

ENGLISH

**HAMEG**<sup>®</sup>  
Instruments

**Spectrum  
analyzer  
HM5011  
HM5010**

4S-5010-0010

09 JUN 1998

**SERVICE-MANUAL HM5011/5010**



**Service Manual  
Adjustment Procedure  
Circuit Diagrams  
HM5010/5011**

Alignment Procedure for HM5010/HM 5011 .....	5
A Control and Adjustment of Supply Voltages .....	5
B Final Alignment - Tuner .....	6
C Alignment - IF-Unit .....	6
D Linearity of Frequency Display .....	7
HM5010 XY-board .....	10
Tuner .....	11
Tracking-Generator .....	12
E Alignment of HM5011 Tracking Generator .....	13
Tracking-Generator .....	15
Tuner RA-Board .....	16
Tuner RB-Board .....	17
IF-Amplifier .....	18
Main board .....	19
X-Y Board .....	20
FC-Board .....	21
PA-Board .....	22
CRT-Board .....	23
Power supply Board .....	24
RA-Board .....	25
Tracking-Generator .....	26
RB-Board .....	27
Main board .....	28
Main board .....	29
XY-Board .....	30
XY-Board .....	31
FC-Board .....	32
FC-Board .....	33
PA-Board .....	34
CRT-Board .....	35
PS-Board .....	36
PS-Board .....	37
PS-Board .....	38
Block Diagram HM5010/HM5011 .....	39

## Specifications

### Frequency

Frequency range: 0.15MHz to 1050MHz (-3dB)  
 Center frequency display accuracy:  $\pm 100\text{kHz}$   
 Marker accuracy:  $\pm(0.1\% \text{ span} + 100\text{kHz})$   
 Frequency display res.: 100kHz (4½ digit LED)  
 Frequency scanwidth: 100kHz/div. to 100MHz/div.  
 in 1-2-5 steps and 0Hz/div. (Zero Scan)  
 Frequency scanwidth accuracy:  $\pm 10\%$   
 Frequency stability: better than 150kHz / hour  
 IF Bandwidth (-3dB): Resolution: 400kHz and  
 20kHz: Video-Filter on: 4kHz  
 Sweep rate: 43Hz

### Amplitude

Amplitude range: -100dBm to +13dBm  
 Screen display range: 80dB (10dB / div.)  
 Reference level: -27dBm to +13dBm  
 (in 10dB steps)  
 Reference level accuracy:  $\pm 2\text{dB}$   
 Average noise level: -99dBm (20kHz BW)  
 Distortion:  $< -75\text{dBc}$ : 2nd and 3rd harmonic  
 3rd order intermod.: -70dBc  
 (two signals  $> 3\text{MHz}$  apart)  
 Sensitivity:  $< 5\text{dB}$  above average noise level  
 Log scale fidelity:  $\pm 2\text{dB}$  (without attn.) Ref.: 250MHz  
 IF gain: 10dB adjustment range

### Input

Input impedance: 50Ω  
 Input connector: BNC  
 Input attenuator: 0 to 40 dB (4 x 10dB steps)  
 Input attenuator accuracy:  $\pm 1\text{dB}/10\text{dB}$  step  
 Max. input level: +10dBm,  $\pm 25\text{V}_{\text{DC}}$  (0dB attenuation)  
 +20dBm (40dB attenuation)

### Tracking Generator

Output level range: -50dBm to +1dBm  
 (in 10dB steps and var.)  
 Output attenuator: 0 to 40dB (4 x 10dB steps)  
 Output attenuator accuracy:  $\pm 1\text{dB}$   
 Output impedance: 50Ω (BNC)  
 Frequency range: 0.15MHz to 1050MHz  
 Frequency response:  $\pm 1.5\text{dB}$   
 Radio Frequency Interference (RFI):  $< 20\text{dBc}$

### Divers

AM-Demodulator output for head-sets.  
 Permissible load impedance  $> 8\Omega$

### General

Display: CRT. 6 inch, 8 x 10 div. intern. graticule  
 Trace rotation: Adjustable on front panel  
 Line voltage: 115 / 230V  $\pm 10\%$ , 50-60Hz  
 Power consumption: approx. 20W  
 Operating ambient temperature: 0°C..+40°C  
 Protective system: Safety Class I (IEC 1010-1)  
 Weight: approx. 7kg  
 Cabinet: W 285, H 125, D 380 mm

Subject to change without notice

5/96

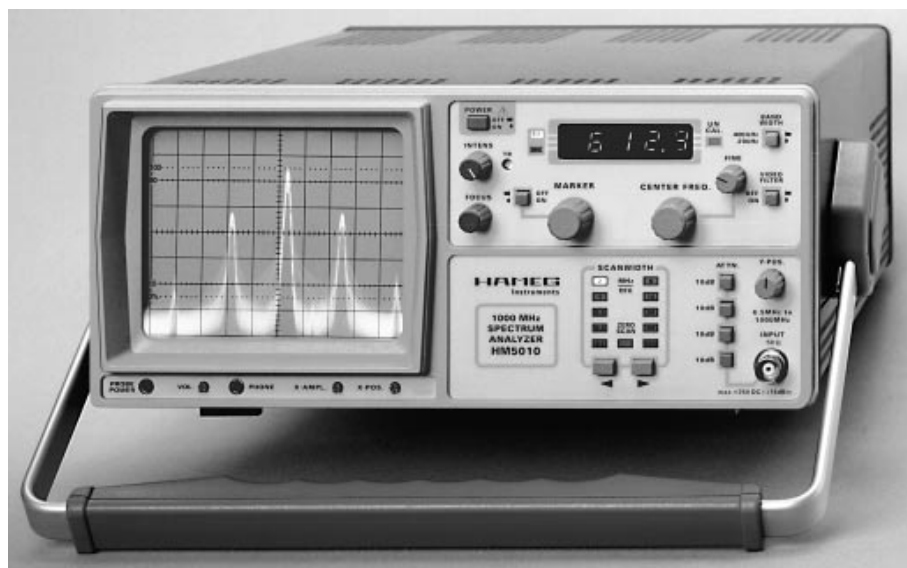

## Spectrum Analyzer HM5010 / HM5011

Frequency Range 0.15MHz - 1050MHz.

4½ Digit Display (Center & Marker Frequency, 0.1MHz resolution)

-100 to +13dBm Amplitude Range, 20kHz, 400kHz and Video-Filter

Tracking-Generator (HM5011 only):

Frequency range: 0.15MHz - 1050MHz.

Output Voltage: +1dBm to -50dBm (50Ω).

Evolution of the original HM5005/HM5006 has led to the **new HM5010/HM5011 Spectrum Analyzer/Tracking Generator** which now extends operation **over 1 GHz** (frequency range 0.15 to 1050 MHz). Both fine and coarse center frequency controls, combined with a scanwidth selector provide simple frequency domain measurements from 100 kHz/div. to 100 MHz/Div.. Both models include a **4½ digit numeric LED readout** that can selectively display either the center or marker frequency. The **HM5011** includes a **tracking generator**.

The **HM5010/5011** offer the same operation modes as the HM5005/5006. The instruments are suitable for pre-compliance testing during development prior to third party testing. A near-field sniffer probe set, **HZ530**, can be used to locate cable and PC board emission "hot spots" and evaluate **EMC problems** at the breadboard and prototype level. The combination of **HM5010/5011** with the **HZ530** is an excellent solution for RF leakage/radiation detection, **CATV/MATV** system troubleshooting, cellular telephone/pocket pager test and **EMC** diagnostics. There is an optional measurement output for a PC which makes documentation of results easy and affordable with the **HO500 Interface**.

**Accessories supplied: Line Cord, Operators Manual. Optional accessories, 50Ω-feedthrough termination HZ22 Viewing Hood HZ47, Near Field Probe Set HZ530, Carrying Case HZ96-2, Transient Limiter HZ560**

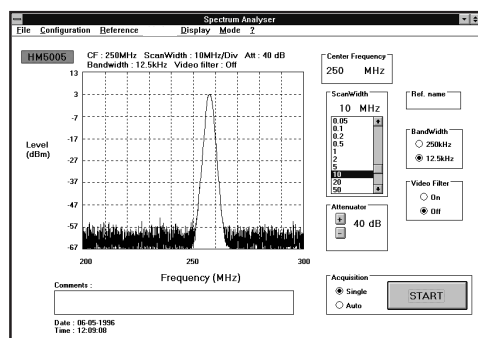

## HO500 Computer Interface for HAMEG Spectrum Analyzer

This **HO500** computer interface offers the facility to transfer a calibrated frequency spectrum from any **HAMEG spectrum analyzer** to a PC. The **HO500 interface** is a 8 bit **ISA BUS card** installed in the **PC**, which transfers data via an interface cable. The software supplied allows a hard copy print out (including parameters) of the frequency spectrum, in **Windows Format**. Signal acquisition occurs **2 to 3 times per second**.

The picture consists of 10 bit vertical by approx 3600 point horizontal display. The PC monitor display is in **SVGA** Format with 800 x 600 pixels. For comparison measurements, a previously stored reference curve can be recalled. The software supplied works under Windows 3.1, 3.11 and WIN95. A simple XY analog output is required to connect the **HO500** to the spectrum analyzer.

Specifications

Frequency

**Frequency range:** 0.1MHz to 1000MHz  
(lower frequency limit depends on probe type)

**Output impedance:** 50 Ω

**Output connector:** BNC-jack

**Input capacitance:** 2pF  
(high impeded. probe)

**Max. Input Level:** +10dBm  
(without destruction)

**1dB-compression point:** -2dBm  
(frequency range dependent)

**DC-input voltage:** 20V max.

**Supply Voltage:** 6V DC  
4 AA size batteries  
Supply-power of HM5010/5011

**Supply Current:** 8mA (H-Field Probe)  
15mA (E-Field Probe)  
24mA (High imp. Probe)

**Probe Dimensions:** 40x19x195mm (WxDxL)

**Housing:** Plastic; (electrically shielded internally)

**Package contents:** Carrying case  
1 H-Field Probe  
1 E-Field Probe  
1 High Impedance Probe  
1 BNC cable (1.5m)  
1 Power Supply Cable

(Batteries or Ni-Cads are not included)



Near Field Sniffer Probes HZ 530

The HZ530 is the ideal toolkit for the investigation of **RF electromagnetic fields**. It is indispensable for **EMI pre-compliance testing** during product development, **prior to third party testing**. The set **includes 3 hand-held probes** with a built-in pre-amplifier covering the frequency range from **100kHz to over 1000 MHz**.

The probes - one **magnetic field** probe, one **electric field** probe, and one **high impedance** probe - are all matched to the 50Ω inputs of **spectrum analyzers or RF-receivers**. The power can be supplied either from batteries, Ni-Cads or through a power cord directly connected to an HM5010/HM5011 series spectrum analyzer.

Signal feed is via a 1.5m BNC-cable. When used in conjunction with a spectrum analyzer or a measuring receiver, the probes can be used to locate and **qualify EMI sources**, as well as evaluate EMC problems at the **breadboard** and **prototype level**. They enable the user to evaluate radiated fields and perform **shield effectiveness comparisons**. Mechanical screening performance and immunity tests on cables and components are easily performed.

The H-Field Near-Field Probe

The H-Field probe provides a voltage to

the connected measurement system which is proportional to the magnetic radio frequency (RF) field strength existing at the probe location. With this probe, circuit RF sources may be localized in close proximity of each other. The H-field will decrease as the cube of the distance from the source. A doubling of the distance will reduce the H-field by a factor of eight ( $H = 1/d^3$ ); where d is the distance.

In the actual use of the H-field sensor one observes therefore a rapid increase of the probe's output voltage as the interference source is approached. While investigating a circuit board, the sources are immediately obvious. It is easily noticed which component (i.e. IC) causes interference and which does not. In addition, by use of a spectrum analyzer, the maximum amplitude as a function of frequency is easily identified. Therefore, one can eliminate early in the development components which are not suitable for EMC purposes. The effectiveness of countermeasures can be judged easily. One can investigate shields for "leaking" areas and cables or wires for conducted interference.

The High-Impedance Probe

The high-impedance probe (Hi-Z) permits the determination of the radio frequency interference (RFI) on individual contacts or printed circuit traces. It is a direct-contact probe. The probe is of very high impedance

(near the insulation resistance of the printed circuit material) and is loading the test point with only 2 pF (80Ω at 1 GHz). Thereby one can measure directly in a circuit without significantly influencing the relationships in the circuit with the probe.

One can, for example, measure the quantitative effectiveness of filters or other blocking measures. Individual pins of ICs can be identified as RFI sources. On printed circuit boards, individual problem tracks can be identified. With this Hi-Z probe individual test points of a circuit can be connected to the 50Ω impedance of a spectrum analyzer.

The E-Field Monopole Probe

The E-field monopole probe has the highest sensitivity of the three probes. It is sensitive enough to be used as an antenna for radio or TV reception. With this probe the entire radiation from a circuit or an equipment can be measured. It is used, to determine the effectiveness of shielding measures. With this probe, the entire effectiveness of filters can be measured by measuring the RFI which is conducted along cables that leave the equipment and may influence the total radiation. In addition, the E-field probe may be used to perform relative measurements for certification tests. This makes it possible to apply remedial suppression measures so that any re-qualification results will be positive. In addition, pre-testing for certification tests may be performed so that no surprises are encountered during the certification tests.

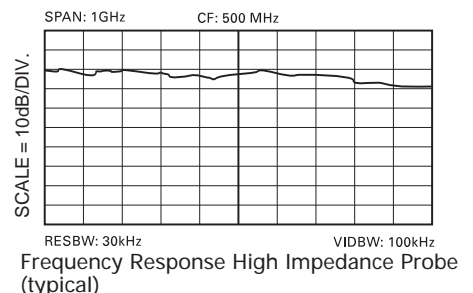
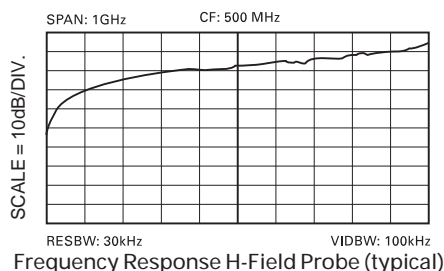
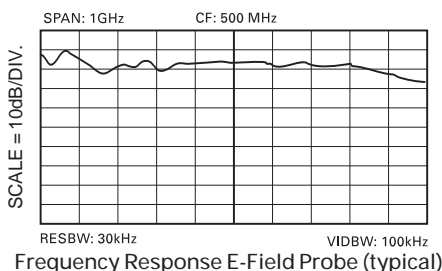

# Alignment Procedure for HM5010/HM 5011

**Attention!** The opening of covers or removal of parts is likely to expose live parts and accessible terminals which can be dangerous to life. Maintenance, service and alignment should be carried out by qualified personnel only, which is acquainted with the danger involved.

When aligning the HM5010/5011 it is assumed that all sub-assemblies of the instrument are completely pretested and working correctly. The tuner, IF-unit, and tracking generator should be pre-aligned. When aligning a HM5010, a separate tracking generator unit must be available and connected to the HM5010 for some specific adjustments. Prior to the alignment procedure, the instrument must warm up for 60 minutes. All adjustments are carried out by means of a plastic screw driver or a ceramic adjustment tool.

The alignment is divided into the following steps:

- A Checking of supply voltages
- B Alignment of the tuner
- C Alignment of the IF-unit
- D Linearity alignment
- E Tracking generator alignment
- F Check of overall adjustment

The numbering system is related to the respective pictures. Screen shots are designated as PIC

- 1 HF-Synthesizer 100 kHz to 1000 MHz, i.e. HM 8133
- 2 BNC cable, BNC T-connector, 2 x 10dB attenuator 50 ohm
- 1 Voltmeter i.e. HM 8011-3

## A Control and Adjustment of Supply Voltages

*adjust:* 12V to an accuracy of  $\pm 0.1V$  via **Trimpot 4** **PIC 1**  
*adjust:* minimum brightness via **Trimpot 2** **PIC 1**  
*adjust:* maximum brightness via **Trimpot 3** **PIC 1**  
*adjust:* astigmatism via **Trimpot 1** **PIC 1**

*check:* -12V tolerance  $\pm 0.2V$   
*check:* +12V tolerance  $\pm 0.1V$   
*check:* +5V tolerance  $\pm 0.2V$   
*check:* -5V tolerance  $\pm 0.2V$   
*check:* +38V tolerance  $\pm 1V$   
*check:* +138V tolerance  $\pm 1V$

1	+138V
2	+38V
3	GND
4	+5V
5	+12V
6	-12V

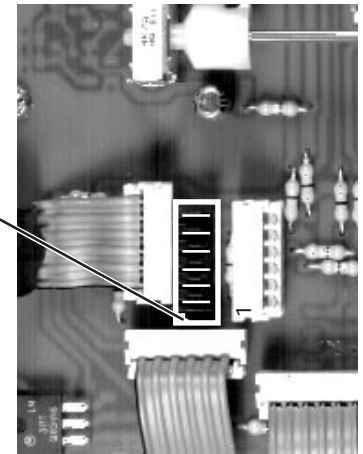

**PIC 2. XYF-Board (partial)**

The corresponding voltage test points to check direct voltage can be measured at the measuring connector strip (see PIC 2).

Basic adjustment:

When Y-pos. knob is snapped in on front board, adjust beam approx. 2 mm below bottom graticule line via R801.

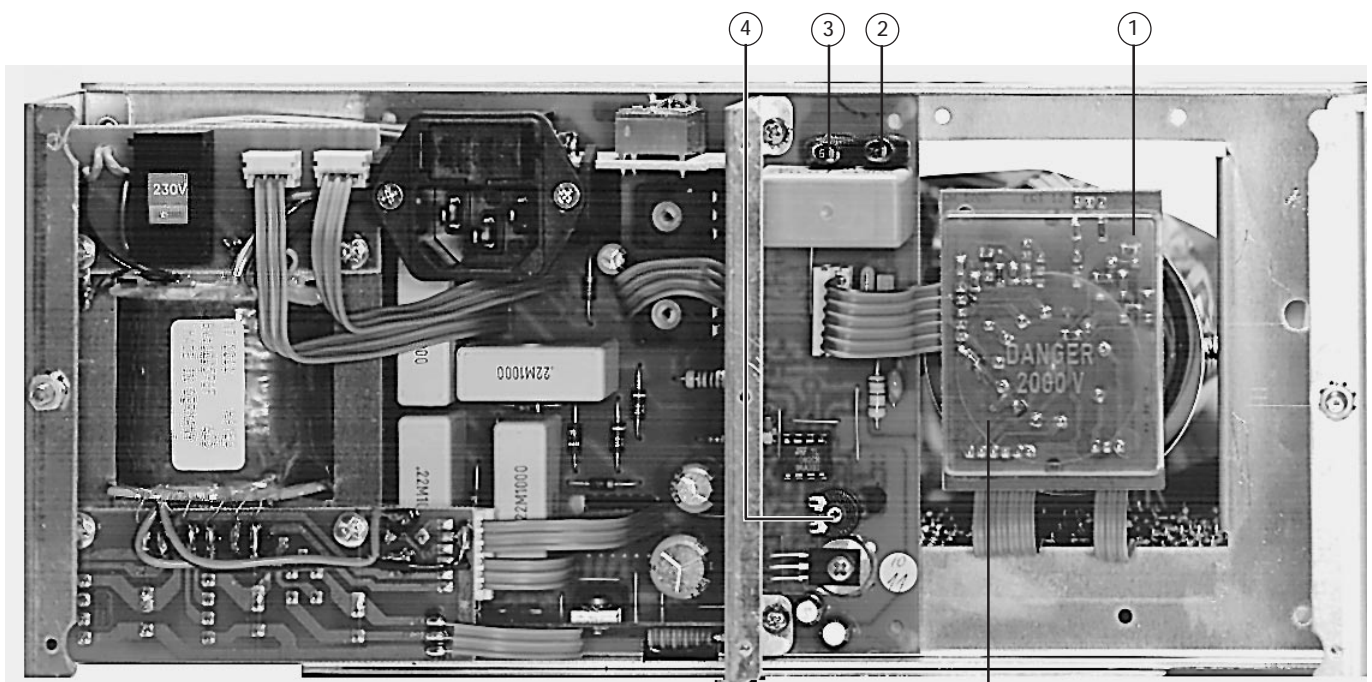

**PIC 1. PS-Board**

**Instrument Rear Side**

**CRT-Board**

## B Final Adjustment - Tuner

The tuner is already aligned by the factory. When changing the 1st mixer, it might be necessary to realign cavity filter: Set signal to 500MHz -27dBm to input, center frequency to 500MHz, Scanwidth to 0.5MHz, turn all three M3 screws to max. amplitude. In case curve is not uniform, coils L1, L2, and L3 can be adjusted to maximum uniformity (fig. 22) by slightly bending them.

In case signal in frequency range is shaky, 2nd local oscillator might not be snapped in correctly. The correct snap-in of the PLL is visible via the lock detect LED (D2), which has to be lit constantly without flickering if PLL is snapped-in correctly.

The oscillator signal has to be fixed (crystal dependent) at 1.32GHz, it may not drift.

The PLL is snapped-in when the tuning voltage VT (measure at PAD1) is between 0.5 and 4.5V. The alignment will bring the tuning voltage to the center of the tuning range. VT of the 2nd LO has to be between 2V and 2.5V. Constantly check tuning voltage while aligning tuner.

Alignment is necessary in two cases:  $VT < 2.0V$  and  $VT > 2.5V$ .

- *Case 1*  $VT < 2.0V$

Correction:

- Solder all adjustment areas to connect trace from C1 to C2.
- Remove excess solder at center conductor of resonator pad.

- *Case 2*  $VT > 2.5V$

Correction:

- Adjustment areas may not be soldered to connect trace from C1 to C2.
- Add solder to resonator pad.

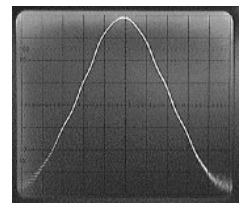

fig. 22 for HM5010

## C Alignment of IF-Unit

*Measurement setup:* Apply two different signals to the input of the HM5011 via BNC T-connector and 10dB attenuators.

Adjust HM5010/5011: Center frequency to 500MHz; all attenuators on (-40 dB) Bandwidth 400kHz; video filter off; scanwidth 0.5MHz/div.; marker off.

Adjust Tracking Generator: Attenuator -20dB; level max. (HM5011 only) RF-generator: frequency 500MHz; level -5dBm

The output voltage of the tracking generator is visible on the screen by an overlay of the fixed frequency. A "zero" point is visible within the signal to the right or to the left of the 500MHz spectral line (fig. 23) (5011 only).

### IF Filter Curve at 400kHz Bandwidth

- align:* Step 1 Align (with plastic screw driver) **Coil L1 (PIC 5)** to maximum output amplitude and symmetry to Y-axis.
- align:* Step 2 Align (with plastic screw driver) **Coils 3 + 4 + 13 + 14 (PIC 5)** to symmetric to Y-axis. The "zero" point must be at the maximum (at 500MHz) (fig. 23).
- align:* Step 3 If necessary, repeat step 1 and 2.

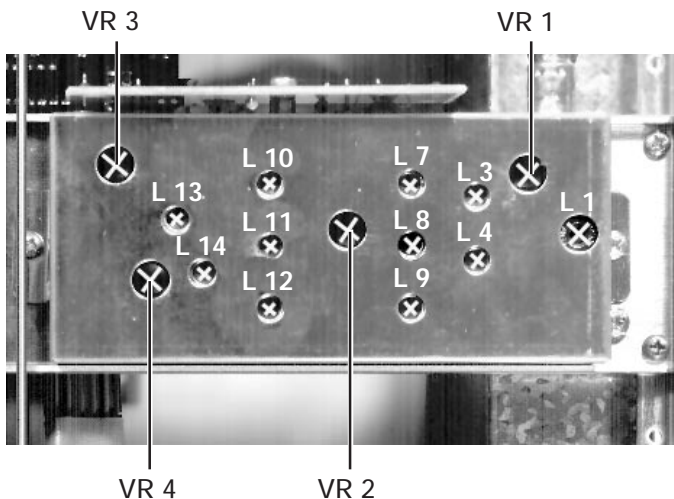

PIC 5  
IF-Amp  
Board

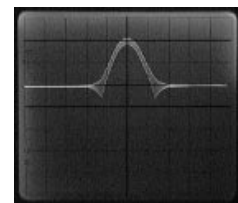

fig. 23 for HM5011

## IF Filter Curve at 20kHz Bandwidth (HM5010)

*align:* Step 1 Align (with plastic screw driver) **Coils L7+8+9+10+11+12** until "zero" point is exactly centered at 500MHz (as with 400kHz Bandwidth).  
Watch for symmetry of Filter Curve.

## IF Filter Curve at 20kHz Bandwidth (HM5011)

**Pre-Alignment:** Remove T-connector. Connect tracking generator module directly to the input of the HM5011. Turn off attenuators on tracking generator line module and on HM5011 (0 dB). The output voltage of the tracking generator module is now visible as horizontal line (with slight ripple).

*adjust:* Step 1 Adjust (with plastic screw driver) **Coils 7 + 8 + 9 + 10 + 11 + 12** to maximum screen height of displayed output voltage. Add attenuators of HM5010/5011 as soon as "line" has reached the middle of the screen (-30 dB).

*adjust:* Step 2 This alignment has to be performed repeatedly in order to optimize settings.

**Fine Alignment:** Connect BNC-T-connector again as in the beginning of the IF alignment. Set attenuator of tracking generator module to -20dB, scanwidth to 0.5 MHz/div. If necessary, re-adjust center frequency (adjust 500MHz spectral line to screen center). "Zero" point is now visible to the right or to the left of screen center (amplitude maximum) (**fig. 24**).

*adjust:* Step 1 Align (with plastic screw driver) **Coils L7+8+9+10+11+12** until "zero" point reaches maximum. Watch for symmetry of Filter Curve.

*adjust:* Step 2 This alignment has to be performed repeatedly in order to optimize settings.

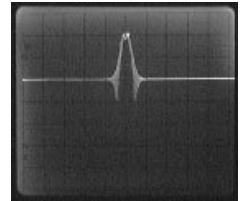

fig. 24

## IF Gain - Adjustment of different Bandwidths

Set scanwidth to 0.2MHz/div. Switch bandwidth repeatedly between 400kHz and 20kHz. The distance between the output voltage (line) of the tracking generator and the 400MHz amplitude may not vary. If the amplitude values do not match exactly, adjust by means of R-trimmer **VR2 (PIC5)**.

## Linearity of IF-Amplifier Gain

The linearity of the IF-amplifier gain has to be checked through the entire display range. Apply a 400MHz (-27dBm) signal directly to the input of the HM5010/5011. Adjust scanwidth to 5MHz/div, release attenuator switched (0 dB), select filter bandwidth of 400kHz. The spectral line should reach the upper screen edge. Use attenuators to reduce signal in 10db steps, whereby each individual attenuation step has to reduce the level by 10dB  $\pm$  1dB. In case deviation is as follows:

- A the drop of the individual attenuation steps is larger than 10dB  $\pm$  1dB, or
- B the drop of the individual attenuation steps is smaller than 10dB  $\pm$  1dB, the linearity of the attenuators has to be adjusted as follows:

Set attenuator to -40dB. Adjust spectral line exactly to -40dB (center line) via **VR1, VR3, VR4**. Then set attenuators back to 0dB and adjust spectral line by means of trim pots VR802A and VR801 (XY board) to zero point and base line to bottom graticule line. This procedure has to be repeated until the settings at -40dB and 0dB are correct.

## D Linearity of Frequency Display

Settings for HM5010/5011: Center frequency at 500MHz; all attenuator switches released; filter bandwidth 400kHz; video filter off; scanwidth to 100MHz/div.; marker off.

Measurement Setup: Apply signal of 500MHz -27dBm to input of HM 5010/5011.

*Check:* Basic setting: The HM5010/5011 has to be adjusted that the noise level touches the bottom graticule line. The spectral line of 500MHz -27dBm reaches the top graticule line and is situated in the center of the screen. Adjust 500MHz spectral line exactly to screen center via X-pos knob (on front of the unit).

*Check:* Upper frequency limit: Check if frequency of minimum 1050 can be set as center frequency.

Adjust HM5010/5011 to basic setting (see above). Apply input signal of 100MHz, level +7dBm  
Overriding the input allows for the harmonics of the input signal to become visible (fig. 7). This simplifies the adjustment of individual spectral lines in horizontal direction.

*adjust:* Spectral line at 400MHz  
Turn X-ampl. knob on front of instrument to have the 4 spectral lines matched with the corresponding graticule lines on the screen(fig. 8).

*adjust:* Spectral line at 100MHz  
With Trimpot **RV171** align to match this spectral line with the corresponding graticule line on the screen (fig. 9).

*adjust:* Zero Peak  
With Trimpot **RV173** align to match this spectral line with the corresponding graticule line on the screen (fig. 9).

*adjust:* Spectral line at 600-1000MHz  
With Trimpot **RV186** adjust to match 700MHz to the correct graticule line.

*adjust:* Spectral line at 800 MHz;  
With Trimpots **RV181 + RV183 for 900MHz and RV197 for 1000MHz (PIC 3)** adjust to match this spectral line with the corresponding graticule line on the screen.

*adjust:* Beam length  
With Trimpot **RV101** adjust beam to end approx. 1mm beyond the right CRT boundary (graticule) (Fig. 11 - base line too short)  
(Fig. 10 - 300 to 1000MHz spectral lines not correct )

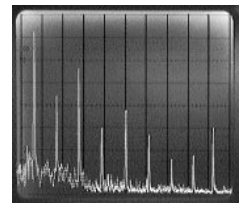

fig. 7

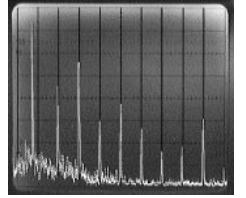

fig. 8

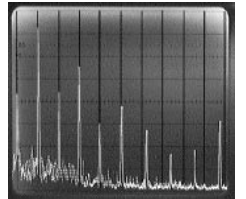

fig. 9

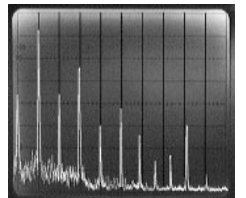

fig. 10

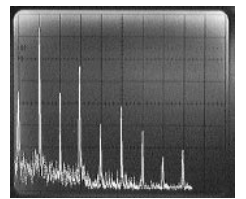
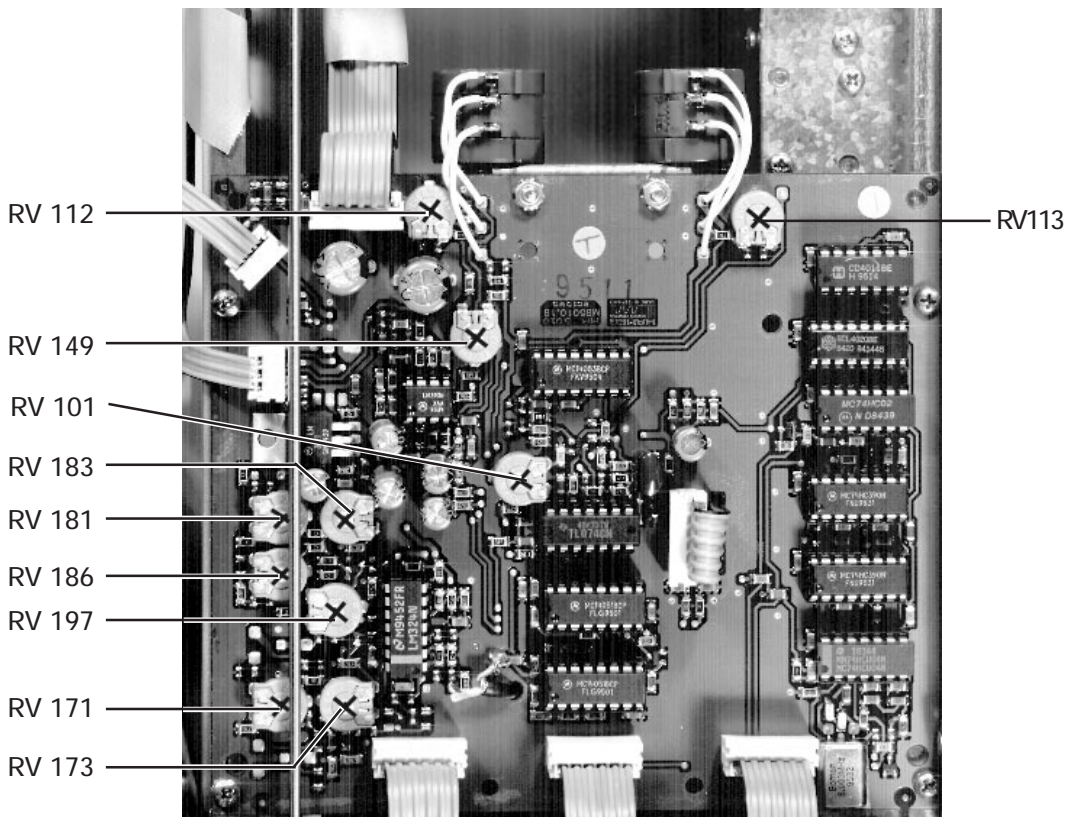

fig. 11



PIC 3 - MB-Board

Set **Trimpot RV113** that frequency will not display below 990MHz when center frequency is set to lowest frequency



Adjust Marker.

Settings on HM5010/5011: Center frequency to 500MHz, all attenuators in off position, filter bandwidth to 400kHz, video filter off.

Scanwidth to 100MHz, Marker on.

Signal 100MHz +7dBm.

Adjust Marker to 500MHz display and set to 500MHz mark on screen via RV149 (PIC 4).

Turn Marker left to max. and adjust to 990MHz via RV112.

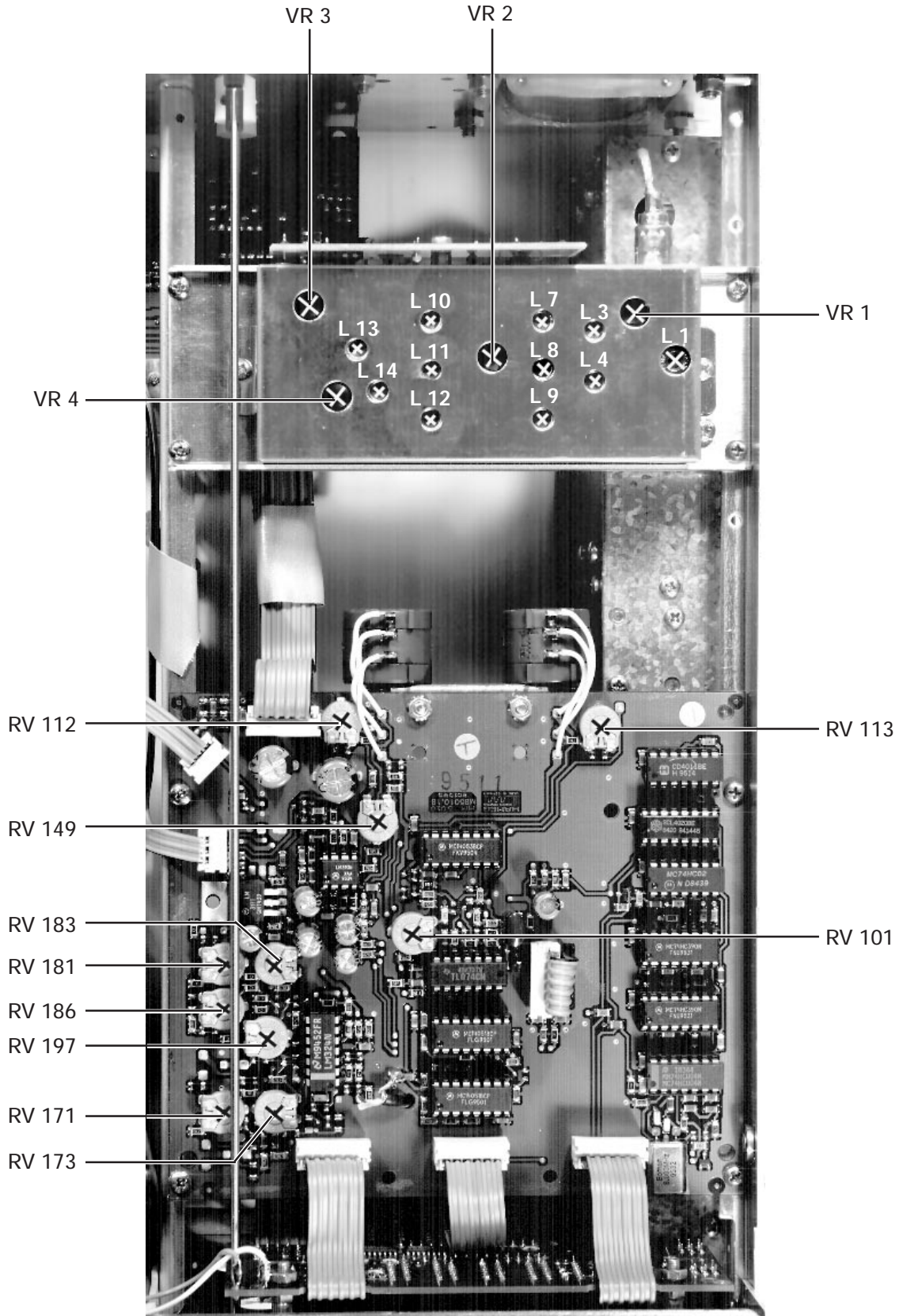

PIC 3 - Main-Board

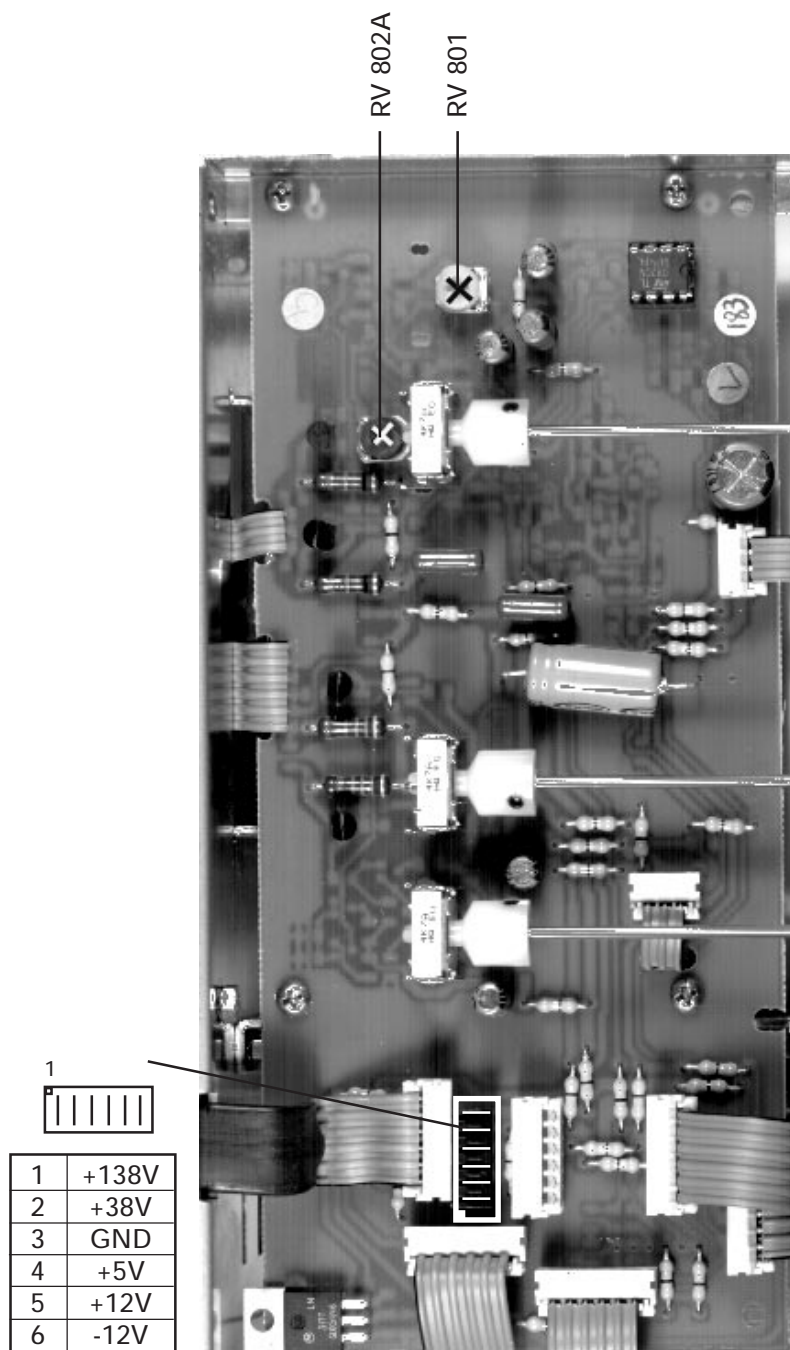

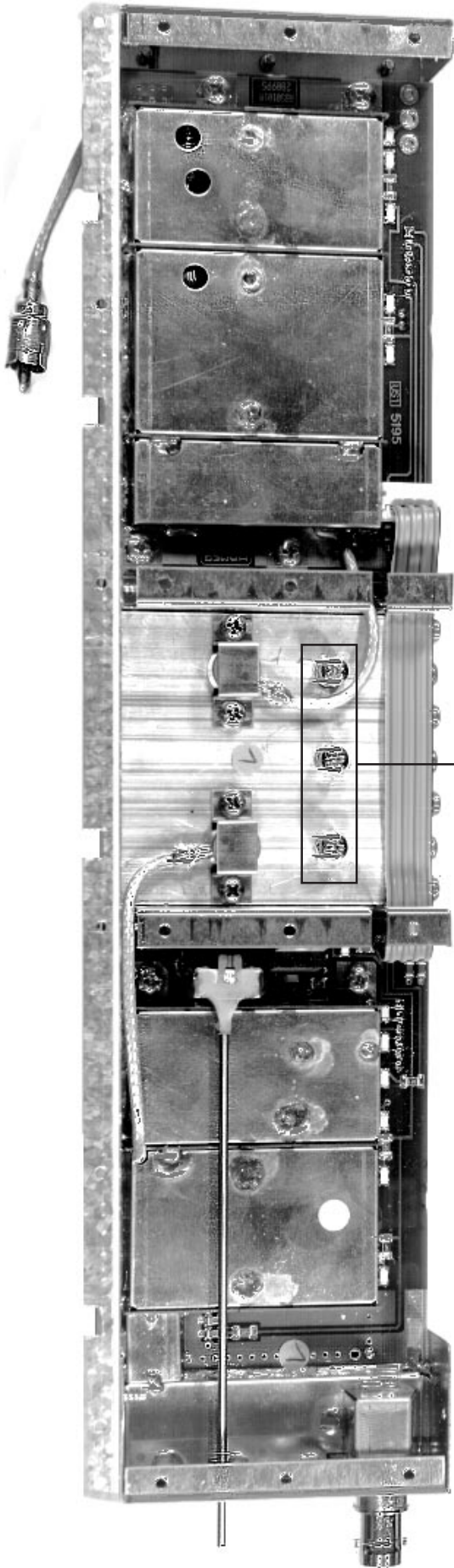

M3 Screws  
Cavity - Filter

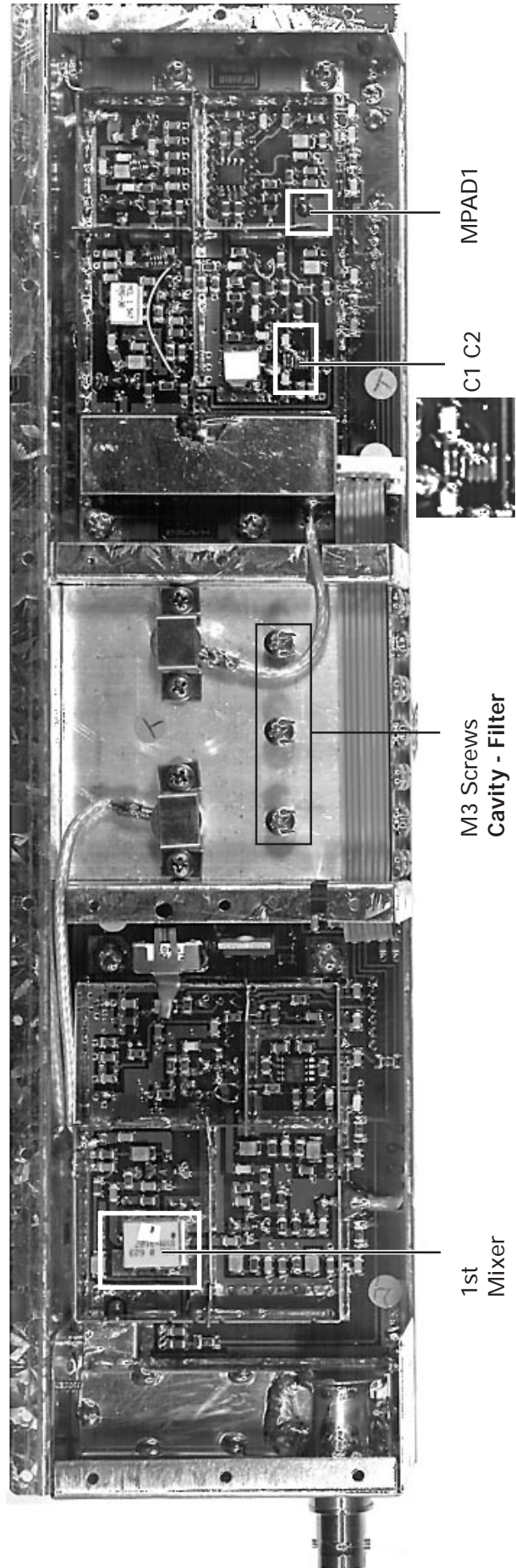

1st  
Mixer

M3 Screws  
Cavity - Filter

C1 C2

MPAD1

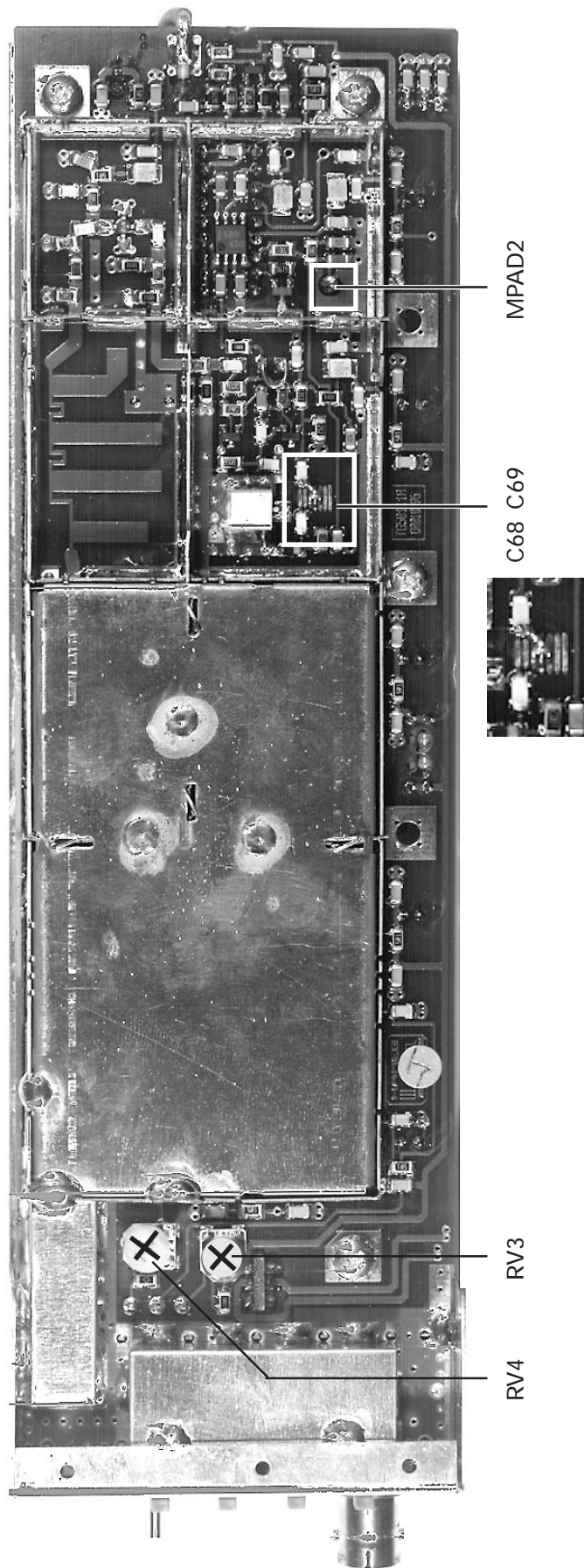

## E Alignment of HM5011 Tracking Generator

### 1. Required Instruments:

- 1.1 Spectrum Analyzer - minimum 1000MHz
- 1.2 Completely assembled HM5011
- 1.3 Multimeter to measure DC voltage
- 1.4 Oscilloscope, i.e. HM303
- 1.5 Coax cable

### 2. Preparation:

- 2.1 Assemble Spectrum Analyzer completely (without case).
- 2.2 All sub-assemblies have to be pre-checked.
- 2.3 HM5011 has to be warmed up.
- 2.4 Connect VCO output of RA board to VCO input (MCX connector).
- 2.5 Connect 12MHz reference clock of TG board to RCA connector ST1 on RB board.

### 3. Check Signalling Lines

Cable connection W1

Pin Nr.	Description	Signal
1	-12V	Supply OP
2	+12V	Supply
3	+5V	Supply PLL

### 4. Check Supply and Bias Voltages

Comp.Nr.	Pin Nr.	Description	Voltage
C1	1	1. VCO Amp.	+5.8 V
C2	1	2. VCO Amp.	+5.8 V
C11	3	fix LO Amp.	+5.9 V
C6	5	Var. Amp.	+5.6 V
C9	3	1. Power Amp.	+3.6 V
C12	3	2. Power Amp.	+4.8 V

### 5. Alignment of fixed LO

- 5.1 The 2nd LO oscillates at a frequency of 1.35 GHz. The level at the mixer input IC3 Pin2 is -17dBm. Oscillation of the 2nd LO can also be measured with the H or E-Field Probe (HZ530).
- 5.2 Lock-Detect LED (D4) will confirm the correct PLL lock when lighting up without flickering or going out. The oscillator signal has to remain fixed crystal dependent) at 1.35GHz and may not drift. PLL is locked if tuning voltage VT (measure at PAD2) is between 0.5 and 4.5V. Align tuning voltage to medium tuning range. VT of fixed LO should be between 2 and 2.5V. The tuning voltage has to be checked constantly during alignment. Place coax resonator CR2 bottom side to the edge of soldermask next to center conductor, and solder on the left and the right side.
- 5.3 Alignment is necessary in two cases:  $VT < 2.0V$  and  $VT > 2.5V$ .

#### • Case 1 $VT < 2.0V$

Correction:

- a) Solder all adjustment areas to connect trace from C1 to C2.
- b) Remove excess solder at center conductor of resonator pad.

#### • Case 2 $VT > 2.5V$

Correction:

- a) Adjustment areas may not be soldered to connect trace from C1 to C2.
- b) Add solder to resonator pad.

## 6. Control of fixed LO-Level

- 6.1 To check 2nd LO-level, cap C20 (22pF) has to be removed and 50Ohm Coax-cable has to be connected to -13dB attenuator of output. Connect other end of coax cable with adequate test analyzer.
- 6.2 Adjust test analyzer to 1.35 GHz center frequency; the LO-level to be measured has to be -17dBm ( $\pm 1$  dB) (consider attenuation of cable).
- 6.3 If cap is not removed and coax cable is connected parallel to mixer to the VCO-branch, a level of approx. -24 dBm ( $\pm 1$ dB) should be measured due to decreased load resistance.

## 7. Check of VCO

- 7.1 Adjust HM5011 to Zero Scan, center frequency to 500MHz.
- 7.2 Remove Cap C14 (22pF), connect one side to attenuator output, other side stand up in the air.
- 7.3 Connect Cap side sticking up in the air to center conductor of 50 Ohm cable. Solder shielding of cable directly next to Cap to ground. Connect other end of Cap to Analyzer input (i.e. Advantest R3361A). Start 1.35GHz - Stop 2.35GHz reference level: 0dBm.
- 7.4 VCO signal which can be observed on the test analyzer has to shift according to center frequency (tuning voltage). Tuning range has to be at least from 1350 to 2350 Mhz. continuously and without interruption. It should not go under absolute level of +7dBm (coax cable of 1 mtr. has 1-2 dB of attenuation at 2GHz). Level has to be between +7 dBm and +10 dBm.
- 7.5 Connect coax cable parallel to 1st mixer to VCO-branch. A level of +5 dBm to +8 dBm due to decreased load resistance over frequency band.

## 8. Check of Attenuators:

- 8.1 Set -30dB attenuation to Tuner and to 0dB attenuation to TG.
- 8.2 Set Center Frequency to 500MHz, 100MHz/Div. span.
- 8.3 Connect tracking generator to tuner input.
- 8.4 TG-line has to be visible.
- 8.5 Switch on additional attenuators. Attenuation for each attenuator switch has to be 10dB ( $\pm 1$  dB)

## 9. TG Level Adjustment:

- 9.1 Connect TG to reference analyzer.
- 9.2 Set HM5011 to Zero Scan and 500MHz Center Frequency.
- 9.3 Release all attenuator buttons of TG (0-dBm) and turn TG-level to maximum.
- 9.4 Adjust amplitude to +1dBm with Pot RV4 on TG.
- 9.5 turn TG-level to minimum.
- 9.6 Adjust amplitude to -10dBm with Pot RV3 on TG.
- 9.7 Amplitude has to be adjustable now between +1dB and -10dB.

## 10. Final Check

- 10.1 Position of TG-level has to align in both bandwidths (400kHz and 20kHz). If necessary, align with IF-Amp.
- 10.2 TG-level knob has to be adjustable from +1 to -10dBm.

# Tracking-Generator

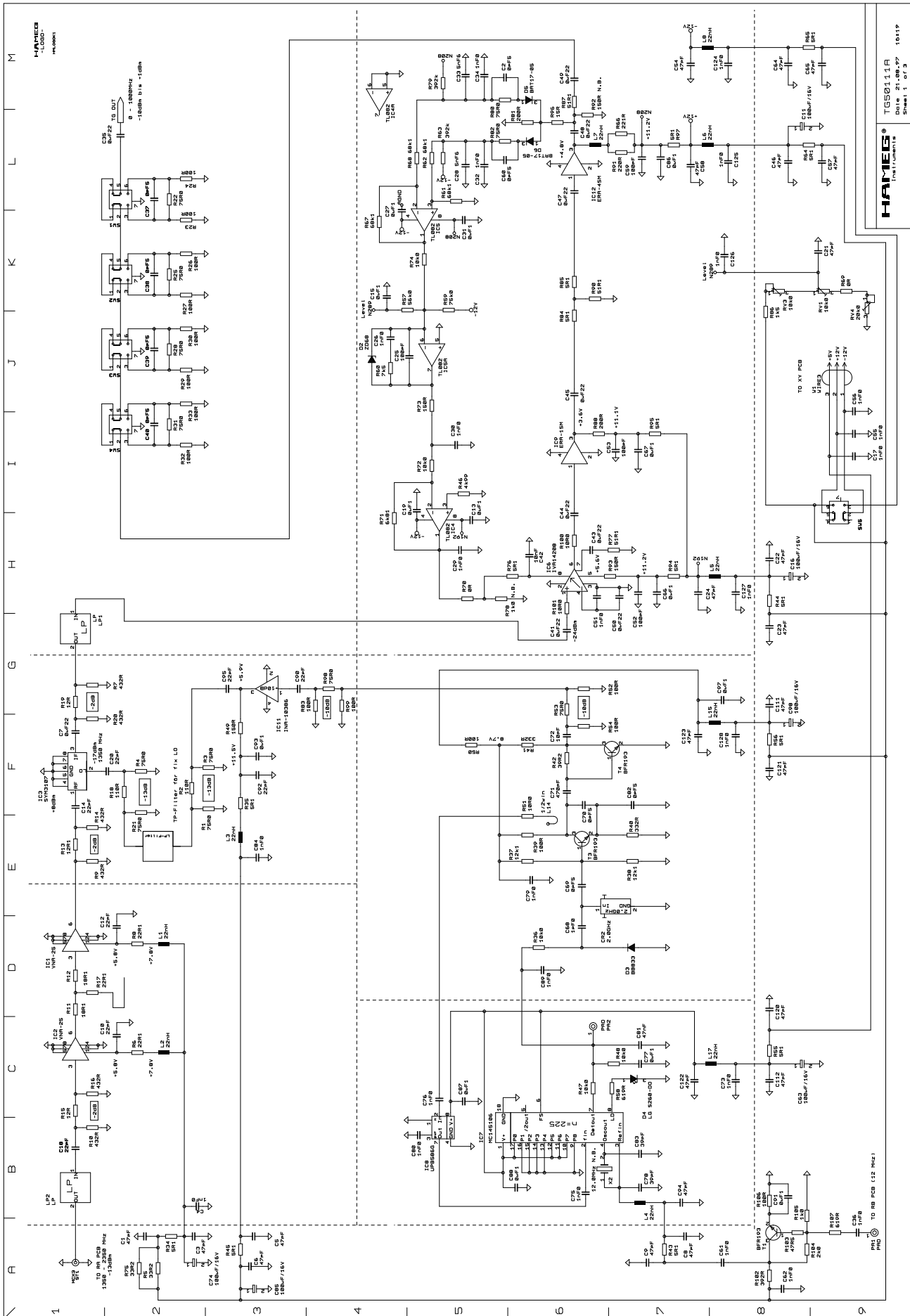

HAMECO  
TSS0111R  
Date: 21.08.97 10:17  
Sheet 1 of 3

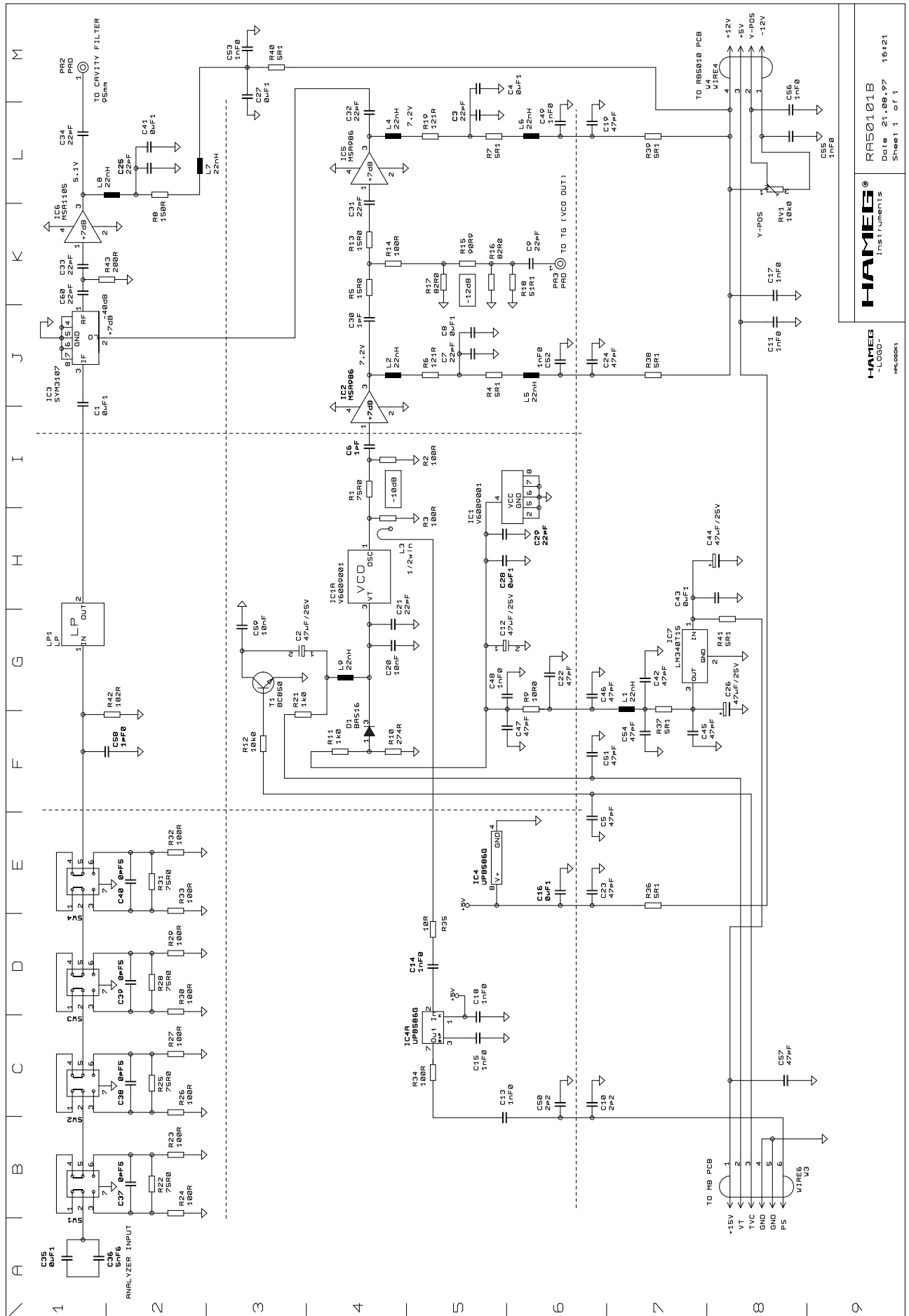

HAMEES  
-LOGO-  
HML00001

RAS101B  
Instruments  
Date 21.08.97  
Sheet 1 of 1



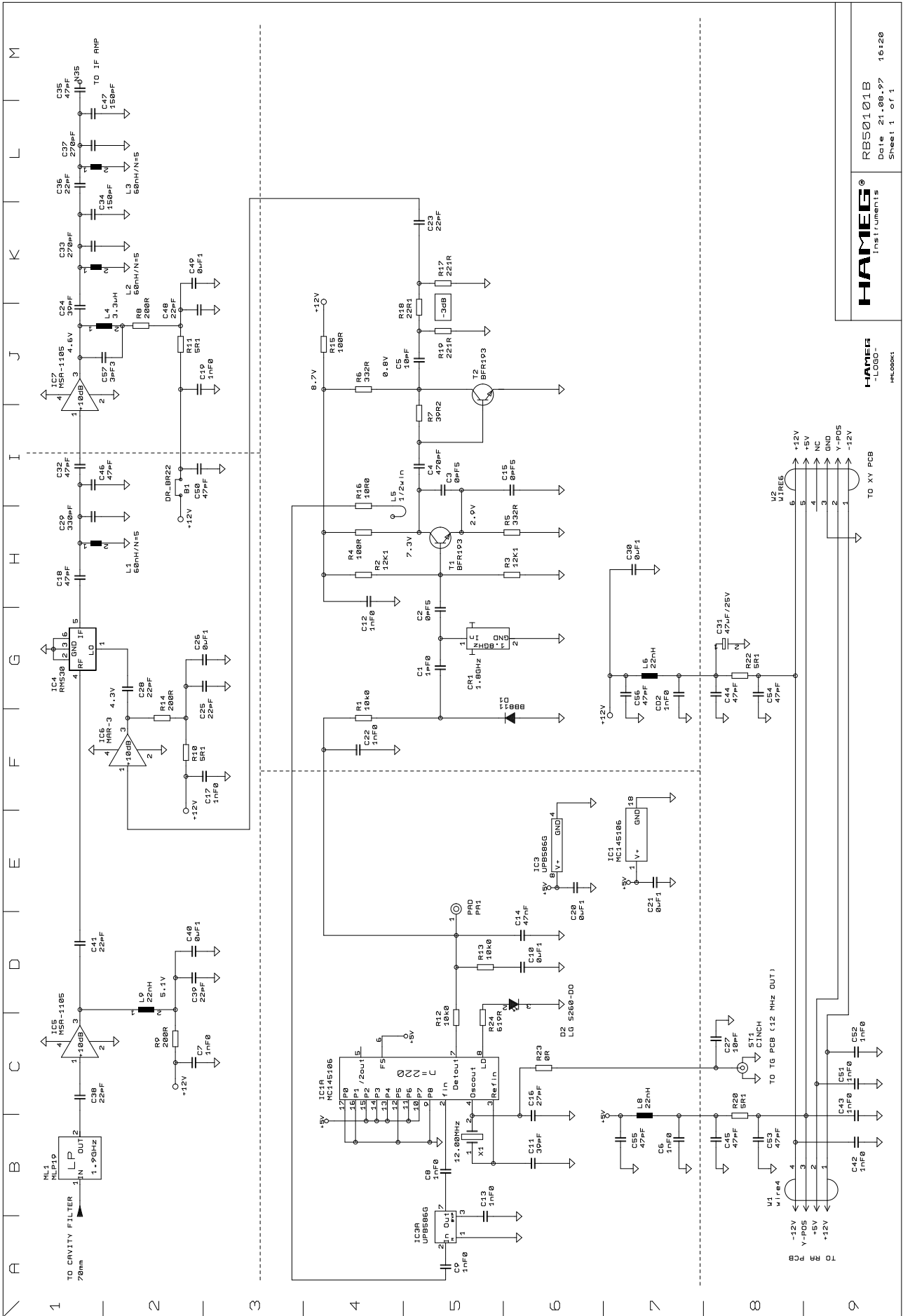

HAMEG®  
-LOGO-  
HME0001

RBS0101B  
Date 21.08.97 16:20  
Sheet 1 of 1

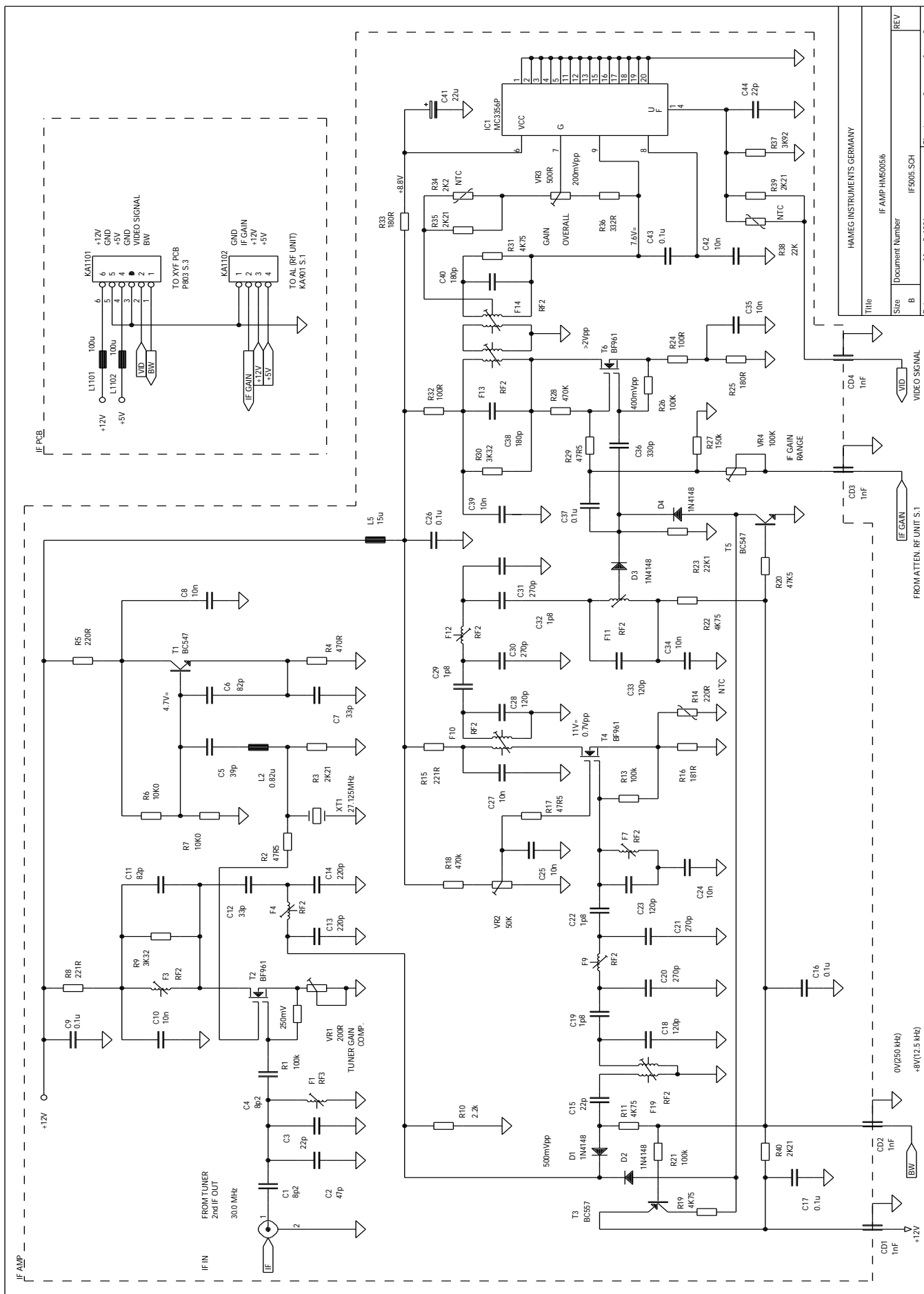

Title		HAMEG INSTRUMENTS GERMANY	
Size	Document Number	IF AMP HM5005/6	
B			
Date:		May 5, 1994	
Sheet	2	of	8
REV			

# Main board

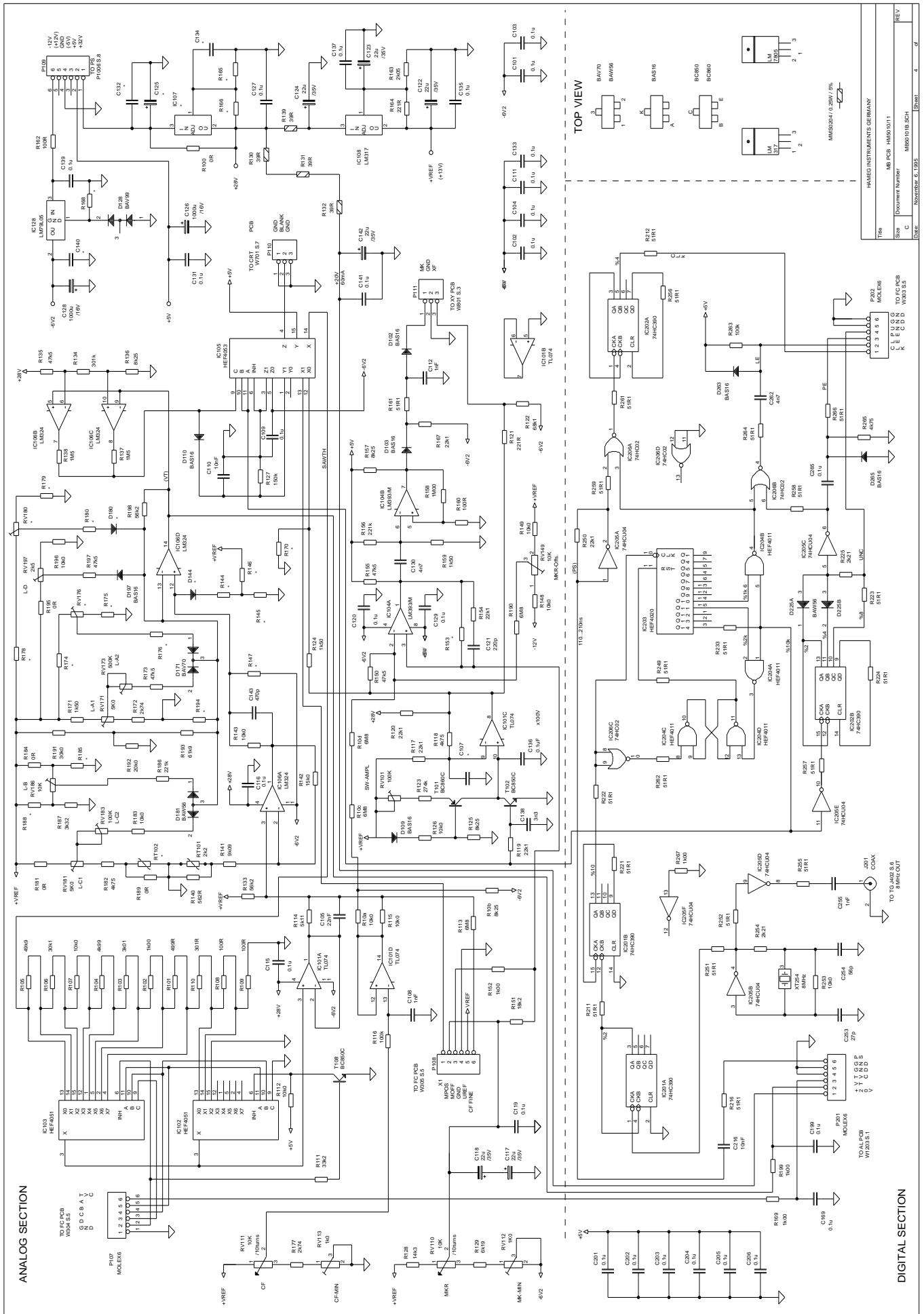

REV.	4
Doc.	November 01.1995
Size	A4
Doc. Number	MB PCB HM60/011
File	HM60/01B.SCH
Sheet	4

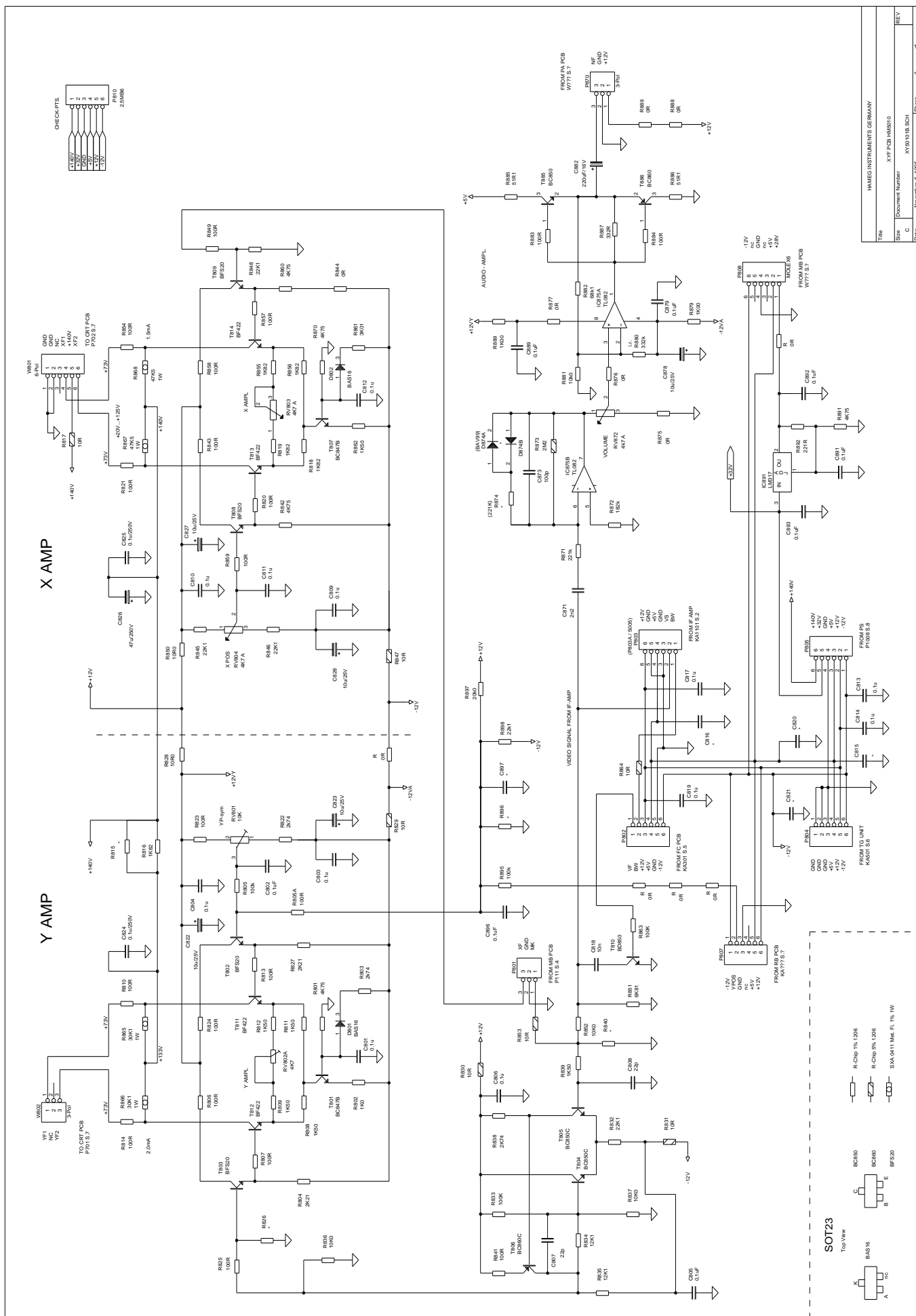

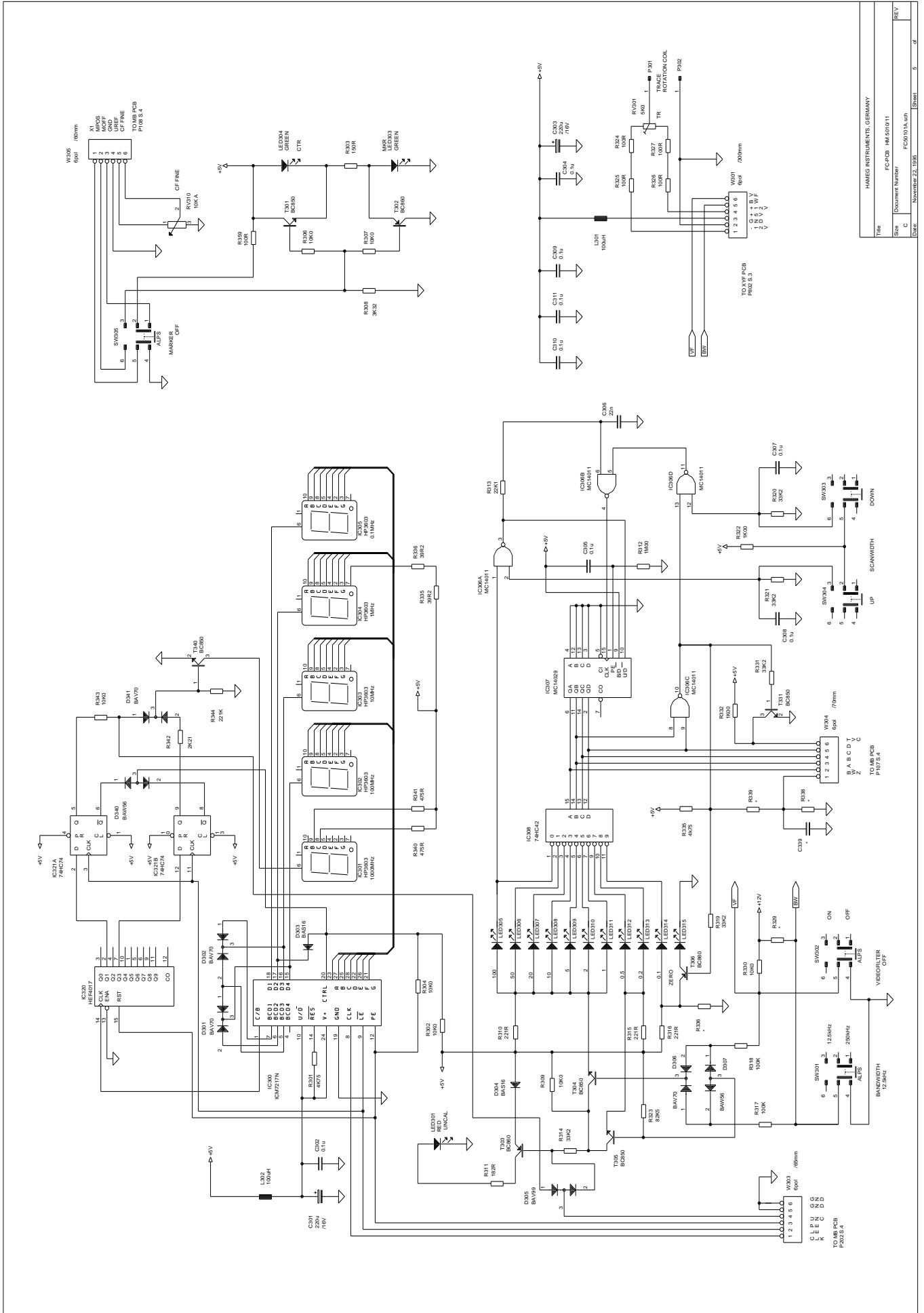

File	FC-PCB_HM151011
Size	Document Number
C	FC50101A.dwg
Drawn	November 25, 1998
Sheet	5 of 5

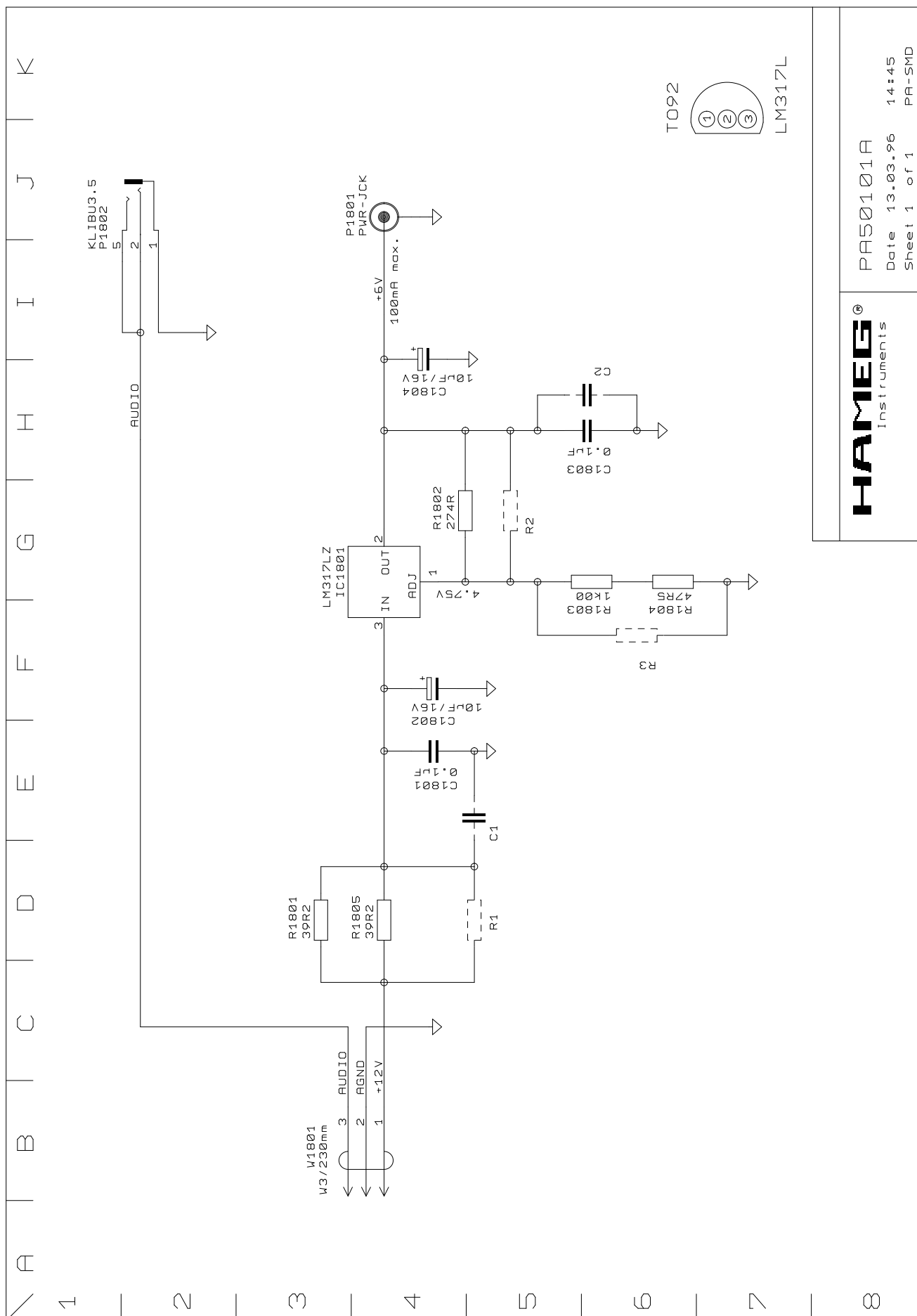

**HAMEG**  
Instruments

PA50101A

Date 13.03.96

14:45

Sheet 1 of 1

PA-SMD

# CRT-Board

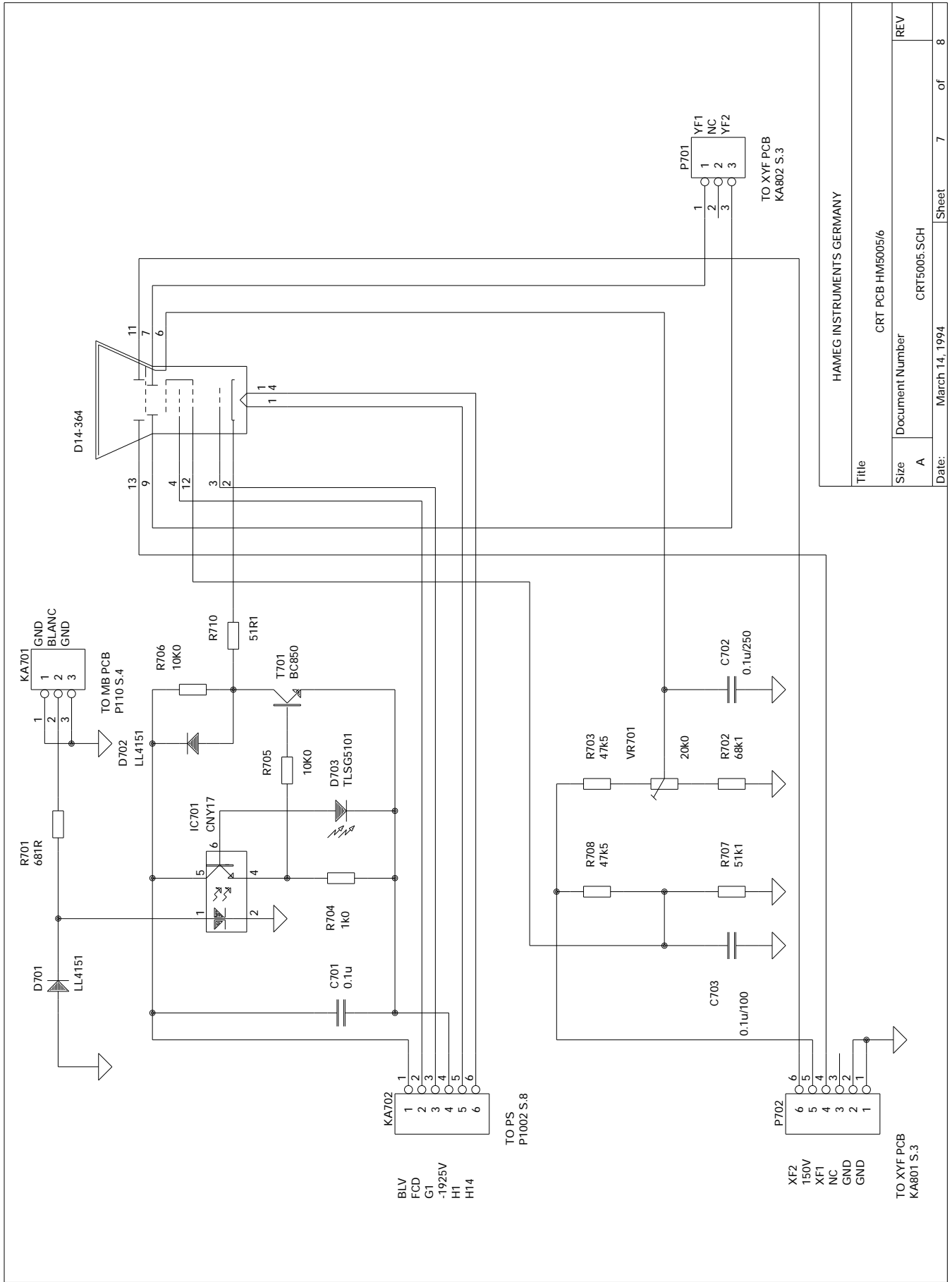

HAMEG INSTRUMENTS GERMANY			
Title			
CRT PCB HM5005/6			
Size	Document Number	Sheet	of
A	CRT5005.SCH	7	8
Date:	March 14, 1994		
REV			

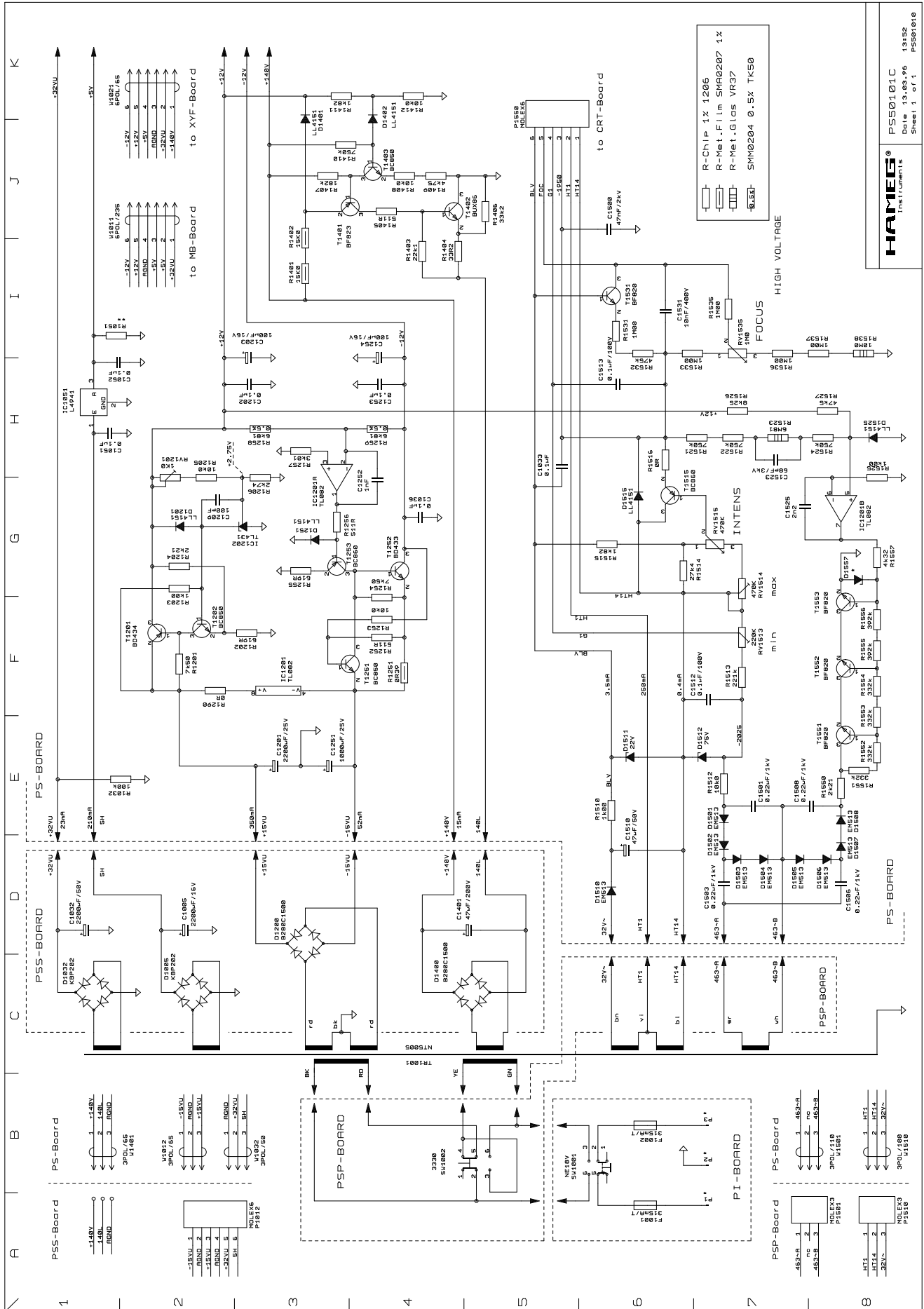



# RA-Board

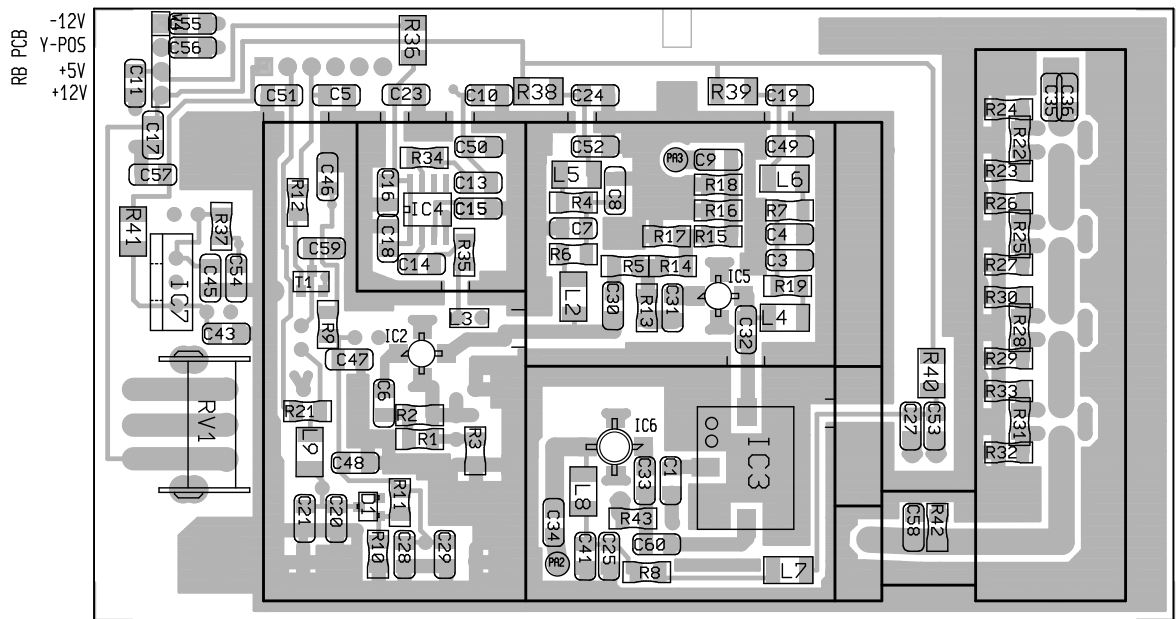
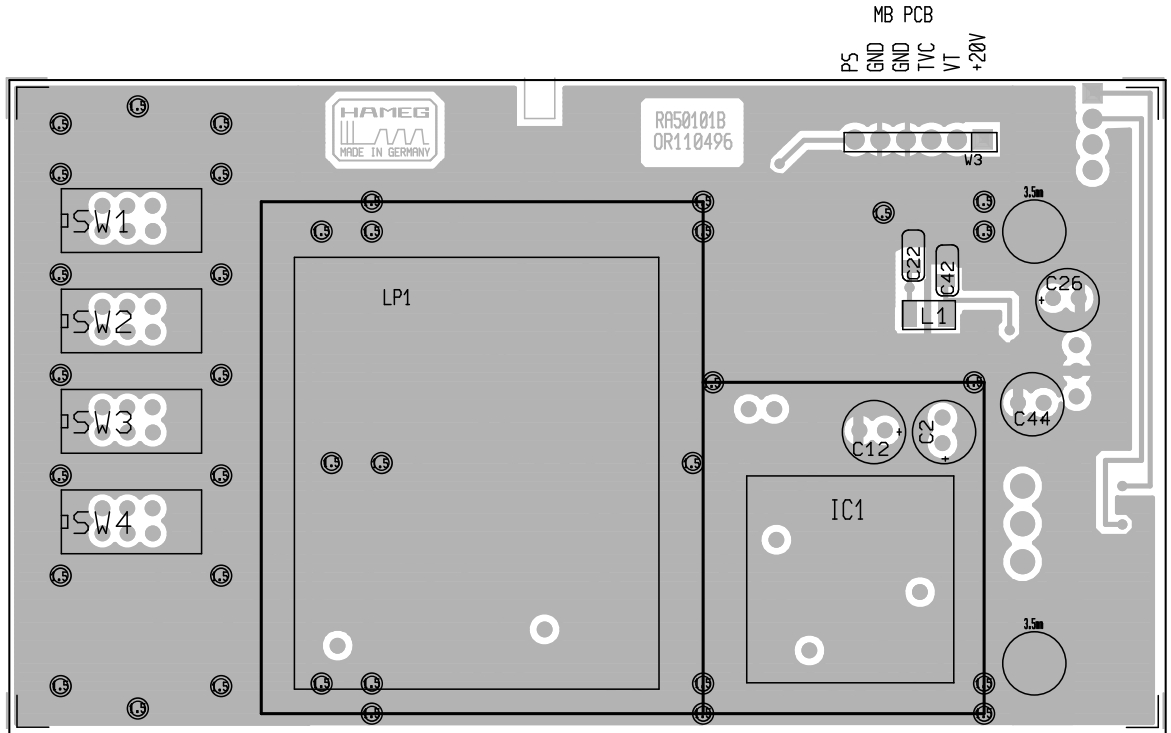

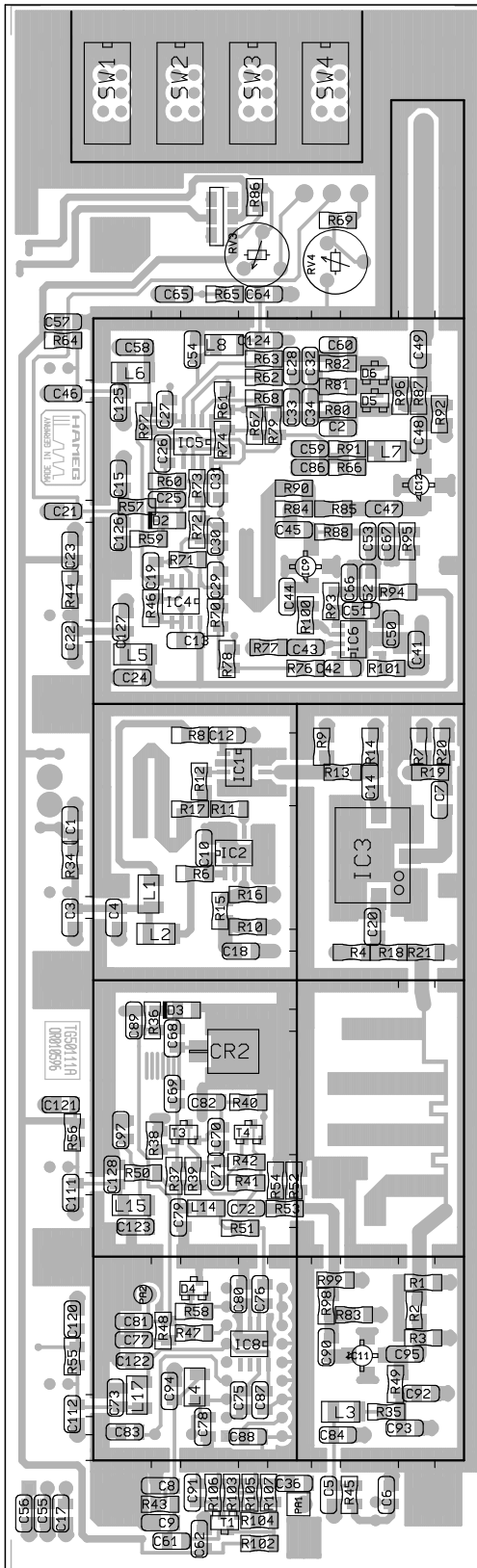

TO RB PCB

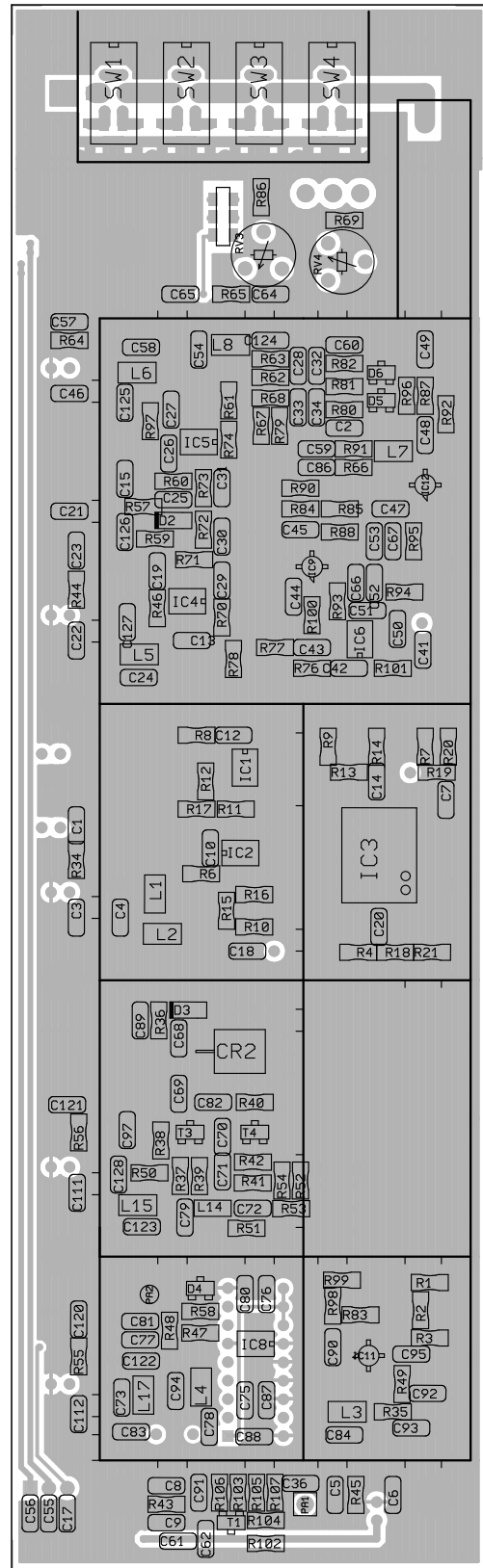

TO RB PCB

# RB-Board

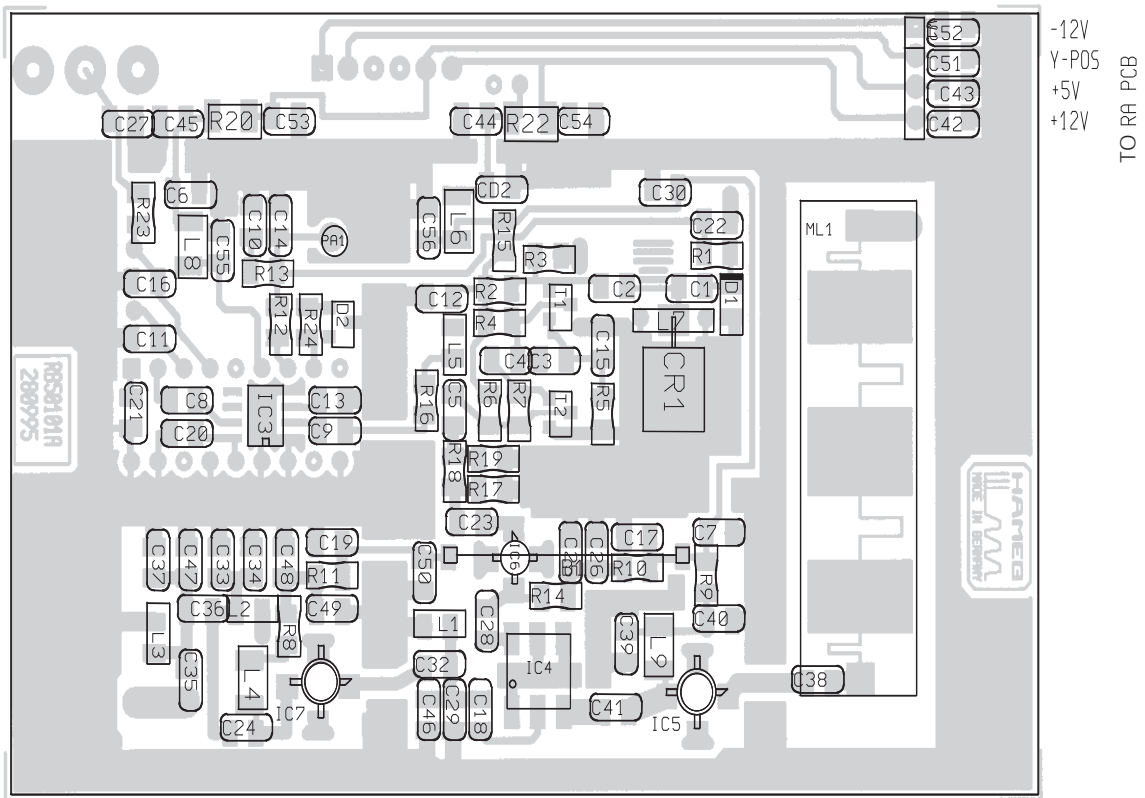
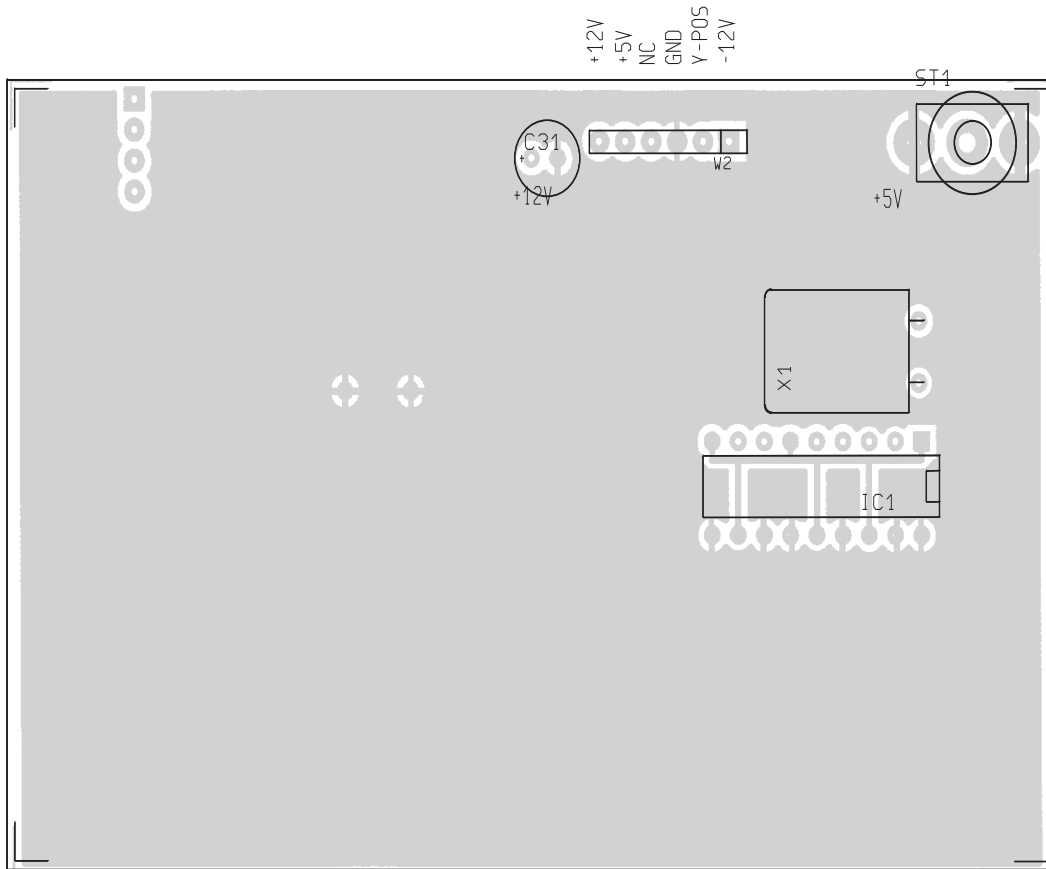

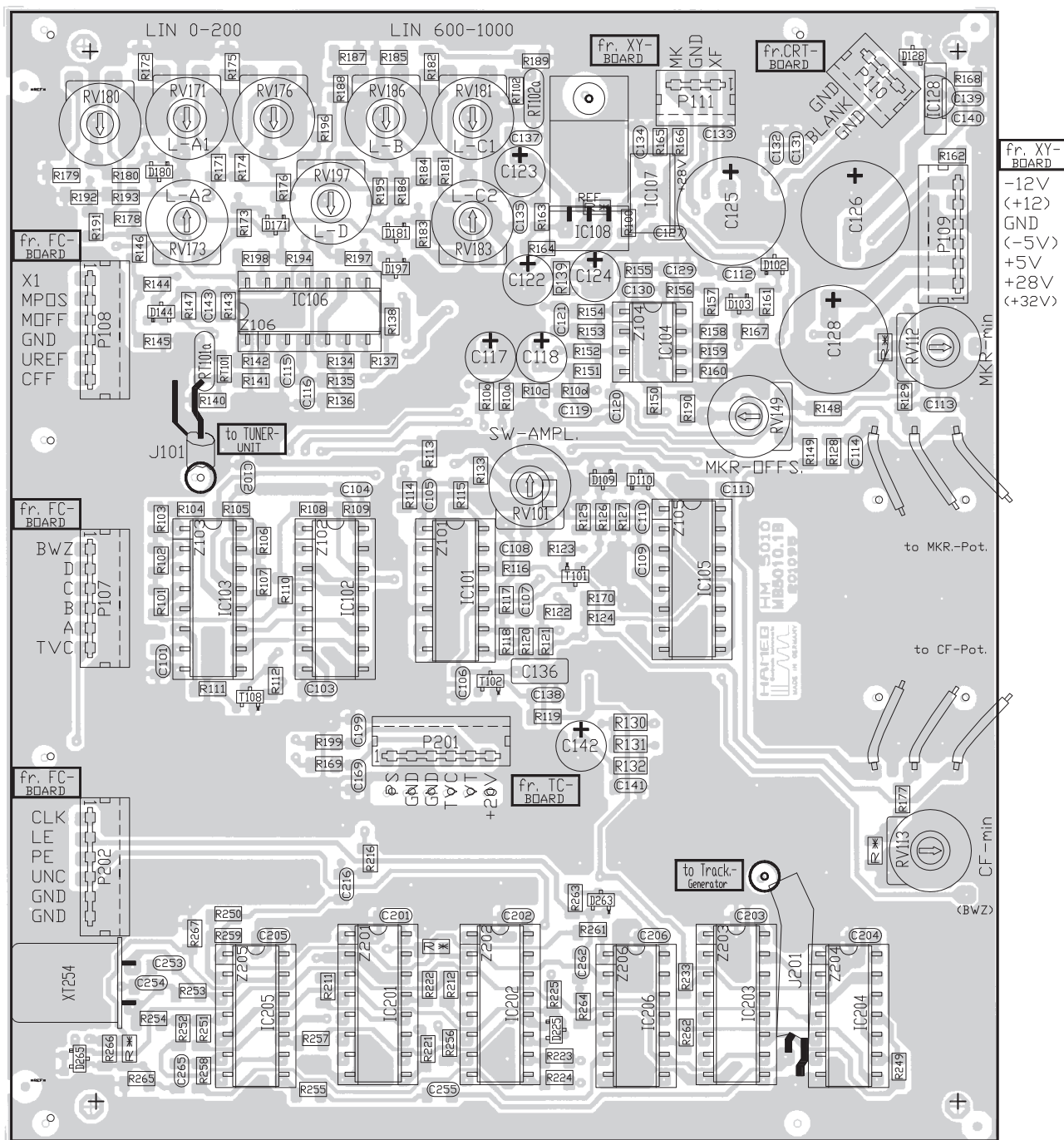

- fr. XY-BOARD
- 12V
  - (+12)
  - GND
  - (-5V)
  - +5V
  - +28V
  - (+32V)

# Main board

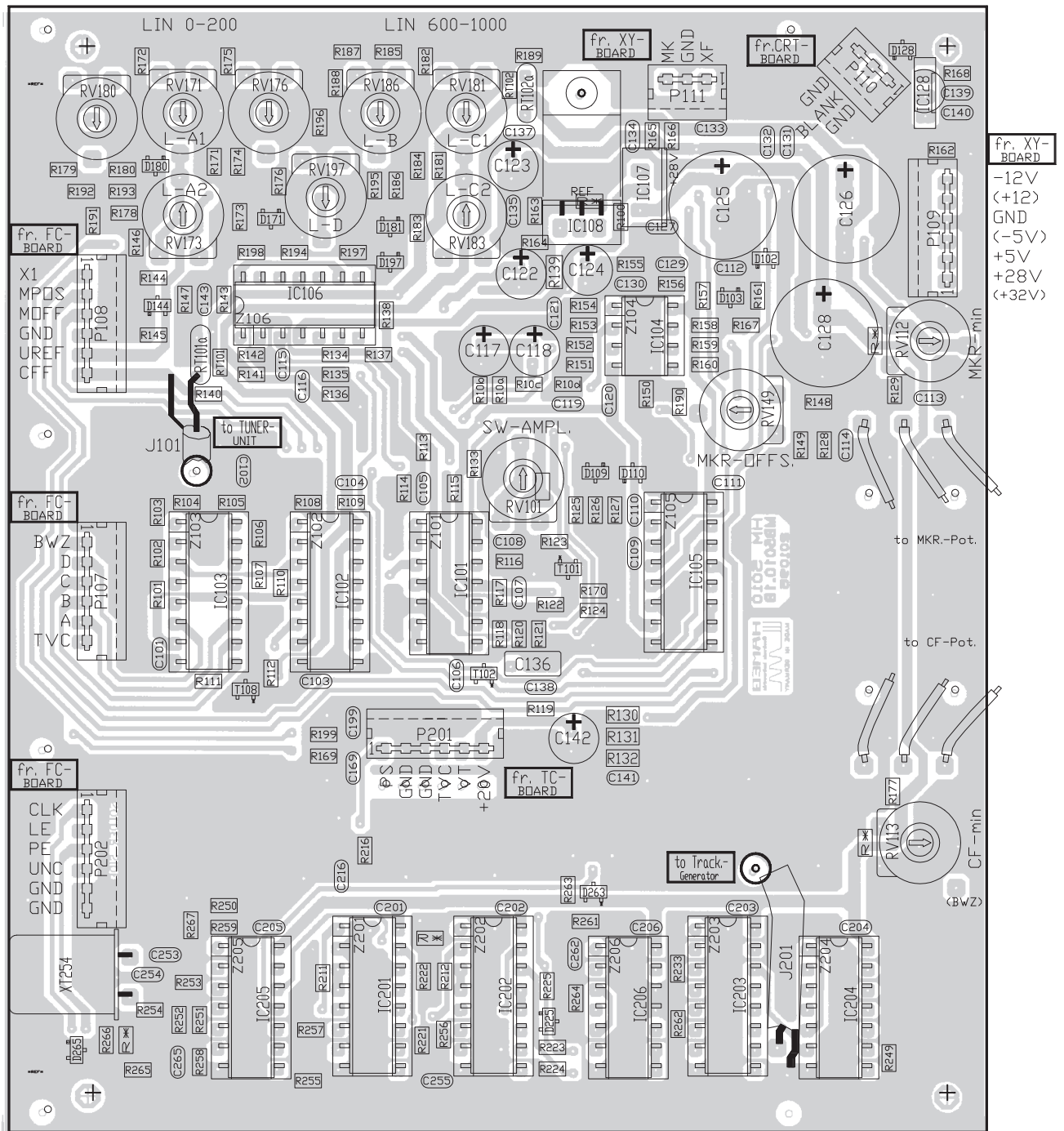

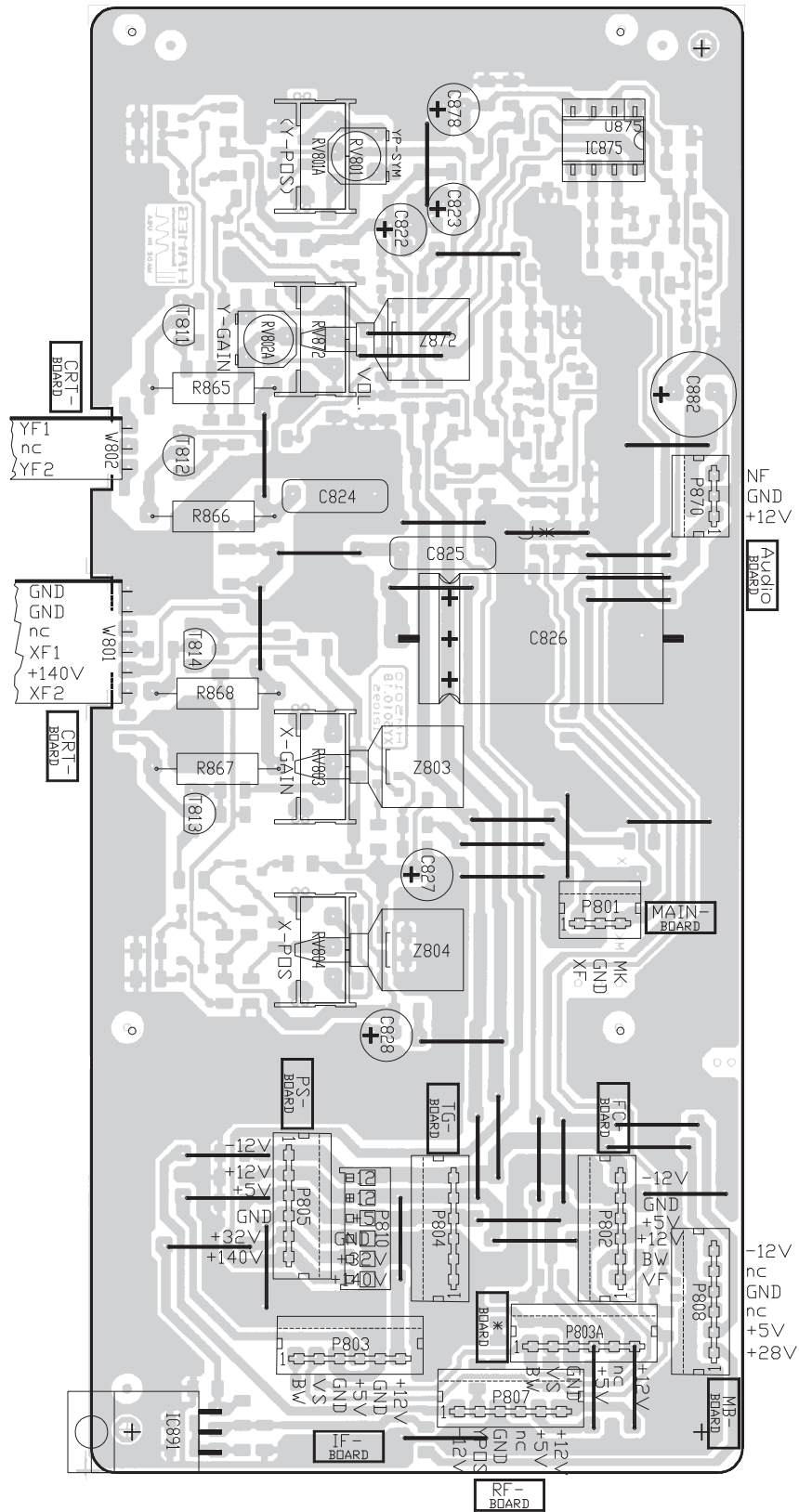

XY-Board

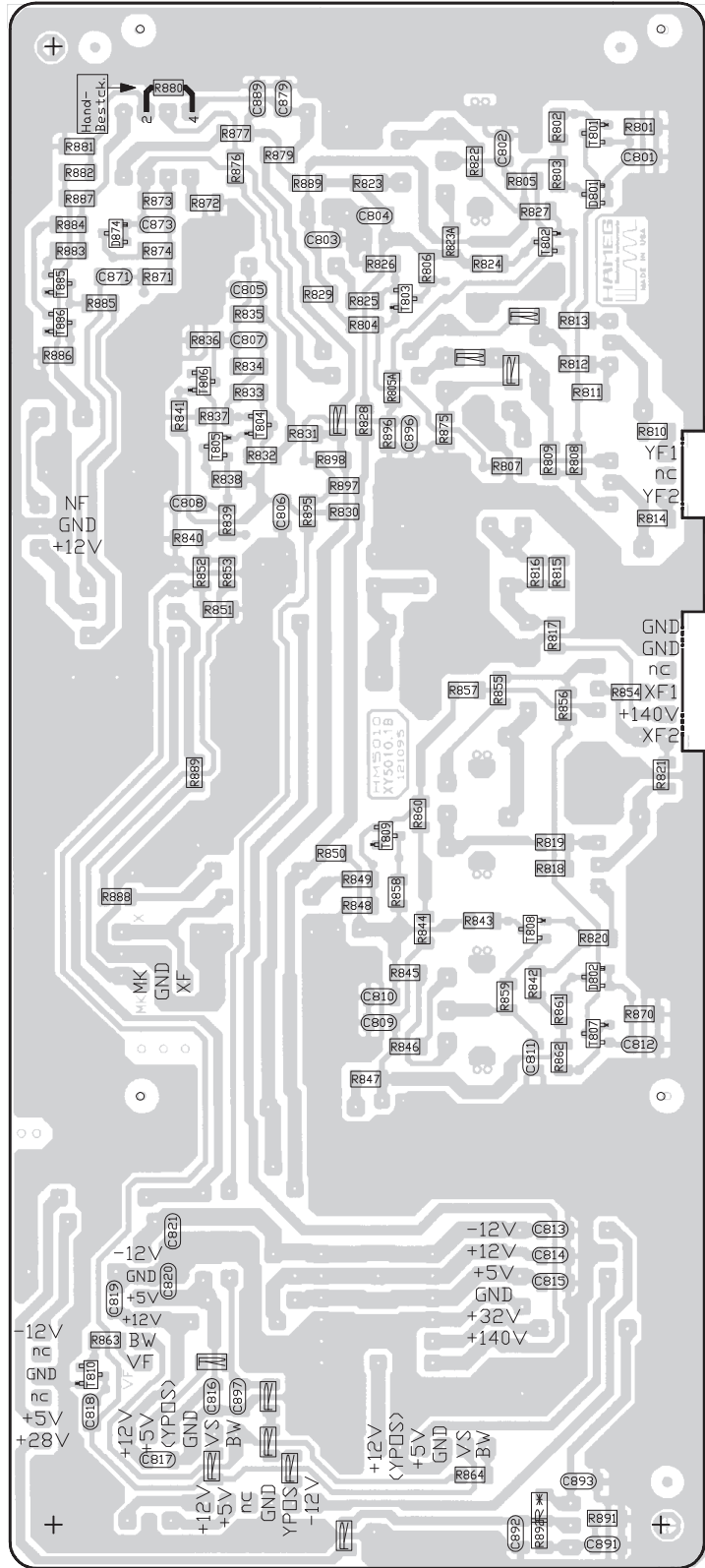

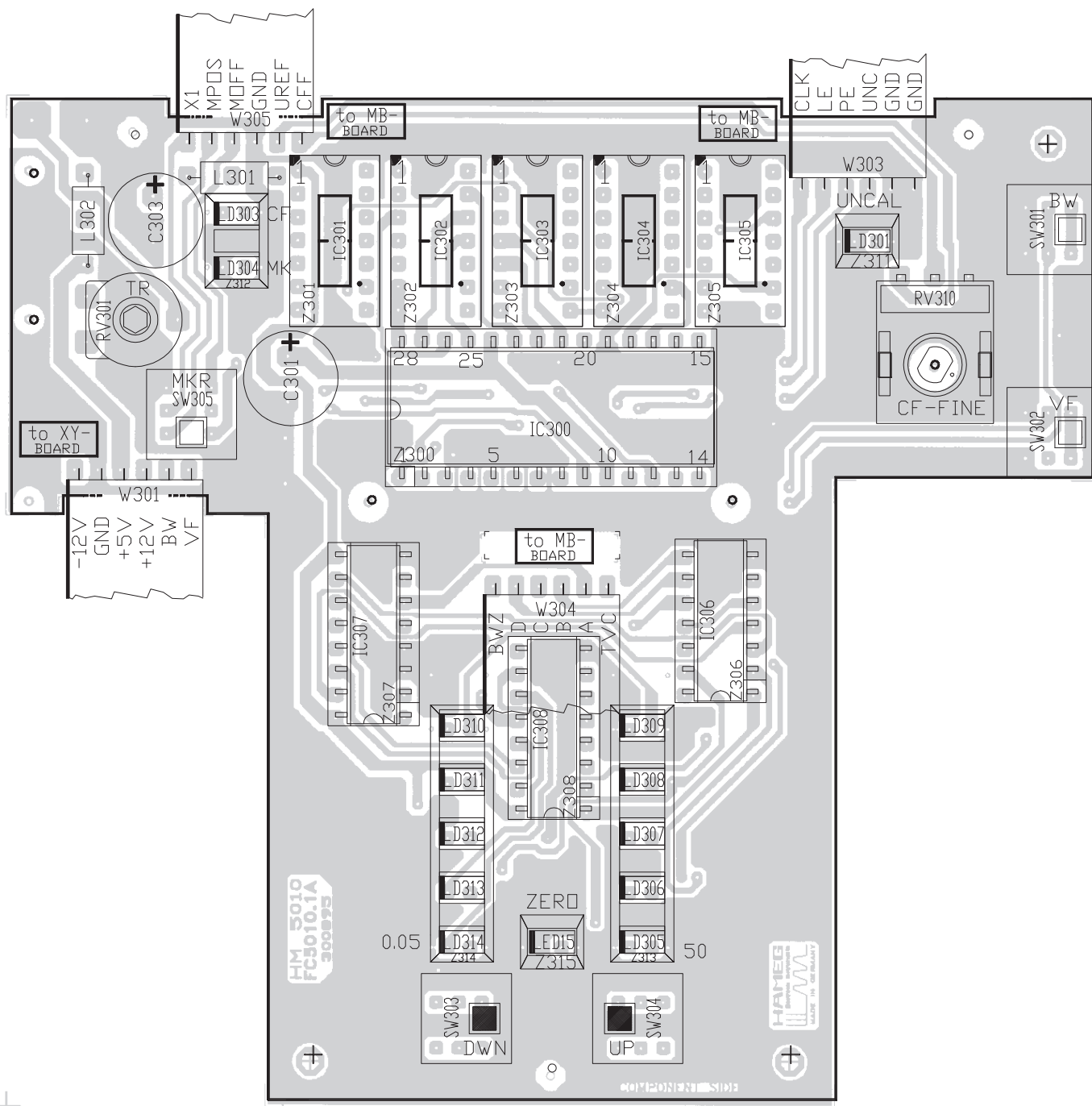



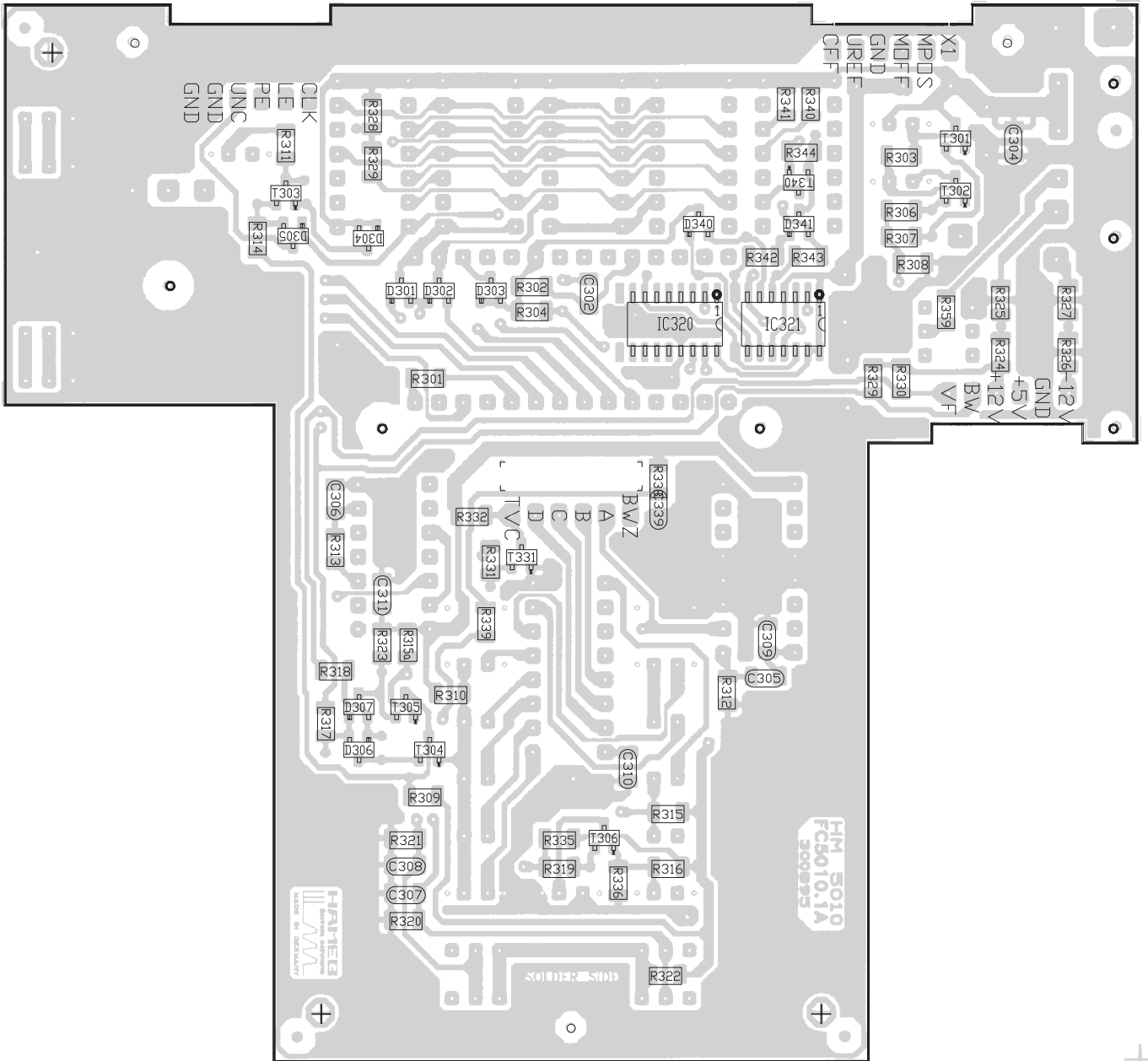

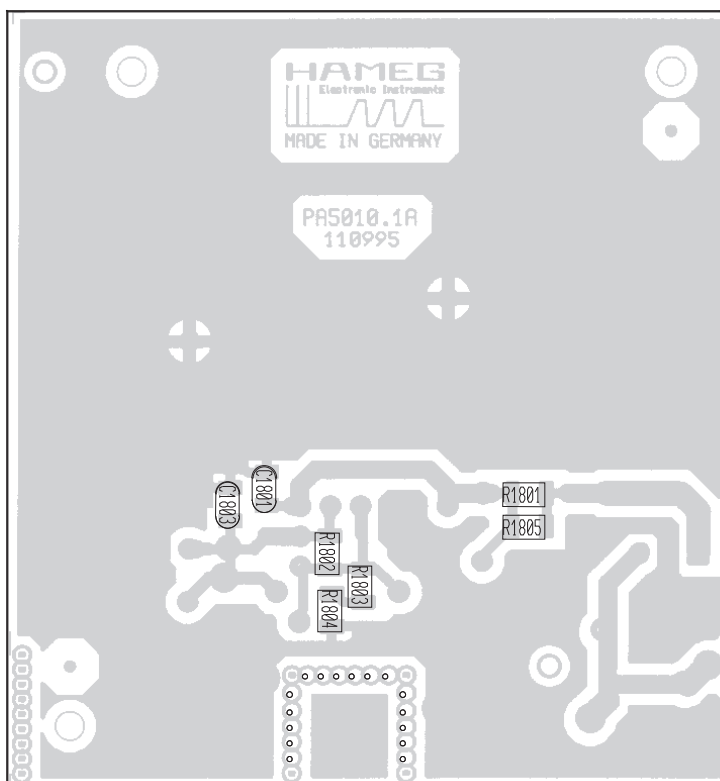
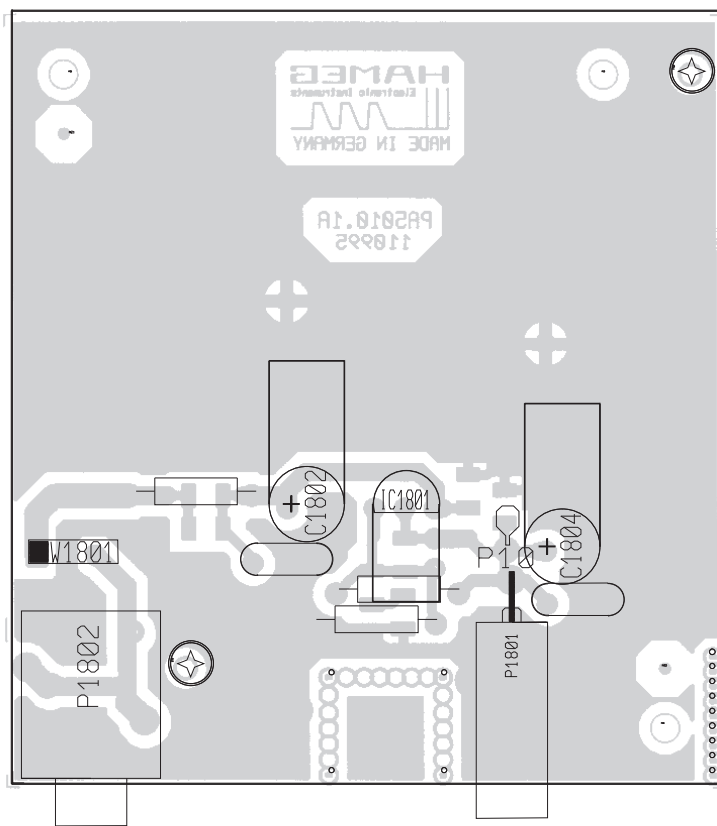

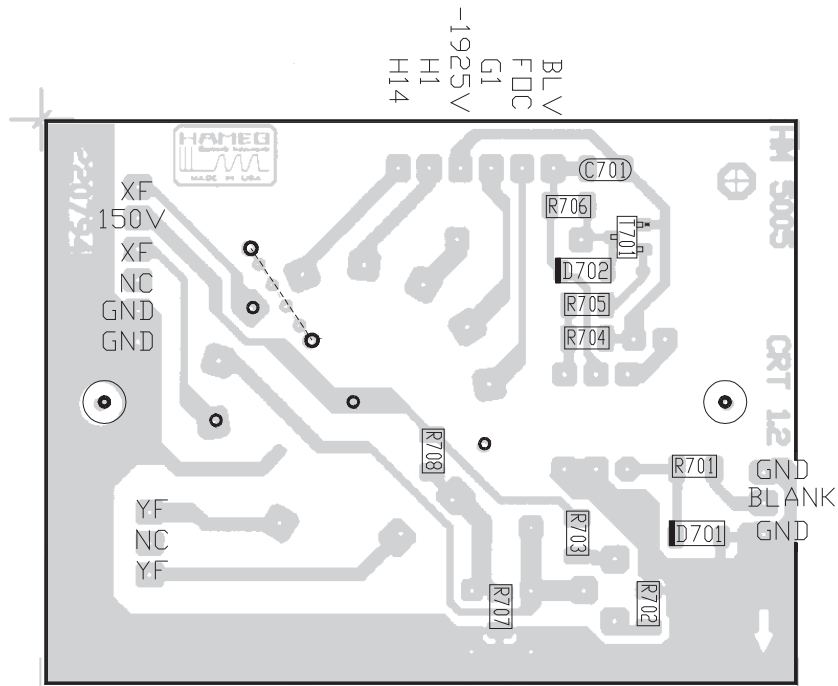
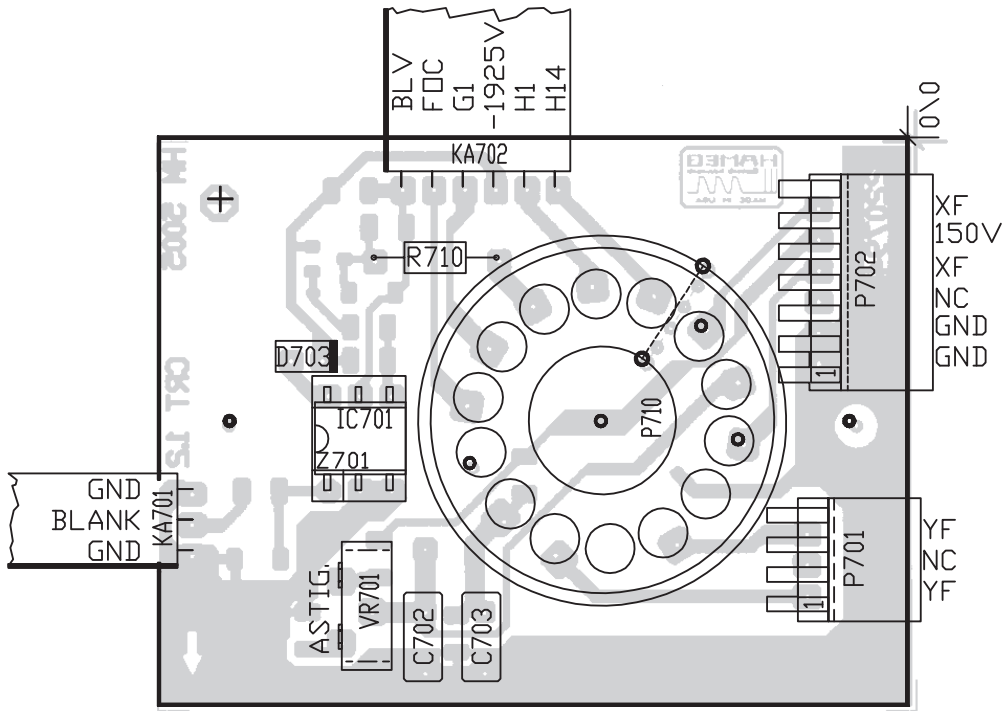

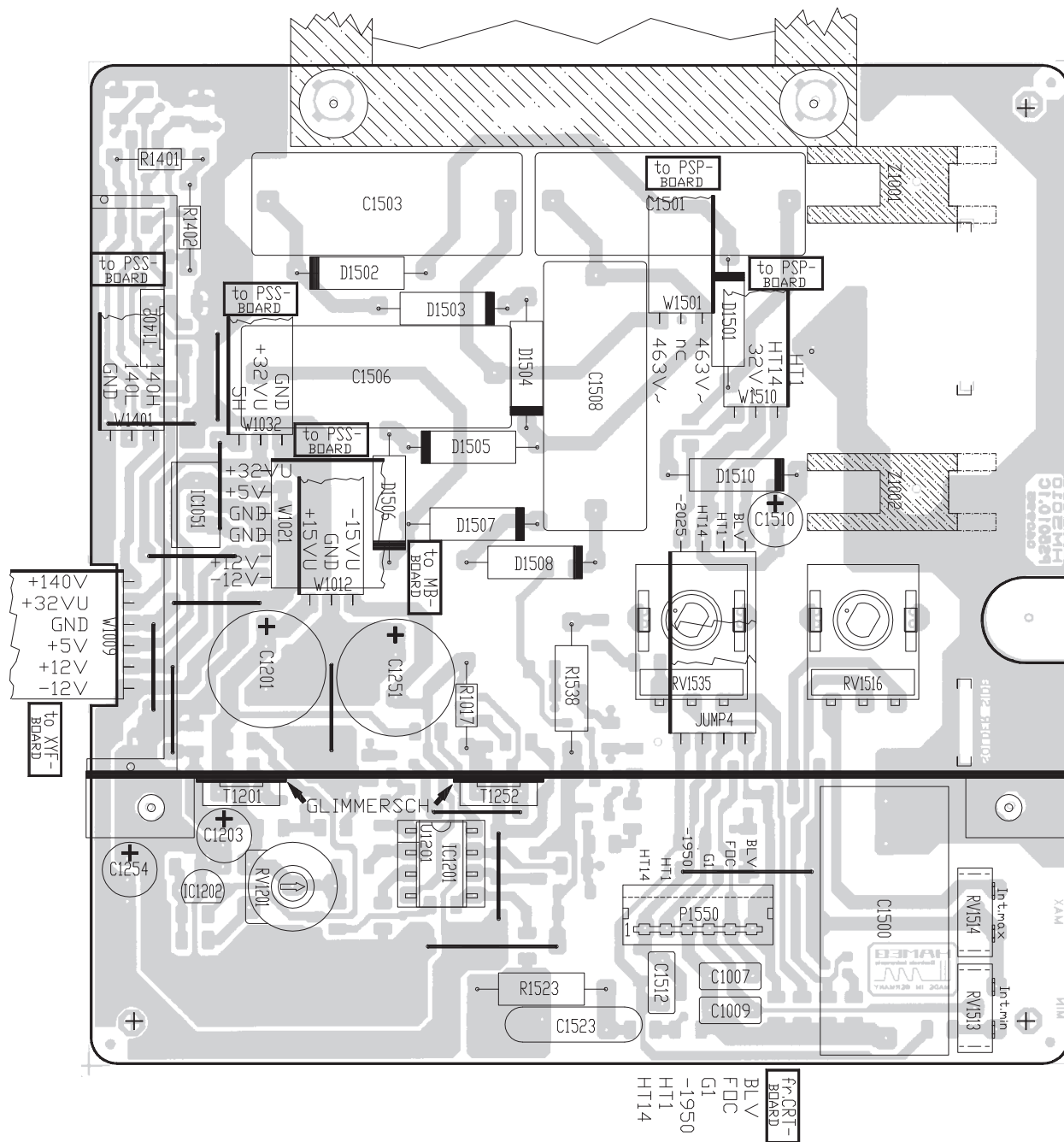

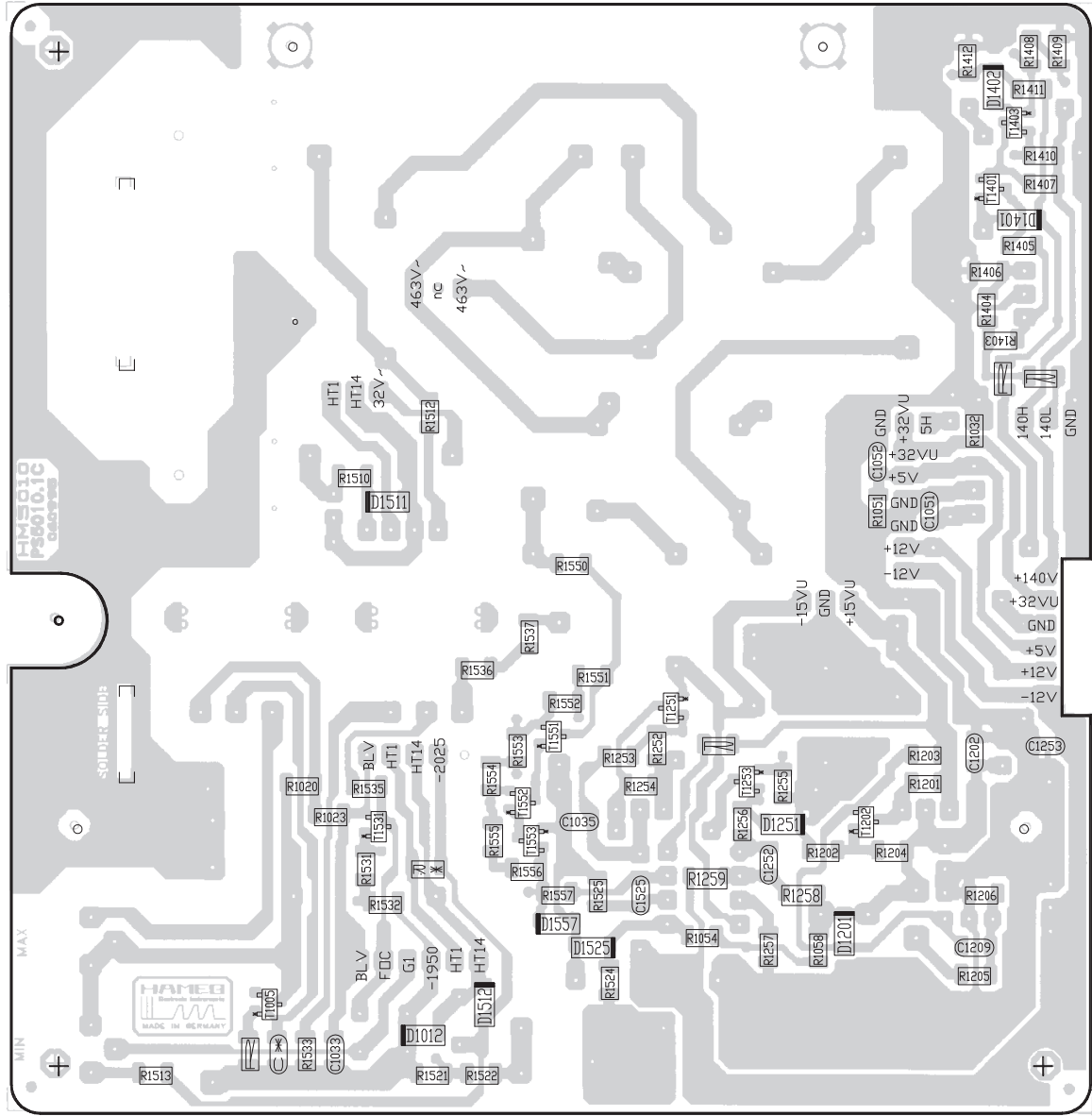

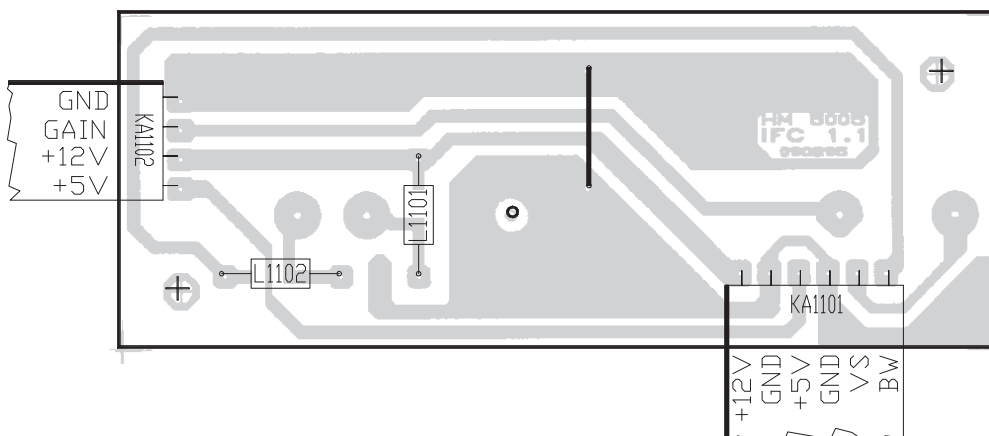
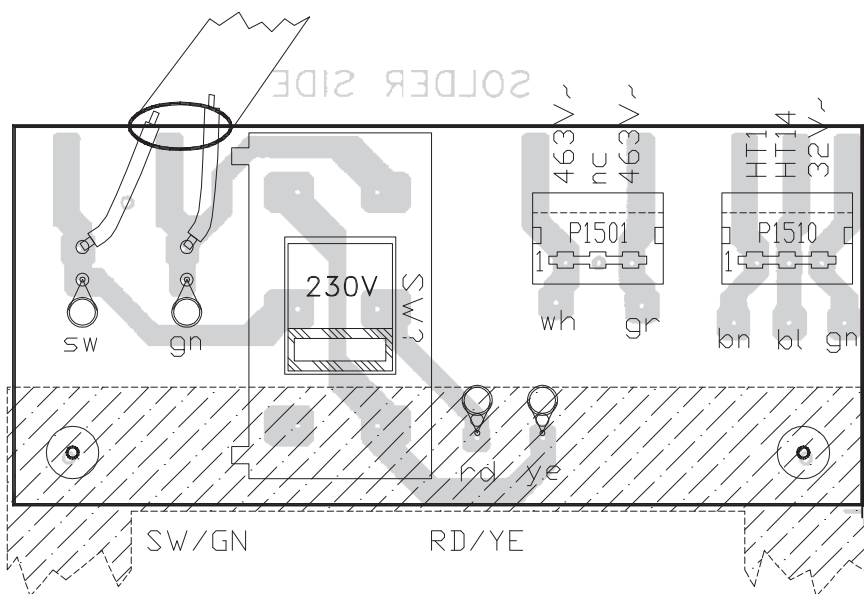
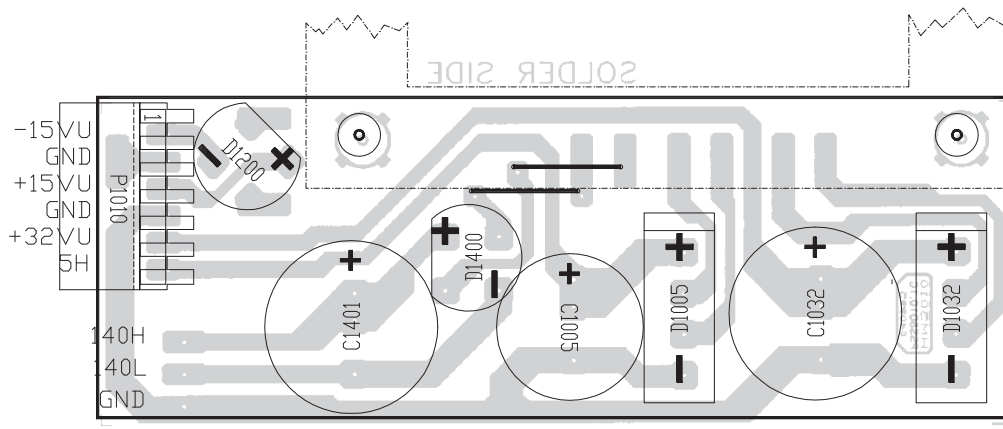

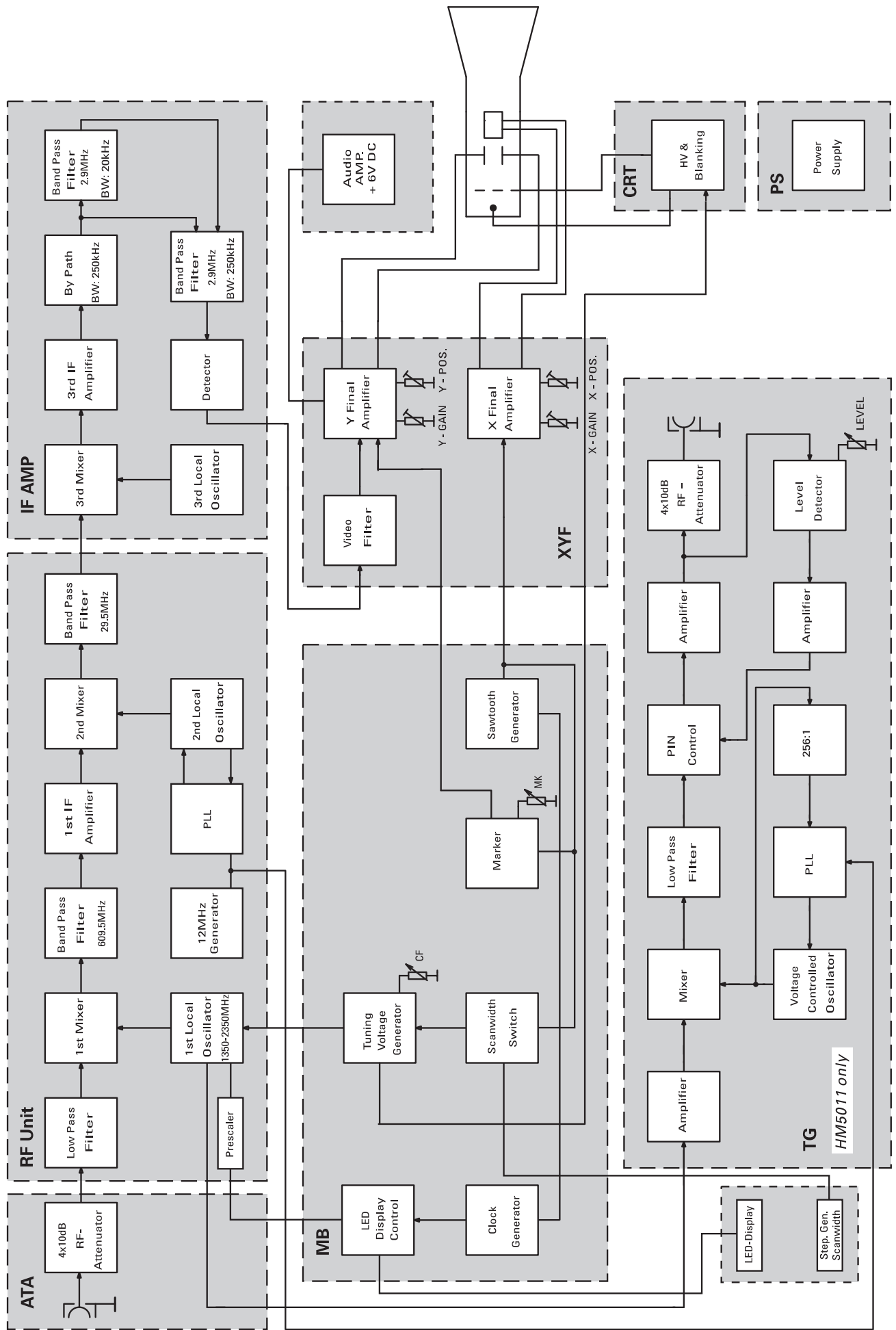

# **HAMEG<sup>®</sup>** **Instruments**

**Oscilloscopes**

**Multimeters**

**Counters**

**Frequency Synthesizers**

**Generators**

**R- and LC-Meters**

**Spectrum Analyzers**

**Power Supplies**

**Curve Tracers**

**Time Standards**

4S-5010-0010

**HAMEG GmbH**

Industriestraße 6

D-63533 Mainhausen

Telefon: +49 (0) 6182 / 800-0

Telefax: +49 (0) 6182 / 800-100

E-mail: [sales@hameg.de](mailto:sales@hameg.de)

[service@hameg.de](mailto:service@hameg.de)

Internet:  
**[www.hameg.de](http://www.hameg.de)**

Printed in Germany