

HAMEG

Instruments

MANUAL

Oscilloscope HM604

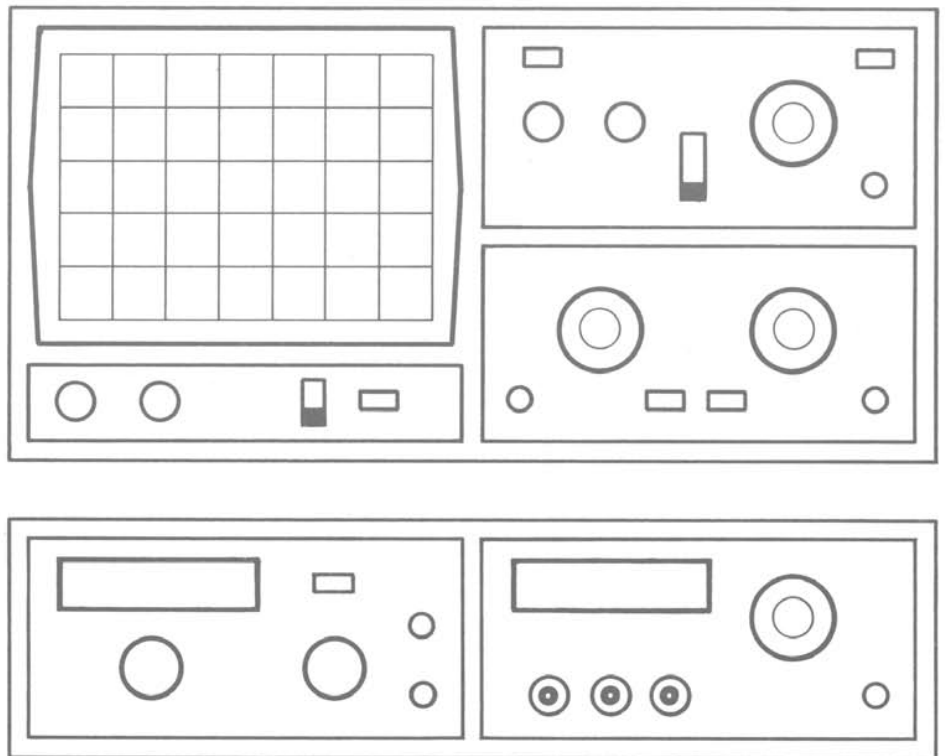

Technical Data P 1

Accessories Z 1

Operating Instructions

General Information M 1
 Use of tilt handle M 1
 Safety M 1
 Operating conditions M 2
 Warranty M 2
 Maintenance M 2
 Mains/Line voltage change M 2
 Type of Signal M 3
 Amplitude Measurements M 3
 Time Measurements M 4
 Connection of Test Signal M 5
 Operating M 6
 First Time Operation M 7
 Trace Rotation TR M 7
 DC Balance Adjustment M 7
 Use and Compensation of Probes M 8
 Operating Modes of the Y Amplifier M 9
 X-Y Operation M10
 X-Y Phase Measurements M10
 Dual Trace Phase Difference Measurements M10
 Measurement of an amplitude modulation M11
 Triggering and Timebase M11
 Triggering of video signals M12
 Function of variable HOLD OFF control M13
 Sweep Delay / After Delay Triggeringe M13
 Delay Mode Indication M15
 Component Tester M15
 Miscellaneous M17
 Test Patterns M18

Short Instruction K 1,

Front Panel Elements

Folder with Front View K 2

Test Instructions

General T 1
 Cathode-Ray Tube: Brightness, Focus,
 Linearity, Raster Distortions T 1
 Astigmatismus Check T 1
 Symmetry and Drift of the Vertical Amplifier T 1
 Calibration of the Vertical Amplifier T 1
 Transmission Performance of the Vertical Amplifier
 T 2
 Operating Modes: CH/II-TRIG. I/II, DUAL, ADD,
 CHOP., INV. I/II and XY-Betrieb T 2
 Triggering Checks T 3
 Timebase T 3
 Sweep Delay T 4
 Component Tester T 4
 Trace Alignment T 4
 Miscellaneous T 4

**Oscilloscope
 HM 604**

Service Instructions

General S 1
 Instrument Case Removal S 1
 Operating Voltages S 1
 Minimum Brightness S 1
 Astigmatismus control S 1
 Trouble Shooting the Instrument S 2
 Replacement of Components and Parts S 2
 Replacement of the Power Transformer S 2
 Adjustments S 3

Circuit Diagrams

Block Diagram D 1
 Wiring Diagram D 2
 Identification of Components D 3
 Y Input, Attenuator, Preamplifier CH. I/II D 4
 Y Intermediate Amplifiers, Trigger Pre-Amplifiers,
 Component Tester D 5
 Y Final Amplifier D 6
 Post Trigger, Field Selector D 7
 Timebase (analog) D 8
 Timebase (digital) D 9
 Timebase Generator D10
 X Final Amplifier, Calibrator D11
 CRT and HV circuit D12
 Power Supply D13

Component Locations

XY Board D14
 TB Board D15
 PTFS Board D16
 TBG, CAL, YF Boards D17
 CO, EY, Z Boards D18

Specification

Vertical Deflection

Operating modes: Channel I or Ch. II separate, Channel I and II; alternate or chopped. (Chopper frequency approx. 0.5MHz).
Sum or difference of Ch. I and Ch. II, (with invert buttons for both Channels).
XY-Mode: via Channel I and Channel II.
Frequency range: 2x DC to 60MHz (-3dB). Risettime: approx. 5.8ns. Overshoot: $\leq 1\%$.
Deflection coefficients: 12 calibrated steps from 5mV/div. to 20V/div in 1-2-5 sequence, variable 2.5:1 to min. **50V/cm**.
 Accuracy in calibrated position: $\pm 3\%$.
Y-Magnification x5 (calibrated) to **1mV/div.** (Frequency range DC to 20MHz, -3dB).
Input impedance: 1M Ω || 30pF.
 Input coupling: DC-AC-GD (Ground)
 Input voltage: max. 400V (DC + peak AC).
Y-output from CHI or CHII approx 50mV_{pp}/div.
Delay Line: approx. 90ns.

Trigger System

With **automatic** from 10Hz-100MHz, normal with level control from DC-100MHz.
LED indication for trigger action.
 Slope: positive or negative.
 Sources: Ch. I, Ch. II, line, external.
 Coupling: **AC** (≥ 10 Hz to approx. 20MHz), **DC LF** (DC - ≤ 50 kHz), **HF** (≥ 50 kHz - 100MHz).
Threshold: internal ≥ 5 mm, external ≥ 50 mV.
Active TV-Sync-Separator for line and frame. Slope positive or negative.
2nd. Triggering (Del. Trig.): autom. or slope controlled (independent from slope direction). \pm selection for TV mode.
 Threshold: 1 div; typical 0.5 div.
 Trigger bandwidth: ≥ 25 Hz to 60MHz.

Horizontal Deflection

Time coefficients: 23 calibrated steps from 50ns/div. to 1s/div in 1-2-5 sequence, variable 2.5:1 to min. 2.5s/div, accuracy in calibrated position: $\pm 3\%$.
 with **X-Magnifier x10** ($\pm 5\%$) to ≈ 5 ns/div..
 Hold-Off time: variable ($\geq 5:1$).
Delay: 7 decade steps from 100ns to 0.1s, variable approx 10:1 to 1s.
Bandwidth X-Amplifier: DC-5MHz (-3dB).
 Input X-Amplifier via Channel II, sensitivity see Ch. II specification.
X-Y phase shift: $< 3^\circ$ below 120kHz.
 Ramp output: approx. 5V, positive going.

Component Tester

Test voltage: max. 8.5V_{rms} (open circuit).
Test current: max. 8mA_{rms} (shorted).
Test frequency: 50 - 60Hz (line frequency).

General Information

Cathode-ray tube: 150CTB31 P43/123, rectangular screen, **internal graticule 8x10 cm**.
Total acceleration voltage: 12kV.
 Input for Z Modulation optional (TTL-level).
 Trace rotation: adjustable on front panel.
 Graticule illumination optional (3 steps).
Calibrator: square-wave generator switchable from ≈ 1 kHz to 1MHz (t, approx. 3ns).
 Output voltage: 0.2V and 2V $\pm 1\%$.
Protective system Safety Class I (IEC 348).
Line voltage: 110, 125, 220, 240V $\sim \pm 10\%$.
 Line frequency: 50 to 60Hz.
Power consumption: ≈ 40 Watt.
 Weight: approx. 8kg. Colour: techno-brown.
 Cabinet: **W** 285, **H** 145, **D** 380mm.
 Lockable tilt handle.

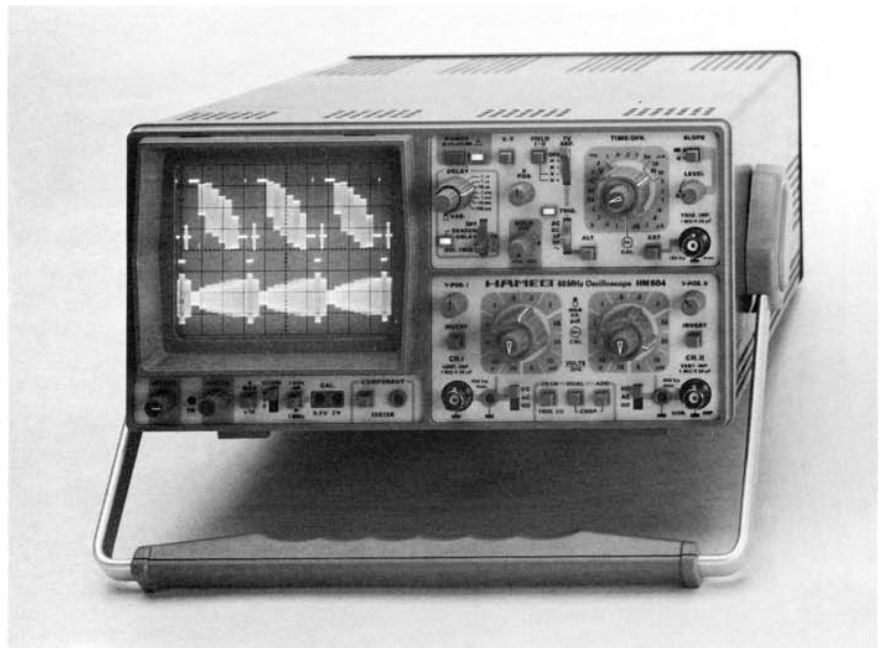

60 MHz Universal Oscilloscope

2 Channels, max. 1 mV/div., Delay Line, Component Tester.

Timebase: 2.5s-5ns/div. incl. x10. Sweep Delay.

Triggering DC to 80MHz, TV Sync-Separator, After-Delay Trig.

With its variety of operating and trigger modes, the **HM 604** is a new innovative **general purpose oscilloscope** satisfying a wide range of exacting requirements in laboratory, production, and service. The dual-channel measurement amplifier ensures highly faithful waveform transfer characteristics, which can be readily checked on the built-in fast-risetime **1MHz Calibrator** – from probe tip to **CRT** screen! Using Y-axis magnification, the instrument's high sensitivity enables stable displays of very small signals as low as 0.5mV. An analog output is provided for connecting multimeters or counters. Another important feature is the internal **delay line** for observations of the leading edge of a signal. As in dual-time base oscilloscopes, the **HM 604** features a calibrated sweep delay mode, allowing smallest waveform sections to be expanded up to **1000 times**.

The **HM 604's** most outstanding feature, however, is the unique, newly developed automatic **After-Delay Trigger** mode to ensure extremely stable displays and jitter-free measurements of asynchronous signal sections and bursts or pulse trains, independent of amplitude fluctuations. An active **TV-Sync-Separator** further enhances trigger quality of video frame and line signals. In the alternate trigger mode, two signals of different frequencies can be compared.

With this **state-of-the-art** oscilloscope, **HAMEG** again sets a new price/performance standard which is not likely to be met by others in this category at the moment. Despite the instrument's outstanding versatility, users will be particularly impressed by its ease of operation, while scope experts will soon recognise in many details that the **HM 604** hides decades of successful design experience!

Accessories supplied

2 switchable probes 10:1, 1:1; trimming tool for probes and DC balance; line cord, manual.

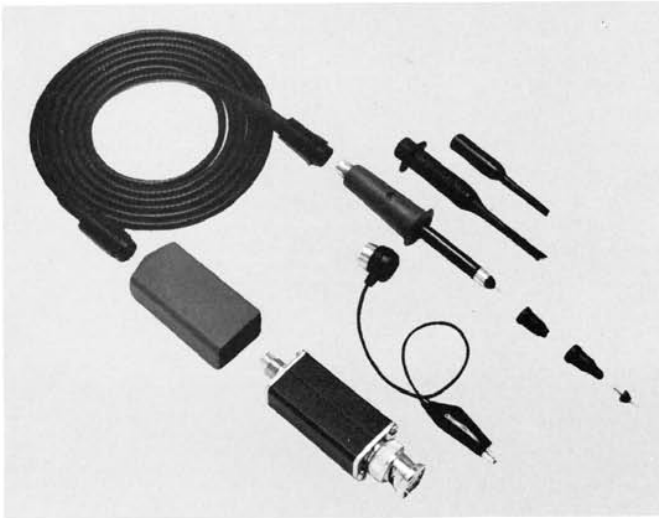

Modular Probes

The clear advantage over ordinary probes are field replaceable parts and the HF-compensation feature on the 10:1 attenuator probes. For the first time, probes in this price range allow adjustments of their HF-characteristics to match individually the input impedance of each scope. This is particularly important for scopes with higher bandwidths (>50MHz), as otherwise strong overshoot or rounding may occur, when measuring fast-rising square waves. An exact HF-compensation, however, is only possible with square-wave generators having a risetime <5ns. Most HAMEG scopes already feature such a calibration generator. For other oscilloscopes, it is available as accessory item HZ60. At present the following Modular Probes are available:

Type	HZ50	HZ51	HZ52	HZ53	HZ54 selectable
Attenuation Ratio	1:1	10:1	10:1 (HF)	100:1	1:1 / 10:1
Bandwidth min. (MHz)	30	150	250	150	10 / 150
Risetime (ns)	11	<2	<1.4	<2	35/<2
Inp. Capacitance (pF)	45	16	16	6,5	40/18
Inp. Resistance (MΩ)	1	10	10	100	1/10
Inp. Voltage max. (V _p)	600	600	600	1200	600
Cable Length (m)	1.2	1.2	1.5	1.5	1.2

Demodulator Probe

HZ55

Special probe for AM-demodulation and wobulator measurements. HF-Bandwidth 100kHz - 500MHz (±1dB). AC Input Voltage 250mV - 50V_{rms}. DC Isolation Voltage 200V DC including peak AC. Cable length 1.2m.

Conventional Probes

These popular standard probes are well suited for all oscilloscopes up to 20MHz bandwidth (HZ37 only with HF adjustment facility).

Typ	HZ30	HZ35	HZ36 selectable	HZ37 selectable	HZ39 selectable
Attenuation Ratio	10:1	1:1	1:1 / 10:1	1:1 / 10:1	1000:1
Bandwidth min. (MHz)	100	10	10 / 100	10 / 150	1
Risetime (ns)	3.5	35	35 / 3.5	20 / 3.2	50
Inp. Capacitance (pF)	13	47	47/13	44/13	3
Inp. Resistance (MΩ)	10	1	1/10	1/10	500
Outp. Resistance (MΩ)	1	1	1	1	1/10
Inp. Voltage (max. V _p)	600	600	600	600	15000
Cable Length (m)	1.5	1.5	1.5	1.2	1.5

Test Cable Banana—BNC

HZ32

Coaxial test cable; length 1.15 m, characteristic impedance 50Ω. Cable capacitance 120pF. Input voltage max. 500V_p.

Test Cable BNC—BNC

HZ34

Coaxial test cable; length 1.2m, characteristic impedance 50Ω. Cable capacitance 126pF. Input voltage max. 500V_p.

Adapter Banana—BNC

HZ20

Two 4mm binding posts (19mm between centers) to standard BNC male plug. Input voltage max. 500V_p.

50Ω Through-Termination

HZ22

For terminating systems with 50Ω characteristic impedance. Maximum load 2W. Max. voltage 10V_{rms}.

Carrying Cases

For HM203-1 and HM203-3	HZ42
For HM312, HM412, HM512 and HM705	HZ43
For HM307, HZ62 and HZ64	HZ44
For HM103	HZ45
For HM203-4, HM203-5, HM203-6, HM204, HM204-2, HM205, HM208 and HM605	HZ46

Viewing Hood

HZ47

For HM203, HM204, HM205, HM208, HM605, HM705, HM808 and HM312, HM412, HM512, HM812

Scope-Tester

HZ60

For Checking the Y amplifier, timebase, and compensation of all probes, the HZ60 is a crystal-controlled, fast rising (typ. 3ns) square-wave generator with switchable frequencies of 1, 10, 100kHz, and 1MHz. Three BNC outputs provide signals of 25mV_{pp} into 50Ω, 0.25V_{pp} and 2.5V_{pp} (open circuit for 10x and 100x probes); accuracy ±1%. Battery-powered or AC supply operated (optional).

Component-Tester

HZ65

Indispensable for trouble-shooting in electronic circuits. Single component and in-circuit tests are both possible. The HZ65 operates with all scopes, which can be switched to X-Y operation (ext. horizontal deflection). Non-destructive tests can be carried out on almost all semiconductors, resistors, capacitors, and coils. Two sockets provide for quick testing of the 3 junction areas in any small power transistor. Other components are connected by using 2 banana jacks. Test leads supplied.

Examples of Test Displays:

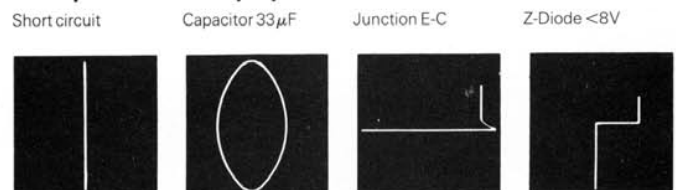

Operating Instructions

General Information

This oscilloscope is easy to operate. The logical arrangement of the controls allows anyone to become familiar with the operation of the instrument after a short time, however, experienced users are also advised to read through these instructions so that all functions are understood.

Immediately after unpacking, the instrument should be checked for mechanical damage and loose parts in the interior. If there is transport damage, the supplier must be informed immediately. The instrument must then not be put into operation.

Check that the instrument is set to the correct mains/line voltage. If not, refer to instructions on page M2.

Use of tilt handle

To view the screen from the best angle, there are three different positions (C, D, E) for setting up the instrument. If the instrument is set down on the floor after being carried, the handle remains automatically in the upright carrying position (A).

In order to place the instrument onto a horizontal surface, the handle should be turned to the upper side of the oscilloscope (C). For the D position (10° inclination), the handle should be turned in the opposite direction out of the carrying position until it locks in place automatically underneath the instrument. For the E position (20° inclination), the handle should be pulled to release it from the D position and swing backwards until it locks once more.

The handle may also be set to a position for horizontal carrying by turning it to the upper side to lock in the B position. At the same time, the instrument must be moved upwards, because otherwise the handle will jump back.

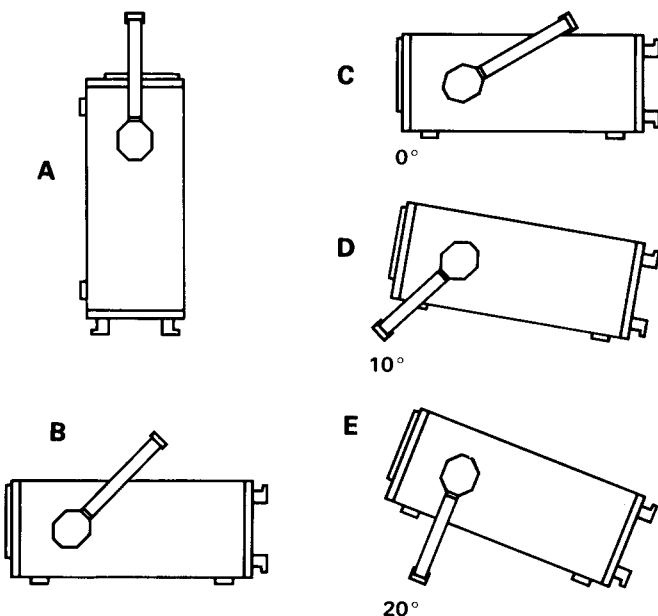

Safety

This instrument has been designed and tested in accordance with **IEC Publication 348, Safety Requirements for Electronic Measuring Apparatus**, and has left the factory in a safe condition. The present instruction manual contains important information and warnings which have to be followed by the user to ensure safe operation and to retain the oscilloscope in safe condition. The case, chassis and all measuring terminals are connected to the protective earth contact of the appliance inlet. The instrument operates according to **Safety Class I** (three-conductor power cord with protective earthing conductor and a plug with earthing contact). The mains/line plug shall only be inserted in a socket outlet provided with a protective earth contact. The protective action must not be negated by the use of an extension cord without a protective conductor.

Warning! Any interruption of the protective conductor inside or outside the instrument or disconnection of the protective earth terminal is likely to make the instrument dangerous. Intentional interruption of the protective earth connection is prohibited. The mains/line plug should be inserted before connections are made to measuring circuits.

The grounded accessible metal parts (case, sockets, jacks) and the mains/line supply contacts (line, neutral) of the instrument have been tested against insulation breakdown with **2000 Vr.m.s. (50 Hz)**.

Under certain conditions, 50 Hz or 60 Hz hum voltages can occur in the measuring circuit due to the interconnection with other mains/line powered equipment or instruments. This can be avoided by using an isolation transformer (Safety Class II) between the mains/line outlet and the power plug of the instrument. When displaying waveforms where the "low-level" side of the signal is at a high potential, even with the use of a protective isolation transformer, it should be noted that this potential is connected to the oscilloscope's case and other accessible metal parts. High voltages are dangerous. In this case, special safety precautions are to be taken, which must be supervised by qualified personnel if the voltage is higher than 42 V.

Most cathode-ray tubes develop X-rays. However, **the dose equivalent rate falls far below the maximum permissible value of 36 pA/kg (0.5 mR/h)**.

Whenever it is likely that protection has been impaired, the instrument shall be made inoperative and be secured against any unintended operation. The protection is likely to be impaired if, for example, the instrument

- shows visible damage,
- fails to perform the intended measurements,
- has been subjected to prolonged storage under unfavourable conditions (e.g. in the open or in moist environments),
- has been subject to severe transport stress (e.g. in poor packaging).

Operating conditions

The instrument has been designed for indoor use.

The permissible ambient temperature range during operation is +15°C ... +30°C. It may occasionally be subjected to temperatures between +10°C and -10°C without degrading its safety. The permissible ambient temperature range for storage or transportation is -40°C ... +70°C.

The maximum operating altitude is up to 2200m (non-operating 15000m). The maximum relative humidity is up to 80%.

If condensed water exists in the instrument it should be acclimatized before switching on. In some cases (e.g. extremely cold oscilloscope) two hours should be allowed before the instrument is put into operation. The instrument should be kept in a clean and dry room and must not be operated in explosive, corrosive, dusty, or moist environments. The oscilloscope can be operated in any position, but the convection cooling must not be impaired. **The ventilation holes may not be covered.** For continuous operation the instrument should be used in the horizontal position, preferably tilted upwards, resting on the tilt handle.

The specifications stating tolerances are only valid if the instrument has warmed up for 30 minutes at an ambient temperature between +15°C and +30°C. Values not stating tolerances are typical for an average instrument.

Warranty

Each instrument runs through a quality test with 10 hour burn-in before leaving the production. Practically every early failure is detected in intermittent operation by this method. However, it is possible that a component fails only after a lengthy operating period. Therefore a **functional guarantee of 2 years** is given for all units. The condition for this is that no modifications have been made in the instrument. In the case of shipments by post, rail or carrier it is recommended that the original packing is carefully preserved. Transport damages and damage due to gross negligence are not covered by the guarantee.

In the case of a complaint, a label should be attached to the housing of the instrument which describes briefly the faults observed. If at the same time the name and telephone number (dialing code and telephone or direct number or department designation) is stated for possible queries, this helps towards speeding up the processing of guarantee claims.

Maintenance

Various important properties of the oscilloscope should be carefully checked at certain intervals. Only in this way is it largely certain that all signals are displayed with the accuracy on which the technical data are based. The test methods described in the test plan of this manual can be performed without great expenditure on measuring instruments. However, purchase of the new HAMEG scope tester HZ 60, which despite its low price is highly suitable for tasks of this type, is very much recommended.

The exterior of the oscilloscope should be cleaned regularly with a dusting brush. Dirt which is difficult to remove on the casing and handle, the plastic and aluminium parts, can be removed with a moistened cloth (99% water +1% mild detergent). Spirit or washing benzine (petroleum ether) can be used to remove greasy dirt. The screen may be cleaned with water or washing benzine (but not with spirit (alcohol) or solvents), it must then be wiped with a dry clean lint-free cloth. Under no circumstances may the cleaning fluid get into the instrument. The use of other cleaning agents can attack the plastic and paint surfaces.

Switching over the mains/line voltage

The instrument is set for 220V (240V U.K.) line voltage on delivery. It can be switched over to other voltages at the fuse holder combined with the 3-pole appliance inlet at the rear of the instrument. Firstly the fuse holder printed with the voltage values is removed using a small screw driver and - if required - provided with another fuse. Refer to the table below for the prescribed value of the fuse. Then replace the fuse holder so that the impressed white triangle points to the desired voltage. Here pay attention that the cover plate is also correctly engaged. The use of repaired fuses or short circuiting the fuse holder is not allowed. Damage arising because of this is not covered by the guarantee.

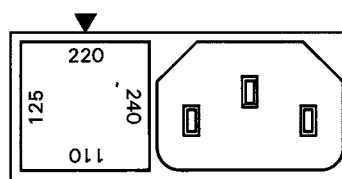

Fuse type: Size **5 x 20 mm**; 250 V~, C; IEC 127, Sheet III; DIN 41 662 (possibly DIN 41 571 sheet 3).

Cutoff: **time lag (T)**.

Line voltage	Fuse rating
110 V ~ ±10 %	T0.63 A
125 V ~ ±10 %	T0.63 A
220 V ~ ±10 %	T0.315 A
240 V ~ ±10 %	T0.315 A

Type of Signal

All types of signals with a frequency spectrum below 60 MHz can be displayed on the HM 604. The display of simple electrical processes such as sinusoidal RF and AF signals or ripple poses no problems. However, when square or pulse-shaped signals are displayed it must be remembered that their **harmonic content** must also be transmitted. In this case, the bandwidth of the vertical amplifier must be considerably higher than the repetition frequency of the signal. In view of this, accurate evaluation of such signals with the HM 604 is only possible up to a maximum repetition rate of 6 MHz. Operating problems can sometimes occur when composite signals are to be displayed, especially if they do not contain any suitable level components and repetition frequency which can be used for triggering. This occurs, for example, with burst signals. To obtain a stably triggered display in these cases, it may be necessary to use Normal Triggering, **HOLD OFF** time control, and/or **TIME/DIV.** variable control.

Video signals are easily triggerable by the aid of the active TV sync separator (**TV SEP.** switch).

For optional operation as a DC or AC voltage amplifier, each channel is provided with a **DC-AC** coupling switch. The **DC** position should only be used with an attenuator probe or at very low frequencies or if the determination of DC voltage content of the signal is absolutely necessary.

However, when investigating very low-frequency pulses, misleading ramp-offs may occur with **AC** coupling. In this case, **DC** operation is to be preferred if the signal voltage is not superimposed on a too high DC voltage level. Otherwise, a capacitor of adequate capacitance must be connected before the input of the vertical amplifier (switched to **DC** coupling). It should be remembered that this capacitor must have a sufficiently high breakdown voltage. **DC** operation is also recommended for the display of logic and pulse signals, particularly if their pulse duty factor changes permanently during operation. Otherwise, the display will move up and down with any change. DC voltages can only be measured in the **DC** position.

Amplitude Measurements

In general electrical engineering, alternating voltage data normally refers to effective values (rms = root-mean-square value). However, for signal magnitudes and voltage designations in oscilloscope measurements, the peak-to-peak voltage (V_{pp}) value is applied. The latter corresponds to the real potential difference between the most positive and most negative points of a signal waveform.

If a sinusoidal waveform, displayed on the oscilloscope screen, is to be converted into an effective (rms) value, the resulting peak-to-peak value must be divided by $2 \times \sqrt{2} = 2.83$. Conversely, it should be observed that sinusoidal voltages indicated in V_{rms} (V_{eff}) have 2.83 times the potential difference in V_{pp} . The relationship between the different voltage magnitudes can be seen from the following figure.

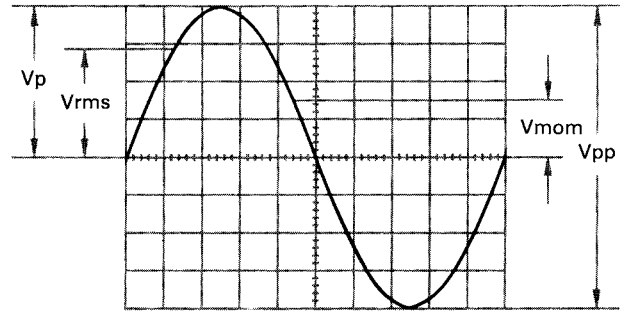

Voltage values of a sine curve

V_{rms} = effective value; V_p = simple peak or crest value;
 V_{pp} = peak-to-peak value; V_{mom} = momentary value.

The minimum signal voltage required at the vertical amplifier input for a display of 1 cm is approximately **1 mV_{pp}**. This is achieved with the attenuator control set at **5 mV/cm**, its **variable control in the fully clockwise position and pulled out**. However, smaller signals than this may also be displayed. The **deflection coefficients** on the input attenuators are indicated in **mV/cm** or **V/cm** (peak-to-peak value).

The magnitude of the applied voltage is ascertained by multiplying the selected deflection coefficient by the vertical display height in cm.

If an attenuator probe x 10 is used, a further multiplication by a factor of 10 is required to ascertain the correct voltage value.

For exact amplitude measurements the variable control on the attenuator switch must be set to its calibrated detent CAL. When turning the variable control ccw the sensitivity will be decreased by a factor of 2.5.

Therefore every intermediate value is possible within the 1-2-5 sequence.

With direct connection to the vertical input, **signals up to 400 V_{pp}** may be displayed (attenuator set to **20 V/cm**, variable control ccw).

When pulling the variable control knob (**MAG x5**), the sensitivity is increased by a factor of 5. Hence follows a min. deflection coefficient of **1 mV/cm** (reduced bandwidth).

With the designations

H = display height in cm,

U = signal voltage in V_{pp} at the vertical input,

D = deflection coefficient in **V/cm** at attenuator switch, the required quantity can be calculated from the two given quantities:

$$U = D \cdot H$$

$$H = \frac{U}{D}$$

$$D = \frac{U}{H}$$

However, these three values are not freely selectable. They have to be within the following limits (trigger threshold, accuracy of reading):

- H** between 0.5 and 8 cm, if possible 3.2 to 8 cm,
- U** between 1 mV_{pp} and 160 V_{pp},
- D** between 5 mV/cm and 20 V/cm in 1-2-5 sequence.
- D** between 1 mV/cm and 4 V/cm in 1-2-5 sequence (*with pulled MAG x5 knob*).

Examples:

Set deflection coefficient **D** = 50 mV/cm \cong 0.05 V/cm,
 observed display height **H** = 4.6 cm,
required voltage U = 0.05 · 4.6 = **0.23 V_{pp}**.

Input voltage **U** = 5 V_{pp},
 set deflection coefficient **D** = 1 V/cm,
required display height H = 5 : 1 = **5 cm**

Signal voltage $U = 220 V_{rms} \cdot 2 \cdot \sqrt{2} = 622 V_{pp}$
 (voltage > 160 V_{pp}, with probe X10 : **U** = 62.2 V_{pp}),
 desired display height **H** = min. 3.2 cm, max. 8 cm,
 max. deflection coefficient **D** = 62.2 : 3.2 = 19.4 V/cm,
 min. deflection coefficient **D** = 62.2 : 8 = 7.8 V/cm,
adjusted deflection coefficient D = 10 V/cm

If the applied signal is superimposed on a DC (direct voltage) level the total value (DC + peak value of the alternating voltage) of the signal across the Y-input must not exceed ±400 V (see figure). This same limit applies to normal x10 attenuator probes, the attenuation ratio of which allows signal voltages up to approximately 1,000 V_{pp} to be evaluated. Voltages of up to approximately 2,400 V_{pp} may be measured by using the HZ53 high voltage probe which has an attenuation ratio of 100:1. It should be noted that its AC_{peak} value is derated at higher frequencies. If a normal x10 probe is used to measure high voltages there is the risk that the compensation trimmer bridging the attenuator series resistor will break down causing damage to the input of the oscilloscope. However, if for example only the residual ripple of a high voltage is to be displayed on the oscilloscope, a normal x10 probe is sufficient. In this case, an appropriate high voltage capacitor (approx. 22-68 nF) must be connected in series with the input tip of the probe.

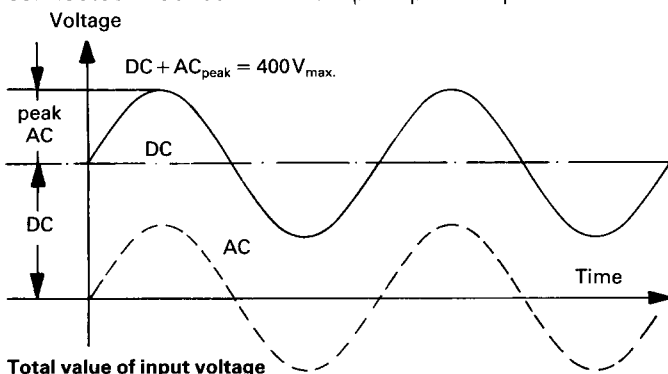

Total value of input voltage
 The dotted line shows a voltage alternating at zero volt level. When superimposed a DC level, the addition of the positive peak and the DC voltage results in the max. voltage (DC + AC_{peak}).

It is very important that the oscilloscope input coupling is set to **DC**, if an attenuator probe is used for voltages higher than 400V (see page M6: Connection of Test Signal).

Time Measurements

As a rule, all signals to be displayed are periodically repeating processes and can also be designated as periods. The number of periods per second is the recurrence frequency or repetition rate. One or more signal periods or even part of a period may be shown as a function of the adjustment of the **TIME/DIV.** switch. The time coefficients on the **TIME/DIV.** switch are indicated in **s/cm, ms/cm, and μs/cm**. Accordingly, the dial is subdivided into three sectors. **The duration of a signal period or a portion of the waveform is ascertained by multiplying the relevant time (horizontal distance in cm) by the time coefficient selected on the TIME/DIV. switch. The time variable control (small knob on the TIME/DIV. switch) must be in its calibrated detent CAL. for accurate measurement** (arrow horizontal and pointing to the right).

With the designations

- L** = displayed wave **length in cm** of one period,
 - T** = **time in seconds** for one period,
 - F** = recurrence **frequency in Hz** of the signal,
 - T_c** = **time coefficient in s/cm** on timebase switch
- and the relation **F = 1/T**, the following equations can be stated:

$$T = L \cdot T_c \qquad L = \frac{T}{T_c} \qquad T_c = \frac{T}{L}$$

$$F = \frac{1}{L \cdot T_c} \qquad L = \frac{1}{F \cdot T_c} \qquad T_c = \frac{1}{L \cdot F}$$

With X-MAG. x10 button depressed the T_c value must be divided by 10.

However, these four values are not freely selectable. They have to be within the following limits:

- L** between 0.2 and 10 cm, if possible 4 to 10 cm,
- T** between 5 ns and 10 s,
- F** between 0.1 Hz and 60 MHz,
- T_c** between 50 ns/cm and 1 s/cm in 1-2-5 sequence (*with X MAG. x10 in out position*), and
- T_c** between 5 ns/cm and 100 ms/cm in 1-2-5 sequence (*with pushed X MAG. x10 button*).

Examples:

Displayed wavelength **L** = 7 cm,
 set time coefficient **T_c** = 0.5 μs/cm,
required period T = 7 · 0.5 · 10⁻⁶ = **3.5 μs**
required rec. freq. F = 1 : (3.5 · 10⁻⁶) = **286 kHz**.

Signal period **T** = 0.5 s,
 set time coefficient **T_c** = 0.2 s/cm,
required wavelength L = 0.5 : 0.2 = **2.5 cm**.

Displayed ripple wavelength $L = 1 \text{ cm}$,
 set time coefficient $T_c = 10 \text{ ms/cm}$,
required ripple freq. $F = 1 : (1 \cdot 10 \cdot 10^{-3}) = 100 \text{ Hz}$.

TV-line frequency $F = 15\,625 \text{ Hz}$,
 set time coefficient $T_c = 10 \text{ } \mu\text{s/cm}$,
required wavelength $L = 1 : (15\,625 \cdot 10^{-5}) = 6.4 \text{ cm}$.

Sine wavelength $L = \text{min. } 4 \text{ cm, max. } 10 \text{ cm}$,
 Frequency $F = 1 \text{ kHz}$,
 max. time coefficient $T_c = 1 : (4 \cdot 10^3) = 0.25 \text{ ms/cm}$,
 min. time coefficient $T_c = 1 : (10 \cdot 10^3) = 0.1 \text{ ms/cm}$,
set time coefficient $T_c = 0.2 \text{ ms/cm}$,
required wavelength $L = 1 : (10^3 \cdot 0.2 \cdot 10^{-3}) = 5 \text{ cm}$.

Displayed wavelength $L = 0.8 \text{ cm}$,
 set time coefficient $T_c = 0.5 \text{ } \mu\text{s/cm}$,
pressed MAG X10 button: $T_c = 0.05 \text{ } \mu\text{s/cm}$,
required rec. freq. $F = 1 : (0.8 \cdot 0.05 \cdot 10^{-6}) = 25 \text{ MHz}$,
required period $T = 1 : (25 \cdot 10^6) = 40 \text{ ns}$.

If the time is relatively short as compared with the complete signal period, an expanded time scale should always be applied (**X MAG x10** button pushed). In this case, the ascertained time values have to be divided by **10**. Very small time intervals at optional points of the signal can be measured more exactly with the aid of the sweep delay. With it, the display and measurement of time intervals, which are smaller than 1% of the full signal period, are possible. The smallest measurable time interval is, on the whole, dependent on the obtainable brightness of the CRT. The limit is an expansion of approximately 1000 times. Using a Viewing Hood HZ47, more expansion is possible, provided that the time coefficient set on the **TIME/DIV.** switch is greater than **5 $\mu\text{s/cm}$** (and using the **X MAG x10** facility) for the signal's basic period. Otherwise, the fastest sweep speed determines the greatest possible expansion.

When investigating pulse or square waveforms, the critical feature is the **risetime of the voltage step**. To ensure that transients, ramp-offs, and bandwidth limits do not unduly influence the measuring accuracy, the risetime is generally measured between **10%** and **90%** of the vertical pulse height. For peak-to-peak signal amplitude of **6 cm** height, which are symmetrically adjusted to the horizontal center line, the internal graticule of the CRT has two horizontal dotted lines $\pm 2.4 \text{ cm}$ from the center line. Adjust the Y attenuator switch with its variable control together with the **Y-POS.** control so that the pulse height is precisely aligned with the 0 and 100% lines. The 10% and 90% points of the signal will now coincide with the two lines, which have a distance of $\pm 2.4 \text{ cm}$ from the horizontal center line and an additional subdivision of 0.2 cm . **The risetime is given by the product of the horizontal distance in cm between these two coincidence points and the time coefficient setting.**

If magnification is used, this product must be divided by 10. The **fall time** of a pulse can also be measured by using this method.

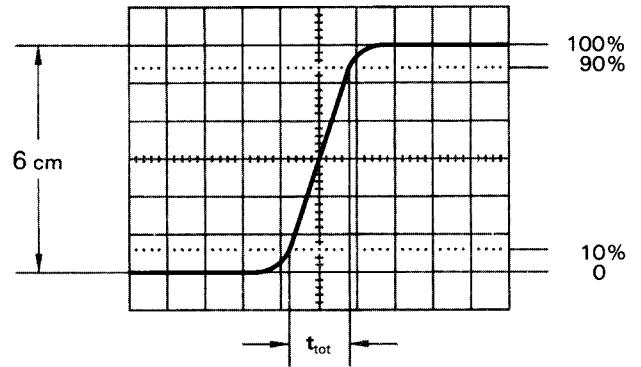

The above figure shows correct positioning of the oscilloscope trace for accurate risetime measurement.

With a time coefficient of **0.05 $\mu\text{s/cm}$** and pushed **X MAG x10** button the example shown in the above figure results in a measured total risetime of

$$t_{tot} = 1.6 \text{ cm} \cdot 0.05 \text{ } \mu\text{s/cm} : 10 = 8 \text{ ns}$$

When very fast risetimes are being measured, the risetimes of the oscilloscope amplifier and the attenuator probe have to be deducted from the measured time value. The risetime of the signal can be calculated using the following formula.

$$t_r = \sqrt{t_{tot}^2 - t_{osc}^2 - t_p^2}$$

In this t_{tot} is the total measured risetime, t_{osc} is the risetime of the oscilloscope amplifier (approx. 5.8 ns), and t_p the risetime of the probe (e.g. = 2 ns). If t_{tot} is greater than 42 ns, then t_{tot} can be taken as the risetime of the pulse, and calculation is unnecessary.

Calculation of the example in the figure above results in a signal risetime

$$t_r = \sqrt{8^2 - 5.8^2 - 2^2} = 5.1 \text{ ns}$$

Connection of Test Signal

Caution: When connecting unknown signals to the oscilloscope input, always use automatic triggering and set the **DC-AC** input coupling switch to **AC**. The attenuator switch should initially be set to **20 V/cm**.

Sometimes the trace will disappear after an input signal has been applied. The attenuator switch must then be turned back to the left, until the vertical signal height is only 3-8 cm. With a signal amplitude greater than 160 V_{pp}, an attenuator probe must be inserted before the oscilloscope's vertical input. If, after applying the signal, the trace is nearly blanked, the period of the signal is probably substantially

longer than the set value on the **TIME/DIV.** switch. It should be turned to the left to an adequately greater time coefficient.

The signal to be displayed should be fed to the vertical input of the oscilloscope by means of a shielded test cable, e.g. the HZ32 or HZ34, or by a x10 or x100 attenuator probe. The use of these shielded cables with high impedance circuits is only recommended for relatively low frequencies (up to approx. 50kHz). For higher frequencies, and when the signal source is of low impedance, a cable of matched characteristic impedance (usually 50Ω) is recommended. In addition, and especially when investigating square or pulse waveforms, a resistor equivalent to the characteristic impedance of the cable must also be connected to the cable directly at the input of the oscilloscope. When using a 50Ω cable, such as the HZ34, a 50Ω through-termination type HZ22 is available from HAMEG. When investigating square or pulse waveforms with fast risetimes, transient phenomena on both the edge and top of the signal may become visible if the correct termination is not used. It must be remembered that the 50Ω through-termination will only dissipate a maximum of 2 watts. This power consumption is reached with 10V_{rms} or with 28V_{pp} sine signal.

If a x10 or x100 attenuator probe is used, no termination is necessary. In this case, the connecting cable is matched directly to the high impedance input of the oscilloscope. When using attenuator probes even high internal impedance sources are only slightly loaded by approximately 10MΩ||16pF or 100MΩ||7pF respectively. Therefore, when the voltage loss due to the attenuation of the probe can be compensated by a higher sensitivity setting on the HM604, the probe should always be used. Also it should be remembered that the series impedance of the probe provides a certain amount of protection for the input of the oscilloscope amplifier. It should be noted that all attenuator probes must be compensated in conjunction with the oscilloscope (see: Probe Adjustment, page M8).

If a x10 or x100 attenuator probe is used at voltages higher than 400V, the DC input coupling must always be set. With **AC** coupling, the attenuation is frequency-dependent, the pulses displayed can exhibit ramp-off, DC-voltage contents are suppressed – but loads the respective input coupling capacitor of the oscilloscope. The electric strength of which is maximum 400V (DC + peak AC). For the suppression of unwanted DC voltages, a **capacitor** of adequate capacitance and electric strength **may be connected before the input tip of the probe** (e.g. for ripple measurements).

It is important to remember that when low voltage signals are being investigated the position of the ground point on the test circuit can be critical. This ground point should always be located as close as possible to the measuring point. If this is not done, serious signal deformation may

result from any spurious currents through the ground leads or test chassis parts. This comment also applies to the ground leads on attenuator probes which ideally should be as short and as thick as possible. For connection of a probe to a BNC socket, a BNC-adaptor should be used. It forms often a part of the probe accessory. Grounding and matching problems are then eliminated.

Hum or interference voltage appearing in the measuring circuit (especially with a small deflection coefficient) is possibly caused by multiple grounding, because equalizing currents can flow in the shielding of the measuring cables (voltage drop between non-fused earthed conductors of other line powered devices, which are connected to the oscilloscope or test object, e.g. signal generators with anti-interference capacitors).

Operating

For a better understanding of these Operating Instructions the front panel picture at the end of these instructions can be unfolded for reference alongside the text.

The front panel is subdivided into three sections according to the various functions. The **INTENS.**, **FOCUS** and **TR** (trace rotation) controls are arranged on the left directly below the screen of the cathode-ray tube (CRT). Continuing towards the right are the horizontal magnification button (**X MAG. x10**), the switch for calibrator frequency selection (**1kHz/1MHz**) and calibrator output sockets 0.2V/2V (**CAL.**). The **COMPONENT TESTER** pushbutton and its measuring socket are located on the right side.

The X-Section, located on the upper right, next to the screen, contains the red **POWER** pushbutton and indicating LED, all controls for timebase (**TIME/DIV.**), triggering (**TRIG.**), horizontal trace position (**X-POS.**), sweep delay (**DELAY**), TV separator (**TV SEP.**) together with the field select button (**FIELD I/II**), the XYmode button (**XY**), and the knob for holdoff adjustment (**HOLD OFF**).

The lower Y-Section contains the controls for the vertical deflection system. On the right and left in this section are located: vertical input connector, **DC-AC-GD** input coupling slide switch, **Y-POS.** control, **INVERT** pushbutton, attenuator switch with variable control, and ground jack. All these controls and connectors exist in duplicate for each of the Channels I and II. Three pushbuttons for selecting the operating mode are arranged below the attenuator switches: **CHI/II-TRIGI/II**, **DUAL** and **ADD**.

These are explained later.

The instrument is so designed that even incorrect operation will not cause serious damage. The pushbuttons control only minor functions, and it is recommended that before commencement of operation all pushbuttons are in the “out” position. After this the pushbuttons can be operated depending upon the mode of operation required.

The HM604 accepts all signals from DC (direct voltage) up to a frequency of at least 60MHz (−3dB). For sinewave voltages the upper frequency limit will be 80MHz. However, in this higher frequency range the vertical display height on the screen is limited to approx. 6cm. The time resolution poses no problem. For example, with 100MHz and the fastest adjustable sweep rate (5ns/cm), one cycle will be displayed every 2cm. The tolerance on indicated values amounts to $\pm 3\%$ in both deflection directions. All values to be measured can therefore be determined relatively accurately. However, from approximately 25MHz upwards the measuring error will increase as a result of loss of gain. At 40MHz this reduction is about 10%. Thus, approximately 11% should be added to the measured voltage at this frequency. As the bandwidth of the amplifiers differ (normally between 65 and 70MHz), the measured values in the upper limit range cannot be defined exactly. Additionally, as already mentioned, for frequencies above 60MHz the dynamic range of the display height steadily decreases. The vertical amplifier is designed so that the transmission performance is not affected by its own overshoot.

First Time Operation

Check that the instrument is set to the correct mains/line voltage. (Refer to page M2).

Before applying power to the oscilloscope it is recommended that the following simple procedures are performed:

- Check that all pushbuttons are in the **out** position, i.e. released.
- Rotate the three variable controls with arrows to their calibrated detent.
- Set the variable controls with marker lines to their mid-range position (marker lines pointing vertically).
- The **LEVEL** control knob should be on its left stop (**AT**).
- The three lever switches in the X-Section should be set to their uppermost position.
- Both input coupling slide switches for **CH.I** and **CH.II** in the Y-Section should be set to the **GD** position.

Switch on the oscilloscope by depressing the red **POWER** pushbutton. An LED will illuminate to indicate working order. The trace, displaying one baseline, should be visible after a short warm-up period of 10 seconds. Adjust **Y-POS.I** and **X-POS.** controls to center the baseline. Adjust **INTENS.** (intensity) and **FOCUS** controls for medium brightness and optimum sharpness of the trace. The oscilloscope is now ready for use.

If only a spot appears (**CAUTION!** CRT phosphor can be damaged.), reduce the intensity immediately and check that the **X-Y** pushbutton is in the released (out) position. If the trace is not visible, check the correct positions of all knobs and switches (particularly **LEVEL** knob in **AT** position and **DELAY MODE** lever switch to **OFF**).

To obtain the maximum life from the cathode-ray tube, the minimum intensity setting necessary for the measurement in hand and the ambient light conditions should be used. **Particular care is required when a single spot is displayed**, as a very high intensity setting may cause damage to the fluorescent screen of the CRT. Switching the oscilloscope off and on at short intervals stresses the cathode of the CRT and should therefore be avoided.

Trace Rotation TR

In spite of Mumetal-shielding of the CRT, effects of the earth's magnetic field on the horizontal trace position cannot be completely avoided. This is dependent upon the orientation of the oscilloscope on the place of work. A centred trace may not align exactly with the horizontal center line of the graticule. A few degrees of misalignment can be corrected by a potentiometer accessible through an opening on the front panel marked TR.

DC Balance Adjustment

The vertical preamplifiers for **CH.I** and **CH.II** contain matched dual FETs connected as input source followers. After long periods of use the FET characteristics may change which can alter the DC balance of the vertical amplifier. A quick check of DC Balance can be made on each channel by pulling the fine amplitude control **MAG x5** and pushing it back. If the trace moves from the vertical position (up or down) more than 1 mm, the DC Balance will require readjustment. This check should be made after a 20-minute warm-up period.

Adjustment procedure

The following instructions should be performed to obtain the correct DC balance adjustment of both channels.

- Remove all input cables and adjust oscilloscope controls to display the baseline.
- Center the baseline using **Y-POS.** and **X-POS.** controls.
- Set attenuator switches to **5mV/cm** and input coupling switches to **GD**.
- Release all pushbuttons in the Y-Section.
- Place the oscilloscope so that it rests firmly on its back (upright position) and locate DC balance adjustment potentiometer access holes – marked **CH.I DC-BALANCE CH.II** – which are found underneath the instrument.
- Insert a screwdriver (blade approx. 3mm, length min. 20mm) in **CH.I** hole. A plastic guide with slotted bottom is located behind the hole.
- Pull and push the CH.I variable control **MAG x5** and adjust balance pot so that the baseline no longer moves up or down. When the trace remains steady, correction of **CH.I** is completed.
- Depress **CH.II-TRIG.I/II** button. Repeat adjustment procedure for **CH.II**.

Use and Compensation of Probes

To display an undistorted waveform on an oscilloscope, the probe must be matched to the individual input impedance of the vertical amplifier.

The HM604's built-in calibration generator provides a squarewave signal with a very low risetime (<5ns), and switch-selectable frequencies of approx. 1 kHz and 1 MHz at two output sockets below the CRT screen. One output provides $0.2V_{pp} \pm 1\%$ for 10:1 probes, and $2V_{pp} \pm 1\%$ are present at the other, for 100:1 probes.

When the attenuator switches are set to **5mV/cm** vertical deflection coefficient, these calibration voltages correspond to a screen amplitude of **4cm**.

The output sockets have an internal diameter of 4.9mm to accommodate the internationally accepted shielding tube diameter of modern **Modular Probes** and **F-series** slimline probes. Only this type of construction ensures the extremely short ground connections which are essential for an undistorted waveform reproduction of non-sinusoidal high frequency signals.

Adjustment at 1 kHz

The C-trimmer adjustment compensates the capacitive loading on the oscilloscope input (approx. 30pF with the HM604). By this adjustment, the capacitive division assumes the same division ratio as the ohmic voltage divider to ensure an equal division ratio for high and low frequencies, as for DC. (For 1:1 probes or switchable probes set to 1:1, this adjustment is neither required nor possible). A baseline exactly parallel to the horizontal graticule lines is a major condition for accurate probe adjustments. (See also 'Trace Rotation **TR**', page M7.)

Connect the probes (Types HZ51, 52, 53, 54, or HZ37) to **CH.I** input. All pushbuttons should be released (in the 'out' position), and all push-pull knobs pushed 'in'. Set the input coupling switch to **DC**, the attenuator switch to **5mV/cm**, and the **TIME/DIV.** switch to **0.2ms/cm**, and all variable controls to **CAL.** position. Plug the probe tip into the appropriate calibrator output socket, i.e. 10:1 probes into the **0.2V** socket, 100:1 probes into the **2.0V** socket.

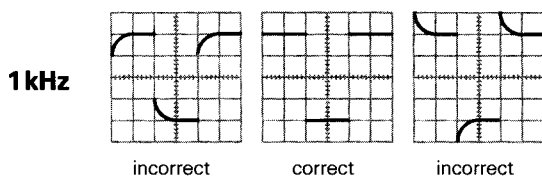

Approximately 2 complete waveform periods are displayed on the CRT screen. Now the compensation trimmer has to be adjusted. Normally, this trimmer is located in the probe head. On the 100:1 probe HZ53, however, it is located in the connecting box at the other end of the cable. Using a

small insulated non-metallic screwdriver or trimming tool, the trimmer has to be adjusted slowly until the tops of the squarewave signal are exactly parallel to the horizontal graticule lines. (See Fig. above for 1 kHz.) The signal amplitude shown should be $4cm \pm 1.2mm (= 3\%)$. During this adjustment, the signal edges will remain invisible.

Adjustment at 1 MHz

Probes HZ51, 52, and 54 will also allow for HF-adjustments. They incorporate resonance deemphasizing networks (R-trimmer in conjunction with inductances and capacitors) which permit – for the first time – probe compensation in the range of the upper frequency limit of the vertical oscilloscope amplifier. Only this compensative adjustment ensures optimum utilisation of the full bandwidth, together with constant group delay at the high frequency end, thereby reducing characteristic transient distortion near the leading signal edge (e.g. overshoot, rounding, ringing, holes or bumps) to an absolute minimum.

Using the probes HZ51, 52, and 54, the full bandwidth of the HM604 can be utilized without risk of unwanted waveform distortion.

Prerequisite for this HF-adjustment is a squarewave generator with fast risetime (typical 4ns), and low output impedance (approx. 50Ω), providing 0.2V and 2V at a frequency of approx. 1MHz. The calibrator output of the HM604 meets these requirements when the pushbutton 1 MHz is depressed.

Connect the probe (HZ51, 52, or 54) to **CH.I** input. Depress the calibrator pushbutton **1MHz**. All other pushbuttons should be released ('out' position). Set the input coupling switch to **DC**, attenuator switch to **5mV/cm**, and **TIME/DIV.** switch to **0.1µs/cm**. Set all variable controls to **CAL.** position.

Insert the probe tip into the output socket marked **0.2V**. A waveform will be displayed on the CRT screen, with leading and trailing edges clearly visible. For the HF-adjustment now to be performed, it will be necessary to observe the rising edge as well as the upper left corner of the pulse top. To gain access to the HF-compensation trimmer, the plastic cover of the probe connecting box has to be slid off after unscrewing the probe cable. The connecting boxes of the HZ51 and HZ54 contain one R-trimmer screw, each, while that of the HZ52 provides three. These R-trimmers have to be adjusted in such a manner that the beginning of the pulse top is as straight as possible. Overshoot or excessive rounding are unacceptable. This is relatively easy on the HZ51 and HZ54, but slightly more difficult on the HZ52. The rising edge should be as steep as possible, with the pulse top remaining as straight and horizontal as possible.

On the HZ52, each of the three trimmers has a clearly

defined area of influence on the waveform shape (see Fig.), offering the added advantage of being able to 'straighten out' waveform aberrations near the leading edge.

Adjustment points of the probes

HZ51, HZ54

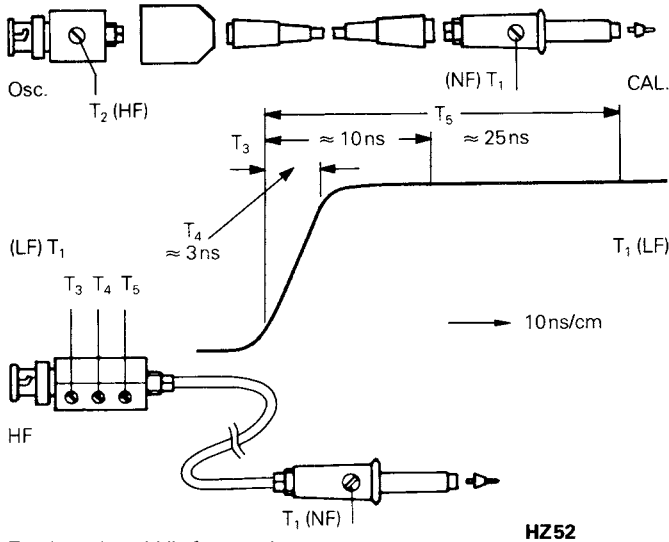

T₃: alters the middle frequencies
 T₄: alters the leading edge
 T₅: alters the lower frequencies

After completion of the HF-adjustment, the signal amplitude displayed on the CRT screen should have the same value as during the 1 kHz adjustment.

Probes other than those mentioned above, normally have a larger tip diameter and may not fit into the calibrator outputs. Whilst it is not difficult for an experienced operator to build a suitable adapter, it should be pointed out that most of these probes have a slower risetime with the effect that the total bandwidth of scope together with probe may fall far below that of the HM604. Furthermore, the HF-adjustment feature is nearly always missing so that waveform distortion can not be entirely excluded.

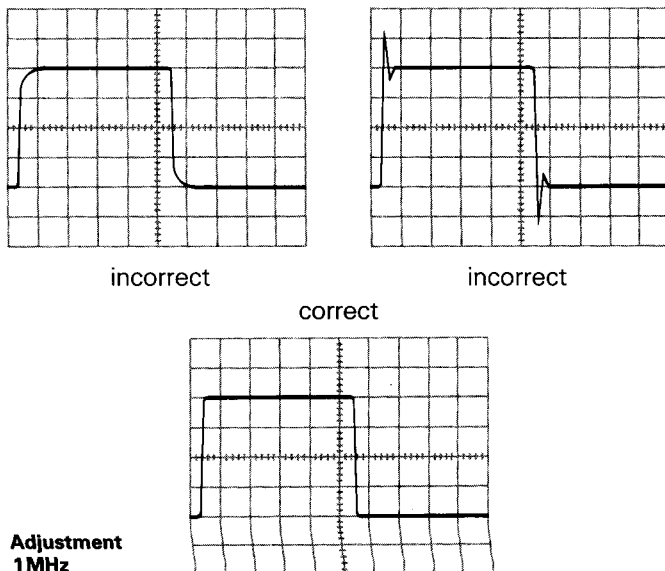

Adjustment
 1 MHz

The adjustment sequence must be followed in the order described, i.e. first at 1 kHz, then at 1 MHz. The calibrator frequencies should not be used for timebase calibrations. The pulse duty cycle deviates from 1:1 ratio.

Prerequisites for precise and easy probe adjustments, as well as checks of deflection coefficients, are straight horizontal pulse tops, calibrated pulse amplitude, and zero-potential at the pulse base. Frequency and duty cycle are relatively uncritical. For interpretations of transient response, fast pulse risetimes and low-impedance generator outputs are of particular importance.

Providing these essential features, as well as switch-selectable output-frequencies, the calibrator of the HM604 can, under certain conditions, replace expensive squarewave generators when testing or compensating wideband-attenuators or -amplifiers. In such a case, the input of an appropriate circuit will be connected to one of the **CAL.**-outputs via a suitable probe.

The voltage provided at a high-impedance input (1 MΩ || 15-50 pF) will correspond to the division ratio of the probe used (10:1 = 20 mV_{pp}, 100:1 = also 20 mV_{pp} from 2V output). Suitable probes are HZ51, 52, 53, and 54.

For low-impedance inputs (e.g. 50 Ω), a 1:1 probe can be employed which, however, must be fully terminated with a 50 Ω through-termination. Suitable probe types are HZ50 and HZ54. The latter must be switched to the 1:1 position, and the HF-trimmer in the connecting box turned fully counterclockwise.

When connected to the **0.2V CAL.** socket, and using the HZ50, this arrangement will provide approx. 40 mV_{pp} at 50 Ω circuit input, and approx. 24 mV_{pp} if the HZ54 is used.

The voltages given here will have larger tolerances than 1 % since operation of a 1:1 probe together with a 50 Ω load is very uncommon.

Using the **2V CAL.** socket under similar conditions is only possible with the **HZ54** probe. The potential obtained at the 50 Ω input will then be approx. 190 mV_{pp}, but with almost twice the risetime. Accurate readings of the available input voltage can be shown directly on the HM604 when connecting a 50 Ω through-termination between the BNC plug of the probe and the input of the oscilloscope.

Operating Modes of the Y Amplifier

The required operating modes are selected on three pushbuttons located in the Y-Section. For **Mono** operation all pushbuttons should be in the out position, the instrument is then operating on **Channel 1** only.

For **Mono** operation with **Channel II**, the **CH I/II - TRIG. I/II** pushbutton has to be pressed. When the **DUAL** button is depressed, the HM 604 is in **Dual** channel operation. In this mode, the channels are displayed consecutively (alternate mode). This mode is not suitable for the display of very low frequency signals (<1 kHz), as the trace will appear to flicker or jump. Under these conditions, the **ADD** button should be depressed additionally selecting chopped mode. In this position, both channels then share the trace during each sweep period. For the display of high frequency signals, the type of channel switching selected is less important.

To select the **add mode** only the **ADD** button should be depressed. The signals on both channels are then added together. If in this mode one channel is **inverted** (pushbutton **INVERT** depressed), then the **difference** between the two channels is displayed. For both of these operating modes, the vertical position of the trace depends on the setting of the **Y-POS.** controls of **both** channels.

Differential measurements techniques allow direct measurement of the voltage drop across floating components (both ends above ground). Two identical probes should be used for both vertical inputs. Using a separate ground connection and **not** connecting the probe or cable shields to the circuit under test avoid ground loops (hum, common-mode disturbances).

X-Y Operation

For **X-Y operation**, the pushbutton in the X-Section marked **X-Y** must be depressed. The X signal is then derived from the **Channel II (HOR. INP.)**. **The calibration of the X signal during X-Y operation is determined by the setting of the Channel II input attenuator and variable control.** This means that the sensitivity ranges and input impedances are identical for both the X and Y axes. However, the **Y-POS.II** control is disconnected in this mode. Its function is taken over by the **X-POS.** control. It is important to note that the **X MAG. x10** facility, normally used for expanding the sweep, should not be operated in the X-Y mode. It should also be noted that the bandwidth of the X amplifier is approximately 5 MHz (-3 dB), and therefore an increase in phase difference between both axes is noticeable from 50 kHz upwards.

The Y-Input signal may be inverted by using the **INVERT** (channel I) facility.

X-Y Phase Measurements

The X-Y phase measurement method can be used to measure the phase difference between two signals of the same frequency. This provides a method of measurement for sig-

nal frequencies up to 120 kHz. However, above this frequency the inherent phase difference between the vertical and horizontal system makes accurate measurements difficult. In this mode, one of the sinewave signals provides horizontal deflection (X) while the other signal provides the vertical deflection (Y).

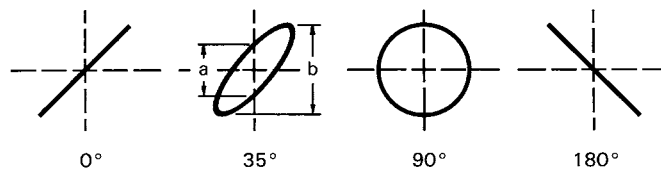

The phase angle between the two signals can be determined from the Lissajous pattern as follows:

$$\sin \varphi = \frac{a}{b}$$

$$\cos \varphi = \sqrt{1 - \left(\frac{a}{b}\right)^2}$$

$$\varphi = \arcsin \frac{a}{b}$$

This simple formula works for angles less than 90°, it is **independent** from both deflection amplitudes on the screen.

Caution!

If a single spot appears (both deflection voltages are missing) reduce the intensity immediately, as a high intensity setting may cause damage to the fluorescent screen of the CRT.

Dual-Trace Phase Difference Measurements

Phase comparison between two signals of the same frequency can be made using the dual-trace feature (**DUAL** button depressed). This method of phase difference measurement can be used up to the frequency limit of the vertical system. To make the comparison, use the following procedure:

Set the Input Coupling switches to the same position, and the **CH. I/II - TRIG. I/II** pushbutton to the channel where the reference signal (Phase 0°) is connected. Select **ALT.** channel switching for frequencies above 1 kHz, and **CHOP.** for frequencies below 1 kHz. Use probes which have equal time delay to connect the signals to the input connectors. Set the Input Attenuator switches and the CH I and CH II variable controls so that the displays are approximately equal and about five divisions in amplitude. Set the **TIME/DIV.** switch to a sweep rate which displays about one cycle of the waveform. Move the waveforms to the center of the graticule with the **Y-POS.I** and **Y-POS.II** controls.

Turn the Variable Time Control until one cycle of the reference signal occupies exactly 10 divisions (see next figure). Each division represents 36° of the cycle.

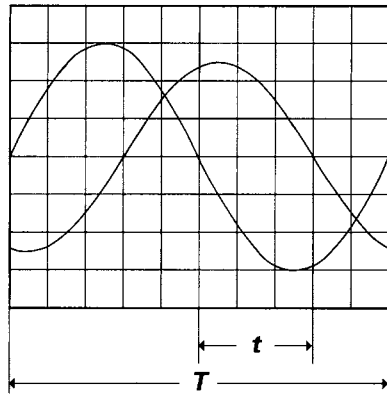

Dual-Trace Phase Difference Measurements

T = Horizontal distance **for one period** (cm).

t = Horizontal distance of zero-crossing points (cm).

Assume a horizontal difference of 3 divisions (**t** = 3 cm) and a period of 10 divisions (**T** = 10 cm), the phase difference φ can be calculated using the following formula:

$$\text{or } \varphi^\circ = \frac{t}{T} \cdot 360^\circ = \frac{3}{10} \cdot 360^\circ = 108^\circ$$

$$\text{arc } \varphi = \frac{t}{T} \cdot 2\pi = \frac{3}{10} \cdot 2\pi = 1.885 \text{ rad}$$

respectively.

Measurement of an amplitude modulation

The momentary amplitude **u** at time **t** of a HF-carrier voltage, which is amplitude modulated without distortion by a sinusoidal AF voltage, is in accordance with the equation

$$u = U_T \cdot \sin \Omega t + 0,5m \cdot U_T \cdot \cos(\Omega - \omega)t - 0,5m \cdot U_T \cdot \cos(\Omega + \omega)t$$

where **U_T** = unmodulated carrier amplitude

Ω = $2\pi F$ = angular carrier frequency

ω = $2\pi f$ = modulation angular frequency

m = modulation factor ($\leq 1 \triangleq 100\%$).

The lower side frequency **$F-f$** and the upper side frequency **$F+f$** arise because of the modulation apart from the carrier frequency **F**.

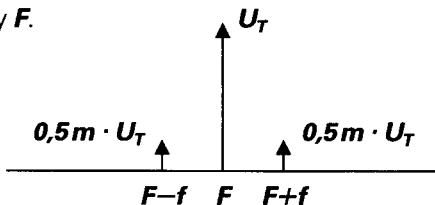

Figure 1
Amplitude and frequency spectrum for AM display ($m = 50\%$)

The display of the amplitude-modulated HF oscillation can be evaluated with the oscilloscope provided the frequency spectrum is inside the oscilloscope bandwidth. The time base is set so that several cycles of the modulation frequency are visible. Strictly speaking, triggering should be external with modulation frequency (from the AF generator or a demodulator). However, internal triggering is frequently possible with normal triggering using a suitable **LEVEL** setting and possibly also using the time variable adjustment.

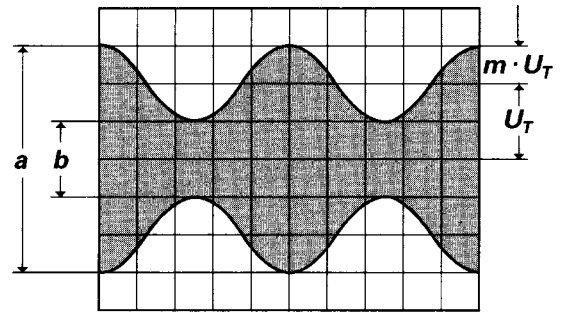

Figure 2
Amplitude modulated oscillation: **F** = 1 MHz; **f** = 1 kHz;
m = 50 %; **U_T** = 28.3 mV_{rms}.

Oscilloscope setting for a signal according to figure 2:

Depress no buttons. **Y: CH. I; 20mV/div; AC.**

TIME/DIV.: 0.2ms/div.

Triggering: **NORMAL** with **LEVEL**-setting; **internal (or external) triggering.**

If the two values **a** and **b** are read from the screen, the modulation factor is calculated from

$$m = \frac{a - b}{a + b} \text{ resp. } m = \frac{a - b}{a + b} \cdot 100 [\%]$$

where **a** = $U_T(1+m)$ and **b** = $U_T(1-m)$.

The variable controls for amplitude and time can be set arbitrarily in the modulation factor measurement. Their position does not influence the result.

Triggering and Timebase

With the **LEVEL** knob in locked position (turned ccw to **AT** position = automatic triggering), a baseline is displayed continuously even when no signal is present. In this position it is possible to obtain stable displays of virtually all uncomplicated, periodically repeating signals above 30Hz. Adjustments of the timebase then are limited to timebase setting.

With normal triggering (**LEVEL** knob not in **AT** position) and **LEVEL** adjustment, triggering of time/div. deflection can be set in any point of a given signal. The triggering range which can be set with the **LEVEL** control depends greatly on the amplitude of the displayed signal. If it is less than 1 div, then the range is quite small and performance of settings requires a delicate touch.

If the **LEVEL** control is incorrectly set, no trace will be visible.

In order to obtain a satisfactory stable display, the timebase must be triggered synchronously with the test signal. The trigger signal can be derived from the test signal itself, when internal triggering is selected, or from a frequency related signal applied to the external trigger input.

Triggering can be selected on either the rising or falling edge of the trigger signal depending on whether the **SLOPE +/–** pushbutton (next to **LEVEL**) is in the out or in position. In the out position, triggering from the positive-going edge is selected. The correct slope setting is important in obtaining a display when only a portion of a cycle is being displayed.

With **internal triggering** in the **Mono channel mode** on the Y amplifier, the trigger signal is derived from the respective channel in use. In the **Dual channel mode**, the internal trigger signal may be selected from either **Channel I** or **Channel II** using the **CH I/II-TRIG. I/II** button; in the out position, the trigger signal is derived from Channel I. However, it is always preferable to trigger from the less complicated signal.

With **internal alternate triggering** (**ALT** pushbutton in the X-Section depressed) in the **DUAL** channel alternate mode of the Y amplifier, the trigger voltage is derived **alternately from Channel I and Channel II**. This trigger mode is particularly useful when **two asynchronous signals** are being investigated. Normal triggering should be preferable in this mode. The display of one signal only is not possible on the alternate trigger mode.

For **external triggering**, the **EXT.** pushbutton in the X-Section must be depressed. The sync. signal ($0.05 V_{pp}$ – $0.5 V_{pp}$) must then be fed to the **TRIG. INP.** input socket.

Coupling mode and frequency range of the trigger signal are selected with the **TRIG.** lever switch in the X-Section for internal and external triggering, provided that the **TV SEP.** switch is in off position. The HM 604 has 4 coupling modes: **AC, DC, LF, HF**. The **AC** coupling mode is mainly used. **DC** trigger coupling is only recommended, when very low frequency signals are being investigated and triggering at a particular value is necessary, or when pulses, which significantly change in duty cycle during observation time, have to be displayed. If **DC** coupling is selected, it is advisable to use the **normal triggering** mode. In the **HF** coupling mode, a **high pass filter** is switched into the trigger amplifier. This filter cuts off the DC content of the trigger signal and the lower frequency range.

In the **LF** coupling mode, a **low-pass filter** is switched into the trigger amplifier. This filter cuts off any amplifier noise and the frequency range of the trigger signal above 50 kHz.

For the purpose of **line triggering** (**TRIG.** lever switch in the X-Section) to \sim , a (divided) secondary voltage of the power transformer is used as a trigger signal. This trigger mode is independent of the signal amplitude or display height and allows a display below the (internal) trigger threshold. Line triggering is recommended for all signals which are time-related (multiple or submultiple) to the mains/line frequency or when it is desirable to provide a stable display of a line-

frequency component in complex waveforms. Therefore it is especially suited for the measurement of small ripple voltages from power supply rectifiers or of magnetic or static leakage fields in a circuit.

In some countries, the standard power plug has symmetrically arranged plugs (interchanging of **Line** and **Neutral** is possible). In such cases, the **SLOPE +/–** pushbutton may indicate the wrong polarity compared with the display (triggering with falling edge instead of rising edge). For correction, the power plug of the instrument has to be turned.

Triggering of video signals

The built-in active **TV-Sync-Separator** separates the sync pulses from the video signal, permitting the display of distorted video signals either in line (**H** = horizontal) or in frame (**V** = vertical) trigger mode. The **TV** lever switch has five positions: the **OFF** position is for normal operation.

The **TV: H+** and **H–** positions (horizontal = line) and the **TV: V+** and **V–** (vertical = frame) positions are used for video triggering. In these four positions the **TRIG.** coupling switch and the **LEVEL** control (in **NORM.** trigger mode) are inoperative. In the **TV: V+** and **V–** positions (frame triggering), a low-pass filter or integrating network is connected into circuit, which forms a trigger pulse sequence with frame frequency from the vertical sync pulses (incl. pre- and postequalizing pulses).

When in **V** mode, it is possible to select field I or II by releasing or depressing **FIELD I/II** pushbutton.

For correct video triggering, the **+** and **–** positions at **V** and **H** must be selected corresponding to the video input signal. If the sync pulses are placed above the picture content, **H+** or **V+** should be in use. For sync pulses below the picture content of the input signal, correct triggering, without any influence from changing picture contents, will be possible only in **V–** or **H–** setting. The **INVERT** pushbutton only changes the display on the CRT, not the input signal.

In **TV: H** trigger mode, the trigger point lies on the starting edge of a sync pulse if **SLOPE** button is in **+** position. As mentioned before, in **TV: V** mode an integrating network is additionally added to the sync separator which delays the formed trigger pulse by about 50 μ s.

Video signals are triggered in the automatic mode. Therefore the adjustment of the trigger point is superfluous. The internal triggering is virtually independent of the display height, which may differ from 0.8 to 8 div. As opposed to **AT** mode, when in **normal** mode, the screen is blanked without signal at the input (turning the **LEVEL** knob is ineffectual).

Function of var. HOLD-OFF control

If it is found that a trigger point cannot be located on extremely complex signals even after repeated and careful adjustment of the **LEVEL** control in the **Normal Triggering** mode, a stable display may be obtained using the **HOLD-OFF** control (in the X-Section). This facility varies the hold-off time between two sweep periods up to the ratio $>5:1$. Pulses or other signal waveforms appearing during this off period cannot trigger the timebase. Particularly with burst signals or aperiodic pulse trains of the same amplitude, the start of the sweep can be shifted to the optimum or required moment. After specific use the **HOLD-OFF** control should be re-set into its calibration detent **min.**, otherwise the brightness of the display is reduced drastically.

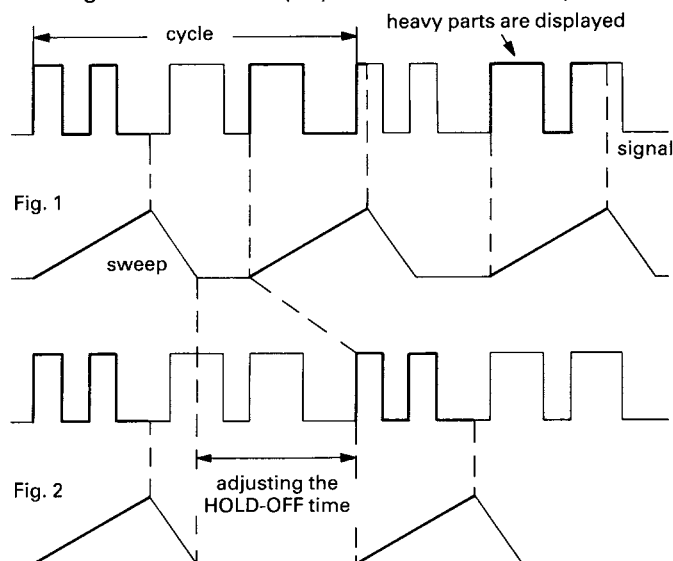

Fig. 1 shows a case where the **HOLD-OFF** knob is in the **X1** position and various different waveforms are overlapped on the screen, making the signal observation unsuccessful.
Fig. 2 shows a case where only the desired parts of the signal are stably displayed.

Sweep Delay / After Delay Triggering

With the sweep delay, the start of the sweep can be delayed from the trigger point by a selectable time (100 ns to maximum 1 s). It is therefore possible to start the sweep at practically any point of a waveform. The interval, which follows the start of the sweep, can be greatly expanded by the increase of the sweep speed. From the **5 μ s/cm TIME/DIV.** range downwards to slower sweep speeds, an expansion of at least 100 times, and with the aid of the **X MAG. x10** expansion of 1000 times, is possible. With time coefficients higher than **5 μ s/cm**, the maximum expansion increases proportionally. However, with increasing the expansion, the display brightness decreases. Under very high ambient light conditions a Viewing Hood like HZ47 can overcome this problem. It should be noted that there are some difficulties with higher expansions, if the test signal has inherent jitter. To reduce or eliminate this jitter, expanded parts of a signal can be triggered again "after delay" provided there is another suitable edge (**DEL. TRIG.**).

In **DEL. TRIG.** mode *and* **TV SEP.** switch in **H** or **V** position, after delay triggering to the next following line is possible. Therefore discrete lines are representable. The slope is appointed by the **TV+** or **TV-** position of the delay switch.

Operation of the sweep delay is relatively easy, as normally only 3 controls in the X-Section need to be used: the **DELAY** operating mode lever switch (**OFF-SEARCH-DELAY-DEL. TRIG.**), the **DELAY** rotary switch (delay time range), and its variable control **VAR. 10:1** (small knob on the **DELAY** switch). The latter, a twenty-turn precision potentiometer with overwind protection, can increase the delay time range tenfold. An LED near the **DELAY** mode switch indicates the operating mode.

For reliable operation of the sweep delay, it is recommended that the following procedure should always be adopted; also reference to the accompanying figures will be of assistance.

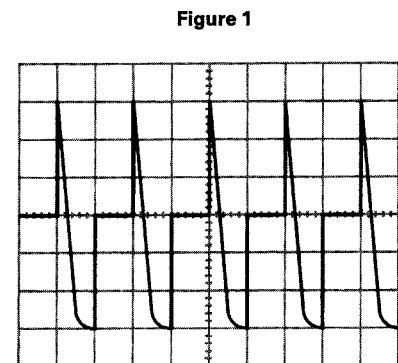

MODE : **NORM.**
TIME/DIV. : **0.5 ms/cm**
LED : off

Initially, the sweep delay mode lever switch should be set in the **OFF** position. In this mode, the complete waveform under investigation will be displayed as for normal oscilloscope operation. The mode indicator LED is not illuminated in **OFF** mode. The time coefficient on the **TIME/DIV.** switch is selected so that **1 to 3 basic periods of the signal** are displayed. A larger number unnecessarily decreases the brightness and maximum expansion. The display of only a portion of a period limits the choice of the expanded time interval and possibly complicates the triggering. On the other hand, the range of 1 to 3 basic periods can always be set unconstrainedly with the **TIME/DIV.** switch. In doing so, the **x10 expansion must be switched off temporarily (X MAG. x10** button is in out position). In the X-Section, the **HOLD-OFF** control should be set to **min.** and the variable control to **CAL.** The **LEVEL** control is adjusted so that stable triggering is ensured (**TRIG.** LED is illuminated).

The mode switch should now be set to the **SEARCH** position; it will be seen that the start of the display will shift to the right. The amount of shift indicates the exact delay time.

If a display is not obtained in this mode, then a lower delay time range should be selected. For example, when investigating the waveform shown in the figures, a display could not be obtained with a delay time setting of **10ms**, as the display is completely blanked. However, as a result of setting the **DELAY** rotary switch to **0.1μs**, the shifting is not visible. The **DELAY** range switch should then be rotated clockwise until the display starts just prior to the short time interval to be investigated. The precise adjustment to the start is done with the **VAR. 10:1** delay time control. The rotating range of the latter has no stop. On the range limits a certain snapping noise is audible. Initially, this control should be set in the left start position. In the **SEARCH** mode, the LED indicator will flash.

Figure 2

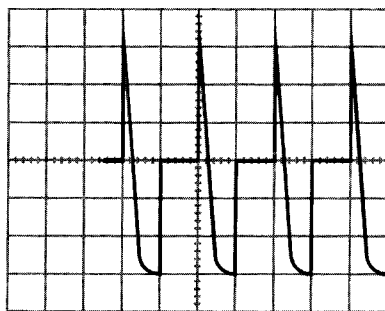

MODE : **SEARCH**
 DELAY range : **1 ms**
 TIME/DIV. : **0.5ms/cm**
 LED : flashing

$$\text{Delay time} = 2.5 \text{ cm} \cdot 0.5 \text{ ms/cm} = 1.25 \text{ ms}$$

In figure 2 it can be seen that the delay time is also measurable as the blanked portion or apparent shift of the start of the trace. This time can be determined by multiplication of (the horizontal shifting in cm) by (the time coefficient set on the **TIME/DIV.** switch).

Now the mode switch can be set to **DELAY**. In this mode, the LED is permanently illuminated. The display will now shift to the left and the trace will commence in the same position as for a normal display; however, the short time interval under investigation now starts on the first or left vertical graticule line.

Figure 3

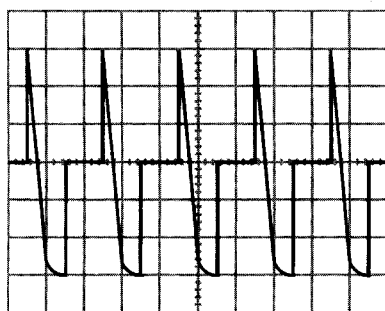

MODE : **DELAY**
 DELAY range : **1 ms**
 TIME/DIV. : **0.5ms/cm**
 LED : illuminated

If the timebase sweep speed is increased (rotate **TIME/DIV.** switch clockwise), then the short time interval will be expanded. It may be found that, as the amount of expansion is increased, the trace will tend to shift. If this happens, the **VAR.** delay time control can be readjusted — also subsequently at any time — to enable the exact point of interest to be displayed.

In the example shown in figure 4, it can be seen that an expansion of **x10** was obtained by increasing the timebase sweep speed **from 0.5ms/cm to 50μs/cm**. Also the precise measurement for the delayed portion of the waveform is possible. In the example, this was found to be **250μs** on multiplication of the horizontal length in cm (of an optional signal section) by the time coefficient just adjusted.

Figure 4

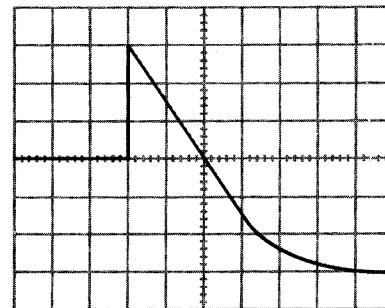

MODE : **DELAY**
 DELAY range : **1 ms**
 TIME/DIV. : **50μs/cm**
 LED : illuminated
 Expansion : $0.5 \cdot 10^{-3} : 50 \cdot 10^{-6} = 10$

$$T = 5 \text{ cm} \cdot 50 \mu\text{s/cm} = 250 \mu\text{s}$$

Operation of the sweep delay requires a constant trigger point. All signals, which have a constant phase shift between the expanded section and trigger point, pose no problems. This means all electrical signal shapes, which contain signal edges of the same polarity and with triggerable level values, which are constantly repeated with the recurring frequency.

If there is no constant phase shift, the triggering may fail after switching from the **SEARCH** to **DELAY** position or with changing of the time coefficient. It is best to attempt to find a trigger point, which has a constant phase shift up to the signal section to be expanded in the **OFF** mode. With complicated composite signals, the display of the basic period could become superimposed by other signal portions. These disappear as a rule when the sweep is increased. Otherwise, a stable expanded display is obtained by adjusting the **LEVEL** and the variable sweep control or by means of the **HOLD-OFF** control.

Using the **X MAG. x10** button, a **tenfold expansion** of the desired signal section is possible without any change of triggering or timebase. This can be of assistance with complicated or difficult-to-trigger signals.

Operation of the sweep delay needs some experience, particularly with composite signals. However, the display of sections from simple signal waveforms is easily possible. It is recommended to operate only the sequence **OFF-SEARCH-DELAY**, because otherwise location of the short time interval to be investigated will be relatively difficult. The sweep delay facility can be used in the following modes: **Mono**, **Dual**, and **Algebraic Addition** ($\pm I+II$).

Delay Mode Indication

Both operating modes of the sweep delay are indicated with an LED, located to the right of the DELAY mode lever switch. In **SEARCH** position, the LED will flash. This is an indication of the temporary operating state. The **DELAY** position is indicated by constant lighting of the LED. However, should this be noted, and normal operating mode is required then the change-over of the lever switch to its **OFF** position has been overlooked. This could cause errors in displaying a signal by complete or partial blanking. This indication, therefore, should be closely observed.

Component Tester

General

The HM604 has a built-in electronic Component Tester (abbreviated **CT**), which is used for instant display of a test pattern to indicate whether or not components are faulty. The **CT** can be used for quick checks of semiconductors (e.g. diodes and transistors), resistors, capacitors, and inductors. Certain tests can also be made to integrated circuits. All these components can be tested in and out of circuit.

The test principle is fascinatingly simple. The power transformer of the oscilloscope delivers a sine voltage, which is applied across the component under test and a built-in fixed resistor. The sine voltage across the test object is used for the horizontal deflection, and the voltage drop across the resistor (i.e. current through test object) is used for vertical deflection of the oscilloscope. The test pattern shows a current-voltage characteristic of the test object.

Since this circuit operates with mains/line frequency (50 or 60 Hz) and a voltage of 8.5 V max. (open circuit), the indicating range of the **CT** is limited. The impedance of the component under test is limited to a range from $20\ \Omega$ to $4.7\ k\Omega$. Below and above these values, the test pattern shows only short-circuit or open-circuit. For the interpretation of the displayed test pattern, these limits should always be borne in mind. However, most electronic components can normally be tested without any restriction.

Using the Component Tester

The **CT** is switched on by depressing the **COMPONENT TESTER** pushbutton. This makes the vertical preamplifier

and the timebase generator inoperative. A shortened horizontal trace will be observed. It is not necessary to disconnect scope input cables unless in-circuit measurements are to be carried out. In the **CT** mode, the only controls which can be operated are **INTENS.**, **FOCUS**, and **X-POS.**. All other controls and settings have no influence on the test operation.

For the component connection, two simple test leads with 4 mm \varnothing banana plugs, and with test prod, alligator clip or sprung hook, are required. The test leads are connected to the insulated **CT** socket and the adjacent ground socket in the Y-Section. The component can be connected to the test leads either way round.

After use, to return the oscilloscope to normal operation, release the **COMPONENT TESTER** pushbutton.

Test Procedure

Caution! Do not test any component in live circuitry – remove all grounds, power and signals connected to the component under test. Set up Component Tester as stated above. Connect test leads across component to be tested. Observe oscilloscope display.

Only discharged capacitors should be tested!

A built-in quick-acting fuse protects the **CT** and the oscilloscope against mis-operation, e.g. device under test not disconnected from mains/line supply. In that case the fuse will blow. For fuse replacement the oscilloscope has to be opened (see service instruction page S1 "Instrument Case Removal"). The fuse is located on the bottom side of the instrument (close to the CT pushbutton). Make sure that only fuses of the specified type are used for replacement: **5x20 mm, quick-acting, 250 V, C, 50 mA** (IEC 127/II or DIN 41661).

Test Pattern Displays

Page M18 shows typical test patterns displayed by the various components under test.

- **Open circuit is indicated by a straight horizontal line.**
- **Short circuit is shown by a straight vertical line.**

Testing Resistors

If the test object has a linear ohmic resistance, both deflecting voltages are in the same phase. The test pattern expected from a resistor is therefore a sloping straight line. The angle of slope is determined by the resistance of the resistor under test. With high values of resistance, the slope will tend towards the horizontal axis, and with low values, the slope will move towards the vertical axis.

Values of resistance from $20\ \Omega$ to $4.7\ k\Omega$ can be approximately evaluated. The determination of actual values will come with experience, or by direct comparison with a component of a known value.

Testing Capacitors and Inductors

Capacitors and inductors cause a phase difference between current and voltage, and therefore between the X and Y deflection, giving an ellipse-shaped display. The position and opening width of the ellipse will vary according to the impedance value (at 50 or 60Hz) of the component under test.

A horizontal ellipse indicates a high impedance or a relatively small capacitance or a relatively high inductance.

A vertical ellipse indicates a small impedance or a relatively large capacitance or a relatively small inductance.

A sloping ellipse means that the component has a considerable ohmic resistance in addition to its reactance.

The values of capacitance of normal or electrolytic capacitors from **0.1 μ F** to **1000 μ F** can be displayed and approximate values obtained. More precise measurement can be obtained in a smaller range by comparing the capacitor under test with a capacitor of known value. Inductive components (coils, transformers) can also be tested. The determination of the value of inductance needs some experience, because inductors have usually a higher ohmic series resistance. However, the impedance value (at 50 or 60Hz) of an inductor in the range from 20 Ω to 4.7 k Ω can easily be obtained or compared.

Testing Semiconductors

Most semiconductor devices, such as diodes, Z-diodes, transistors, FETs can be tested. The test pattern displays vary according to the component type as shown in the figures below.

The main characteristic displayed during semiconductor testing is the voltage dependent knee caused by the junction changing from the conducting state to the non conducting state. It should be noted that both the forward and the reverse characteristic are displayed simultaneously. This is always a two-terminal test, therefore testing of transistor amplification is not possible, but testing of a single junction is easily and quickly possible. Since the **CT** test voltage applied is only very low (max. 8.5V_{rms}), all sections of most semiconductors can be tested without damage. However, checking the breakdown or reverse voltage of high voltage semiconductors is not possible. More important is testing components for open or short-circuit, which from experience is most frequently needed.

Testing Diodes

Diodes normally show at least their knee in the forward characteristic. This is not valid for some high voltage diode types, because they contain a series connection of several

diodes. Possibly only a small portion of the knee is visible. Z-diodes always show their forward knee and, up to approx. 10V, their Z-breakdown, forms a second knee in the opposite direction. A Z-breakdown voltage of more than 12V can not be displayed.



Type:	Normal Diode	High Voltage Diode	Z-Diode 12V
Terminals:	Cathode-Anode	Cathode-Anode	Cathode-Anode
Connections:	(CT-GD)	(CT-GD)	(CT-GD)

The polarity of an unknown diode can be identified by comparison with a known diode.

Testing Transistors

Three different tests can be made to transistors: base-emitter, base-collector and emitter-collector. The resulting test patterns are shown below.

The basic equivalent circuit of a transistor is a Z-diode between base and emitter and a normal diode with reverse polarity between base and collector in series connection. There are three different test patterns:

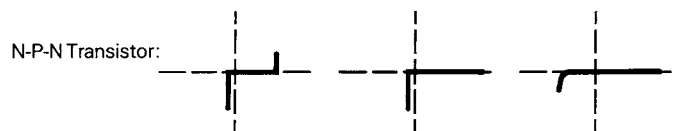

N-P-N Transistor:			
Terminals:	b-e	b-c	e-c
Connections:	(CT-GD)	(CT-GD)	(CT-GD)

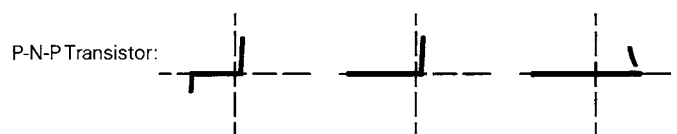

P-N-P Transistor:			
Terminals:	b-e	b-c	e-c
Connections:	(CT-GD)	(CT-GD)	(CT-GD)

For a transistor the figures b-e and b-c are important. The figure e-c can vary; but a vertical line only shows short circuit condition.

These transistor test patterns are valid in most cases, but there are exceptions to the rule (e.g. Darlington, FETs). With the **CT**, the distinction between a P-N-P to a N-P-N transistor is discernible. In case of doubt, comparison with a known type is helpful. It should be noted that the same socket connection (**CT** or ground) for the same terminal is then absolutely necessary. A connection inversion effects a rotation of the test pattern by 180 degrees round about the center point of the scope graticule.

Pay attention to the usual caution with single MOS-components relating to static charge or frictional electricity!

In-Circuit Tests

Caution! During in-circuit tests make sure the circuit is dead. No power from mains/line or battery and no signal inputs are permitted. Remove all ground connections including Safety Earth (pull out power plug from outlet). Remove all measuring cables including probes between oscilloscope and circuit under test. Otherwise the connection of both CT test leads is not recommended.

In-circuit tests are possible in many cases. However, they are not so well-defined. This is caused by a shunt connection of real or complex impedances – especially if they are of relatively low impedance at 50 or 60 Hz – to the component under test, often results differ greatly when compared with single components. In case of doubt, one component terminal may be unsoldered. This terminal should then be connected to the insulated **CT** socket avoiding hum distortion of the test pattern.

Another way is a test pattern comparison to an identical circuit which is known to be operational (likewise without power and any external connections). Using the test prods, identical test points in each circuit can be checked, and a defect can be determined quickly and easily. Possibly the device itself under test contains a reference circuit (e.g. a second stereo channel, push-pull amplifier, symmetrical bridge circuit), which is not defective.

The test patterns on page M18 show some typical displays for in-circuit tests.

Miscellaneous

A positive-going **sawtooth voltage** of approximately $5V_{pp}$ coincident with display's sweep time is available at a BNC output connector on the rear panel. This ramp output is marked with \mathcal{W} . The load impedance should not be less than $10k\Omega \parallel 47pF$. If the DC potential of the ramp output is not required, a capacitor should be connected in series with the output. The ramp output can be used for different measuring tasks in combination with the oscilloscope and other instruments, triggering of signal sources, swept-frequency signal generators and so on.

Blanking or intensity **Z-modulation** respectively of the CRT display is possible using the input connector marked **Z** on the rear panel. Low level (positive logic) effects blanking, high level gives unblanking. No higher voltages than $10V_{pp}$

are permitted. The Z input impedance is $8k\Omega \parallel 20pF$. A square-wave generator with negative pulses to ground (chassis) is not suitable. Also an offset (DC) voltage is not allowed for periodic modulation. For setting the blanking duty factor, the output voltage of a sine-wave generator should be adjustable. The Z-modulation occurs in bright-dark steps. An analog Z-modulation with continuous gradation of tones is possible. The modulating generator should have a sync input or – at least – an incremental frequency control, if an evaluation of the Z-modulation is necessary (blanking gaps as time markers). Generally, it is suitable to generate the Z-modulating frequency by multiplying the measuring frequency. Then the display shows stationary time markers.

The Z-modulation may also be effected with a **mechanical switch**, connected directly parallel to the **Z** connector, **without any power source**:

contact closed \triangleq dark trace
contact open \triangleq bright trace

This facility simplifies for instance contact time measurements and chatter tests on switches (relay). For periodical switch operation, the mechanical drive unit should deliver functionally a trigger signal. Only with synchronous operation of the Z-modulation and the sweep is a stationary display obtained.

The oscilloscope also contains a **vertical output** with BNC connector marked **Y** on the rear panel. The output voltage is $\geq 50mV_{pp}/cm$ display height (into 50Ω). It is picked off from the vertical amplifier like the trigger signal and it is similarly switchable. Channel **I** or **II** is selected with the **CHI/II-TRIGI/II** pushbutton. With alternate channel switching (**DUAL** button in the Y-Section depressed) and alternate triggering (**ALT.** button in the X-Section depressed), the vertical output is consecutively driven (in time with the sweep period) from Channel I and Channel II. The vertical output is not dependent on the vertical trace position. It does not respond to the adjustment of the **Y-POS.I** and **Y-POS.II** controls and to the depressing one of the **INVERT** buttons. The vertical output is DC coupled and has approximately zero level to ground. The bandwidth of the output is approx. 60 MHz (with 50Ω termination).

Especially for the photographic recording of displays, the oscilloscope has an optional **raster illumination**. Normally, the raster, which is necessary for the point-by-point evaluation, is not visible without illumination. Variation of the brightness is possible on two steps with a slide switch marked **ILLUM.**, which is mounted below the screen. In the uppermost position, the illumination is switched off. The optimum setting depends on the camera and film exposure index used. Possibly some test pictures are required for a good representation of the graticule.

Single Components



Short circuit

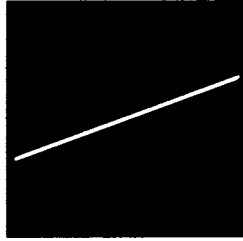

Resistor 510 Ω

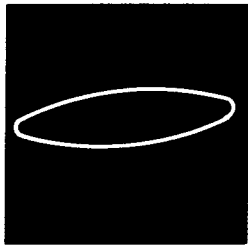

Mains transformer prim.

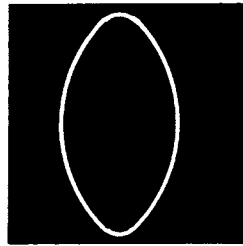

Capacitor 33 μF

Single Transistors

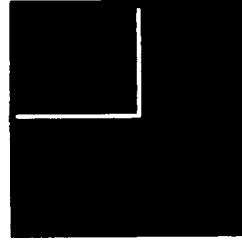

Junction B-C

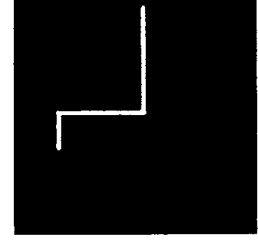

Junction B-E

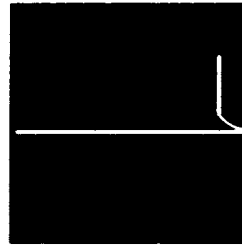

Junction E-C

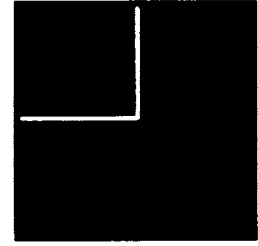

FET

Single Diodes

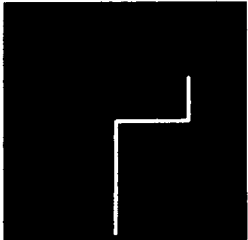

Z-diode under 8V



Z-diode beyond 12V

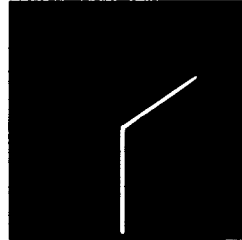

Diode paralleled by 680 Ω

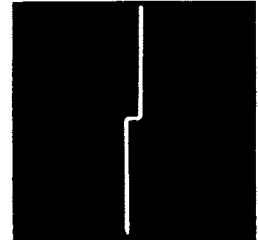

2 Diodes antiparallel

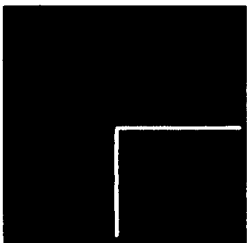

Silicon diode

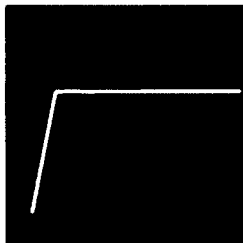

Germanium diode



Diode in series with 51 Ω

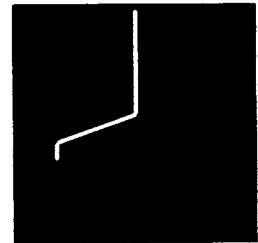

B-E paralleled by 680 Ω

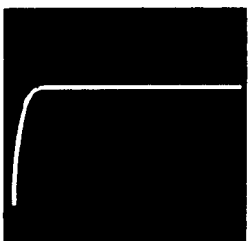

Rectifier

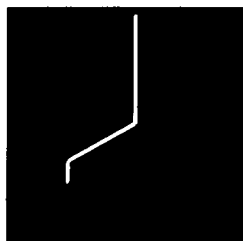

Thyristor G + A together



B-E with 1 μF + 680 Ω



Si-diode with 10 μF

First Time Operation

Connect the instrument to power outlet. Switch on **POWER** pushbutton. No other button is depressed. LED indicates operating condition.

Case, chassis, and all measuring connectors are connected to the Safety Earth Conductor (Safety Class I).

TRIG. selector switch to **AC, TV SEP.** switch to **OFF**, **LEVEL** knob in **AT** position (Automatic Triggering).

DELAY lever switch to **OFF**, and **HOLD-OFF** control **min.**

Adjust **INTENS.** control for average brightness.

Center trace on screen using **X-POS.** and **Y-POS.I** controls. Then focus trace using **FOCUS** control.

Operating Modes of the Vertical System

Channel **I**: All pushbuttons in out position.

Channel **II**: **CH.I/II-TRIG.I/II** button depressed.

Channel **I and Channel II**: **DUAL** button depressed.

Alternate channel switching: **ADD.** button in out position.

Chopped channel switching: **DUAL and ADD** buttons depressed. Signals < 1 kHz with **CHOP.**

Channel **I+II** (sum): **ADD** button depressed only.

Channel **-I+II** (difference): **ADD and INVERT** (CH. I) buttons depressed.

Channel **+I-II** (difference): **ADD and INVERT** (CH. II) buttons depressed.

Trigger Modes

Automatic Triggering: **LEVEL** knob in **AT** position. Trace always visible.

Normal Triggering: **LEVEL** turned cw. Trace visible when triggered.

Triggering from positive-going signal edge: **SLOPE +/-** button is in out position.

Triggering from negative-going signal edge: **SLOPE +/-** button depressed.

This facility is important when only a portion of a cycle is being displayed.

Internal triggering: select Channel with button **CH. I/II-TRIG. I/II.**

Internal alternate triggering: **ALT** button is depressed (only with alternate channel switching).

External triggering from **TRIG. INP.** connector: **EXT.** button depressed.

External trigger signal: 50 mV-0.5 V_{pp}, time-related to vertical input signal.

Line triggering: **TRIG.** selector switch in \sim position.

Trigger coupling selected with **TRIG.** switch **AC-DC-LF-HF.**

Trig. freq. range: **AC** and **DC** to 20 MHz, **HF** above 20 MHz, **LF** below 50 kHz.

Video signals with line freq.: **TV SEP.** switch to **H+** or **H-**.

Video signals with frame freq.: **TV SEP.** switch to **V+** or **V-**.

First or second half of frame selection with **FIELD I/II** switch.

Pay attention to **TRIG.** indication LED!

Measuring

Connect test signal to **CH.I** and/or **CH.II** vertical input connector.

Compensate attenuator probe using **CAL.** square-wave signal.

Select **AC** or **DC** input coupling. **GD:** Y amplifier is disconnected from input and grounded.

Adjust required display height of signal with attenuator switch and variable control.

Select sweep speed with **TIME/DIV.** switch and variable control.

Adjust trigger point with **LEVEL** control.

Calibrated amplitude measurement with attenuator variable control to **CAL.**

Calibrated time measurement with **TIME/DIV.** variable control to **CAL.**

Trigger complex or aperiodic signals using **HOLD-OFF** control in normal trigger mode.

Horizontal x10 expansion: **X MAG. x10** button depressed.

External horizontal deflection: (**X-Y operation**) with **X-Y** button depressed (X input via **CH.II**).

Sweep Delay Operation

OFF: normal oscilloscope operation. **DELAY** LED not illuminated.

SEARCH: use **DELAY** range switch and **VAR. 10:1** fine control to select point of interest on displayed wave-form. **DELAY** LED flashing.

DELAY: delayed signal now displayed. Expansion obtained by rotating **TIME/DIV.** switch clockwise. Press **X MAG. x10** button if necessary. **DELAY** LED illuminated.

DEL TRIG.: After Delay Triggering; together with **TV SEP.:** selection of trigger slope.

Component Tester

Press **COMPONENT TESTER** button. Connect both component terminals to **CT** and ground jacks.

In-circuit test: Circuit under test must be disconnected to battery or power (pull out power plug), signals and ground (earth). Remove all signal connections to HM 604 (cable, probe), then start testing.

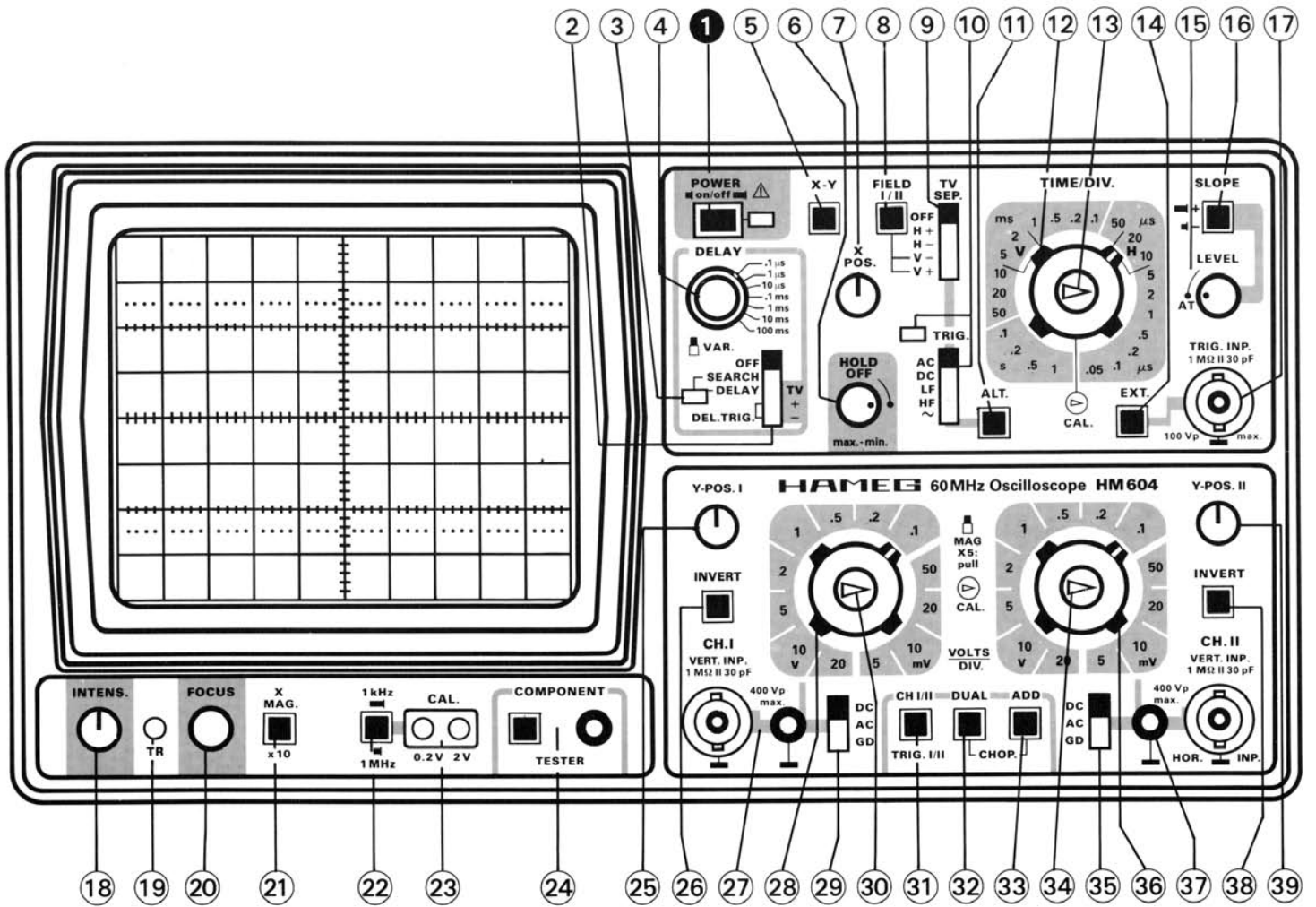

Front Panel Elements HM 604

Element	Function	Element	Function
① POWER on/off (pushbutton + LED)	Mains switch; when depressed: on. LED indicates operating condition.	②④ X-MAG. x10 (pushbutton)	10 fold expansion in X direction. When depressed, max. resolution = 5 ns/cm.
② DELAY OFF, SEARCH, DELAY, DEL. TRIG. (TV+/-) (lever switch)	5pos. switch for DELAY mode operation: OFF = normal; SEARCH = delay time select; DELAY = delayed timebase. Turning TIME/DIV. cw = expansion. DEL. TRIG. = additional triggering after delayed time has elapsed. TV+/- = selection of slope from delayed signal when in TV trig. mode.	②② 1 kHz – 1 MHz (pushbutton)	Selects calibrator frequency. Button released = 1 kHz; button depressed = 1 MHz.
③ DELAY (LED)	Indicator for DELAY mode: OFF = normal, SEARCH = flashes DELAY = permanently illuminated.	②③ CAL. 0.2V-2V (test sockets)	Calibrator square wave output, 0.2V _{pp} or 2V _{pp} (frequ. adjust ②②)
④ DELAY (7pos. rotary switch, outer knob. Fine adjustment = center pot.)	Coarse adjustment of delay time. Operative only during SEARCH, DELAY and DEL. Trig modes of DELAY lever switch.	②④ COMPONENT TESTER (pushbutton switch and single pole socket)	Switch to convert oscilloscope to component tester mode. Connector for single test lead. Second test lead is connected to chassis ground socket.
⑤ X-Y (pushbutton)	Selects XY operation. Switches off the internal timebase generator and connects channel II (HOR. INP.) to the X amplifier.	②⑤ Y-POS.I (knob)	Controls vertical position of channel I display.
Attention! Phosphor burn-in without X signal.		②⑥ INVERT (CHI) (pushbutton)	Inversion of CH. I display. In combination with ADD button ③③ = difference CH. II – CH. I. (Does not influence triggering).
⑥ HOLD OFF (knob)	Controls holdoff time between sweeps. Normal position = fully cw.	②⑦ CH. I (BNC connector) Ground (4mm socket)	Channel I signal input. Input impedance 1MΩ 30pF. Separate ground jack.
⑦ X-POS. (knob)	Controls horizontal position of trace.	②⑧ VOLTS/DIV. (12 position rotary switch)	Channel I input attenuator. Selects Y input sensitivity in mV/div. or V/div. in 1-2-5 sequence.
⑧ FIELD I/II (pushbutton)	Selects first or second half frame. (only in TV SEP. V+ or V- position).	②⑨ DC-AC-GD (slide switch)	Selects input coupling of CH. I vertical amplifier. DC = direct coupling; AC = coupling via capacitor; GD = signal disconnected from input, Y amplifier input grounded.
⑨ TV SEP. (lever switch)	Switch for TV sync separator. OFF = normal operation, H+ / H- = trig. of line (pos. or neg.) V+ / V- = trig. of frame (pos. od. neg.)	③⑩ Variable Y amplification (knob, pull-push switch)	Fine adjustment of Y amplitude CH. I. Increases attenuation factor min. by 2.5 (left hand stop). For amplitude measurements must be in CAL. position (right hand stop). When knob pulled out increasing of sensitivity by a factor of 5 (max. 1 mV/div.)
⑩ TRIG. AC-DC-HF-LF-~ (lever switch; LED indicator)	Trigger selector: AC: 10 Hz – 20 MHz. DC: 0 – 20 MHz. HF: 50 kHz – 100 MHz. LF: 0 – 50 kHz. ~: Internal line triggering. LED illuminated, when timebase is triggered.	③① CH I/II-TRIG. I/II (pushbutton)	No button depressed: CH. I only and triggering from channel I. When depressed, channel II only and triggering from channel II. (Trigger selection in DUAL mode).
⑪ ALT. (pushbutton)	Alternating triggering in dual channel mode.	③② DUAL (pushbutton)	Button released: one channel only. Button depressed: channel I and channel II in alternating mode. DUAL and ADD buttons depressed: CH. I and CH. II in chopped mode.
⑫ TIME/DIV. (23 step rotary switch)	Selects time coefficients (speeds) of timebase. from 0.05 μs/cm to 1 s/cm.	③③ ADD. (pushbutton)	
⑬ Variable timebase control (center knob)	Variable adjustment of timebase. Decreases X deflection speed at least 2.5 fold. For time measurements turn to right hand stop.	③④ Variable Y amplification (knob, pull-push switch)	Fine adjustment of Y amplitude CH. I. Increases attenuation factor min. by 2.5 (left hand stop). For amplitude measurements must be in CAL. position (right hand stop). When knob pulled out increasing of sensitivity by a factor of 5 (max. 1 mV/div.)
⑭ EXT. (pushbutton)	Input for external trigger signal. Trigger input signal via ⑰.	③⑤ DC-AC-GD (slide switch)	Selects input coupling of the CH. II vertical amplifier. Similar to ②⑨.
⑮ LEVEL (knob)	Adjustment of trigger level. Automatic triggering in AT position (knob on left hand stop).	③⑥ VOLTS/DIV. (12 position rotary switch)	Channel I input attenuator. Selects Y input sensitivity in mV/div. or V/div. in 1-2-5 sequence.
⑯ SLOPE +/- (pushbutton)	Selection of triggering on positive or negative going edge of signal.	③⑦ CH. II (BNC connector) Ground (4mm socket)	Channel II signal input. Input impedance 1MΩ 30pF. Separate ground jack.
⑰ TRIG. INP. (BNC connector)	Input for external trigger signal. (Pushbutton ⑭ depressed).	③⑧ INVERT (CHII) (pushbutton)	Inversion of Channel II display. Similar to ②⑥.
⑱ INTENS. (knob)	Intensity control for trace brightness.	③⑨ Y-POS.II (knob)	Controls vertical position of CH. II display. No function in XY mode.
⑲ TR (potentiometer adjustment with screwdriver)	Trace Rotation. To align trace with horizontal graticule line. Compensates influence of earth's magnetic field.		
⑳ FOCUS (knob)	Focus control for trace sharpness.		

Test Instructions

General

These Test Instructions are intended as an aid for checking the most important characteristics of the HM 604 at regular intervals without the need for expensive test equipment. Resulting corrections and readjustments inside the instrument, detected by the following tests, are described in the Service Instructions or on the Adjusting Plan. They should only be undertaken by qualified personnel.

As with the First Time Operation instructions, care should be taken that all knobs with arrows are set to their calibrated positions. None of the pushbuttons should be depressed. **LEVEL** knob out in **AT** position, **TRIG.** selector switch to **AC**, **DELAY** slide switch to **OFF**. It is recommended to switch on the instrument for about 30 minutes prior to the commencement of any check.

Cathode-Ray Tube: Brightness and Focus, Linearity, Raster Distortions

Normally, the CRT of the HM 604 has very good brightness. Any reduction of this brightness can only be judged visually. However, decreased brightness may be the result of reduced high voltage. This is easily recognized by the greatly increased sensitivity of the vertical amplifier. The control range for maximum and minimum brightness (intensity) must be such that the beam just disappears before reaching the left hand stop of the **INTENS.** control (particularly when the **X-Y** button is depressed), while with the control at the right hand stop the focus and the line width are just acceptable.

With maximum intensity the timebase fly-back must on no account be visible. Visible display fault without input signal: Bright dot on the left side — **or** — decreasing brightness from left to right or shortening of the baseline. (Cause: incorrect Unblanking Pulse.

It should be noted that with wide variations in brightness, refocusing is always necessary. Moreover, with maximum brightness, no “pumping” of the display must occur. If pumping does occur, it is normally due to a fault in the regulation circuitry for the high voltage supply. The presetting pots for the high voltage circuit, minimum and maximum intensity, are only accessible inside the instrument (see Adjusting Plan and Service Instructions).

A certain out-of-focus condition in the edge zone of the screen must be accepted. It is limited by standards of the CRT manufacturer. The same is valid for tolerances of the orthogonality, the undeflected spot position, the non-linearity and the raster distortion in the marginal zone of the screen in accordance with international standards (see CRT data book). These limit values are strictly supervised by HAMEG. The selection of a cathode-ray tube without any tolerances is practically impossible.

Astigmatism Check

Check whether the horizontal and vertical sharpness of the display are equal. This is best seen by displaying a square-wave signal with the repetition rate of approximately 1 MHz. Focus the horizontal tops of the square-wave signal at normal intensity, then check the sharpness of the vertical edges. If it is possible to improve this vertical sharpness by turning the **FOCUS** control, then an adjustment of the astigmatism control is necessary. A potentiometer of 50 k Ω (see Adjusting Plan) is provided inside the instrument for the correction of astigmatism (see Service Instructions). A certain loss of marginal sharpness of the CRT is unavoidable; this is due to the manufacturing process of the CRT.

Symmetry and Drift of the Vertical Amplifier

Both of these characteristics are substantially determined by the input stages of the amplifiers. **The checking and correction of the DC balance for the amplifiers should be carried out as already described in the Operating Instructions** (page M7).

The symmetry of Channel I and the vertical final amplifier can be checked by inverting Channel I, depress **INVERT** (CHI pushbutton). The vertical position of the trace should not change by more than 5 mm. However, a change of 1 cm is just permissible. Larger deviations indicate that changes have occurred in the amplifier.

A further check of the vertical amplifier symmetry is possible by checking the control range of the **Y-POS.** controls. A sine-wave signal of 10-100 kHz is applied to the amplifier input. When the **Y-POS.** control is then turned fully in both directions from stop to stop with a display height of approximately **8 cm**, the upper and lower positions of the trace that are visible should be approximately of the same height. Differences of up to 1 cm are permissible (input coupling should be set to **AC**).

Checking the drift is relatively simple. **Ten minutes after switching on the instrument**, set the baseline exactly on the horizontal center line of the graticule. The beam position must not change by more than **5 mm** during the following hour. Larger deviations generally result from different characteristics of the dual FETs in both channel inputs to the Y amplifier. To some extent, fluctuations in drift are caused by offset current on the gate. The drift is too high, if the vertical trace position drifts by more than **0.5 mm** on turning the appropriate attenuator switch through all 12 steps. Sometimes such effects occur after long periods of operation.

Calibration of the Vertical Amplifier

Two square-wave voltages of **0.2 mV_{pp}** and **2 V_{pp} ± 1 %** are present at the output sockets of the calibrator (**CAL.**). If a

direct connection is made between the 0.2mV output and the input of the vertical amplifier, the displayed signal in the **50mV/cm** position (variable control to **CAL.**) should be **4cm** high (**DC** input coupling). Maximum deviations of 1.2mm (3%) are permissible. If a **x10 probe** is connected between the 2V-output socket and Y input, the same display height should result. With higher tolerances it should first be investigated whether the cause lies, within the amplifier or in the amplitude of the square-wave signal. On occasions it is possible that the probe is faulty or incorrectly compensated. If necessary the measuring amplifier can be calibrated with an accurately known DC voltage (**DC** input coupling). The trace position should then vary in accordance with the deflection coefficient set.

With variable control at the attenuator switch fully counter-clockwise, the input sensitivity is decreased at least by the factor 2.5 in each position. In the **50mV/cm** position, the displayed calibrator signal height should vary from 4cm to at least 1.6cm.

When pulling the Y-expansion x5 knob (**MAG x5**), the sensitivity is increased by the factor 5. In the **0.2V/cm** position the displayed signal should change from 1cm to 5cm by pulling the **MAG x5** knob.

Transmission Performance of the Vertical Amplifier

The transient response and the delay distortion correction can only be checked with the aid of a square-wave generator with a fast risetime (**max. 5ns**). The signal coaxial cable (e.g. HZ34) must be terminated at the vertical input of the oscilloscope with a resistor equal to the characteristic impedance of the cable (e.g. with HZ22). Checks should be made at 100Hz, 1kHz, 10kHz, 100kHz and 1MHz, the deflection coefficient should be set at **5mV/cm** with **DC** input coupling (Y variable control in **CAL.** position). In so doing, the square pulses must have a flat top without ramp-off, spikes and glitches; no overshoot is permitted, especially at 1MHz and a display height of **4-5cm**. At the same time, the leading top corner of the pulse must not be rounded. In general, no great changes occur after the instrument has left the factory, and it is left to the operator's discretion whether this test is undertaken or not.

Of course, the quality of the transmission performance is not only dependent on the vertical amplifier. **The input attenuators**, located in the front of the amplifier, **are frequency-compensated in each position**. Even small capacitive changes can reduce the transmission performance. Faults of this kind are as a rule most easily detected with a square-wave signal with a low repetition rate (e.g. 1kHz). If a suitable generator with max. output of 40V_{pp} is available, it is advisable to check at regular intervals the deflection coefficients on all positions of the input

attenuators and readjust them as necessary. A compensated **2:1 series attenuator** is also necessary, and this must be matched to the input impedance of the oscilloscope. This attenuator can be made up locally. It is important that this attenuator is shielded. For local manufacture, the electrical components required are a 1MΩ ±1% resistor and, in parallel with it, a trimmer 3-15pF in parallel with approx. 20pF. One side of this parallel circuit is connected directly to the input connector of the vertical amplifier and the other side is connected to the generator, if possible via a low-capacitance coaxial cable. The series attenuator must be matched to the input impedance of the oscilloscope in the **5mV/cm** position (variable control to **CAL.**, **DC** input coupling; square tops exactly horizontal; no ramp-off is permitted). This is achieved by adjusting the trimmer located in the 2:1 attenuator. **The shape of the square-wave should then be the same in each input attenuator position.**

Operating Modes: CH.I/II-TRIG.I/II, DUAL, ADD, CHOP., INV.I/II and X-Y Operation

On depressing the **DUAL** pushbutton, two traces must appear immediately. On actuation of the **Y-POS.** controls, the trace positions should have no effect on each other. Nevertheless, this cannot be entirely avoided, even in fully serviceable instruments. When one trace is shifted vertically across the entire screen, the position of the other trace must not vary by more than 0.5mm.

A criterion in chopped operation is trace widening and shadowing around and within the two traces in the upper or lower region of the screen. Set **TIME/DIV.** switch to **1μs/cm**, depress the **DUAL** and **CHOP.** pushbutton, set input coupling of both channels to **GD** and advance the **INTENS.** control fully clockwise. Adjust **FOCUS** for a sharp display. With the **Y-POS.** controls shift one of the traces to a +2cm, the other to a -2cm vertical position from the horizontal center line of the graticule. Do not try to synchronize the chop frequency (500kHz)! Then alternately release and depress the **CHOP.** pushbutton. Check for negligible trace widening and periodic shadowing in the chopped mode.

It is important to note that in the **I+II** add mode (only **ADD** depressed) or the **-I+II** difference mode **INVERT** (**CHI**) button depressed in addition) the vertical position of the trace can be adjusted by using **both** the Channel I and Channel II **Y-POS.** controls. If a trace is not visible in either these modes, the overscanning LEDs will indicate the position of the trace.

In X-Y Operation (**X-Y** pushbutton depressed), the sensitivity in both deflection directions will be the same. When the signal from the built-in square-wave generator is applied to the input of Channel II, then, as with Channel I in the vertical direction, there must be a horizontal deflection of **4cm** when the deflection coefficient is set to **50mV/cm** position

(variable control set to its **CAL.** position, **X MAG. x10** released). The check of the mono channel display with the **CHI/II** button is unnecessary; it is contained indirectly in the tests above stated.

Triggering Checks

The internal trigger threshold is important as it determines the display height from which a signal will be stably displayed. It should be approx. 5mm for the HM604. An increased trigger sensitivity creates the risk of response to the noise level in the trigger circuit, especially when the sensitivity of the vertical input is increased by pulling the **MAG. x5** knob. This can produce double-triggering with two out-of-phase traces. Alteration of the trigger threshold is only possible internally. Checks can be made with any **sine-wave voltage** between 50Hz and 1 MHz. The **LEVEL** knob should be in **AT** position. Following this it should be ascertained whether the same trigger sensitivity is also present with Normal Triggering (**LEVEL** knob not in **AT** position).

On depressing the **SLOPE +/-** button, the start of the sweep changes from the positive-going to the negative-going edge of the trigger signal.

Internally the HM604 should trigger perfectly with sinusoidal signals up to 100MHz at a display height of approx. 5mm, when the **HF** trigger coupling mode is set.

For external triggering (**EXT.** button depressed), the **EXT. TRIG.** input connector requires a signal voltage of at least 50mV_{pp}, which is in synchronism with the Y input signal. Checking of TV triggering is possible with a video signal of switchable polarity. A check of both polarities in **V** and **H** mode should be made.

The display should not shift horizontally during a change of the trigger coupling from **AC** to **DC** with a sine-wave signal without DC offset. The basic requirement for this is a correct **DC Balance Adjustment** on the input of the vertical amplifier (see Operating Instructions, page M7).

In the **dual channel mode** (**DUAL** button depressed) **with alternate channel switching and with alternate triggering** (**ALT.** button in the X-Section depressed), two non-frequency related signals (e.g. mains/line frequency signal and calibrator signal) should reliably be triggered internally dependent on the positions of the **CHI/II-TRIG.I/II** pushbuttons. In the dual channel mode with chop channel switching and depressed **ALT.** button, only triggering from Channel **I** should be possible. Periodical signal blanks (due to the chopper frequency 0.5MHz) should not be visible.

If both vertical inputs are **AC** coupled to the same signal and both traces are brought to coincide exactly on the screen, when working in the **alternate dual channel mode**, then no change in display should be noticeable, when the **ALT.** button is depressed or released.

Checking of the line/mains frequency triggering (50-60Hz) is possible, when the input signal is time-related (multiple or submultiple) to the power line frequency (**TRIG.** selector switch to **LINE**). In this trigger mode, there is no trigger threshold. Even very small input signals are triggered stably (e.g. ripple voltage). For this check, use an input of approx. 1V. The displayed signal height can then be varied by turning the respective input attenuator switch and its variable control.

Timebase

Before checking the timebase it should be ascertained that the **trace length is 10cm**. If not, it can be corrected with the potentiometer for sweep amplitude (see Adjusting Plan). This adjustment should be made with the **TIME/DIV.** switch in a mid position (i.e. **5µs/cm**). Prior to the commencement of any check set the time variable control to **CAL.** and the **HOLD-OFF** time control to **min.** The **X MAG. x10** button should be released. This condition should be maintained until the variation ranges of these controls are checked.

If a precise marker signal is not available for checking the **Timebase** time coefficients, then an accurate sine-wave generator may be used. Its frequency tolerance should not be greater than $\pm 1\%$. The timebase accuracy of the HM604 is given as $\pm 3\%$, but as a rule it is considerably better than this. For the simultaneous checking of timebase linearity and accuracy at least 10 oscillations, i.e. **1 cycle every cm**, should always be displayed. For precise determination, set the peak of the first marker or cycle peak exactly behind the first vertical graticule line using the **X-POS.** control. Deviation tendencies can be noted after some of the marker or cycle peaks.

The **20** and **10ms/cm** ranges of the **TIME/DIV.** switch can be checked very precisely with line frequency (**50Hz** only). On the **20ms/cm** range a cycle will be displayed every cm, while on the **10ms/cm** range it will be every 2cm.

The following table shows which frequencies are required for the particular ranges.

1 s/cm	—	1 Hz	0.1 ms/cm	—	10 kHz
0.5 s/cm	—	2 Hz	50 µs/cm	—	20 kHz
0.2 s/cm	—	5 Hz	20 µs/cm	—	50 kHz
0.1 s/cm	—	10 Hz	10 µs/cm	—	100 kHz
50 ms/cm	—	20 Hz	5 µs/cm	—	200 kHz
20 ms/cm	—	50 Hz	2 µs/cm	—	500 kHz
10 ms/cm	—	100 Hz	1 µs/cm	—	1 MHz
5 ms/cm	—	200 Hz	0.5 µs/cm	—	2 MHz
2 ms/cm	—	500 Hz	0.2 µs/cm	—	5 MHz
1 ms/cm	—	1 kHz	0.1 µs/cm	—	10 MHz
0.5 ms/cm	—	2 kHz	0.05 µs/cm	—	20 MHz
0.2 ms/cm	—	5 kHz			

The **time variable control** range can also be checked. The sweep speed becomes slower by turning this variable control counter-clockwise to its left stop. 2.5 cycles at least every **cm** should be displayed (with **X MAG. x10** button released; measurement in the **5 μ s/cm** range).

When the **X MAG. x10** button is depressed, a marker or cycle peak will be displayed every 10cm $\pm 5\%$ (with variable control in **CAL.** position; measurement in the **5 μ s/cm** range). The tolerance is better measurable in the **50 μ s/cm** range (one cycle every 1cm).

Check the ramp output voltage on rear panel (BNC connector marked by *M*) with a Test Oscilloscope. **Test Scope setting: 1V/cm; Timebase** to one step slower sweep speed than on the HM604 under test. The latter must have no input and no trigger voltage (free-running sweep; input coupling switch to **GD**). The sawtooth voltage is applied with a BNC cable **without termination** from the ramp output connector to the input of the Test Scope. The Test Scope should show a positive-going linear sawtooth with an amplitude of approx. **5V_{pp}**. At the same time the function of the **HOLD-OFF** control **min.-max.** can be checked. The hold-off time variation cannot be measured precisely with this method, because the unblanking pulse of the timebase generator is smaller than the ramp width.

Sweep Delay

When the Sweep DELAY mode lever switch is set to the **OFF** mode, the delay should have no effect on the display of the **1kHz calibration signal**. When the Sweep Delay is set in the **SEARCH** mode (refer to Sweep Delay Operating Instructions), it is possible to check the delay time by means of a distance measurement of the blanked baseline. For this, the **DELAY VAR. 10:1** control must be set to x1 (rotate counterclockwise until a snap noise is audible). When **DELAY** mode is selected, the trace reverts to the full 10cm display without any blanking.

Over the full range of adjustment of the DELAY VAR. 10:1 control, the displayed waveform of the calibration signal should be shifted without any jitter, jumping or intermittent blanking.

Control settings: Connect calibrator socket (0.2V/1 kHz) to **CH.I** input connector, **DC** input coupling, deflection coefficient **50mV/cm**, **TRIG.** selector switch to **AC**, time coefficient **1ms/cm**, no pushbutton depressed, all controls in calibrated position, **DELAY** mode switch in **OFF** position, **LEVEL** knob in **AT** position. Now the calibrator signal is displayed with a signal height of 4cm and approx. 1 cycle per cm. After switching to **SEARCH**, the mode indication lamp blinks. Set the **DELAY** range switch to **1ms**. Rotate the **DELAY VAR.** control until the left half of the display is blanked. The delay time is now **5ms**. After switching to

DELAY, the display is again fully visible. The **DELAY** mode LED is illuminated continuously. The displayed signal can now be expanded. For this purpose turn the **TIME/DIV.** switch clockwise to **5 μ s/cm**. The expansion is now x200. With the **DELAY VAR.** control, the nearest edge of the calibration signal can be brought in the screen center and checked on the above-mentioned criteria. With x200 expansion, the display brightness normally needs increasing (with **INTENS.** and **FOCUS** control). However, larger expansions than x200 are quite possible, but the decrease of brightness and the jitter restricts the evaluation.

When switching to **DEL. TRIG.** positions, every slope is accepted for triggering after the delay time has elapsed. In **TVSEP.** mode condition, the slope can be chosen (+/-).

Component Tester

After pressing the **COMPONENT TESTER** button, a horizontal straight line has to appear immediately, when the **CT** socket is open. The length of this trace should be approx. **8cm**. With connection of the **CT** socket to one of the ground jacks in the Y-Section, a vertical straight line with approx. 6cm height should be displayed. The above stated measurements have some tolerances. They are dependent among other things on the mains/line voltage.

Trace Alignment

The CRT has an admissible angular deviation $\pm 5^\circ$ between the X deflection plane D1-D2 and the horizontal center line of the internal graticule. This deviation, due to tube production tolerances (and only important after changing the CRT), and also the influence of the earth's magnetic field, which is dependent on the instrument's North orientation, are corrected by means of the **TR** potentiometer. In general, the trace rotation range is asymmetric. It should be checked, whether the baseline can be adjusted somewhat sloping **to both sides** round about the horizontal center line of the graticule. With the HM604 in its closed case, an angle of rotation $\pm 0.57^\circ$ (1mm difference in elevation per 10cm graticule length) is sufficient for the compensation of the earth's magnetic field.

Miscellaneous

Y output

A check of the **Y** output (rear panel) is possible on the screen using the dual channel mode by means of the calibrator signal. To this a connection is made from the calibrator socket (0.2V/1 kHz) to the **CH.I** input connector and – using a BNC-BNC cable and a 50 Ω through-termination – a second connection from the **Y** output to **CH.II** input connec-

tor. **Settings:** CH.I attenuator switch to **50mV/cm**, CH.II attenuator switch to **0.1V/cm**, CH.I input coupling to **DC**, CH.II input coupling to **GD**, **TIME/DIV.** switch to **0.5ms/cm**, automatic triggering (**LEVEL** knob in **AT** position), **TRIG.** selector to **AC**, no button depressed. Now the square-wave signal is visible with **4cm** display height. With **Y-POS.I** control, the tops of the square-wave are adjusted to $\pm 2\text{cm}$ from the horizontal center line of the graticule. Then the **DUAL** button has to be pressed. The appearing second trace (without signal) is adjusted to -2cm using the **Y-POS.II** control. Then the **CH.II** input coupling is set to **DC**. Now the signal across the **Y** output appears with the same phase position as the calibrator signal via Channel I. As well as the DC offset (e.g. $+0.8\text{cm} \triangleq +80\text{mV}$) the amplitude (e.g. $2\text{cm} \triangleq 0.2V_{pp}$) of the **Y** output can be measured. In the example, the sensitivity of the **Y** output can be calculated as $0.2V:4\text{cm} = 50\text{mV/cm}$.

Z modulation (optional)

Checking the blanking facility on the **Z** modulation connector (rear panel) is possible with a sine- or square-wave generator. The sine-wave generator requires an output voltage control. The square-wave generator must deliver positive pulses to ground (chassis). Alternatively a small adjustable sine voltage from a (separate) power transformer may be used. For the latter set the **TIME/DIV.** range to e.g. **10ms/cm**. With the **TIMEBASE** variable control, the gap in the baseline can be brought acceptably to a standstill. Line frequency triggering is better (**TRIG.** selector switch to \sim). The length ratio from bright to dark lines on the display is dependent on the sine voltage amplitude. Without a modulating generator, the function of the **Z** modulation can be checked coarsely by short-circuiting the **Z** connector. Then the baseline is blanked fully.

HAMEG

Oscilloscopes

Multimeters

Counter Timers

Power Supplies

Calibrators

**Signal
Generators**

**Check Point
Testers**

West Germany

HAMEG GmbH

Kelsterbacher Str. 15-19
6000 FRANKFURT am Main 71
Tel. (069) 67805-0 · Telex 413866
Telefax (069) 6780513

France

HAMEG S.a.r.l.

5-9, av. de la République
94800-VILLEJUIF
Tél. (1) 46778151 ; Télex 270705
Telefax (1) 47263544

Spain

HAMEG S.A.

Villarroel 172-174
08036 BARCELONA
Téléf. (93) 2301597 / 2301100
Telex 99816 · Telefax (93) 3212201

Great Britain

HAMEG LTD

74-78 Collingdon Street
LUTON, Bedfordshire LU1 1RX
Tel. (0582) 413174 · Telex 825484
Telefax (0582) 456416

United States of America

HAMEG, Inc.

88-90 Harbor Road
PORT WASHINGTON, NY 11050
Phone (516) 883-3837
Telex (023) 497-4606
Telefax (516) 883-3894

HAMEG, Inc.

Hancock Business Park
4790 Wesley Drive
ANAHEIM, CA 92807
Phone (714) 970-9575
Telefax (714) 970-0328