Operation Manual

Oscilloscope

SS-7821/11
SS-7810/06

IWATSU



Introduction

- ◇ Thank you very much for your purchase of Iwatsu electronic measuring instruments. We appreciate your continued patronage of Iwatsu electronic measuring instruments.
- ◇ Please use your instrument after thoroughly reading this instruction manual and understanding its contents. After reading this manual, please keep it in a safe place for future reference.

Cautions for safe use

Matters that must be observed for safe operation of this instrument and for prevention of injury to humans and damage to property are described as “⚠ warnings” and “⚠ cautions” in this instruction manual. The symbol to invoke caution is marked on the panel.

Explanation of “⚠ warnings” and “⚠ cautions” columns in this instruction manual

 Warning	Incorrect operation or failure to heed warnings may result in death or serious injury.
 Caution	Incorrect operation or failure to heed cautions may result in injury or damage to equipment.

Explanation of the symbols on the panel

 Warning symbol	This is a symbol used in reference with the statements in the instruction manual to protect human against injury and protect this instrument against damage.
--	--

Cautions

- ◇ Parts of the contents of this instruction manual may be modified without notice to accommodate improvements in performance and function.
- ◇ Reproduction of the contents of this instruction manual without previous consent is prohibited.

History

- ◇ Nov. 1994: Issue of the 1st edition
- ◇ May. 1998: Issue of the 5th edition

Warnings

- **Do not use this instrument in a location where there is explosive gas in the vicinity.**

The use of this instrument in a location where there is explosive gas could result in explosion.

- **If there is any smoke, abnormal odor, or abnormal sound coming display type this instrument, immediately set the power switch to STBY and disconnect the power cord.**

Use of this instrument under these conditions could result in electrical shock or fire. After setting the power switch to STBY and disconnecting the power cord, contact one of our service offices for repair. Repair by the user is dangerous and should be strictly avoided.

- **Take care to not allow water to get into this instrument or the wetting of this instrument.**

The use of this instrument in a wet state could result in electrical shock or fire. If water or other foreign matter has gotten into this instrument, first set the power switch to STBY and remove the power cord and then contact one of our service offices for repair.

- **Do not place this instrument on an unstable place such as on a shaky stand or on a slant.**

The dropping or turning over of this instrument could result in electrical shock, injury, or fire. If this instrument has dropped or its cover has been damaged, first set the power switch to STBY and remove the power cord and then contact one of our service offices for repair.

- **Do not allow any foreign matter such as metal or inflammable substance to get in from the air hole, etc.**

The entrance of any foreign matter display type the ventilation port, etc., could result in fire, electrical shock, or power failure. If any foreign matter has entered, first set the power switch to STBY and remove the power cord and then contact one of our service offices for repair.

Be sure to read this page to assure safety. Read the next page also.

Warnings (cont'd)

● Be sure to use a 3-core power cord.

Failure to use a 3-core power cord could result in electrical shock or power failure.

- When supplying power display type a 2-wire receptacle using a 3-core/2-core conversion adapter, be sure to connect the grounding terminal of the 3-core/2-core conversion adapter to ground.
- When supplying power display type a 3-wire receptacle using the attached 3-core power cord, the grounding wire of the power cord is connected to ground.

● Use this instrument with the rated AC power supply.

Use of this instrument with a voltage other than specified could result in electrical shock, fire, or power failure. The usable power voltage range (90 to 132 VAC or 180 to 250 VAC) is marked on the rear panel.

● Be sure to connect the ground side of probes and input connectors to the grounding potential of the object being measured.

If the grounding lead is connected to potential other than the ground, electrical shock or other accidents (damages to the object being measured, the instrument itself or other units connected to the instrument) may occur (refer to the "Example of improper configuration" shown below).

[Example of improper configuration]

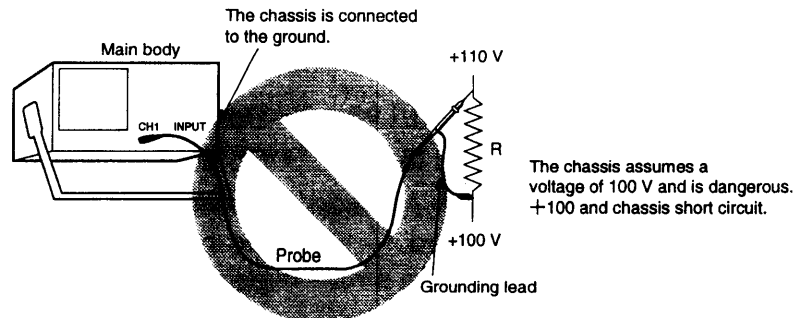

When measuring the floating potential, measurement by the differential method (CH1 and CH2 input) is recommended (refer to the example shown below).

[Example of recommended measurement method]

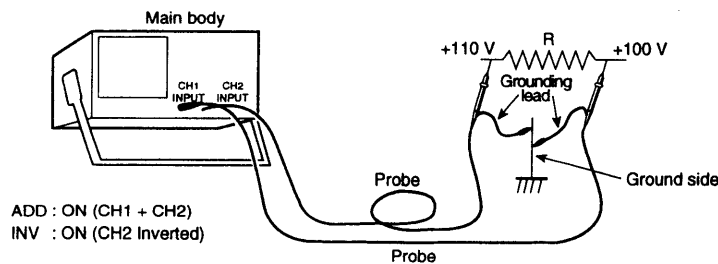

Warnings

● **Do not remove either the cover or panel.**

There are high-voltage parts inside the cover and panel and touching any of them could result in electrical shock. Please contact one of our service offices for any inspection, calibration, or repair.

● **Take sufficient care when measuring high voltages.**

Touching a high-voltage part during measurement could result in electrical shock.

● **When carrying this instrument with a shoulder bag, use only an appropriate bag.**

If an inappropriate shoulder bag is used, the instrument may drop and cause injury.

If there are any questions concerning the safety of a shoulder bag, such as broken seams or weakened straps, do not use the bag.

● **When handling the power cord, strictly observe the following:**

Failure to heed this inspection could result in fire or electrical shock. If the power cord has been damaged, contact one of our service offices (at the end of this volume) for repair.

- Do not modify the power cord.
- Do not bend the power cord forcibly.
- Do not twist the power cord.
- Do not bundle the power cord.
- Do not pull the power cord.
- Do not heat the power cord.
- Do not moisten the power cord.
- Do not place a heavy object on the power cord.

● **Do not modify this instrument.**

Modification of this instrument could result in electrical shock, fire, or power failure. Repair of a modified instrument may be refused.

Cautions

- **Be sure to use a specified fuse (ϕ 5 x 20 mm, 250 V, 2A, SLOW) when replacing the fuse.**
The use of a fuse other than a specified one could result in fire or power failure. Disconnect the power cord when replacing the fuse.
- **Be sure to use a three-core power cord suitable for the supply voltage.**
The use of a cord that is not suitable for the supply voltage may cause fire. Also, the use of a two-core power cord may cause electrical shock.
- **Be sure to connect and disconnect the power cord after setting the power switch to STBY.**
Connection and disconnection of the power cord with power supplied could result in electrical shock or power failure.
- **When disconnecting the power cord display type the receptacle, pull it by holding the plug.**
Pulling by the cord may damage the cord and could result in fire or electrical shock.
- **Avoid use of any damaged cable or adapter.**
The use of any damaged cable or adapter could result in fire or electrical shock.
- **Avoid placing any object on this instrument.**
If any object is placed on this instrument, the cover may contact the internal circuitry and could result in electrical shock, fire, or power failure.
- **Do not place any object in the vicinity of the air hole or fan of this instrument.**
Placing any object in the vicinity of the air hole or fan may generate internal heat and could result in fire or electrical shock.
- **Do not place this instrument in a location with a high degree of moisture or dust.**
Placing this instrument in a location with a high degree of moisture or dust could result in fire or electrical shock.
- **When using this instrument in an upright position, take care not to allow it fall over.**
The falling over of this instrument could result in injury, fire, or electrical shock.
- **When probes or measuring cables, etc. are connected to this instrument, take care not to cause this instrument to fall over by pulling them.**
The falling over of this instrument could result in injury, fire, or electrical shock.
- **Do not use this instrument if it has failed.**
The use of this instrument in a state of failure could result in fire or electrical shock. In the case of failure, contact one of our service offices for repair.

Be sure to read this page to assure safety.

Cautions

- **Always use this instrument only within the rated operating range.**

The use of this instruction out of the rated operating range could result in power failure. The temperature and humidity ranges that allow the use of this instrument are as follows:

 - Operation : Indoor use only
 - Temperature : 0 °C to +40°C
 - Relative humidity : 90% or less (at 0°C to +40°C)
- **Do not apply voltage to an input terminal exceeding the posted rating.**

Applying a voltage exceeding the posted rating could result in power failure. The maximum voltage than can be applied is as follows:

 - SS-7821
 - Direct : ±400 V (DC+ACpeak)
 - With probes equivalent to SS-082R (10:1) : ±600 V (DC+ACpeak)
 - SS-7811/7810/06
 - Direct : ±400 V (DC+ACpeak)
 - With probes equivalent to SS-0130R (10:1) : ±600 V (DC+ACpeak)

[Note] The maximum input voltage derates depending on frequency and high voltage pulse of an input signal.
- **Do not raise trace or character intensity beyond what is necessary.**

The use of an intensity beyond what is necessary could result in eye fatigue or burn in of the CRT.
- **Leave space side and rear.**

When using this instrument in a cabinet or putting on the other instruments, the scope may overheat, it could result failure of operation and specifications, contact our Service Office.
- **To assure safety, be sure to disconnect the power cord if the instrument is not to be used for a long period.**
- **When transporting this instrument, be sure to use the original packing material that came with the instrument or other packing material that is equal or superior.**

Large vibrations and/or shocks applied to the instrument during transpiration could result in power failure and fire. If there is no appropriate packing material and/or cushion material, consult one of our service offices.

When using a carrier, label "precision machine" on each face of the packing box.

Contents

Cautions for safe use	I
<i>Warnings</i>	<i>II</i>
Cautions	V
Unpacking	IX
Components	IX
Replacement of built-in battery	IX
Section 1. Controls, Connectors and Indicators	1
1.1 Front Panel	1
1.2 RearPanel	3
Section 2. Basic Operation	4
2.1 Displaying CAL signal with AUTO SET	6
2.2 Probe Compensation	7
2.3 Display Adjustment	8
2.4 Vertical and Horizontal Positioning	9
2.5 Vertical Deflection System	9
2.5.1 Deflection Factor	9
2.5.2 Input Coupling	10
2.5.3 Display Channels	11
2.5.4 ALT and CHOP	11
2.5.5 Sum (ADD) and Difference (INV)	12
2.5.6 Bandwidth Limiter	12
2.6 Sweep Rate and Magnification	13
2.6.1 Sweep Rate	13
2.6.2 Magnification	13
2.7 Sweep Mode	14
2.7.1 Repetitive Sweep	14
2.7.2 Single Sweep	14
2.8 Triggering	15
2.8.1 Trigger Source	15
2.8.2 Trigger Coupling	15
2.8.3 Trigger Slope	16
2.8.4 Trigger Level	16
2.8.5 TV Signal	17
2.9 Horizontal Display	18
2.10 Trace Separation	19
2.11 Delayed Sweep	20
2.11.1 Continuous Delay	20
2.11.2 Triggered Delay	21
2.12 Holdoff	22

Section 3. Cursor Measurement and Counter	23
3.1 Time Difference (Δt) and Frequency ($1/\Delta t$)	23
3.2 Voltage Difference (ΔV)	25
3.3 Counter	26
Section 4. Save/Recall	27
4.1 Save	27
4.2 Recall	27
Section 5. Daily Inspection	28
Section 6. Specifications	31
SS-500/501/502/505 (CH2 OUT, Z AXIS IN)	36
Probe SS-082R	37
Probe SS-0130R/0131R	38

Unpacking

The figure below depicts the unpacking procedure.

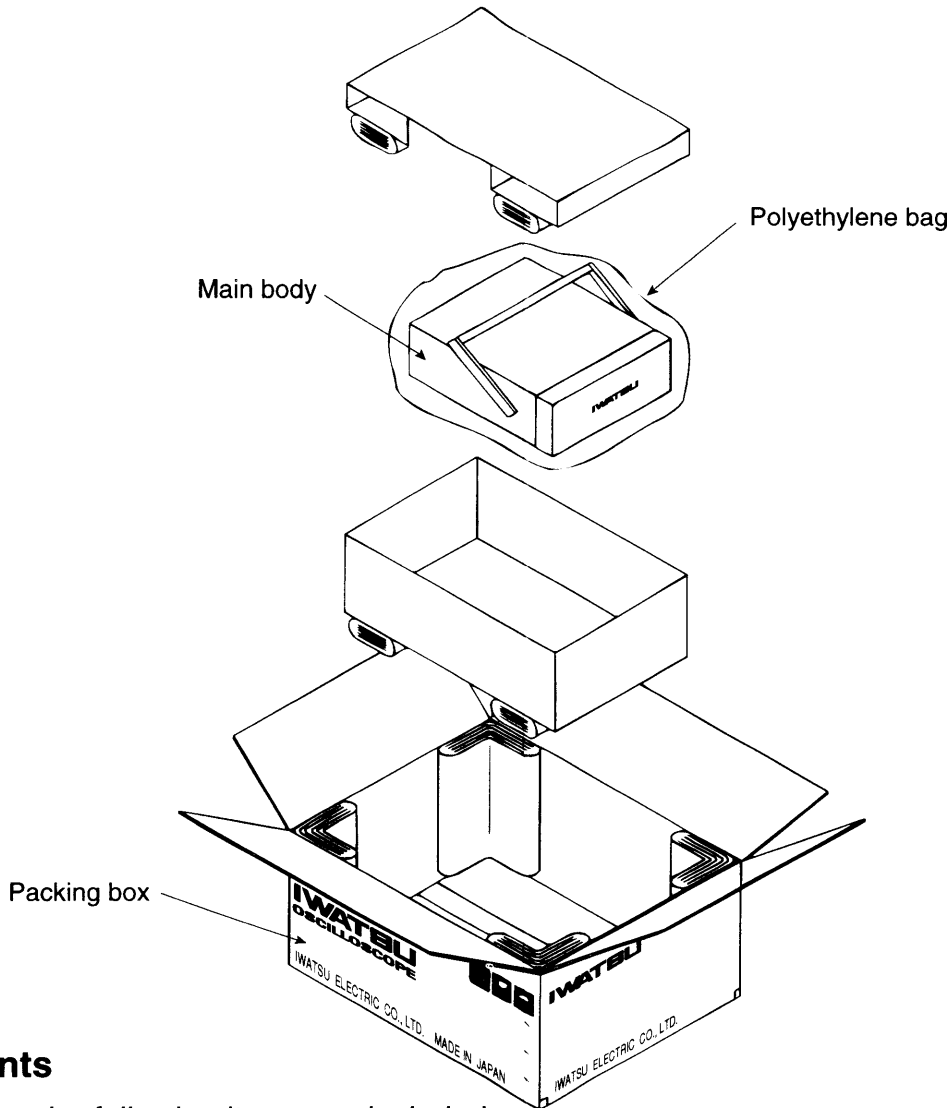

Components

Check that the following items are included:

- SS-7821/7811/7810/06 1
- Accessories
 - Power cord (three-core type) 1
 - Probe (10:1) 2
 - For SS-7821 : SS-082R
 - For SS-7811/10/06 : SS-0130R
 - Front cover 1
 - Fuse 2
 - Instruction manual 1

Replacement of built-in battery

- The built-in battery is not commercially available. Please contact your nearest sales representative to obtain a replacement.
- If the battery is exhausted, the setup conditions are initialized when the power is turned on.

Memo

Section 1. Controls, Connectors and Indicators

1.1 Front panel

See Figure 1.1.1.

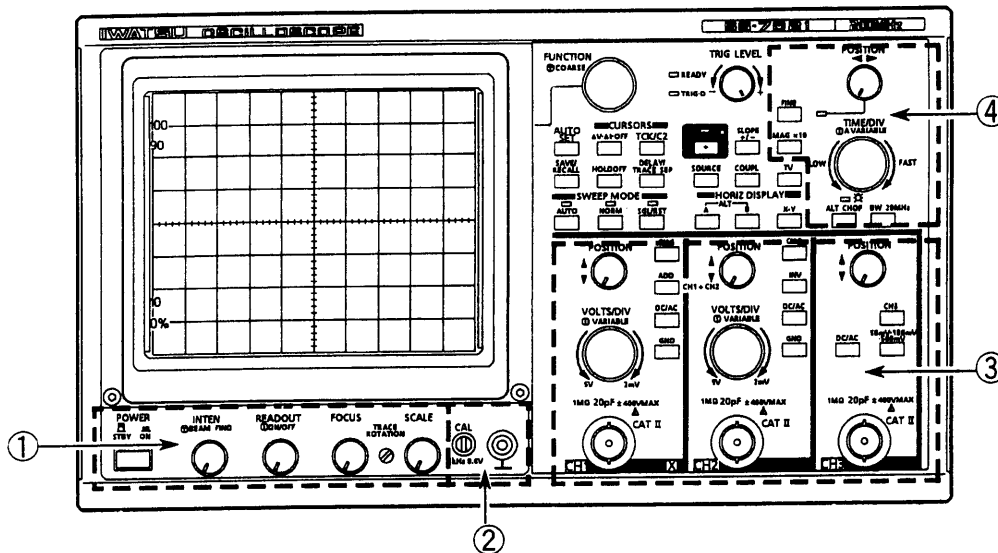

Figure 1.1.1 Front Panel I

① Adjustment of the power source and screen

- POWER** : Used to set the AC power source to ON/STBY.
- INTEN** : Adjusts the intensity of traces (refer to "2.3 Display Adjustment").
- READOUT** : Adjusts the intensity of characters (refer to "2.3 Display Adjustment").
- FOCUS** : Adjusts the focus (refer to "2.3 Display Adjustment").
- SCALE** : Adjusts the intensity of the scale (refer to "2.3 Display Adjustment").
- TRACE ROTATION** : Adjusts the rotation of traces (refer to "2.3 Display Adjustment").

② Calibration voltage output and grounding terminals

CAL connector : Outputs calibration voltage signals. This terminal is used for operation check of this instrument and adjustment of probe waveform (refer to "2.1 Displaying CAL Signal with AUTO SET").

⊥ (grounding) connector : This is the grounding for measurement.

③ Vertical axis

INPUT connectors (CH1 to CH3) : Connections for input signals.

- VOLTS/DIV** (CH1, CH2) : Select the voltage deflection factor (refer to "2.5.1 Deflection Factor").
- 50mV, 100mV, 500mV** (CH3) : Selects the voltage deflection factor (refer to "2.5.1 Deflection Factor").
- POSITION** (CH1 to CH3) : Move the position in the vertical direction (refer to "2.4 Vertical and Horizontal Positioning").

DC/AC (CH1 to CH3), **GND** (CH1, CH2) : Select the input coupling (refer to "2.5.2 Input Coupling").

CH1, **CH2**, **CH3** : Select the channel to be displayed on the screen (refer to "2.5.3 Display Channels").

ADD : Displays the sum of CH1 and CH2 (refer to "2.5.5 Sum (ADD) and Difference (INV)").

INV : Displays the input of CH2 in reversal (refer to "2.5.5 Sum (ADD) and Difference (INV)").

④ Horizontal section, etc.

TIME/DIV : Selects the sweep rate (refer to "2.6.1 Sweep Rate").

POSITION, **FINE** : Move the position in the horizontal direction (refer to "2.4 Vertical and Horizontal Positioning").

MAG x 10 : Magnifies ten times horizontally (refer to "2.6.2 Magnification").

ALT CHOP : Selects ALT or CHOP (refer to "2.5.4 ALT and CHOP").

BW 20MHz : Limits the bandwidth (refer to "2.5.6 Bandwidth Limitation").

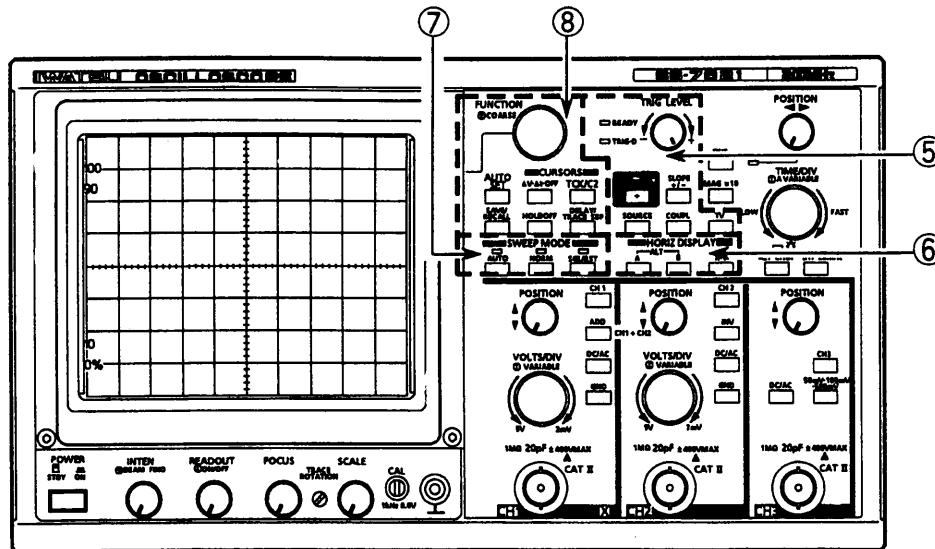

Figure 1.1.2 Front Panel II

⑤ **Trigging section**

- AB** : Selects A sweep or B sweep (refer to 2.11 Delayed Sweep). The indicator lights when B sweep is selected.
- TRIG LEVEL** : Selects the trigger level (refer to "2.8.4 Trigger Level").
- SLOPE** : Selects the trigger slope (+, -) (refer to "2.8.3 Trigger Slope").
- SOURCE** : Selects the trigger signal source (**CH1**, **CH2**, **CH3**, **LINE**, **VERT**), (refer to "2.8.1 Trigger Source").
- COUPL** : Selects the trigger coupling mode (**AC**, **DC**, **HF REJ**, or **LF REJ**) (refer to "2.8.2 Trigger Coupling").
- TV** : Selects triggering with TV (**BOTH**, **ODD**, **EVEN**, or **TV-H**) (refer to "2.8.5 TV Signal").
- TRIG'D** indicator : Lights when a trigger pulse has been generated.
- READY** indicator : Lights while waiting for signals.

⑥ **– HORIZ DISPLAY –**

- A** , **B** , **X-Y** : Select the display mode (refer to "2.9 Horizontal Display"). **ALT** sweep can be selected by pressing **A** and **B** simultaneously.

⑦ **– SWEEP MODE –**

- AUTO** , **NORM** : Select repetitive sweep (refer to "2.7.1 Repetitive Sweep").
- SGL/RST** : Selects single sweep (refer to "2.7.2 Single Sweep").

⑧ **FUNCTION, AUTOSET, etc.**

- AUTO SET** : Measuring conditions are set automatically. (refer to "2.1 CAL wave display with AUTO SET.")
- FUNCTION** : The delay time, cursor position, etc. can be set by turning or pressing this knob. Fine adjustment can be effected by turning this knob. Coarse adjustment in the direction this knob has been turned so far can be effected each time this knob is pressed or continuously held down.
- CURSORS –**
 - ΔV-Δt-OFF** : Selects Δt (time difference measurement), ΔV (voltage difference measurement), or **OFF** (release of measurement) (refer to "Section 3. Cursor Measurement and Counter").
 - TCK/C2** : Selects the type of cursor to be moved (**Clor C2** or **tracking**) (refer to "Section 3. Cursor Measurement and Counter").
- SAVE/RECALL** : Selects Save or Recall (refer to "Section 4. Save/Recall").
- HOLDOFF** : Selects **HOLDOFF** (refer to "2.12 Holdoff").
- DELAY/TRACE SEP** : Selects **DELAY** (refer to "2.11 Delayed Sweep") or **TRACE SEP** (refer to "2.10 Trace Separation").

1.2 Rear panel

See Figure 1.2.1.

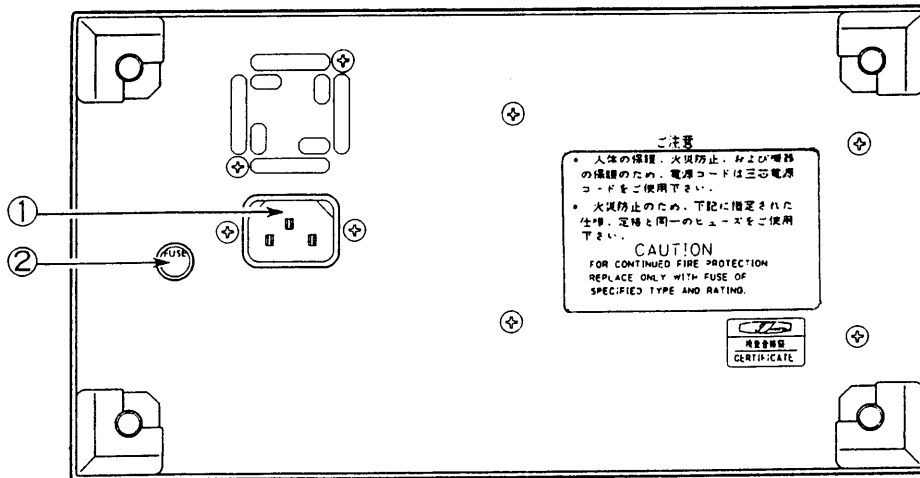

Figure 1.2.1 Rear Panel

① AC LINE INPUT

Connect the power cord to this receptacle.

② FUSE

φ 5 x 20 mm, 250 V, 2 A fuse.

Section 2. Basic Operation

Cautions

- **Be sure to connect or remove the power cord after setting the power switch to STBY.**
- **Use this instrument with the rated AC power supply.**
 - Voltage range : 100 to 120 VAC
 - Frequency : 50/60 Hz
 - Power consumption : 110 VA max.
- **Be sure to use a 3-core power cord appropriate to the supply voltage.**
- **Do not place any object in the vicinity of the air hole or fan of this instrument.**
- **Use this instrument within the rated operating range.**
 - Temperature: 0 to +40 °C, humidity: 90%RH (at 40 °C)
- **Power is applied to this instrument if the power switch is set to STBY. Disconnect the power cord from the receptacle if the instrument is not to be used for a long time.**
- **Do not apply voltage to the input terminal exceeding the posted rating.**
 - CH1, CH2, CH3 input
 - Direct : ± 400 V max.
 - With the SS-082R/SS-0130R (10 : 1) or equivalent : ± 600 V max.
 - [Note] The maximum input voltage derates depending on frequency and high voltage pulse of an input signal.
- **Do not raise trace or character intensity beyond what is necessary.**
 - This instruction is for two purposes: 1) to protect the user's eyes from eye strain and fatigue, and 2) to protect the CRT from burn-in.

General

Perform basic operation using CAL output and a signal generator so as to become familiar with this instrument. The Iwatsu FG-350 is used for the signal generator.

◇ Symbols on the panel

-  Warning symbol
This symbol calls the users' attention to the description in the instruction manual. This symbol is marked near the CH1, CH2, and CH3 INPUT terminals.

◇ Symbols in the instruction manual

Expression of keys and knobs

-  : Indicates a key.
-  : Indicates a knob.

◇ Power switch

-  : Indicates a state wherein this instrument is ready for ON operation with power supplied to every circuit.

-  : Indicates a standby state of this instrument wherein the STBY main power supply is off. When AC power is connected to AC LINE INPUT, power is supplied to the only microprocessor in this instrument. When AC power is not connected to AC LINE INPUT, panel setup conditions are backed up by the built-in battery.

◇ How to read the screen

- Main contents of display

A SWEEP RATE		A TRIGGER SOURCE		A TRIGGER SLOPE		A TRIGGER COUPLE		A TRIGGER LEVEL		HOLDOFF TIME		
B SWEEP RATE		B TRIGGER SOURCE		B TRIGGER SLOPE		B TRIGGER COUPLE		B TRIGGER LEVEL		DELAY TIME		
										FUNCTION MODE		
Measurement of ΔV or Δt										Frequency measured		
CH1	Range	Coupling	Setting of ADD	CH2	INV	Range	Coupling	CH3	Range	Coupling	Sweep enlargement	Limit of bandwidth

- An example of the display

A	10 μ s	CH1	+ DC	- 1.00mV	HO : 100%
B	1 μ s	CH2	- DC	3.00mV	DLY 99.00 μ s
					f:B-DELAY
A	$\Delta t = 5.00 \mu$ s	$1/\Delta t = 200.0$ kHz	f = 200.00 kHz		
1:	100mV +	2: ↓ 200mV	3: 500mV ⊥	MAG BW	

◇ Loading effect of the probe

If a cable, etc. is directly connected to the circuit under measurement, the input impedance of the measuring instrument works as a load and may cause hindrance in measurement. The RC of this unit is "1 M Ω , 20 pF." If a 10:1 probe is used, it becomes the following value, where the loading effect is largely reduced and highly accurate measurement is enabled.

SS-7821 : 10 M Ω , 13 pF
 SS-7811 : 10 M Ω , 12.5 pF

◇ Grounding

Connect the measurement grounding terminal (left side of CH1 INPUT) to GND of the circuit being measured. Grounding is particularly important to measure high-frequency signals accurately. Connect the grounding lead of the probe as closely as possible to the grounding terminal near the signals.

◇ Settings when power is set STBY or OFF *1

When power is set STBY or OFF, the panel setup immediately before such setting is stored. When power is turned on again, operation restarts with the panel setup immediately before the setting to STBY or OFF. When power is set to OFF, the panel setup is backed up by the built-in batteries.

*1 The state where the power cord is disconnected.

2.1 Displaying CAL Signal with AUTO SET

Display the CAL waveform (1 kHz, 0.6 V square wave) on CH1 using the AUTO SET function of this instrument.

Operating method

Procedures

- ① Press **POWER** to turn on the power.
 - Traces, characters, or both are displayed on the screen.
- ② Connect the **CH1 input connector and CAL connector with the attached probe.**

Connector of probe → CH1 signal input connector
 Tip of probe → CAL connector

- ③ Press **AUTO SET**.

- ← • The CAL waveform is displayed on the screen.
- If the CAL waveform does not appear, adjust the intensity (refer to "2.3 Display Adjustment").

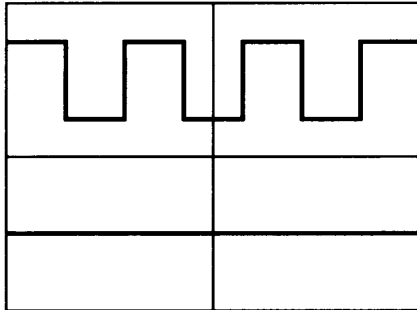

◇ AUTO SET function

- Press **AUTO SET** in a state such that "the size of signal is unknown, frequency is unknown, or operation mode is unknown." This instrument automatically selects the measurement conditions suitable for observation (as listed below), based on the amplitude and/or frequency of the input signal and the waveform is displayed on the screen.
- Sometimes suitable measurement conditions cannot be found depending on the frequency, amplitude, and/or duty ratio of the input signal.

◇ Measurement conditions of AUTO SET

Vertical deflection system	Triggering
Deflection factor VOLTS/DIV : 2 mV to 5 V/div with an amplitude of approx. 2 to 7 div at frequencies between 50 Hz to 50 MHz VARIABLE : OFF (CAL)	A/B : A SOURCE : Detected in the order of CH1 and CH2 COUPL : DC TV : OFF SLOPE : + LEVEL : About 0 div
Display channel CH1 : Former setting *1 CH2 : Former setting *1 CH3 : OFF (non display) *1 CH1 alone is set to ON if both CH1 and CH2 have been set to OFF.	Horizontal deflection system HORIZ DISPLAY : A
POSITION In case of 1-channel display : In the middle In case of 2-channel display CH1 : About + 2 div CH2 : About - 2 div	Sweep rate • SS-7821 20 ms to 10 ns/div, approx. 2.5 to 5 cycles • SS-7811 20 ms to 20 ns/div, approx. 2.5 to 5 cycles VARIABLE : OFF
AC/DC : AC GND : OFF (GND released) ALT/CHOP : CHOP CH2 INV : OFF BW 20 MHz : OFF (no limits on bandwidth)	SWEEP MODE : AUTO POSITION : Sweep starts display type a position near the left end of the screen.

2.2 Probe Compensation

Adjust the waveform on the attached probe. Be sure to confirm that the waveform of the probe is compensated correctly before using the probe.

Operating method

Procedures

① **Set this unit as follows:**

CH1 VOLTS/DIV : 10 mV
 GND : OFF (GND released)
 AC/DC : DC
 SOURCE : CH1
 SEC : 200 μ s

② **Take triggering by turning [TRIG LEVEL] .**

③ **Adjust the waveform by turning the variable capacitor of the probe with a screwdriver.**

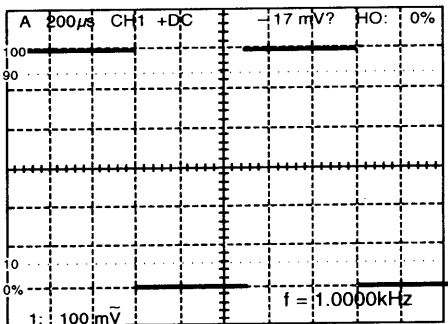

← • Correctly compensated waveform

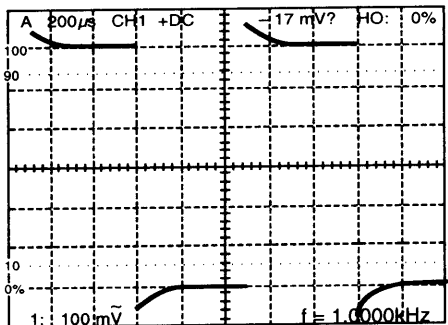

← • Over compensated waveform

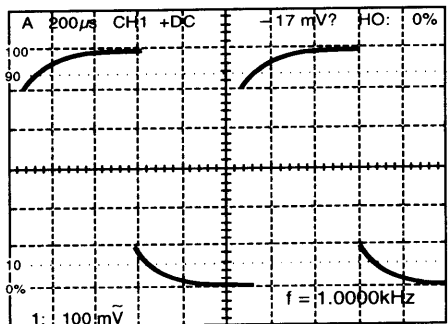

← • Under compensated waveform

◇ **Probe sense (display of deflection factor)**

When the probe has a probe sense function, the voltage as compensated by the attenuation ratio of the probe is displayed.

2.3 Display Adjustment

Adjust the brightness (**INTEN**), displayed characters (**READOUT**), focus (**FOCUS**), intensity of scales (**SCALE**), and rotation of traces (**TRACE ROTATION**).

Operating method

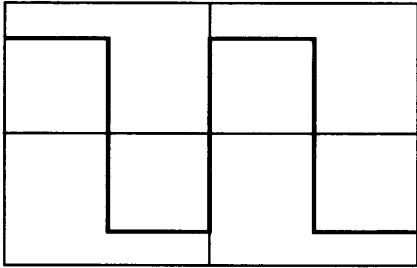

Procedures

← ① Adjust the brightness of traces by turning **[INTEN]** .

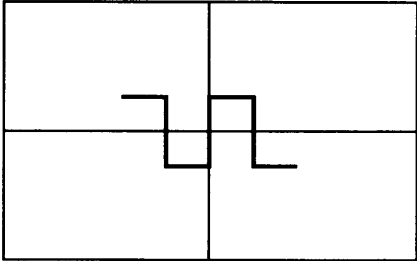

← ② Press **[INTEN (BEAM FIND)]** .

- Compresses the vertical and horizontal deflection to within the graticule area.
- Return to the original state after confirmation.

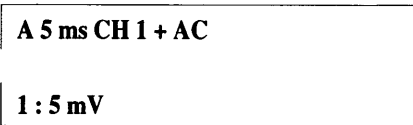

← ③ Adjust the brightness of displayed characters by turning **[READ OUT]** .

- ON/OFF is switched each time **[READ OUT]** is pressed.

④ Adjust the focus of traces and displayed characters by turning **[FOCUS]** .

- ◇ Use **[FOCUS]** to adjust when the brightness of the trace has been turned up too far.
- ◇ When the difference in brightness between the (READOUT) and (TRACE) becomes too large, the focus of both will become blurred. Turn **[INTEN]** or **[READ OUT]** to adjust to the same brightness.
- ◇ When the brightness of SS-7821 is increased, the focus is automatically corrected.
- * And then READ OUT intensity brighten and intensity difference between TRACE and READ OUT is decreased.

⑤ Adjust graticule illumination by turning **[SCALE]** .

- Perform step ⑥ and ⑦ if trace is inclining due to earth magnetism, etc.

← ⑥ Set the input coupling of CH1 to **GND** by pressing **[GND]** .

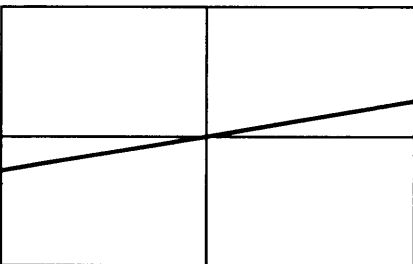

← ⑦ Correct the inclination of the trace by turning **TRACE ROTATION** on the front panel with the attached adjustment screwdriver.

- Return the input coupling to the original setting after correcting the inclination.

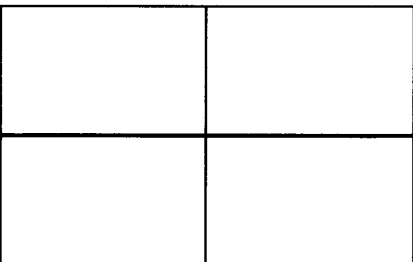

2.4 Vertical and Horizontal Positioning

Adjust the vertical and horizontal positions. This function is used to move the waveform to a position where it can be observed easily or when performing comparative measurement of two or more waveforms by laying one waveform on another.

Operating method

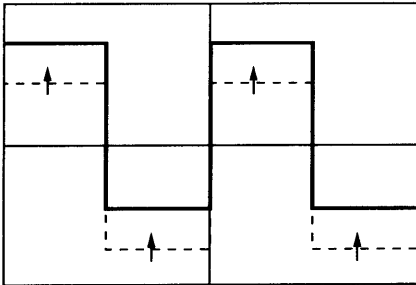

- Procedures**
Moving vertical positions
- ← ① Turn [▲POSITION▼] of CH1 to the right; the waveform moves upward.
 - ② Turn [▲POSITION▼] of CH1 to the left; the waveform moves downward.
 - ◇ Perform the same operation on CH2 and CH3 as well.

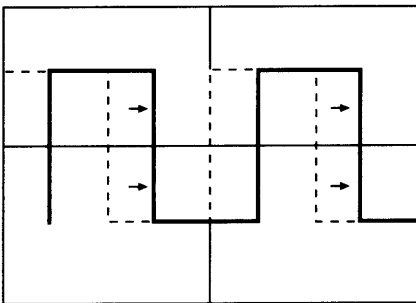

- Procedures**
Moving horizontal positions
- ← ① Turn [◀POSITION▶] to the right; the waveform moves to the right.
 - ② Turn [◀POSITION▶] to the left; the waveform moves to the left.
 - ③ The FINE indicator lights or goes off every time [FINE] is pressed.
 - Fine adjustment is accomplished when [◀POSITION▶] is turned while the FINE indicator is lighted. If [◀POSITION▶] is fully turned in this case, the waveform scrolls. To stop scrolling in the middle, return [◀POSITION▶] slightly.

2.5 Vertical Deflection System

2.5.1 Deflection Factor

Set the amplitude of waveform to a size suitable for viewing.

a. CH1 and CH2

Operating method

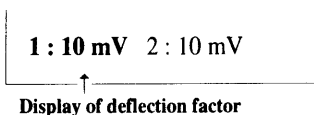

- Procedures**
Setting the TIME/DIV
- ← ① Select the deflection factor by turning [VOLTS/DIV] of CH1.
 - The deflection factor can be selected with a range of 2 mV/div to 5 V/div (in 1-2-5 steps).
 - The deflection factor is displayed in the lower lefthand corner of the screen.
 - [Note] Do automatic calibration if traces move upward or downward when the range has been switched (refer to "Section 5. Daily Inspection").

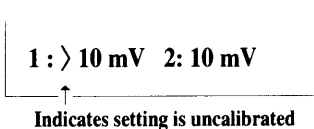

- Procedures**
Setting the VARIABLE
- ← ② Press [VOLTS/DIV] of CH1; the deflection factor is displayed with ">" mark.
 - Fine adjustment can be performed using this screen.
 - ③ Turn [VOLTS/DIV] of CH1; the deflection factor varies continuously between steps.
 - "CH1 VAR LIMIT" is displayed when the set value reaches the maximum or minimum value.
 - To release the variable setting mode, delete ">" by pressing [VOLTS/DIV] again.
 - ◇ Perform the same operation on CH2 as well.

b. CH3



- Procedures**
- ← ① Select the deflection factor by pressing [50 mV - 100 mV - 500 mV] of CH3.
 - One of the three ranges of 50 mV/div, 100 mV/div, and 500 mV/div can be selected. Fine adjustment is not available.

2.5.2 Input coupling

Select a coupling mode suitable for observation according to the type of input signal.

Operating method

Procedures

Setting GND

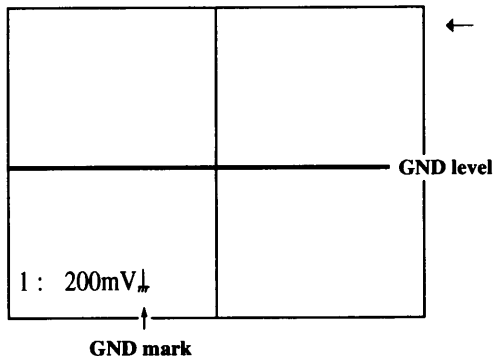

① Set GND to ON by pressing **GND** of CH1 (the GND mark is displayed in the lower left hand corner on the screen).

- The input section of the vertical amplifier is connected to GND and a trace (grounding potential) is displayed.
- CH3 has no GND.

[Note] Do automatic calibration if there is a difference display type the actual grounding potential at the time of connection to GND (refer to "Section 5. Daily Inspection").

Setting DC or AC

① Set GND to OFF (GND released) by pressing **GND** of CH1.

② Set DC or AC by pressing **DC/AC** of CH1.

- Perform the same operation on CH2 as well.

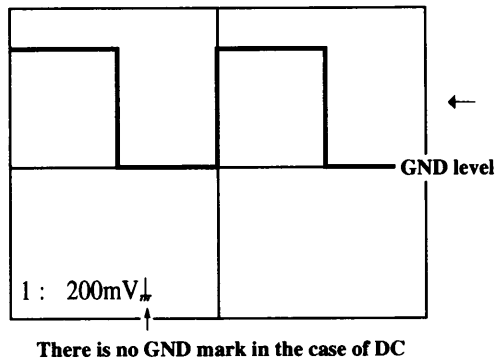

◇ DC

- The DC and AC components of the input signal are displayed.
- The CAL waveform is displayed on the basis of the GND level.

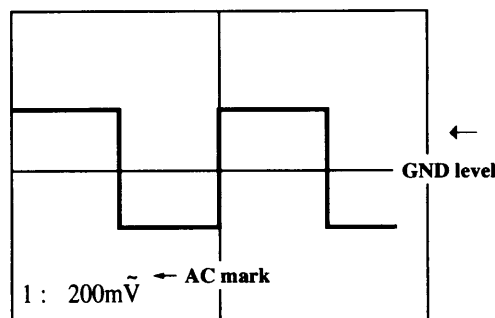

◇ AC

- The AC component only of the input signal is displayed with the DC component cut.
- The CAL waveform is displayed on the middle of the average potential.
- Character "V." is displayed with the "~" mark on the top.

2.5.3 Display channels

Signals input to CH1, CH2, or CH3 are displayed.

Operating method

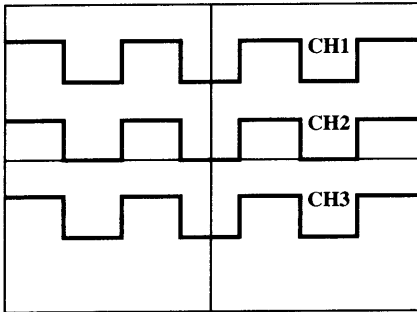

1: 10 mV

Procedures

① Select ON (display) or OFF (non display) of each channel by pressing **CH1**, **CH2**, or **CH3**.

- An example where **CH1**, **CH2**, and **CH3** are set to ON is shown on the left.

◇ The signals applied to INPUT of the channels set to ON are displayed on the screen. The signal applied to a channel that is set to OFF disappears display type the screen.

◇ The channel No., VOLTS/DIV, and input coupling of the channels set to ON are displayed in the lower left corner of the screen. Those of a channel that is set to OFF disappear display type the screen.

[Note] When all channels (CH1, CH2, CH3, and ADD) are set to OFF, CH1 is displayed.

2.5.4 ALT and CHOP

Select the display mode (ALT, CHOP) when two or more channels are displayed.

Operating method

Procedures

① Select two or more channels display type CH1, CH2, and CH3 (refer to "2.5.3 Display Channels").

② Select **ALT** or **CHOP** (the indicator lights) by pressing **ALT CHOP**.

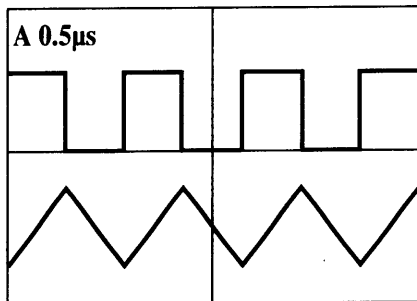

A 0.5μs

◇ **ALT (alternate)**

- Two or more input signals are swept alternately.
- This mode is suitable for observing high-frequency signals on two or more channels.

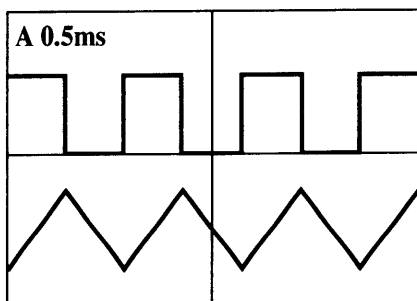

A 0.5ms

◇ **CHOP (chop)**

- Two or more input signals are switched at frequency of approx. 555 kHz.
- This mode is suitable for observing low-frequency signals on two or more channels.

2.5.5 Sum (ADD) and difference (INV)

Add two channels (CH1 + CH2) or subtract one channel display type another (CH1 - CH2). Addition or subtraction can be selected by selecting ADD and then setting INV.

Operating method

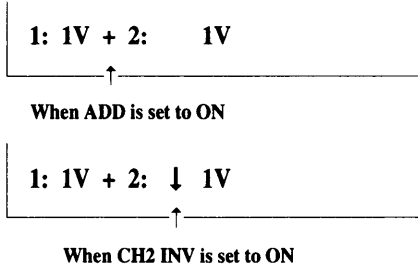

Procedures

- ① Set CH1 and CH2 to ON (display) (refer to "2.5.3 Display Channels").
- ← ② Set ADD to ON by pressing **ADD** ("+" is displayed in the lower left corner of the screen).
 - A waveform in which two signals are added (CH1 + CH2) is displayed on the screen.
- ← ③ Set INV to ON by pressing **INV** ("↓" is displayed in the lower left corner of the screen).
 - The polarity of CH2 is inverted and a waveform in which one signal is subtracted display type another (CH1 - CH2) is displayed on the screen.

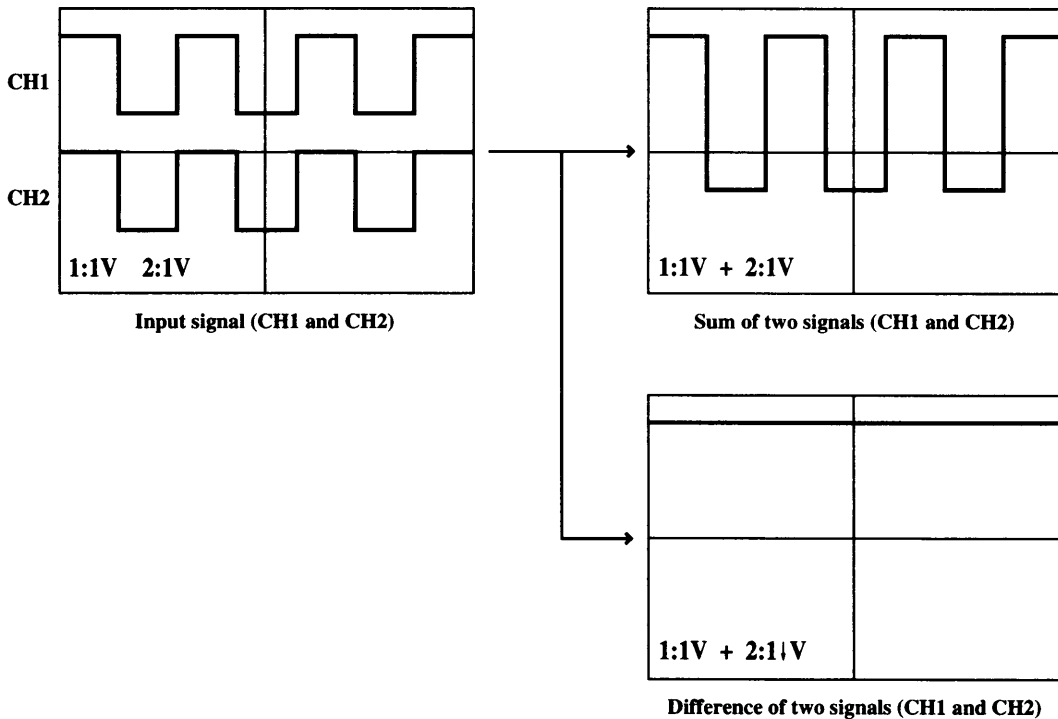

2.5.6 Bandwidth Limiter (BW 20MHz)

Observation with reduced high-frequency noises is enabled by limiting the frequency bandwidth to approx. 20 MHz.

Operating method



Procedures

- ① Select BW 20MHz by pressing **BW 20MHz**.
 - BW is displayed in the lower righthand corner of the screen.

2.6 Sweep Rate and Magnification

2.6.1 Sweep Rate

Select the sweep rate (TIME/DIV) of A sweep or B sweep.

Operating method

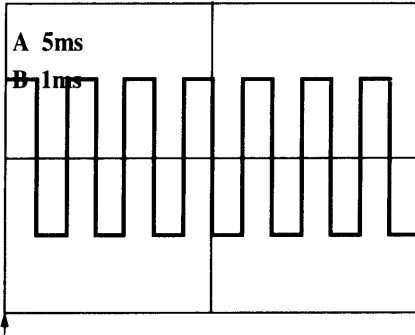

Sweep start point (for magnification/reduction reference point)



Procedures

Selecting *A/B sweep*

- ① Select A sweep or B sweep (the indicator lights) by pressing **AB**.

Setting the TIME/DIV

- ② Select the sweep rate by turning **TIME/DIV**.

- The sweep rate is displayed in the upper lefthand corner of the screen.
- The waveform is magnified or reduced on the basis of the sweep start point.
- Proceed to step ③ for performing fine adjustment (on A sweep rate alone).

Setting the VARIABLE

- ③ Press **TIME/DIV**; the uncalibrated ">" sweep rate is displayed in the upper left corner of the screen.

- ④ Turn **TIME/DIV**; the sweep rate varies continuously between steps.

- "VAR LIMIT" is displayed when the set value reaches the maximum or minimum value.
- To release the variable setting mode, press **TIME/DIV** again to delete ">".

2.6.2 Magnification

Magnify the waveform by 10 times as the reference on the center line.

Operating method

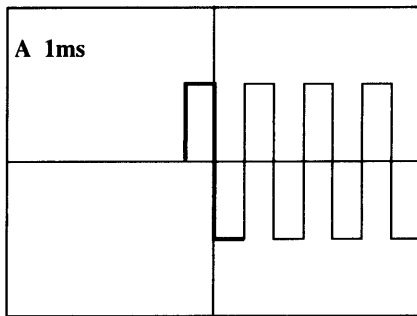

Center line (magnification reference point)

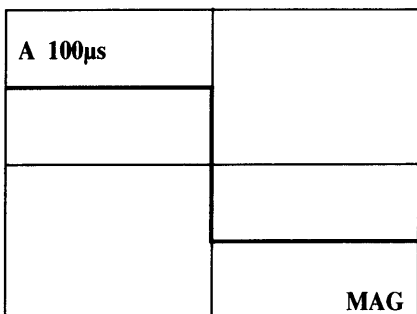

Procedures

- ① Set the sweep rate using **TIME/DIV**. (refer to "2.6.1 Sweep Rate").

- ② Set the position of the waveform to be magnified to the center of the screen.

- The portion indicated by thick lines is magnified.

- ③ Press **x 10 MAG**.

- The sweep rate is increased by 10 times and the waveform is magnified to the left and right from the center line of the screen.
- MAG is displayed in the lower right corner of the screen.

2.7 Sweep Mode

Select the sweep mode (AUTO, NORM, or SINGLE).

2.7.1 Repetitive sweep

Select AUTO or NORM.

Operating method

Procedures

① Select repetitive sweep by pressing **AUTO** or **NORM** in the SWEEP MODE.

- The AUTO indicator lights when AUTO is selected and NORM indicator, when NORM is selected.
- If triggering is not set, set triggering by adjusting **TRIG LEVEL**, etc.
Refer to "2.8 Triggering" for details.

AUTO (automatic sweep)

- Take triggering by adjusting the trigger level. If no triggering is set, automatic sweep takes place.
- When the frequency of the trigger signal is approx. 10 Hz or less at a sweep time between 500 ms and 10 ms/DIV, or approx. 50 Hz or less at a sweep time of 5 ms/DIV or more, triggering may become unstable. In this case, take triggering by NORM.

NORM (normal sweep)

- Take triggering by adjusting the trigger level. If no triggering is set, no sweep occurs.
- Only when the trigger source is CH1 or CH2 and the input coupling is GND at the same time, automatic sweep takes place.

With this function, the position of GND can be confirmed easily.

2.7.2 Single sweep

Select single sweep.

Operating method

Procedures

① Select single sweep by pressing **SGL/RST** in the SWEEP MODE (the SGL/RST indicator lights).

- The READY indicator lights to indicate the state waiting for signal input.
- ◇ Sweep is effected once when a trigger signal is generated.
- The READY indicator goes off.
- In the CHOP mode, all channels are swept simultaneously.
- In the ALT mode, only one channel is swept.

② To perform another single sweep, press **SGL/RST** again.

2.8 Triggering

This is the operation to enable observation of input signals in a stable state on the screen.

2.8.1 Trigger Source

Select the trigger source.

Operating method

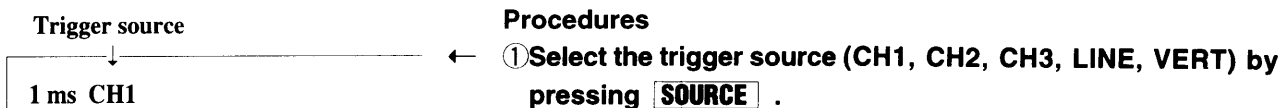

CH1 : Use the signal input to CH1 as the trigger source.

CH2 : Use the signal input to CH2 as the trigger source.

CH3 : Use the signal input to CH3 as the trigger source.

LINE : The power source is used as the trigger source. This is suitable for observation of signals triggered with the power frequency.

VERT : The signal input to the low channel numbers of the channels displayed on the screen are used as the trigger signal source. However, when (ADD) is selected, the trigger sources used are shown in Table 2.

Table 1 When ADD is not used

Displayed channels	Trigger source
CH1	CH1
CH2	CH2
CH3	CH3
CH1, CH2	CH1
CH1, CH3	CH1
CH2, CH3	CH2
CH1, CH2, CH3	CH1

Table 2 When ADD is selected

Displayed channels	Trigger source
ADD	CH1
CH1, ADD	CH1
CH2, ADD	CH2
CH3, ADD	CH1
CH1, CH2, ADD	CH1
CH1, CH3, ADD	CH1
CH2, CH3, ADD	CH2
CH1, CH2, CH3, ADD	CH1

2.8.2 Trigger Coupling

Select the the trigger coupling mode.

Operating method

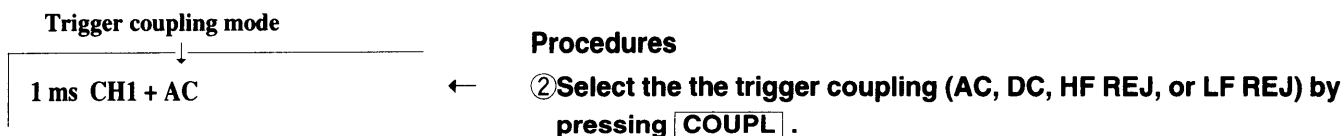

AC : Blocks the DC component of the trigger signal. The lower limit of frequency is 100 Hz.

DC : Pass all the signal components.

HF REJ : Attenuates the high frequency component (above 10 kHz). This mode is used when high-frequency noises are contained in the trigger source and the trigger may become unstable due to such noises.

LF REJ : Attenuates the low frequency component (below 10 kHz). This mode is used when low-frequency noises (hum of power frequency, etc.) are contained in the trigger source and the trigger may become unstable due to such noises.

2.8.3 Trigger Slope

Select the trigger slope.

Operating method

Trigger slope

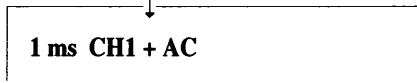

Procedures

① Select the slope (+ or -) by pressing **[SLOPE]**.

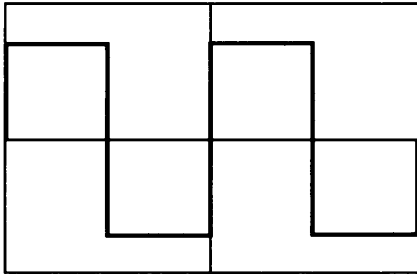

- +
Sweep starts at the rising edge of the waveform.

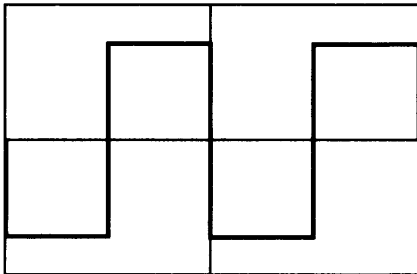

- -
Sweep starts at the falling edge of the waveform.

2.8.4 Trigger Level

Adjust the amplitude point on the trigger level.

Operating method

Trigger level

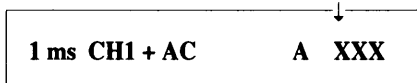

Procedures

① Adjust the trigger level by turning **[TRIG LEVEL]**.

- The TRIG'D indicator lights when the trigger signal is generated.
- Sometimes "?" is displayed to the right of the value displayed. This indicates that direct reading is impossible if AC coupling or VARIABLE is set.

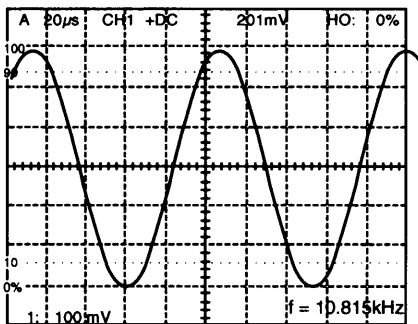

Turning **[TRIG LEVEL]** to right display type the midrange

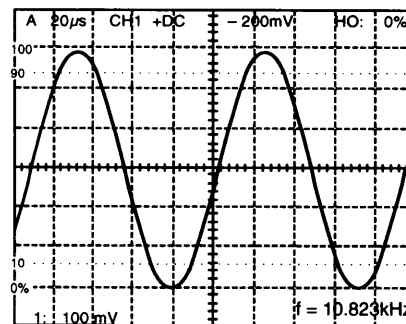

Turning **[TRIG LEVEL]** to left display type the midrange

2.8.5 TV Signal

Select the TV trigger mode

SS-7821 : NTSC, PAL (SECAM), HDTV

SS-7811 : NTSC, PAL (SECAM)

Operating method

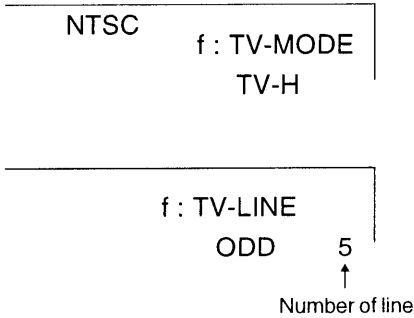

Procedures

- ① **Select the TV trigger mode (BOTH, ODD, EVEN, or TV-H) by pressing **[TV]**.**
 - Set the trigger slope to the same polarity of video synchronizing signal.
- ◇ **When TV-H is selected**
 - The function display changes into f:TV-MODE.
 - Select NTSC, PAL (SECAM), or HDTV by turning **[FUNCTION]**.
 - [Note] HDTV is for SS-7821 alone.
- ◇ **When BOTH, ODD, or EVEN is selected**
 - The function display changes into f:TV-LINE.
 - Select the line No. by turning **[FUNCTION]**.
 - Coarse adjustment in the direction it has so far been turned can be effected each time **[FUNCTION]** is pressed or when it is pressed continuously.

ODD : Triggering is set by selecting the number of horizontal synchronization signal display type the vertical synchronization signals of odd-numbered fields.

EVEN : Triggering is set by selecting the number of horizontal synchronization signal display type the vertical synchronization signals of even-numbered fields.

BOTH : Triggering is set by selecting the number of horizontal synchronization signal display type the vertical synchronization signals of odd-numbered or even-numbered fields.

TV-H : Triggering is set on a horizontal synchronization pulse.

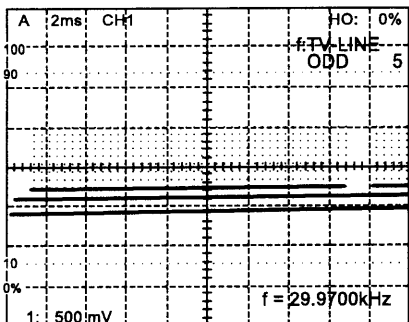

Triggering on a vertical synchronization pulse

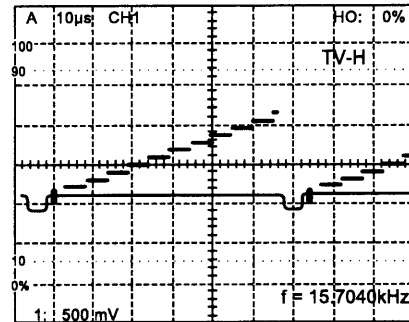

Triggering on a horizontal synchronization pulse

2.9 Horizontal Display

Select the horizontal display.

Operating method

Procedures

① Select A, B, ALT, or X-Y by pressing **A**, **B**, or **X-Y** in the **HORIZ DISPLAY** mode.

- To select ALT, press **A** and **B** simultaneously.

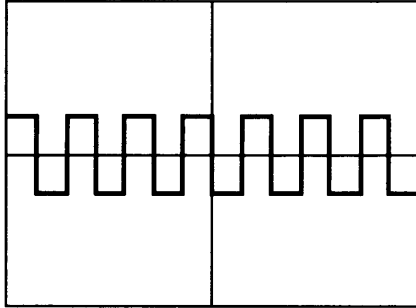

← **◇ A**
A sweep is displayed.

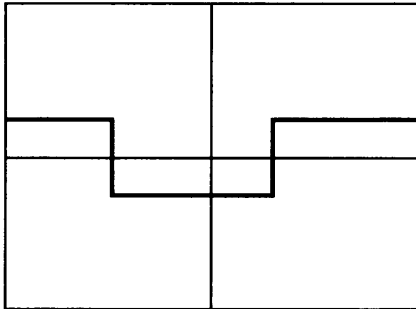

← **◇ B**

- B sweep (magnified waveform in ALT) is displayed.
- Refer to "2.11 Delayed Sweep" for details.

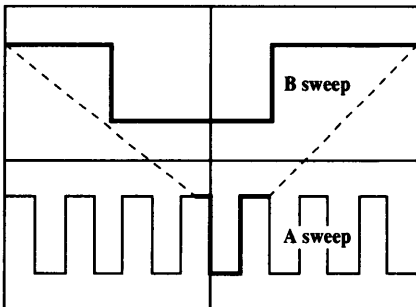

← **◇ ALT**

- A sweep (not magnified waveform) and B sweep (magnified waveform) are displayed simultaneously.
- Refer to "2.11 Delayed Sweep" for details.
- Vertical position of B sweep can be adjusted. B sweep is moved upward with respect to A sweep (refer to "2.10 Trace Separation").

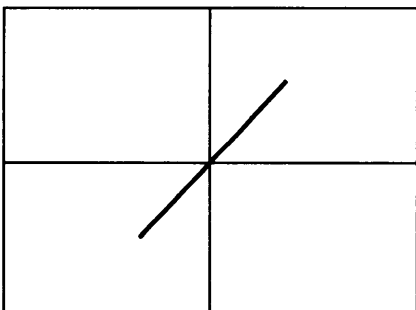

← **◇ X-Y**

- An X-Y display in which CH1 input is taken on the X axis and each channel (CH1, CH2, CH3, ADD) is taken on the Y axis is obtained.
- This mode is used for observation of hysteresis curves, Lissajous waveforms, etc.

2.10 Trace Separation

During ALT sweep, move the B-sweep waveform to a position suitable for observation.

Operating method

Procedures

Selecting ALT sweep

- ① **Select ALT** by pressing **A** and **B** in the **HORIZ DISPLAY** mode.

- A-sweep waveform and B-sweep waveform are displayed so that one is laid upon the other.

A sweep: ———

B sweep: - - - - -

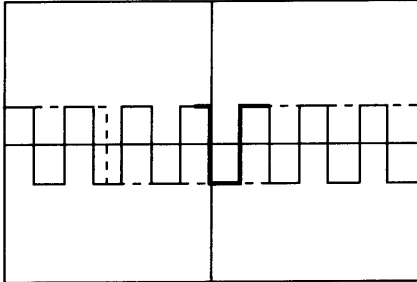

←

Moving the position of A and B waveform

- ② **Move the position of waveform to the lower area of the screen** by turning **[ΔPOSITION]**.

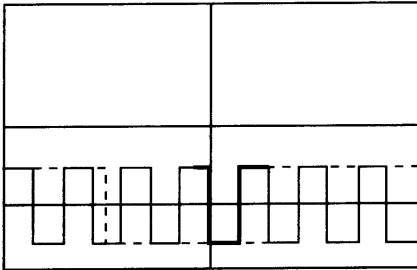

←

Selecting TRACE SEP

- ③ **Select TRACE SEP** by pressing **DELAY/TRACE SEP**.

- The function display changes into f : TR-SEP.

Function display → f : TR-SEP

←

Moving B waveform

- ④ **Move the vertical position of the B-sweep waveform** by turning **[FUNCTION]** (only upward movement is available).

- Coarse adjustment in the direction it has so far been turned can be effected each time **[FUNCTION]** is pressed or when it is pressed continuously.

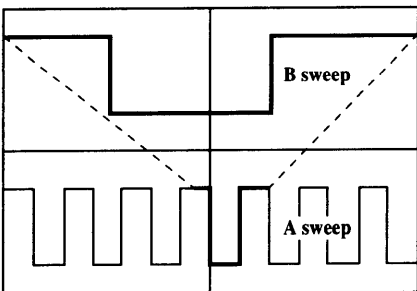

←

2.11 Delayed Sweep

Select the delayed sweep mode (continuous delay, triggered delay).

2.11.1 Continuous Delay

B sweep starts after a specified delay time has elapsed display type the sweep start point of A sweep. The desired portion of the waveform displayed can be displayed in magnified display type. This function is valid when HORIZ DISPLAY is set to ALT or B.

Operating method

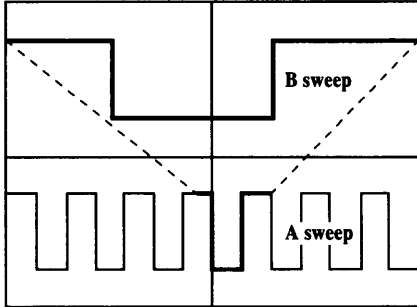

A 5ms CH1 + DC A level
 B 1ms - AC B level
 No display of trigger source B

Delay time → DLY nnn
 Function display → f : DELAY

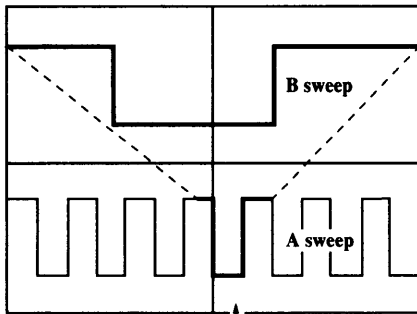

The intensity modulated portion moves continuously

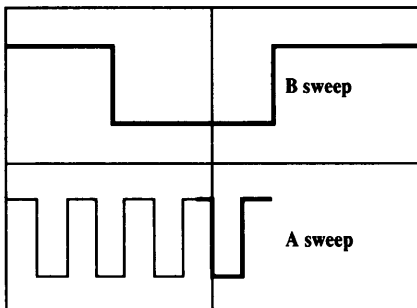

Procedures

Selecting ALT a sweep

① Select ALT by pressing **A** and **B** in the HORIZ DISPLAY mode.

- A sweep and B sweep are displayed.
- The intensity-modulated portion of A sweep (in the lower area of the screen) is magnified and displayed as B sweep (in the upper area of the screen).
- A sweep and B sweep are separated display type each other for convenience of explanation. For the method of separation, refer to "2.10 Trace Separation."

Selecting the B-sweep rate

② Select B by pressing **A B** (the B indicator lights).

③ Select the B-sweep rate by turning **[TIME/DIV]**.

- The ratio between A sweep and B sweep varies.
- The B-sweep rate cannot be set to a value slower than the A-sweep rate.

Selecting of continuous delay

④ Select the screen with no display of trigger source B by pressing **SOURCE**.

Selecting the delay time

⑤ Select DELAY by pressing **DELAY/TRACE SEP**.

- Function display changes into f : DELAY

⑥ Adjust the delay time by turning **[FUNCTION]**.

- Coarse adjustment in the direction it has so far been turned can be effected each time **[FUNCTION]** is pressed or when it is pressed continuously.
- Proceed to step ⑦ when performing B ENDS A.

Selecting B ENDS A

⑦ Select HOLDOFF by pressing **HOLDOFF**.

- For details of HOLDOFF, refer to "2.12 Holdoff."

⑧ Set the hold-off time to a value larger than 100% by turning **[FUNCTION]**; the B ENDS A mode is set.

- B ENDS A
 The portion of A sweep following the intensity-modulated portion (B sweep) is deleted. The frequency of sweep increases in proportion to the length of the deleted time and the intensity increases.

2.11.2 Triggered Delay

B sweep starts at the trigger point of B sweep after a specified delay time set display type the sweep start point of A sweep. Although the delay jitter can be reduced in this mode, the start point of B sweep is limited to the B trigger point.

Operating method

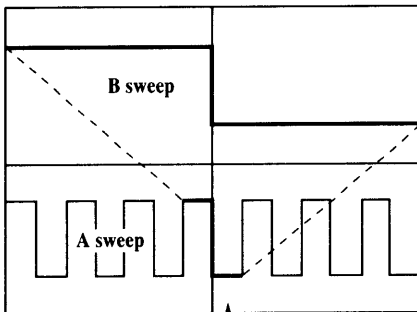
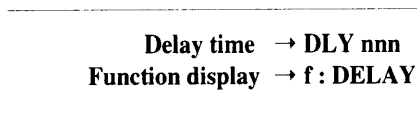
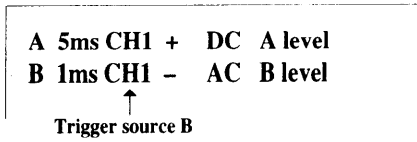

The intensity-modulated portion moves to the next trigger point.

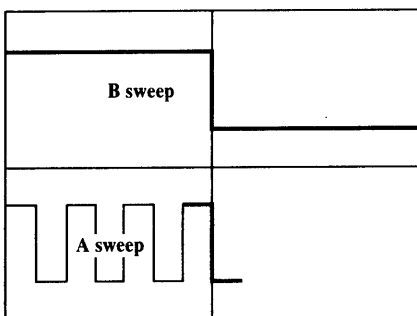

◇ The vertical position of B sweep is maintained until it is moved by setting the TRACE SEP mode again.

◇ The figure below shows the time relations for the case where CH2 is specified as the trigger source for B sweep in the triggered delay mode.

Procedures

① to ③ Same as those in "2.11.1 Continuous Delay."

Selecting of trigger delay

← ④ Select trigger source B by pressing **SOURCE**.

Triggering of B sweep

⑤ Take triggering of B sweep.

- The method for taking triggering is the same as that for A sweep (refer to "2.8 Triggering").

Selecting the delay time

← ⑥ Select **DELAY** by pressing **DELAY/TRACE SEP**.

- Function display changes into f: DELAY.

← ⑦ Adjust the delay time by turning **FUNCTION**.

- Coarse adjustment in the direction it has so far been turned can be effected each time **FUNCTION** is pressed or when it is pressed continuously.
- Although the DLY value varies continuously in the case of trigger delay, it is not in accord with the actual delay time. "<" is attached to the DLY value.
- Proceed to step ⑧ when performing B ENDS A.

Selecting B ENDS A

← ⑧ Select **HOLDOFF** by pressing **HOLDOFF**.

- For details of HOLDOFF, refer to "2.12 Holdoff."

← ⑨ Set the hold-off time to a value larger than 100% by turning **FUNCTION**; the B ENDS A mode is set.

- B ENDS A

The portion of A sweep following the intensity-modulated portion (B sweep) is deleted. The frequency of sweep increases in proportion with the length of the deleted time and the intensity increases.

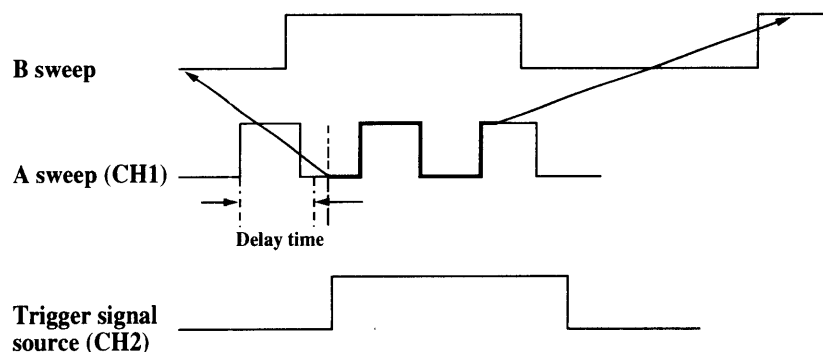

2.12 Holdoff

Sometimes triggering cannot be set in a stable manner when observing a pulse train made of complex combinations. In this case, adjust the holdoff (sweep pause) time so that a stable waveform can be obtained.

Operating method

HO : nn%
f : HOLDOFF

Procedures

- ① **Select HOLDOFF by pressing **HOLDOFF**.**
 - Function display changes into f : HOLDOFF.
- ② **Adjust the holdoff time by turning **FUNCTION**.**
 - Coarse adjustment in the direction it has so far been turned can be effected each time **FUNCTION** is pressed or when it is pressed continuously.
 - The holdoff time becomes the maximum value (100%) when **FUNCTION** is fully turned clockwise, and the minimum value (0%) when fully turned counterclockwise.
 - Usually, the holdoff time is set to 0%.

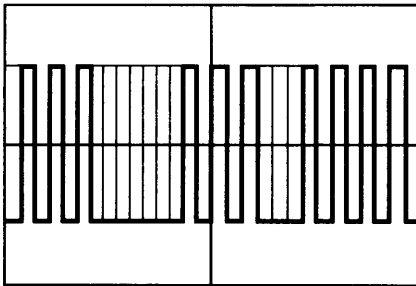

Waveform before adjustment (duplicated display)

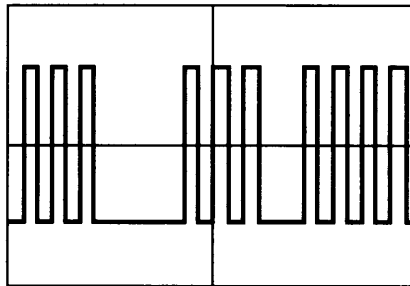

Waveform after adjustment

Section 3. Cursors Measurement and Counter

Measure the time difference and frequency (Δt , $1/\Delta t$) or voltage difference (ΔV) using cursors.

◇ Selecting measurement items

- Press **$\Delta V-\Delta t-OFF$** and select ΔV (voltage measurement) or Δt (time measurement).

◇ Cursor measurement

- Select Δt or ΔV to display the two measurement cursors.
- Turn **[FUNCTION]** to adjust cursor position.
Pressing or holding down **[FUNCTION]** performs a (COARSE) adjustment in the direction the dial has been turned so far.
- When **TCK/C2** is pressed, the movable cursor and "I" changes.
The cursors are cycled in the following sequence : C1 (cursor 1) → C2 (cursor 2) → TCK (tracking)

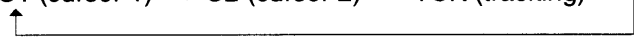

3.1 Time Difference (Δt) and Frequency ($1/\Delta t$)

Measure the time difference (Δt) and frequency ($1/\Delta t$).

Operating method

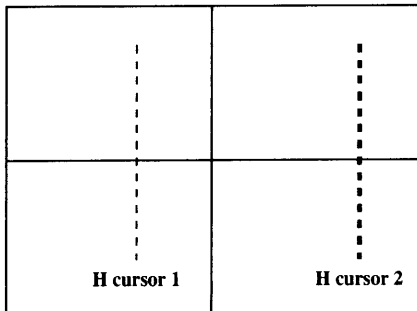

Symbol indicating cursor movement

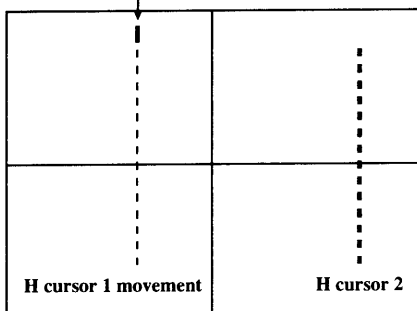

Procedures

- ← ① **Select Δt by pressing $\Delta V-\Delta t-OFF$.**
 - H cursor 1 and H cursor 2 are displayed.
 - The measurement results of Δt (time difference) between cursor 1 and cursor 2 and their frequency $1/\Delta t$ (frequency) are displayed in the lower left corner of the screen.
 - Move cursor 1 and cursor 2 to the measurement points and perform measurement.

Setting cursor 1

- ← ② **Select C1 (cursor 1) by pressing TCK/C2.**
 - The function display changes into f : H-C1.
- ← • The symbol "I" displayed above H cursor 1 indicates that the cursor can be moved.

- ③ **Turn [FUNCTION] to move H cursor 1 (I) to the measurement point.**

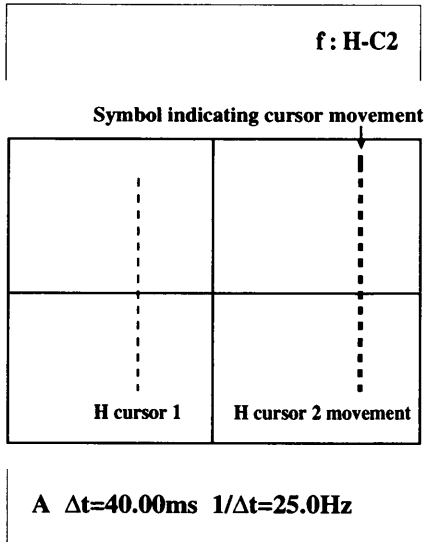

Setting cursor 2

- ← ④ **Select C2 (cursor 2) by pressing TCK/C2** .
- The function display changes into f : H-C2.
- ← • The symbol "I" displayed above H cursor 2 indicates that the cursor can be moved.

- ⑤ **Turn [FUNCTION] to move H cursor 2 (I) to the measurement point.**

- ← • The measurement results of the time difference between the newly set cursors and their frequency are displayed in the lower left corner of the screen.

Setting tracking

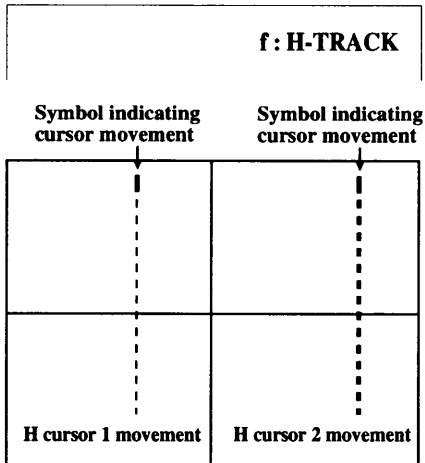

- ← ⑥ **Select TCK (tracking) by pressing TCK/C2** .
- The function display changes into f : H-TRACK.

- ← • The symbol "I" displayed above H cursor 1 and cursor 2 indicates that the cursor can be moved.

- ⑦ **Turn [FUNCTION] to move H cursor 1 and H cursor 2 to the measurement point .**

- ◇ **Release Δt measurement**
 Select OFF (no cursor displayed by pressing $\Delta V-\Delta t-OFF$.

3.2 Voltage Difference (ΔV)

Measure the voltage between the cursors.

Operating method

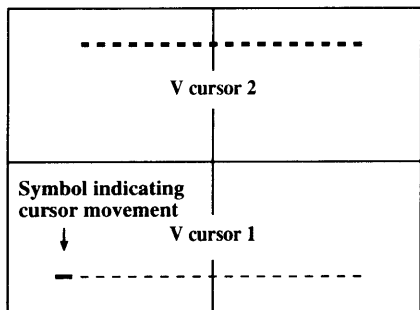
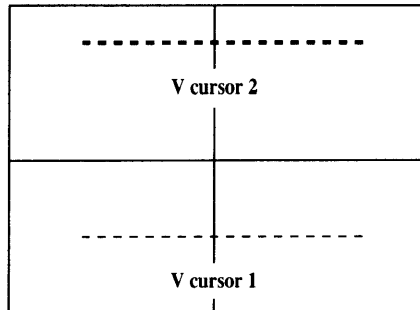

Symbol indicating cursor movement

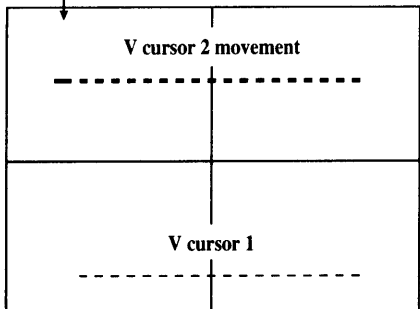

Procedures

- ← ① Select ΔV by pressing **$\Delta V-\Delta t-OFF$** .
- V cursor 1 and H cursor 2 are displayed.
 - The measurement results of $\Delta V1$ (CH1) between cursor 1 and cursor 2 and their frequency $\Delta V2$ (CH2) are displayed in the lower left corner of the screen.
 - Move cursor 1 and cursor 2 to the measurement points and perform measurement.

Setting cursor 1

- ← ② Select **V-C1 (cursor 1)** by pressing **TCK/C2**.
- The function display changes into f : V-C1.
- ← • The symbol "—" displayed to the left of V cursor 1 indicates that the cursor can be moved.

- ③ Turn **[FUNCTION]** to move V cursor 1 (----) to the measurement point.

Setting cursor 2

- ← ④ Select **f : V-C2 (cursor 2)** by pressing **TCK/C2**.
- The function display changes into f : V-C2.
- ← • The symbol "—" displayed to the left of V cursor 2 indicates that the cursor can be moved.

- ⑤ Turn **[FUNCTION]** to move V cursor 2 (----) to the measurement point.

- ← • The measurement results of the voltage difference between the newly set cursors are displayed in the lower left corner of the screen.
- Of the channels set to ON (CH1, CH2, CH3), only measurement results for the two channels with the lower numbers are displayed.

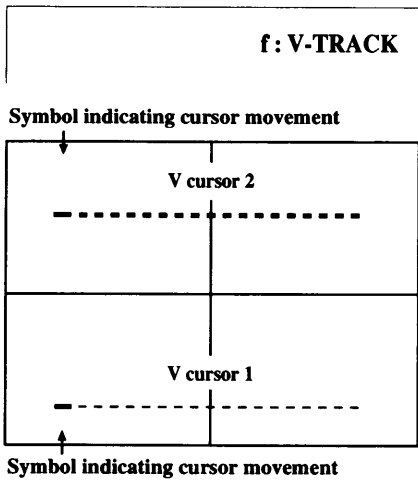

Setting tracking

- ← ⑥ **Select TCK (tracking) by pressing `TCK/C2`.**
 - The function display changes into f : V-TRACK.
- ← • The symbol "—" displayed above V cursor 1 and cursor 2 indicates that the cursor can be moved.
- ⑦ **Turn `[FUNCTION]` to move V cursor 1 and H cursor 2 to the measurement point .**
- ◇ Release ΔV measurement
Select OFF (no cursor displayed by pressing `$\Delta V-\Delta t$ -OFF` .

3.3 Counter

Measure the input signal frequency on the counter.

Operating method

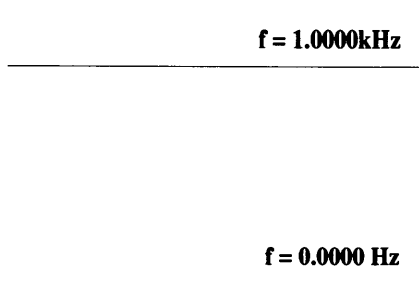

Procedures

- ← ① **Take A triggering (see "2.8 Triggering")**
 - When A triggering is set, the measurement result is displayed in the lower right corner of the screen.
 - The specified A trigger source is the object of the measurement.
 - The A trigger source in the VERT mode uses signals input to the low numbers as the trigger source (see "2.8.1 Triggering source VERT").
- ← • When A triggering is not set or the input signal exceeds the measurable frequency range, 0 Hz is displayed.

Section 4. Save/Recall

The save/recall functions can only be used with the SS-7821/11.

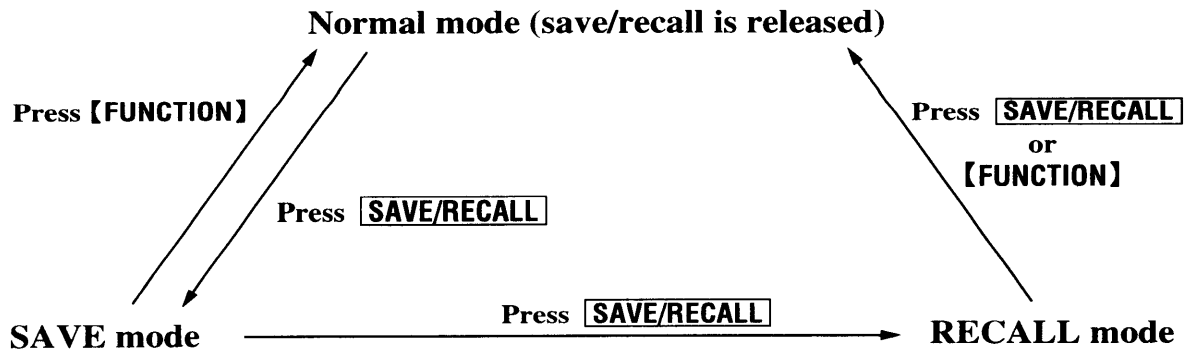

4.1 Save

Save the panel setup conditions.

Operating method

f : SAVE nn

Procedures

- ① Set a panel setup condition.
- ② Set the save mode by pressing **[SAVE/RECALL]** .
 - Function display changes into f : SAVE nn.
 - nn : Register No.
- ③ Select the register No. (00 to 31) in which the setup condition is to be saved by turning **[FUNCTION]** .
- ④ Press **[FUNCTION]** .
 - The setup condition is saved in the register of the No. displayed and the save mode is released.
- ⑤ To save multiple setup conditions, repeat steps ① to ④.

4.2 Recall

Recall the panel setup conditions.

Operating method

f : RECALL nn

Procedures

- ① Set the recall mode by pressing **[SAVE/RECALL]** twice.
 - Function display changes into f : RECALL nn.
 - nn : The register No. display type which the setup conditions are to be recalled.
- ② Select the register no. by turning **[FUNCTION]** .
 - The setup conditions are recalled display type the register of the selected no.
- ③ Release the recall mode by pressing **[SAVE/RECALL]** or **[FUNCTION]** .

Section 5. Daily Inspections

a. Methods for servicing

◇ Cleaning

Wipe off the stains on the casing and cover with soft cloth dampened with a small volume of water or diluted neutral cleanser. If any solvent or cleanser not suitable for cleaning is used, it may cause discoloration or an unexpected fault.

- Solvent or cleanser that can be used : Water and neutral cleanser
- Solvent or cleanser that cannot be used : Alcohol, gasoline, acetone, lacquer, ether, thinner, and cleansers containing ketone

◇ Stains on the CRT

Remove stains in the following manner:

- Wipe off ordinary stains with a soft cloth.
- Wipe off stubborn stains with a cloth dampened with neutral cleanser.

•How to take off the filter

1. Shift the lower part of the filter upward by the tip of a finger.
2. press the filter toward CRT.
3. Pull the lower part of the filter toward you by the tip of your finger.

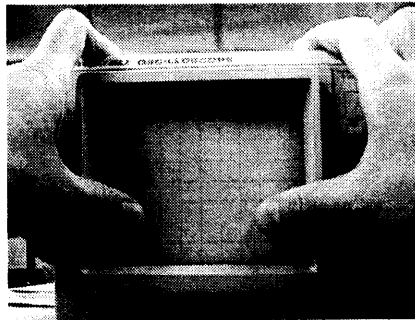

b. Cycles of periodical calibration

To ensure instrument accuracy calibrate once every year or, every 2000 hours in ordinary use. Calibration cycle may be reduction if the instrument is heavy use or harsh environment.

c. Automatic calibration

The following items are calibrated automatically:

- Changes in vertical position of traces after switching the voltage deflection factor.
- GND position.
- Vertical position.

⚠ Cautions

- Perform calibration with BEAM FIND released.
Automatic calibration is not accomplished correctly if BEAM FIND is pressed.
- Perform calibration with no signal input.
Automatic calibration is not accomplished correctly if there are signals input to any INPUT (CH1, CH2, EXT).

Operating method

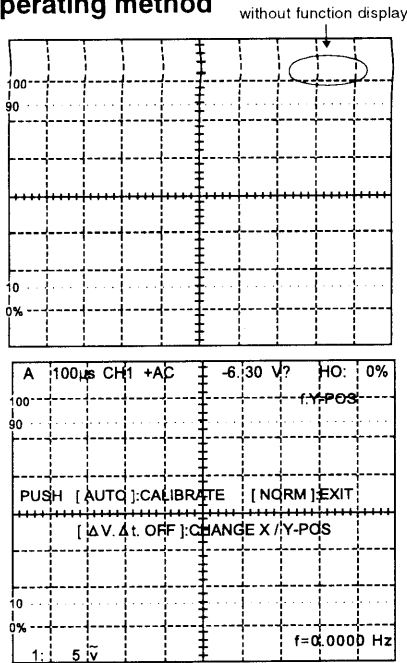

Procedures

- ← ① Turn all functions OFF to put [FUNCTION] key in the invalid state *1.
- *1 The state that f : XXXXX is not displayed in the upper right and corner of the screen.
- ② Press [FUNCTION] to select OFF (no display).
- ← ③ When [FUNCTION] is pressed about 3 seconds, the system menu appears.
- ← f: X-POS message is displayed in the middle of the screen.
- ④ Press [AUTO], and automatic calibration will start.
 - ◇ To stop automatic calibration, press [NORM].
 - ◇ If automatic calibration does not end normally, and error message is displayed. Make sure no signal is input, and if the error message is displayed after automatic calibration is performed several times, please contact our Service Center. (Refer to "Service Network" at the end of this manual.)

d. Calibrating the character center

If the position of characters is shifted by earth magnetism, calibrate the position of characters.
 Note : Calibrate the character center more than 30 minutes after power is turned ON.

Operating method

Fig④

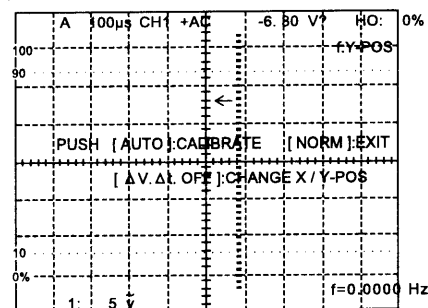

Fig⑤

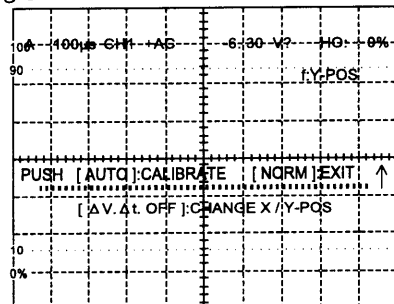

Procedures

- ①~③ Same as in "c. Automatic calibration".
- The following messages are displayed.
- Adjusting the horizontal position -
- ④ Press [ΔV-Δt-OFF] to select the X axis.
- By turning [FUNCTION], adjust the display position of the X direction of READ OUT.
- Adjusting the vertical position -
- ⑤ Press [ΔV-Δt-OFF] to select the Y axis
- By turning [FUNCTION], adjust the display position of the Y direction of READ OUT.
- ⑥ By pressing [NORM], adjustment is finished.

e. Guide to diagnosis

If this instrument does not operate or appears to be out of order, check the contents in "Table 5.1.1 Guide to diagnosis".

f. Storage and transportation

- ◇ Storage
- Avoid storage in the following places:
 - In locations exposed to direct sunlight

- In locations where there is a large amount of dust
 - In locations exposed to corrosive gas
- The conditions for storage of this instrument are as follows:
 Storage temperature : -20 to $+70$ °C
 Storage humidity : 80 %RH or less (at -20 °C to 70 °C)

◇ Transportation

When transporting this instrument, use packaging materials equal or superior to those used when this instrument was purchased.

Table 4.1.1 Guide to Diagnosing Faults

Phenomenon	Confirmation items	Remedy
Traces or luminescent spots do not appear.	Check that the power cord plug is connected to the AC receptacle.	Connect the plug to the AC receptacle.
	Check that the power switch is set to ON.	Set the power switch to ON.
	Check that INTEN is turned counterclockwise.	Turn INTEN clockwise until an adequate intensity is obtained.
	Check that SWEEP MODE is set to SINGLE.	Set SWEEP MODE to AUTO.
Scales on the screen are not clearly displayed.	Check that SCALE is turned counterclockwise.	Turn INTEN clockwise until an adequate intensity is obtained.
	Check that the illumination lamp is disconnected.	Contact your nearest Iwatsu sales agent.
Characters are not displayed.	Check that READOUT is turned counterclockwise.	Turn INTEN clockwise until an adequate intensity is obtained.
Focus of traces and characters is not clear.	Check whether the adjustment of FOCUS is deviated.	Adjust FOCUS so that it becomes clear.
Waveform does not appear when signals are input.	Check that the probe is disconnected.	Replace the probe.
	Check that the input coupling is set to GND.	Release GND.
	Check whether a wrong channel is selected.	Set the channel to which input signals are connected to ON.
	Check whether the voltage sensitivity is too low.	Increase the sensitivity.
Triggering cannot be set.		Press AUTO SET.
	Check whether the wrong trigger source is selected.	Select the channel to which trigger are input.
	Check whether the wrong trigger coupling mode is selected.	Set the trigger coupling mode suitable for input signals again.
Waveform is unstable.	Check whether the level is set to an inadequate position.	Adjust the level to the position where triggering is set.
	Check whether the AC supply voltage is too low.	Use an AC power supply within the rating.
Original settings are not restored when power is turned on again.		Replace the battery by contacting your nearest Iwatsu sales agent.

Section 6. Specifications

CRT

Type	6 inch, diagonal rectangular flat face, internal graticule, meshless CRT with graticule illumination
Display area	8 div x 10 div (1 div = 10 mm)
Accelerating voltage	Approx. 16 kV

Vertical deflection system (Y axis)

Vertical mode	CH1, CH2, CH3, ADD, ALT/CHOP
CH1, CH2	CHOP mode switching rate 555 kHz \pm 1 %
Deflection factor	
Range	2 mV/div to 5 V/div, 1-2-5 sequence, 11 steps
Variable control range	2 mV/div to 12.5 V/div continuously variable
Accuracy	\pm 2 %
Frequency characteristics	
Band width	
SS-7821	
5 mV to 5 V/div	DC to 200 MHz - 3 dB
2 mV/div	DC to 50 MHz - 3 dB
SS-7811/10	
5 mV to 5 V/div	DC to 100 MHz - 3 dB
2 mV/div	DC to 50 MHz - 3 dB
SS-7806	
5 mV to 5 V/div	DC to 60 MHz - 3 dB
2 mV/div	DC to 30 MHz - 3 dB
Band width limiter	DC to approx. 20 MHz
	[Note] AC coupled low cutoff frequency (-3 dB) is 4 Hz.
Rise time	
SS-7821	Approx. 1.75 ns
SS-7811	Approx. 3.5 ns
SS-7806	Approx. 5.8 ns
	[Note] Rise time T_r is calculate from:
	$T_r = \frac{350}{\text{Bandwidth [MHz]}} \text{ [ns]}$
Step response	at 10 mV/div, 50 Ω termination
Over shoot	
SS-7821	7 %
SS-7811/10/06	3 %
Sag (at 1 kHz)	1 %
Signal delay	At least 30 ns of the sweep is displayed before the triggering event.
Input coupling	AC, DC, GND
Input RC	1 M Ω \pm 1.5 % // 20 pF \pm 2 pF
Maximum input voltage	\pm 400 V (DC+AC _{peak})
Position control range	Approx. \pm 10 div from the center line of the screen
Invert	Available on CH2
ADD	
Accuracy of sum (at 1 kHz)	\pm 3 %
Frequency characteristics	
SS-7821	DC to 120 MHz - 3 dB
SS-7811	DC to 60 MHz - 3 dB
SS-7806	DC to 40 MHz - 3 dB
Common-mode rejection ratio	at 10 mV/div
1 kHz sine wave	50 : 1
20 MHz sine wave	15 : 1

Dynamic range	SS-7821	Overranging the screen at 200 MHz in the case of 10 mV/div
	SS-7811/10	Overranging the screen at 100 MHz in the case of 10 mV/div
	SS-7806	Overranging the screen at 60 MHz in the case of 10 mV/div
Probe sense		10 : 1, 100 : 1 detection
CH3		
Deflection factor		
Range		50 mV/div, 100 mV/div, 500 mV/div
Accuracy		± 2 %
Bandwidth		
SS-7821		DC to 200 MHz -3dB
SS-7811/10		DC to 100 MHz -3dB
SS-7806		DC to 60 MHz -3dB
Rise time		
SS-7821		Approx. 1.75 ns
SS-7811/10		Approx. 3.5 ns
SS-7806		Approx. 5.8 ns
		[Note] Rise time Tr is calculate from:
		$Tr = \frac{350}{\text{Bandwidth [MHz]}} \text{ [ns]}$
		at 50 mV/div, 50 Ω termination
Step response		
Over shoot		
SS-7821		10 %
SS-7811/10/06		6 %
Sag		1 %
Input coupling		AC, DC
Input RC		1 MΩ ± 1.5 % // 20 pF ± 3 pF
Maximum input voltage		± 400 V (DC+ACpeak)
Position control range		Approx. ± 10 div. from the center line of the screen
Dynamic range		
SS-7821		Overranging the screen at 200 MHz
SS-7811/10		Overranging the screen at 100 MHz
SS-7806		Overranging the screen at 60 MHz
Probe sense		10 : 1, 100 : 1 detection

Triggering

A triggering
Trigger sensitivity

Frequency	P.P signal amplitude
DC to 10 MHz (SS-7821/11/10/06)	0.4 div
10 MHz to 60 MHz (SS-7806)	1.0 div
10 MHz to 100 MHz (SS-7821/11/10)	
100 MHz to 200 MHz (SS-7821)	1.5 div

[Note] TV : The ratio between the composite video signal and synchronization signal is 7 : 3 and synchronization signal amplitude is 1.5 div or more.

HF-REJ : Attenuates at 10 kHz or more

LF-REJ : Attenuates at 10 kHz or less

Trigger level range

± 9.5 div or more (set range : ± 10 div)

Signal source

CH1, CH2, CH3, LINE, VERT

Coupling

AC, DC, HF-REJ, LF-REJ

Slope

+, -

B triggering
Trigger sensitivity

Frequency	P.P signal amplitude
DC to 10 MHz (SS-7821/11/10/06)	0.4 div
10 MHz to 60 MHz (SS-7806)	1.0 div
10 MHz to 100 MHz (SS-7821/11/10)	
100 MHz to 200 MHz (SS-7821)	1.5 div

[Note] HF-REJ : Attenuates at 10 kHz or more

LF-REJ : Attenuates at 10 kHz or less

Signal source
Coupling
Slope
TV mode
SS-7821
SS-7811/10/06
TV synchronization

CH1, CH2, CH3
AC, DC, HF-REJ, LF-REJ
+, -

NTSC, PAL (SECAM), HDTV

NTSC, PAL (SECAM)

ODD, EVEN, BOTH TV-H

[Note] ODD, EVEN, or BOTH can be selected

NTSC : 5 H to 2000 H

PAL (SECAM), HDTV : 2 H to 1997 H

AUTO SETUP

Channels
Frequency

Available CH1 and CH2
50 Hz to 50 MHz

Horizontal deflection system (X axis)

Horizontal display

A, ALT, B, X-Y

A sweep

Sweep mode

AUTO, NORMAL, SINGLE

Sweep rates

Maximum sweep

SS-7821

1 ns/div

SS-7811/10

2 ns/div

SS-7811/06

5 ns/div

Range

SS-7821

10 ns to 500 ms/div 1-2-5 sequence, 24 steps

SS-7811/10

20 ns to 500 ms/div 1-2-5 sequence, 23 steps

SS-7806

50 ns to 500 ms/div 1-2-5 sequence, 22 steps

Variable range

SS-7821

10 ns to 1.5 s/div

SS-7811/10

20 ns to 1.5 s/div

SS-7806

50 ns to 1.5 s/div

Accuracy I

± 2 % over center 8 div

Accuracy II

± 5 % over center any 2 div within center 8 div

Hold-off time

Continuously variable

B sweep

Delay

Triggered delay or continuous delay (RUNS AFTER)

Sweep rate

Maximum sweep

SS-7821

1 ns/div

SS-7811/10

2 ns/div

SS-7806

5 ns/div

Range

SS-7821

10 ns to 5 ms/div 1-2-5 sequence, 18 steps

SS-7811/10

20 ns to 5 ms/div 1-2-5 sequence, 17 steps

SS-7806

50 ns to 5 ms/div 1-2-5 sequence, 16 steps

Accuracy I

± 2 % over center 8 div

Accuracy II

± 5 % over center any 2 div within center 8 div

Delay time	
Position control range	0.2 to 10.2 div
Accuracy	$\pm [(set\ value \times 0.005) + (sweep\ rate \times 0.1)] - 55\ ns$ within the range of 1 $\mu s/div$ to 500 ms/div
Delay pick off jitter	1/2000, at 1 ms/div of A sweep., at 500 ns/div of B sweep
Sweep magnification	
Magnifying ratio	10 times
Accuracy I	over center 8 div
SS-7821	
10 ns/div to 50 ns/div	$\pm 5\ %$
100 ns/div to 500 ms/div	$\pm 3\ %$
SS-7811/10	
20 ns/div , 50 ns/div	$\pm 5\ %$
100 ns/div to 500 ms/div	$\pm 3\ %$
SS-7806	
50 ns/div	$\pm 5\ %$
100 ns/div to 500 ms/div	$\pm 3\ %$
^{**} Accuracy II	over any 2 div within center 8 div
SS-7821	
10 ns/div to 50 ns/div	$\pm 8\ %$
100 ns/div to 500 ms/div	$\pm 3\ %$
SS-7811/10	
20 ns/div , 50 ns/div	$\pm 8\ %$
100 ns/div to 500 ms/div	$\pm 3\ %$
SS-7806	
50 ns/div	$\pm 8\ %$
100 ns/div to 500 ms/div	$\pm 3\ %$
**30 ns or 1 div at the beginning of sweep and 30 ns at the end of sweep are excluded.	

X-Y operation

X axis (CH1)	
Deflection factor	
Accuracy	Same as CH1
Bandwidth	$\pm 4\ %$
Frequency response	DC to 2 MHz, - 3 dB
Y axis	CH1, CH2, CH3, ADD
Phase difference between X axis and Y axis	
SS-7821/11/06	3° or less (DC to 200 kHz)

CAL (Probe calibration signal)

Waveform	Rectangular wave
Frequency	1 kHz $\pm 0.1\ %$
Duty ratio	49 to 51 $\%$
Output voltage	0.6 V $\pm 1\ %$

Measurement with cursors and counter

Measurement with cursors	
Type of measurement	Time difference (Δt), voltage difference (ΔV)
Cursor position control range	
X axis	$\pm (5 \pm 0.2)$ div from the center line of the screen
Y axis	$\pm (4 \pm 0.2)$ div from the center line of the screen
Accuracy	
Voltage difference (ΔV)	$\pm [(2\ %\ of\ reading) + (0.3\ %\ of\ full\ scale)]$
Time difference (Δt)	
MAG OFF	$\pm [(2\ %\ of\ reading) + (0.3\ %\ of\ full\ scale)]$
MAG ON (MAG x 10)	

SS-7821	
500 ms to 100 ns/div	± [(3 % of reading) + (0.3 % of full scale)]
50 ns to 10 ns/div	± [(5 % of reading) + (0.3 % of full scale)]
SS-7811/10	
500 ms to 100 ns/div	± [(3 % of reading) + (0.3 % of full scale)]
50 ns, 20 ns/div	± [(5 % of reading) + (0.3 % of full scale)]
SS-7806	
500 ms to 100 ns/div	± [(3 % of reading) + (0.3 % of full scale)]
50 ns	± [(5 % of reading) + (0.3 % of full scale)]
Counter	
Number of digits displayed	5 digits
Accuracy	± 0.01%
Frequency measurement range	
SS-7821/11/10	2 Hz to 100 MHz
SS-7806	2 Hz to 60 MHz
Saving data	Backup by built-in battery
Type of date to be saved	Panel setup conditions immediately before turning power off ² Storing of panel setup conditions ³ (SS-7821/11)
	² The state where the power cord is disconnected.
	³ The maximum number of data items that can be stored: 32
	Approx. 30,000 H (at approx. 25 °C)
Data retention time	
Power source	
Voltage range	90 to 132 VAC /180 to 250 VAC
Frequency range	48 to 440 Hz
Power consumption	110 VA MAX
Mass and Dimension	
Mass	Approx. 7.5 kg
Dimension	Approx. 272 W x 152 H x 390 L [mm] [Note] Without accessories, and projections.
Environmental conditions	
Specification assurance temperature	10 to 35 °C
Operating	
Temperature	0 to 40 °C
Humidity	90 % RH or less (at 40 °C)
Storage	
Temperature	– 20 to 70 °C
Humidity	80 % RH or less (at 70 °C)
Altitude	
Operating	5,000 m, atmospheric pressure : Approx. 55 kPa
Nonoperating	15,000 m, atmospheric pressure : Approx. 12 kPa
Vibration	15 minutes along each of three axes at a total displacement of 0.67 mm.p with frequency Varied from 10 Hz to 55 Hz in 1 minute sweep.
Shock	Lifting a side to a height of 10 cm and dropping it naturally onto hard wood; 4 times on each side.
Dropping packaged	Dropping an instrument packaged for transportation from a height of 90 cm.
Warm up time	The specifications for this instrument are the assured values after more than 30 min of power on.

SS-500/501/502/505 (CH2 OUT, Z AXIS IN)

Factory option for the SS-7800 series.

SS-500 : SS-7802
SS-501 : SS-7804/7804P
SS-502 : SS-7806/7810/7811/7811P
SS-505 : SS-7821

CH2 OUT connector (rear panel)

Outputs a sample of the signal applied to the CH2 signal input.

Z AXIS IN connector (rear panel)

Input a signal for an intensity modulation on screen.

Specification

CH2 OUT

Deflection factor	
SS-500 to 502	45 mV \pm 20 % per one division screen amplitude (at 50 Ω load)
SS-505	30 mV \pm 20 % per one division screen amplitude (at 50 Ω load)
DC level	\pm 100 mV (at 50 Ω load)
Output coupling	DC
Bandwidth	
SS-500	10 MHz - 3dB (at 50 Ω load)
SS-501	20 MHz - 3dB (at 50 Ω load)
SS-502	50 MHz - 3dB (at 50 Ω load)
SS-505	100 MHz - 3dB (at 50 Ω load)
Output resistance	50 Ω \pm 20 %

Z AXIS IN

Input voltage	0.5 Vp-p or more
Polarity	Positive going signal decreases intensity and negative going signal increases intensity
Input frequency	
SS-500	DC to 2 MHz
SS-501/502/505	DC to 5 MHz
Input resistance	4.5 k Ω \pm 20 %
Maximum input voltage	\pm 50 V (DC+ACpeak)

Probe · SS-082R

Instruction Manual

Summary

Probe SS-082R is a passive probe that is applicable to oscilloscopes with an input resistance of $1M\Omega$. Equipped with the readout compensating function at an attenuation ratio of 10:1.

Components

There are a probe itself and its accessories.

Specification

Model	SS-082R
Attenuation ratio	10:1 \pm 2%
Input RC	10M Ω //13pF \pm 2pF
Matching Input Capacity	14pF to 20pF
Frequency Bandwidth	DC to 400MHz \pm 3dB (Using for SS-7840 or TS-8500)
Maximum Input voltage	600V (DC+AC peak) [Note] The maximum input voltage derates when frequency response is 1MHz or more.
Read-out function	Provided
GND REF	Provided
Probe length	Approx. 1.2m
Type of Connector	BNC type
Form of Matching Box	Straight
Major Applicable Types of Instrument	TS-8500 TS-8421/8422 SS-7840/7825/7821

[Note] *1 : The frequency band width is specified to probe only.

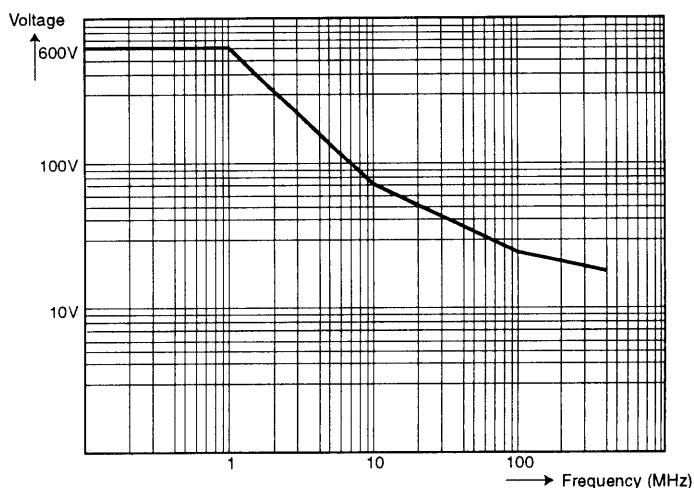
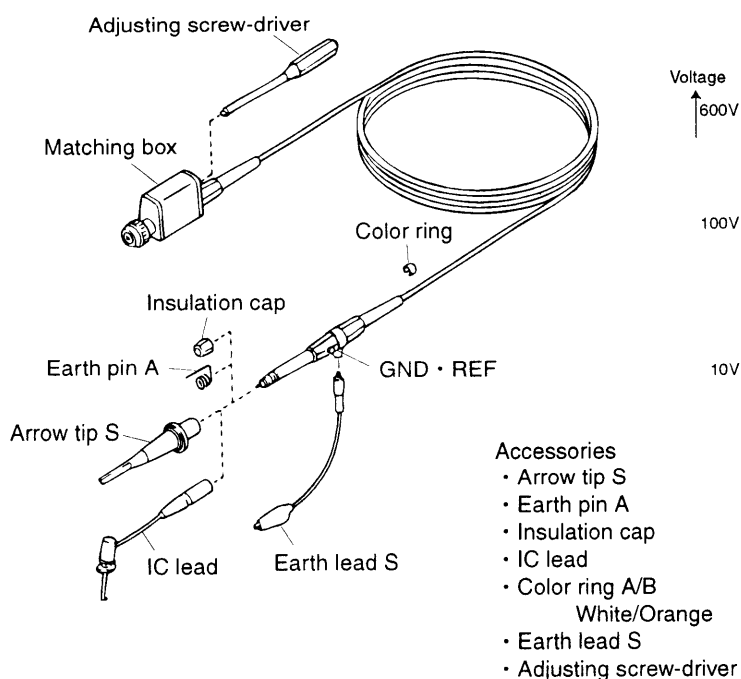

Figure 1 Maximum input voltage

Probe SS-0130R/0131R Instruction Manual

Summary

The probe SS-0130/0131 is the passive probe to be used with an oscilloscope with the input impedance of 1 MΩ. Operating the switch at the tip can select the attenuation ratio of 10:1 or 1:1.

Composition

There are a probe itself and its accessories.

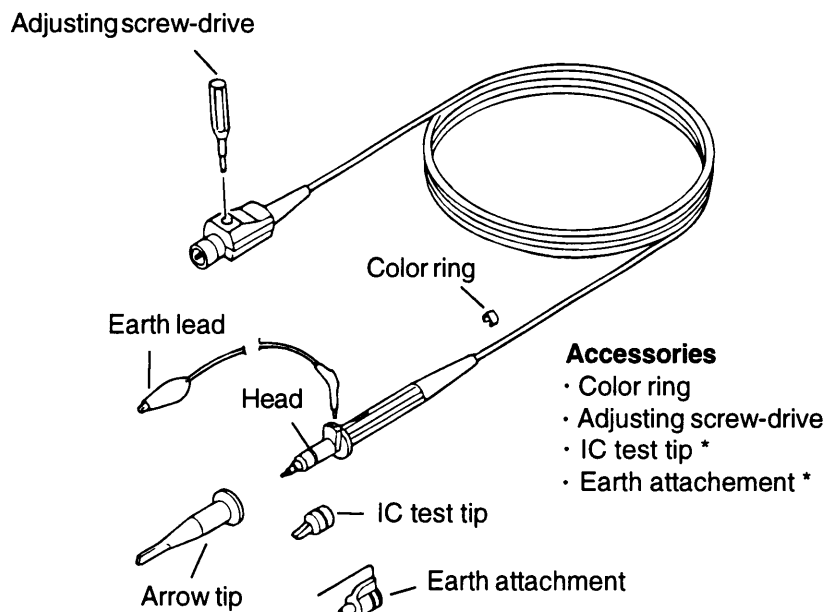

Specification

Model	SS-0130R	SS-0131R
Input RC	10MΩ ± 2% // 12.5Ω ± 2pF	10MΩ ± 2% // 22Ω ± 3pF
Attenuation ratio	within 10:1 ± 3%	
Frequency bandwidth	DC to 100MHz ± 2dB	
Input capacitance for waveform compensation	18 to 35pF	21 to 29pF
Input voltage	600V (DC+AC peak)	
	[Note] The maximum input voltage derates when frequency response is 1MHz or more.	
Probe length	Approx. 1.5m	
Type of connector	BNC type	
Environmental conditions	Assured operating temperature range : 5 to 40 °C Assured operating humidities range : 80%RH (5 to 31 °C) Maintaining temperature range : -20 to +70 °C	
IEC standard	Complies with IEC 1010 (installation category II, pollution degree 2)	

[Note] The accessory phase adjusting screw-driver is of simple type and or lower strength.
For frequent adjustments, a stronger screw-driver is available at your option. Please contact us.

Memo

SS-7821/11
10/06

IWATSU