

SERVICE MANUAL

CS-1022, CS-1021, CS-1012
(DUAL TRACE OSCILLOSCOPE)

CS-1020, CS-1010
(SINGLE TRACE OSCILLOSCOPE)

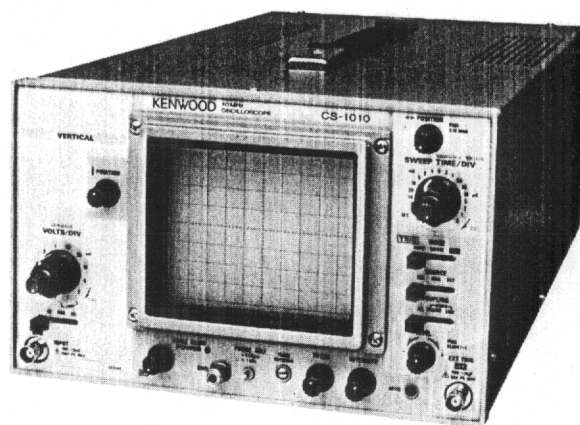
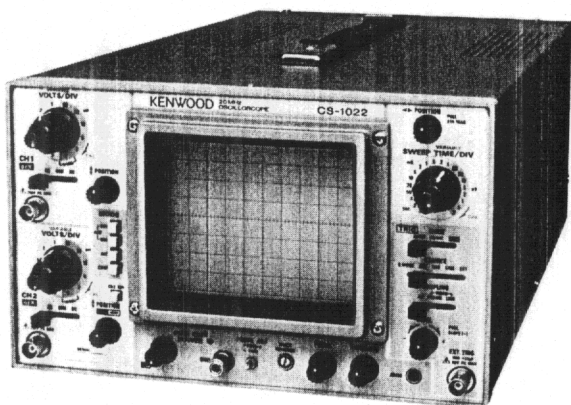

KENWOOD

CONTENTS

SPECIFICATIONS	2
SAFETY	6
CIRCUIT DESCRIPTION.....	7, 9
BLOCK DIAGRAM.....	8, 10
ADJUSTMENT.....	11
TROUBLESHOOTING	15
PARTS LIST	17
SEMICONDUCTORS	38
DISASSEMBLY	39
P.C. BOARD	40
SCHEMATIC DIAGRAM.....	41

WARNING

1. The following instructions are for use by qualified personnel only. To avoid electric shock, do not perform servicing other than contained in the operating instructions unless you are qualified to do so.
2. High voltage up to 6000 volts (for CS-1021, 1012, 1010, 2000 volts) dc is present when the oscilloscope is operating. Line voltage (100

to 240 VAC) is present on the power transformer, on-off switch, fuse holder, and line voltage selector any time the oscilloscope is connected to an ac power source, even if turned off. Always observe caution when the housing is removed from the unit. Contacting exposed high voltage could result in fatal electric shock.

NOTE:

The description of the dual-trace oscilloscope in this Service Manual is based on CS-1021. The shaded parts cannot be applied to CS-1021.

SPECIFICATIONS

	CS-1022	CS-1021	CS-1012	CS-1020	CS-1010
CRT	150FTM31	150GTM31A	150GTM31A	150FTM31	150GTM31A
Acceleration Voltage	6 kV	2 kV	2 kV	6 kV	2 kV
Display Area	8 × 10 div (1 div = 10 mm)				
Type	Rectangular, with internal graticule				
VERTICAL AXIS	CH1 and CH2			—	
Sensitivity	1 mV/div to 5 V/div, ±3%				
Attenuator	12 steps, 1 mV/div to 5 V/div in 1-2-5 sequence. Vernier control for fully adjustable sensitivity between steps.				
Input Impedance	1 MΩ ± 2%, approx 35pF				
Frequency Response 2 mV/div to 5 V/div 1 mV/div	DC; DC to 20 MHz, -3 dB AC; 5 Hz to 20 MHz, -3 dB DC; DC to 10 MHz, -3 dB AC; 5 Hz to 10 MHz, -3 dB	DC; DC to 10 MHz, -3 dB AC; 5 Hz to 10 MHz, -3 dB DC; DC to 7 MHz, -3 dB AC; 5 Hz to 7 MHz, -3 dB	DC; DC to 20 MHz, -3 dB AC; 5 Hz to 20 MHz, -3 dB DC; DC to 10 MHz, -3 dB AC; 5 Hz to 10 MHz, -3 dB	DC; DC to 10 MHz, -3 dB AC; 5 Hz to 10 MHz, -3 dB DC; DC to 7 MHz, -3 dB AC; 5 Hz to 7 MHz, -3 dB	DC; DC to 10 MHz, -3 dB AC; 5 Hz to 10 MHz, -3 dB DC; DC to 7 MHz, -3 dB AC; 5 Hz to 7 MHz, -3 dB
Rise Time	17.5 nsec or less (20 MHz) 35 nsec or less (10 MHz)	35 nsec or less (10 MHz) 50 nsec or less (7 MHz)	17.5 nsec or less (20 MHz) 35 nsec or less (10 MHz)	35 nsec or less (10 MHz) 50 nsec or less (7 MHz)	35 nsec or less (10 MHz) 50 nsec or less (7 MHz)
Crosstalk	-40 dB minimum			—	
Operating Modes	CH1; single trace CH2; single trace ADD; CH1 + CH2 added display ALT; two waveforms alternating CHOP; two waveforms chopped			—	
Chop Frequency	Approx. 250 kHz			—	
Channel Polarity	Normal or inverted, CH2 only inverted			—	
Maximum Input voltage	500 Vp-p or 250 V (DC + AC peak)				
Non-Distorted Maximum Amplitude	More than 8 div, DC to 20 MHz	More than 5 div, DC to 20 MHz	More than 6 div, DC to 10 MHz	More than 8 div, DC to 20 MHz	More than 6 div, DC to 10 MHz
HORIZONTAL AXIS	(input thru CH2, × 10 MAG not included)			(× 10 MAG not included)	
Operating Mode	With TRIG MODE switch, X-Y operation is selectable. CH1; Y axis CH2; X axis			With TRIG MODE switch, X-Y operation is selectable. VERT. INPUT; Y axis EXT TRIG INPUT; X axis	
Sensitivity	Same as vertical axis (CH2)			100 mV/div	
Input Impedance	Same as vertical axis (CH2)			1 MΩ ± 2%, approx. 32pF	1 MΩ ± 2%, approx. 35 pF
Frequency Response	DC; DC to 1 MHz, -3 dB AC; 5 Hz to 1 MHz, -3 dB	DC; DC to 500 kHz, -3 dB AC; 5 Hz to 500 kHz, -3 dB	DC; DC to 1 MHz, -3 dB	DC; DC to 500 kHz, -3 dB	DC; DC to 500 kHz, -3 dB
X-Y Phase Difference	3° or less at 100 kHz	3° or less at 50 kHz	3° or less at 100 kHz	3° or less at 50 kHz	
Maximum Input Voltage	Same as vertical axis (CH2)			50 V (DC + AC peak)	
SWEEP					
Type	NORM	Triggering sweep			
	AUTO	Sweep free runs in absence of trigger			

SPECIFICATIONS

	CS-1022	CS-1021	CS-1012	CS-1020	CS-1010					
Sweep Time	0.2 μ s/div to 0.5 s/div, \pm 3% in 20 ranges, in 1-2-5 sequence. Vernier control provides fully adjustable sweep time between steps.	0.5 μ s/div to 0.5 s/div, \pm 3% in 19 ranges, in 1-2-5 sequence. Vernier control provides fully adjustable sweep time between steps.		0.2 μ s/div to 0.5 s/div, \pm 3% in 20 ranges, in 1-2-5 sequence. Vernier control provides fully adjustable sweep time between steps.	0.5 μ s/div to 0.5 s/div, \pm 3% in 19 ranges, in 1-2-5 sequence. Vernier control provides fully adjustable sweep time between steps.					
Sweep Magnification	\times 10 (ten times) \pm 5%									
Linearity	\pm 3% all ranges, \pm 5% on 0.2 μ s/div range at \times 10 magnification.									
TRIGGERING										
Internal Sync	V. MODE; CH1; CH2; LINE;	Triggered by input signal selected by vertical MODE setting. Triggered by CH1 signal Triggered by CH2 signal Triggered by line voltage		INT; Triggered by vertical input signal LINE; Triggered by line voltage						
External Sync	EXT; Triggered by signal applied to EXT TRIG INPUT jack									
External sync Input Impedance	1 M Ω , \pm 2% approx 32pF	1 M Ω , \pm 2% approx 35pF		1 M Ω , \pm 2% approx 30pF						
Maximum External Trigger Voltage	50 V (DC + AC peak)									
Coupling	AC, VIDEO FRAME, VIDEO LINE									
Tigger Sensitivity	FREQ. RANGE INT EXT		FREQ. RANGE INT EXT		FREQ. RANGE INT EXT		FREQ. RANGE INT EXT		FREQ. RANGE INT EXT	
	20Hz to 20MHz 1div 0.1Vp-p		20Hz to 20MHz 1div 0.2Vp-p		20Hz to 10MHz 1div 0.1Vp-p		20Hz to 20MHz 1div 0.1Vp-p		20Hz to 10MHz 1div 0.1Vp-p	
	10Hz to 20MHz 1div 0.1Vp-p		10Hz to 20MHz 1div 0.2Vp-p		10Hz to 10MHz 1div 0.1Vp-p		10Hz to 20MHz 1div 0.1Vp-p		10Hz to 10MHz 1div 0.1Vp-p	
	FRAME, LINE 1div 0.1Vp-p		FRAME, LINE 1div 0.2Vp-p		FRAME, LINE 1div 0.1Vp-p		FRAME, LINE 1div 0.1Vp-p		FRAME, LINE 1div 0.1Vp-p	
PROBE ADJ. VOLTAGE	0.5 V, \pm 6%, square wave, positive polarity, approx 1 kHz									
INTENSITY MODULATION	TTL compatible Positive voltage increases brightness. Negative voltage decreases brightness.									
Sensitivity	TTL compatible Positive voltage increases brightness. Negative voltage decreases brightness.									
Input Impedance	Approx 10 k Ω									
Usable Frequency Range	DC to 2 MHz	DC to 1 MHz		DC to 2 MHz	DC to 1 MHz					
Maximum Input Voltage	50 V (DC + AC peak)									
VERTICAL AXIS SIGNAL OUTPUT	CH1 SIGNAL OUTPUT	-	CH1 SIGNAL OUTPUT	VERTICAL SIGNAL OUTPUT						
Output Voltage	Approx. 50mV/div (50 Ω load)	-	Approx 50 mV/div (50 Ω load)							
Output Impedance	Approx 50 Ω	-	Approx 50 Ω							
Frequency Response	100 Hz to 20 MHz, -3 dB (50 Ω load)	-	100 Hz to 10 MHz, -3 dB (50 Ω load)	100 Hz to 20 MHz, -3 dB (50 Ω load)	100 Hz to 10 MHz, -3 dB (50 Ω load)					
TRACE ROTATION	Electrical, adjustable from front panel									
POWER REQUIREMENT	AC 100/120/220/240 V \pm 10% 50/60 Hz									
Power Consumption	Approx 43 W	Approx 39 W	Approx 41W	Approx 38W	Approx 36W					
DIMENSIONS () dimensions include protrusions from basic outline dimensions.										
	Width	260 mm (260 mm)								
	Height	160 mm (180 mm)								
	Depth	400 mm (460 mm)								

SPECIFICATIONS

	CS-1022	CS-1021	CS-1012	CS-1020	CS-1010
WEIGHT	Approx. 8.8 kg	Approx. 8.4 kg			Approx. 8.1 kg
ENVIRONMENT					
Operating Temperature and Humidity for Guaranteed Specifications	0°C to 40°C, 85% maximum RH				
Full Operating Temperature and Humidity	0°C to 50°C, 90% maximum RH				
ACCESSORIES					
Probe	2			1	
Instruction Manual	1				
Replacement Fuse 0.8 A	2				
0.5 A	2				

■ Circuit and rating are subject to change without notice due to developments in technology.

STANDARD ACCESSORIES INCLUDED

Probe (PC-20)	Y87-1840-00
Attenuation.....	1/10, 1/1
Input Impedance	
1/10	10 MΩ, 18pF or less
1/1	1 MΩ, 100pF or less
Instruction Manual.....	B50-7570-00
Replacement Fuse	
0.8 A	F05-8015-05
0.5 A	F05-5013-05

OPTIONAL ACCESSORIES

Probe Pouch (MC-78).....	Y87-1600-00
Service Manual	B51-1033-10

SPECIFICATIONS

CRT 150FTM 31 SPECIFICATIONS (150GTM31A)

Screen and Shape

Dimensions;

Overall length; 330 mm max. (355mm max)
 Face plate dimensions; 149.3 ± 3 mm max.
 (149 ± 3 mm)

Screen shape; Rectangular flat face, internal graticule, non-metal back

Deflection and focusing system; Electrostatic deflection, electrostatic focusing and post-deflection acceleration (150FTM 31 only)

Color; Green
 Persistence; Medium short

Useful display area
 Y axis.....80 mm
 X axis.....100 mm

Heating

Heater voltage 6.0 V (6.3 V)

Heater current 75 mV (95 mA)

Weight 900 gr (1000 gr)

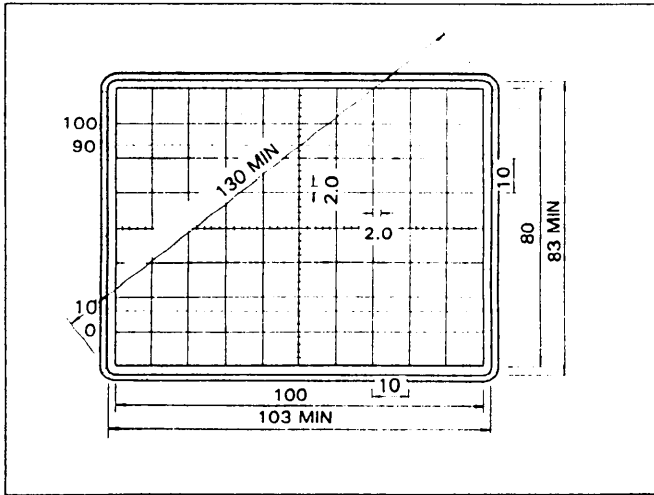

Fig. 1 150GTM31A 150FTM31 Graticule

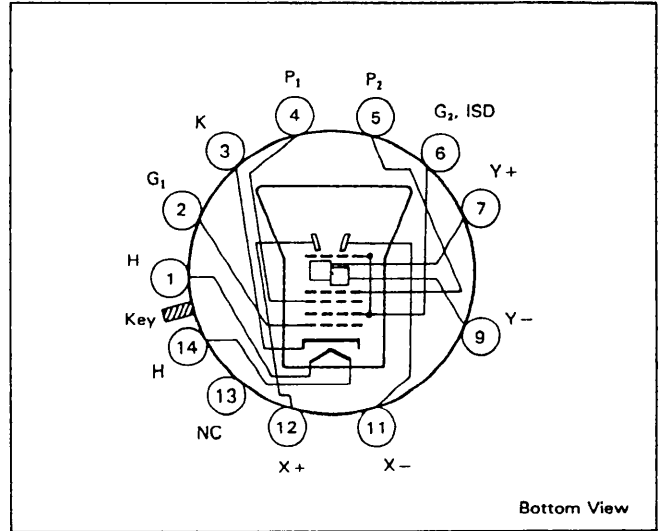

Fig. 2 150GTM31A Basing

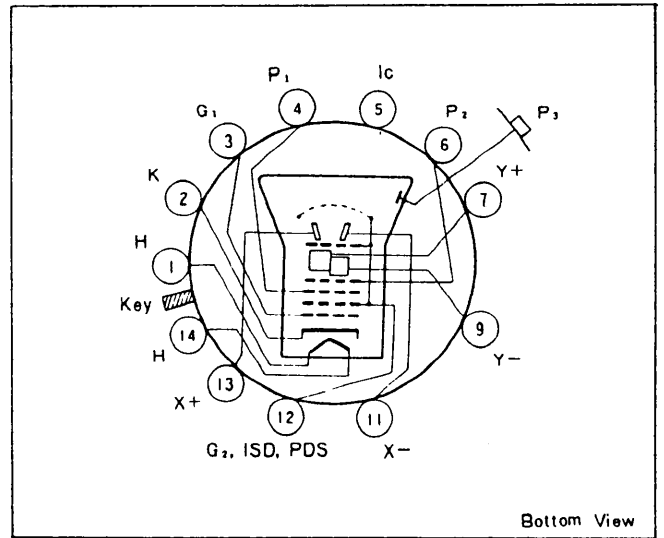

Fig. 3 150FTM31 Basing

SAFETY

SAFETY

Before connecting the instrument to a power source, carefully read the following information, then verify that the proper power cord is used and the proper line fuse is installed for power source. The specified voltage is shown at the left side of the power cord on the rear panel. If the power cord is not applied for specified voltage, there is always a certain amount of danger from electric shock.

Line voltage

This instrument operates using ac-power input voltages that 100/120/220/240 V at frequencies from 50 Hz to 60 Hz.

Power cord

The ground wire of the 3-wire ac power plug places the chassis and housing of the oscilloscope at earth ground. Do not attempt to defeat the ground wire connection or float the oscilloscope; to do so may pose a great safety hazard. The appropriate power cord is supplied by an option that is specified when the instrument is ordered.

The optional power cords are shown as follows in Fig. 4.

Line fuse

The fuse holder is located on the rear panel and contains the line fuse. Verify that the proper fuse is installed by replacing the line fuse.

Voltage conversion

This oscilloscope may be operated from either a 100 V to 240 V, 50/60 Hz power source. Use the following procedure to change from 100- to 240 volt operation or vice versa.

1. Remove the top section of case.
2. Unplug the leadwire of the voltage selector P5 located on the connection unit (X77-1260).
3. Reinsert it for appropriate voltage range.
4. Replace fuse F 1 with a fuse of appropriate value, 0.8 amp for 100 VAC to 120 VAC operation, 0.5 amp for 220 VAC to 240 VAC operation.
5. When performing the reinsertion of leadwire for the voltage conversion the appropriate power cord should be used. (See Fig. 4.)



Plug configuration	Power cord and plug type	Factory installed instrument fuse	Line cord plug fuse	Parts No. for power cord and plate
	North American 120 volt/60 Hz Rated 15 amp (12 amp max; NEC)	0.8 A, 250 V Fast blow AGC/3AG	None	Cord: E30-1854-05 Plate: J21-2977-04
	Universal Europe 220 volt/50 Hz Rated 16 amp	0.5 A, 250 V Fast blow 5 x 20 mm	None	Cord: E30-1852-05 Plate: J21-2973-04
	U.K. 240 volt/50 Hz Rated 13 amp	0.5 A, 250 V Fast blow 5 x 20 mm	0.5 A Type C	—
	Australian 240 volt/50 Hz Rated 10 amp	0.5 A, 250 V Fast blow 5 x 20 mm	None	Cord: E30-1853-05 Plate: J21-2972-04
	North American 240 volt/60 Hz Rated 15 amp (12 amp max; NEC)	0.5 A, 250 V Fast blow AGC/3AG	None	—
	Switzerland 240 volt/50 Hz Rated 10 amp	0.5 A, 250 V Fast blow AGC/3AG 5 x 20 mm	None	—

Fig. 4 Power Input Voltage Configuration

CIRCUIT DESCRIPTION CS-1021, CS-1022, CS-1012

VERTICAL ATTENUATOR

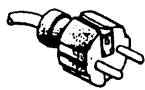
The attenuators of channel 1 and channel 2 are mounted on two independent circuit board which are the same.

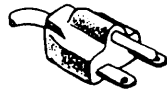
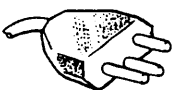
The vertical input signal coming to the BNC input receptacle enters a first-stage attenuator with path selected with the AC-GND-DC switch.

It then comes to one of the 1:1, 1:10, 1:100 attenuators which the vertical rotary switch selects before it enters the attenuator of the second stage. This attenuator consists of U1 and U2 and provides an attenuation sequence of 1-2-5. For the ranges of 1, 2, and 5mV/div, an amplifier consists of U3 and Q2 - 4 is used. For the adjustment of step ATT balance, VR2 is used in the ranges of 10 mV/div or more. For the ranges of 1, 2, 5mV/div, VR3 adjusts coarsely and VR4 does finely. VR2 and VR4 are accessible from the outside.

Trimmer TC 5 adjusts frequency response of the amplifier operating for ranges of 1, 2, and 5mV/div. It should be adjusted to obtain square wave and frequency response of the 10 mV/div range also in the other three ranges.

VERTICAL AMPLIFIER

The signal which has passed the attenuators comes to a preamplifier consisting of U1 and Q2 - 4 (CH2 ; U101 and Q102 - 104). Variable resistor VR1 (101) provided for the preamplifier allows to vary vertical position.

The preamplifier output comes to not only the vertical mode selector but in CH1, the CH1 OUTPUT circuit consisting of Q6 - 8 from which it is sent to the outside via a 22 μ F capacitor for AC coupling.

Another component of the preamplifier output comes to the base of Q5 (105) and after being selected with the TRIG SOURCE switch, passes through the emitter follower Q5 (105) over to a trigger amplifier which generates a trigger signal from the input. The channel 2 signal is used also as X-signal and VR102 adjusts offset for X POSITION centering.

The vertical mode switching circuit is a cascode amplifier comprising Q9 - 12 (107 - 110) whose outputs to Q13, 14 are controlled by two signals, CH1 - ENABLE and CH2 ENABLE, supplied from the vertical switching signal generator of the horizontal & high voltage unit.

Channel 2 is provided with the CH2 polarity inverter which comprises Q111, 112 and switched by switch S102.

VR104 allows to center during CH2 INVERT in relation to the condition during NORMAL.

Two cascode amplifiers of channel 1 and channel 2 of the vertical mode switching circuit are provided with trimmer capacitors TC101 (102) permitting adjustment of square wave and frequency response at high frequencies and semi-fixed variable resistor VR103 permitting to adjust channel 1 gain.

Since both channels are on during ADD, current is supplied to the vertical switching circuits from the circuits of Q113, 114 which are controlled by CH1-E and CH2-E signals. The

vertical switching output is given not only to the vertical output amplifier but also to the base of Q115 from which it goes as the V MODE trigger signal to the trigger amplifier.

The output amplifier is a cascode amplifier comprising Q15 - 18 and provided with VR4 permitting CH1 center adjustment, VR3 permitting operating level adjustment, VR5 permitting gain adjustment, and VR6 plus TC1 - 2 permitting square wave and frequency response adjustment.

TRIGGER AND SWEEP CIRCUITS

The trigger (or X-axis) signal coming from the vertical amplifier enters the trigger amplifier of Q101 - 104 with path selected by the TRIG SOURCE switch. During X-Y mode, the channel 2 signal passes Q117 to the horizontal output amplifier comprising Q118 and Q120 - 127.

During sweep mode, the trigger signal entering the trigger amplifier divides into AC and VIDEO signals. The VIDEO signal passes the video-sync signal separator which separates vertical and horizontal sync signals from the video signal. Then it comes to the TRIG COUPLING switch and appears, after shaped by a Schmitt circuit, as the clock signal of sweep control gate U102b.

The auto-sweep circuit comprising U101a, b, d and U103a checks for the presence of the output of U101c and performs free-run operation if the signal is absent and mode is AUTO.

The output of the sweep control gate is controlled by the auto sweep and Schmitt circuits. When Q116 turns off, the Miller integrator starts to charge at the speed which time-base C and R determine. SWEEP VARIABLE VR103 permits to vary sweep speed. The sweep stop circuit of Q113, 114 detects the output voltage of the Miller integrator and controls a gate to invert state and stop sweep. The holdoff circuit Q119 determines when to stop sweep. The sawtooth wave output of the Miller integrator is, with sweep speed controlled by VR104, sent to the horizontal output amplifier.

VR111 and TC101 permit sweep time adjustment respectively of 10 msec/div and 50 μ sec/div ranges. VR106, 107 permit adjustment respectively of gain and center during $\times 10$ MAG mode. VR105 adjusts X-axis gain during X-Y mode.

CRT CIRCUIT

U104a ANDs the \bar{Q} output of sweep control gate U102b with the CHOP blanking signal of U104c, d to generate the blanking signal.

Its amplitude is controlled in Q128, 129 by voltage coming from the INTENSITY control before the signal is sent to the blanking amplifier of Q1, 2. After amplified in the blanking amplifier and high acceleration DC component regenerated by D4 - 7, the blanking signal applies to a grid of the CRT. High voltages of 6 kV (for CS-1012, 2 kV) needed for trace in the CRT are generated by the DC - DC converter comprising T1 and Q3. Operational amplifier U1b performs

CIRCUIT DESCRIPTION / BLOCK DIAGRAM

feedback to obtain high stability.

POWER SUPPLY

The regulated power supply requires no adjustment. +5, -15, and +15 V are generated by 3-terminal regulators. +100 and +140 V are stabilized against line voltage fluctuation by feedback applied by an operational amplifier.

CALIBRATION VOLTAGE

No adjustment is needed for the calibration voltage. An oscillator composed of operational amplifier U1 generates a stable signal.

VERTICAL FINAL AMPLIFIER (applied for CS-1021 only)

The output amplifier is a cascode amplifier and comprised Q15, 16 (V. AMP. X73-1490) and Q1, 2 (V. FINAL X73-1630). The buffer amplifier is comprised with Q3~6. This output amplifier is provided with VR4 permitting crt center adjustment, VR3 permitting operating level adjustment, VR5 permitting gain adjustment and VR6 plus TC1, 2 permitting square wave and frequency response adjustment.

CS-1021 (1022, 1012) BLOCK DIAGRAM

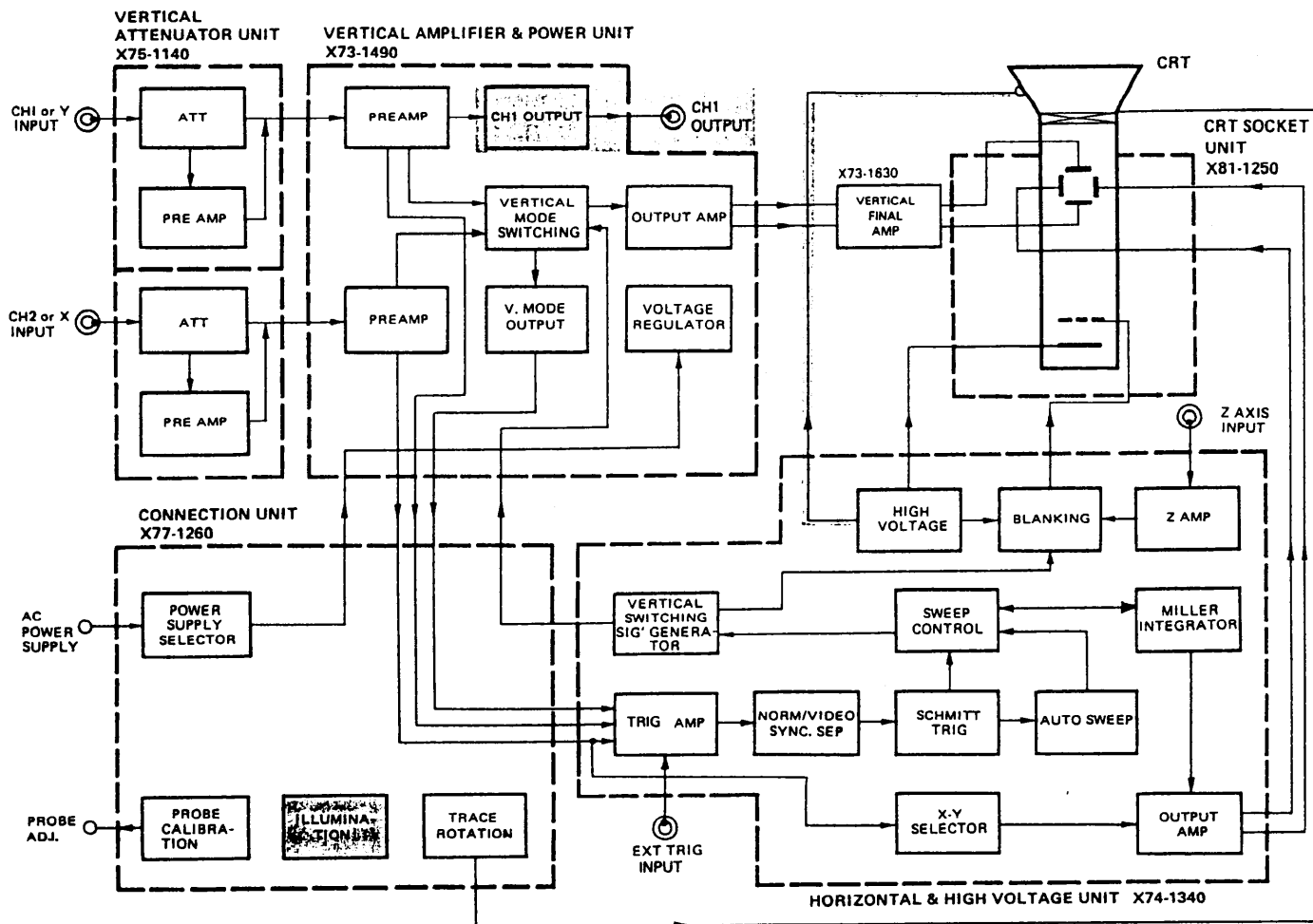

Fig. 5

Note: The shaded parts cannot be applied to CS-1021.

CIRCUIT DESCRIPTION CS-1020, CS-1010

VERTICAL ATTENUATOR

The vertical input signal coming to the BNC input receptacle enters a first-stage attenuator with path selected with the AG-GND-DC switch.

It then comes to one of the 1:1, 1:10, 1:100 attenuators which the vertical rotary switch selects before it enters the attenuator of the second stage. This attenuator consists of U1 and U2 and provides an attenuation sequence of 1-2-5. For the ranges of 1, 2, and 5 mV/div, an amplifier consists of U3 and Q2 - 4 is used.

For the adjustment of step ATT balance, VR2 is used in the ranges of 10 mV/div or more. For the ranges of 1, 2, 5 mV/div, VR3 adjusts coarsely and VR 4 does finely. VR2 and VR4 are accessible from the outside.

Trimmer TC 5 adjusts frequency response of the amplifier operating for ranges of 1, 2, and 5 mV/div. It should be adjusted to obtain square wave and frequency response of the 10 mV/div range also in the other three ranges.

VERTICAL AMPLIFIER

The signal which has passed the attenuators comes to a preamplifier consisting of U1 and Q2 - 4.

Variable resistor VR1 provided for the preamplifier allows to vary vertical position.

The preamplifier output comes to not only the vertical mode selector but in CH1, the VERT OUTPUT circuit consisting of Q6 - 8 from which it is sent to the outside via a 22 μ F capacitor for AC coupling. Another component of the preamplifier output comes to the base of Q5 and after being selected with the TRIG SOURCE switch, passes through the emitter follower Q5 over to a trigger amplifier which generates a trigger signal from the input.

The second stage amplifier is a cascode amplifier comprising Q9 - 12 whose switched to differential signal and it is fed to emitter follower of Q13 and 14.

The cascode amplifier is provided with trimmer capacitor TC101 permitting adjustment of square wave and frequency response at high frequencies.

The signal from Q13 and 14 is fed to vertical output amplifier.

The output amplifier is a cascode amplifier comprising Q15 - 18 and provided with VR4 permitting CRT center adjustment, VR3 permitting operating level adjustment, VR5 permitting gain adjustment, and VR6 plus TC1, 2 permitting square wave and frequency response adjustment.

TRIGGER AND SWEEP CIRCUITS

The trigger signal coming from the vertical amplifier enters the trigger amplifier of Q101 - 104 with path selected by the TRIG SOURCE switch. During X-Y mode, the signal applied to EXT TRIG input is X-signal which passes sweep X-Y selector consisting of S106, Q117, 130 and 131 and then applies to horizontal output amplifier comprising Q118 and Q120 - 127.

VR103a of X-Y selector adjusts X-axis gain coarsely and VR110 adjusts X-axis DC balance.

During sweep mode, the sync signal entering the sync amplifier divides into AC and VIDEO signals. The VIDEO signal passes the video-sync signal separator which separated vertical and horizontal sync signals from the video signal. Then it comes to the TRIG COUPLING switch and appears, after shaped by a Schmitt circuit, as the clock signal of sweep control gate U102b.

The auto-sweep circuit comprising U101a, b, d and U103a checks for the presence of the output of U101c and performs free-run operation if the signal is absent and mode is AUTO.

The output of the sweep control gate is controlled by the auto sweep and Schmitt circuits. When Q116 turns off, the Miller integrator starts to charge at the speed which time-base C and R determine. SWEEP VARIABLE VR103b permits to vary sweep speed. The sweep stop circuit of Q113, 114 detects the output voltage of the Miller integrator and controls a gate to invert state and stop sweep. The holdoff circuit Q119 determines when to stop sweep. The sawtooth wave output of the Miller integrator is, with sweep speed controlled by VR104, sent to the horizontal output amplifier.

VR111 and TC101 permit sweep time adjustment respectively of 10 msec/div and 50 μ sec/div ranges. VR106, 107 permit adjustment respectively of gain and center during $\times 10$ MAG mode. VR105 adjusts X-axis gain during X-Y mode.

CRT CIRCUIT

Q output of sweep control gate U102b generates the blanking signal.

Its amplitude is controlled in Q128, 129 by voltage coming from the INTENSITY control before the signal is sent to the blanking amplifier of Q1, 2.

After amplified in the blanking amplifier and high acceleration DC component of regenerated by D4 - 7, the blanking signal applies to a grid of the CRT. High voltages of 6 kV (for CS-1010, 2 kV) needed for trace in the CRT are generated by the DC-DC converter comprising T1 and Q 3. Operational amplifier U1b performs feedback to obtain high stability.

POWER SUPPLY

The regulated power supply requires no adjustment.

+5, -15, and +15 V are generated by 3-terminal regulators. +100 and +140 V are stabilized against line voltage fluctuation by feedback applied by an operational amplifier.

CALIBRATION VOLTAGE

No adjustment is needed for the calibration voltage.

An oscillator composed of operational amplifier U1 generates a stable signal.

BLOCK DIAGRAM

CS-1020 (1010) BLOCK DIAGRAM

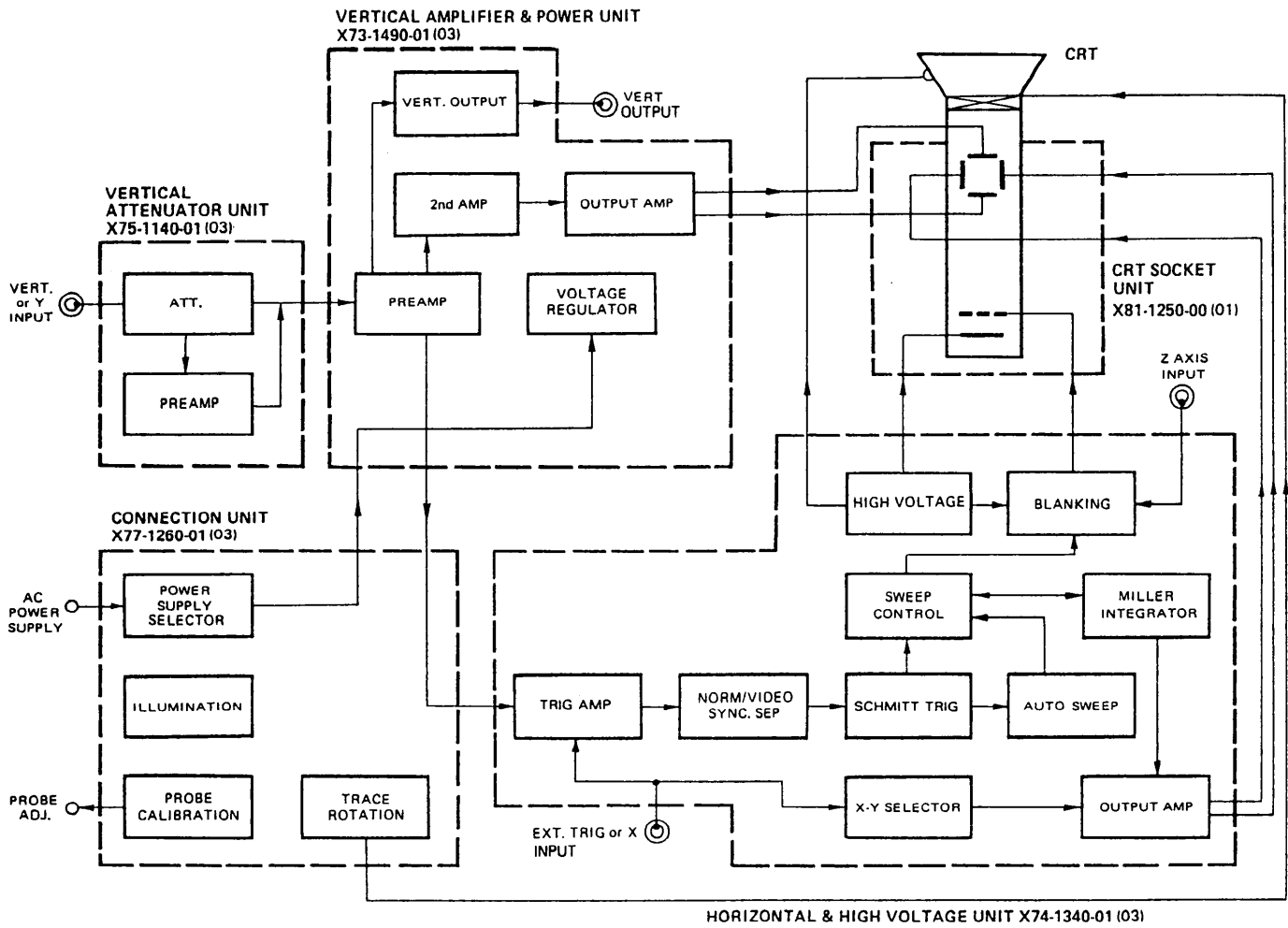

Fig. 6

ADJUSTMENT

To obtain the best performance, periodically calibrate the unit. Sometimes, only one mode need be calibrated, while at other times, all modes should be calibrated. When one mode is calibrated, it must be noted that the other modes may be affected. When calibrating all modes, perform the calibration in the specified sequence.

The following calibration required an accurate measuring instrument and an insulated adjusting flat blade screwdriver. If they are not available, contact your dealer.

For optimum adjustment, turn the power on and warm up the this equipment sufficiently (more than 30 minutes) before starting.

Before calibrating the unit, check the power supply voltage.

TEST EQUIPMENT REQUIRED

The following instrument or their equivalent should be used for making adjustment.

Test Equipment	Model	Minimum Specification
Digital Multi-Meter	DL-706 (TRIO)	Impedance: More than 10 MΩ, Measuring range: 0.01 V to 199 V
Sine-Wave Generator	651 B (YHP)	Frequency: 10 Hz to 10 MHz, constant voltage over tuning range
Sine-Wave Generator	SG-503 (Tektronix)	Frequency: 50 kHz to 100 MHz, Output impedance: 50 Ω, constant voltage over tuning range.
Square-Wave Generator	PG-506 (Tektronix)	Output signal: 1 kHz, Amplitude: 10 mVp-p to 10 Vp-p, Accuracy: within ± 1%, Rise time: 35ns or less 100 kHz, Rise time: 1 ns or less
Q Meter	4343B (YHP)	—
Color Pattern Generator	CG-911A (TRIO)	—
Oscilloscope	CS-2100A (TRIO)	Sensitivity: more than 5 mV Frequency response: More than 100 MHz
Time-Marker Generator	TG-501 (Tektronix)	Time mark: 0.5 s to 0.1 μs repetitive waveform
High-Voltage Probe	—	Input Impedance: 1000 MΩ
Termination	—	Impedance: 50 Ω Accuracy: within 3%
Termination	—	3 watts type impedance: 50 Ω
Attenuator	—	— 20 dB attenuation (50 Ω)

PREPARATION FOR ADJUSTMENT

Control Setting

The control setting listed below must be used for each adjustment procedure.

Exceptions to these settings will be noted as they occur.

After completing a adjustment, return the controls to the following settings.

NAME OF KNOBS	POSITION
INTENSITY	3 o'clock
FOCUS	Optimum position
CH1, CH2 POSITION	Mechanical center
◀▶ H. POSITION/PULL × 10MAG VARIABLE	Mechanical center, push CAL
(SWEEP TIME/DIV, VOLTS/DIV)	
AC-GND-DC (CH1 and CH2)	DC (GND at no signal)
MODE	CH1
CH2 POLARITY	NORM
COUPLING	AC
SOURCE	V.MODE
TRIG. LEVEL	Mechanical center, push
TRIG. MODE	AUTO
VOLTS/DIV	10 mV/DIV
SWEEP TIME/DIV	0.2 ms/DIV

ADJUSTMENT

Item	Control setting	Test equ.	Adjustment control				P.C.B	Procedure
			1021 1022	1012	1020	1010		
POWER SUPPLY SECTION ADJ.								
ASTIG. FOCUS	TRIG MODE; X-Y	—	ASTIG, FOCUS					For the sharpest and roundest spot.
INTENSITY	AC-GND-DC; GND TRIG MODE; X-Y	—	VR1				X74	Spot disappears in 9 to 10 o'clock position.
TRACE ROTATION	AC-GND-DC; GND	—	TRACE ROTATION VR					Trace is in parallel with horizontal graduation line.
GRT CENTER		DL-706	VR4				X73	Short the short terminal (P2). Trace should be in the CRT center.
58 V ADJ.		DL-706	VR3	—	VR3	—	X73	Short the short terminal (P2). The voltage of +Y (-Y) should be 58 V ± 0.5 V.
63 V ADJ.		DL-706	—	VR3	—	VR3	X73	Short the short terminal (P2). The voltage of +Y (-Y) should be 63 V ± 0.3 V.
VERTICAL AMPLIFIER SECTION ADJ.								
CH1 DC BAL	VOLTS/DIV; 10 mV AC-GND-DC; GND		VR2	VR2	VR2	VR2	X75	Trace does not move vertically when rotating CH1 variable control.
			VR1	VR1	—	VR1	X75	
CH2 DC BAL	VOLTS/DIV; 10 mV AC-GND-DC; GND		VR2	VR2	—	—	X75	Trace does not move vertically when rotating CH2 variable control.
			VR1	VR1	—	—	X75	
CH1 ATT BAL	VOLTS/DIV; 1 mV AC-GND-DC; GND		VR3	VR3	VR3	VR3	X75	Trace does not move vertically when rotating CH1 variable control.
			VR4	VR4	VR4	VR4	X75	
CH2 ATT BAL	VOLTS/DIV; 1 mV AC-GND-DC; GND		VR3	VR3	—	—	X75	Trace does not move vertically when rotating CH2 variable control.
			VR4	VR4	—	—	X75	
CH2 INVERT	MODE; CH2 AC-GND-DC; GND		VR104	VR104	—	—	X73	Trace should be overlapped in the center of the graduation.
CH2 GAIN	MODE; CH2 VOLTS/DIV; 10 mV		VR5	VR5	VR5 (CH1 GAIN)	VR5 (CH1 GAIN)	X73	When applying a 1 kHz, 50 mVp-p square wave signal, vertical amplitude should be 5 div.
CH1 GAIN	MODE; CH1 VOLTS/DIV; 10 mV		VR103	VR103	—	—	X73	When applying a 1 kHz, 50 mVp-p square wave signal, vertical amplitude should be 5 div.
CH1 WAVESHAPE		PG-506	TC1	TC1	TC1	TC1	X75	Same as 10 mV range, a best flat top waveform should be obtained. TC1.....0.1 V TC3.....1 V
			TC3	TC3	TC3	TC3	X75	
CH2 WAVESHAPE		PG-506	TC1	TC1	—	—	X75	Same as 10 mV range, a best flat top waveform should be obtained. TC1.....0.1 V TC3.....1 V
			TC3	TC3	—	—	X75	
CH2 INPUT CAPACITY		4343B	TC2	TC2	—	—	X75	Input capacity should be 35pF ± 3pF. TC2.....0.1 V TC4.....1 V
			TC4	TC4	—	—	X75	
CH1 INPUT CAPACITY		4343B	TC2	TC2	TC2	TC2	X75	Input capacity should be 35pF ± 3pF. TC2.....0.1 V TC4.....1 V
			TC4	TC4	TC4	TC4	X75	

ADJUSTMENT

Item	Control setting	Test equ.	Adjustment control				P.C.B	Procedure
			1021 1022	1012	1020	1010		
CH1 OVERSHOOT	SWEEP TIME/DIV; 2 μ s PULL x 10MAG; PULL VOLTS/DIV; 10 mV	PG-506	TC101	TC101	TC101	TC101	X73	When applying a 100 kHz, square wave signal, vertical amplitude should be 6 div. Set TC101 at mechanical center and with VR6, for the sharpest waveform. TC1...mid range flat top waveform TC2...high range flat top waveform Set VOLTS/DIV to 5 mV for 6 div \pm 3% vertical amplitude waveform. Overshoot should be \pm 3%. TC5...best flat top waveform.
			VR6	VR6	VR6	VR6	X73	
			TC1	TC1	TC1	TC1	X73	
			TC2	TC2	TC2	TC2	X73	
			TC5	TC5	TC5	TC5	X75	
CH2 OVERSHOOT	SWEEP TIME/DIV; 2 μ s	PG-506	TC102	TC102	—	—	X73	When applying a 100 kHz square wave signal for 6 div vertical amplitude, overshoot should be \pm 3%.
HORIZONTAL HIGH VOLTAGE SECTION ADJ.								
1 ms SWEEP TIME	SWEEP TIME/DIV; 1 ms	TG-501	VR104	VR104	VR104	VR104	X74	Pulse should be on each division on the graduation line.
MAG GAIN	SWEEP TIME/DIV; 1 ms PULL x 10MAG; PULL	TG501	VR106	VR106	VR106	VR106	X74	Interval of pulses should be 10 div when applying a 1 ms time marker signal.
MAG CENTER	SWEEP TIME/DIV; 1 ms PULL x 10MAG; PUSH	TG-501	VR107	VR107	VR107	VR107	X74	The center of pulse should be center of the graduation scale when applying a 5 ms marker signal. H.POSITION...mechanical center.
10 ms SWEEP TIME	SWEEP TIME/DIV; 10 ms	TG-501	VR111	VR111	VR111	VR111	X74	11th pulse should correspond to the right end of the graduation line.
20 μ s SWEEP TIME	SWEEP TIME/DIV; 20 μ s	TG-501	TC101	TC101	TC101	TC101	X74	11th pulse should correspond to the right end of the graduation line.
X POSITION	TRIG MODE; X-Y \Rightarrow AUTO AC-GND-DC; GND		VR102	VR102	—	—	X73	(1) Adjust the trace for center graduation line. (2) Spot should be the center of the screen.
X GAIN	TRIG MODE; X-Y VOLTS/DIV; 10 mV (CH2)	PG-506	VR105	VR105	VR105	VR105	X74	When applying a 1 kHz, 50 mV square wave signal, horizontal amplitude should be 5 div.

ADJUSTMENT

VERTICAL ATTENUATOR UNIT (X75-1140)

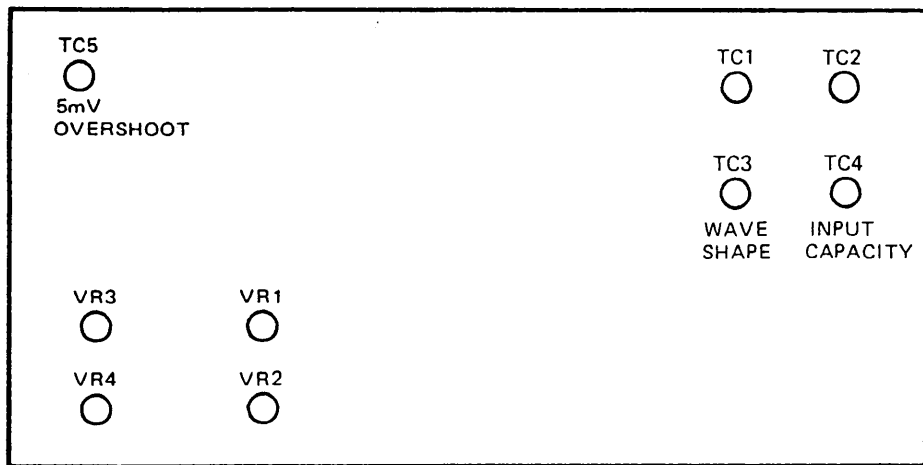

V. FINAL AMP UNIT (X73-1630)

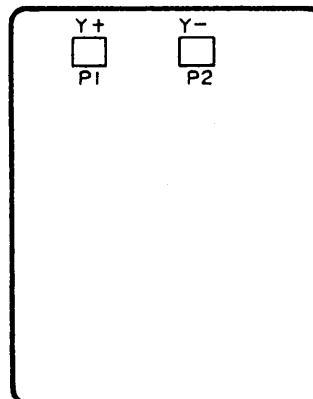

HORIZONTAL & HIGH VOLTAGE UNIT (X74-1340)

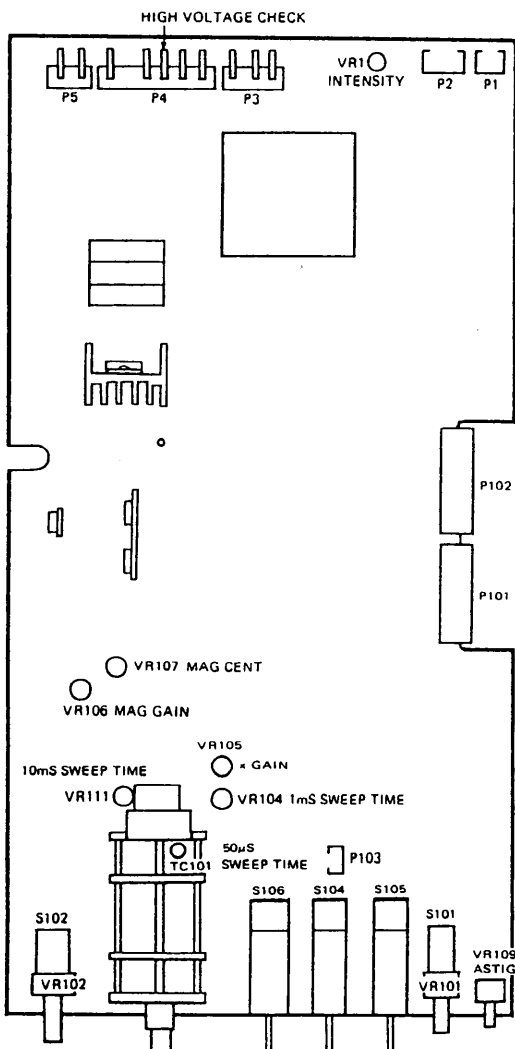

VERTICAL AMPLIFIER & POWER UNIT (X73-1490)

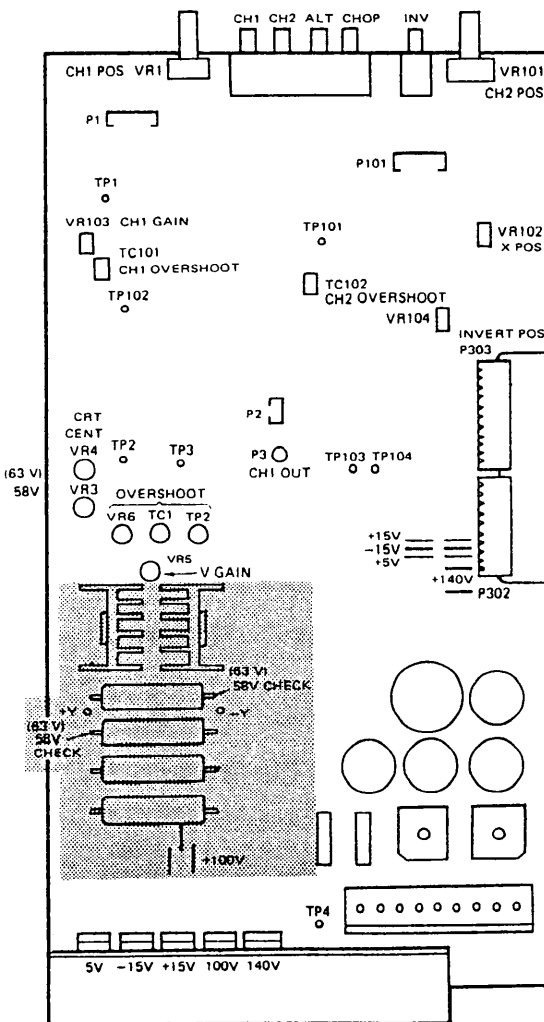
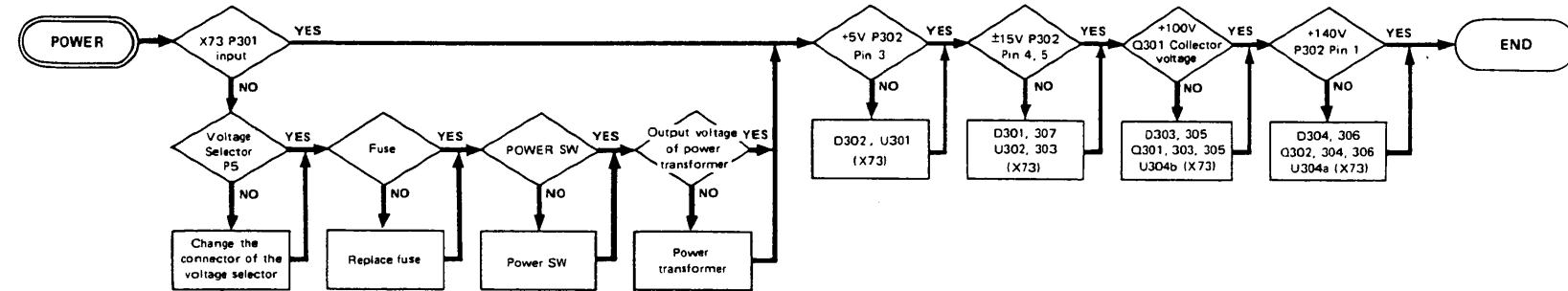
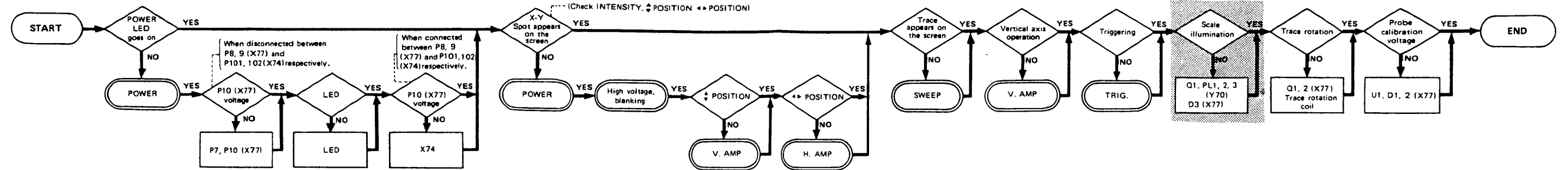

Fig. 7 Location of adjustment control

TROUBLESHOOTING



Note:

Index:		
Y70	... Main chassis	◇ Check and judgement
X73	... X73-1490	□ Malfunction
X74	... X74-1340	○ Item
X75	... X75-1140	
X77	... X77-1260	

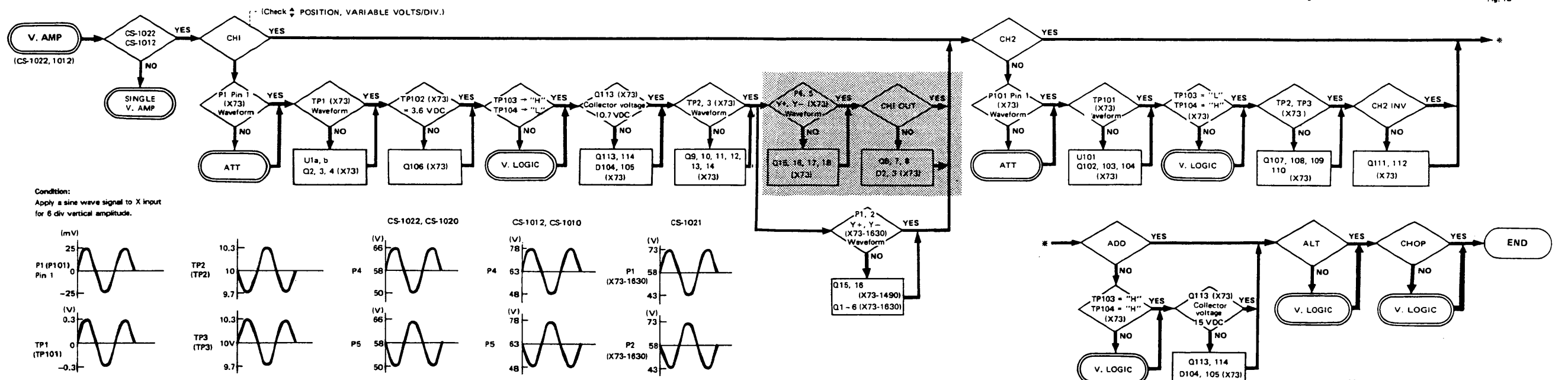
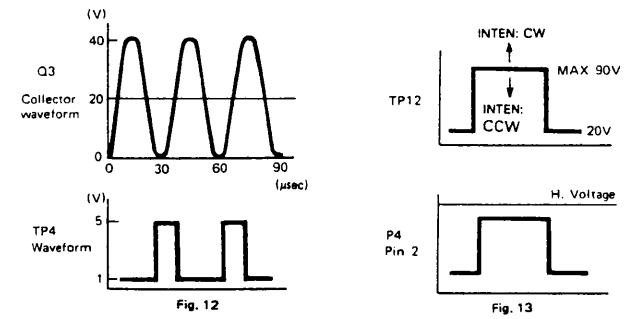
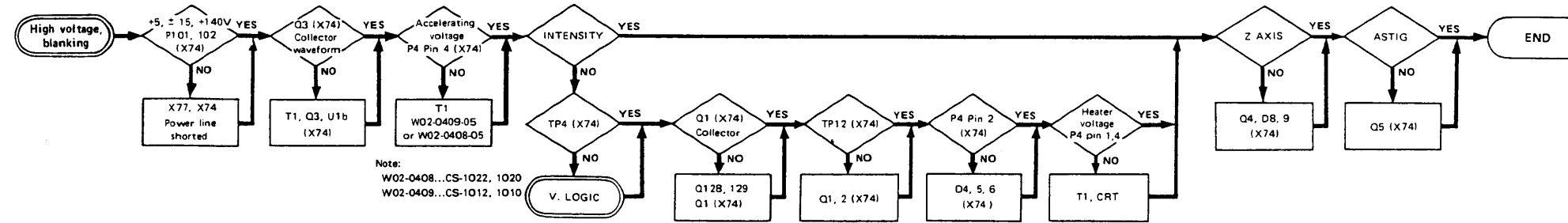

Condition:
Apply a sine wave signal to X input for 6 div vertical amplitude.

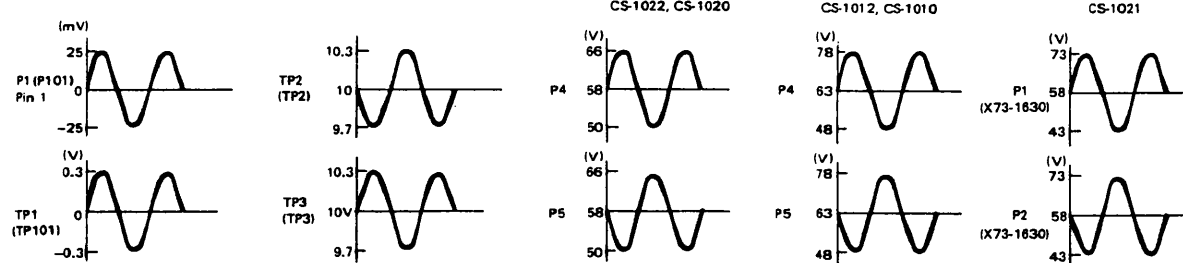

Note: The shaded parts cannot be applied to CS-1021.

TROUBLESHOOTING

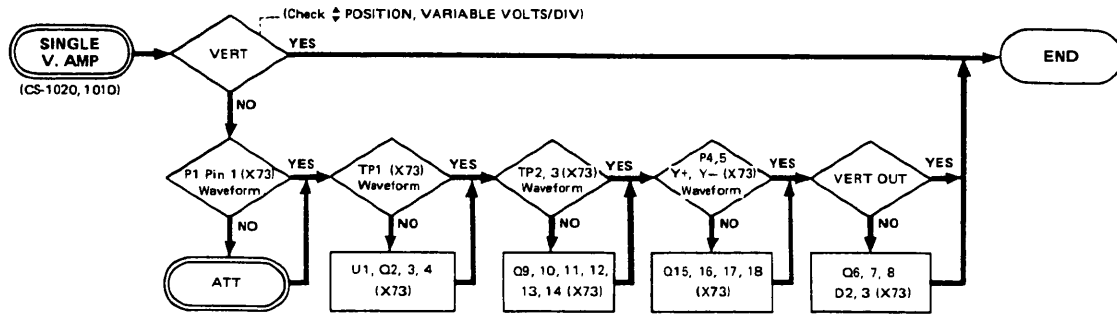

Note: Waveforms of P1, Pin 1, TP1, TP2 and TP3, are same as CH1 V. AMP.

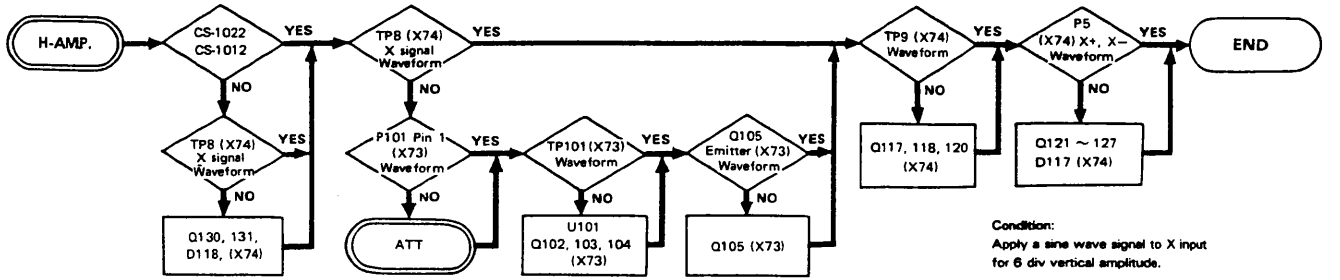
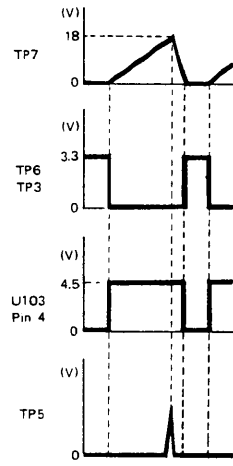
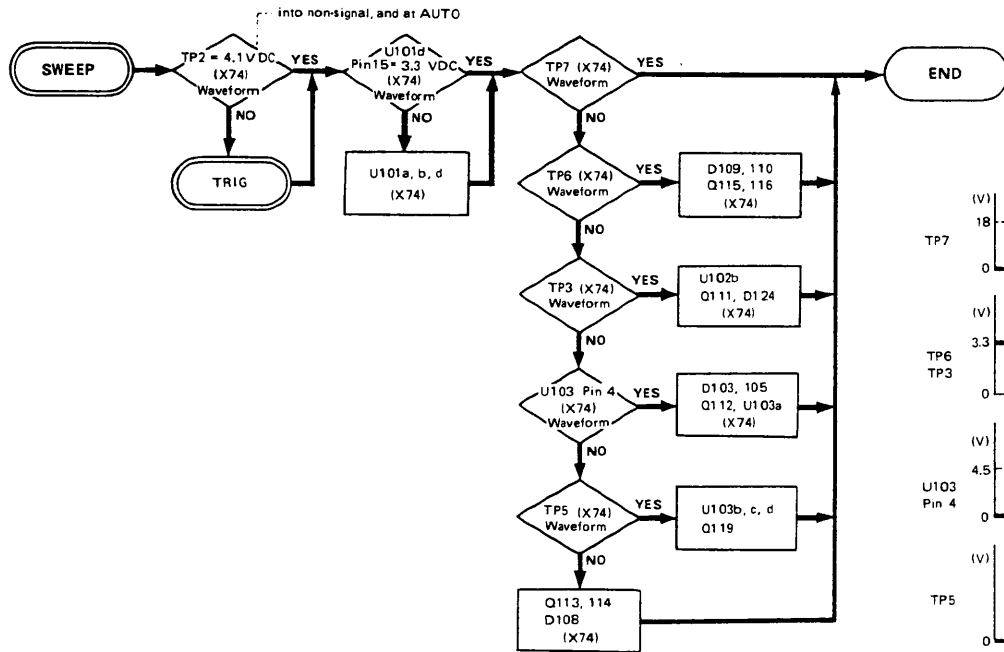

Condition: Apply a sine wave signal to X input for 6 div vertical amplitude.

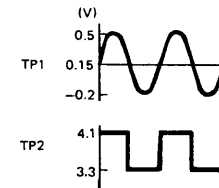
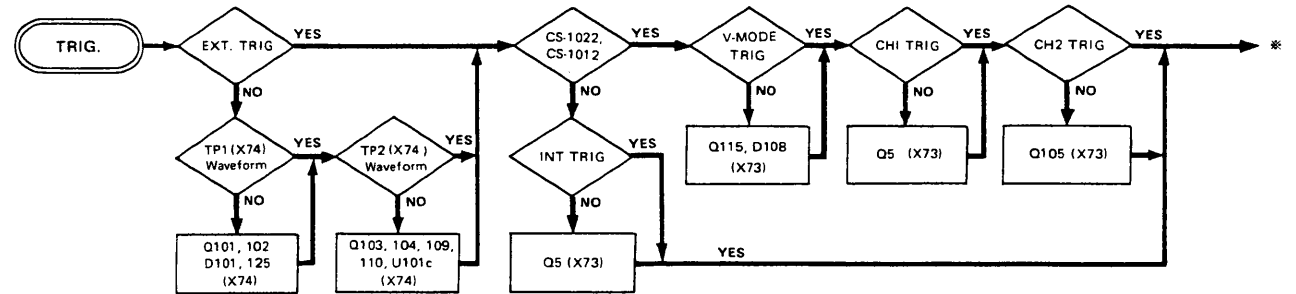
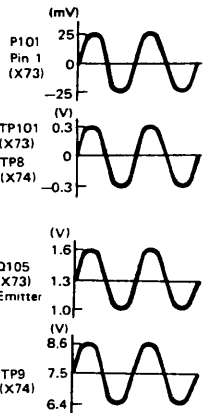
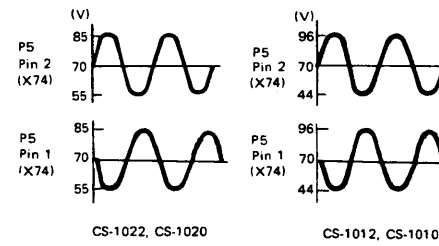

Waveform which synchronized at the center of the signal when applied a sine wave signal for 6 div.

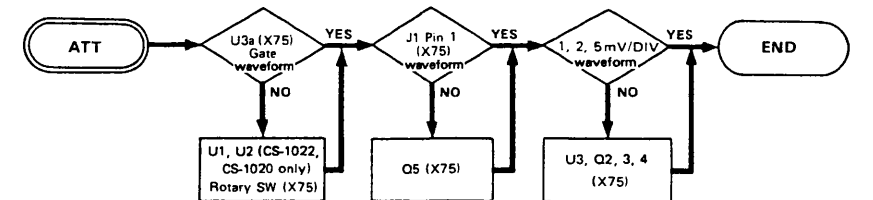

Note: Waveforms of U3 gate and J1 Pin 1 are same as P1 Pin 1 of CH1 V. AMP. (at 10 mV/div range)

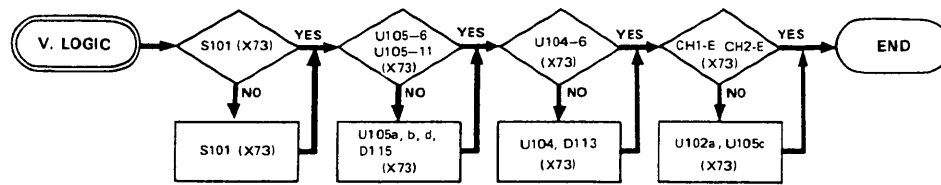

Note: Check the signal refer to table right.

TEST POINT	P303 (X73)			U105 (X74)		U104	U104	P102 (X74)	
	MODE	CH1	CH2	Pin. 6	Pin. 11	Pin 8	Pin 6	CH1-E ①	CH2-E ②
CH1	L	H	H	L	L	H		H	L
CH2	H	L	H	L	H	H		L	H
ADD	L	L	H	L	L	H		H	H
ALT	H	H	L	L	H	H		CH1 SWEEP	CH2 SWEEP
CHOP	H	H	H	H	H			CH1 SWEEP	CH2 SWEEP
X-Y	-	-	-	L	L	H	H		



PARTS LIST

MAIN CHASSIS

CS-1022 Y70-1400-21

REF. NO	PARTS NO	NAME & DESCRIPTION
1	A01-0897-12	CASE (TOP)
2	A01-0898-02	CASE (BOTTOM)
3	A10-1435-12	CHASSIS
4	A20-2761-02	PANEL (MOLDED)
5	A21-1026-12	DECORATIVE PANEL
6	A22-0826-02	SUB PANEL
7	A22-0827-13	SUB PANEL
8	A23-1642-02	REAR PANEL
9	A33-0502-05	REFLECTOR (FOR LAMP ASS'Y)
10	A33-0503-05	REFLECTOR (FOR LAMP ASS'Y)
11	B07-0712-13	ESCUTCHEON FOR FILTER
12	B19-0726-04	FILTER
13	B30-0903-15	LED LAMP (RED)
14	B30-0940-05	LAMP ASS'Y
15	B30-0941-05	LAMP
16	B39-0407-04	SPACER
17	B40-2765-04	NAME PLATE (SERIAL NO)
18	B41-0710-04	CAUTION LABEL (HIGH VOLTAGE)
19	B41-0747-13	CAUTION LABEL
20	B50-2998-00	INSTRUCTION MANUAL
21	E04-0251-05	BNC RECEPTACLE
22	E21-0657-04	TERMINAL (GND)
23	E21-0660-04	TERMINAL (CAL)
24	E23-0043-04	EARTH LUG
25	E23-0513-05	EARTH LUG
26	E23-0524-04	EARTH LUG
27	E23-0525-14	EARTH PLATE
28	E30-0545-05	POWER CORD (JIS)
29	E30-1851-05	POWER CORD ASS'Y (JIS)
30	E31-2371-05	LEAD WIRE WITH CONNECTOR
31	E31-2372-05	LEAD WIRE WITH CONNECTOR
32	E31-2373-15	LEAD WIRE WITH CONNECTOR
33	F05-5013-05	FUSE 0.5A
34	F05-8015-05	FUSE 0.8A
35	F11-0990-13	SHIELD CASE
36	F15-0733-04	BLIND PLATE
37	F20-0622-05	INSULATOR
38	G02-0607-04	SPRING FOR CRT
39	G13-0716-04	CUSHION
40	G16-0602-04	REFLECTOR SHEET(L)
41	G16-0603-04	REFLECTOR SHEET(R)
42	G16-0607-04	REFLECTOR SHEET
43	H01-2986-04	CARTON BOX
44	H10-2815-02	FOAMED STYRENE PAD
45	H10-2816-02	FOAMED STYRENE PAD
46	H20-1719-04	VINYL COVER
47	H25-0029-04	BAG
48	J02-0089-05	LEG
49	J02-0510-14	LEG
50	J10-0100-22	BEZEL
51	J13-0033-15	FUSE HOLDER
52	J19-1313-05	LEAD HOLDER
53	J19-1633-13	HOLDER FOR CRT
54	J19-1634-04	HOLDER FOR LEAD
55	J19-1635-04	HOLDER FOR LEAD
56	J21-2573-04	HOLDER FOR LEG
57	J21-2970-23	BRACKET FOR CRT
58	J21-2972-04	PLATE FOR POWER CORD
59	J21-4512-04	BRACKET FOR CRT
60	J25-3000-05	P.C. BOARD (FOR LAMP ASS'Y)
61	J31-0603-04	COLLAR
62	J42-0083-05	BUSHING
63	J42-0523-04	BUSHING
64	J59-0403-05	NYLON RIVET
65	J61-0408-05	WIRE WRAPPING BAND
66	J61-0515-05	SUPPORT (I TYPE)
67	J61-0516-05	SUPPORT (T TYPE)
68	J61-0517-05	STADOFF CLIP
69	K01-0518-05	HANDLE
70	K21-0851-03	KNOB
71	K21-0853-13	KNOB
72	K21-0854-13	KNOB
73	K21-0855-14	KNOB
74	K21-0856-13	KNOB
75	K27-0526-04	KNOB FOR LEVER
76	K27-0528-04	KNOB FOR PUSH
77	L01-9344-15	POWER TRANSFORMER
78	L39-0518-05	ROTATOR COIL
79	N08-0611-04	DRESSED SCREW
80	N09-0715-04	SCREW, PAN HD M 4X31
81	N09-0716-05	SCREW
82	N09-0717-05	SCREW, TRUSS HD M 3X12
83	N09-0720-05	SCREW, SEMS PAN HD
84	N10-2070-46	NUT, HEX
85	N15-1030-41	WASHER, FLAT FOR M3
86	N15-1040-41	WASHER
87	N19-0191-05	WASHER NONMETAL
88	N30-3004-46	SCREW, PAN HD M 3X4
89	N30-3006-46	SCREW, PAN HD M 3X6
90	N88-3006-46	SCREW, FLAT HD TAP TITE
91	N89-3006-41	SCREW, BINDING TAP TITE
92	R03-3502-15	V.R. 10K B

REF. NO	PARTS NO	NAME & DESCRIPTION
54	R05-3504-05	V.R. 10K B
55	R05-3505-05	V.R. 20K B
56	R05-8001-05	V.R. 3M B
57	W01-0503-04	CORD WRAP
58	X73-1490-00	VERTICAL, POWER SUPPLY UNIT
59	X74-1340-00	HORIZONTAL UNIT
60	X75-1140-00	VERTICAL ATTENUATOR UNIT
61	X77-1260-00	CONNECTION UNIT
62	X81-1250-00	C.R.T SOCKET UNIT
63	Y87-1840-00	PROBE PC-20
	150FIM31	CRT
	Z12-2014-05	TUBE (PLASTIC)
	Z12-3017-05	TUBE (PLASTIC)
0001	Z80613(E)	TR. SI. NPN
R100	RD148B2E31J	RES. CARBON 330 5% 1/4W

CS-1020 Y70-1410-21

REF. NO	PARTS NO	NAME & DESCRIPTION
	A01-0897-12	CASE (TOP)
	A01-0898-02	CASE (BOTTOM)
	A10-1435-12	CHASSIS
	A20-2761-02	PANEL
	A21-1027-12	DECORATIVE PANEL
	A22-0826-02	SUB PANEL
	A22-0827-13	SUB PANEL
	A23-1642-02	REAR PANEL
	A33-0502-05	REFLECTOR (FOR LAMP ASS'Y)
	A33-0503-05	REFLECTOR (FOR LAMP ASS'Y)
	B07-0712-13	ESCUTCHEON FOR FILTER
	B19-0726-04	FILTER
	B30-0903-15	LED LAMP (RED)
	B30-0940-05	LAMP ASS'Y
	B30-0941-05	LAMP
	B39-0407-04	SPACER
	B40-2765-04	NAME PLATE (SERIAL NO)
	B41-0710-04	CAUTION LABEL (HIGH VOLTAGE)
	B41-0748-13	CAUTION LABEL
	B50-2998-00	INSTRUCTION MANUAL
	E04-0251-05	BNC RECEPTACLE
	E21-0657-04	TERMINAL (GND)
	E21-0660-04	TERMINAL (CAL)
	E23-0043-04	EARTH LUG
	E23-0513-05	EARTH LUG
	E23-0524-04	EARTH LUG
	E23-0525-14	EARTH PLATE
	E30-0545-05	AC POWER CORD
	E30-1851-05	POWER CORD ASS'Y (JIS)
	E31-2371-05	LEAD WIRE WITH CONNECTOR
	E31-2372-05	LEAD WIRE WITH CONNECTOR
	E31-2373-15	LEAD WIRE WITH CONNECTOR
	F05-5013-05	FUSE 0.5A
	F05-8015-05	FUSE 0.8A
	F11-0981-03	SHIELD CASE FOR CRT
	F20-0622-05	INSULATOR
	G02-0607-04	SPRING FOR CRT
	G13-0716-04	CUSHION
	G16-0602-04	REFLECTOR SHEET(L)
	G16-0603-04	REFLECTOR SHEET(R)
	G16-0607-04	REFLECTOR SHEET
	H01-2987-04	CARTON BOX
	H10-2815-02	FOAMED STYRENE PAD
	H10-2816-02	FOAMED STYRENE PAD
	H20-1719-04	VINYL COVER
	H25-0029-04	BAG
	J02-0089-05	LEG
	J02-0510-14	LEG
	J10-0100-12	BEZEL
	J13-0033-15	FUSE HOLDER
	J19-1313-05	LEAD HOLDER
	J19-1633-03	HOLDER FOR CRT
	J19-1634-04	HOLDER FOR LEAD
	J19-1635-04	HOLDER FOR LEAD
	J21-2573-04	HOLDER FOR LEG
	J21-2970-13	BRACKET FOR CRT
	J21-2972-04	PLATE FOR POWER CORD
	J25-3000-05	P.C. BOARD (FOR LAMP ASS'Y)
	J31-0603-04	COLLAR
	J42-0083-05	BUSHING
	J59-0403-05	NYLON RIVET
	J61-0401-05	WIRE BAND
	J61-0515-05	SUPPORT (I TYPE)
	J61-0516-05	SUPPORT (T TYPE)
	J61-0517-05	STADOFF CLIP
	K01-0518-05	HANDLE
	K21-0851-03	KNOB
	K21-0853-03	KNOB
	K21-0854-03	KNOB
	K21-0855-14	KNOB
	K21-0856-03	KNOB
	K27-0526-04	KNOB FOR LEVER

PARTS LIST

REF.NO	PARTS NO	NAME & DESCRIPTION
	L01-9344-15	POWER TRANSFORMER
	L39-0518-05	ROTATOR COIL
	N08-0611-04	DRESSED SCREW
	N09-0715-04	SCREW, PAN HD M 4X31
	N09-0716-05	SCREW
	N09-0717-05	SCREW, TRUSS HD M 3X12
	N09-0720-05	SCREW, SEMS PAN HD
	N10-2070-46	NUT, HEX
	N15-1030-41	WASHER, FLAT FOR M3
	N15-1040-41	WASHER
	N19-0191-05	WASHER NONMETAL
	N30-3004-46	SCREW, PAN HD M 3X4
	N30-3006-46	SCREW, PAN HD M 3X6
	N33-4012-41	SCREW M 4X12
	N88-3006-46	SCREW, FLAT HD TAP TITE
	N89-3006-41	SCREW, BINDING TAP TITE
	R03-3502-15	V.R. 10K B
	R05-3504-05	V.R. 10K B
	R05-3505-05	V.R. 20K B
	R05-8001-05	V.R. 3M B
	W01-0503-04	CORD WRAP
	X73-1490-01	VERTICAL,POWER SUPPLY UNIT
	X74-1340-01	HORIZONTAL UNIT
	X75-1140-01	VERTICAL ATTENUATOR UNIT
	X77-1260-01	CONNECTION UNIT
	X81-1250-00	C.R.T SOCKET UNIT
	Y87-1840-00	PROBE PC-20
	150GTM31	CRT
Q001	2SD613(E)	TR. SI, NPN
R100	RD14882E331J	RES. CARBON 330 5% 1/4W

CS-1012 Y70-1420-21

REF.NO	PARTS NO	NAME & DESCRIPTION
	A01-0897-12	CASE (TOP)
	A01-0898-02	CASE (BOTTOM)
	A10-1435-12	CHASSIS
	A20-2761-02	PANEL (MOLDED)
	A21-1028-12	DECORATIVE PANEL
	A22-0826-02	SUB PANEL
	A22-0827-13	SUB PANEL
	A23-1642-02	REAR PANEL
	A33-0502-05	REFLECTOR (FOR LAMP ASS'Y)
	A33-0503-05	REFLECTOR (FOR LAMP ASS'Y)
	B07-0712-13	ESCUTCHEON FOR FILTER
	B19-0726-04	FILTER
	B30-0903-15	LED LAMP (RED)
	B30-0940-05	LAMP ASS'Y
	B30-0941-05	LAMP
	B39-0407-04	SPACER
	B40-2765-04	NAME PLATE (SERIAL NO)
	B41-0749-13	CAUTION LABEL
	B50-2998-00	INSTRUCTION MANUAL
	E04-0251-05	BNC RECEPTACLE
	E21-0657-04	TERMINAL (GND)
	E21-0660-04	TERMINAL(CAL)
	E23-0043-04	EARTH LUG
	E23-0513-05	EARTH LUG
	E23-0524-04	EARTH LUG
	E23-0525-14	EARTH PLATE
	E30-0545-05	POWER CORD (JIS)
	E30-1851-05	POWER CORD ASS'Y (JIS)
	E31-2371-05	LEAD WIRE WITH CONNECTOR
	E31-2372-05	LEAD WIRE WITH CONNECTOR
	E31-2373-15	LEAD WIRE WITH CONNECTOR
	F05-5013-05	FUSE 0.5A
	F05-8015-05	FUSE 0.8A
	F10-1565-04	SHIELDING PLATE
	F11-0982-23	SHIELD CASE
	F15-0734-04	BLIND PLATE
	F20-0622-05	INSULATOR
	G02-0607-04	SPRING FOR CRT
	G13-0716-04	CUSHION
	G16-0602-04	REFLECTOR SHEET(L)
	G16-0603-04	REFLECTOR SHEET(R)
	G16-0607-04	REFLECTOR SHEET
	H01-2988-04	CARTON BOX
	H10-2815-02	FOAMED STYRENE PAD
	H10-2816-02	FOAMED STYRENE PAD
	H20-1719-04	VINYL COVER
	H25-0029-04	BAG
	J02-0089-05	LEG
	J02-0510-14	LEG
	J10-0100-22	BEZEL
	J13-0033-15	FUSE HOLDER
	J19-1313-05	LEAD HOLDER
	J19-1633-13	HORDER FOR CRT
	J19-1634-04	HOLDER FOR LEAD
	J19-1635-04	HOLDER FOR LED
	J21-2573-04	HOLDER FOR LEG
	J21-2970-23	BLACKET FOR CRT

REF.NO	PARTS NO	NAME & DESCRIPTION
	J21-2972-14	PLATE FOR POWER CORD
	J21-4512-04	BLACKET FOR CRT
	J25-3000-05	P.C.BOARD (FOR LAMP ASS'Y)
	J31-0603-04	COLLAR
	J42-0083-05	BUSHING
	J42-0524-04	BUSHING
	J59-0403-05	NYLON RIVET
	J61-0408-05	WIRE WRAPPING BAND
	J61-0515-05	SUPPORT (I TYPE)
	J61-0516-05	SUPPORT (T TYPE)
	J61-0517-05	STADOFF CLIP
	K01-0518-05	HANDLE
	K21-0851-03	KNOB
	K21-0853-13	KNOB
	K21-0854-13	KNOB
	K21-0855-14	KNOB
	K21-0856-13	KNOB
	K27-0526-04	KNOB FOR LEVER
	K27-0528-04	KNOB FOR PUSH
	L01-9344-15	POWER TRANSFORMER
	L39-0518-05	ROTATOR COIL
	N08-0611-04	DRESSED SCREW
	N09-0715-04	SCREW, PAN HD M 4X31
	N09-0716-05	SCREW
	N09-0717-05	SCREW, TRUSS HD M 3X12
	N09-0720-05	SCREW, SEMS PAN HD
	N10-2070-46	NUT, HEX
	N15-1030-41	WASHER, FLAT FOR M3
	N15-1040-41	WASHER
	N19-0191-05	WASHER NONMETAL
	N30-3004-46	SCREW, PAN HD M 3X4
	N30-3006-46	SCREW, PAN HD M 3X6
	N88-3006-46	SCREW, FLAT HD TAP TITE
	N89-3006-41	SCREW, BINDING TAP TITE
	R03-3502-15	V.R. 10K B
	R05-3504-05	V.R. 10K B
	R05-3505-05	V.R. 20K B
	R05-8001-05	V.R. 3M B
	W01-0503-04	CORD WRAP
	X73-1490-02	VERTICAL,POWER SUPPLY UNIT
	X74-1340-02	HORIZONTAL UNIT
	X75-1140-02	VERTICAL ATTENUATOR UNIT
	X77-1260-02	CONNECTION UNIT
	X81-1250-01	C.R.T SOCKET UNIT
	Y87-1840-00	PROBE PC-20
	150GTM31	CRT
	212-2014-05	TUBE (PLASTIC)
	212-3017-05	TUBE (PLASTIC)
Q001	2SD613(E)	TR. SI, NPN
R100	RD14882E431J	RES. CARBON 430 5% 1/4W

CS-1010 Y70-1430-21

REF.NO	PARTS NO	NAME & DESCRIPTION
	A01-0897-12	CASE (TOP)
	A01-0898-02	CASE (BOTTOM)
	A10-1435-12	CHASSIS
	A20-2761-02	PANEL (MOLDED)
	A21-1029-12	DECORATIVE PANEL
	A22-0826-02	SUB PANEL
	A22-0827-13	SUB PANEL
	A23-1642-02	REAR PANEL
	A33-0502-05	REFLECTOR (FOR LAMP ASS'Y)
	A33-0503-05	REFLECTOR (FOR LAMP ASS'Y)
	B07-0712-13	ESCUTCHEON FOR FILTER
	B19-0726-04	FILTER
	B30-0903-15	LED LAMP (RED)
	B30-0940-05	LAMP ASS'Y
	B30-0941-05	LAMP
	B39-0407-04	SPACER
	B40-2765-04	NAME PLATE (SERIAL NO)
	B41-0750-13	CAUTION LABEL
	B50-2998-00	INSTRUCTION MANUAL
	E04-0251-05	BNC RECEPTACLE
	E21-0657-04	TERMINAL (GND)
	E21-0660-04	TERMINAL(CAL)
	E23-0043-04	EARTH LUG
	E23-0513-05	EARTH LUG
	E23-0524-04	EARTH LUG
	E23-0525-14	EARTH PLATE
	E30-0545-05	POWER CORD (JIS)
	E30-1851-05	POWER CORD ASS'Y (JIS)
	E31-2371-05	LEAD WIRE WITH CONNECTOR
	E31-2372-05	LEAD WIRE WITH CONNECTOR
	E31-2373-15	LEAD WIRE WITH CONNECTOR
	F05-5013-05	FUSE 0.5A
	F05-8015-05	FUSE 0.8A
	F10-1565-04	SHIELDING PLATE
	F11-0982-23	SHIELD CASE
	F15-0734-04	BLIND PLATE
	F20-0622-05	INSULATOR

PARTS LIST

REF.NO	PARTS NO	NAME & DESCRIPTION	REF.NO	PARTS NO	NAME & DESCRIPTION
	G02-0607-04	SPRING FOR CRT	C009	CC45CH1H470J	CAP. CERAMIC 47P 5% 50V
	G13-0716-04	CUSHION	C010	CK45B1H103K	CAP. CERAMIC 0.01 10% 50V
	G16-0602-04	REFLECTOR SHEET(L)	C011	CK45B1H103K	CAP. CERAMIC 0.01 10% 50V
	G16-0603-04	REFLECTOR SHEET(R)	C012	CK45B1H103K	CAP. CERAMIC 0.01 10% 50V
	G16-0607-04	REFLECTOR SHEET	C013	CE04W1E470M	CAP. ELECTRO 47 20% 25V
	H01-2989-04	CARTON BOX	C014	CE04W1E470M	CAP. ELECTRO 47 20% 25V
	H10-2815-02	FOAMED STYRENE PAD	C015	CE04W1E470M	CAP. ELECTRO 47 20% 25V
	H10-2816-02	FOAMED STYRENE PAD	C016	CE04W1E470M	CAP. ELECTRO 47 20% 25V
	H20-1719-04	VINYL COVER	C017	CC45CH1H030C	CAP. CERAMIC 3P 0.25P 50V
	H25-0029-04	BAG	C018	CC45CH1H010C	CAP. CERAMIC 1P 0.25P 50V
	J02-0089-05	LEG	C019	CE04B1H010M	CAP. ELECTRO 1 20% 50V
	J02-0510-14	LEG	C020	CK45B1H152K	CAP. CERAMIC 1500P 10% 50V
	J10-0100-22	BEZEL	C021	NO USE	
	J13-0033-15	FUSE HOLDER	C022	CK45B1H103K	CAP. CERAMIC 0.01 10% 50V
	J19-1313-05	LEAD HOLDER	C023	CK45B1H103K	CAP. CERAMIC 0.01 10% 50V
	J19-1633-13	HOLDER FOR CRT	D001	MTZ9.1JC	DIODE, ZENER 9V
	J19-1634-04	HOLDER FOR LEAD	D002	MTZ9.1JC	DIODE, ZENER 9V
	J19-1635-04	HOLDER FOR LEAD	J001	E31-2367-15	LEAD WIRE WITH CONNECTOR
	J21-2573-04	HOLDER FOR LEG	Q001	25K30A(D)	FET, N-CHANNEL
	J21-2970-23	BLACKET FOR CRT	Q002	25A1005(K)	TR. SI, PNP
	J21-2972-04	PLATE FOR POWER CORD	Q003	25A1005(K)	TR. SI, PNP
	J21-4512-04	BLACKET FOR CRT	Q004	25C2786(K)	TR. SI, NPN
	J25-3000-05	P.C.BOARD (FOR LAMP ASS'Y)	Q005	25C2786(K)	TR. SI, NPN
	J31-0603-04	COLLAR	R001	RD14BB2E220J	RES. CARBON 22 5% 1/4W
	J42-0083-05	BUSHING	R002	RD14BB2E105J	RES. CARBON 1M 5% 1/4W
	J42-0524-04	BUSHING	R003	RD14BB2E220J	RES. CARBON 22 5% 1/4W
	J59-0403-05	NYLON RIVET	R004	RD14BB2E220J	RES. CARBON 22 5% 1/4W
	J61-0408-05	WIRE WRAPPING BAND	R005	RN14BK2E9903F	RES. METAL FILM 990K 1% 1/4W
	J61-0515-05	SUPPORT (I TYPE)	R006	RN14BK2E1113F	RES. METAL FILM 111K 1% 1/4W
	J61-0516-05	SUPPORT (T TYPE)	R007	RD14BB2E820J	RES. CARBON 82 5% 1/4W
	J61-0517-05	STADOFF CLIP	R008	RN14BK2E9903F	RES. METAL FILM 990K 1% 1/4W
	K01-0518-05	HANDLE	R009	RN14BK2E1012F	RES. METAL FILM 10.1K 1% 1/4W
	K21-0851-03	KNOB	R010	RD14BB2E100J	RES. CARBON 10 5% 1/4W
	K21-0853-13	KNOB	R011	RN14BK2E1004F	RES. METAL FILM 1M 1% 1/4W
	K21-0854-13	KNOB	R012	RD14BB2E104J	RES. CARBON 100K 5% 1/4W
	K21-0855-14	KNOB	R013	RN14BK2E3900F	RES. METAL FILM 390 1% 1/4W
	K21-0856-13	KNOB	R014	RD14BB2E101J	RES. CARBON 100 5% 1/4W
	K27-0526-04	KNOB FOR LEVER	R015	RN14BK2E3900F	RES. METAL FILM 390 1% 1/4W
	L01-9344-15	POWER TRANSFORMER	R016	RD14BB2C101J	RES. CARBON 100 5% 1/6W
	L39-0518-05	ROTATOR COIL	R017	RD14BB2C302J	RES. CARBON 3K 5% 1/6W
	N08-0611-04	DRESSED SCREW	R018	RD14BB2C101J	RES. CARBON 100 5% 1/6W
	N09-0715-04	SCREW, PAN HD M 4X31	R019	RD14BB2E271J	RES. CARBON 270 5% 1/4W
	N09-0716-05	SCREW	R020	NO USE	
	N09-0717-05	SCREW, TRUSS HD M 3X12	R021	RD14BB2E124J	RES. CARBON 120K 5% 1/4W
	N09-0720-05	SCREW, SEMS PAN HD	R022	RD14BB2E220J	RES. CARBON 22 5% 1/4W
	N10-2070-46	NUT, HEX	R023	RD14BB2E562J	RES. CARBON 5.6K 5% 1/4W
	N15-1030-41	WASHER, FLAT FOR M3	R024	RD14BB2E562J	RES. CARBON 5.6K 5% 1/4W
	N15-1040-41	WASHER	R025	RD14BB2E392J	RES. CARBON 3.9K 5% 1/4W
	N19-0191-05	WASHER NONMETAL	R026	RD14BB2E753J	RES. CARBON 75K 5% 1/4W
	N30-3004-46	SCREW, PAN HD M 3X4	R027	RD14BB2E754J	RES. CARBON 750K 5% 1/4W
	N30-3006-46	SCREW, PAN HD M 3X6	R028	RD14BB2E122J	RES. CARBON 1.2K 5% 1/4W
	N88-3006-46	SCREW, FLAT HD TAP TITE	R029	RD14BB2C332J	RES. CARBON 3.3K 5% 1/6W
	N89-3006-41	SCREW, BINDING TAP TITE	R030	RD14BB2E332J	RES. CARBON 3.3K 5% 1/4W
	R03-3502-15	V.R. 10K B	R031	RD14BB2E332J	RES. CARBON 3.3K 5% 1/4W
	R05-3504-05	V.R. 10K B	R032	RD14BB2C561J	RES. CARBON 560 5% 1/6W
	R05-3505-05	V.R. 20K B	R033	RN14BK2E9100F	RES. METAL FILM 910 1% 1/4W
	R05-8001-05	V.R. 3M B	R034	RN14BK2E1000F	RES. METAL FILM 100 1% 1/4W
	W01-0503-04	CORD WRAP	R035	RD14BB2E220J	RES. CARBON 22 5% 1/4W
	X73-1490-03	VERTICAL POWER SUPPLY UNIT	R036	RN14BK2E3000F	RES. METAL FILM 300 1% 1/4W
	X74-1340-03	HORIZONTAL UNIT	R037	RN14BK2E1800F	RES. METAL FILM 180 1% 1/4W
	X75-1140-03	VERTICAL ATTENUATOR UNIT	R038	RN14BK2E1200F	RES. METAL FILM 120 1% 1/4W
	X77-1260-03	CONNECTION UNIT	R039	RD14BB2E151J	RES. CARBON 150 5% 1/4W
	X81-1250-01	C.R.T SOCKET UNIT	R040	RD14BB2E560J	RES. CARBON 56 5% 1/4W
	Y87-1840-00	PROBE PC-20	R041	RN14BK2E3000F	RES. METAL FILM 300 1% 1/4W
	150GTM31	CRT	R042	RN14BK2E1800F	RES. METAL FILM 180 1% 1/4W
	212-2014-05	TUBE (PLASTIC)	R043	RN14BK2E1200F	RES. METAL FILM 120 1% 1/4W
	212-3017-05	TUBE (PLASTIC)	R044	RD14BB2E151J	RES. CARBON 150 5% 1/4W
Q001	2SD613(E)	TR. SI, NPN	R045	RD14BB2E560J	RES. CARBON 56 5% 1/4W
R100	RD14BB2E431J	RES. CARBON 430 5% 1/4W	R046	RD14BB2E333J	RES. CARBON 33K 5% 1/4W
			R047	RD14BB2E473J	RES. CARBON 47K 5% 1/4W
			R048	RD14BB2E472J	RES. CARBON 4.7K 5% 1/4W
			R049	RD14BB2C163J	RES. CARBON 16K 5% 1/6W
			R050	RD14BB2C131J	RES. CARBON 130 5% 1/6W
			R051	NO USE	
			R052	RD14BB2C910J	RES. CARBON 91 5% 1/6W
			R053	RD14BB2C111J	RES. CARBON 110 5% 1/6W
			R054	RD14BB2E220J	RES. CARBON 22 5% 1/4W
			S001	S32-4007-05	SLIDE SWITCH
			S002	S02-3501-15	ROTARY SWITCH
			TC001	C05-0427-05	CAP. TRIMMER 10P
			TC002	C05-0428-05	CAP. TRIMMER 20P
			TC003	C05-0427-05	CAP. TRIMMER 10P
			TC004	C05-0428-05	CAP. TRIMMER 20P
			TC005	C05-0427-05	CAP. TRIMMER 10P
C001	C91-0501-05	CAP. METAL FILM 0.047 10% 630V	U001	M47F(C)	FET, DUAL SI, N-CHANNEL
C002	CM93BD2A470J	CAP. MICA 47P 5% 100V	U002	2SA884	TR. SI, PNP
C003	CM93BD2A471J	CAP. MICA 470P 5% 100V	U003	M47F(B)	FET
C004	C91-0502-05	CAP. METAL FILM 0.01 20% 630V			
C005	CK45B1H103K	CAP. CERAMIC 0.01 10% 50V			
C006	CC45CH1H05C	CAP. CERAMIC 0.5P 0.25P 50V			

VERTICAL ATTENUATOR UNIT (X75-1140-00)

REF.NO	PARTS NO	NAME & DESCRIPTION
1	A72-0828-03	SUB PANEL
2	E04-0251-05	ENC. RECEPTACLE
	E33-4038-00	WIRE BASKY
3	F10-1564-04	SHIELD PLATE
	F10-1566-04	SHIELD PLATE
	J25-2997-13	PCB (UNMOUNTED)
4	K21-0852-03	KNOB
5	K21-0855-14	KNOB
	N30-3006-46	SCREW, PAN HD M 3X6
	N89-3006-41	SCREW, BINDING TAP TITE
	R92-0150-05	JUMPING RES. ZERO OHM
	212-2014-05	TUBE (PLASTIC)

PARTS LIST

REF.NO	PARTS NO	NAME & DESCRIPTION
VR002	R12-3502-05	RES. SEMI FIXED 33K B
VR003	R12-3502-05	RES. SEMI FIXED 33K B
VR004	R12-3502-05	RES. SEMI FIXED 33K B
VR005	S02-3501-15	ROTARY SWITCH

REF.NO	PARTS NO	NAME & DESCRIPTION			
R041	RN14BK2E3000F	RES. METAL FILM	300	1%	1/4W
R042	RN14BK2E1800F	RES. METAL FILM	180	1%	1/4W
R043	RN14BK2E1200F	RES. METAL FILM	120	1%	1/4W
R044	RD14BB2E151J	RES. CARBON	150	5%	1/4W
R045	RD14BB2E560J	RES. CARBON	56	5%	1/4W
R046	RD14BB2E333J	RES. CARBON	33K	5%	1/4W
R047	RD14BB2E473J	RES. CARBON	47K	5%	1/4W
R048	RD14BB2E472J	RES. CARBON	4.7K	5%	1/4W
R049	RD14BB2C163J	RES. CARBON	16K	5%	1/6W
R050	RD14BB2C131J	RES. CARBON	130	5%	1/6W
R051	NO USE				
R052	RD14BB2C910J	RES. CARBON	91	5%	1/6W
R053	RD14BB2C111J	RES. CARBON	110	5%	1/6W

VERTICAL ATTENUATOR UNIT

(X75-1140-01)

REF.NO	PARTS NO	NAME & DESCRIPTION			
	A22-0828-03	SUB PANEL			
	E04-0251-05	BNC RECEPTACLE			
	E33-4038-00	WIRE ASSY			
	F10-1564-04	SHIELD PLATE			
	F10-1566-04	SHIELD PLATE			
	J25-2997-13	PCB (UNMOUNTED)			
	K21-0852-03	KNOB			
	K21-0855-14	KNOB			
	N30-3006-46	SCREW, PAN HD M 3X6			
	N89-3006-41	SCREW, BINDING TAP TITE			
	R92-0150-05	JUMPING RES. ZERO OHM			
C001	C91-0501-05	CAP. METAL FILM 0.047 10%	630V		
C002	CM93B02A470J	CAP. MICA 47P	5%	100V	
C003	CM93B02A471J	CAP. MICA 470P	5%	100V	
C004	C91-0502-05	CAP. METAL FILM 0.01 20%	630V		
C005	CK45B1H103K	CAP. CERAMIC 0.01 10%	50V		
C006	CC45CH1H05C	CAP. CERAMIC 0.5P 0.25P	50V		
C009	CC45CH1H470J	CAP. CERAMIC 47P	5%	50V	
C010	CK45B1H103K	CAP. CERAMIC 0.01 10%	50V		
C011	CK45B1H103K	CAP. CERAMIC 0.01 10%	50V		
C012	CK45B1H103K	CAP. CERAMIC 0.01 10%	50V		
C013	CE04W1E470M	CAP. ELECTRO 47	20%	25V	
C014	CE04W1E470M	CAP. ELECTRO 47	20%	25V	
C015	CE04W1E470M	CAP. ELECTRO 47	20%	25V	
C016	CE04W1E470M	CAP. ELECTRO 47	20%	25V	
C017	CC45CH1H030C	CAP. CERAMIC 3P 0.25P	50V		
C018	CC45CH1H010C	CAP. CERAMIC 1P 0.25P	50V		
C019	CE04B1H010M	CAP. ELECTRO 1	20%	50V	
C020	CK45B1H152K	CAP. CERAMIC 1500P 10%	50V		
C021	NO USE				
C022	CK45B1H103K	CAP. CERAMIC 0.01 10%	50V		
C023	CK45B1H103K	CAP. CERAMIC 0.01 10%	50V		

D001	WZ-090	DIODE			
D002	WZ-090	DIODE			
J001	E31-2367-15	LEAD WIRE WITH CONNECTOR			

Q001	2SK30A(D)	FET, N-CHANNEL			
Q002	2SA1005(K)	TR. SI, PNP			
Q003	2SA1005(K)	TR. SI, PNP			
Q004	2SC2786(K)	TR. SI, NPN			
Q005	2SC2786(K)	TR. SI, NPN			
R001	RD14BB2E220J	RES. CARBON 22	5%	1/4W	
R002	RD14BB2E105J	RES. CARBON 1M	5%	1/4W	
R003	RD14BB2E220J	RES. CARBON 22	5%	1/4W	
R004	RD14BB2E220J	RES. CARBON 22	5%	1/4W	
R005	RN14BK2E9003F	RES. METAL FILM 900K	1%	1/4W	
R006	RN14BK2E1113F	RES. METAL FILM 111K	1%	1/4W	
R007	RD14BB2E620J	RES. CARBON 82	5%	1/4W	
R008	RN14BK2E9903F	RES. METAL FILM 990K	1%	1/4W	
R009	RN14BK2E1012F	RES. METAL FILM 10.1K	1%	1/4W	
R010	RD14BB2E100J	RES. CARBON 10	5%	1/4W	
R011	RN14BK2E1004F	RES. METAL FILM 1M	1%	1/4W	
R012	RD14BB2E104J	RES. CARBON 100K	5%	1/4W	
R013	RN14BK2E3900F	RES. METAL FILM 390	1%	1/4W	
R014	RD14BB2E101J	RES. CARBON 100	5%	1/4W	
R015	RN14BK2E3900F	RES. METAL FILM 390	1%	1/4W	
R016	RD14BB2C101J	RES. CARBON 100	5%	1/6W	
R017	RD14BB2C302J	RES. CARBON 3K	5%	1/6W	
R018	RD14BB2C101J	RES. CARBON 100	5%	1/6W	
R019	RD14BB2E271J	RES. CARBON 270	5%	1/4W	
R020	NO USE				
R021	RD14BB2E274J	RES. CARBON 270K	5%	1/4W	
R022	RD14BB2E220J	RES. CARBON 22	5%	1/4W	
R023	RD14BB2E562J	RES. CARBON 5.6K	5%	1/4W	
R024	RD14BB2E562J	RES. CARBON 5.6K	5%	1/4W	
R025	RD14BB2E392J	RES. CARBON 3.9K	5%	1/4W	
R026	RD14BB2E753J	RES. CARBON 75K	5%	1/4W	
R027	RD14BB2E754J	RES. CARBON 750K	5%	1/4W	
R028	RD14BB2E122J	RES. CARBON 1.2K	5%	1/4W	
R029	RD14BB2C332J	RES. CARBON 3.3K	5%	1/6W	
R030	RD14BB2E332J	RES. CARBON 3.3K	5%	1/4W	
R031	RD14BB2E332J	RES. CARBON 3.3K	5%	1/4W	
R032	RD14BB2C561J	RES. CARBON 560	5%	1/6W	
R033	RN14BK2E9100F	RES. METAL FILM 910	1%	1/4W	
R034	RN14BK2E1000F	RES. METAL FILM 100	1%	1/4W	
R035	RD14BB2E220J	RES. CARBON 22	5%	1/4W	
R036	RN14BK2E3000F	RES. METAL FILM 300	1%	1/4W	
R037	RN14BK2E1800F	RES. METAL FILM 180	1%	1/4W	
R038	RN14BK2E1200F	RES. METAL FILM 120	1%	1/4W	
R039	RD14BB2E151J	RES. CARBON 150	5%	1/4W	
R040	RD14BB2E560J	RES. CARBON 56	5%	1/4W	

S001	S32-4007-05	SLIDE SWITCH			
S002	S02-3501-15	ROTARY SWITCH			
TC001	C05-0427-05	CAP. TRIMMER 10P			
TC002	C05-0428-05	CAP. TRIMMER 20P			
TC003	C05-0427-05	CAP. TRIMMER 10P			
TC004	C05-0428-05	CAP. TRIMMER 20P			
TC005	C05-0427-05	CAP. TRIMMER 10P			

U001	M47F(C)	FET, DUAL SI, N-CHANNEL			
U002	2SA884	TR. SI, PNP			
U003	M47F(B)	FET			

VR002	R12-3502-05	RES. SEMI FIXED 33K B			
VR003	R12-3502-05	RES. SEMI FIXED 33K B			
VR004	R12-3502-05	RES. SEMI FIXED 33K B			

VERTICAL ATTENUATOR UNIT

(X75-1140-02)

REF.NO	PARTS NO	NAME & DESCRIPTION			
	A22-0828-03	SUB PANEL			
	E04-0251-05	BNC RECEPTACLE			
	F10-1564-04	SHIELD PLATE			
	F10-1566-04	SHIELD PLATE			
	J25-2997-13	PCB (UNMOUNTED)			
	K21-0852-03	KNOB			
	K21-0855-14	KNOB			
	N30-3006-46	SCREW, PAN HD M 3X6			
	N89-3006-41	SCREW, BINDING TAP TITE			
	R92-0150-05	JUMPING RES. ZERO OHM			
C001	C91-0501-05	CAP. METAL FILM 0.047 10%	630V		
C002	CM93B02A470J	CAP. MICA 47P	5%	100V	
C003	CM93B02A471J	CAP. MICA 470P	5%	100V	
C004	C91-0502-05	CAP. METAL FILM 0.01 20%	630V		
C005	NO USE				
C006	CC45CH1H1R5C	CAP. CERAMIC 1.5P 0.25P	50V		
C007	NO USE				
C008	CC45CH1H040C	CAP. CERAMIC 4P 0.25P	50V		
C009	CC45CH1H680J	CAP. CERAMIC 68P	5%	50V	
C010	CK45B1H103K	CAP. CERAMIC 0.01 10%	50V		
C011	CK45B1H103K	CAP. CERAMIC 0.01 10%	50V		
C012	CK45B1H103K	CAP. CERAMIC 0.01 10%	50V		
C013	CE04W1E470M	CAP. ELECTRO 47	20%	25V	
C014	CE04W1E470M	CAP. ELECTRO 47	20%	25V	
C015	CE04W1E470M	CAP. ELECTRO 47	20%	25V	
C016	CE04W1E470M	CAP. ELECTRO 47	20%	25V	
C017	CC45CH1H270C	CAP. CERAMIC 27P	5%	50V	
C018	CC45CH1H020C	CAP. CERAMIC 2P 0.25P	50V		
C024	CC45CH1H270J	CAP. CERAMIC 27P	5%	50V	

D001	MTZ9.1JC	DIODE, ZENER 9V			
D002	MTZ9.1JC	DIODE, ZENER 9V			

J001	E31-2367-15	LEAD WIRE WITH CONNECTOR			
------	-------------	--------------------------	--	--	--

Q001	2SK30A(D)	FET, N-CHANNEL			
Q002	2SA1005(K)	TR. SI, PNP			
Q003	2SA1005(K)	TR. SI, PNP			
Q004	2SC2786(K)	TR. SI, NPN			
R001	RD14BB2E220J	RES. CARBON 22	5%	1/4W	
R002	RD14BB2E105J	RES. CARBON 1M	5%	1/4W	
R003	RD14BB2E220J	RES. CARBON 22	5%	1/4W	
R004	RD14BB2E220J	RES. CARBON 22	5%	1/4W	
R005	RN14BK2E9003F	RES. METAL FILM 900K	1%	1/4W	
R006	RN14BK2E1113F	RES. METAL FILM 111K	1%	1/4W	
R007	RD14BB2E620J	RES. CARBON 82	5%	1/4W	
R008	RN14BK2E9903F	RES. METAL FILM 990K	1%	1/4W	
R009	RN14BK2E1012F	RES. METAL FILM 10.1K	1%	1/4W	
R010	RD14BB2E100J	RES. CARBON 10	5%	1/4W	
R011	RN14BK2E1004F	RES. METAL FILM 1M	1%	1/4W	
R012	RD14BB2E104J	RES. CARBON 100K	5%	1/4W	
R013	RN14BK2E27R0F	RES. METAL FILM 27.0	1%	1/4W	
R014	RD14BB2E101J	RES. CARBON 100	5%	1/4W	
R015	RN14BK2E27R0F	RES. METAL FILM 27.0	1%	1/4W	
R016	RD14BB2C101J	RES. CARBON 100	5%	1/6W	
R017	NO USE				
R018	RD14BB2C101J	RES. CARBON 100	5%	1/6W	

PARTS LIST

REF. NO	PARTS NO	NAME & DESCRIPTION			
R019	RD148B2E121J	RES. CARBON	120	5%	1/4W
R020	RD148B2E473J	RES. CARBON	47K	5%	1/4W
R021	RD148B2E474J	RES. CARBON	470K	5%	1/4W
R022	RD148B2E220J	RES. CARBON	22	5%	1/4W
R023	RD148B2E562J	RES. CARBON	5.6K	5%	1/4W
R024	RD148B2E562J	RES. CARBON	5.6K	5%	1/4W
R025	RD148B2E392J	RES. CARBON	3.9K	5%	1/4W
R026	RD148B2E753J	RES. CARBON	75K	5%	1/4W
R027	RD148B2E754J	RES. CARBON	750K	5%	1/4W
R028	RD148B2E122J	RES. CARBON	1.2K	5%	1/4W
R029	RD148B2C332J	RES. CARBON	3.3K	5%	1/6W
R030	RD148B2E332J	RES. CARBON	3.3K	5%	1/4W
R031	RD148B2E332J	RES. CARBON	3.3K	5%	1/4W
R032	NO USE				
R033	RN148K2E9100F	RES. METAL FILM	910	1%	1/4W
R034	RN148K2E1000F	RES. METAL FILM	100	1%	1/4W
R035	RD148B2E220J	RES. CARBON	22	5%	1/4W
R036	RN148K2E3000F	RES. METAL FILM	300	1%	1/4W
R037	RN148K2E1800F	RES. METAL FILM	180	1%	1/4W
R038	RN148K2E1200F	RES. METAL FILM	120	1%	1/4W
R039	RD148B2E151J	RES. CARBON	150	5%	1/4W
R040	RD148B2E560J	RES. CARBON	56	5%	1/4W
R041	RN148K2E3000F	RES. METAL FILM	300	1%	1/4W
R042	RN148K2E1800F	RES. METAL FILM	180	1%	1/4W
R043	RN148K2E1200F	RES. METAL FILM	120	1%	1/4W
R044	RD148B2E161J	RES. CARBON	160	5%	1/4W
R045	RD148B2E560J	RES. CARBON	56	5%	1/4W
R046	RD148B2E153J	RES. CARBON	15K	5%	1/4W
R051	RD148B2E361J	RES. CARBON	360	5%	1/4W
R052	RD148B2C910J	RES. CARBON	91	5%	1/6W
R053	RD148B2C111J	RES. CARBON	110	5%	1/6W
S001	S32-4007-05	SLIDE SWITCH			
S002	S02-3501-15	ROTARY SWITCH			
TC001	C05-0427-05	CAP. TRIMMER	10P		
TC002	C05-0428-05	CAP. TRIMMER	20P		
TC003	C05-0427-05	CAP. TRIMMER	10P		
TC004	C05-0428-05	CAP. TRIMMER	20P		
TC005	C05-0427-05	CAP. TRIMMER	10P		
U001	M47F(C)	FET, DUAL SI, N-CHANNEL			
U002	NO USE				
U003	M47F(B)	FET			
VR001	R12-3502-05	RES. SEMI FIXED 33K B			
VR002	R12-3502-05	RES. SEMI FIXED 33K B			
VR003	R12-3502-05	RES. SEMI FIXED 33K B			
VR004	R12-3502-05	RES. SEMI FIXED 33K B			
VR005	S02-3501-15	ROTARY SWITCH			

REF. NO	PARTS NO	NAME & DESCRIPTION			
Q003	2SA1005(K)	TR. SI, PNP			
Q004	2SC2786(K)	TR. SI, NPN			
R001	RD148B2E220J	RES. CARBON	22	5%	1/4W
R002	RD148B2E105J	RES. CARBON	1M	5%	1/4W
R003	RD148B2E220J	RES. CARBON	22	5%	1/4W
R004	RD148B2E220J	RES. CARBON	22	5%	1/4W
R005	RN148K2E9003F	RES. METAL FILM	900K	1%	1/4W
R006	RN148K2E1113F	RES. METAL FILM	111K	1%	1/4W
R007	RD148B2E820J	RES. CARBON	82	5%	1/4W
R008	RN148K2E9903F	RES. METAL FILM	990K	1%	1/4W
R009	RN148K2E1012F	RES. METAL FILM	10.1K	1%	1/4W
R010	RD148B2E100J	RES. CARBON	10	5%	1/4W
R011	RN148K2E1004F	RES. METAL FILM	1M	1%	1/4W
R012	RD148B2E104J	RES. CARBON	100K	5%	1/4W
R013	RN148K2E270F	RES. METAL FILM	27.0	1%	1/4W
R014	RD148B2E101J	RES. CARBON	100	5%	1/4W
R015	RN148K2E270F	RES. METAL FILM	27.0	1%	1/4W
R016	RD148B2C101J	RES. CARBON	100	5%	1/6W
R017	NO USE				
R018	RD148B2C101J	RES. CARBON	100	5%	1/6W
R019	RD148B2E121J	RES. CARBON	120	5%	1/4W
R020	RD148B2E473J	RES. CARBON	47K	5%	1/4W
R021	RD148B2E474J	RES. CARBON	470K	5%	1/4W
R022	RD148B2E220J	RES. CARBON	22	5%	1/4W
R023	RD148B2E562J	RES. CARBON	5.6K	5%	1/4W
R024	RD148B2E562J	RES. CARBON	5.6K	5%	1/4W
R025	RD148B2E392J	RES. CARBON	3.9K	5%	1/4W
R026	RD148B2E753J	RES. CARBON	75K	5%	1/4W
R027	RD148B2E754J	RES. CARBON	750K	5%	1/4W
R028	RD148B2E122J	RES. CARBON	1.2K	5%	1/4W
R029	RD148B2C332J	RES. CARBON	3.3K	5%	1/6W
R030	RD148B2E332J	RES. CARBON	3.3K	5%	1/4W
R031	RD148B2E332J	RES. CARBON	3.3K	5%	1/4W
R032	NO USE				
R033	RN148K2E9100F	RES. METAL FILM	910	1%	1/4W
R034	RN148K2E1000F	RES. METAL FILM	100	1%	1/4W
R035	RD148B2E220J	RES. CARBON	22	5%	1/4W
R036	RN148K2E3000F	RES. METAL FILM	300	1%	1/4W
R037	RN148K2E1800F	RES. METAL FILM	180	1%	1/4W
R038	RN148K2E1200F	RES. METAL FILM	120	1%	1/4W
R039	RD148B2E151J	RES. CARBON	150	5%	1/4W
R040	RD148B2E560J	RES. CARBON	56	5%	1/4W
R041	RN148K2E3000F	RES. METAL FILM	300	1%	1/4W
R042	RN148K2E1800F	RES. METAL FILM	180	1%	1/4W
R043	RN148K2E1200F	RES. METAL FILM	120	1%	1/4W
R044	RD148B2E161J	RES. CARBON	160	5%	1/4W
R045	RD148B2E560J	RES. CARBON	56	5%	1/4W
R046	RD148B2E153J	RES. CARBON	15K	5%	1/4W
R051	RD148B2E361J	RES. CARBON	360	5%	1/4W
R052	RD148B2C910J	RES. CARBON	91	5%	1/6W
R053	RD148B2C111J	RES. CARBON	110	5%	1/6W
S001	S32-4007-05	SLIDE SWITCH			
S002	S02-3501-15	ROTARY SWITCH			
TC001	C05-0427-05	CAP. TRIMMER	10P		
TC002	C05-0428-05	CAP. TRIMMER	20P		
TC003	C05-0427-05	CAP. TRIMMER	10P		
TC004	C05-0428-05	CAP. TRIMMER	20P		
TC005	C05-0427-05	CAP. TRIMMER	10P		
U001	M47F(C)	FET, DUAL SI, N-CHANNEL			
U002	NO USE				
U003	M47F(B)	FET			
VR001	R12-3502-05	RES. SEMI FIXED 33K B			
VR002	R12-3502-05	RES. SEMI FIXED 33K B			
VR003	R12-3502-05	RES. SEMI FIXED 33K B			
VR004	R12-3502-05	RES. SEMI FIXED 33K B			
VR005	S02-3501-15	ROTARY SWITCH			

VERTICAL ATTENUATOR UNIT

(X75-1140-03)

REF. NO	PARTS NO	NAME & DESCRIPTION			
A22-0828-03		SUB PANEL			
E04-0251-05		BNC RECEPTACLE			
F10-1564-04		SHIELD PLATE			
F10-1566-04		SHIELD PLATE			
J25-2997-13		PCB (UNMOUNTED)			
K21-0852-03		KNOB			
K21-0855-14		KNOB			
N30-3006-46		SCREW, PAN HD M 3X6			
N89-3006-41		SCREW, BINDING TAP TITE			
R92-0150-05		JUMPING RES. ZERO OHM			
C001	C91-0501-05	CAP. METAL FILM	0.047	10%	630V
C002	CM93B02A470J	CAP. MICA	47P	5%	100V
C003	CM93B02A471J	CAP. MICA	470P	5%	100V
C004	C91-0502-05	CAP. METAL FILM	0.01	20%	630V
C005	NO USE				
C006	CC45CH1H1R5C	CAP. CERAMIC	1.5P	0.25P	50V
C007	NO USE				
C008	CC45CH1H040C	CAP. CERAMIC	4P	0.25P	50V
C009	CC45CH1H680J	CAP. CERAMIC	68P	5%	50V
C010	CK45B1H103K	CAP. CERAMIC	0.01	10%	50V
C011	CK45B1H103K	CAP. CERAMIC	0.01	10%	50V
C012	CK45B1H103K	CAP. CERAMIC	0.01	10%	50V
C013	CE04W1E470M	CAP. ELECTRO	47	20%	25V
C014	CE04W1E470M	CAP. ELECTRO	47	20%	25V
C015	CE04W1E470M	CAP. ELECTRO	47	20%	25V
C016	CE04W1E470M	CAP. ELECTRO	47	20%	25V
C017	CC45CH1H270J	CAP. CERAMIC	27P	5%	50V
C018	CC45CH1H020C	CAP. CERAMIC	2P	0.25P	50V
C024	CC45CH1H270J	CAP. CERAMIC	27P	5%	50V
D001	MT29.1JC	DIODE, ZENER	9V		
D002	MT29.1JC	DIODE, ZENER	9V		
J001	E31-2367-15	LEAD WIRE WITH CONNECTOR			
Q001	2SK30A(C)	FET, N-CHANNEL			
Q002	2SA1005(K)	TR. SI, PNP			

REF. NO	PARTS NO	NAME & DESCRIPTION			
S001	S32-4007-05	SLIDE SWITCH			
S002	S02-3501-15	ROTARY SWITCH			
TC001	C05-0427-05	CAP. TRIMMER	10P		
TC002	C05-0428-05	CAP. TRIMMER	20P		
TC003	C05-0427-05	CAP. TRIMMER	10P		
TC004	C05-0428-05	CAP. TRIMMER	20P		
TC005	C05-0427-05	CAP. TRIMMER	10P		
U001	M47F(C)	FET, DUAL SI, N-CHANNEL			
U002	NO USE				
U003	M47F(B)	FET			
VR001	R12-3502-05	RES. SEMI FIXED 33K B			
VR002	R12-3502-05	RES. SEMI FIXED 33K B			
VR003	R12-3502-05	RES. SEMI FIXED 33K B			
VR004	R12-3502-05	RES. SEMI FIXED 33K B			
VR005	S02-3501-15	ROTARY SWITCH			

VERTICAL AMP & POWER UNIT

(X73-1490-00)

REF. NO	PARTS NO	NAME & DESCRIPTION			
E23-0526-04		EARTH PLATE			
E33-4031-00		WIRE ASSY			
F01-0835-05		HEAT SINK			
F01-0836-04		HEAT SINK			
J25-2999-13		PCB (UNMOUNTED)			
J61-0517-05		STADOFF CLIP			
N19-0191-05		WASHER NONMETAL			
N19-0702-04		WASHER			
N30-3008-46		SCREW, PAN HD M 3X8			
R92-0150-05		JUMPING RES. ZERO OHM			
T12-1018-05		TUBE (PLASTIC)			
T12-2014-05		TUBE (PLASTIC)			
C002	CC45CH1H1R5C	CAP. CERAMIC	1.5P	0.25P	50V
C006	CC45CH1H221J	CAP. CERAMIC	220P	5%	50V
C007	CK45B1H103K	CAP. CERAMIC	0.01	10%	50V

PARTS LIST

REF.NO	PARTS NO	NAME & DESCRIPTION	REF.NO	PARTS NO	NAME & DESCRIPTION
C008	CE04W1E470M	CAP. ELECTRO 47 20% 25V	Q014	2SC2786(K)	TR. SI, NPN
C009	CE04W1E470M	CAP. ELECTRO 47 20% 25V	Q015	2SC2407	TR. SI, NPN
C010	CE04W1E470M	CAP. ELECTRO 47 20% 25V	Q016	2SC2407	TR. SI, NPN
C011	CE04W1E470M	CAP. ELECTRO 47 20% 25V	Q017	2SC2912(R,S)	TR. SI, NPN
C012	NO USE		Q018	2SC2912(R,S)	TR. SI, NPN
C013	CC45CH1H470J	CAP. CERAMIC 47P 5% 50V	Q102	2SA1005(K)	TR. SI, PNP
C014	CE04W1E220M	CAP. ELECTRO 22 20% 25V	Q103	2SA1005(K)	TR. SI, PNP
C015	NO USE		Q104	2SC2786(K)	TR. SI, NPN
C016	CE04W1E220M	CAP. ELECTRO 22 20% 25V	Q105	2SC2786(K)	TR. SI, NPN
C017	CE04W1E220M	CAP. ELECTRO 22 20% 25V	Q106	2SC2785(F)	TR. SI, NPN
C020	CC45CH1H1R5C	CAP. CERAMIC 1.5P 0.25P 50V	Q107	2SC2786(K)	TR. SI, NPN
C102	CC45CH1H010C	CAP. CERAMIC 1P 0.25P 50V	Q108	2SC2786(K)	TR. SI, NPN
C103	NO USE		Q109	2SC2786(K)	TR. SI, NPN
C104	CE04W1E470M	CAP. ELECTRO 47 20% 25V	Q110	2SC2786(K)	TR. SI, NPN
C105	CE04W1E470M	CAP. ELECTRO 47 20% 25V	Q111	2SC2786(K)	TR. SI, NPN
C106	CE04W1E470M	CAP. ELECTRO 47 20% 25V	Q112	2SC2786(K)	TR. SI, NPN
C107	CE04W1E470M	CAP. ELECTRO 47 20% 25V	Q113	2SA1175(F)	TR. SI, PNP
C108	NO USE		Q114	2SC2785(F)	TR. SI, NPN
C109	CC45CH1H470J	CAP. CERAMIC 47P 5% 50V	Q115	2SC2786(K)	TR. SI, NPN
C110	CC45CH1H470J	CAP. CERAMIC 47P 5% 50V	Q301	2SA1009(L,K)	TR. SI, PNP
C111	CE04W1H010M	CAP. ELECTRO 1 20% 50V	Q302	2SA1009(L,K)	TR. SI, PNP
C112	CK45B1H103K	CAP. CERAMIC 0.01 10% 50V	Q303	2SA1175(F)	TR. SI, PNP
C115	CC45CH1H020C	CAP. CERAMIC 2P 0.25P 50V	Q304	2SA1175(F)	TR. SI, PNP
C301	CE04W1V222M	CAP. ELECTRO 2200 20% 35V	Q305	2SC2271(E)	TR. SI, NPN
C302	CE04W1V222M	CAP. ELECTRO 2200 20% 35V	Q306	2SC2271(E)	TR. SI, NPN
C303	CE04W1E222M	CAP. ELECTRO 2200 20% 25V	R001	RD148B2E105J	RES. CARBON 1M 5% 1/4W
C304	C90-0910-05	CAP. ELECTRO 100 20% 200V	R002	RD148B2E220J	RES. CARBON 22 5% 1/4W
C305	CE04W2E470	CAP. ELECTRO 47 250V	R003	RD148B2E562J	RES. CARBON 5.6K 5% 1/4W
C306	CE04W1A101M	CAP. ELECTRO 100 20% 10V	R004	RD148B2E562J	RES. CARBON 5.6K 5% 1/4W
C307	CE04W1E101M	CAP. ELECTRO 100 20% 25V	R005	RD148B2E120J	RES. CARBON 12 5% 1/4W
C308	CE04W1E101M	CAP. ELECTRO 100 20% 25V	R006	RD148B2E510J	RES. CARBON 51 5% 1/4W
C309	CE04W2C100	CAP. ELECTRO 10 140V	R007	RD148B2E510J	RES. CARBON 51 5% 1/4W
C310	CE04W2E010	CAP. ELECTRO 1 250V	R008	RD148B2E392J	RES. CARBON 3.9K 5% 1/4W
C311	CE04BW1H010M	CAP. ELECTRO 1 20% 50V	R009	RD148B2E102J	RES. CARBON 1K 5% 1/4W
C312	CE04W1H010M	CAP. ELECTRO 1 20% 50V	R010	RD148B2E302J	RES. CARBON 3K 5% 1/4W
C313	CK45B1H103K	CAP. CERAMIC 0.01 10% 50V	R011	RD148B2E220J	RES. CARBON 22 5% 1/4W
C314	CE04W1H010M	CAP. ELECTRO 1 20% 50V	R012	RD148B2E243J	RES. CARBON 24K 5% 1/4W
C315	CK45B1H103K	CAP. CERAMIC 0.01 10% 50V	R013	RD148B2E302J	RES. CARBON 3K 5% 1/4W
C316	CE04W1H010M	CAP. ELECTRO 1 20% 50V	R014	RN148K2E1000F	RES. METAL FILM 100 1% 1/4W
C317	CK45B1H103K	CAP. CERAMIC 0.01 10% 50V	R015	RN148K2E1301F	RES. METAL FILM 1.3K 1% 1/4W
C318	CK45B1H102K	CAP. CERAMIC 1000P 10% 50V	R016	RD148B2E220J	RES. CARBON 22 5% 1/4W
C319	CK45B1H102K	CAP. CERAMIC 1000P 10% 50V	R017	RD148B2E302J	RES. CARBON 3K 5% 1/4W
C320	CK45B2H103K	CAP. CERAMIC 0.01 10% 500V	R018	RD148B2E104J	RES. CARBON 100K 5% 1/4W
D001	DS442X	DIODE	R019	RD148B2E220J	RES. CARBON 22 5% 1/4W
D002	DS442X	DIODE	R020	RD148B2E331J	RES. CARBON 330 5% 1/4W
D003	DS442X	DIODE	R021	RD148B2E331J	RES. CARBON 330 5% 1/4W
D101	DS442X	DIODE	R022	NO USE	
D102	DS442X	DIODE	R023	RD148B2E220J	RES. CARBON 22 5% 1/4W
D103	DS442X	DIODE	R024	RD148B2E222J	RES. CARBON 2.2K 5% 1/4W
D104	DS442X	DIODE	R025	RD148B2E101J	RES. CARBON 100 5% 1/4W
D105	DS442X	DIODE	R026	RD148B2E152J	RES. CARBON 1.5K 5% 1/4W
D106	DS442X	DIODE	R027	RD148B2E152J	RES. CARBON 1.5K 5% 1/4W
D107	DS442X	DIODE	R028	RD148B2E270J	RES. CARBON 27 5% 1/4W
D108	MTZ10JC	DIODE, ZENER 10V	R029	RD148B2E270J	RES. CARBON 27 5% 1/4W
D301	S2VB40F	DIODE, BRIDGE	R030	RD148B2E100J	RES. CARBON 10 5% 1/4W
D302	S2VB40F	DIODE, BRIDGE	R031	RD148B2E151J	RES. CARBON 150 5% 1/4W
D303	S1VB60	DIODE	R032	RD148B2E101J	RES. CARBON 100 5% 1/4W
D304	S1VB60	DIODE	R033	RD148B2E101J	RES. CARBON 100 5% 1/4W
D305	DS442X	DIODE	R034	RD148B2E222J	RES. CARBON 2.2K 5% 1/4W
D306	DS442X	DIODE	R035	RD148B2E222J	RES. CARBON 2.2K 5% 1/4W
D307	V068	DIODE	R036	RN148K2E2201F	RES. METAL FILM 2.2K 1% 1/4W
L001	L40-1025-03	FERRI INDUCTOR	R037	RN148K2E2201F	RES. METAL FILM 2.2K 1% 1/4W
L002	L40-1025-03	FERRI INDUCTOR	R038	RD148B2E750J	RES. CARBON 75 5% 1/4W
P001	E40-0473-05	PIN CONNECTOR 4 P	R039	RD148B2E431J	RES. CARBON 430 5% 1/4W
P002	E40-0273-05	PIN CONNECTOR 2 P	R040	RD148B2E682J	RES. CARBON 6.8K 5% 1/4W
P003	E04-0154-05	BNC RECEPTACLE	R041	RD148B2E332J	RES. CARBON 3.3K 5% 1/4W
P004	E23-0046-04	TERMINAL	R042	RD148B2E471J	RES. CARBON 470 5% 1/4W
P005	E23-0046-04	TERMINAL	R043	RD148B2E471J	RES. CARBON 470 5% 1/4W
P101	E40-0473-05	PIN CONNECTOR 4 P	R044	RN148K2E8200F	RES. METAL FILM 820 1% 1/4W
P301	E40-0930-05	PIN CONNECTOR 9P	R045	RN148K2E8200F	RES. METAL FILM 820 1% 1/4W
P302	E40-1116-05	PIN CONNECTOR 11P	R046	RN148K2E8200F	RES. METAL FILM 820 1% 1/4W
P303	E40-1116-05	PIN CONNECTOR 11P	R047	RN148K2E8200F	RES. METAL FILM 820 1% 1/4W
Q002	2SA1005(K)	TR. SI, PNP	R048	RD148B2E101J	RES. CARBON 100 5% 1/4W
Q003	2SA1005(K)	TR. SI, PNP	R049	RD148B2E302J	RES. CARBON 3K 5% 1/4W
Q004	2SC2786(K)	TR. SI, NPN	R050	RD148B2E302J	RES. CARBON 3K 5% 1/4W
Q005	2SC2786(K)	TR. SI, NPN	R051	RD148B2E101J	RES. CARBON 100 5% 1/4W
Q006	2SC2786(K)	TR. SI, NPN	R052	RD148B2E220J	RES. CARBON 22 5% 1/4W
Q007	2SC2786(K)	TR. SI, NPN	R053	RD148B2E220J	RES. CARBON 22 5% 1/4W
Q008	2SA1005(K)	TR. SI, PNP	R054	RD148B2E201J	RES. CARBON 200 5% 1/4W
Q009	2SC2786(K)	TR. SI, NPN	R055	RD148B2E201J	RES. CARBON 200 5% 1/4W
Q010	2SC2786(K)	TR. SI, NPN	R056	RD148B2E121J	RES. CARBON 120 5% 1/4W
Q011	2SC2786(K)	TR. SI, NPN	R057	NO USE	
Q012	2SC2786(K)	TR. SI, NPN	R058	RD148B2E101J	RES. CARBON 100 5% 1/4W
Q013	2SC2786(K)	TR. SI, NPN	R059	RD148B2E101J	RES. CARBON 100 5% 1/4W
			R060	RS148B3F681J	RES. METAL FILM 680 5% 3W
			R061	RS148B3F681J	RES. METAL FILM 680 5% 3W
			R062	RS148B3F681J	RES. METAL FILM 680 5% 3W
			R063	RS148B3F681J	RES. METAL FILM 680 5% 3W
			R064	RD148B2E104J	RES. CARBON 100K 5% 1/4W
			R065	RD148B2E201J	RES. CARBON 200 5% 1/4W
			R066	RD148B2E511J	RES. CARBON 510 5% 1/4W
			R067	RD148B2E562J	RES. CARBON 5.6K 5% 1/4W
			R068	RD148B2E104J	RES. CARBON 100K 5% 1/4W

PARTS LIST

REF.NO	PARTS NO	NAME & DESCRIPTION	RES.	CARBON	22K	5%	1/4W
R101	RD148B2E105J	RES. CARBON	1M	5%	1/4W		
R102	RD148B2E220J	RES. CARBON	22	5%	1/4W		
R103	RD148B2E562J	RES. CARBON	5.6K	5%	1/4W		
R104	RD148B2E562J	RES. CARBON	5.6K	5%	1/4W		
R105	RD148B2E120J	RES. CARBON	12	5%	1/4W		
R106	RD148B2E510J	RES. CARBON	51	5%	1/4W		
R107	RD148B2E510J	RES. CARBON	51	5%	1/4W		
R108	RD148B2E392J	RES. CARBON	3.9K	5%	1/4W		
R109	RD148B2E102J	RES. CARBON	1K	5%	1/4W		
R110	RD148B2E302J	RES. CARBON	3K	5%	1/4W		
R111	RD148B2E220J	RES. CARBON	22	5%	1/4W		
R112	RD148B2E243J	RES. CARBON	24K	5%	1/4W		
R113	RD148B2E302J	RES. CARBON	3K	5%	1/4W		
R114	RN148K2E1000F	RES. METAL FILM	100	1%	1/4W		
R115	RD148B2E104J	RES. CARBON	100K	5%	1/4W		
R116	RN148K2E1301F	RES. METAL FILM	1.3K	1%	1/4W		
R117	RD148B2E220J	RES. CARBON	22	5%	1/4W		
R118	RD148B2E182J	RES. CARBON	1.8K	5%	1/4W		
R119	RD148B2E223J	RES. CARBON	22K	5%	1/4W		
R120	RD148B2E220J	RES. CARBON	22	5%	1/4W		
R121	RD148B2E561J	RES. CARBON	560	5%	1/4W		
R122	NO USE						
R123	RD148B2E333J	RES. CARBON	33K	5%	1/4W		
R124	RD148B2E151J	RES. CARBON	150	5%	1/4W		
R125	RD148B2E101J	RES. CARBON	100	5%	1/4W		
R126	RD148B2E101J	RES. CARBON	100	5%	1/4W		
R127	RD148B2E222J	RES. CARBON	2.2K	5%	1/4W		
R128	RD148B2E222J	RES. CARBON	2.2K	5%	1/4W		
R129	RN148K2E2201F	RES. METAL FILM	2.2K	1%	1/4W		
R130	RN148K2E2201F	RES. METAL FILM	2.2K	1%	1/4W		
R131	RD148B2E750J	RES. CARBON	75	5%	1/4W		
R132	RN148K2E2001F	RES. METAL FILM	2K	1%	1/4W		
R133	RN148K2E2001F	RES. METAL FILM	2K	1%	1/4W		
R134	RD148B2E510J	RES. CARBON	51	5%	1/4W		
R135	RD148B2E511J	RES. CARBON	510	5%	1/4W		
R136	RD148B2E123J	RES. CARBON	12K	5%	1/4W		
R137	RD148B2E472J	RES. CARBON	4.7K	5%	1/4W		
R138	RD148B2E332J	RES. CARBON	3.3K	5%	1/4W		
R139	RD148B2E332J	RES. CARBON	3.3K	5%	1/4W		
R140	RD148B2E471J	RES. CARBON	470	5%	1/4W		
R141	RD148B2E471J	RES. CARBON	470	5%	1/4W		
R142	RD148B2E471J	RES. CARBON	470	5%	1/4W		
R143	RD148B2E471J	RES. CARBON	470	5%	1/4W		
R144	RD148B2E272J	RES. CARBON	2.7K	5%	1/4W		
R145	RD148B2E153J	RES. CARBON	15K	5%	1/4W		
R146	RD148B2E153J	RES. CARBON	15K	5%	1/4W		
R147	RD148B2E272J	RES. CARBON	2.7K	5%	1/4W		
R148	RD148B2E223J	RES. CARBON	22K	5%	1/4W		
R149	RD148B2E682J	RES. CARBON	6.8K	5%	1/4W		
R150	RD148B2E102J	RES. CARBON	1K	5%	1/4W		
R151	RD148B2E102J	RES. CARBON	1K	5%	1/4W		
R152	RD148B2E151J	RES. CARBON	150	5%	1/4W		
R153	RD148B2E101J	RES. CARBON	100	5%	1/4W		
R154	NO USE						
R155	RD148B2E470J	RES. CARBON	47	5%	1/4W		
R156	NO USE						
R157	RD148B2E102J	RES. CARBON	1K	5%	1/4W		
R158	RD148B2E104J	RES. CARBON	100K	5%	1/4W		
R159	RD148B2E682J	RES. CARBON	6.8K	5%	1/4W		
R301	RD148B2E473J	RES. CARBON	47K	5%	1/4W		
R302	RD148B2E102J	RES. CARBON	1K	5%	1/4W		
R303	RD148B2E3R3J	RES. CARBON	3.3	5%	1/4W		
R304	RD148B2E100J	RES. CARBON	10	5%	1/4W		
R305	RD148B2E562J	RES. CARBON	5.6K	5%	1/4W		
R306	RD148B2E822J	RES. CARBON	8.2K	5%	1/4W		
R307	RD148B2E222J	RES. CARBON	2.2K	5%	1/4W		
R308	RD148B2E222J	RES. CARBON	2.2K	5%	1/4W		
R309	RN148K2E1502F	RES. METAL FILM	15K	1%	1/4W		
R310	RN148K2E1003F	RES. METAL FILM	100K	1%	1/4W		
R311	RN148K2E1602F	RES. METAL FILM	16K	1%	1/4W		
R312	RN148K2E1503F	RES. METAL FILM	150K	1%	1/4W		
R313	RD148Y2H104J	RES. CARBON	100K	5%	1/2W		
R314	RD148Y2H104J	RES. CARBON	100K	5%	1/2W		
S101	S42-4509-05	PUSH SWITCH					
TC001	C05-0425-05	CAP. TRIMMER	70P				
TC002	C05-0425-05	CAP. TRIMMER	70P				
TC101	C05-0434-05	CAP. TRIMMER	20P				
TC102	C05-0434-05	CAP. TRIMMER	20P				
TP001	E23-0046-04	TERMINAL					
TP002	E23-0046-04	TERMINAL					
TP003	E23-0046-04	TERMINAL					
TP004	E23-0046-04	TERMINAL					
TP101	E23-0046-04	TERMINAL					
TP102	E23-0046-04	TERMINAL					
TP103	E23-0046-04	TERMINAL					
TP104	E23-0046-04	TERMINAL					
U001	M47F(B)	FET					

REF.NO	PARTS NO	NAME & DESCRIPTION	FET
U101	M47F(B)	FET	
U301	UPC7805H	IC	
U302	UPC7915HA	IC	
U303	NJM7815	IC	
U304	NJM4558D	IC	
VR001	R05-3506-05	V.R.	20K B
VR002	NO USE		
VR003	R12-0539-05	RES. SEMI FIXED	200 B
VR004	R12-0421-05	RES. SEMI FIXED	100 B
VR005	R12-0421-05	RES. SEMI FIXED	100 B
VR006	R12-0421-05	RES. SEMI FIXED	100 B
VR101	R05-3506-05	V.R.	20K B
VR102	R12-3523-05	RES. SEMI FIXED	20K B
VR103	R12-0541-05	RES. SEMI FIXED	100 B
VR104	R12-0543-05	RES. SEMI FIXED	500 B

VERTICAL AMP & POWER UNIT (X73-1490-01)

REF.NO	PARTS NO	NAME & DESCRIPTION			
	E33-4032-00	WIRE ASSY			
	F01-0835-05	HEAT SINK			
	F01-0836-04	HEAT SINK			
	J25-2999-03	PCB (UNMOUNTED)			
	J61-0517-05	STADOFF CLIP			
	N19-0191-05	WASHER NONMETAL			
	N30-3008-46	SCREW, PAN HD	M 3X8		
	R92-0150-05	JUMPING RES.	ZERO OHM		
	212-2014-05	TUBE (PLASTIC)			
C002	CC45CH1H1R5C	CAP. CERAMIC	1.5P	0.25P	50V
C006	CC45CH1H221J	CAP. CERAMIC	220P	5%	50V
C007	CK45B1H103K	CAP. CERAMIC	0.01	10%	50V
C008	CE04W1E470M	CAP. ELECTRO	47	20%	25V
C009	CE04W1E470M	CAP. ELECTRO	47	20%	25V
C010	CE04W1E470M	CAP. ELECTRO	47	20%	25V
C011	CE04W1E470M	CAP. ELECTRO	47	20%	25V
C012	NO USE				
C013	CK45B1H103K	CAP. CERAMIC	0.01	10%	50V
C014	CE04W1E220M	CAP. ELECTRO	22	20%	25V
C015	NO USE				
C016	CE04W1E220M	CAP. ELECTRO	22	20%	25V
C017	CE04BW1E220M	CAP. ELECTRO	22	20%	25V
C020	CC45CH1H1R5C	CAP. CERAMIC	1.5P	0.25P	50V
C301	CE04W1V222M	CAP. ELECTRO	2200	20%	35V
C302	CE04W1V222M	CAP. ELECTRO	2200	20%	35V
C303	CE04W1E222M	CAP. ELECTRO	2200	20%	25V
C304	C90-0910-05	CAP. ELECTRO	100	20%	200V
C305	CE04W2E470M	CAP. ELECTRO	47	20%	250V
C306	CE04W1A101M	CAP. ELECTRO	100	20%	10V
C307	CE04W1E101M	CAP. ELECTRO	100	20%	25V
C308	CE04W1E101M	CAP. ELECTRO	100	20%	25V
C309	CE04W2C100M	CAP. ELECTRO	10	20%	160V
C310	CE04W2E010M	CAP. ELECTRO	1	20%	250V
C311	CE04BW1H010M	CAP. ELECTRO	1	20%	50V
C312	CE04W1H010M	CAP. ELECTRO	1	20%	50V
C313	CK45B1H103K	CAP. CERAMIC	0.01	10%	50V
C314	CE04W1H010M	CAP. ELECTRO	1	20%	50V
C315	CK45B1H103K	CAP. CERAMIC	0.01	10%	50V
C316	CE04W1H010M	CAP. ELECTRO	1	20%	50V
C317	CK45B1H103K	CAP. CERAMIC	0.01	10%	50V
C318	CK45B1H102K	CAP. CERAMIC	1000P	10%	50V
C319	CK45B1H102K	CAP. CERAMIC	1000P	10%	50V
C320	CK45B2H103K	CAP. CERAMIC	0.01	10%	500V
D001	DS442X	DIODE			
D002	DS442X	DIODE			
D003	DS442X	DIODE			
D301	S2VB40F	DIODE, BRIDGE			
D302	S2VB40F	DIODE, BRIDGE			
D303	S1QB60	DIODE			
D304	S1QB60	DIODE			
D305	DS442X	DIODE			
D306	DS442X	DIODE			
D307	V06B	DIODE			
L001	L40-1025-03	FERRI INDUCTOR			
L002	L40-1025-03	FERRI INDUCTOR			
P001	E40-0473-05	PIN CONNECTOR	4P		
P002	E40-0273-05	PIN CONNECTOR	2P		
P003	E04-0154-05	BNC RECEPTACLE			
P301	E40-0930-05	PIN CONNECTOR	9P		
P302	E40-1116-05	PIN CONNECTOR	11P		
P303	E40-1116-05	PIN CONNECTOR	11P		

PARTS LIST

REF. NO	PARTS NO	NAME & DESCRIPTION
Q002	2SA1005(K)	TR. SI, PNP
Q003	2SA1005(K)	TR. SI, PNP
Q004	2SC2786(K)	TR. SI, NPN
Q005	2SC2786(K)	TR. SI, NPN
Q006	2SC2786(K)	TR. SI, NPN
Q007	2SC2786(K)	TR. SI, NPN
Q008	2SA1005(K)	TR. SI, PNP
Q009	2SC2786(K)	TR. SI, NPN
Q010	2SC2786(K)	TR. SI, NPN
Q011	2SC2786(K)	TR. SI, NPN
Q012	2SC2786(K)	TR. SI, NPN
Q013	2SC2786(K)	TR. SI, NPN
Q014	2SC2786(K)	TR. SI, NPN
Q015	2SC2407	TR. SI, NPN
Q016	2SC2407	TR. SI, NPN
Q017	2SC2912(R,S)	TR. SI, NPN
Q018	2SC2912(R,S)	TR. SI, NPN
Q301	2SA1009(L,K)	TR. SI, PNP
Q302	2SA1009(L,K)	TR. SI, PNP
Q303	2SA1175(F)	TR. SI, PNP
Q304	2SA1175(F)	TR. SI, PNP
Q305	2SC2271(E)	TR. SI, NPN
Q306	2SC2271(E)	TR. SI, NPN
R001	RD148B2E105J	RES. CARBON 1M 5% 1/4W
R002	RD148B2E220J	RES. CARBON 22 5% 1/4W
R003	RD148B2E562J	RES. CARBON 5.6K 5% 1/4W
R004	RD148B2E562J	RES. CARBON 5.6K 5% 1/4W
R005	RD148B2E120J	RES. CARBON 12 5% 1/4W
R006	RD148B2E510J	RES. CARBON 51 5% 1/4W
R007	RD148B2E510J	RES. CARBON 51 5% 1/4W
R008	RD148B2E392J	RES. CARBON 3.9K 5% 1/4W
R009	RD148B2E102J	RES. CARBON 1K 5% 1/4W
R010	RD148B2E302J	RES. CARBON 3K 5% 1/4W
R011	RD148B2E220J	RES. CARBON 22 5% 1/4W
R012	RD148B2E243J	RES. CARBON 24K 5% 1/4W
R013	RD148B2E302J	RES. CARBON 3K 5% 1/4W
R014	RN148K2E1000F	RES. METAL FILM 100 1% 1/4W
R015	RN148K2E1301F	RES. METAL FILM 1.3K 1% 1/4W
R016	RD148B2E220J	RES. CARBON 22 5% 1/4W
R017	RD148B2E302J	RES. CARBON 3K 5% 1/4W
R018	RD148B2E104J	RES. CARBON 100K 5% 1/4W
R019	RD148B2E220J	RES. CARBON 22 5% 1/4W
R020	RD148B2E331J	RES. CARBON 330 5% 1/4W
R021	RD148B2E331J	RES. CARBON 330 5% 1/4W
R022	RD148B2E222J	RES. CARBON 2.2K 5% 1/4W
R023	RD148B2E220J	RES. CARBON 22 5% 1/4W
R024	RD148B2E222J	RES. CARBON 2.2K 5% 1/4W
R025	RD148B2E101J	RES. CARBON 100 5% 1/4W
R026	RD148B2E152J	RES. CARBON 1.5K 5% 1/4W
R027	RD148B2E152J	RES. CARBON 1.5K 5% 1/4W
R028	RD148B2E270J	RES. CARBON 27 5% 1/4W
R029	RD148B2E270J	RES. CARBON 27 5% 1/4W
R030	RD148B2E100J	RES. CARBON 10 5% 1/4W
R031	RD148B2E221J	RES. CARBON 220 5% 1/4W
R032	RD148B2E101J	RES. CARBON 100 5% 1/4W
R033	RD148B2E101J	RES. CARBON 100 5% 1/4W
R034	RD148B2E222J	RES. CARBON 2.2K 5% 1/4W
R035	RD148B2E222J	RES. CARBON 2.2K 5% 1/4W
R036	RN148K2E2201F	RES. METAL FILM 2.2K 1% 1/4W
R037	RN148K2E2201F	RES. METAL FILM 2.2K 1% 1/4W
R038	RD148B2E750J	RES. CARBON 75 5% 1/4W
R039	RD148B2E471J	RES. CARBON 470 5% 1/4W
R040	RD148B2E682J	RES. CARBON 6.8K 5% 1/4W
R041	RD148B2E332J	RES. CARBON 3.3K 5% 1/4W
R042	RD148B2E471J	RES. CARBON 470 5% 1/4W
R043	RD148B2E471J	RES. CARBON 470 5% 1/4W
R044	RN148K2E8200F	RES. METAL FILM 820 1% 1/4W
R045	RN148K2E8200F	RES. METAL FILM 820 1% 1/4W
R046	RD148B2E162J	RES. CARBON 1.6K 5% 1/4W
R047	NO USE	
R048	RD148B2E101J	RES. CARBON 100 5% 1/4W
R049	RD148B2E302J	RES. CARBON 3K 5% 1/4W
R050	RD148B2E302J	RES. CARBON 3K 5% 1/4W
R051	RD148B2E101J	RES. CARBON 100 5% 1/4W
R052	RD148B2E220J	RES. CARBON 22 5% 1/4W
R053	RD148B2E220J	RES. CARBON 22 5% 1/4W
R054	RD148B2E201J	RES. CARBON 200 5% 1/4W
R055	RD148B2E201J	RES. CARBON 200 5% 1/4W
R056	RD148B2E121J	RES. CARBON 120 5% 1/4W
R057	NO USE	
R058	RD148B2E101J	RES. CARBON 100 5% 1/4W
R059	RD148B2E101J	RES. CARBON 100 5% 1/4W
R060	RS148B3F681J	RES. METAL FILM 680 5% 3W
R061	RS148B3F681J	RES. METAL FILM 680 5% 3W
R062	RS148B3F681J	RES. METAL FILM 680 5% 3W
R063	RS148B3F681J	RES. METAL FILM 680 5% 3W
R064	RD148B2E104J	RES. CARBON 100K 5% 1/4W
R065	RD148B2E201J	RES. CARBON 200 5% 1/4W
R066	RD148B2E511J	RES. CARBON 510 5% 1/4W
R067	RD148B2E562J	RES. CARBON 5.6K 5% 1/4W
R068	RD148B2E104J	RES. CARBON 100K 5% 1/4W
R069	RD148B2E223J	RES. CARBON 22K 5% 1/4W
R301	RD148B2E473J	RES. CARBON 47K 5% 1/4W

REF. NO	PARTS NO	NAME & DESCRIPTION
R302	RD148B2E102J	RES. CARBON 1K 5% 1/4W
R303	RD148B2E3R3J	RES. CARBON 3.3 5% 1/4W
R304	RD148B2E100J	RES. CARBON 10 5% 1/4W
R305	RD148B2E562J	RES. CARBON 5.6K 5% 1/4W
R306	RD148B2E822J	RES. CARBON 8.2K 5% 1/4W
R307	RD148B2E222J	RES. CARBON 2.2K 5% 1/4W
R308	RD148B2E222J	RES. CARBON 2.2K 5% 1/4W
R309	RN148K2E1502F	RES. METAL FILM 15K 1% 1/4W
R310	RN148K2E1003F	RES. METAL FILM 100K 1% 1/4W
R311	RN148K2E1602F	RES. METAL FILM 16K 1% 1/4W
R312	RN148K2E1503F	RES. METAL FILM 150K 1% 1/4W
R313	RD148Y2H104J	RES. CARBON 100K 5% 1/2W
R314	RD148Y2H104J	RES. CARBON 100K 5% 1/2W
TC001	C05-0425-05	CAP. TRIMMER 70P
TC002	C05-0425-05	CAP. TRIMMER 70P
TC101	C05-0434-05	CAP. TRIMMER 20P
TP001	E23-0046-04	TERMINAL
TP002	E23-0046-04	TERMINAL
TP003	E23-0046-04	TERMINAL
TP004	E23-0046-04	TERMINAL
TP005	E23-0046-04	TERMINAL
U001	M47F(B)	FET
U301	#PC7805H	IC
U302	#PC7915HA	IC
U303	NJM7815	IC
U304	NJM4558D	IC DUAL OP AMP.
VR001	R05-3506-05	V.R. 10K B
VR002	NO USE	
VR003	R12-0539-05	RES. SEMI FIXED 200 B
VR004	R12-0421-05	RES. SEMI FIXED 100 B
VR005	R12-0421-05	RES. SEMI FIXED 100 B
VR006	R12-0421-05	RES. SEMI FIXED 100 B

VERTICAL AMP & POWER UNIT (X73-1490-02)

REF. NO	PARTS NO	NAME & DESCRIPTION
E23-0526-04	EARTH PLATE	
E33-4031-00	WIRE ASSY	
F01-0835-05	HEAT SINK	
F01-0836-04	HEAT SINK	
J25-2999-13	PCB (UNMOUNTED)	
J61-0517-05	STADOFF CLIP	
N19-0191-05	WASHER NONMETAL	
N19-0702-04	WASHER	
N30-3008-46	SCREW, PAN HD M 3X8	
R92-0150-05	JUMPING RES. ZERO OHM	
T12-1018-05	TUBE (PLASTIC)	
T12-2014-05	TUBE (PLASTIC)	
C006	CC45CH1H471J	CAP. CERAMIC 470P 5% 50V
C007	CK45B1H103K	CAP. CERAMIC 0.01 10% 50V
C008	CE04W1E470M	CAP. ELECTRO 47 20% 25V
C009	CE04W1E470M	CAP. ELECTRO 47 20% 25V
C010	CE04W1E470M	CAP. ELECTRO 47 20% 25V
C011	CE04W1E470M	CAP. ELECTRO 47 20% 25V
C012	NO USE	
C013	CC45CH1H470J	CAP. CERAMIC 47P 5% 50V
C014	CE04W1E220M	CAP. ELECTRO 22 20% 25V
C015	NO USE	
C016	CE04W1E220M	CAP. ELECTRO 22 20% 25V
C017	CE04W1E220M	CAP. ELECTRO 22 20% 25V
C021	CC45CH1H050C	CAP. CERAMIC 5P 0.25P 50V
C103	CC45CH1H150J	CAP. CERAMIC 15P 5% 50V
C104	CE04W1E470M	CAP. ELECTRO 47 20% 25V
C105	CE04W1E470M	CAP. ELECTRO 47 20% 25V
C106	CE04W1E470M	CAP. ELECTRO 47 20% 25V
C107	CE04W1E470M	CAP. ELECTRO 47 20% 25V
C108	NO USE	
C109	CC45CH1H470J	CAP. CERAMIC 47P 5% 50V
C110	CC45CH1H470J	CAP. CERAMIC 47P 5% 50V
C111	CE04W1H010M	CAP. ELECTRO 1 20% 50V
C112	CK45B1H103K	CAP. CERAMIC 0.01 10% 50V
C116	CC45CH1H050C	CAP. CERAMIC 5P 0.25P 50V
C301	CE04W1V222M	CAP. ELECTRO 2200 20% 35V
C302	CE04W1V222M	CAP. ELECTRO 2200 20% 35V
C303	CE04W1E222M	CAP. ELECTRO 2200 20% 25V
C304	C90-0910-05	CAP. ELECTRO 100 20% 200V
C305	CE04W2E470	CAP. ELECTRO 47 250V
C306	CE04W1A101M	CAP. ELECTRO 100 20% 10V
C307	CE04W1E101M	CAP. ELECTRO 100 20% 25V
C308	CE04W1E101M	CAP. ELECTRO 100 20% 25V
C309	CE04W2C100	CAP. ELECTRO 10 160V
C310	CE04W2E010	CAP. ELECTRO 1 250V

PARTS LIST

REF. NO	PARTS NO	NAME & DESCRIPTION	REF. NO	PARTS NO	NAME & DESCRIPTION
C311	CE04W1H010M	CAP. ELECTRO 1 20% 50V	R010	RD14BB2E302J	RES. CARBON 3K 5% 1/4W
C312	CE04W1H010M	CAP. ELECTRO 1 20% 50V	R011	RD14BB2E220J	RES. CARBON 22 5% 1/4W
C313	CK45B1H103K	CAP. CERAMIC 0.01 10% 50V	R012	RD14BB2E223J	RES. CARBON 22K 5% 1/4W
C314	CE04W1H010M	CAP. ELECTRO 1 20% 50V	R013	RD14BB2E302J	RES. CARBON 3K 5% 1/4W
C315	CK45B1H103K	CAP. CERAMIC 0.01 10% 50V	R014	RN14BK2E1000F	RES. METAL FILM 100 1% 1/4W
C316	CE04W1H010M	CAP. ELECTRO 1 20% 50V	R015	RN14BK2E1201F	RES. METAL FILM 1.2K 1% 1/4W
C317	CK45B1H103K	CAP. CERAMIC 0.01 10% 50V	R016	RD14BB2E220J	RES. CARBON 22 5% 1/4W
C318	CK45B1H103K	CAP. CERAMIC 1000P 10% 50V	R017	RD14BB2E302J	RES. CARBON 3K 5% 1/4W
C319	CK45B1H103K	CAP. CERAMIC 1000P 10% 50V	R018	RD14BB2E104J	RES. CARBON 100K 5% 1/4W
C320	CK45B2H103K	CAP. CERAMIC 0.01 10% 500V	R019	RD14BB2E220J	RES. CARBON 22 5% 1/4W
			R020	RD14BB2E331J	RES. CARBON 330 5% 1/4W
D001	DS442X	DIODE	R021	RD14BB2E331J	RES. CARBON 330 5% 1/4W
D002	DS442X	DIODE	R022	NO USE	
D003	DS442X	DIODE	R023	RD14BB2E220J	RES. CARBON 22 5% 1/4W
D101	DS442X	DIODE	R024	RD14BB2E222J	RES. CARBON 2.2K 5% 1/4W
D102	DS442X	DIODE	R025	RD14BB2E101J	RES. CARBON 100 5% 1/4W
D103	DS442X	DIODE	R026	RD14BB2E152J	RES. CARBON 1.5K 5% 1/4W
D104	DS442X	DIODE	R027	RD14BB2E152J	RES. CARBON 1.5K 5% 1/4W
D105	DS442X	DIODE	R028	RD14BB2E270J	RES. CARBON 27 5% 1/4W
D106	DS442X	DIODE	R029	RD14BB2E270J	RES. CARBON 27 5% 1/4W
D107	DS442X	DIODE	R030	RD14BB2E220J	RES. CARBON 22 5% 1/4W
D108	MTZ10JC	DIODE, ZENER 10V	R031	RD14BB2E470J	RES. CARBON 47 5% 1/4W
D301	S2VB40F	DIODE, BRIDGE	R032	RD14BB2E101J	RES. CARBON 100 5% 1/4W
D302	S2VB40F	DIODE, BRIDGE	R033	RD14BB2E101J	RES. CARBON 100 5% 1/4W
D303	S1VB60	DIODE	R034	RD14BB2E332J	RES. CARBON 2.2K 5% 1/4W
D304	S1VB60	DIODE	R035	RD14BB2E222J	RES. CARBON 2.2K 5% 1/4W
D305	DS442X	DIODE	R036	RN14BK2E2201F	RES. METAL FILM 2.2K 1% 1/4W
D306	DS442X	DIODE	R037	RN14BK2E2201F	RES. METAL FILM 2.2K 1% 1/4W
D307	V06B	DIODE	R038	RD14BB2E750J	RES. CARBON 75 5% 1/4W
L001	L40-1025-03	FERRI INDUCTOR	R039	RD14BB2E431J	RES. CARBON 430 5% 1/4W
L002	L40-1025-03	FERRI INDUCTOR	R040	RD14BB2E682J	RES. CARBON 6.8K 5% 1/4W
P001	E40-0473-05	PIN CONNECTOR 4 P	R041	RD14BB2E332J	RES. CARBON 3.3K 5% 1/4W
P002	E40-0273-05	PIN CONNECTOR 2 P	R042	RD14BB2E471J	RES. CARBON 470 5% 1/4W
P003	E04-0154-05	BNC RECEPTACLE	R043	RD14BB2E471J	RES. CARBON 470 5% 1/4W
P004	E23-0046-04	TERMINAL	R044	RN14BK2E8200F	RES. METAL FILM 820 1% 1/4W
P005	E23-0046-04	TERMINAL	R045	RN14BK2E8200F	RES. METAL FILM 820 1% 1/4W
P101	E40-0473-05	PIN CONNECTOR 4 P	R046	RN14BK2E8200F	RES. METAL FILM 820 1% 1/4W
P301	E40-0930-05	PIN CONNECTOR 9P	R047	RN14BK2E8200F	RES. METAL FILM 820 1% 1/4W
P302	E40-1116-05	PIN CONNECTOR 11P	R048	RD14BB2E101J	RES. CARBON 100 5% 1/4W
P303	E40-1116-05	PIN CONNECTOR 11P	R049	RD14BB2E302J	RES. CARBON 3K 5% 1/4W
Q002	ZSA1005(K)	TR. SI, PNP	R050	RD14BB2E302J	RES. CARBON 3K 5% 1/4W
Q003	ZSA1005(K)	TR. SI, PNP	R051	RD14BB2E101J	RES. CARBON 100 5% 1/4W
Q004	ZSC2786(K)	TR. SI, NPN	R052	RD14BB2E220J	RES. CARBON 22 5% 1/4W
Q005	ZSC2785(F)	TR. SI, NPN	R053	RD14BB2E220J	RES. CARBON 22 5% 1/4W
Q006	ZSC2785(F)	TR. SI, NPN	R054	RD14BB2E221J	RES. CARBON 220 5% 1/4W
Q007	ZSC2785(F)	TR. SI, NPN	R055	RD14BB2E221J	RES. CARBON 220 5% 1/4W
Q008	ZSA1005(K)	TR. SI, PNP	R056	RD14BB2E750J	RES. CARBON 75 5% 1/4W
Q009	ZSC2785(F)	TR. SI, NPN	R057	RD14BB2E121J	RES. CARBON 120 5% 1/4W
Q010	ZSC2785(F)	TR. SI, NPN	R058	RD14BB2E101J	RES. CARBON 100 5% 1/4W
Q011	ZSC2785(F)	TR. SI, NPN	R059	RD14BB2E101J	RES. CARBON 100 5% 1/4W
Q012	ZSC2785(F)	TR. SI, NPN	R060	RS14GB3F681J	RES. METAL FILM 680 5% 3W
Q013	ZSC2785(F)	TR. SI, NPN	R061	RS14GB3F681J	RES. METAL FILM 680 5% 3W
Q014	ZSC2785(F)	TR. SI, NPN	R062	RS14GB3F681J	RES. METAL FILM 680 5% 3W
Q015	ZSC1973	TR. SI, NPN	R063	RS14GB3F681J	RES. METAL FILM 680 5% 3W
Q016	ZSC1973	TR. SI, NPN	R064	RD14BB2E104J	RES. CARBON 100K 5% 1/4W
Q017	ZSC2912(R,S)	TR. SI, NPN	R065	RD14BB2E201J	RES. CARBON 200 5% 1/4W
Q018	ZSC2912(R,S)	TR. SI, NPN	R066	RD14BB2E471J	RES. CARBON 470 5% 1/4W
Q102	ZSA1005(K)	TR. SI, PNP	R067	RD14BB2E272J	RES. CARBON 2.7K 5% 1/4W
Q103	ZSA1005(K)	TR. SI, PNP	R068	RD14BB2E104J	RES. CARBON 100K 5% 1/4W
Q104	ZSC2786(K)	TR. SI, NPN	R101	RD14BB2E105J	RES. CARBON 1M 5% 1/4W
Q105	ZSC2785(F)	TR. SI, NPN	R102	RD14BB2E220J	RES. CARBON 22 5% 1/4W
Q106	ZSC2785(F)	TR. SI, NPN	R103	RD14BB2E562J	RES. CARBON 5.6K 5% 1/4W
Q107	ZSC2785(F)	TR. SI, NPN	R104	RD14BB2E562J	RES. CARBON 5.6K 5% 1/4W
Q108	ZSC2785(F)	TR. SI, NPN	R105	RD14BB2E120J	RES. CARBON 12 5% 1/4W
Q109	ZSC2785(F)	TR. SI, NPN	R106	RD14BB2E510J	RES. CARBON 51 5% 1/4W
Q110	ZSC2785(F)	TR. SI, NPN	R107	RD14BB2E510J	RES. CARBON 51 5% 1/4W
Q111	ZSC2785(F)	TR. SI, NPN	R108	RD14BB2E392J	RES. CARBON 3.9K 5% 1/4W
Q112	ZSC2785(F)	TR. SI, NPN	R109	RD14BB2E102J	RES. CARBON 1K 5% 1/4W
Q113	ZSA1175(F)	TR. SI, PNP	R110	RD14BB2E302J	RES. CARBON 3K 5% 1/4W
Q114	ZSC2785(F)	TR. SI, NPN	R111	RD14BB2E220J	RES. CARBON 22 5% 1/4W
Q115	ZSC2785(F)	TR. SI, NPN	R112	RD14BB2E223J	RES. CARBON 22K 5% 1/4W
Q301	ZSA1009(L,K)	TR. SI, PNP	R113	RD14BB2E302J	RES. CARBON 3K 5% 1/4W
Q302	ZSA1009(L,K)	TR. SI, PNP	R114	RN14BK2E1000F	RES. METAL FILM 100 1% 1/4W
Q303	ZSA1175(F)	TR. SI, PNP	R115	RD14BB2E104J	RES. CARBON 100K 5% 1/4W
Q304	ZSA1175(F)	TR. SI, PNP	R116	RN14BK2E1201F	RES. METAL FILM 1.2K 1% 1/4W
Q305	ZSC2271(E)	TR. SI, NPN	R117	RD14BB2E220J	RES. CARBON 22 5% 1/4W
Q306	ZSC2271(E)	TR. SI, NPN	R118	RD14BB2E182J	RES. CARBON 1.8K 5% 1/4W
R001	RD14BB2E105J	RES. CARBON 1M 5% 1/4W	R019	NO USE	
R002	RD14BB2E220J	RES. CARBON 22 5% 1/4W	R120	RD14BB2E220J	RES. CARBON 22 5% 1/4W
R003	RD14BB2E562J	RES. CARBON 5.6K 5% 1/4W	R121	RD14BB2E561J	RES. CARBON 560 5% 1/4W
R004	RD14BB2E562J	RES. CARBON 5.6K 5% 1/4W	R122	NO USE	
R005	RD14BB2E120J	RES. CARBON 12 5% 1/4W	R123	RD14BB2E333J	RES. CARBON 33K 5% 1/4W
R006	RD14BB2E510J	RES. CARBON 51 5% 1/4W	R124	RD14BB2E470J	RES. CARBON 47 5% 1/4W
R007	RD14BB2E510J	RES. CARBON 51 5% 1/4W	R125	RD14BB2E101J	RES. CARBON 100 5% 1/4W
R008	RD14BB2E392J	RES. CARBON 3.9K 5% 1/4W	R126	RD14BB2E101J	RES. CARBON 100 5% 1/4W
R009	RD14BB2E102J	RES. CARBON 1K 5% 1/4W	R127	RD14BB2E223J	RES. CARBON 2.2K 5% 1/4W
			R128	RD14BB2E222J	RES. CARBON 2.2K 5% 1/4W
			R129	RN14BK2E2201F	RES. METAL FILM 2.2K 1% 1/4W
			R130	RN14BK2E2201F	RES. METAL FILM 2.2K 1% 1/4W
			R131	RD14BB2E750J	RES. CARBON 75 5% 1/4W
			R132	RN14BK2E2001F	RES. METAL FILM 2K 1% 1/4W
			R133	RN14BK2E2001F	RES. METAL FILM 2K 1% 1/4W
			R134	RD14BB2E510J	RES. CARBON 51 5% 1/4W
			R135	RD14BB2E511J	RES. CARBON 510 5% 1/4W
			R136	RD14BB2E123J	RES. CARBON 12K 5% 1/4W
			R137	RD14BB2E472J	RES. CARBON 4.7K 5% 1/4W

PARTS LIST

REF.NO	PARTS NO	NAME & DESCRIPTION	REF.NO	PARTS NO	NAME & DESCRIPTION
R138	RD148B2E332J	RES. CARBON 3.3K 5% 1/4W	C007	CK45B1H103K	CAP. CERAMIC 0.01 10% 50V
R139	RD148B2E332J	RES. CARBON 3.3K 5% 1/4W	C008	CE04W1E470M	CAP. ELECTRO 47 20% 25V
R140	RD148B2E471J	RES. CARBON 470 5% 1/4W	C009	CE04W1E470M	CAP. ELECTRO 47 20% 25V
R141	RD148B2E471J	RES. CARBON 470 5% 1/4W	C010	CE04W1E470M	CAP. ELECTRO 47 20% 25V
R142	RD148B2E471J	RES. CARBON 470 5% 1/4W	C011	CE04W1E470M	CAP. ELECTRO 47 20% 25V
R143	RD148B2E471J	RES. CARBON 470 5% 1/4W	C012	NO USE	
R144	RD148B2E272J	RES. CARBON 2.7K 5% 1/4W	C013	CK45B1H103K	CAP. CERAMIC 0.01 10% 50V
R145	RD148B2E153J	RES. CARBON 15K 5% 1/4W	C014	CE04W1E220M	CAP. ELECTRO 22 20% 25V
R146	RD148B2E153J	RES. CARBON 15K 5% 1/4W	C015	NO USE	
R147	RD148B2E272J	RES. CARBON 2.7K 5% 1/4W	C016	CE04W1E220M	CAP. ELECTRO 22 20% 25V
R148	RD148B2E223J	RES. CARBON 22K 5% 1/4W	C017	CE04BW1E220M	CAP. ELECTRO 22 20% 25V
R149	RD148B2E682J	RES. CARBON 6.8K 5% 1/4W	C021	CC45CH1H050C	CAP. CERAMIC 5P 0.25P 50V
R150	RD148B2E102J	RES. CARBON 1K 5% 1/4W	C301	CE04W1V222M	CAP. ELECTRO 2200 20% 35V
R151	RD148B2E102J	RES. CARBON 1K 5% 1/4W	C302	CE04W1V222M	CAP. ELECTRO 2200 20% 35V
R152	RD148B2E151J	RES. CARBON 150 5% 1/4W	C303	CE04W1E222M	CAP. ELECTRO 2200 20% 25V
R153	RD148B2E101J	RES. CARBON 100 5% 1/4W	C304	C90-0910-05	CAP. ELECTRO 100 20% 200V
R154	NO USE		C305	CE04W2E470	CAP. ELECTRO 47 250V
R155	RD148B2E470J	RES. CARBON 47 5% 1/4W	C306	CE04W1A101M	CAP. ELECTRO 100 20% 10V
R156	NO USE		C307	CE04W1E101M	CAP. ELECTRO 100 20% 25V
R157	RD148B2E332J	RES. CARBON 3.3K 5% 1/4W	C308	CE04W1E101M	CAP. ELECTRO 100 20% 25V
R158	RD148B2E104J	RES. CARBON 100K 5% 1/4W	C309	CE04W2C100	CAP. ELECTRO 10 160V
R159	RD148B2E223J	RES. CARBON 22K 5% 1/4W	C310	CE04W2E010	CAP. ELECTRO 1 250V
R301	RD148B2E473J	RES. CARBON 47K 5% 1/4W	C311	CE04BW1H010M	CAP. ELECTRO 1 20% 50V
R302	RD148B2E102J	RES. CARBON 1K 5% 1/4W	C312	CE04W1H010M	CAP. ELECTRO 1 20% 50V
R303	RD148B2E3R3J	RES. CARBON 3.3 5% 1/4W	C313	CK45B1H103K	CAP. CERAMIC 0.01 10% 50V
R304	RD148B2E100J	RES. CARBON 10 5% 1/4W	C314	CE04W1H010M	CAP. ELECTRO 1 20% 50V
R305	RD148B2E562J	RES. CARBON 5.6K 5% 1/4W	C315	CK45B1H103K	CAP. CERAMIC 0.01 10% 50V
R306	RD148B2E822J	RES. CARBON 8.2K 5% 1/4W	C316	CE04W1H010M	CAP. ELECTRO 1 20% 50V
R307	RD148B2E222J	RES. CARBON 2.2K 5% 1/4W	C317	CK45B1H103K	CAP. CERAMIC 0.01 10% 50V
R308	RD148B2E222J	RES. CARBON 2.2K 5% 1/4W	C318	CK45B1H102K	CAP. CERAMIC 1000P 10% 50V
R309	RN148K2E1502F	RES. METAL FILM 15K 1% 1/4W	C319	CK45B1H102K	CAP. CERAMIC 1000P 10% 50V
R310	RN148K2E1003F	RES. METAL FILM 100K 1% 1/4W	C320	CK45B2H103K	CAP. CERAMIC 0.01 10% 50V
R311	RN148K2E1602F	RES. METAL FILM 16K 1% 1/4W	D001	D5442X	DIODE
R312	RN148K2E1503F	RES. METAL FILM 150K 1% 1/4W	D002	D5442X	DIODE
R313	RD14BY2H104J	RES. CARBON 100K 5% 1/2W	D003	D5442X	DIODE
R314	RD14BY2H104J	RES. CARBON 100K 5% 1/2W	D301	S2VB40F	DIODE BRIDGE
S101	S42-4509-05	PUSH SWITCH	D302	S2VB40F	DIODE BRIDGE
TC001	C05-0425-05	CAP. TRIMMER 70P	D303	S1VB60	DIODE
TC002	C05-0425-05	CAP. TRIMMER 70P	D304	S1VB60	DIODE
TC101	C05-0434-05	CAP. TRIMMER 20P	D305	D5442X	DIODE
TC102	C05-0434-05	CAP. TRIMMER 20P	D306	D5442X	DIODE
TP001	E23-0046-04	TERMINAL	D307	V06B	DIODE
TP002	E23-0046-04	TERMINAL	L001	L40-1025-03	FERRI INDUCTOR
TP003	E23-0046-04	TERMINAL	L002	L40-1025-03	FERRI INDUCTOR
TP004	E23-0046-04	TERMINAL	P001	E40-0473-05	PIN CONNECTOR 4 P
TP101	E23-0046-04	TERMINAL	P002	E40-0273-05	PIN CONNECTOR 2 P
TP102	E23-0046-04	TERMINAL	P003	E04-0154-05	BNC RECEPTACLE
TP103	E23-0046-04	TERMINAL	P301	E40-0930-05	PIN CONNECTOR 9P
TP104	E23-0046-04	TERMINAL	P302	E40-1116-05	PIN CONNECTOR 11P
U001	M47F(B)	FET	P303	E40-1116-05	PIN CONNECTOR 11P
U101	M47F(B)	FET	Q002	2SA1005(K)	TR. SI, PNP
U301	UPC7805H	IC	Q003	2SA1005(K)	TR. SI, PNP
U302	UPC7915HA	IC	Q004	2SC2786(K)	TR. SI, NPN
U303	NJM7815	IC	Q005	2SC2785(F)	TR. SI, NPN
U304	NJM4558D	IC	Q006	2SC2785(F)	TR. SI, NPN
VR001	R05-3506-05	V.R. 20K B	Q007	2SC2785(F)	TR. SI, NPN
VR002	NO USE		Q008	2SA1005(K)	TR. SI, PNP
VR003	R12-0539-05	RES. SEMI FIXED 200 B	Q009	2SC2785(F)	TR. SI, NPN
VR004	R12-0421-05	RES. SEMI FIXED 100 B	Q010	2SC2785(F)	TR. SI, NPN
VR005	R12-0421-05	RES. SEMI FIXED 100 B	Q011	2SC2785(F)	TR. SI, NPN
VR006	R12-0421-05	RES. SEMI FIXED 100 B	Q012	2SC2785(F)	TR. SI, NPN
VR101	R05-3506-05	V.R. 20K B	Q013	2SC2785(F)	TR. SI, NPN
VR102	R12-3523-05	RES. SEMI FIXED 20K B	Q014	2SC2785(F)	TR. SI, NPN
VR103	R12-0541-05	RES. SEMI FIXED 100 B	Q015	2SC1973	TR. SI, NPN
VR104	R12-0543-05	RES. SEMI FIXED 500 B	Q016	2SC1973	TR. SI, NPN
			Q017	2SC2912(R,S)	TR. SI, NPN
			Q018	2SC2912(R,S)	TR. SI, NPN
			Q301	2SA1009(L,K)	TR. SI, PNP
			Q302	2SA1009(L,K)	TR. SI, PNP
			Q303	2SA1175(F)	TR. SI, PNP
			Q304	2SA1175(F)	TR. SI, PNP
			Q305	2SC2271(E)	TR. SI, NPN
			Q306	2SC2271(E)	TR. SI, NPN

VERTICAL AMP & POWER UNIT (X73-1490-03)

REF.NO	PARTS NO	NAME & DESCRIPTION	REF.NO	PARTS NO	NAME & DESCRIPTION
	E23-0526-04	EARTH PLATE	R001	RD148B2E105J	RES. CARBON 1M 5% 1/4W
	E33-4032-00	WIRE ASSY	R002	RD148B2E220J	RES. CARBON 22 5% 1/4W
	F01-0835-05	HEAT SINK	R003	RD148B2E562J	RES. CARBON 5.6K 5% 1/4W
	F01-0836-04	HEAT SINK	R004	RD148B2E562J	RES. CARBON 5.6K 5% 1/4W
	J25-2999-13	PCB (UNMOUNTED)	R005	RD148B2E120J	RES. CARBON 12 5% 1/4W
	J61-0517-05	STADOFF CLIP	R006	RD148B2E510J	RES. CARBON 51 5% 1/4W
	N19-0191-05	WASHER NONMETAL	R007	RD148B2E510J	RES. CARBON 51 5% 1/4W
	N19-0702-04	WASHER	R008	RD148B2E392J	RES. CARBON 3.9K 5% 1/4W
	N30-3008-46	SCREW, PAN HD M 3X8	R009	RD148B2E102J	RES. CARBON 1K 5% 1/4W
	R92-0150-05	JUMPING RES. ZERO OHM	R010	RD148B2E302J	RES. CARBON 3K 5% 1/4W
	T12-2014-05	TUBE (PLASTIC)	R011	RD148B2E220J	RES. CARBON 22 5% 1/4W
C006	CC45CH1H471J	CAP. CERAMIC 470P 5% 50V	R012	RD148B2E223J	RES. CARBON 22K 5% 1/4W
			R013	RD148B2E302J	RES. CARBON 3K 5% 1/4W
			R014	RN148K2E1000F	RES. METAL FILM 100 1% 1/4W

PARTS LIST

REF.NO	PARTS NO	NAME & DESCRIPTION			
R015	RN14BK2E1201F	RES. METAL FILM 1.2K	1%	1/4W	
R016	RD14BB2E220J	RES. CARBON 22	5%	1/4W	
R017	RD14BB2E302J	RES. CARBON 3K	5%	1/4W	
R018	RD14BB2E104J	RES. CARBON 100K	5%	1/4W	
R019	RD14BB2E220J	RES. CARBON 22	5%	1/4W	
R020	RD14BB2E331J	RES. CARBON 330	5%	1/4W	
R021	RD14BB2E331J	RES. CARBON 330	5%	1/4W	
R022	RD14BB2E222J	RES. CARBON 2.2K	5%	1/4W	
R023	RD14BB2E220J	RES. CARBON 22	5%	1/4W	
R024	RD14BB2E222J	RES. CARBON 2.2K	5%	1/4W	
R025	RD14BB2E101J	RES. CARBON 100	5%	1/4W	
R026	RD14BB2E152J	RES. CARBON 1.5K	5%	1/4W	
R027	RD14BB2E152J	RES. CARBON 1.5K	5%	1/4W	
R028	RD14BB2E270J	RES. CARBON 27	5%	1/4W	
R029	RD14BB2E270J	RES. CARBON 27	5%	1/4W	
R030	RD14BB2E220J	RES. CARBON 22	5%	1/4W	
R031	RD14BB2E470J	RES. CARBON 47	5%	1/4W	
R032	RD14BB2E101J	RES. CARBON 100	5%	1/4W	
R033	RD14BB2E101J	RES. CARBON 100	5%	1/4W	
R034	RD14BB2E222J	RES. CARBON 2.2K	5%	1/4W	
R035	RD14BB2E222J	RES. CARBON 2.2K	5%	1/4W	
R036	RN14BK2E2201F	RES. METAL FILM 2.2K	1%	1/4W	
R037	RN14BK2E2201F	RES. METAL FILM 2.2K	1%	1/4W	
R038	RD14BB2E750J	RES. CARBON 75	5%	1/4W	
R039	RD14BB2E471J	RES. CARBON 470	5%	1/4W	
R040	RD14BB2E682J	RES. CARBON 6.8K	5%	1/4W	
R041	RD14BB2E332J	RES. CARBON 3.3K	5%	1/4W	
R042	RD14BB2E471J	RES. CARBON 470	5%	1/4W	
R043	RD14BB2E471J	RES. CARBON 470	5%	1/4W	
R044	RN14BK2E8200F	RES. METAL FILM 820	1%	1/4W	
R045	RN14BK2E8200F	RES. METAL FILM 820	1%	1/4W	
R046	RD14BB2E162J	RES. CARBON 1.6K	5%	1/4W	
R047	NO USE				
R048	RD14BB2E101J	RES. CARBON 100	5%	1/4W	
R049	RD14BB2E302J	RES. CARBON 3K	5%	1/4W	
R050	RD14BB2E302J	RES. CARBON 3K	5%	1/4W	
R051	RD14BB2E101J	RES. CARBON 100	5%	1/4W	
R052	RD14BB2E220J	RES. CARBON 22	5%	1/4W	
R053	RD14BB2E220J	RES. CARBON 22	5%	1/4W	
R054	RD14BB2E221J	RES. CARBON 220	5%	1/4W	
R055	RD14BB2E221J	RES. CARBON 220	5%	1/4W	
R056	RD14BB2E750J	RES. CARBON 75	5%	1/4W	
R057	RD14BB2E121J	RES. CARBON 120	5%	1/4W	
R058	RD14BB2E101J	RES. CARBON 100	5%	1/4W	
R059	RD14BB2E101J	RES. CARBON 100	5%	1/4W	
R060	R314GB3F681J	RES. METAL FILM 680	5%	3W	
R061	R314GB3F681J	RES. METAL FILM 680	5%	3W	
R062	R314GB3F681J	RES. METAL FILM 680	5%	3W	
R063	R314GB3F681J	RES. METAL FILM 680	5%	3W	
R064	RD14BB2E104J	RES. CARBON 100K	5%	1/4W	
R065	RD14BB2E201J	RES. CARBON 200	5%	1/4W	
R066	RD14BB2E112J	RES. CARBON 1.1K	5%	1/4W	
R067	RD14BB2E272J	RES. CARBON 2.7K	5%	1/4W	
R068	RD14BB2E104J	RES. CARBON 100K	5%	1/4W	
R301	RD14BB2E473J	RES. CARBON 47K	5%	1/4W	
R302	RD14BB2E102J	RES. CARBON 1K	5%	1/4W	
R303	RD14BB2E3R3J	RES. CARBON 3.3	5%	1/4W	
R304	RD14BB2E100J	RES. CARBON 10	5%	1/4W	
R305	RD14BB2E562J	RES. CARBON 5.6K	5%	1/4W	
R306	RD14BB2E822J	RES. CARBON 8.2K	5%	1/4W	
R307	RD14BB2E222J	RES. CARBON 2.2K	5%	1/4W	
R308	RD14BB2E222J	RES. CARBON 2.2K	5%	1/4W	
R309	RN14BK2E1502F	RES. METAL FILM 15K	1%	1/4W	
R310	RN14BK2E1003F	RES. METAL FILM 100K	1%	1/4W	
R311	RN14BK2E1602F	RES. METAL FILM 16K	1%	1/4W	
R312	RN14BK2E1503F	RES. METAL FILM 150K	1%	1/4W	
R313	RD14BY2H104J	RES. CARBON 100K	5%	1/2W	
R314	RD14BY2H104J	RES. CARBON 100K	5%	1/2W	
TC001	C05-0425-05	CAP. TRIMMER 70P			
TC002	C05-0425-05	CAP. TRIMMER 70P			
TC101	C05-0434-05	CAP. TRIMMER 20P			
TP001	E23-0046-04	TERMINAL			
TP002	E23-0046-04	TERMINAL			
TP003	E23-0046-04	TERMINAL			
TP004	E23-0046-04	TERMINAL			
TP005	E23-0046-04	TERMINAL			
U001	M47F(B)	FET			
U301	UPC7805H	IC			
U302	UPC7915HA	IC			
U303	NJM7815	IC			
U304	NJM4558D	IC			
VR001	R05-3506-05	V.R. 20K B			
VR002	NO USE				
VR003	R12-0539-05	RES. SEMI FIXED 200 B			
VR004	R12-0421-05	RES. SEMI FIXED 100 B			
VR005	R12-0421-05	RES. SEMI FIXED 100 B			
VR006	R12-0421-05	RES. SEMI FIXED 100 B			

HORIZONTAL & HIGH VOLTAGE UNIT

(X74-1340-00)

REF.NO	PARTS NO	NAME & DESCRIPTION			
	E23-0015-04	EARTH LUG			
	E23-0046-04	TERMINAL			
	E31-2170-05	JUMPING WIRE			
	E33-4028-00	WIRE ASSY			
	F01-0230-04	HEAT SINK			
	F01-0820-04	HEAT SINK			
	F01-0835-05	HEAT SINK			
	F15-0727-04	HOLDER (NEON TUBE)			
	F20-0622-05	INSULATOR			
	J25-2998-13	PCB (UNMOUNTED)			
	J31-0604-04	COLLAR			
	N19-0191-05	WASHER NONMETAL			
	N30-3008-46	SCREW, PAN HD M 3X8			
	R92-0150-05	JUMPING RES. ZERO OHM			
	W02-0408-05	HIGH VOLTAGE POWER BLOCK			
	002-0001-05	BRAIDED WIRE			
	212-1018-05	TUBE (PLASTIC)			
	212-3013-05	TUBE (PLASTIC)			
C001	CC45CH1H330J	CAP. CERAMIC 33P 5%	50V		
C002	CC45CH2H010C	CAP. CERAMIC 1P 0.25P	500V		
C003	CK45B2H472K	CAP. CERAMIC 4700P 10%	500V		
C004	CE04W1H100M	CAP. ELECTRO 10	20%	50V	
C005	CE04W2E100	CAP. ELECTRO 10		250V	
C006	C093FM1H104K	CAP. MYLAR 0.1	10%	50V	
C007	C093FM1H153K	CAP. MYLAR 0.015	10%	50V	
C008	CE04W1V471M	CAP. ELECTRO 470	20%	35V	
C009	C093FM1H104K	CAP. MYLAR 0.1	10%	50V	
C010	C093FM1H223K	CAP. MYLAR 0.022	10%	50V	
C011	CK45B2H102K	CAP. CERAMIC 1000P	10%	500V	
C012	CK45E3D103P	CAP. CERAMIC 0.01		2K	
C013	CK45E3D103P	CAP. CERAMIC 0.01		2K	
C014	NO USE				
C015	CE04W2E010	CAP. ELECTRO 1		250V	
C016	CE04W2E4R7	CAP. ELECTRO 4.7		250V	
C017	CK45B2H472K	CAP. CERAMIC 4700P	10%	500V	
C018	CE04W1E470M	CAP. ELECTRO 47	20%	25V	
C019	CC45FCH1H100D	CAP. CERAMIC 10P 0.5P		50V	
C020	CE04W1E101M	CAP. ELECTRO 100	20%	25V	
C021	CK45B2H103K	CAP. CERAMIC 0.01	10%	500V	
C022	CE04W1E101M	CAP. ELECTRO 100	20%	25V	
C023	CE04W1E101M	CAP. ELECTRO 100	20%	25V	
C024	C90-0912-05	CAP. ELECTRO 220	20%	35V	
C025	C90-0912-05	CAP. ELECTRO 220	20%	35V	
C026	CK45F1H103Z	CAP. CERAMIC 0.01		50V	
C027	CK45B2H472K	CAP. CERAMIC 4700P	10%	500V	
C028	CE04W2A3R3M	CAP. ELECTRO 3.3	20%	100V	
C029	C91-0571-05	CAP. CERAMIC 0.01		2KV	
C030	CK45E3D102P	CAP. CERAMIC 1000P		2K	
C031	CC45CH1H180J	CAP. CERAMIC 18P 5%		50V	
C101	C093FM1H103K	CAP. MYLAR 0.01	10%	50V	
C102	C093FM1H103K	CAP. MYLAR 0.01	10%	50V	
C103	CK45F1H103Z	CAP. CERAMIC 0.01		50V	
C104	CK45F1H103Z	CAP. CERAMIC 0.01		50V	
C105	CC45CH1H121J	CAP. CERAMIC 120P 5%		50V	
C106	CE04W1H100M	CAP. ELECTRO 10	20%	50V	
C107	NO USE				
C108	C90-0298-05	CAP. CERAMIC 0.1	20%	12V	
C109	CK45B1H472K	CAP. CERAMIC 4700P	10%	50V	
C110	CK45F1H103Z	CAP. CERAMIC 0.01		50V	
C111	CC45CH1H101J	CAP. CERAMIC 100P 5%		50V	
C112	CK45F1H103Z	CAP. CERAMIC 0.01		50V	
C113	CC45CH1H101J	CAP. CERAMIC 100P 5%		50V	
C114	CE04W1H010M	CAP. ELECTRO 1	20%	50V	
C115	CE04W1A101M	CAP. ELECTRO 100	20%	10V	
C116	CK45F1H103Z	CAP. CERAMIC 0.01		50V	
C117	CK45F1H103Z	CAP. CERAMIC 0.01		50V	
C118	CC45CH2H100D	CAP. CERAMIC 10P 0.5P		500V	
C119	CC45CH2H040C	CAP. CERAMIC 4P 0.25P		500V	
C120	CF93AN2A105J	CAP. POLYESTHEL 1	5%	100V	
C121	C093BP2A103F	CAP. MYLAR 0.01	1%	100V	
C122	CM93BD2A900J	CAP. MICA 90P 5%		100V	
C123	C093FM1H102K	CAP. MYLAR 1000P	10%	50V	
C124	CK45F1H103Z	CAP. CERAMIC 0.01		50V	
C125	CK45F1H103Z	CAP. CERAMIC 0.01		50V	
C126	CK45F1H103Z	CAP. CERAMIC 0.01		50V	
C127	CC45FCH1H330J	CAP. CERAMIC 33P 5%		50V	
C128	CE04W1E470M	CAP. ELECTRO 47	20%	25V	
C129	CE04W1H010M	CAP. ELECTRO 1	20%	50V	
C130	NO USE				
C131	CK45F1H103Z	CAP. CERAMIC 0.01		50V	
C132	NO USE				
C133	CK45F1H103Z	CAP. CERAMIC 0.01		50V	
C134	CC45FCH1H270J	CAP. CERAMIC 27P 5%		50V	
C135	CC45CH2H010C	CAP. CERAMIC 1P 0.25P		500V	
C136	CM93BD2A151J	CAP. MICA 150P 5%		100V	
C137	CC45CH1H680J	CAP. CERAMIC 68P 5%		50V	
C138	NO USE				
C139	CC45CH2H060D	CAP. CERAMIC 6P 0.5P		500V	
C140	CK45F1H103Z	CAP. CERAMIC 0.01		50V	
C141	CK45F1H102K	CAP. CERAMIC 1000P	10%	50V	

PARTS LIST

REF.NO	PARTS NO	NAME & DESCRIPTION	REF.NO	PARTS NO	NAME & DESCRIPTION
C142	CC45CH1H221J	CAP. CERAMIC 220P 5% 50V	Q005	2SC2271(D)	TR. SI, NPN
C143	CK45F1H103Z	CAP. CERAMIC 0.01 50V	Q101	2SK117(Y)	FET. N-CHANNEL
C144	CK45F1H103Z	CAP. CERAMIC 0.01 50V	Q102	2SK117(Y)	FET. N-CHANNEL
C145	C90-0298-05	CAP. CERAMIC 0.1 20% 12V	Q103	2SC2785(F)	TR. SI, NPN
C146	CK45F1H103Z	CAP. CERAMIC 0.01 50V	Q104	2SC2785(F)	TR. SI, NPN
C147	CK45F1H103Z	CAP. CERAMIC 0.01 50V	Q105	2SC2785(F)	TR. SI, NPN
C148	CK45F1H103Z	CAP. CERAMIC 0.01 50V	Q106	2SC2785(F)	TR. SI, NPN
C149	CK45F1H103Z	CAP. CERAMIC 0.01 50V	Q107	2SA1175(F)	TR. SI, PNP
C150	CE04W1E101M	CAP. ELECTRO 100 20% 25V	Q108	2SA1175(F)	TR. SI, PNP
C151	CE04W1A221M	CAP. ELECTRO 220 20% 10V	Q109	2SA838(C)	TR. SI, PNP
C152	CE04W1E101M	CAP. ELECTRO 100 20% 25V	Q110	2SA838(C)	TR. SI, PNP
C153	CK45F1H103Z	CAP. CERAMIC 0.01 50V	Q111	2SA1175(F)	TR. SI, PNP
C154	CE04W2E4R7	CAP. ELECTRO 4.7 250V	Q112	2SA1175(F)	TR. SI, PNP
C155	CK45B2H472K	CAP. CERAMIC 4700P 10% 500V	Q113	2SC2785(F)	TR. SI, NPN
C158	CC45FCH1H150J	CAP. CERAMIC 15P 5% 50V	Q114	2SC2785(F)	TR. SI, NPN
C159	CE04W1E470M	CAP. ELECTRO 47 20% 25V	Q115	2SK117(Y)	FET. N-CHANNEL
C160	CE04W1E470M	CAP. ELECTRO 47 20% 25V	Q116	2SC2785(F)	TR. SI, NPN
C161	CE04W1E470M	CAP. ELECTRO 47 20% 25V	Q117	2SC2785(F)	TR. SI, NPN
C162	NO USE		Q118	2SC2785(F)	TR. SI, NPN
C163	CC45FCH1H100D	CAP. CERAMIC 10P 0.5P 50V	Q119	2SC2785(F)	TR. SI, NPN
C164	CK45F1H103Z	CAP. CERAMIC 0.01 50V	Q120	2SC2785(F)	TR. SI, NPN
C165	CC45CH1H101J	CAP. CERAMIC 100P 5% 50V	Q121	2SA1175(F)	TR. SI, PNP
C166	NO USE		Q122	2SA1175(F)	TR. SI, PNP
C167	CC45CH1H101J	CAP. CERAMIC 100P 5% 50V	Q123	2SA1175(F)	TR. SI, PNP
C168	CE04W1E101M	CAP. ELECTRO 100 20% 25V	Q124	2SC2912(S)	TR. SI, NPN
C169	NO USE		Q125	2SA1210(S)	TR. SI, PNP
C170	CK45F1H103Z	CAP. CERAMIC 0.01 50V	Q126	2SC2785(F)	TR. SI, NPN
C171	CK45F1H103Z	CAP. CERAMIC 0.01 50V	Q127	2SC2912(S)	TR. SI, NPN
C172	CK45F1H103Z	CAP. CERAMIC 0.01 50V	Q128	2SC2785(F)	TR. SI, NPN
C173	C90-0298-05	CAP. CERAMIC 0.1 20% 12V	Q129	2SC2785(F)	TR. SI, NPN
C174	C90-0298-05	CAP. CERAMIC 0.1 20% 12V			
C175	NO USE		R001	RN148K2E4701F	RES. METAL FILM 4.7K 1% 1/4W
C176	CK45B1H152K	CAP. CERAMIC 1500P 10% 50V	R002	RD148B2E221J	RES. CARBON 220 5% 1/4W
D001	DS442X	DIODE, SILICON SWITCHING	R003	RD148B2E183J	RES. CARBON 18K 5% 1/4W
D002	DS442X	DIODE, SILICON SWITCHING	R004	RD148B2E104J	RES. CARBON 100K 5% 1/4W
D003	NO USE		R005	RN148K2E4702F	RES. METAL FILM 47K 1% 1/4W
D004	W06C	DIODE, SILICON RECTIFIER	R006	RD148B2E101J	RES. CARBON 100 5% 1/4W
D005	W06C	DIODE, SILICON RECTIFIER	R007	RN148K2E3303F	RES. METAL FILM 330K 1% 1/4W
D006	1S583	DIODE, SILICON SWITCHING	R008	RD148B2E102J	RES. CARBON 1K 5% 1/4W
D007	1S583	DIODE, SILICON SWITCHING	R009	RD148B2E104J	RES. CARBON 100K 5% 1/4W
D008	DS442X	DIODE, SILICON SWITCHING	R010	RD148B2E472J	RES. CARBON 4.7K 5% 1/4W
D009	DS442X	DIODE, SILICON SWITCHING	R011	RD148B2E221J	RES. CARBON 220 5% 1/4W
D101	DS442X	DIODE, SILICON SWITCHING	R012	RD148B2E103J	RES. CARBON 10K 5% 1/4W
D102	NO USE		R013	R92-1033-05	RES. FIXED 33M
D103	DS442X	DIODE, SILICON SWITCHING	R014	RD148B2E334J	RES. CARBON 330K 5% 1/4W
D104	DS442X	DIODE, SILICON SWITCHING	R015	R92-1034-05	RES. METAL FILM 47M
D105	DS442X	DIODE, SILICON SWITCHING	R016	R92-1031-05	RES. FIXED 4.7M
D106	DS442X	DIODE, SILICON SWITCHING	R017	R92-0800-05	RES. FIXED 10M
D107	DS442X	DIODE, SILICON SWITCHING	R018	RD148B2E823J	RES. CARBON 82K 5% 1/4W
D108	DS442X	DIODE, SILICON SWITCHING	R019	RD148B2E393J	RES. CARBON 39K 5% 1/4W
D109	DS442X	DIODE, SILICON SWITCHING	R020	RD148B2E333J	RES. CARBON 33K 5% 1/4W
D110	DS442X	DIODE, SILICON SWITCHING	R021	RD148B2E473J	RES. CARBON 47K 5% 1/4W
D111	DS442X	DIODE, SILICON SWITCHING	R022	RD148B2E103J	RES. CARBON 10K 5% 1/4W
D112	DS442X	DIODE	R023	RD148B2E223J	RES. CARBON 2.2K 5% 1/4W
D113	DS442X	DIODE	R024	RN148K2E6800F	RES. METAL FILM 680 1% 1/4W
D114	NO USE		R025	RD148K2E2400F	RES. METAL FILM 24K 1% 1/4W
D115	DS442X	DIODE	R026	RN148K2E1302F	RES. METAL FILM 13K 1% 1/4W
D116	NO USE		R027	RD148B2E102J	RES. CARBON 1K 5% 1/4W
D117	MTZ5.1JB	DIODE, ZENER 5V	R028	RD148B2E562J	RES. CARBON 5.6K 5% 1/4W
D121	DS442X	DIODE, SILICON SWITCHING	R029	RD148B2E4R7J	RES. CARBON 4.7 5% 1/4W
D124	DS442X	DIODE	R030	NO USE	
D125	DS442X	DIODE	R031	RD148B2E470J	RES. CARBON 47 5% 1/4W
L001	L40-1011-13	FERRI INDUCTOR 100UH	R032	RD148B2E224J	RES. CARBON 220K 5% 1/4W
L002	L40-1011-13	FERRI INDUCTOR 100UH	R033	RD148B2E563J	RES. CARBON 56K 5% 1/4W
L003	L40-1021-03	FERRI INDUCTOR	R101	RN148K2E1004F	RES. METAL FILM 1M 1% 1/4W
L004	L40-1021-13	FERRI INDUCTOR	R102	RD148B2E104J	RES. CARBON 100K 5% 1/4W
L005	L40-1021-13	FERRI INDUCTOR	R103	RD148B2E153J	RES. CARBON 15K 5% 1/4W
L006	L40-1021-13	FERRI INDUCTOR	R104	RD148B2E153J	RES. CARBON 15K 5% 1/4W
L007	L40-1021-13	FERRI INDUCTOR	R105	RD148B2E201J	RES. CARBON 200 5% 1/4W
L008	L40-4791-02	FERRI INDUCTOR 4.7UH	R106	RD148B2E302J	RES. CARBON 3K 5% 1/4W
L101	L40-1011-13	FERRI INDUCTOR 100UH	R107	RN148K2E3301F	RES. METAL FILM 3.3K 1% 1/4W
NL001	NE-2B	NEON LAMP	R108	RN148K2E3300F	RES. METAL FILM 330 1% 1/4W
NL002	NE-2B	NEON LAMP	R109	RN148K2E3600F	RES. METAL FILM 360 1% 1/4W
P001	E40-0274-05	PIN CONNECTOR 2 P	R110	RN148K2E4701F	RES. METAL FILM 4.7K 1% 1/4W
P002	E40-0374-05	PIN CONNECTOR 3P	R111	RN148K2E5101F	RES. METAL FILM 5.1K 1% 1/4W
P003	E40-0335-05	PIN CONNECTOR 3P	R112	RD148B2E103J	RES. CARBON 10K 5% 1/4W
P004	E40-0535-05	PIN CONNECTOR 5P	R113	RD148B2E183J	RES. CARBON 18K 5% 1/4W
P005	E40-0233-05	PIN CONNECTOR 2P	R114	RD148B2E222J	RES. CARBON 2.2K 5% 1/4W
P101	E40-1116-05	PIN CONNECTOR 11P	R115	RD148B2E223J	RES. CARBON 2.2K 5% 1/4W
P102	E40-1116-05	PIN CONNECTOR 11P	R116	RD148B2E223J	RES. CARBON 2.2K 5% 1/4W
P103	E40-0273-05	PIN CONNECTOR 2 P	R117	RD148B2E472J	RES. CARBON 4.7K 5% 1/4W
Q001	2SC2912(S)	TR. SI, NPN	R118	RD148B2E105J	RES. CARBON 1M 5% 1/4W
Q002	2SA1210(S)	TR. SI, PNP	R119	RD148B2E622J	RES. CARBON 6.2K 5% 1/4W
Q003	2SD613(E)	TR. SI, NPN	R120	RD148B2E102J	RES. CARBON 1K 5% 1/4W
Q004	2SC2785(F)	TR. SI, NPN	R121	RD148B2E472J	RES. CARBON 4.7K 5% 1/4W
			R122	RN148K2E2701F	RES. METAL FILM 2.7K 1% 1/4W
			R123	RN148K2E3600F	RES. METAL FILM 360 1% 1/4W
			R124	RN148K2E3600F	RES. METAL FILM 360 1% 1/4W
			R125	RD148B2E102J	RES. CARBON 1K 5% 1/4W
			R126	RN148K2E1002F	RES. METAL FILM 10K 1% 1/4W
			R127	RD148K2E2701F	RES. METAL FILM 2.7K 1% 1/4W
			R128	RD148B2E102J	RES. CARBON 1K 5% 1/4W
			R129	RD148B2E561J	RES. CARBON 560 5% 1/4W
			R130	RD148B2E182J	RES. CARBON 1.8K 5% 1/4W

PARTS LIST

REF.NO	PARTS NO	NAME & DESCRIPTION
R131	RD14BB2E681J	RES. CARBON 680 5% 1/4W
R132	RD14BB2E472J	RES. CARBON 4.7K 5% 1/4W
R133	RD14BB2E222J	RES. CARBON 2.2K 5% 1/4W
R134	RD14BB2E102J	RES. CARBON 1K 5% 1/4W
R135	RD14BB2E472J	RES. CARBON 4.7K 5% 1/4W
R136	RD14BB2E222J	RES. CARBON 2.2K 5% 1/4W
R137	RD14BB2E102J	RES. CARBON 1K 5% 1/4W
R138	RD14BB2E102J	RES. CARBON 1K 5% 1/4W
R139	RD14BB2E562J	RES. CARBON 5.6K 5% 1/4W
R140	RD14BB2E221J	RES. CARBON 220 5% 1/4W
R141	RD14BB2E221J	RES. CARBON 220 5% 1/4W
R142	RD14BB2E220J	RES. CARBON 22 5% 1/6W
R143	RD14BB2E472J	RES. CARBON 4.7K 5% 1/4W
R144	RD14BB2E103J	RES. CARBON 10K 5% 1/4W
R145	RD14BB2E182J	RES. CARBON 1.8K 5% 1/4W
R146	RD14BB2E472J	RES. CARBON 4.7K 5% 1/4W
R147	RN14BK2E3302F	RES. METAL FILM 33K 1% 1/4W
R148	RD14BB2E102J	RES. CARBON 1K 5% 1/4W
R149	RN14BK2E3602F	RES. METAL FILM 36K 1% 1/4W
R150	RS14GB3D183J	RES. METAL FILM 18K 5% 2W
R151	RD14BB2E102J	RES. CARBON 1K 5% 1/4W
R152	RD14BB2E153J	RES. CARBON 15K 5% 1/4W
R153	RD14BB2E153J	RES. CARBON 15K 5% 1/4W
R154	RD14BB2E133J	RES. CARBON 13K 5% 1/4W
R155	RD14BB2E132J	RES. CARBON 1.3K 5% 1/6W
R156	RN14BK2E1201F	RES. METAL FILM 1.2K 1% 1/4W
R157	RN14BK2E1201F	RES. METAL FILM 1.2K 1% 1/4W
R158	RN14BK2E4301F	RES. METAL FILM 4.3K 1% 1/4W
R159	RN14BK2E9101F	RES. METAL FILM 9.1K 1% 1/4W
R160	RN14BK2E3004F	RES. METAL FILM 3M 1% 1/4W
R161	RN14BK2E1004F	RES. METAL FILM 1M 1% 1/4W
R162	RN14BK2E5003F	RES. METAL FILM 500K 1% 1/4W
R163	RN14BK2E3003F	RES. METAL FILM 300K 1% 1/4W
R164	RN14BK2E1003F	RES. METAL FILM 100K 1% 1/4W
R165	RN14BK2E5002F	RES. METAL FILM 50K 1% 1/4W
R166	RN14BK2E3002F	RES. METAL FILM 30K 1% 1/4W
R167	RN14BK2E2002F	RES. METAL FILM 20K 1% 1/4W
R168	RD14BB2E472J	RES. CARBON 4.7K 5% 1/4W
R169	RD14BB2E222J	RES. CARBON 2.2K 5% 1/4W
R170	RD14BB2E472J	RES. CARBON 4.7K 5% 1/4W
R171	RN14BK2E4701F	RES. METAL FILM 4.7K 1% 1/4W
R172	RD14BB2E472J	RES. CARBON 4.7K 5% 1/4W
R173	RD14BB2E101J	RES. CARBON 100 5% 1/4W
R174	RD14BB2E391J	RES. CARBON 390 5% 1/4W
R175	RN14BK2E2201F	RES. METAL FILM 2.2K 1% 1/4W
R176	RN14BK2E2201F	RES. METAL FILM 2.2K 1% 1/4W
R177	RD14BB2E182J	RES. CARBON 1.8K 5% 1/4W
R178	RD14BB2E182J	RES. CARBON 1.8K 5% 1/4W
R179	RD14BB2E103J	RES. CARBON 10K 5% 1/4W
R180	RN14BK2E9101F	RES. METAL FILM 9.1K 1% 1/4W
R181	RD14BB2E103J	RES. CARBON 10K 5% 1/4W
R182	RD14BB2E103J	RES. CARBON 10K 5% 1/4W
R183	RD14BB2E683J	RES. CARBON 68K 5% 1/4W
R184	RD14BB2E621J	RES. CARBON 620 5% 1/4W
R185	RD14BB2E102J	RES. CARBON 1K 5% 1/4W
R186	RD14BB2E473J	RES. CARBON 47K 5% 1/4W
R187	RD14BB2E183J	RES. CARBON 18K 5% 1/4W
R188	RD14BB2E103J	RES. CARBON 10K 5% 1/4W
R189	RD14BB2E102J	RES. CARBON 1K 5% 1/4W
R190	RS14GB3D103J	RES. METAL FILM 10K 5% 2W
R191	RD14BB2E683J	RES. CARBON 68K 5% 1/4W
R192	RD14BB2E103J	RES. CARBON 10K 5% 1/4W
R193	RD14BB2E122J	RES. CARBON 1.2K 5% 1/4W
R194	RD14BB2E122J	RES. CARBON 1.2K 5% 1/4W
R195	RD14BB2E821J	RES. CARBON 820 5% 1/4W
R196	RD14BB2E821J	RES. CARBON 820 5% 1/4W
R197	NO USE	
R198	RD14BB2E222J	RES. CARBON 2.2K 5% 1/4W
R199	RD14BB2E221J	RES. CARBON 220 5% 1/4W
R205	RD14BB2E102J	RES. CARBON 1K 5% 1/4W
R206	RD14BB2E363J	RES. CARBON 36K 5% 1/4W
R207	RN14BK2E1202F	RES. METAL FILM 1.2K 1% 1/4W
R210	RD14BB2E101J	RES. CARBON 100 5% 1/4W
R211	RD14BB2E470J	RES. CARBON 47 5% 1/4W
R212	RD14BB2E101J	RES. CARBON 100 5% 1/4W
R213	NO USE	
R214	RN14BK2E5101F	RES. METAL FILM 5.1K 1% 1/4W
R217	RD14BB2E183J	RES. CARBON 18K 5% 1/4W
R221	RD14BB2E133J	RES. CARBON 13K 5% 1/4W
R222	RD14BB2E102J	RES. CARBON 1K 5% 1/6W
R225	RD14BB2E222J	RES. CARBON 2.2K 5% 1/4W
R226	NO USE	
R227	RD14BB2E100J	RES. CARBON 1K 5% 1/6W
R228	RD14BB2E133J	RES. CARBON 13K 5% 1/6W
S101	R01-3510-05	V.R. WITH SW. 10K B
S102	R01-3510-05	V.R. WITH SW. 10K B
S103	S02-2505-15	ROTARY SWITCH WITH VR.2KB
S104	S33-2501-05	LEVER SWITCH
S105	S32-2012-05	LEVER SWITCH
S106	S32-4007-05	SLIDE SWITCH

REF.NO	PARTS NO	NAME & DESCRIPTION
T001	L19-0412-05	CONVERTOR TRANSFORMER
TC101	C05-0422-05	CAP. TRIMMERY 20P
TC102	C05-0421-05	CAP. TRIMMER 10P
U001	NJM4558D	IC
U101	MC10103L	IC, QUAD 2-INPUT OR GATE
U102	SN74LS11CN	IC
U103	SN74LS07N	IC, QUAD 2-INPUT NOR GATE
U104	SN74LS00N	IC
U105	SN74LS08N	IC, QUAD 2-INPUT AND GATE
UR001	R12-5518-05	RES. SEMI FIXED 100K B
VR101	R01-3510-05	V.R. WITH SW. 10K B
VR102	R01-3510-05	V.R. WITH SW. 10K B
VR103	S02-2505-15	ROTARY SWITCH WITH VR.2KB
VR104	R12-3520-05	RES. SEMI FIXED 10K B
VR105	R12-1518-05	RES. SEMI FIXED 2K B
VR106	R12-0421-05	RES. SEMI FIXED 100 B
VR107	R12-1517-05	RES. SEMI FIXED 1K B
VR108	NO USE	
VR109	R12-5518-05	RES. SEMI FIXED 200K OHM B
VR110	NO USE	
VR111	R12-0540-05	RES. SEMI FIXED 500 B

HORIZONTAL & HIGH VOLTAGE UNIT (X74-1340-01)

REF.NO	PARTS NO	NAME & DESCRIPTION
E23-0015-04	E23-0015-04	EARTH LUG
E23-0046-04	E23-0046-04	TERMINAL
E31-2170-05	E31-2170-05	JUMPING WIRE
E33-4029-00	E33-4029-00	WIRE ASSY
F01-0230-04	F01-0230-04	HEAT SINK
F01-0820-04	F01-0820-04	HEAT SINK
F01-0835-05	F01-0835-05	HEAT SINK
F15-0727-04	F15-0727-04	HOLDER (NEON TUBE)
F20-0622-05	F20-0622-05	INSULATOR
J25-2998-13	J25-2998-13	PCB (UNMOUNTED)
J31-0604-04	J31-0604-04	COLLAR
J31-0604-04	J31-0604-04	COLLAR
N19-0191-05	N19-0191-05	WASHER NONMETAL
N30-3006-46	N30-3006-46	SCREW, PAN HD M 3X6
N30-3008-46	N30-3008-46	SCREW, PAN HD M 3X8
R92-0150-05	R92-0150-05	JUMPING RES. ZERO OHM
W02-0408-05	W02-0408-05	HIGH VOLTAGE POWER BLOCK
212-3013-05	212-3013-05	TUBE (PLASTIC)
C001	CC45FCH1H330J	CAP. CERAMIC 33P 5% 50V
C002	CC45CH2H010C	CAP. CERAMIC 1P 0.25P 500V
C003	CK45B2H472K	CAP. CERAMIC 4700P 10% 500V
C004	CE04FW1H100M	CAP. ELECTRO 10 20% 50V
C005	CE04W2E100M	CAP. ELECTRO 10 20% 250V
C006	C093FM1H104K	CAP. MYLAR 0.1 10% 50V
C007	C093FM1H153K	CAP. MYLAR 0.015 10% 50V
C008	CE04W1V471M	CAP. ELECTRO 470 20% 35V
C009	C093FM1H104K	CAP. MYLAR 0.1 10% 50V
C010	C093FM1H223K	CAP. MYLAR 0.022 10% 50V
C011	CK45B2H102K	CAP. CERAMIC 1000P 10% 500V
C012	CK45E3D103P	CAP. CERAMIC 0.01 2K
C013	CK45E3D103P	CAP. CERAMIC 0.01 2K
C014	NO USE	
C015	CE04W2E010M	CAP. ELECTRO 1 20% 250V
C016	CE04W2E47R7M	CAP. ELECTRO 4.7 20% 250V
C017	CK45B2H472K	CAP. CERAMIC 4700P 10% 500V
C018	CE04FW1E4700M	CAP. ELECTRO 47 20% 25V
C019	CC45FCH1H100D	CAP. CERAMIC 10P 0.5P 50V
C020	CE04W1E101M	CAP. ELECTRO 100 20% 25V
C021	CK45B2H103K	CAP. CERAMIC 0.01 10% 500V
C022	CE04W1E101M	CAP. ELECTRO 100 20% 25V
C023	CE04W1E101M	CAP. ELECTRO 100 20% 25V
C024	C90-0912-05	CAP. ELECTRO 220 20% 35V
C025	C90-0912-05	CAP. ELECTRO 220 20% 35V
C026	CK45F1H103Z	CAP. CERAMIC 0.01 50V
C027	CK45B2H472K	CAP. CERAMIC 4700P 10% 500V
C028	CE04FW2A3R3M	CAP. ELECTRO 3.3 20% 100V
C029	C91-0571-05	CAP. CERAMIC 0.01 2KV
C030	CK45E3D102P	CAP. CERAMIC 1000P 2K
C031	CC45FCH1H180J	CAP. CERAMIC 18P 5% 50V
C101	C093FM1H103K	CAP. MYLAR 0.01 10% 50V
C102	C093FM1H103K	CAP. MYLAR 0.01 10% 50V
C103	CK45F1H103Z	CAP. CERAMIC 0.01 50V
C104	CK45F1H103Z	CAP. CERAMIC 0.01 50V
C105	CC45CH1H221J	CAP. CERAMIC 220P 5% 50V
C106	CE04FW1H100M	CAP. ELECTRO 10 20% 50V
C107	NO USE	
C108	CE04HW1H010M	CAP. ELECTRO 1 20% 50V
C109	CK45B1H472K	CAP. CERAMIC 4700P 10% 50V
C110	CK45F1H103Z	CAP. CERAMIC 0.01 50V
C111	CC45CH1H101J	CAP. CERAMIC 100P 5% 50V
C112	CK45F1H103Z	CAP. CERAMIC 0.01 50V

PARTS LIST

REF.NO	PARTS NO	NAME & DESCRIPTION	REF.NO	PARTS NO	NAME & DESCRIPTION
G113	CC45CH1H101J	CAP. CERAMIC 100P 5% 50V	L001	L40-1011-13	FERRI INDUCTOR
C114	CE04FW1A101M	CAP. ELECTRO 1 20X 50V	L002	L40-1011-13	FERRI INDUCTOR
C115	CC45F1H101M	CAP. ELECTRO 100 20X 10V	L003	L40-1021-03	FERRI INDUCTOR
C116	CK45F1H103Z	CAP. CERAMIC 0.01 50V	L004	L40-1021-13	FERRI INDUCTOR
C117	CK45F1H103Z	CAP. CERAMIC 0.01 50V	L005	L40-1021-13	FERRI INDUCTOR
C118	CC45CH2H100D	CAP. CERAMIC 10P 0.5P 500V	L006	L40-1021-13	FERRI INDUCTOR
C119	CC45CH2H040C	CAP. CERAMIC 4P 0.25P 500V	L007	L40-1021-13	FERRI INDUCTOR
C120	CF93AN2A105J	CAP. POLYESTHEL 1 5% 100V	L008	L40-4791-02	FERRI INDUCTOR
C121	CQ93BP2A103F	CAP. MYLAR 0.01 1% 100V	L101	L40-1011-13	FERRI INDUCTOR
C122	CM93BD2A900J	CAP. MICA 90P 5% 100V	NL001	NE-2B	NEON LAMP
C123	CQ93FM1H102K	CAP. MYLAR 1000P 10% 50V	NL002	NE-2B	NEON LAMP
C124	CK45F1H103Z	CAP. CERAMIC 0.01 50V	P001	E40-0274-05	PIN CONNECTOR 2P
C125	CK45F1H103Z	CAP. CERAMIC 0.01 50V	P002	E40-0374-05	PIN CONNECTOR 3P
C126	CK45F1H103Z	CAP. CERAMIC 0.01 50V	P003	E40-0335-05	PIN CONNECTOR 3P
C127	CC45FCH1H330J	CAP. CERAMIC 33P 5% 50V	P004	E40-0535-05	PIN CONNECTOR 5P
C128	CE04FW1E470M	CAP. ELECTRO 47 20X 25V	P005	E40-0233-05	PIN CONNECTOR 2P
C129	CE04FW1H010M	CAP. ELECTRO 1 20X 50V	P101	E40-1116-05	PIN CONNECTOR 11P
C130	NO USE		P102	E40-1116-05	PIN CONNECTOR 11P
C131	CK45F1H103Z	CAP. CERAMIC 0.01 50V	P103	E40-0273-05	PIN CONNECTOR 2 CONTACT
C132	NO USE		Q001	2SC2912(S)	TR. SI, NPN
C133	CK45F1H103Z	CAP. CERAMIC 0.01 50V	Q002	2SA1210(S)	TR. SI, PNP
C134	CC45FCH1H270J	CAP. CERAMIC 27P 5% 50V	Q003	2SD613(E)	TR. SI, NPN
C135	CC45CH2H010C	CAP. CERAMIC 1P 0.25P 500V	Q004	2SC2785(F)	TR. SI, NPN
C135	CC45CH2H030C	CAP. CERAMIC 3P 0.25P 500V	Q005	2SC2271(D)	TR. SI, NPN
C136	CM93BD2A151J	CAP. MICA 150P 5% 100V	Q101	2SK117(Y)	FET. N-CHANNEL
C137	CC45CH1H680J	CAP. CERAMIC 68P 5% 50V	Q102	2SK117(Y)	FET. N-CHANNEL
C138	CC45CH2H060D	CAP. CERAMIC 6P 0.5P 500V	Q103	2SC2785(F)	TR. SI, NPN
C139	CC45CH2H060D	CAP. CERAMIC 6P 0.5P 500V	Q104	2SC2785(F)	TR. SI, NPN
C140	CK45F1H103Z	CAP. CERAMIC 0.01 50V	Q105	2SC2785(F)	TR. SI, NPN
C143	CK45F1H103Z	CAP. CERAMIC 0.01 50V	Q106	2SC2785(F)	TR. SI, NPN
C144	CK45F1H103Z	CAP. CERAMIC 0.01 50V	Q107	2SA1175(F)	TR. SI, PNP
C145	C91-0572-05	CAP. CERAMIC 0.1 12V	Q108	2SA1175(F)	TR. SI, PNP
C146	CK45F1H103Z	CAP. CERAMIC 0.01 50V	Q109	2SA838(C)	TR. SI, PNP
C147	CK45F1H103Z	CAP. CERAMIC 0.01 50V	Q110	2SA838(C)	TR. SI, PNP
C148	CK45F1H103Z	CAP. CERAMIC 0.01 50V	Q111	2SA1175(F)	TR. SI, PNP
C149	CK45F1H103Z	CAP. CERAMIC 0.01 50V	Q112	2SA1175(F)	TR. SI, PNP
C150	CE04W1E101M	CAP. ELECTRO 100 20X 25V	Q113	2SC2785(F)	TR. SI, NPN
C151	CE04W1A221M	CAP. ELECTRO 220 20X 10V	Q114	2SC2785(F)	TR. SI, NPN
C152	CE04W1E101M	CAP. ELECTRO 100 20X 25V	Q115	2SK117(Y)	FET. N-CHANNEL
C153	CK45F1H103Z	CAP. CERAMIC 0.01 50V	Q116	2SC2785(F)	TR. SI, NPN
C154	CE04W2E4R7M	CAP. ELECTRO 4.7 20X 250V	Q117	2SC2785(F)	TR. SI, NPN
C155	CK45B2H472K	CAP. CERAMIC 4700P 10% 500V	Q118	2SC2785(F)	TR. SI, NPN
C156	NO USE		Q119	2SC2785(F)	TR. SI, NPN
C157	CQ93FM1H103K	CAP. MYLAR 0.01 10% 50V	Q120	2SC2785(F)	TR. SI, NPN
C158	CC45FCH1H150J	CAP. CERAMIC 15P 5% 50V	Q121	2SA1175(F)	TR. SI, PNP
C159	CE04FW1E470M	CAP. ELECTRO 47 20X 25V	Q122	2SA1175(F)	TR. SI, PNP
C160	CE04FW1E470M	CAP. ELECTRO 47 20X 25V	Q123	2SA1175(F)	TR. SI, PNP
C161	CE04FW1E470M	CAP. ELECTRO 47 20X 25V	Q124	2SC2912(S)	TR. SI, NPN
C162	NO USE		Q125	2SA1210(S)	TR. SI, PNP
C163	CC45FCH1H100D	CAP. CERAMIC 10P 0.5P 50V	Q126	2SC2785(F)	TR. SI, NPN
C164	CK45F1H103Z	CAP. CERAMIC 0.01 50V	Q127	2SC2912(S)	TR. SI, NPN
C165	CC45CH1H101J	CAP. CERAMIC 100P 5% 50V	Q128	2SC2785(F)	TR. SI, NPN
C166	CC45FCH1H100D	CAP. CERAMIC 10P 0.5P 50V	Q129	2SC2785(F)	TR. SI, NPN
C167	CC45CH1H101J	CAP. CERAMIC 100P 5% 50V	Q130	2SK117(Y)	FET. N-CHANNEL
C168	CE04W1E101M	CAP. ELECTRO 100 20X 25V	Q131	2SA1175(F)	TR. SI, PNP
C169	NO USE		R001	RN148K2E4701F	RES. METAL FILM 4.7K 1% 1/4W
C170	CK45F1H103Z	CAP. CERAMIC 0.01 50V	R002	RD148B2E221J	RES. CARBON 220 5% 1/4W
C171	CK45F1H103Z	CAP. CERAMIC 0.01 50V	R003	RD148B2E183J	RES. CARBON 18K 5% 1/4W
C172	NO USE		R004	RD148B2E104J	RES. CARBON 100K 5% 1/4W
C173	C91-0572-05	CAP. CERAMIC 0.1 12V	R005	RN148K2E4702F	RES. METAL FILM 47K 1% 1/4W
C174	C91-0572-05	CAP. CERAMIC 0.1 12V	R006	RD148B2E101J	RES. CARBON 100 5% 1/4W
D001	DS442X	DIODE	R007	RN148K2E3303F	RES. METAL FILM 330K 1% 1/4W
D002	DS442X	DIODE	R008	RD148B2E102J	RES. CARBON 1K 5% 1/4W
D003	NO USE		R009	RD148B2E104J	RES. CARBON 100K 5% 1/4W
D004	W06C	DIODE SILICON RECTIFIER	R010	RD148B2E472J	RES. CARBON 4.7K 5% 1/4W
D005	W06C	DIODE SILICON RECTIFIER	R011	RD148B2E221J	RES. CARBON 220 5% 1/4W
D006	1SS83	DIODE SILICON SWITCHING	R012	RD148B2E103J	RES. CARBON 10K 5% 1/4W
D007	1SS83	DIODE SILICON SWITCHING	R013	R92-1033-05	RES. FIXED 33M
D008	DS442X	DIODE	R014	RD148B2E334J	RES. CARBON 330K 5% 1/4W
D009	DS442X	DIODE	R015	R92-1034-05	RES. METAL FILM 47M
D101	DS442X	DIODE	R016	R92-1031-05	RES. FIXED 4.7M
D102	NO USE		R017	R92-0800-05	RES. FIXED 10M
D103	DS442X	DIODE	R018	RD148B2E823J	RES. CARBON 82K 5% 1/4W
D104	DS442X	DIODE	R019	RD148B2E393J	RES. CARBON 39K 5% 1/4W
D105	DS442X	DIODE	R020	RD148B2E333J	RES. CARBON 33K 5% 1/4W
D106	DS442X	DIODE	R021	RD148B2E473J	RES. CARBON 47K 5% 1/4W
D107	DS442X	DIODE	R022	RD148B2E103J	RES. CARBON 10K 5% 1/4W
D108	DS442X	DIODE	R023	RD148B2E222J	RES. CARBON 2.2K 5% 1/4W
D109	DS442X	DIODE	R024	RN148K2E6800F	RES. METAL FILM 680 1% 1/4W
D110	DS442X	DIODE	R025	RN148K2E2402F	RES. METAL FILM 24K 1% 1/4W
D111	DS442X	DIODE	R026	RN148K2E1302F	RES. METAL FILM 13K 1% 1/4W
D117	WZ-050	DIODE, ZENER 5V	R027	RD148B2E102J	RES. CARBON 1K 5% 1/4W
D118	DS442X	DIODE	R028	RD148B2E562J	RES. CARBON 5.6K 5% 1/4W
D119	NO USE		R029	RD148B2E4R7J	RES. CARBON 4.7 5% 1/4W
D120	DS442X	DIODE	R030	NO USE	
D121	DS442X	DIODE	R031	RD148B2E470J	RES. CARBON 47 5% 1/4W
D124	DS442X	DIODE	R032	RD148B2E224J	RES. CARBON 220K 5% 1/4W
D125	DS442X	DIODE	R033	RD148B2E563J	RES. CARBON 56K 5% 1/4W

REF.NO	PARTS NO	NAME & DESCRIPTION			
R101	RN14BK2E1004F	RES. METAL FILM	1M	1%	1/4W
R102	RD14BB2E104J	RES. CARBON	100K	5%	1/4W
R103	RD14BB2E153J	RES. CARBON	15K	5%	1/4W
R104	RD14BB2E153J	RES. CARBON	15K	5%	1/4W
R105	RD14BB2E152J	RES. CARBON	1.5K	5%	1/4W
R106	RD14BB2E223J	RES. CARBON	22K	5%	1/4W
R107	RN14BK2E3301F	RES. METAL FILM	3.3K	1%	1/4W
R108	RN14BK2E3300F	RES. METAL FILM	330	1%	1/4W
R109	RN14BK2E3600F	RES. METAL FILM	360	1%	1/4W
R110	RN14BK2E4701F	RES. METAL FILM	4.7K	1%	1/4W
R111	RN14BK2E5101F	RES. METAL FILM	5.1K	1%	1/4W
R112	RD14BB2E103J	RES. CARBON	10K	5%	1/4W
R113	RD14BB2E183J	RES. CARBON	18K	5%	1/4W
R114	RD14BB2E222J	RES. CARBON	2.2K	5%	1/4W
R115	RD14BB2E222J	RES. CARBON	2.2K	5%	1/4W
R116	RD14BB2E222J	RES. CARBON	2.2K	5%	1/4W
R117	RD14BB2E472J	RES. CARBON	4.7K	5%	1/4W
R118	RD14BB2E105J	RES. CARBON	1M	5%	1/4W
R119	RD14BB2E272J	RES. CARBON	2.7K	5%	1/4W
R120	RD14BB2E102J	RES. CARBON	1K	5%	1/4W
R121	RD14BB2E472J	RES. CARBON	4.7K	5%	1/4W
R122	RN14BK2E2701F	RES. METAL FILM	2.7K	1%	1/4W
R123	RN14BK2E3600F	RES. METAL FILM	360	1%	1/4W
R124	RN14BK2E3600F	RES. METAL FILM	360	1%	1/4W
R125	RD14BB2E102J	RES. CARBON	1K	5%	1/4W
R126	RN14BK2E1801F	RES. METAL FILM	1.8K	1%	1/4W
R127	RN14BK2E2701F	RES. METAL FILM	2.7K	1%	1/4W
R128	RD14BB2E102J	RES. CARBON	1K	5%	1/4W
R129	RD14BB2E561J	RES. CARBON	560	5%	1/4W
R130	RD14BB2E182J	RES. CARBON	1.8K	5%	1/4W
R131	RD14BB2E681J	RES. CARBON	680	5%	1/4W
R132	RD14BB2E472J	RES. CARBON	4.7K	5%	1/4W
R133	RD14BB2E222J	RES. CARBON	2.2K	5%	1/4W
R134	RD14BB2E102J	RES. CARBON	1K	5%	1/4W
R135	RD14BB2E472J	RES. CARBON	4.7K	5%	1/4W
R136	RD14BB2E222J	RES. CARBON	2.2K	5%	1/4W
R137	RD14BB2E102J	RES. CARBON	1K	5%	1/4W
R138	RD14BB2E102J	RES. CARBON	1K	5%	1/4W
R139	RD14BB2E562J	RES. CARBON	5.6K	5%	1/4W
R140	RD14BB2E221J	RES. CARBON	220	5%	1/4W
R141	RD14BB2E221J	RES. CARBON	220	5%	1/4W
R142	RD14BB2E220J	RES. CARBON	22	5%	1/4W
R143	RD14BB2E472J	RES. CARBON	4.7K	5%	1/4W
R144	RD14BB2E103J	RES. CARBON	10K	5%	1/4W
R145	RD14BB2E182J	RES. CARBON	1.8K	5%	1/4W
R146	RD14BB2E472J	RES. CARBON	4.7K	5%	1/4W
R147	RN14BK2E3302F	RES. METAL FILM	33K	1%	1/4W
R148	RD14BB2E102J	RES. CARBON	1K	5%	1/4W
R149	RN14BK2E3602F	RES. METAL FILM	36K	1%	1/4W
R150	RS14GB3D183J	RES. METAL FILM	18K	5%	2W
R151	RD14BB2E102J	RES. CARBON	1K	5%	1/4W
R152	RD14BB2E153J	RES. CARBON	15K	5%	1/4W
R153	RD14BB2E153J	RES. CARBON	15K	5%	1/4W
R154	RD14BB2E133J	RES. CARBON	13K	5%	1/4W
R155	RD14BB2C152J	RES. CARBON	1.5K	5%	1/6W
R156	RN14BK2E1201F	RES. METAL FILM	1.2K	1%	1/4W
R157	RN14BK2E1201F	RES. METAL FILM	1.2K	1%	1/4W
R158	RN14BK2E6801F	RES. METAL FILM	6.8K	1%	1/4W
R159	RN14BK2E9101F	RES. METAL FILM	9.1K	1%	1/4W
R160	RN14BK2E3004F	RES. METAL FILM	3M	1%	1/4W
R161	RN14BK2E1004F	RES. METAL FILM	1M	1%	1/4W
R162	RN14BK2E5003F	RES. METAL FILM	500K	1%	1/4W
R163	RN14BK2E3003F	RES. METAL FILM	300K	1%	1/4W
R164	RN14BK2E1003F	RES. METAL FILM	100K	1%	1/4W
R165	RN14BK2E5002F	RES. METAL FILM	50K	1%	1/4W
R166	RN14BK2E3002F	RES. METAL FILM	30K	1%	1/4W
R167	RN14BK2E2002F	RES. METAL FILM	20K	1%	1/4W
R168	RD14BB2E472J	RES. CARBON	4.7K	5%	1/4W
R169	RD14BB2E222J	RES. CARBON	2.2K	5%	1/4W
R170	RD14BB2E472J	RES. CARBON	4.7K	5%	1/4W
R171	RN14BK2E4701F	RES. METAL FILM	4.7K	1%	1/4W
R172	RD14BB2E472J	RES. CARBON	4.7K	5%	1/4W
R173	RD14BB2E101J	RES. CARBON	100	5%	1/4W
R174	RD14BB2E391J	RES. CARBON	390	5%	1/4W
R175	RN14BK2E2201F	RES. METAL FILM	2.2K	1%	1/4W
R176	RN14BK2E2201F	RES. METAL FILM	2.2K	1%	1/4W
R177	RD14BB2E182J	RES. CARBON	1.8K	5%	1/4W
R178	RD14BB2E182J	RES. CARBON	1.8K	5%	1/4W
R179	RD14BB2E103J	RES. CARBON	10K	5%	1/4W
R180	RN14BK2E9101F	RES. METAL FILM	9.1K	1%	1/4W
R181	RD14BB2E103J	RES. CARBON	10K	5%	1/4W
R182	RD14BB2E103J	RES. CARBON	10K	5%	1/4W
R183	RD14BB2E683J	RES. CARBON	68K	5%	1/4W
R184	RD14BB2E621J	RES. CARBON	620	5%	1/4W
R185	RD14BB2E102J	RES. CARBON	1K	5%	1/4W
R186	RD14BB2E473J	RES. CARBON	47K	5%	1/4W
R187	RD14BB2E183J	RES. CARBON	18K	5%	1/4W
R188	RD14BB2E103J	RES. CARBON	10K	5%	1/4W
R189	RD14BB2E102J	RES. CARBON	1K	5%	1/4W
R190	RS14GB3D103J	RES. METAL FILM	10K	5%	2W
R191	RD14BB2E683J	RES. CARBON	68K	5%	1/4W
R192	RD14BB2E103J	RES. CARBON	10K	5%	1/4W
R195	RD14BB2E821J	RES. CARBON	820	5%	1/4W
R196	RD14BB2E821J	RES. CARBON	820	5%	1/4W

REF.NO	PARTS NO	NAME & DESCRIPTION			
R197	NO USE				
R198	RD14BB2E222J	RES. CARBON	2.2K	5%	1/4W
R199	RD14BB2E221J	RES. CARBON	220	5%	1/4W
R200	RN14BK2E1004F	RES. METAL FILM	1M	1%	1/4W
R201	RD14BB2E104J	RES. CARBON	100K	5%	1/4W
R202	RD14BB2E153J	RES. CARBON	15K	5%	1/4W
R203	RD14BB2E472J	RES. CARBON	4.7K	5%	1/4W
R204	RD14BB2E751J	RES. CARBON	750	5%	1/4W
R205	RD14BB2E102J	RES. CARBON	1K	5%	1/4W
R206	RD14BB2E363J	RES. CARBON	36K	5%	1/4W
R207	RN14BK2E1202F	RES. METAL FILM	12K	1%	1/4W
R210	RD14BB2E101J	RES. CARBON	100	5%	1/4W
R211	RD14BB2E470J	RES. CARBON	47	5%	1/4W
R212	RD14BB2E101J	RES. CARBON	100	5%	1/4W
R213	NO USE				
R214	RN14BK2E3601F	RES. METAL FILM	3.6K	1%	1/4W
R217	RD14BB2E183J	RES. CARBON	18K	5%	1/4W
R221	RD14BB2E133J	RES. CARBON	13K	5%	1/4W
R222	RD14BB2E102J	RES. CARBON	1K	5%	1/4W
S103	S02-2506-05	ROTARY SWITCH			
S104	S32-2012-05	LEVER SWITCH			
S105	S32-2012-05	LEVER SWITCH			
S106	S32-4007-05	SLIDE SWITCH			
T001	L19-0412-05	CONVERTOR TRANSFORMER			
TC101	C05-0422-05	CAP. TRIMMER	20P		
U001	NJM4558D	IC, DUAL OP-AMP			
U101	MC10103L	IC, QUAD 2-INPUT OR GATE			
U102	SN74LS112N	IC, DUAL J-K FLIP-FLOP			
U103	SN74LS02N	IC, QUAD 2-INPUT NOR GATE			
VR001	R12-5516-05	RES. SEMI FIXED	100K OHM B		
VR101	R01-3510-05	V.R. WITH SW.	10K B		
VR102	R01-3510-05	V.R. WITH SW.	10K B		
VR103	S02-2506-15	ROTARY SWITCH	WITH VR.2K,10KB		
VR104	R12-3520-05	RES. SEMI FIXED	10K OHM B		
VR105	R12-1518-05	RES. SEMI FIXED	2K B		
VR106	R12-0421-05	RES. SEMI FIXED	100 B		
VR107	R12-1517-05	RES. SEMI FIXED	1KB		
VR108	NO USE				
VR109	R12-5516-05	RES. SEMI FIXED	200K OHM B		
VR110	R12-1517-05	RES. SEMI FIXED	1KB		
VR111	R12-0540-05	RES. SEMI FIXED	500 B		

HORIZONTAL & HIGH VOLTAGE UNIT (X74-1340-02)

REF.NO	PARTS NO	NAME & DESCRIPTION			
	E23-0015-04	EARTH LUG			
	E23-0046-04	TERMINAL			
	E31-2170-05	JUMPING WIRE			
	E33-4028-00	WIRE ASSY			
	F01-0230-04	HEAT SINK			
	F01-0820-04	HEAT SINK			
	F01-0835-05	HEAT SINK			
	F15-0727-04	HOLDER (NEON TUBE)			
	F20-0622-05	INSULATOR			
	J25-2998-13	PCB (UNMOUNTED)			
	J51-0604-04	COLLAR			
	N19-0191-05	WASHER NONMETAL			
	N30-3008-46	SCREW, PAN HD	M 3X8		
	R92-0150-05	JUMPING RES.	ZERO OHM		
	W02-0409-05	HIGH VOLTAGE POWER BLOCK			
	002-0001-05	BRAIDED WIRE			
	212-1018-05	TUBE (PLASTIC)			
	212-3013-05	TUBE (PLASTIC)			
C001	CC45CH1H330J	CAP. CERAMIC	33P	5%	50V
C002	CC45CH2H010C	CAP. CERAMIC	1P	0.25P	500V
C003	CK45B2H472K	CAP. CERAMIC	4700P	10%	500V
C004	CE04W1H100M	CAP. ELECTRO	10	20%	50V
C005	CE04W2E100	CAP. ELECTRO	10		250V
C006	CQ93FM1H104K	CAP. MYLAR	0.1	10%	50V
C007	CQ93FM1H153K	CAP. MYLAR	0.015	10%	50V
C008	CE04W1V471M	CAP. ELECTRO	470	20%	35V
C009	CQ93FM1H104K	CAP. MYLAR	0.1	10%	50V
C010	CQ93FM1H223K	CAP. MYLAR	0.022	10%	50V
C011	CK45B2H102K	CAP. CERAMIC	1000P	10%	500V
C012	CK45E3F332P	CAP. CERAMIC	3300P		3.1K
C013	CK45E3F332P	CAP. CERAMIC	3300P		3.1K
C014	NO USE				
C015	CE04W2E010	CAP. ELECTRO	1		250V
C016	CE04W2E4R7	CAP. ELECTRO	4.7		250V
C017	CK45B2H472K	CAP. CERAMIC	4700P	10%	500V
C018	CE04W1E470M	CAP. ELECTRO	47	20%	25V
C019	CC45FCH1H100D	CAP. CERAMIC	10P	0.5P	50V

PARTS LIST

REF. NO	PARTS NO	NAME & DESCRIPTION	REF. NO	PARTS NO	NAME & DESCRIPTION
C020	CE04W1E101M	CAP. ELECTRO 100 20% 25V	D103	D5442X	DIODE, SILICON SWITCHING
C021	CK45B2H103K	CAP. CERAMIC 0.01 10% 500V	D104	D5442X	DIODE, SILICON SWITCHING
C022	CE04W1E101M	CAP. ELECTRO 100 20% 25V	D105	D5442X	DIODE, SILICON SWITCHING
C023	CE04W1E101M	CAP. ELECTRO 100 20% 25V	D106	D5442X	DIODE, SILICON SWITCHING
C024	C90-0912-05	CAP. ELECTRO 220 20% 35V	D107	D5442X	DIODE, SILICON SWITCHING
C025	C90-0912-05	CAP. ELECTRO 220 20% 35V	D108	D5442X	DIODE, SILICON SWITCHING
C026	CK45F1H103Z	CAP. CERAMIC 0.01 50V	D109	D5442X	DIODE, SILICON SWITCHING
C027	CK45B2H472K	CAP. CERAMIC 4700P 10% 500V	D110	D5442X	DIODE, SILICON SWITCHING
C028	CE04W2A3R3M	CAP. ELECTRO 3.3 20% 100V	D111	D5442X	DIODE, SILICON SWITCHING
C029	C91-0570-05	CAP. CERAMIC 4700P 3KV	D112	D5442X	DIODE, SILICON SWITCHING
C030	CK45E3F102P	CAP. CERAMIC 1000P 3.1K	D113	D5442X	DIODE
C031	CC45CH1H180J	CAP. CERAMIC 18P 5% 50V	D114	NO USE	
			D115	D5442X	DIODE
C101	C093FM1H103K	CAP. MYLAR 0.01 10% 50V	D116	1S583	DIODE, SILICON SWITCHING
C102	C093FM1H103K	CAP. MYLAR 0.01 10% 50V	D117	MTZ5.1JB	DIODE, ZENER 5V
C103	CK45F1H103Z	CAP. CERAMIC 0.01 50V			
C104	CK45F1H103Z	CAP. CERAMIC 0.01 50V	D121	D5442X	DIODE, SILICON SWITCHING
C105	CC45CH1H221J	CAP. CERAMIC 220P 5% 50V	D122	NO USE	
C106	CE04W1H100M	CAP. ELECTRO 10 20% 50V	D123	1S583	DIODE, SILICON SWITCHING
C107	NO USE		D124	D5442X	DIODE
C108	C90-0298-05	CAP. CERAMIC 0.1 20% 12V	D125	D5442X	DIODE
C109	CK45B1H472K	CAP. CERAMIC 4700P 10% 50V	L001	L40-1011-13	FERRI INDUCTOR 100UH
C110	CK45F1H103Z	CAP. CERAMIC 0.01 50V	L002	L40-1011-13	FERRI INDUCTOR 100UH
C111	CC45CH1H101J	CAP. CERAMIC 100P 5% 50V	L003	L40-1021-03	FERRI INDUCTOR
C112	CK45F1H103Z	CAP. CERAMIC 0.01 50V	L004	L40-1021-13	FERRI INDUCTOR
C113	CC45CH1H101J	CAP. CERAMIC 100P 5% 50V	L005	L40-1021-13	FERRI INDUCTOR
C114	CE04W1H010M	CAP. ELECTRO 1 20% 50V	L006	L40-1021-13	FERRI INDUCTOR
C115	CE04W1A101M	CAP. ELECTRO 100 20% 10V	L007	L40-1021-13	FERRI INDUCTOR
C116	CK45F1H103Z	CAP. CERAMIC 0.01 50V	L008	L40-4791-02	FERRI INDUCTOR 4.7UH
C117	CK45F1H103Z	CAP. CERAMIC 0.01 50V	L101	L40-1011-13	FERRI INDUCTOR 100UH
C118	CC45CH2H100D	CAP. CERAMIC 10P 0.5P 500V	NL001	NE-2B	NEON LAMP
C119	CC45CH2H100D	CAP. CERAMIC 10P 0.5P 500V	NL002	NE-2B	NEON LAMP
C120	CF93AN2A105J	CAP. POLYESTHEL 1 5% 100V	P001	E40-0374-05	PIN CONNECTOR 2 P
C121	C093BP2A103F	CAP. MYLAR 0.01 1% 100V	P002	E40-0374-05	PIN CONNECTOR 3P
C122	CM93BD2A900J	CAP. MICA 90P 5% 100V	P003	E40-0335-05	PIN CONNECTOR 3P
C123	C093FM1H102K	CAP. MYLAR 1000P 10% 50V	P004	E40-0535-05	PIN CONNECTOR 5P
C124	CK45F1H103Z	CAP. CERAMIC 0.01 50V	P005	E40-0233-05	PIN CONNECTOR 2P
C125	CK45F1H103Z	CAP. CERAMIC 0.01 50V	P101	E40-1116-05	PIN CONNECTOR 11P
C126	CK45F1H103Z	CAP. CERAMIC 0.01 50V	P102	E40-1116-05	PIN CONNECTOR 11P
C127	NO USE		P103	E40-0273-05	PIN CONNECTOR 2 P
C128	CE04W1E470M	CAP. ELECTRO 47 20% 25V	Q001	2SC2912(S)	TR. SI, NPN
C129	CE04W1H010M	CAP. ELECTRO 1 20% 50V	Q002	2SA1210(S)	TR. SI, PNP
C130	NO USE		Q003	2SD613(E)	TR. SI, NPN
C131	CK45F1H103Z	CAP. CERAMIC 0.01 50V	Q004	2SC2785(F)	TR. SI, NPN
C132	NO USE		Q005	2SC2271(D)	TR. SI, NPN
C133	CK45F1H103Z	CAP. CERAMIC 0.01 50V	Q101	2SK117(Y)	FET, N-CHANNEL
C134	CC45FCH1H470J	CAP. CERAMIC 47P 5% 50V	Q102	2SK117(Y)	FET, N-CHANNEL
C135	CC45CH2H030C	CAP. CERAMIC 3P 0.25P 500V	Q103	2SC2785(F)	TR. SI, NPN
C136	CM93B02A151J	CAP. MICA 150P 5% 100V	Q104	2SC2785(F)	TR. SI, NPN
			Q105	2SC2785(F)	TR. SI, NPN
C139	CC45CH2H020C	CAP. CERAMIC 2P 0.25P 500V	Q106	2SC2785(F)	TR. SI, NPN
C140	CK45F1H103Z	CAP. CERAMIC 0.01 50V	Q107	2SA1175(F)	TR. SI, PNP
C141	CK45FB1H102K	CAP. CERAMIC 1000P 10% 50V	Q108	2SA1175(F)	TR. SI, PNP
C142	CC45CH1H221J	CAP. CERAMIC 220P 5% 50V	Q109	2SA1175(F)	TR. SI, PNP
C143	CK45F1H103Z	CAP. CERAMIC 0.01 50V	Q110	2SA1175(F)	TR. SI, PNP
C144	CK45F1H103Z	CAP. CERAMIC 0.01 50V	Q111	2SA1175(F)	TR. SI, PNP
C145	C90-0298-05	CAP. CERAMIC 0.1 20% 12V	Q112	2SA1175(F)	TR. SI, PNP
C146	CK45F1H103Z	CAP. CERAMIC 0.01 50V	Q113	2SC2785(F)	TR. SI, NPN
C147	CK45F1H103Z	CAP. CERAMIC 0.01 50V	Q114	2SC2785(F)	TR. SI, NPN
C148	CK45F1H103Z	CAP. CERAMIC 0.01 50V	Q115	2SK117(Y)	FET, N-CHANNEL
C149	CK45F1H103Z	CAP. CERAMIC 0.01 50V	Q116	2SC2785(F)	TR. SI, NPN
C150	CE04W1E101M	CAP. ELECTRO 100 20% 25V	Q117	2SC2785(F)	TR. SI, NPN
C151	CE04W1A221M	CAP. ELECTRO 220 20% 10V	Q118	2SC2785(F)	TR. SI, NPN
C152	CE04W1E101M	CAP. ELECTRO 100 20% 25V	Q119	2SC2785(F)	TR. SI, NPN
C153	CK45F1H103Z	CAP. CERAMIC 0.01 50V	Q120	2SC2785(F)	TR. SI, NPN
C154	CE04W2E4R7	CAP. ELECTRO 4.7 250V	Q121	2SA1175(F)	TR. SI, PNP
C155	CK45B2H472K	CAP. CERAMIC 4700P 10% 500V	Q122	2SA1175(F)	TR. SI, PNP
			Q123	2SA1175(F)	TR. SI, PNP
C158	CC45FCH1H150J	CAP. CERAMIC 15P 5% 50V	Q124	2SC2912(S)	TR. SI, NPN
C159	CE04W1E470M	CAP. ELECTRO 47 20% 25V	Q125	2SA1210(S)	TR. SI, PNP
C160	CE04W1E470M	CAP. ELECTRO 47 20% 25V	Q126	2SC2785(F)	TR. SI, NPN
C161	CE04W1E470M	CAP. ELECTRO 47 20% 25V	Q127	2SC2912(S)	TR. SI, NPN
C162	CK45F1H103Z	CAP. CERAMIC 0.01 50V	Q128	2SC2785(F)	TR. SI, NPN
C163	CC45FCH1H100D	CAP. CERAMIC 10P 0.5P 50V	Q129	2SC2785(F)	TR. SI, NPN
C164	CK45F1H103Z	CAP. CERAMIC 0.01 50V	R001	RN14BK2E4701F	RES. METAL FILM 4.7K 1% 1/4W
C165	CC45CH1H151J	CAP. CERAMIC 150P 5% 50V	R002	RD14BB2E221J	RES. CARBON 220 5% 1/4W
C166	NO USE		R003	RD14BB2E183J	RES. CARBON 18K 5% 1/4W
C167	CC45CH1H221J	CAP. CERAMIC 220P 5% 50V	R004	RD14BB2E104J	RES. CARBON 100K 5% 1/4W
C168	CE04W1E101M	CAP. ELECTRO 100 20% 25V	R005	RN14BK2E4702F	RES. METAL FILM 47K 1% 1/4W
C169	CC45FCH1H050C	CAP. CERAMIC 5P 0.25P 50V	R006	RD14BB2E101J	RES. CARBON 100 5% 1/4W
C173	C90-0298-05	CAP. CERAMIC 0.1 20% 12V	R007	RN14BK2E2403F	RES. METAL FILM 240K 1% 1/4W
C174	C90-0298-05	CAP. CERAMIC 0.1 20% 12V	R008	RD14BB2E102J	RES. CARBON 1K 5% 1/4W
C175	NO USE		R009	RD14BB2E104J	RES. CARBON 100K 5% 1/4W
C176	CK45B1H152K	CAP. CERAMIC 1500P 10% 50V	R010	RD14BB2E332J	RES. CARBON 3.3K 5% 1/4W
			R011	RD14BB2E221J	RES. CARBON 220 5% 1/4W
D001	D5442X	DIODE, SILICON SWITCHING	R012	RD14BB2E103J	RES. CARBON 10K 5% 1/4W
D002	D5442X	DIODE, SILICON SWITCHING	R013	R92-1033-05	RES. FIXED 33M
D003	NO USE		R014	RD14BB2E334J	RES. CARBON 330K 5% 1/4W
D004	W06C	DIODE, SILICON RECTIFIER	R015	R92-1034-05	RES. METAL FILM 47M
D005	W06C	DIODE, SILICON RECTIFIER			
D006	1S583	DIODE, SILICON SWITCHING			
D007	1S583	DIODE, SILICON SWITCHING			
D008	D5442X	DIODE, SILICON SWITCHING			
D009	D5442X	DIODE, SILICON SWITCHING			
D101	D5442X	DIODE, SILICON SWITCHING			
D102	NO USE				

PARTS LIST

REF. NO	PARTS NO	NAME & DESCRIPTION	REF. NO	PARTS NO	NAME & DESCRIPTION
R016	R92-1026-05	RES. METAL FILM 3.3M	R179	RD14BB2E103J	RES. CARBON 10K 5% 1/4W
R017	R92-1032-05	RES. FIXED 22M	R180	RN14BK2E1202F	RES. METAL FILM 12K 5% 1/4W
R018	RD14BB2E473J	RES. CARBON 47K 5% 1/4W	R181	RD14BB2E822J	RES. CARBON 8.2K 5% 1/4W
R019	RD14BB2E393J	RES. CARBON 39K 5% 1/4W	R182	RD14BB2E103J	RES. CARBON 10K 5% 1/4W
R020	RD14BB2E333J	RES. CARBON 33K 5% 1/4W	R183	RD14BB2E124J	RES. CARBON 120K 5% 1/4W
R021	RD14BB2E473J	RES. CARBON 47K 5% 1/4W	R184	RD14BB2E621J	RES. CARBON 620 5% 1/4W
R022	RD14BB2E103J	RES. CARBON 10K 5% 1/4W	R185	RD14BB2E102J	RES. CARBON 1K 5% 1/4W
R023	RD14BB2E222J	RES. CARBON 2.2K 5% 1/4W	R186	RD14BB2E473J	RES. CARBON 47K 5% 1/4W
R024	RN14BK2E6800F	RES. METAL FILM 680 1% 1/4W	R187	RD14BB2E203J	RES. CARBON 20K 5% 1/4W
R025	RN14BK2E2402F	RES. METAL FILM 24K 1% 1/4W	R188	RD14BB2E103J	RES. CARBON 10K 5% 1/4W
R026	RN14BK2E1302F	RES. METAL FILM 13K 1% 1/4W	R189	RD14BB2E102J	RES. CARBON 1K 5% 1/4W
R027	RD14BB2E102J	RES. CARBON 1K 5% 1/4W	R190	RS14GB3D103J	RES. METAL FILM 10K 5% 2W
R028	RD14BB2E562J	RES. CARBON 5.6K 5% 1/4W	R191	RD14BB2E124J	RES. CARBON 120K 5% 1/4W
R029	RD14BB2E4R7J	RES. CARBON 4.7 5% 1/4W	R192	RD14BB2E103J	RES. CARBON 10K 5% 1/4W
R030	NO USE		R193	RD14BB2E122J	RES. CARBON 1.2K 5% 1/4W
R031	RD14BB2E470J	RES. CARBON 47 5% 1/4W	R194	RD14BB2E122J	RES. CARBON 1.2K 5% 1/4W
R032	RD14BB2E224J	RES. CARBON 220K 5% 1/4W	R195	RD14BB2E821J	RES. CARBON 820 5% 1/4W
R033	RD14BB2E563J	RES. CARBON 56K 5% 1/4W	R196	RD14BB2E821J	RES. CARBON 820 5% 1/4W
R101	RN14BK2E1004F	RES. METAL FILM 1M 1% 1/4W	R197	NO USE	
R102	RD14BB2E104J	RES. CARBON 100K 5% 1/4W	R198	RD14BB2E222J	RES. CARBON 2.2K 5% 1/4W
R103	RD14BB2E153J	RES. CARBON 15K 5% 1/4W	R199	RD14BB2E211J	RES. CARBON 220 5% 1/4W
R104	RD14BB2E153J	RES. CARBON 15K 5% 1/4W	R205	RD14BB2E102J	RES. CARBON 1K 5% 1/4W
R105	RD14BB2E201J	RES. CARBON 200 5% 1/4W	R206	NO USE	
R106	RD14BB2E302J	RES. CARBON 3K 5% 1/4W	R207	RN14BK2E9101F	RES. METAL FILM 9.1K 1% 1/4W
R107	RN14BK2E3301F	RES. METAL FILM 3.3K 1% 1/4W	R210	RD14BB2E101J	RES. CARBON 100 5% 1/4W
R108	RN14BK2E3300F	RES. METAL FILM 330 1% 1/4W	R211	RD14BB2E470J	RES. CARBON 47 5% 1/4W
R109	RN14BK2E3600F	RES. METAL FILM 360 1% 1/4W	R212	RD14BB2E101J	RES. CARBON 100 5% 1/4W
R110	RN14BK2E4701F	RES. METAL FILM 4.7K 1% 1/4W	R213	RD14BB2E152J	RES. CARBON 1.5K 5% 1/4W
R111	RN14BK2E5101F	RES. METAL FILM 5.1K 1% 1/4W	R214	RN14BK2E5101F	RES. METAL FILM 5.1K 1% 1/4W
R112	RD14BB2E103J	RES. CARBON 10K 5% 1/4W	R217	RD14BB2E562J	RES. CARBON 5.6K 5% 1/4W
R113	RD14BB2E183J	RES. CARBON 18K 5% 1/4W	R221	RD14BB2E133J	RES. CARBON 13K 5% 1/4W
R114	RD14BB2E222J	RES. CARBON 2.2K 5% 1/4W	R222	RD14BB2C102J	RES. CARBON 1K 5% 1/6W
R115	RD14BB2E222J	RES. CARBON 2.2K 5% 1/4W	R223	RD14BB2E103J	RES. CARBON 10K 5% 1/4W
R116	RD14BB2E222J	RES. CARBON 2.2K 5% 1/4W	R224	NO USE	
R117	RD14BB2E472J	RES. CARBON 4.7K 5% 1/4W	R225	RD14BB2E222J	RES. CARBON 2.2K 5% 1/4W
R118	RD14BB2E105J	RES. CARBON 1M 5% 1/4W	R226	NO USE	
R119	RD14BB2E622J	RES. CARBON 6.2K 5% 1/4W	R227	RD14BB2C102J	RES. CARBON 1K 5% 1/6W
R120	RD14BB2E102J	RES. CARBON 1K 5% 1/4W	R228	RD14BB2C133J	RES. CARBON 13K 5% 1/6W
R121	RD14BB2E472J	RES. CARBON 4.7K 5% 1/4W	S101	R01-3510-05	V.R. WITH SW. 10K B
R122	RN14BK2E2701F	RES. METAL FILM 2.7K 1% 1/4W	S102	R01-3510-05	V.R. WITH SW. 10K B
R123	RN14BK2E3600F	RES. METAL FILM 360 1% 1/4W	S103	S02-2507-15	ROTARY SWITCH WITH VR.2KB
R124	RN14BK2E3600F	RES. METAL FILM 360 1% 1/4W	S104	S33-2501-05	LEVER SWITCH
R125	RD14BB2E102J	RES. CARBON 1K 5% 1/4W	S105	S32-2012-05	LEVER SWITCH
R126	RN14BK2E1002F	RES. METAL FILM 10K 1% 1/4W	S106	S32-4007-05	SLIDE SWITCH
R127	RN14BK2E2701F	RES. METAL FILM 2.7K 1% 1/4W	T001	L19-0413-05	CONVERTOR TRANSFORMER
R128	RD14BB2E102J	RES. CARBON 1K 5% 1/4W	TC101	C05-0422-05	CAP. TRIMMER 20P
R129	RD14BB2E561J	RES. CARBON 560 5% 1/4W	TC102	C05-0420-05	CAP. TRIMMER 6P
R130	RD14BB2E182J	RES. CARBON 1.8K 5% 1/4W	U001	NJM45580	IC
R131	RD14BB2E681J	RES. CARBON 680 5% 1/4W	U101	MC10103L	IC, QUAD 2-INPUT OR GATE
R132	RD14BB2E472J	RES. CARBON 4.7K 5% 1/4W	U102	SN74LS12N	IC
R133	RD14BB2E222J	RES. CARBON 2.2K 5% 1/4W	U103	SN74LS02N	IC, QUAD 2-INPUT NOR GATE
R134	RD14BB2E102J	RES. CARBON 1K 5% 1/4W	U104	SN74LS00N	IC
R135	RD14BB2E472J	RES. CARBON 4.7K 5% 1/4W	U105	SN74LS08N	IC, QUAD 2-INPUT AND GATE
R136	RD14BB2E222J	RES. CARBON 2.2K 5% 1/4W	VR001	R12-5516-05	RES. SEMI FIXED 100K B
R137	RD14BB2E102J	RES. CARBON 1K 5% 1/4W	VR101	R01-3510-05	V.R. WITH SW. 10K B
R138	RD14BB2E102J	RES. CARBON 1K 5% 1/4W	VR102	R01-3510-05	V.R. WITH SW. 10K B
R139	RD14BB2E562J	RES. CARBON 5.6K 5% 1/4W	VR103	S02-2507-15	ROTARY SWITCH WITH VR.2KB
R140	RD14BB2E221J	RES. CARBON 220 5% 1/4W	VR104	R12-3520-05	RES. SEMI FIXED 10K B
R141	RD14BB2E221J	RES. CARBON 220 5% 1/4W	VR105	R12-1518-05	RES. SEMI FIXED 2K B
R142	RD14BB2C201J	RES. CARBON 20 5% 1/6W	VR106	R12-0421-05	RES. SEMI FIXED 100 B
R143	RD14BB2E472J	RES. CARBON 4.7K 5% 1/4W	VR107	R12-1517-05	RES. SEMI FIXED 1K B
R144	RD14BB2E103J	RES. CARBON 10K 5% 1/4W	VR108	NO USE	
R145	RD14BB2E182J	RES. CARBON 1.8K 5% 1/4W	VR109	R12-5518-05	RES. SEMI FIXED 200K OHM B
R146	RD14BB2E472J	RES. CARBON 4.7K 5% 1/4W	VR110	NO USE	
R147	RN14BK2E3302F	RES. METAL FILM 33K 1% 1/4W	VR111	R12-0540-05	RES. SEMI FIXED 500 B
R148	RD14BB2E102J	RES. CARBON 1K 5% 1/4W			
R149	RN14BK2E3602F	RES. METAL FILM 36K 1% 1/4W			
R150	RS14GB3D183J	RES. METAL FILM 18K 5% 2W			
R151	RD14BB2E102J	RES. CARBON 1K 5% 1/4W			
R152	RD14BB2E153J	RES. CARBON 15K 5% 1/4W			
R153	RD14BB2E153J	RES. CARBON 15K 5% 1/4W			
R154	RD14BB2E133J	RES. CARBON 13K 5% 1/4W			
R155	RD14BB2C132J	RES. CARBON 1.3K 5% 1/6W			
R156	RN14BK2E1201F	RES. METAL FILM 1.2K 1% 1/4W			
R157	RN14BK2E1201F	RES. METAL FILM 1.2K 1% 1/4W			
R158	RN14BK2E4301F	RES. METAL FILM 4.3K 1% 1/4W			
R159	RN14BK2E9101F	RES. METAL FILM 9.1K 1% 1/4W			
R160	RN14BK2E3004F	RES. METAL FILM 3M 1% 1/4W			
R161	RN14BK2E1004F	RES. METAL FILM 1M 1% 1/4W			
R162	RN14BK2E5003F	RES. METAL FILM 500K 1% 1/4W			
R163	RN14BK2E3003F	RES. METAL FILM 300K 1% 1/4W			
R164	RN14BK2E1003F	RES. METAL FILM 100K 1% 1/4W			
R165	RN14BK2E5002F	RES. METAL FILM 50K 1% 1/4W			
R166	RN14BK2E3002F	RES. METAL FILM 30K 1% 1/4W			
R167	RN14BK2E2002F	RES. METAL FILM 20K 1% 1/4W			
R168	RD14BB2E472J	RES. CARBON 4.7K 5% 1/4W			
R169	RD14BB2E222J	RES. CARBON 2.2K 5% 1/4W			
R170	RD14BB2E472J	RES. CARBON 4.7K 5% 1/4W			
R171	RN14BK2E4701F	RES. METAL FILM 4.7K 1% 1/4W			
R172	RD14BB2E472J	RES. CARBON 4.7K 5% 1/4W			
R173	RD14BB2E101J	RES. CARBON 100 5% 1/4W			
R174	RD14BB2E391J	RES. CARBON 390 5% 1/4W			
R175	RN14BK2E2201F	RES. METAL FILM 2.2K 1% 1/4W			
R176	RN14BK2E2201F	RES. METAL FILM 2.2K 1% 1/4W			
R177	RD14BB2E182J	RES. CARBON 1.8K 5% 1/4W			
R178	RD14BB2E182J	RES. CARBON 1.8K 5% 1/4W			

HORIZONTAL & HIGH VOLTAGE UNIT

(X74-1340-03)

REF. NO	PARTS NO	NAME & DESCRIPTION
	E23-0015-04	EARTH LUG
	E23-0046-04	TERMINAL
	E31-2170-05	JUMPING WIRE
	E33-4029-00	WIRE ASSY
	F01-0230-04	HEAT SINK
	F01-0820-04	HEAT SINK
	F01-0835-05	HEAT SINK
	F15-0727-04	HOLDER (NEON TUBE)
	F20-0622-05	INSULATOR
	J25-2998-13	PCB (UNMOUNTED)
	J31-0604-04	COLLAR
	N19-0191-05	WASHER NONMETAL
	N30-3008-46	SCREW, PAN HD M 3X8

PARTS LIST

REF.NO	PARTS NO	NAME & DESCRIPTION	REF.NO	PARTS NO	NAME & DESCRIPTION
	R92-0150-05	JUMPING RES. ZERO OHM	C163	CC45FCH1H1000	CAP. CERAMIC 10P 0.5P 50V
	W02-0409-05	HIGH VOLTAGE POWER BLOCK	C164	CK45F1H103Z	CAP. CERAMIC 0.01 50V
	002-0001-05	BRAIDED WIRE	C165	CC45CH1H151J	CAP. CERAMIC 150P 5% 50V
	212-1018-05	TUBE (PLASTIC)	C166	CC45FCH1H1000	CAP. CERAMIC 10P 0.5P 50V
	212-3013-05	TUBE (PLASTIC)	C167	CC45CH1H221J	CAP. CERAMIC 220P 5% 50V
C001	CC45CH1H330J	CAP. CERAMIC 33P 5% 50V	C168	CE04W1E101M	CAP. ELECTRO 100 20% 25V
C002	CC45CH2H010C	CAP. CERAMIC 1P 0.25P 500V	C169	CC45FCH1H050C	CAP. CERAMIC 5P 0.25P 50V
C003	CK45B2H472K	CAP. CERAMIC 4700P 10% 500V	C173	C90-0298-05	CAP. CERAMIC 0.1 20% 12V
C004	CE04W1H100M	CAP. ELECTRO 10 20% 50V	C174	C90-0298-05	CAP. CERAMIC 0.1 20% 12V
C005	CE04W2E100	CAP. ELECTRO 10 250V	C175	NO USE	
C006	C093FM1H104K	CAP. MYLAR 0.1 10% 50V	C176	CK45B1H152K	CAP. CERAMIC 1500P 10% 50V
C007	C093FM1H153K	CAP. MYLAR 0.015 10% 50V	D001	D5442X	DIODE, SILICON SWITCHING
C008	CE04W1U471M	CAP. ELECTRO 470 20% 35V	D002	D5442X	DIODE, SILICON SWITCHING
C009	C093FM1H104K	CAP. MYLAR 0.1 10% 50V	D003	NO USE	
C010	C093FM1H223K	CAP. MYLAR 0.022 10% 50V	D004	W06C	DIODE, SILICON RECTIFIER
C011	CK45B2H102K	CAP. CERAMIC 1000P 10% 500V	D005	W06C	DIODE, SILICON RECTIFIER
C012	CK45E3F332P	CAP. CERAMIC 3300P 3.1K	D006	1S583	DIODE, SILICON SWITCHING
C013	CK45E3F332P	CAP. CERAMIC 3300P 3.1K	D007	1S583	DIODE, SILICON SWITCHING
C014	NO USE		D008	D5442X	DIODE, SILICON SWITCHING
C015	CE04W2E010	CAP. ELECTRO 1 250V	D009	D5442X	DIODE, SILICON SWITCHING
C016	CE04W2E4R7	CAP. ELECTRO 4.7 250V	D101	D5442X	DIODE, SILICON SWITCHING
C017	CK45B2H472K	CAP. CERAMIC 4700P 10% 500V	D102	NO USE	
C018	CE04W1E470M	CAP. ELECTRO 47 20% 25V	D103	D5442X	DIODE, SILICON SWITCHING
C019	CC45FCH1H1000	CAP. CERAMIC 10P 0.5P 50V	D104	D5442X	DIODE, SILICON SWITCHING
C020	CE04W1E101M	CAP. ELECTRO 100 20% 25V	D105	D5442X	DIODE, SILICON SWITCHING
C021	CK45B2H103K	CAP. CERAMIC 0.01 10% 500V	D106	D5442X	DIODE, SILICON SWITCHING
C022	CE04W1E101M	CAP. ELECTRO 100 20% 25V	D107	D5442X	DIODE, SILICON SWITCHING
C023	CE04W1E101M	CAP. ELECTRO 100 20% 25V	D108	D5442X	DIODE, SILICON SWITCHING
C024	C90-0912-05	CAP. ELECTRO 220 20% 35V	D109	D5442X	DIODE, SILICON SWITCHING
C025	C90-0912-05	CAP. ELECTRO 220 20% 35V	D110	D5442X	DIODE, SILICON SWITCHING
C026	CK45F1H103Z	CAP. CERAMIC 0.01 50V	D111	D5442X	DIODE, SILICON SWITCHING
C027	CK45B2H472K	CAP. CERAMIC 4700P 10% 500V	D116	1S583	DIODE, SILICON SWITCHING
C028	CE04W2A3R3M	CAP. ELECTRO 3.3 20% 100V	D117	MT25.1JB	DIODE, ZENER 5V
C029	C91-0570-05	CAP. CERAMIC 4700P 3K	D118	D5442X	DIODE
C030	CK45E3F102P	CAP. CERAMIC 1000P 3.1K	D119	NO USE	
C031	CC45CH1H180J	CAP. CERAMIC 18P 5% 50V	D120	D5442X	DIODE
C101	C093FM1H103K	CAP. MYLAR 0.01 10% 50V	D121	D5442X	DIODE, SILICON SWITCHING
C102	C093FM1H103K	CAP. MYLAR 0.01 10% 50V	D122	NO USE	
C103	CK45F1H103Z	CAP. CERAMIC 0.01 50V	D123	1S583	DIODE, SILICON SWITCHING
C104	CK45F1H103Z	CAP. CERAMIC 0.01 50V	D124	D5442X	DIODE
C105	CC45CH1H221J	CAP. CERAMIC 220P 5% 50V	D125	D5442X	DIODE
C106	CE04W1H100M	CAP. ELECTRO 10 20% 50V	L001	L40-1011-13	FERRI INDUCTOR 1000UH
C107	NO USE		L002	L40-1011-13	FERRI INDUCTOR 1000UH
C108	C90-0298-05	CAP. CERAMIC 0.1 20% 12V	L003	L40-1021-03	FERRI INDUCTOR
C109	CK45B1H472K	CAP. CERAMIC 4700P 10% 50V	L004	L40-1021-13	FERRI INDUCTOR
C110	CK45F1H103Z	CAP. CERAMIC 0.01 50V	L005	L40-1021-13	FERRI INDUCTOR
C111	CC45CH1H101J	CAP. CERAMIC 100P 5% 50V	L006	L40-1021-13	FERRI INDUCTOR
C112	CK45F1H103Z	CAP. CERAMIC 0.01 50V	L007	L40-1021-13	FERRI INDUCTOR
C113	CC45CH1H101J	CAP. CERAMIC 100P 5% 50V	L008	L40-4791-02	FERRI INDUCTOR 4.7UH
C114	CE04B1H1010M	CAP. ELECTRO 1 20% 50V	L101	L40-1011-13	FERRI INDUCTOR 1000UH
C115	CE04W1A101M	CAP. ELECTRO 100 20% 10V	NL001	NE-2B	NEON LAMP
C116	CK45F1H103Z	CAP. CERAMIC 0.01 50V	NL002	NE-2B	NEON LAMP
C117	CK45F1H103Z	CAP. CERAMIC 0.01 50V	P001	E40-0274-05	PIN CONNECTOR 2 P
C118	CC45CH2H1000	CAP. CERAMIC 10P 0.5P 500V	P002	E40-0374-05	PIN CONNECTOR 3P
C119	CC45CH2H1000	CAP. CERAMIC 10P 0.5P 500V	P003	E40-0335-05	PIN CONNECTOR 3P
C120	CF93AN2A105J	CAP. POLYESTHEL 1 5% 100V	P004	E40-0535-05	PIN CONNECTOR 5P
C121	C093BP2A103F	CAP. MYLAR 0.01 1% 100V	P005	E40-0233-05	PIN CONNECTOR 2P
C122	CM93B02A900J	CAP. MICA 90P 5% 100V	F101	E40-1116-05	PIN CONNECTOR 11P
C123	C093FM1H102K	CAP. MYLAR 1000P 10% 50V	F102	E40-1116-05	PIN CONNECTOR 11P
C124	CK45F1H103Z	CAP. CERAMIC 0.01 50V	F103	E40-0273-05	PIN CONNECTOR 2 P
C125	CK45F1H103Z	CAP. CERAMIC 0.01 50V	Q001	2SC2912(S)	TR. SI, NPN
C126	CK45F1H103Z	CAP. CERAMIC 0.01 50V	Q002	2SA1210(S)	TR. SI, PNP
C127	NO USE		Q003	2SB613(E)	TR. SI, NPN
C128	CE04W1E470M	CAP. ELECTRO 47 20% 25V	Q004	2SC2785(F)	TR. SI, NPN
C129	CE04W1H010M	CAP. ELECTRO 1 20% 50V	Q005	2SC2271(D)	TR. SI, NPN
C130	NO USE		Q101	2SK117(Y)	FET. N-CHANNEL
C131	CK45F1H103Z	CAP. CERAMIC 0.01 50V	Q102	2SK117(Y)	FET. N-CHANNEL
C132	NO USE		Q103	2SC2785(F)	TR. SI, NPN
C133	CK45F1H103Z	CAP. CERAMIC 0.01 50V	Q104	2SC2785(F)	TR. SI, NPN
C134	CC45FCH1H470J	CAP. CERAMIC 47P 5% 50V	Q105	2SC2785(F)	TR. SI, NPN
C135	CC45CH2H030C	CAP. CERAMIC 3P 0.25P 500V	Q106	2SC2785(F)	TR. SI, NPN
C136	CM93B02A151J	CAP. MICA 150P 5% 100V	Q107	2SA1175(F)	TR. SI, PNP
C139	CC45CH2H020C	CAP. CERAMIC 2P 0.25P 500V	Q108	2SA1175(F)	TR. SI, PNP
C140	CK45F1H103Z	CAP. CERAMIC 0.01 50V	Q109	2SA1175(F)	TR. SI, PNP
C143	CK45F1H103Z	CAP. CERAMIC 0.01 50V	Q110	2SA1175(F)	TR. SI, PNP
C144	CK45F1H103Z	CAP. CERAMIC 0.01 50V	Q111	2SA1175(F)	TR. SI, PNP
C145	C90-0298-05	CAP. CERAMIC 0.1 20% 12V	Q112	2SA1175(F)	TR. SI, PNP
C146	CK45F1H103Z	CAP. CERAMIC 0.01 50V	Q113	2SC2785(F)	TR. SI, NPN
C147	CK45F1H103Z	CAP. CERAMIC 0.01 50V	Q114	2SC2785(F)	TR. SI, NPN
C148	CK45F1H103Z	CAP. CERAMIC 0.01 50V	Q115	2SK117(Y)	FET. N-CHANNEL
C149	CK45F1H103Z	CAP. CERAMIC 0.01 50V	Q116	2SC2785(F)	TR. SI, NPN
C150	CE04W1E101M	CAP. ELECTRO 100 20% 25V	Q117	2SC2785(F)	TR. SI, NPN
C151	CE04W1A221M	CAP. ELECTRO 220 20% 10V	Q118	2SC2785(F)	TR. SI, NPN
C152	CE04W1E101M	CAP. ELECTRO 100 20% 25V	Q119	2SC2785(F)	TR. SI, NPN
C153	CK45F1H103Z	CAP. CERAMIC 0.01 50V	Q120	2SC2785(F)	TR. SI, NPN
C154	CE04W2E4R7	CAP. ELECTRO 4.7 250V	Q121	2SA1175(F)	TR. SI, PNP
C155	CK45B2H472K	CAP. CERAMIC 4700P 10% 500V			
C156	NO USE				
C157	C093FM1H103K	CAP. MYLAR 0.01 10% 50V			
C158	CC45FCH1H150J	CAP. CERAMIC 15P 5% 50V			
C159	CE04W1E470M	CAP. ELECTRO 47 20% 25V			
C160	CE04W1E470M	CAP. ELECTRO 47 20% 25V			
C161	CE04W1E470M	CAP. ELECTRO 47 20% 25V			
C162	CK45F1H103Z	CAP. CERAMIC 0.01 50V			

PARTS LIST

REF.NO	PARTS NO	NAME & DESCRIPTION	REF.NO	PARTS NO	NAME & DESCRIPTION
Q122	2SA1175(F)	TR. SI, PNP	R153	RD14BB2E153J	RES. CARBON 15K 5% 1/4W
Q123	2SA1175(F)	TR. SI, PNP	R154	RD14BB2E133J	RES. CARBON 13K 5% 1/4W
Q124	2SC2912(S)	TR. SI, NPN	R155	RD14BB2C152J	RES. CARBON 1.5K 5% 1/6W
Q125	2SA1210(S)	TR. SI, PNP	R156	RN14BK2E1201F	RES. METAL FILM 1.2K 1% 1/4W
Q126	2SC2785(F)	TR. SI, NPN	R157	RN14BK2E1201F	RES. METAL FILM 1.2K 1% 1/4W
Q127	2SC2912(S)	TR. SI, NPN	R158	RN14BK2E6801F	RES. METAL FILM 6.8K 1% 1/4W
Q128	2SC2785(F)	TR. SI, NPN	R159	RN14BK2E9101F	RES. METAL FILM 9.1K 1% 1/4W
Q129	2SC2785(F)	TR. SI, NPN	R160	RN14BK2E3004F	RES. METAL FILM 3M 1% 1/4W
Q130	2SK117(Y)	FET. N-CHANNEL	R161	RN14BK2E1004F	RES. METAL FILM 1M 1% 1/4W
Q131	2SA1175(F)	TR. SI, PNP	R162	RN14BK2E5003F	RES. METAL FILM 500K 1% 1/4W
R001	RN14BK2E4701F	RES. METAL FILM 4.7K 1% 1/4W	R163	RN14BK2E3003F	RES. METAL FILM 300K 1% 1/4W
R002	RD14BB2E221J	RES. CARBON 220 5% 1/4W	R164	RN14BK2E1003F	RES. METAL FILM 100K 1% 1/4W
R003	RD14BB2E183J	RES. CARBON 18K 5% 1/4W	R165	RN14BK2E5002F	RES. METAL FILM 50K 1% 1/4W
R004	RD14BB2E104J	RES. CARBON 100K 5% 1/4W	R166	RN14BK2E3002F	RES. METAL FILM 30K 1% 1/4W
R005	RN14BK2E4702F	RES. METAL FILM 47K 1% 1/4W	R167	RN14BK2E2002F	RES. METAL FILM 20K 1% 1/4W
R006	RD14BB2E101J	RES. CARBON 100 5% 1/4W	R168	RD14BB2E472J	RES. CARBON 4.7K 5% 1/4W
R007	RN14BK2E2403F	RES. METAL FILM 240K 1% 1/4W	R169	RD14BB2E222J	RES. CARBON 2.2K 5% 1/4W
R008	RD14BB2E102J	RES. CARBON 1K 5% 1/4W	R170	RD14BB2E472J	RES. CARBON 4.7K 5% 1/4W
R009	RD14BB2E104J	RES. CARBON 100K 5% 1/4W	R171	RN14BK2E4701F	RES. METAL FILM 4.7K 1% 1/4W
R010	RD14BB2E332J	RES. CARBON 3.3K 5% 1/4W	R172	RD14BB2E472J	RES. CARBON 4.7K 5% 1/4W
R011	RD14BB2E221J	RES. CARBON 220 5% 1/4W	R173	RD14BB2E101J	RES. CARBON 100 5% 1/4W
R012	RD14BB2E103J	RES. CARBON 10K 5% 1/4W	R174	RD14BB2E391J	RES. CARBON 390 5% 1/4W
R013	R92-1033-05	RES. FIXED 33M	R175	RN14BK2E2201F	RES. METAL FILM 2.2K 1% 1/4W
R014	RD14BB2E334J	RES. CARBON 330K 5% 1/4W	R176	RN14BK2E2201F	RES. METAL FILM 2.2K 1% 1/4W
R015	R92-1034-05	RES. METAL FILM 47M	R177	RN14BK2E182J	RES. CARBON 1.8K 5% 1/4W
R016	R92-1026-05	RES. METAL FILM 3.3M	R178	RD14BB2E182J	RES. CARBON 1.8K 5% 1/4W
R017	R92-1032-05	RES. FIXED 22M	R179	RD14BB2E103J	RES. CARBON 10K 5% 1/4W
R018	RD14BB2E473J	RES. CARBON 47K 5% 1/4W	R180	RN14BK2E1202F	RES. METAL FILM 12K 1% 1/4W
R019	RD14BB2E393J	RES. CARBON 39K 5% 1/4W	R181	RD14BB2E822J	RES. CARBON 8.2K 5% 1/4W
R020	RD14BB2E333J	RES. CARBON 33K 5% 1/4W	R182	RD14BB2E103J	RES. CARBON 10K 5% 1/4W
R021	RD14BB2E473J	RES. CARBON 47K 5% 1/4W	R183	RD14BB2E124J	RES. CARBON 120K 5% 1/4W
R022	RD14BB2E103J	RES. CARBON 10K 5% 1/4W	R184	RD14BB2E621J	RES. CARBON 620 5% 1/4W
R023	RD14BB2E222J	RES. CARBON 2.2K 5% 1/4W	R185	RD14BB2E102J	RES. CARBON 1K 5% 1/4W
R024	RN14BK2E6800F	RES. METAL FILM 680 1% 1/4W	R186	RD14BB2E473J	RES. CARBON 47K 5% 1/4W
R025	RN14BK2E2402F	RES. METAL FILM 24K 1% 1/4W	R187	RD14BB2E203J	RES. CARBON 20K 5% 1/4W
R026	RN14BK2E1302F	RES. METAL FILM 13K 1% 1/4W	R188	RD14BB2E103J	RES. CARBON 10K 5% 1/4W
R027	RD14BB2E102J	RES. CARBON 1K 5% 1/4W	R189	RD14BB2E102J	RES. CARBON 1K 5% 1/4W
R028	RD14BB2E562J	RES. CARBON 5.6K 5% 1/4W	R190	RS14GB3D103J	RES. METAL FILM 10K 5% 2W
R029	RD14BB2E4R7J	RES. CARBON 4.7 5% 1/4W	R191	RD14BB2E124J	RES. CARBON 120K 5% 1/4W
R030	NO USE		R192	RD14BB2E103J	RES. CARBON 10K 5% 1/4W
R031	RD14BB2E470J	RES. CARBON 47 5% 1/4W	R195	RD14BB2E821J	RES. CARBON 820 5% 1/4W
R032	RD14BB2E224J	RES. CARBON 220K 5% 1/4W	R196	RD14BB2E821J	RES. CARBON 820 5% 1/4W
R033	RD14BB2E563J	RES. CARBON 56K 5% 1/4W	R197	NO USE	
R101	RN14BK2E1004F	RES. METAL FILM 1M 1% 1/4W	R198	RD14BB2E222J	RES. CARBON 2.2K 5% 1/4W
R102	RD14BB2E104J	RES. CARBON 100K 5% 1/4W	R199	RD14BB2E221J	RES. CARBON 220 5% 1/4W
R103	RD14BB2E153J	RES. CARBON 15K 5% 1/4W	R200	RN14BK2E1004F	RES. METAL FILM 1M 1% 1/4W
R104	RD14BB2E153J	RES. CARBON 15K 5% 1/4W	R201	RD14BB2E104J	RES. CARBON 100K 5% 1/4W
R105	RD14BB2E201J	RES. CARBON 200 5% 1/4W	R202	RD14BB2E153J	RES. CARBON 15K 5% 1/4W
R106	RD14BB2E302J	RES. CARBON 3K 5% 1/4W	R203	RD14BB2E472J	RES. CARBON 4.7K 5% 1/4W
R107	RN14BK2E3301F	RES. METAL FILM 3.3K 1% 1/4W	R204	RD14BB2E751J	RES. CARBON 750 5% 1/4W
R108	RN14BK2E3300F	RES. METAL FILM 330 1% 1/4W	R205	RD14BB2E102J	RES. CARBON 1K 5% 1/4W
R109	RN14BK2E3600F	RES. METAL FILM 360 1% 1/4W	R206	NO USE	
R110	RN14BK2E4701F	RES. METAL FILM 4.7K 1% 1/4W	R207	RN14BK2E9101F	RES. METAL FILM 9.1K 1% 1/4W
R111	RN14BK2E5101F	RES. METAL FILM 5.1K 1% 1/4W	R210	RD14BB2E101J	RES. CARBON 100 5% 1/4W
R112	RD14BB2E103J	RES. CARBON 10K 5% 1/4W	R211	RD14BB2E470J	RES. CARBON 47 5% 1/4W
R113	RD14BB2E183J	RES. CARBON 18K 5% 1/4W	R212	RD14BB2E101J	RES. CARBON 100 5% 1/4W
R114	RD14BB2E222J	RES. CARBON 2.2K 5% 1/4W	R213	RD14BB2E152J	RES. CARBON 1.5K 5% 1/4W
R115	RD14BB2E222J	RES. CARBON 2.2K 5% 1/4W	R214	RN14BK2E5101F	RES. METAL FILM 5.1K 1% 1/4W
R116	RD14BB2E222J	RES. CARBON 2.2K 5% 1/4W	R217	RD14BB2E562J	RES. CARBON 5.6K 5% 1/4W
R117	RD14BB2E472J	RES. CARBON 4.7K 5% 1/4W	R221	RD14BB2E133J	RES. CARBON 13K 5% 1/4W
R118	RD14BB2E105J	RES. CARBON 1M 5% 1/4W	R222	RD14BB2C102J	RES. CARBON 1K 5% 1/6W
R119	RD14BB2E622J	RES. CARBON 6.2K 5% 1/4W	R223	NO USE	
R120	RD14BB2E102J	RES. CARBON 1K 5% 1/4W	R224	RD14BB2E103J	RES. CARBON 10K 5% 1/4W
R121	RD14BB2E472J	RES. CARBON 4.7K 5% 1/4W	R227	RD14BB2C102J	RES. CARBON 1K 5% 1/6W
R122	RN14BK2E2701F	RES. METAL FILM 2.7K 1% 1/4W	R228	RD14BB2C133J	RES. CARBON 13K 5% 1/6W
R123	RN14BK2E3600F	RES. METAL FILM 360 1% 1/4W	S101	R01-3510-05	V.R. WITH SW. 10K B
R124	RN14BK2E3600F	RES. METAL FILM 360 1% 1/4W	S102	R01-3510-05	V.R. WITH SW. 10K B
R125	RD14BB2E102J	RES. CARBON 1K 5% 1/4W	S103	S02-2508-15	ROTARY SWITCH WITH VR.2K,10KB
R126	RN14BK2E1002F	RES. METAL FILM 10K 1% 1/4W	S104	S32-2012-05	LEVER SWITCH
R127	RN14BK2E2701F	RES. METAL FILM 2.7K 1% 1/4W	S105	S32-2012-05	LEVER SWITCH
R128	RD14BB2E102J	RES. CARBON 1K 5% 1/4W	S106	S32-4007-05	SLIDE SWITCH
R129	RD14BB2E561J	RES. CARBON 560 5% 1/4W	T001	L19-0413-05	CONVERTOR TRANSFORMER
R130	RD14BB2E182J	RES. CARBON 1.8K 5% 1/4W	TC101	C05-0422-05	CAP. TRIMMER 20P
R131	RD14BB2E681J	RES. CARBON 680 5% 1/4W	TC102	C05-0420-05	CAP. TRIMMER 6P
R132	RD14BB2E472J	RES. CARBON 4.7K 5% 1/4W	U001	NJM4558D	IC
R133	RD14BB2E222J	RES. CARBON 2.2K 5% 1/4W	U101	MC10103L	IC, QUAD 2-INPUT OR GATE
R134	RD14BB2E102J	RES. CARBON 1K 5% 1/4W	U102	SN74LS112N	IC
R135	RD14BB2E472J	RES. CARBON 4.7K 5% 1/4W	U103	SN74LS02N	IC, QUAD 2-INPUT NOR GATE
R136	RD14BB2E222J	RES. CARBON 2.2K 5% 1/4W	VR001	R12-5516-05	RES. SEMI FIXED 100K B
R137	RD14BB2E102J	RES. CARBON 1K 5% 1/4W	VR101	R01-3510-05	V.R. WITH SW. 10K B
R138	RD14BB2E102J	RES. CARBON 1K 5% 1/4W	VR102	R01-3510-05	V.R. WITH SW. 10K B
R139	RD14BB2E562J	RES. CARBON 5.6K 5% 1/4W	VR103	S02-2508-15	ROTARY SWITCH WITH VR.2K,10KB
R140	RD14BB2E221J	RES. CARBON 220 5% 1/4W	VR104	R12-3520-05	RES. SEMI FIXED 10K B
R141	RD14BB2E221J	RES. CARBON 220 5% 1/4W	VR105	R12-1518-05	RES. SEMI FIXED 2K B
R142	RD14BB2C220J	RES. CARBON 22 5% 1/6W	VR106	R12-0421-05	RES. SEMI FIXED 100 B
R143	RD14BB2E472J	RES. CARBON 4.7K 5% 1/4W			
R144	RD14BB2E103J	RES. CARBON 10K 5% 1/4W			
R145	RD14BB2E182J	RES. CARBON 1.8K 5% 1/4W			
R146	RD14BB2E472J	RES. CARBON 4.7K 5% 1/4W			
R147	RN14BK2E3302F	RES. METAL FILM 33K 1% 1/4W			
R148	RD14BB2E102J	RES. CARBON 1K 5% 1/4W			
R149	RN14BK2E3602F	RES. METAL FILM 36K 1% 1/4W			
R150	RS14GB3D183J	RES. METAL FILM 18K 5% 2W			
R151	RD14BB2E102J	RES. CARBON 1K 5% 1/4W			
R152	RD14BB2E153J	RES. CARBON 15K 5% 1/4W			

PARTS LIST

REF.NO	PARTS NO	NAME & DESCRIPTION
VR107	R12-1517-05	RES. SEMI FIXED 1K B
VR108	NO USE	
VR109	R12-5518-05	RES. SEMI FIXED 200K OHM B
VR110	R12-1517-05	RES. SEMI FIXED 1K B
VR111	R12-0540-05	RES. SEMI FIXED 500 B

REF.NO	PARTS NO	NAME & DESCRIPTION
P013	E40-0273-05	PIN CONNECTOR 2P
P014	E40-0273-05	PIN CONNECTOR 2P
P015	E40-0673-05	PIN CONNECTOR 6P
Q001	2SC1384	TR. SI, NPN
Q002	2SA684	TR. SI, PNP
R001	RD14BB2E331J	RES. CARBON 330 5% 1/4W
R005	RD14BB2E330J	RES. CARBON 33 5% 1/4W
R006	RN14BK2E1300F	RES. METAL FILM 130 1% 1/4W
R007	RN14BK2E4302F	RES. METAL FILM 43K 1% 1/4W
R008	RN14BK2E9102F	RES. METAL FILM 91K 1% 1/4W
R009	RN14BK2E1003F	RES. METAL FILM 100K 1% 1/4W
R010	RN14BK2E3601F	RES. METAL FILM 3.6K 1% 1/4W
R011	RD14BB2E392J	RES. CARBON 3.9K 5% 1/4W
R012	RD14BB2E222J	RES. CARBON 2.2K 5% 1/4W
R013	RD14BY2H100J	RES. CARBON 10 5% 1/2W
U001	NJM4558D	IC DUAL OP AMP.

CONNECTION UNIT

(X77-1260-00)

REF.NO	PARTS NO	NAME & DESCRIPTION
	E33-4037-00	WIRE ASSY
	J25-2995-03	PCB (UNMOUNTED)
	R92-0150-05	JUMPING RES. ZERO OHM
C001	C093M1H103J	CAP. MYLAR 0.01 5% 50V
C002	CK45B1H103K	CAP. CERAMIC 0.01 10% 50V
D001	DS442X	DIODE
D002	DS442X	DIODE
D003	S10B40	DIODE
J001	E31-2374-05	LEAD WIRE WITH CONNECTOR
P001	E40-7203-05	PIN CONNECTOR 3P
P002	E40-7204-05	PIN CONNECTOR 4P
P003	E40-0604-05	PIN CONNECTOR 6P
P004	E40-0804-05	PIN CONNECTOR 8P
P005	E40-0804-05	PIN CONNECTOR 8P
P006	E40-1111-05	PIN CONNECTOR 11P
P007	E40-1111-05	PIN CONNECTOR 11P
P008	E40-1111-05	PIN CONNECTOR 11P
P009	E40-1111-05	PIN CONNECTOR 11P
P010	E40-0273-05	PIN CONNECTOR 2 P
P011	E40-0373-05	PIN CONNECTOR 3 P
P012	E40-0273-05	PIN CONNECTOR 2 P
P013	E40-0273-05	PIN CONNECTOR 2 P
P014	E40-0273-05	PIN CONNECTOR 2 P
P015	E40-0673-05	PIN CONNECTOR 6 P
Q001	2SC1384	TR. SI, NPN
Q002	2SA684	TR. SI, PNP
R001	RD14BB2E331J	RES. CARBON 330 5% 1/4W
R002	RD14BB2E103J	RES. CARBON 10K 5% 1/4W
R003	RD14BB2E103J	RES. CARBON 10K 5% 1/4W
R004	RD14BB2E103J	RES. CARBON 10K 5% 1/4W
R005	RD14BB2E330J	RES. CARBON 33 5% 1/4W
R006	RN14BK2E1300F	RES. METAL FILM 130 1% 1/4W
R007	RN14BK2E4302F	RES. METAL FILM 43K 1% 1/4W
R008	RN14BK2E9102F	RES. METAL FILM 91K 1% 1/4W
R009	RN14BK2E1003F	RES. METAL FILM 100K 1% 1/4W
R010	RN14BK2E3601F	RES. METAL FILM 3.6K 1% 1/4W
R011	RD14BB2E392J	RES. CARBON 3.9K 5% 1/4W
R012	NO USE	
R013	RD14BY2H100J	RES. CARBON 10 5% 1/2W
R014	RD14BB2E222J	RES. CARBON 2.2K 5% 1/4W
R015	RD14BB2E101J	RES. CARBON 100 5% 1/4W
U001	NJM4558D	IC

CONNECTION UNIT

(X77-1260-02)

REF.NO	PARTS NO	NAME & DESCRIPTION
	E33-4037-00	WIRE ASSY
	J25-2995-03	PCB (UNMOUNTED)
	R92-0150-05	JUMPING RES. ZERO OHM
C001	C093M1H103J	CAP. MYLAR 0.01 5% 50V
C002	CK45B1H103K	CAP. CERAMIC 0.01 10% 50V
D001	DS442X	DIODE
D002	DS442X	DIODE
D003	S10B40	DIODE
J001	E31-2374-05	LEAD WIRE WITH CONNECTOR
P001	E40-7203-05	PIN CONNECTOR 3P
P002	E40-7204-05	PIN CONNECTOR 4P
P003	E40-0604-05	PIN CONNECTOR 6P
P004	E40-0804-05	PIN CONNECTOR 8P
P005	E40-0804-05	PIN CONNECTOR 8P
P006	E40-1111-05	PIN CONNECTOR 11P
P007	E40-1111-05	PIN CONNECTOR 11P
P008	E40-1111-05	PIN CONNECTOR 11P
P009	E40-1111-05	PIN CONNECTOR 11P
P010	E40-0273-05	PIN CONNECTOR 2 P
P011	E40-0373-05	PIN CONNECTOR 3 P
P012	E40-0273-05	PIN CONNECTOR 2 P
P013	E40-0273-05	PIN CONNECTOR 2 P
P014	E40-0273-05	PIN CONNECTOR 2 P
P015	E40-0673-05	PIN CONNECTOR 6 P
Q001	2SC1384	TR. SI, NPN
Q002	2SA684	TR. SI, PNP
R001	RD14BB2E331J	RES. CARBON 330 5% 1/4W
R002	RD14BB2E103J	RES. CARBON 10K 5% 1/4W
R003	RD14BB2E103J	RES. CARBON 10K 5% 1/4W
R004	RD14BB2E103J	RES. CARBON 10K 5% 1/4W
R005	RD14BB2E221J	RES. CARBON 220 5% 1/4W
R006	RN14BK2E1300F	RES. METAL FILM 130 1% 1/4W
R007	RN14BK2E4302F	RES. METAL FILM 43K 1% 1/4W
R008	RN14BK2E9102F	RES. METAL FILM 91K 1% 1/4W
R009	RN14BK2E1003F	RES. METAL FILM 100K 1% 1/4W
R010	RN14BK2E3601F	RES. METAL FILM 3.6K 1% 1/4W
R011	RD14BB2E392J	RES. CARBON 3.9K 5% 1/4W
R012	NO USE	
R013	RD14BY2H100J	RES. CARBON 10 5% 1/2W
R014	RD14BB2E222J	RES. CARBON 2.2K 5% 1/4W
R015	RD14BB2E101J	RES. CARBON 100 5% 1/4W
U001	NJM4558D	IC

CONNECTION UNIT

(X77-1260-01)

REF.NO	PARTS NO	NAME & DESCRIPTION
	E33-4037-00	WIRE ASSY
	J25-2995-03	PCB (UNMOUNTED)
	R92-0150-05	JUMPING RES. ZERO OHM
C001	C093M1H103J	CAP. MYLAR 0.01 5% 50V
C002	CK45B1H103K	CAP. CERAMIC 0.01 10% 50V
D001	DS442X	DIODE
D002	DS442X	DIODE
D003	S10B40	DIODE
D004	WZ-120	DIODE
J001	E31-2374-05	LEAD WIRE WITH CONNECTOR
P001	E40-0373-05	PIN CONNECTOR 3P
P001	E40-7203-05	PIN CONNECTOR 3P
P002	E40-7204-05	PIN CONNECTOR 4P
P003	E40-0604-05	PIN CONNECTOR 6P
P004	E40-0804-05	PIN CONNECTOR 8P
P005	E40-0804-05	PIN CONNECTOR 8P
P006	E40-1111-05	PIN CONNECTOR 11P
P007	E40-1111-05	PIN CONNECTOR 11P
P008	E40-1111-05	PIN CONNECTOR 11P
P009	E40-1111-05	PIN CONNECTOR 11P
P010	E40-0273-05	PIN CONNECTOR 2P
P011	NO USE	
P012	E40-0273-05	PIN CONNECTOR 2P

CONNECTION UNIT

(X77-1260-03)

REF.NO	PARTS NO	NAME & DESCRIPTION
	E33-4037-00	WIRE ASSY
	J25-2995-03	PCB (UNMOUNTED)
	R92-0150-05	JUMPING RES. ZERO OHM
C001	C093M1H103J	CAP. MYLAR 0.01 5% 50V
C002	CK45B1H103K	CAP. CERAMIC 0.01 10% 50V
D001	DS442X	DIODE
D002	DS442X	DIODE
D003	S10B40	DIODE
D004	WZ-120	DIODE
J001	E31-2374-05	LEAD WIRE WITH CONNECTOR

PARTS LIST

REF.NO	PARTS NO	NAME & DESCRIPTION
P001	E40-0373-05	PIN CONNECTOR 3P
P001	E40-7203-05	PIN CONNECTOR 3P
P002	E40-7204-05	PIN CONNECTOR 4P
P003	E40-0604-05	PIN CONNECTOR 6P
P004	E40-0804-05	PIN CONNECTOR 8P
P005	E40-0804-05	PIN CONNECTOR 8P
P006	E40-1111-05	PIN CONNECTOR 11P
P007	E40-1111-05	PIN CONNECTOR 11P
P008	E40-1111-05	PIN CONNECTOR 11P
P009	E40-1111-05	PIN CONNECTOR 11P
P010	E40-0273-05	PIN CONNECTOR 2P
P011		NO USE
P012	E40-0273-05	PIN CONNECTOR 2P
P013	E40-0273-05	PIN CONNECTOR 2P
P014	E40-0273-05	PIN CONNECTOR 2P
P015	E40-0673-05	PIN CONNECTOR 6P
Q001	2SC1384	TR. SI, NPN
Q002	2SA684	TR. SI, PNP
R001	RD14BB2E331J	RES. CARBON 330 5% 1/4W
R005	RD14BB2E221J	RES. CARBON 220 5% 1/4W
R006	RN14BK2E1300F	RES. METAL FILM 130 1% 1/4W
R007	RN14BK2E4302F	RES. METAL FILM 43K 1% 1/4W
R008	RN14BK2E9102F	RES. METAL FILM 91K 1% 1/4W
R009	RN14BK2E1003F	RES. METAL FILM 100K 1% 1/4W
R010	RN14BK2E3601F	RES. METAL FILM 3.6K 1% 1/4W
R011	RD14BB2E392J	RES. CARBON 3.9K 5% 1/4W
R012	RD14BB2E222J	RES. CARBON 2.2K 5% 1/4W
R013	RD14BY2H100J	RES. CARBON 10 5% 1/2W
U001	NJM4558D	IC DUAL OP AMP.

CRT SOCKET UNIT

(X81-1250-00)

REF.NO	PARTS NO	NAME & DESCRIPTION
	E01-0103-05	CRT SOCKET
	J25-2996-14	PCB (UNMOUNTED)
	R92-0150-05	JUMPING RES. ZERO OHM
J016	E31-2366-05	LEAD WIRE WITH CONNECTOR
J017	E31-2366-05	LEAD WIRE WITH CONNECTOR
J018		NO USE
J019	E31-2364-05	LEAD WIRE WITH CONNECTOR
J020		NO USE
J021	E31-2363-05	LEAD WIRE WITH CONNECTOR
J022		NO USE
J023	E31-2365-05	LEAD WIRE WITH CONNECTOR
L001	L40-2292-13	FIXED INDUCTOR 2.2UH
L002	L40-2292-13	FIXED INDUCTOR 2.2UH
R001	RD14BB2E151J	RES. CARBON 150 5% 1/4W
R002	RD14BB2E151J	RES. CARBON 150 5% 1/4W

CRT SOCKET UNIT

(X81-1250-01)

REF.NO	PARTS NO	NAME & DESCRIPTION
	E01-0103-05	CRT SOCKET
	J25-2996-14	PCB (UNMOUNTED)
C001	CC45CH2H010C	CAP. CERAMIC 1P 0.25P 500V
C002	CC45SL1H050C	CAP. CERAMIC 5P 0.25P 50V
J016	E31-2366-05	LEAD WIRE WITH CONNECTOR
J017	E31-2366-05	LEAD WIRE WITH CONNECTOR
J018		NO USE
J019	E31-2364-05	LEAD WIRE WITH CONNECTOR
J020		NO USE
J021	E31-2363-05	LEAD WIRE WITH CONNECTOR
J022		NO USE
J023	E31-2365-05	LEAD WIRE WITH CONNECTOR
L001	L40-2792-13	FIXED INDUCTOR 2.7UH
L002	L40-2792-13	FIXED INDUCTOR 2.7UH
R001	RD14BB2E681J	RES. CARBON 680 5% 1/4W
R002	RD14BB2E681J	RES. CARBON 680 5% 1/4W

CS-1021		Y70-1530-61	
REF.NO	PARTS NO	NAME & DESCRIPTION	
	A01-0897-22	CASE	
	A01-0898-12	CASE	
	A10-1444-02	CHASSIS	
	A20-2761-02	PANEL (MOLDED)	
	A21-1076-02	DECORATIVE PANEL	
	A22-0826-02	SUB PANEL	
	A22-0827-13	SUB PANEL	
	A23-1643-02	REAR PANEL	
	B07-0712-13	ESCUTCHEON FOR FILTER	
	B19-0726-04	FILTER	
	B30-0903-15	LED LAMP (RED)	
	B39-0407-04	SPACER	
	B40-2765-04	NAME PLATE (SERIAL NO)	
	B41-0774-03	CAUTION LABEL	
	B50-7570-00	INSTRUCTION MANUAL	
	E04-0251-05	BNC RECEPTACLE	
	E21-0657-04	TERMINAL (GND)	
	E21-0660-04	TERMINAL (CAL)	
	E23-0043-04	EARTH LUG	
	E23-0513-05	EARTH LUG	
	E23-0524-04	EARTH LUG	
	E23-0525-14	EARTH LUG	
	E30-1852-05	EARTH PLATE	
	E31-2370-05	POWER CORD ASS'Y (CEE)	
	E31-2384-15	LEAD WIRE WITH CONNECTOR	
	F05-5013-05	LEAD WIRE WITH CONNECTOR	
	F05-8015-05	FUSE 0.5A	
	F10-1565-04	FUSE 0.8A	
	F11-0995-03	SHIELDING PLATE	
	F15-0733-04	SHIELD CASE	
	G02-0607-04	FELT	
	G13-0716-04	SPRING FOR CRT	
	H01-5769-04	CUSHION	
	H10-2815-02	CARTON BOX	
	H10-2816-02	FOAMED STYRENE PAD	
	H20-1719-04	FOAMED STYRENE PAD	
	H25-0029-04	VINYL COVER	
	J02-0089-05	POLYETHYLENE BAG	
	J02-0510-14	RUBBER LEG	
	J10-0100-22	SUB LEG	
	J11-0046-05	BEZEL	
	J13-0033-15	CABLE CLAMP	
	J19-1634-04	FUSE HOLDER	
	J19-1635-04	HOLDER FOR LEAD	
	J21-2573-04	HOLDER FOR LED	
	J21-2970-23	HOLDER FOR LEG	
	J21-2973-14	BLACKET FOR CRT	
	J21-4512-04	AC VOLTAGE PLATE 220V	
	J31-0603-04	BLACKET FOR CRT	
	J42-0085-05	COLLAR	
	J42-0523-04	BUSHING (FOR AC CORD)	
	J61-0038-05	BUSHING	
	J61-0408-05	FREE UP BELT (FOR CABLE TIE)	
	J61-0515-05	WIRE WRAPPING BAND	
	J61-0516-05	SUPPORT (I TYPE)	
	K01-0518-05	SUPPORT (T TYPE)	
	K21-0851-03	HANDLE	
	K21-0853-23	KNOB	
	K21-0854-23	KNOB	
	K21-0855-14	KNOB	
	K21-0856-23	KNOB	
	K27-0526-04	KNOB FOR LEVER	
	K27-0528-04	KNOB FOR PUSH	
	L01-9344-15	POWER TRANSFORMER	
	L39-0518-05	ROTATOR COIL	
	N08-0611-04	DRESSED SCREW	
	N09-0715-04	SCREW, PAN HD M 4X31	
	N09-0716-05	SCREW M 4X10	
	N09-0717-05	SCREW, TRUSS HD M 3X12	
	N09-0720-05	SCREW, SEMS PAN HD	
	N10-2030-46	NUT, HEX	
	N10-2070-46	NUT, HEX	
	N15-1030-41	WASHER, FLAT FOR M3	
	N15-1040-41	WASHER	
	N17-1030-46	TOOTHED LOCK WASHER FOR M3	
	N30-3004-41	SCREW, PAN HD M 3X4	
	N30-3006-41	SCREW, PAN HD M 3X6	
	N30-3008-41	SCREW, PAN HD M 3X8	
	N88-3006-41	SCREW, FLAT HD TAP TITE	
	N89-3006-41	SCREW, BINDING TAP TITE	
	R05-3504-05	V.R. 10K B	
	R05-3505-05	V.R. 20K B	
	R05-8001-05	V.R. 3M B	
	S59-2503-05	SWITCH	
	W01-0503-04	CORD WRAP	
	X73-1490-04	AMPLIFIER UNIT	
	X73-1630-00	AMPLIFIER UNIT	
	X74-1340-04	SWEEP CIRCUIT UNIT	
	X75-1140-04	ATTENUATOR UNIT	
	X77-1261-61	CONNECTION UNIT	
	X81-1250-04	CRT SOCKET UNIT	
	Y87-1840-00	PROBE PC-20	
	150GTM31A	CRT	
	212-2014-05	TUBE (PLASTIC)	
	212-3017-05	TUBE (PLASTIC)	
R100	RD14BB2E431J	RES. CARBON 430 5% 1/4W	

PARTS LIST

VERTICAL ATTENUATOR UNIT

(X75-1140-04)

REF. NO	PARTS NO	NAME & DESCRIPTION
	A22-0828-03	SUB PANEL
	E04-0251-05	BNC RECEPTACLE
	E31-2367-15	LEAD WIRE WITH CONNECTOR
	F10-1564-04	SHIELD PLATE
	F10-1566-04	SHIELD PLATE
	J25-2997-13	PCB (UNMOUNTED)
	K21-0852-03	KNOB
	K21-0855-14	KNOB
	N30-3006-46	SCREW, PAN HD M 3X6
	N89-3006-41	SCREW, BINDING TAP TITE
	R92-0150-05	JUMPING RES. ZERO OHM
C001	C91-0501-05	CAP. METAL FILM 0.047 10% 630V
C002	CM93BD2A470J	CAP. MICA 47P 5% 100V
C003	CM93BD2A471J	CAP. MICA 470P 5% 100V
C004	C91-0502-05	CAP. METAL FILM 0.01 20% 630V
C005	NO USE	
C006	CC45CH1H0R5C	CAP. CERAMIC 0.5P 0.25P 50V
C009	CC45CH1H470J	CAP. CERAMIC 47P 5% 50V
C010	CK45B1H103K	CAP. CERAMIC 0.01 10% 50V
C011	CK45B1H103K	CAP. CERAMIC 0.01 10% 50V
C012	CK45B1H103K	CAP. CERAMIC 0.01 10% 50V
C013	CE04W1E470M	CAP. ELECTRO 47 20% 25V
C014	CE04W1E470M	CAP. ELECTRO 47 20% 25V
C015	CE04W1E470M	CAP. ELECTRO 47 20% 25V
C016	CE04W1E470M	CAP. ELECTRO 47 20% 25V
C017	NO USE	
C018	CC45CH1H010C	CAP. CERAMIC 1P 0.25P 50V
C019	CE04B1H010M	CAP. ELECTRO 1 20% 50V
C020	CK45B1H152K	CAP. CERAMIC 1500P 10% 50V
C023	CK45B1H103K	CAP. CERAMIC 0.01 10% 50V
D001	MTZ9.1JC	DIODE ZENER 9V
D002	MTZ9.1JC	DIODE ZENER 9V
Q001	2SK30A(D)	FET,N-CHANNEL
Q002	2SA1005(K)	TR. SI, PNP
Q003	2SA1005(K)	TR. SI, PNP
Q004	2SC2786(K)	TR. SI, NPN
Q005	2SC2786(K)	TR. SI, NPN
R001	RD14BB2E220J	RES. CARBON 22 5% 1/4W
R002	RD14BB2E105J	RES. CARBON 1M 5% 1/4W
R003	RD14BB2E220J	RES. CARBON 22 5% 1/4W
R004	RD14BB2E220J	RES. CARBON 22 5% 1/4W
R005	RN14BK2E9003F	RES. METAL FILM 900K 1% 1/4W
R006	RN14BK2E1113F	RES. METAL FILM 111K 1% 1/4W
R007	RD14BB2E820J	RES. CARBON 82 5% 1/4W
R008	RN14BK2E9903F	RES. METAL FILM 990K 1% 1/4W
R009	RN14BK2E1012F	RES. METAL FILM 10.1K 1% 1/4W
R010	RD14BB2E100J	RES. CARBON 10 5% 1/4W
R011	RN14BK2E1004F	RES. METAL FILM 1M 1% 1/4W
R012	RD14BB2E104J	RES. CARBON 100K 5% 1/4W
R013	RN14BK2E27R0F	RES. METAL FILM 27.0 1% 1/4W
R014	RD14BB2E101J	RES. CARBON 100 5% 1/4W
R015	RN14BK2E27R0F	RES. METAL FILM 27.0 1% 1/4W
R016	RD14BB2C101J	RES. CARBON 100 5% 1/6W
R017	NO USE	
R018	RD14BB2C101J	RES. CARBON 100 5% 1/6W
R019	RD14BB2E121J	RES. CARBON 120 5% 1/4W
R020	RD14BB2E473J	RES. CARBON 47K 5% 1/4W
R021	RD14BB2E474J	RES. CARBON 470K 5% 1/4W
R022	RD14BB2E220J	RES. CARBON 22 5% 1/4W
R023	RD14BB2E562J	RES. CARBON 5.6K 5% 1/4W
R024	RD14BB2E562J	RES. CARBON 5.6K 5% 1/4W
R025	RD14BB2E392J	RES. CARBON 3.9K 5% 1/4W
R026	RD14BB2E753J	RES. CARBON 75K 5% 1/4W
R027	RD14BB2E754J	RES. CARBON 750K 5% 1/4W
R028	RD14BB2E122J	RES. CARBON 1.2K 5% 1/4W
R029	RD14BB2C332J	RES. CARBON 3.3K 5% 1/6W
R030	RD14BB2E332J	RES. CARBON 3.3K 5% 1/4W
R031	RD14BB2E332J	RES. CARBON 3.3K 5% 1/4W
R032	NO USE	
R033	RN14BK2E9100F	RES. METAL FILM 910 1% 1/4W
R034	RN14BK2E1000F	RES. METAL FILM 100 1% 1/4W
R035	RD14BB2E220J	RES. CARBON 22 5% 1/4W
R036	RN14BK2E3000F	RES. METAL FILM 300 1% 1/4W
R037	RN14BK2E1800F	RES. METAL FILM 180 1% 1/4W
R038	RN14BK2E1200F	RES. METAL FILM 120 1% 1/4W
R039	RD14BB2E151J	RES. CARBON 150 5% 1/4W
R040	RD14BB2E560J	RES. CARBON 56 5% 1/4W
R041	RN14BK2E3000F	RES. METAL FILM 300 1% 1/4W
R042	RN14BK2E1800F	RES. METAL FILM 180 1% 1/4W
R043	RN14BK2E1200F	RES. METAL FILM 120 1% 1/4W
R044	RD14BB2E151J	RES. CARBON 150 5% 1/4W
R045	RD14BB2E560J	RES. CARBON 56 5% 1/4W
R046	RD14BB2E333J	RES. CARBON 33K 5% 1/4W
R047	RD14BB2E473J	RES. CARBON 47K 5% 1/4W
R048	RD14BB2E472J	RES. CARBON 4.7K 5% 1/4W
R049	RD14BB2C163J	RES. CARBON 16K 5% 1/6W
R050	NO USE	
R051	RD14BB2E361J	RES. CARBON 360 5% 1/4W

REF. NO	PARTS NO	NAME & DESCRIPTION
R052	RD14BB2C910J	RES. CARBON 91 5% 1/6W
R053	RD14BB2C111J	RES. CARBON 110 5% 1/6W
S001	S32-4007-05	LEVER SWITCH
S002	S02-3501-15	ROTARY SW. W/O.R500 B
TC001	C05-0427-05	CAP. TRIMMER 10P
TC002	C05-0428-05	CAP. TRIMMER 20P
TC003	C05-0427-05	CAP. TRIMMER 10P
TC004	C05-0428-05	CAP. TRIMMER 20P
TC005	C05-0427-05	CAP. TRIMMER 10P
U001	M47F(C)	FET
U002	NO USE	
U003	M47F(B)	FET
VR001	R12-3502-05	RES. SEMI FIXED 33K B
VR002	R12-3502-05	RES. SEMI FIXED 33K B
VR003	R12-3502-05	RES. SEMI FIXED 33K B
VR004	R12-3502-05	RES. SEMI FIXED 33K B

VERTICAL AMP & POWER UNIT

(X73-1490-04)

REF. NO	PARTS NO	NAME & DESCRIPTION
	E23-0526-04	EARTH PLATE
	E31-2584-05	LEAD WIRE WITH CONNECTOR
	E31-2585-05	LEAD WIRE WITH CONNECTOR
	E33-4031-00	WIRE ASSY
	F01-0836-04	HEAT SINK
	J25-2999-13	PCB (UNMOUNTED)
	N19-0191-05	WASHER NONMETAL
	N19-0702-04	WASHER
	N30-3008-46	SCREW, PAN HD M 3X8
	R92-0150-05	JUMPING RES. ZERO OHM
	T12-1018-05	TUBE (PLASTIC)
	T12-2014-05	TUBE (PLASTIC)
C002	CC45CH1H010C	CAP. CERAMIC 1P 0.25P 50V
C006	CC45CH1H151J	CAP. CERAMIC 150P 5% 50V
C007	CK45B1H103K	CAP. CERAMIC 0.01 10% 50V
C008	CE04W1E470M	CAP. ELECTRO 47 20% 25V
C009	CE04W1E470M	CAP. ELECTRO 47 20% 25V
C013	CC45CH1H470J	CAP. CERAMIC 47P 5% 50V
C014	CE04W1E220M	CAP. ELECTRO 22 20% 25V
C015	NO USE	
C016	CE04W1E220M	CAP. ELECTRO 22 20% 25V
C020	CC45CH1H1R5C	CAP. CERAMIC 1.5P 0.25P 50V
C102	CC45CH1H010C	CAP. CERAMIC 1P 0.25P 50V
C103	NO USE	
C104	CE04W1E470M	CAP. ELECTRO 47 20% 25V
C105	CE04W1E470M	CAP. ELECTRO 47 20% 25V
C106	CE04W1E470M	CAP. ELECTRO 47 20% 25V
C107	CE04W1E470M	CAP. ELECTRO 47 20% 25V
C108	NO USE	
C109	CC45CH1H470J	CAP. CERAMIC 47P 5% 50V
C110	CC45CH1H470J	CAP. CERAMIC 47P 5% 50V
C111	CE04B1H010M	CAP. ELECTRO 1 20% 50V
C112	CK45B1H103K	CAP. CERAMIC 0.01 10% 50V
C115	CC45CH1H020C	CAP. CERAMIC 2P 0.25P 50V
C301	CE04W1V222M	CAP. ELECTRO 2200 20% 35V
C302	CE04W1V222M	CAP. ELECTRO 2200 20% 35V
C303	CE04W1E222M	CAP. ELECTRO 2200 20% 25V
C304	C90-0910-05	CAP. ELECTRO 100 20% 200V
C305	CE04W2E470	CAP. ELECTRO 47 250V
C306	CE04W1A101M	CAP. ELECTRO 100 20% 10V
C307	CE04W1E101M	CAP. ELECTRO 100 20% 25V
C308	CE04W1E101M	CAP. ELECTRO 100 20% 25V
C309	CE04W2C100	CAP. ELECTRO 10 160V
C310	CE04W2E010	CAP. ELECTRO 1 250V
C311	CE04B1H010M	CAP. ELECTRO 1 20% 50V
C312	CE04W1H010M	CAP. ELECTRO 1 20% 50V
C313	CK45B1H103K	CAP. CERAMIC 0.01 10% 50V
C314	CE04W1H010M	CAP. ELECTRO 1 20% 50V
C315	CK45B1H103K	CAP. CERAMIC 0.01 10% 50V
C316	CE04W1H010M	CAP. ELECTRO 1 20% 50V
C317	CK45B1H103K	CAP. CERAMIC 0.01 10% 50V
C318	CK45B1H102K	CAP. CERAMIC 1000P 10% 50V
C319	CK45B1H102K	CAP. CERAMIC 1000P 10% 50V
C320	CK45B2H103K	CAP. CERAMIC 0.01 10% 500V
D001	D5442X	DIODE
D101	D5442X	DIODE
D102	D5442X	DIODE
D103	D5442X	DIODE
D104	D5442X	DIODE
D105	D5442X	DIODE
D106	D5442X	DIODE

PARTS LIST

REF.NO	PARTS NO	NAME & DESCRIPTION	REF.NO	PARTS NO	NAME & DESCRIPTION
D107	D5442X	DIODE	R051	RD14BB2E101J	RES. CARBON 100 5% 1/4W
D108	MTZ10JC	DIODE, ZENER 10V	R052	RD14BB2E220J	RES. CARBON 22 5% 1/4W
D301	S2VB40F	DIODE, BRIDGE	R053	RD14BB2E220J	RES. CARBON 22 5% 1/4W
D302	S2VB40F	DIODE, BRIDGE	R054	RD14BB2E331J	RES. CARBON 330 5% 1/4W
D303	S1VB60	DIODE	R055	RD14BB2E331J	RES. CARBON 330 5% 1/4W
D304	S1VB60	DIODE	R056	RD14BB2E750J	RES. CARBON 75 5% 1/4W
D305	D5442X	DIODE	R065	RD14BB2E201J	RES. CARBON 200 5% 1/4W
D306	D5442X	DIODE	R066	RD14BB2E471J	RES. CARBON 470 5% 1/4W
D307	V06B	DIODE	R067	RD14BB2E272J	RES. CARBON 2.7K 5% 1/4W
F001	E40-0473-05	PIN CONNECTOR 4 P	R068	RD14BB2E104J	RES. CARBON 100K 5% 1/4W
F002	E40-0273-05	PIN CONNECTOR 2 P	R069	RD14BB2E223J	RES. CARBON 22K 5% 1/4W
F101	E40-0473-05	PIN CONNECTOR 4 P	R101	RD14BB2E105J	RES. CARBON 1M 5% 1/4W
P301	E40-0930-05	PIN CONNECTOR 9P	R102	RD14BB2E220J	RES. CARBON 22 5% 1/4W
P302	E40-1116-05	PIN CONNECTOR 11 P	R103	RD14BB2E562J	RES. CARBON 5.6K 5% 1/4W
P303	E40-1116-05	PIN CONNECTOR 11 P	R104	RD14BB2E562J	RES. CARBON 5.6K 5% 1/4W
Q002	2SA1005(K)	TR. SI, PNP	R105	RD14BB2E120J	RES. CARBON 12 5% 1/4W
Q003	2SA1005(K)	TR. SI, PNP	R106	RD14BB2E510J	RES. CARBON 51 5% 1/4W
Q004	2SC2786(K)	TR. SI, NPN	R107	RD14BB2E510J	RES. CARBON 51 5% 1/4W
Q005	2SC2786(K)	TR. SI, NPN	R108	RD14BB2E392J	RES. CARBON 3.9K 5% 1/4W
Q009	2SC2786(K)	TR. SI, NPN	R109	RD14BB2E102J	RES. CARBON 1K 5% 1/4W
Q010	2SC2786(K)	TR. SI, NPN	R110	RD14BB2E302J	RES. CARBON 3K 5% 1/4W
Q011	2SC2786(K)	TR. SI, NPN	R111	RD14BB2E220J	RES. CARBON 22 5% 1/4W
Q012	2SC2786(K)	TR. SI, NPN	R112	RD14BB2E243J	RES. CARBON 24K 5% 1/4W
Q013	2SC2786(K)	TR. SI, NPN	R113	RD14BB2E302J	RES. CARBON 3K 5% 1/4W
Q014	2SC2786(K)	TR. SI, NPN	R114	RN14BK2E1000F	RES. METAL FILM 100 1% 1/4W
Q015	2SC2407	TR. SI, NPN	R115	RD14BB2E104J	RES. CARBON 100K 5% 1/4W
Q016	2SC2407	TR. SI, NPN	R116	RN14BK2E1401F	RES. METAL FILM 1.4K 1% 1/4W
Q102	2SA1005(K)	TR. SI, PNP	R117	RD14BB2E220J	RES. CARBON 22 5% 1/4W
Q103	2SA1005(K)	TR. SI, PNP	R118	RD14BB2E182J	RES. CARBON 1.8K 5% 1/4W
Q104	2SC2786(K)	TR. SI, NPN	R119	RD14BB2E223J	RES. CARBON 22K 5% 1/4W
Q105	2SC2786(K)	TR. SI, NPN	R120	RD14BB2E220J	RES. CARBON 22 5% 1/4W
Q106	2SC2785(F)	TR. SI, NPN	R121	RD14BB2E561J	RES. CARBON 560 5% 1/4W
Q107	2SC2786(K)	TR. SI, NPN	R122	NO USE	
Q108	2SC2786(K)	TR. SI, NPN	R123	RD14BB2E333J	RES. CARBON 33K 5% 1/4W
Q109	2SC2786(K)	TR. SI, NPN	R124	RD14BB2E151J	RES. CARBON 150 5% 1/4W
Q110	2SC2786(K)	TR. SI, NPN	R125	RD14BB2E101J	RES. CARBON 100 5% 1/4W
Q111	2SC2786(K)	TR. SI, NPN	R126	RD14BB2E101J	RES. CARBON 100 5% 1/4W
Q112	2SC2786(K)	TR. SI, NPN	R127	RD14BB2E222J	RES. CARBON 2.2K 5% 1/4W
Q113	2SA1175(F)	TR. SI, PNP	R128	RD14BB2E222J	RES. CARBON 2.2K 5% 1/4W
Q114	2SC2785(F)	TR. SI, NPN	R129	RN14BK2E2201F	RES. METAL FILM 2.2K 1% 1/4W
Q115	2SC2786(K)	TR. SI, NPN	R130	RN14BK2E2201F	RES. METAL FILM 2.2K 1% 1/4W
Q301	2SA1009(L,K)	TR. SI, PNP	R131	RD14BB2E750J	RES. CARBON 75 5% 1/4W
Q302	2SA1009(L,K)	TR. SI, PNP	R132	RN14BK2E2001F	RES. METAL FILM 2K 1% 1/4W
Q303	2SA1175(F)	TR. SI, PNP	R133	RN14BK2E2001F	RES. METAL FILM 2K 1% 1/4W
Q304	2SA1175(F)	TR. SI, PNP	R134	RD14BB2E510J	RES. CARBON 51 5% 1/4W
Q305	2SC2271(E)	TR. SI, NPN	R135	RD14BB2E511J	RES. CARBON 510 5% 1/4W
Q306	2SC2271(E)	TR. SI, NPN	R136	RD14BB2E123J	RES. CARBON 12K 5% 1/4W
R001	RD14BB2E105J	RES. CARBON 1M 5% 1/4W	R137	RD14BB2E472J	RES. CARBON 4.7K 5% 1/4W
R002	RD14BB2E220J	RES. CARBON 22 5% 1/4W	R138	RD14BB2E332J	RES. CARBON 3.3K 5% 1/4W
R003	RD14BB2E562J	RES. CARBON 5.6K 5% 1/4W	R139	RD14BB2E332J	RES. CARBON 3.3K 5% 1/4W
R004	RD14BB2E562J	RES. CARBON 5.6K 5% 1/4W	R140	RD14BB2E471J	RES. CARBON 470 5% 1/4W
R005	RD14BB2E120J	RES. CARBON 12 5% 1/4W	R141	RD14BB2E471J	RES. CARBON 470 5% 1/4W
R006	RD14BB2E510J	RES. CARBON 51 5% 1/4W	R142	RD14BB2E471J	RES. CARBON 470 5% 1/4W
R007	RD14BB2E510J	RES. CARBON 51 5% 1/4W	R143	RD14BB2E471J	RES. CARBON 470 5% 1/4W
R008	RD14BB2E392J	RES. CARBON 3.9K 5% 1/4W	R144	RD14BB2E272J	RES. CARBON 2.7K 5% 1/4W
R009	RD14BB2E102J	RES. CARBON 1K 5% 1/4W	R145	RD14BB2E153J	RES. CARBON 15K 5% 1/4W
R010	RD14BB2E302J	RES. CARBON 3K 5% 1/4W	R146	RD14BB2E153J	RES. CARBON 15K 5% 1/4W
R011	RD14BB2E220J	RES. CARBON 22 5% 1/4W	R147	RD14BB2E272J	RES. CARBON 2.7K 5% 1/4W
R012	RD14BB2E243J	RES. CARBON 24K 5% 1/4W	R148	RD14BB2E223J	RES. CARBON 22K 5% 1/4W
R013	RD14BB2E302J	RES. CARBON 3K 5% 1/4W	R149	RD14BB2E682J	RES. CARBON 6.8K 5% 1/4W
R014	RN14BK2E1000F	RES. METAL FILM 100 1% 1/4W	R150	RD14BB2E102J	RES. CARBON 1K 5% 1/4W
R015	RN14BK2E1401F	RES. METAL FILM 1.4K 1% 1/4W	R151	RD14BB2E102J	RES. CARBON 1K 5% 1/4W
R016	RD14BB2E220J	RES. CARBON 22 5% 1/4W	R152	RD14BB2E151J	RES. CARBON 150 5% 1/4W
R017	RD14BB2E302J	RES. CARBON 3K 5% 1/4W	R153	RD14BB2E101J	RES. CARBON 100 5% 1/4W
R018	RD14BB2E104J	RES. CARBON 100K 5% 1/4W	R154	NO USE	
R019	RD14BB2E220J	RES. CARBON 22 5% 1/4W	R155	RD14BB2E470J	RES. CARBON 47 5% 1/4W
R020	NO USE		R156	NO USE	
R021	RD14BB2E331J	RES. CARBON 330 5% 1/4W	R157	RD14BB2E331J	RES. CARBON 330 5% 1/4W
R031	RD14BB2E151J	RES. CARBON 150 5% 1/4W	R158	RD14BB2E104J	RES. CARBON 100K 5% 1/4W
R032	RD14BB2E101J	RES. CARBON 100 5% 1/4W	R159	RD14BB2E682J	RES. CARBON 6.8K 5% 1/4W
R033	RD14BB2E101J	RES. CARBON 100 5% 1/4W	R301	RD14BB2E473J	RES. CARBON 47K 5% 1/4W
R034	RD14BB2E222J	RES. CARBON 2.2K 5% 1/4W	R302	RD14BB2E102J	RES. CARBON 1K 5% 1/4W
R035	RD14BB2E222J	RES. CARBON 2.2K 5% 1/4W	R303	RD14BB2E3R3J	RES. CARBON 3.3 5% 1/4W
R036	RN14BK2E2201F	RES. METAL FILM 2.2K 1% 1/4W	R304	RD14BB2E100J	RES. CARBON 10 5% 1/4W
R037	RN14BK2E2201F	RES. METAL FILM 2.2K 1% 1/4W	R305	RD14BB2E562J	RES. CARBON 5.6K 5% 1/4W
R038	RD14BB2E750J	RES. CARBON 75 5% 1/4W	R306	RD14BB2E622J	RES. CARBON 6.2K 5% 1/4W
R039	RD14BB2E431J	RES. CARBON 430 5% 1/4W	R307	RD14BB2E222J	RES. CARBON 2.2K 5% 1/4W
R040	RD14BB2E682J	RES. CARBON 6.8K 5% 1/4W	R308	RD14BB2E222J	RES. CARBON 2.2K 5% 1/4W
R041	RD14BB2E332J	RES. CARBON 3.3K 5% 1/4W	R309	RN14BK2E1502F	RES. METAL FILM 15K 1% 1/4W
R042	RD14BB2E471J	RES. CARBON 470 5% 1/4W	R310	RN14BK2E1003F	RES. METAL FILM 100K 1% 1/4W
R043	RD14BB2E471J	RES. CARBON 470 5% 1/4W	R311	RN14BK2E1602F	RES. METAL FILM 16K 1% 1/4W
R044	RN14BK2E8200F	RES. METAL FILM 820 1% 1/4W	R312	RN14BK2E1503F	RES. METAL FILM 150K 1% 1/4W
R045	RN14BK2E8200F	RES. METAL FILM 820 1% 1/4W	R313	RD14BY2H104J	RES. CARBON 100K 5% 1/2W
R046	RN14BK2E8200F	RES. METAL FILM 820 1% 1/4W	R314	RD14BY2H104J	RES. CARBON 100K 5% 1/2W
R047	RN14BK2E8200F	RES. METAL FILM 820 1% 1/4W	S101	S42-4509-05	PUSH SWITCH
R048	RD14BB2E101J	RES. CARBON 100 5% 1/4W	TC001	C05-0425-05	CAP. TRIMMER 70P
R049	RD14BB2E302J	RES. CARBON 3K 5% 1/4W	TC002	C05-0425-05	CAP. TRIMMER 70P
R050	RD14BB2E302J	RES. CARBON 3K 5% 1/4W	TC101	C05-0434-05	CAP. TRIMMER 20P
			TC102	C05-0434-05	CAP. TRIMMER 20P
			TF001	E23-0046-04	TERMINAL
			TF002	E23-0046-04	TERMINAL

PARTS LIST

REF.NO	PARTS NO	NAME & DESCRIPTION	REF.NO	PARTS NO	NAME & DESCRIPTION
TP003	E23-0046-04	TERMINAL	C113	CC45CH1H101J	CAP. CERAMIC 100P 5% 50V
TP004	E23-0046-04	TERMINAL	C114	CE04W1H010M	CAP. ELECTRO 1 20% 50V
TP101	E23-0046-04	TERMINAL	C115	CE04W1A101M	CAP. ELECTRO 100 20% 10V
TP102	E23-0046-04	TERMINAL	C116	CK45F1H103Z	CAP. CERAMIC 0.01 50V
TP103	E23-0046-04	TERMINAL	C117	CK45F1H103Z	CAP. CERAMIC 0.01 50V
TP104	E23-0046-04	TERMINAL	C118	CC45CH2H1000	CAP. CERAMIC 10P 0.5P 500V
U001	M47F(B)	FET	C119	CC45CH2H1000	CAP. CERAMIC 10P 0.5P 500V
U101	M47F(B)	FET	C120	CF93AN2A105J	CAP. POLYESTHEL 1 5% 100V
U301	UPC7805H	IC	C121	CQ93BP2A103F	CAP. MYLAR 0.01 1% 100V
U302	UPC7915HA	IC	C122	CM93BD2A900J	CAP. MICA 90P 5% 100V
U303	NJM7815A	IC	C123	CQ93FM1H102K	CAP. MYLAR 1000P 10% 50V
U304	NJM4558D	IC	C124	CK45F1H103Z	CAP. CERAMIC 0.01 50V
VR001	R05-3509-05	V.R. 20K B	C125	CK45F1H103Z	CAP. CERAMIC 0.01 50V
VR002	NO USE		C126	CK45F1H103Z	CAP. CERAMIC 0.01 50V
VR003	R12-0539-05	RES. SEMI FIXED 200 B	C127	NO USE	
VR004	R12-0421-05	RES. SEMI FIXED 100 B	C128	CE04W1E470M	CAP. ELECTRO 47 20% 25V
VR005	R12-0421-05	RES. SEMI FIXED 100 B	C129	CE04W1H010M	CAP. ELECTRO 1 20% 50V
VR006	R12-0421-05	RES. SEMI FIXED 100 B	C130	NO USE	
VR101	R05-3509-05	V.R. 20K B	C131	CK45F1H103Z	CAP. CERAMIC 0.01 50V
VR102	R12-3523-05	RES. SEMI FIXED 20K B	C132	NO USE	
VR103	R12-0541-05	RES. SEMI FIXED 100 B	C133	CK45F1H103Z	CAP. CERAMIC 0.01 50V
VR104	R12-0543-05	RES. SEMI FIXED 500 B	C134	CC45FCH1H470J	CAP. CERAMIC 47P 5% 50V
			C135	CC45CH2H030C	CAP. CERAMIC 3P 0.25P 500V
			C136	CM93BD2A151J	CAP. MICA 150P 5% 100V

HORIZONTAL & HIGH VOLTAGE UNIT

(X74-1340-04)

REF.NO	PARTS NO	NAME & DESCRIPTION	REF.NO	PARTS NO	NAME & DESCRIPTION
	E23-0015-04	EARTH LUG	C139	CC45CH2H020C	CAP. CERAMIC 2P 0.25P 500V
	E23-0046-04	TERMINAL	C140	CK45F1H103Z	CAP. CERAMIC 0.01 50V
	E31-2170-05	JUMPING WIRE	C141	CK45FB1H102K	CAP. CERAMIC 1000P 10% 50V
	E33-4028-00	WIRE ASSY	C142	CC45CH1H221J	CAP. CERAMIC 220P 5% 50V
	F01-0230-04	HEAT SINK	C143	CK45F1H103Z	CAP. CERAMIC 0.01 50V
	F01-0820-04	HEAT SINK	C144	CK45F1H103Z	CAP. CERAMIC 0.01 50V
	F01-0835-05	HEAT SINK	C145	C90-0298-05	CAP. CERAMIC 0.1 20% 12V
	F15-0727-04	HOLDER (NEON TUBE)	C146	CK45F1H103Z	CAP. CERAMIC 0.01 50V
	F20-0622-05	INSULATOR	C147	CK45F1H103Z	CAP. CERAMIC 0.01 50V
	J25-2998-13	PCB (UNMOUNTED)	C148	CK45F1H103Z	CAP. CERAMIC 0.01 50V
	J31-0604-04	COLLAR	C149	CK45F1H103Z	CAP. CERAMIC 0.01 50V
	N19-0191-05	WASHER NONMETAL	C150	CE04W1E101M	CAP. ELECTRO 100 20% 25V
	N30-3008-46	SCREW, PAN HD M 3X8	C151	CE04W1A221M	CAP. ELECTRO 220 20% 10V
	R92-0150-05	JUMPING RES. ZERO OHM	C152	CE04W1E101M	CAP. ELECTRO 100 20% 25V
	002-0001-05	BRAIDED WIRE	C153	CK45F1H103Z	CAP. CERAMIC 0.01 50V
	212-1018-05	TUBE (PLASTIC)	C154	CE04W2E4R7	CAP. ELECTRO 4.7 250V
	212-3013-05	TUBE (PLASTIC)	C155	CK45B2H472K	CAP. CERAMIC 4700P 10% 500V
C001	CC45CH1H330J	CAP. CERAMIC 33P 5% 50V	C156	CC45FCH1H150J	CAP. CERAMIC 15P 5% 50V
C002	CC45CH2H010C	CAP. CERAMIC 1P 0.25% 500V	C159	CE04W1E470M	CAP. ELECTRO 47 20% 25V
C003	CK45B2H472K	CAP. CERAMIC 4700P 10% 500V	C160	CE04W1E470M	CAP. ELECTRO 47 20% 25V
C004	CE04W1H100M	CAP. ELECTRO 10 20% 50V	C161	CE04W1E470M	CAP. ELECTRO 47 20% 25V
C005	CE04W2E100	CAP. ELECTRO 10 250V	C162	CK45F1H103Z	CAP. CERAMIC 0.01 50V
C006	CQ93FM1H104K	CAP. MYLAR 0.1 10% 50V	C163	CC45FCH1H100D	CAP. CERAMIC 10P 0.5P 50V
C007	CQ93FM1H153K	CAP. MYLAR 0.015 10% 50V	C164	CK45F1H103Z	CAP. CERAMIC 0.01 50V
C008	CE04W1V471M	CAP. ELECTRO 470 20% 35V	C165	CC45CH1H151J	CAP. CERAMIC 150P 5% 50V
C009	CQ93FM1H104K	CAP. MYLAR 0.1 10% 50V	C166	NO USE	
C010	CQ93FM1H223K	CAP. MYLAR 0.022 10% 50V	C167	CC45CH1H221J	CAP. CERAMIC 220P 5% 50V
C011	CK45B2H102K	CAP. CERAMIC 1000P 10% 500V	C168	CE04W1E101M	CAP. ELECTRO 100 20% 25V
C012	CK45E3F332P	CAP. CERAMIC 3300P 3.1K	C173	C90-0298-05	CAP. CERAMIC 0.1 20% 12V
C013	CK45E3F332P	CAP. CERAMIC 3300P 3.1K	C174	C90-0298-05	CAP. CERAMIC 0.1 20% 12V
C014	NO USE		C175	NO USE	
C015	CE04W2E010	CAP. ELECTRO 1 250V	C176	CK45B1H152K	CAP. CERAMIC 1500P 10% 50V
C016	CE04W2E4R7	CAP. ELECTRO 4.7 250V	0001	DS442X	DIODE, SILICON SWITCHING
C017	CK45B2H472K	CAP. CERAMIC 4700P 10% 500V	0002	DS442X	DIODE, SILICON SWITCHING
C018	CE04W1E470M	CAP. ELECTRO 47 20% 25V	0003	W02-0409-05	HIGH VOLTAGE POWER BLOCK
C019	CC45FCH1H1000	CAP. CERAMIC 10P 0.5P 50V	0004	W06C	DIODE
C020	CE04W1E101M	CAP. ELECTRO 100 20% 25V	0005	W06C	DIODE
C021	CK45B2H103K	CAP. CERAMIC 0.01 10% 500V	0006	1SS83	DIODE
C022	CE04W1E101M	CAP. ELECTRO 100 20% 25V	0007	1SS83	DIODE
C023	CE04W1E101M	CAP. ELECTRO 100 20% 25V	0008	DS442X	DIODE, SILICON SWITCHING
C024	C90-0912-05	CAP. ELECTRO 220 20% 35V	0009	DS442X	DIODE, SILICON SWITCHING
C025	C90-0912-05	CAP. ELECTRO 220 20% 35V	0101	DS442X	DIODE, SILICON SWITCHING
C026	CK45F1H103Z	CAP. CERAMIC 0.01 50V	0102	NO USE	
C027	CK45B2H472K	CAP. CERAMIC 4700P 10% 500V	0103	DS442X	DIODE, SILICON SWITCHING
C028	CE04W2A3R3M	CAP. ELECTRO 3.3 20% 100V	0104	DS442X	DIODE, SILICON SWITCHING
C029	C91-0570-05	CAP. CERAMIC 4700P 3KV	0105	DS442X	DIODE, SILICON SWITCHING
C030	CK45E3F102P	CAP. CERAMIC 1000P 3.1K	0106	DS442X	DIODE, SILICON SWITCHING
C031	CC45CH1H180J	CAP. CERAMIC 18P 5% 50V	0107	DS442X	DIODE, SILICON SWITCHING
C101	CQ93FM1H103K	CAP. MYLAR 0.01 10% 50V	0108	DS442X	DIODE, SILICON SWITCHING
C102	CQ93FM1H103K	CAP. MYLAR 0.01 10% 50V	0109	DS442X	DIODE, SILICON SWITCHING
C103	CK45F1H103Z	CAP. CERAMIC 0.01 50V	0110	DS442X	DIODE, SILICON SWITCHING
C104	CK45F1H103Z	CAP. CERAMIC 0.01 50V	0111	DS442X	DIODE, SILICON SWITCHING
C105	CC45CH1H221J	CAP. CERAMIC 220P 5% 50V	0112	DS442X	DIODE
C106	CE04W1H100M	CAP. ELECTRO 10 20% 50V	0113	DS442X	DIODE
C107	NO USE		0114	NO USE	
C108	C90-0298-05	CAP. CERAMIC 0.1 20% 12V	0115	DS442X	DIODE
C109	CK45B1H472K	CAP. CERAMIC 4700P 10% 50V	0116	1SS83	DIODE
C110	CK45F1H103Z	CAP. CERAMIC 0.01 50V	0117	MTZ5.1JB	DIODE ZENER 5V
C111	CC45CH1H101J	CAP. CERAMIC 100P 5% 50V	0121	DS442X	DIODE, SILICON SWITCHING
C112	CK45F1H103Z	CAP. CERAMIC 0.01 50V	0122	NO USE	
			0123	1SS83	DIODE
			0124	DS442X	DIODE
			0125	DS442X	DIODE
			L001	L40-1011-13	FERRI INDUCTOR 100UH
			L002	L40-1011-13	FERRI INDUCTOR 100UH
			L003	L40-1021-03	FERRI INDUCTOR 1MH
			L004	L40-1021-13	FERRI INDUCTOR 1MH

PARTS LIST

REF.NO	PARTS NO	NAME & DESCRIPTION	REF.NO	PARTS NO	NAME & DESCRIPTION
L005	L40-1021-13	FERRI INDUCTOR 1MH	R107	RN14BK2E3301F	RES. METAL FILM 3.3K 1% 1/4W
L006	L40-1021-13	FERRI INDUCTOR 1MH	R108	RN14BK2E3300F	RES. METAL FILM 330 1% 1/4W
L007	L40-1021-13	FERRI INDUCTOR 1MH	R109	RN14BK2E3600F	RES. METAL FILM 360 1% 1/4W
L008	L40-4791-02	FERRI INDUCTOR 4.7UH	R110	RN14BK2E4701F	RES. METAL FILM 4.7K 1% 1/4W
L101	L40-1011-13	FERRI INDUCTOR 100UH	R111	RN14BK2E5101F	RES. METAL FILM 5.1K 1% 1/4W
NL001	NE-2B	NEON LAMP	R112	RD14BB2E103J	RES. CARBON 10K 5% 1/4W
NL002	NE-2B	NEON LAMP	R113	RD14BB2E183J	RES. CARBON 18K 5% 1/4W
P001	E40-0274-05	PIN CONNECTOR 2 P	R114	RD14BB2E222J	RES. CARBON 2.2K 5% 1/4W
P002	E40-0374-05	PIN CONNECTOR 3 P	R115	RD14BB2E222J	RES. CARBON 2.2K 5% 1/4W
P003	E40-0335-05	PIN CONNECTOR 3 P	R116	RD14BB2E222J	RES. CARBON 2.2K 5% 1/4W
P004	E40-0535-05	PIN CONNECTOR 5 P	R117	RD14BB2E472J	RES. CARBON 4.7K 5% 1/4W
P005	E40-0233-05	PIN CONNECTOR 2 P	R118	RD14BB2E105J	RES. CARBON 1M 5% 1/4W
F101	E40-1116-05	PIN CONNECTOR 11 P	R119	RD14BB2E622J	RES. CARBON 6.2K 5% 1/4W
F102	E40-1116-05	PIN CONNECTOR 11 P	R120	RD14BB2E102J	RES. CARBON 1K 5% 1/4W
F103	E40-0273-05	PIN CONNECTOR 2 P	R121	RD14BB2E472J	RES. CARBON 4.7K 5% 1/4W
Q001	2SC2912(S)	TR. SI, NPN	R122	RN14BK2E2701F	RES. METAL FILM 2.7K 1% 1/4W
Q002	2SA1210(S)	TR. SI, PNP	R123	RN14BK2E3600F	RES. METAL FILM 360 1% 1/4W
Q003	2SD613(E)	TR. SI, NPN	R124	RN14BK2E3600F	RES. METAL FILM 360 1% 1/4W
Q004	2SC2785(F)	TR. SI, NPN	R125	RD14BB2E102J	RES. CARBON 1K 5% 1/4W
Q005	2SC2271(D)	TR. SI, NPN	R126	RN14BK2E1002F	RES. METAL FILM 10K 1% 1/4W
Q101	2SK117(Y)	FET	R127	RN14BK2E2701F	RES. METAL FILM 2.7K 1% 1/4W
Q102	2SK117(Y)	FET	R128	RD14BB2E102J	RES. CARBON 1K 5% 1/4W
Q103	2SC2785(F)	TR. SI, NPN	R129	RD14BB2E561J	RES. CARBON 560 5% 1/4W
Q104	2SC2785(F)	TR. SI, NPN	R130	RD14BB2E182J	RES. CARBON 1.8K 5% 1/4W
Q105	2SC2785(F)	TR. SI, NPN	R131	RD14BB2E681J	RES. CARBON 680 5% 1/4W
Q106	2SC2785(F)	TR. SI, NPN	R132	RD14BB2E472J	RES. CARBON 4.7K 5% 1/4W
Q107	2SA1175(F)	TR. SI, PNP	R133	RD14BB2E222J	RES. CARBON 2.2K 5% 1/4W
Q108	2SA1175(F)	TR. SI, PNP	R134	RD14BB2E102J	RES. CARBON 1K 5% 1/4W
Q109	2SA838(C)	TR. SI, PNP	R135	RD14BB2E472J	RES. CARBON 4.7K 5% 1/4W
Q110	2SA838(C)	TR. SI, PNP	R136	RD14BB2E222J	RES. CARBON 2.2K 5% 1/4W
Q111	2SA1175(F)	TR. SI, PNP	R137	RD14BB2E102J	RES. CARBON 1K 5% 1/4W
Q112	2SA1175(F)	TR. SI, PNP	R138	RD14BB2E102J	RES. CARBON 1K 5% 1/4W
Q113	2SC2785(F)	TR. SI, NPN	R139	RD14BB2E562J	RES. CARBON 5.6K 5% 1/4W
Q114	2SC2785(F)	TR. SI, NPN	R140	RD14BB2E221J	RES. CARBON 220 5% 1/4W
Q115	2SK117(Y)	FET	R141	RD14BB2E221J	RES. CARBON 220 5% 1/4W
Q116	2SC2785(F)	TR. SI, NPN	R142	RD14BB2E220J	RES. CARBON 22 5% 1/4W
Q117	2SC2785(F)	TR. SI, NPN	R143	RD14BB2E472J	RES. CARBON 4.7K 5% 1/4W
Q118	2SC2785(F)	TR. SI, NPN	R144	RD14BB2E103J	RES. CARBON 10K 5% 1/4W
Q119	2SC2785(F)	TR. SI, NPN	R145	RD14BB2E182J	RES. CARBON 1.8K 5% 1/4W
Q120	2SC2785(F)	TR. SI, NPN	R146	RD14BB2E472J	RES. CARBON 4.7K 5% 1/4W
Q121	2SA1175(F)	TR. SI, PNP	R147	RN14BK2E3302F	RES. METAL FILM 33K 1% 1/4W
Q122	2SA1175(F)	TR. SI, PNP	R148	RD14BB2E102J	RES. CARBON 1K 5% 1/4W
Q123	2SA1175(F)	TR. SI, PNP	R149	RN14BK2E3602F	RES. METAL FILM 36K 1% 1/4W
Q124	2SC2912(S)	TR. SI, NPN	R150	RS14GB3D183J	RES. METAL FILM 18K 5% 2W
Q125	2SA1210(S)	TR. SI, PNP	R151	RD14BB2E102J	RES. CARBON 1K 5% 1/4W
Q126	2SC2785(F)	TR. SI, NPN	R152	RD14BB2E153J	RES. CARBON 15K 5% 1/4W
Q127	2SC2912(S)	TR. SI, NPN	R153	RD14BB2E153J	RES. CARBON 15K 5% 1/4W
Q128	2SC2785(F)	TR. SI, NPN	R154	RD14BB2E133J	RES. CARBON 13K 5% 1/4W
Q129	2SC2785(F)	TR. SI, NPN	R155	RD14BB2C132J	RES. CARBON 1.3K 5% 1/6W
R001	RN14BK2E4701F	RES. METAL FILM 4.7K 1% 1/4W	R156	RN14BK2E1201F	RES. METAL FILM 1.2K 1% 1/4W
R002	RD14BB2E221J	RES. CARBON 220 5% 1/4W	R157	RN14BK2E1201F	RES. METAL FILM 1.2K 1% 1/4W
R003	RD14BB2E183J	RES. CARBON 18K 5% 1/4W	R158	RN14BK2E4301F	RES. METAL FILM 4.3K 1% 1/4W
R004	RD14BB2E104J	RES. CARBON 100K 5% 1/4W	R159	RN14BK2E9101F	RES. METAL FILM 9.1K 1% 1/4W
R005	RN14BK2E4702F	RES. METAL FILM 47K 1% 1/4W	R160	RN14BK2E3004F	RES. METAL FILM 3M 1% 1/4W
R006	RD14BB2E101J	RES. CARBON 100 5% 1/4W	R161	RN14BK2E1004F	RES. METAL FILM 1M 1% 1/4W
R007	RN14BK2E2403F	RES. METAL FILM 240K 1% 1/4W	R162	RN14BK2E5003F	RES. METAL FILM 500K 1% 1/4W
R008	RD14BB2E102J	RES. CARBON 1K 5% 1/4W	R163	RN14BK2E3003F	RES. METAL FILM 300K 1% 1/4W
R009	RD14BB2E104J	RES. CARBON 100K 5% 1/4W	R164	RN14BK2E1003F	RES. METAL FILM 100K 1% 1/4W
R010	RD14BB2E332J	RES. CARBON 3.3K 5% 1/4W	R165	RN14BK2E5002F	RES. METAL FILM 50K 1% 1/4W
R011	RD14BB2E221J	RES. CARBON 220 5% 1/4W	R166	RN14BK2E3002F	RES. METAL FILM 30K 1% 1/4W
R012	RD14BB2E103J	RES. CARBON 10K 5% 1/4W	R167	RN14BK2E2002F	RES. METAL FILM 20K 1% 1/4W
R013	R92-1033-05	RES. FIXED 33M 5% 1/4W	R168	RD14BB2E472J	RES. CARBON 4.7K 5% 1/4W
R014	RD14BB2E334J	RES. CARBON 330K 5% 1/4W	R169	RD14BB2E222J	RES. CARBON 2.2K 5% 1/4W
R015	R92-1034-05	RES. METAL FILM 47M 5% 1/2W	R170	RD14BB2E472J	RES. CARBON 4.7K 5% 1/4W
R016	R92-1036-05	RES. METAL FILM 3.3M	R171	RN14BK2E4701F	RES. METAL FILM 4.7K 1% 1/4W
R017	R92-1032-05	RES. FIXED 22M	R172	RD14BB2E472J	RES. CARBON 4.7K 5% 1/4W
R018	RD14BB2E473J	RES. CARBON 47K 5% 1/4W	R173	RD14BB2E101J	RES. CARBON 100 5% 1/4W
R019	RD14BB2E333J	RES. CARBON 33K 5% 1/4W	R174	RD14BB2E391J	RES. CARBON 390 5% 1/4W
R020	RD14BB2E333J	RES. CARBON 33K 5% 1/4W	R175	RN14BK2E2201F	RES. METAL FILM 2.2K 1% 1/4W
R021	RD14BB2E473J	RES. CARBON 47K 5% 1/4W	R176	RN14BK2E2201F	RES. METAL FILM 2.2K 1% 1/4W
R022	RD14BB2E103J	RES. CARBON 10K 5% 1/4W	R177	RD14BB2E182J	RES. CARBON 1.8K 5% 1/4W
R023	RD14BB2E222J	RES. CARBON 2.2K 5% 1/4W	R178	RD14BB2E182J	RES. CARBON 1.8K 5% 1/4W
R024	RN14BK2E6800F	RES. METAL FILM 680 1% 1/4W	R179	RD14BB2E103J	RES. CARBON 10K 5% 1/4W
R025	RN14BK2E2402F	RES. METAL FILM 24K 1% 1/4W	R180	RN14BK2E1202F	RES. METAL FILM 12K 1% 1/4W
R026	RN14BK2E1302F	RES. METAL FILM 13K 1% 1/4W	R181	RD14BB2E822J	RES. CARBON 8.2K 5% 1/4W
R027	RD14BB2E102J	RES. CARBON 1K 5% 1/4W	R182	RD14BB2E103J	RES. CARBON 10K 5% 1/4W
R028	RD14BB2E562J	RES. CARBON 5.6K 5% 1/4W	R183	RD14BB2E124J	RES. CARBON 120K 5% 1/4W
R029	RD14BB2E472J	RES. CARBON 4.7 5% 1/4W	R184	RD14BB2E621J	RES. CARBON 620 5% 1/4W
R030	NO USE		R185	RD14BB2E102J	RES. CARBON 1K 5% 1/4W
R031	RD14BB2E470J	RES. CARBON 47 5% 1/4W	R186	RD14BB2E473J	RES. CARBON 47K 5% 1/4W
R032	RD14BB2E224J	RES. CARBON 220K 5% 1/4W	R187	RD14BB2E203J	RES. CARBON 20K 5% 1/4W
R033	RD14BB2E563J	RES. CARBON 56K 5% 1/4W	R188	RD14BB2E103J	RES. CARBON 10K 5% 1/4W
R101	RN14BK2E1004F	RES. METAL FILM 1M 1% 1/4W	R189	RD14BB2E102J	RES. CARBON 1K 5% 1/4W
R102	RD14BB2E104J	RES. CARBON 100K 5% 1/4W	R190	RS14GB3D103J	RES. METAL FILM 10K 5% 2W
R103	RD14BB2E153J	RES. CARBON 15K 5% 1/4W	R191	RD14BB2E124J	RES. CARBON 120K 5% 1/4W
R104	RD14BB2E153J	RES. CARBON 15K 5% 1/4W	R192	RD14BB2E103J	RES. CARBON 10K 5% 1/4W
R105	RD14BB2E201J	RES. CARBON 200 5% 1/4W	R193	RD14BB2E122J	RES. CARBON 1.2K 5% 1/4W
R106	RD14BB2E302J	RES. CARBON 3K 5% 1/4W	R194	RD14BB2E122J	RES. CARBON 1.2K 5% 1/4W
			R195	RD14BB2E821J	RES. CARBON 820 5% 1/4W
			R196	RD14BB2E821J	RES. CARBON 820 5% 1/4W
			R197	NO USE	
			R198	RD14BB2E222J	RES. CARBON 2.2K 5% 1/4W
			R199	RD14BB2E221J	RES. CARBON 220 5% 1/4W
R205	RD14BB2E102J	RES. CARBON 1K 5% 1/4W			
R206	NO USE				
R207	RN14BK2E9101F	RES. METAL FILM 9.1K 1% 1/4W			

PARTS LIST

REF. NO	PARTS NO	NAME & DESCRIPTION			
R210	RD14882E101J	RES. CARBON	100	5%	1/4W
R211	RD14882E470J	RES. CARBON	47	5%	1/4W
R212	RD14882E101J	RES. CARBON	100	5%	1/4W
R213	RD14882E152J	RES. CARBON	1.5K	5%	1/4W
R214	RN148K2E5101F	RES. METAL FILM	5.1K	1%	1/4W
R217	RD14882E562J	RES. CARBON	5.6K	5%	1/4W
R221	RD14882E133J	RES. CARBON	13K	5%	1/4W
R222	RD14882C102J	RES. CARBON	1K	5%	1/6W
R223	RD14882E103J	RES. CARBON	10K	5%	1/4W
R224	NO USE				
R225	RD14882E222J	RES. CARBON	2.2K	5%	1/4W
R226	NO USE				
R227	RD14882C102J	RES. CARBON	1K	5%	1/6W
R228	RD14882C133J	RES. CARBON	13K	5%	1/6W
S103	S02-2507-15	ROTARY SW. W/V.R2K B			
S104	S33-2501-05	LEVER SWITCH			
S105	S32-2012-05	LEVER SWITCH			
S106	S32-4007-05	LEVER SWITCH			
T001	L19-0413-05	CONVERTOR TRANSFORMER			
TC101	C05-0422-05	CAP. TRIMMER	20P		
TC102	C05-0420-05	CAP. TRIMMER	6P		
U001	NJM4558D	IC			
U101	MC10103L	IC, QUAD 2-INPUT OR GATE			
U102	SN74LS112N	IC			
U103	SN74LS02N	IC			
U104	SN74LS00N	IC			
U105	SN74LS08N	IC			
VR001	R12-5516-05	RES. SEMI FIXED 100K B			
VR101	R01-3510-05	V.R. WITH SW. 10K B			
VR102	R01-3510-05	V.R. WITH SW. 10K B			
VR103	S02-2507-15	ROTARY SW. W/V.R2K B			
VR104	R12-3520-05	RES. SEMI FIXED 10K B			
VR105	R12-1518-05	RES. SEMI FIXED 2K B			
VR106	R12-0421-05	RES. SEMI FIXED 100 B			
VR107	R12-1517-05	RES. SEMI FIXED 1K B			
VR108	NO USE				
VR109	R12-5518-05	RES. SEMI FIXED 200K B			
VR110	NO USE				
VR111	R12-0540-05	RES. SEMI FIXED 500 B			

V. FINAL AMP UNIT

(X73-1630-00)

REF. NO	PARTS NO	NAME & DESCRIPTION			
	F01-0821-04	HEAT SINK			
	F02-0514-04	HEAT SINK			
	J21-2950-04	BRACKET FOR P.C.B			
	J21-2951-04	BRACKET FOR P.C.B			
	J25-5097-04	PCB (UNMOUNTED)			
	J32-0780-04	BOSS			
	J61-0516-05	SUPPORT (T TYPE)			
	N09-0709-05	SCREW			
	N30-3004-46	SCREW, PAN HD	M 3X4		
	N30-3006-46	SCREW, PAN HD	M 3X6		
	N30-3008-46	SCREW, PAN HD	M 3X8		
	R92-0150-05	JUMPING RES.	ZERO OHM		
C001	CK45B1H472K	CAP. CERAMIC	4700P	10%	500V
C002	CE04W2C3R3	CAP. ELECTRO	3.3		160V
C003	CK45B1H103K	CAP. CERAMIC	0.01	10%	50V
C004	CE04W1E101M	CAP. ELECTRO	100	20%	25V
C005	CK45B1H472K	CAP. CERAMIC	4700P	10%	50V
C006	CK45B1H472K	CAP. CERAMIC	4700P	10%	50V
C007	CK45B1H472K	CAP. CERAMIC	4700P	10%	50V
C008	CK45B1H472K	CAP. CERAMIC	4700P	10%	50V
D001	D5442X	DIODE			
D002	D5442X	DIODE			
D003	D5442X	DIODE			
D004	D5442X	DIODE			
P001	E40-0202-05	PIN CONNECTOR	2 P		
P002	E40-0202-05	PIN CONNECTOR	2 P		
P003	E40-0274-05	PIN CONNECTOR	3 P		
P004	E40-0274-05	PIN CONNECTOR	2 P		
Q001	2SC2912(R,S)	TR. SI, NPN			
Q002	2SC2912(R,S)	TR. SI, NPN			
Q003	2SA1210(S)	TR. SI, PNP			
Q004	2SC2912(R,S)	TR. SI, NPN			
Q005	2SA1210(S)	TR. SI, PNP			
Q006	2SC2912(R,S)	TR. SI, NPN			
R001	RD14882E101J	RES. CARBON	100	5%	1/4W
R002	RD14882E101J	RES. CARBON	100	5%	1/4W
R003	R92-1130-05	RES. FIXED	2.4K		3W
R004	R92-1130-05	RES. FIXED	2.4K		3W
R005	RD14882E470J	RES. CARBON	47	5%	1/4W
R006	RD14882E470J	RES. CARBON	47	5%	1/4W
R007	RD14882E470J	RES. CARBON	47	5%	1/4W
R008	RD14882E470J	RES. CARBON	47	5%	1/4W
R009	RD14882E150J	RES. CARBON	15	5%	1/4W
R010	RD14882E150J	RES. CARBON	15	5%	1/4W
R011	RD14882E150J	RES. CARBON	15	5%	1/4W
R012	RD14882E150J	RES. CARBON	15	5%	1/4W

CONNECTION UNIT

(X77-1261-61)

REF. NO	PARTS NO	NAME & DESCRIPTION			
	E33-4037-00	WIRE ASSY			
	J25-2995-03	PCB (UNMOUNTED)			
	R92-0150-05	JUMPING RES.	ZERO OHM		
C001	C093M1H103J	CAP. MYLAR	0.01	5%	50V
C002	CK45B1H103K	CAP. CERAMIC	0.01	10%	50V
D001	D5442X	DIODE			
D002	D5442X	DIODE			
P001	E40-7203-05	PIN CONNECTOR	3 P		
P002	E40-7204-05	PIN CONNECTOR	4 P		
P003	E40-0604-05	PIN CONNECTOR	6 P		
P004	E40-0804-05	PIN CONNECTOR	8 P		
P005	E40-0804-05	PIN CONNECTOR	8 P		
P006	E40-1111-05	PIN CONNECTOR	11P		
P007	E40-1111-05	PIN CONNECTOR	11P		
P008	E40-1111-05	PIN CONNECTOR	11P		
P009	E40-1111-05	PIN CONNECTOR	11P		
P010	E40-0273-05	PIN CONNECTOR	2 P		
P013	E40-0273-05	PIN CONNECTOR	2 P		
P014	E40-0273-05	PIN CONNECTOR	2 P		
P015	E40-0673-05	PIN CONNECTOR	6 P		
Q001	2SC1384	TR. SI, NPN			
Q002	2SA684	TR. SI, PNP			
R001	RD14882E331J	RES. CARBON	330	5%	1/4W
R002	RD14882E103J	RES. CARBON	10K	5%	1/4W
R003	RD14882E103J	RES. CARBON	10K	5%	1/4W
R004	RD14882E103J	RES. CARBON	10K	5%	1/4W
R005	RD14882E221J	RES. CARBON	220	5%	1/4W
R006	RN148K2E1300F	RES. METAL FILM	130	1%	1/4W
R007	RN148K2E4302F	RES. METAL FILM	43K	1%	1/4W
R008	RN148K2E9102F	RES. METAL FILM	91K	1%	1/4W

PARTS LIST

REF.NO	PARTS NO	NAME & DESCRIPTION
R009	RN14BK2E1003F	RES. METAL FILM 100K 1% 1/4W
R010	RN14BK2E3601F	RES. METAL FILM 3.6K 1% 1/4W
R011	RD14BB2E392J	RES. CARBON 3.9K 5% 1/4W
R014	RD14BB2E222J	RES. CARBON 2.2K 5% 1/4W
R015	RD14BB2E101J	RES. CARBON 100 5% 1/4W
U001	NJM4558D	IC

CRT SOCKET UNIT

(X81-1250-04)

REF.NO	PARTS NO	NAME & DESCRIPTION
	E01-0103-05	CRT SOCKET
	J25-2996-24	PCB (UNMOUNTED)
	R92-0150-05	JUMPING RES. ZERO OHM
C001	CC45CH2H010C	CAP. CERAMIC 1P 0.25% 500V
C002	CC45SL1H050C	CAP. CERAMIC 5P 0.25P 50V
J016	E31-2390-15	LEAD WIRE WITH CONNECTOR
J017	E31-2390-15	LEAD WIRE WITH CONNECTOR
J018	NO USE	
J019	E31-2364-05	LEAD WIRE WITH CONNECTOR
J020	NO USE	
J021	E31-2363-05	LEAD WIRE WITH CONNECTOR
J022	NO USE	
J023	E31-2365-05	LEAD WIRE WITH CONNECTOR

SEMICONDUCTORS

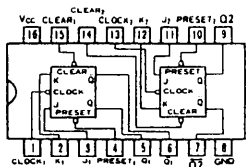

SN74LS112N

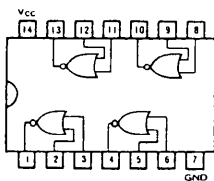

LS74LS02N

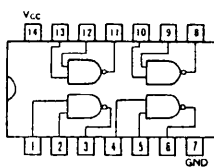

SN74LS00N

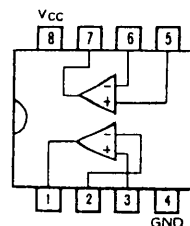

NJM4558D

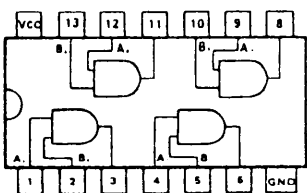

SN74LS08N

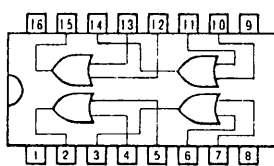

MC10103L

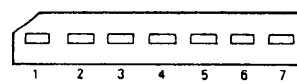

M47F(B)
M47F(C)

Bottom View

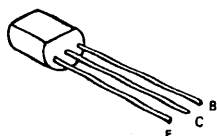

2SA684
2SA838 (C)
2SA1005 (K)

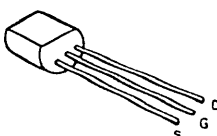

2SK30A (O)

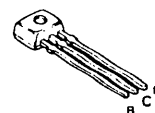

2SA1175 (F)
2SC2785 (F)
2SC2786 (K)

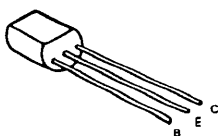

2SC2407

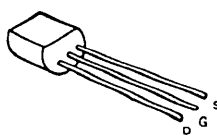

2SK117 (Y)

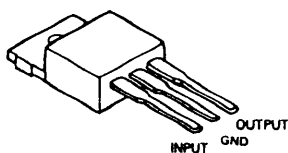

μPC7805H
NJM7815

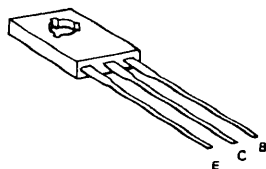

2SA1210 (R or S)
2SC2912 (R or S)

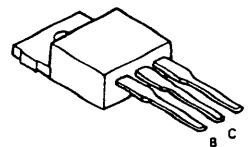

2SA1009 (L, K)
2SD613E

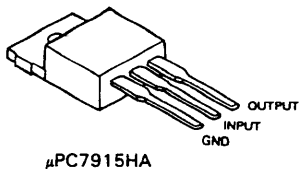

μPC7915HA

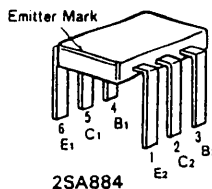

2SA884

DISASSEMBLY

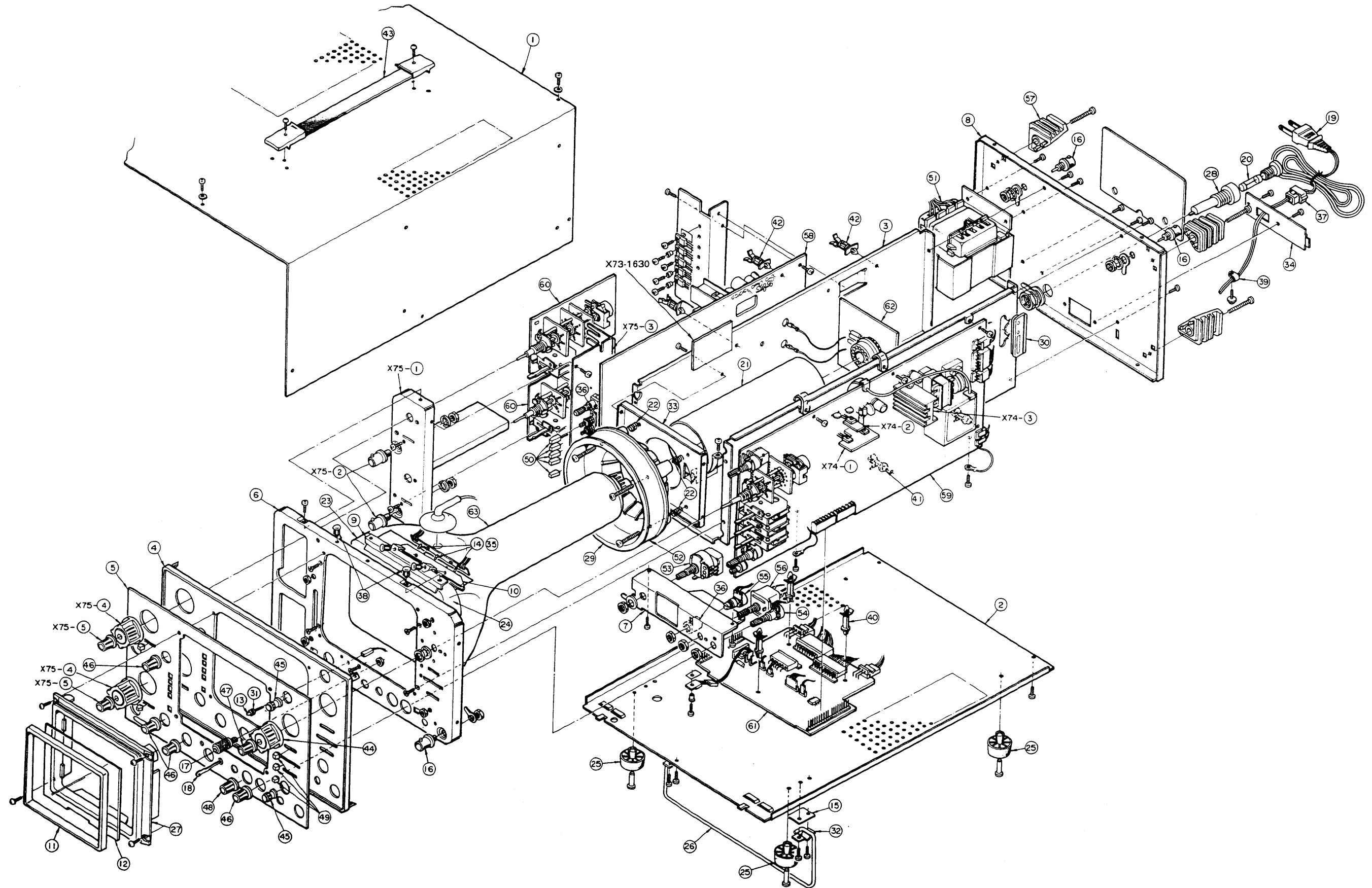

P.C. BOARD

VERTICAL ATTENUATOR UNIT (X75-1140-00)

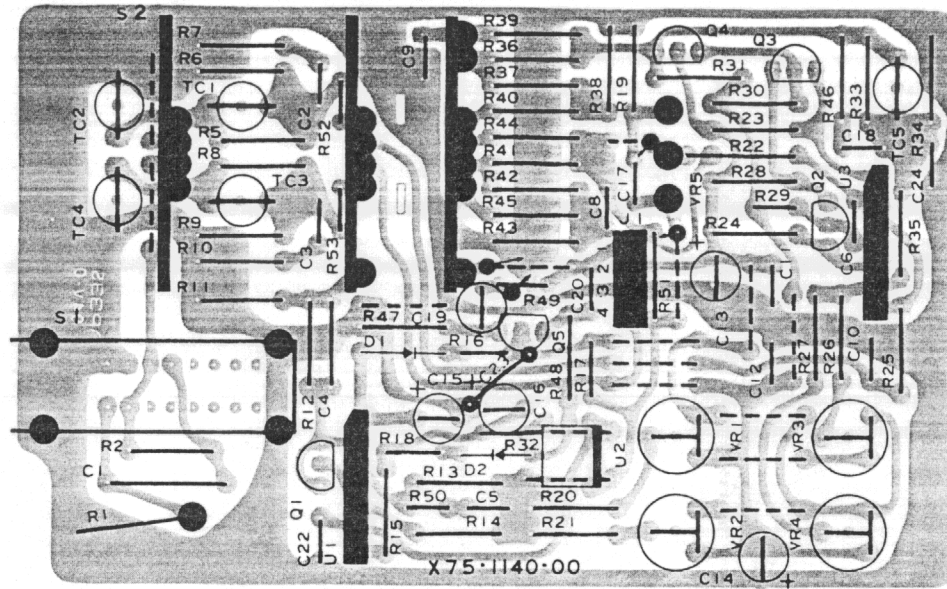

CONNECTION UNIT (X77-1260-00)

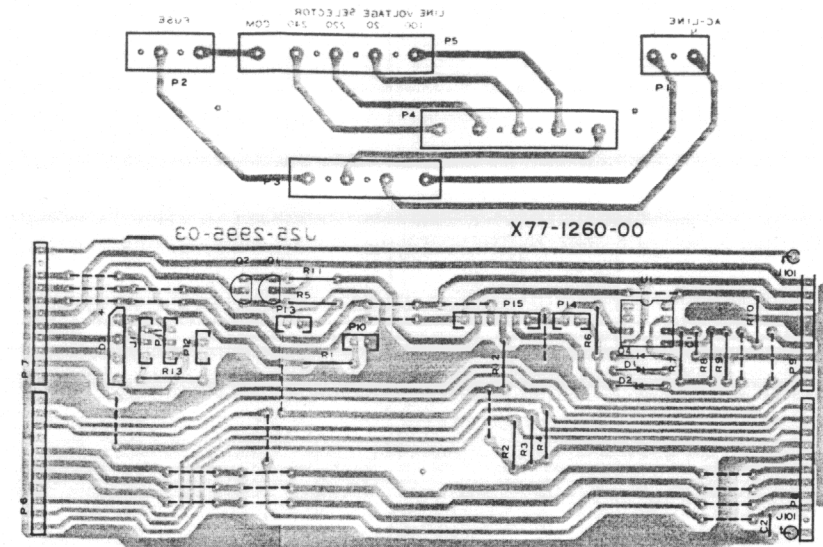

HORIZONTAL & HIGH VOLTAGE UNIT (X74-1340-00)

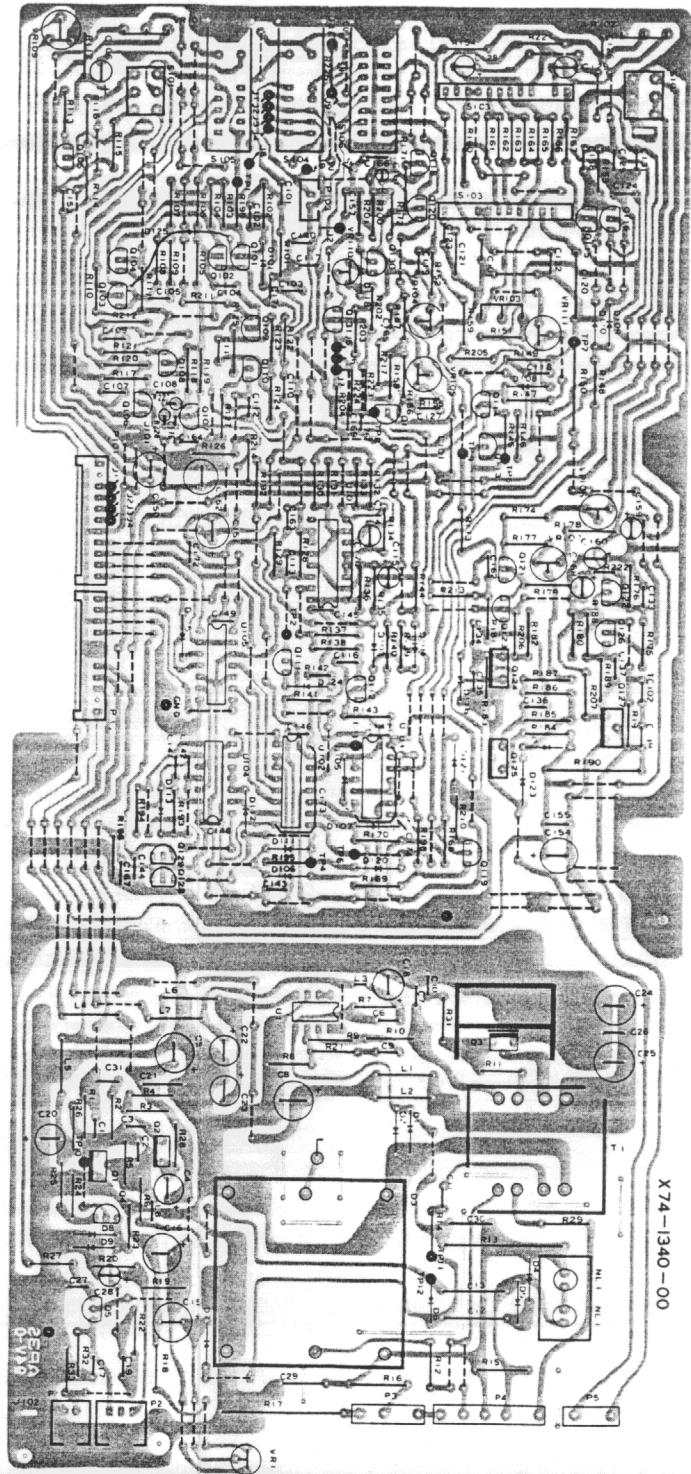

VERTICAL AMP & POWER UNIT (X73-1490-00)

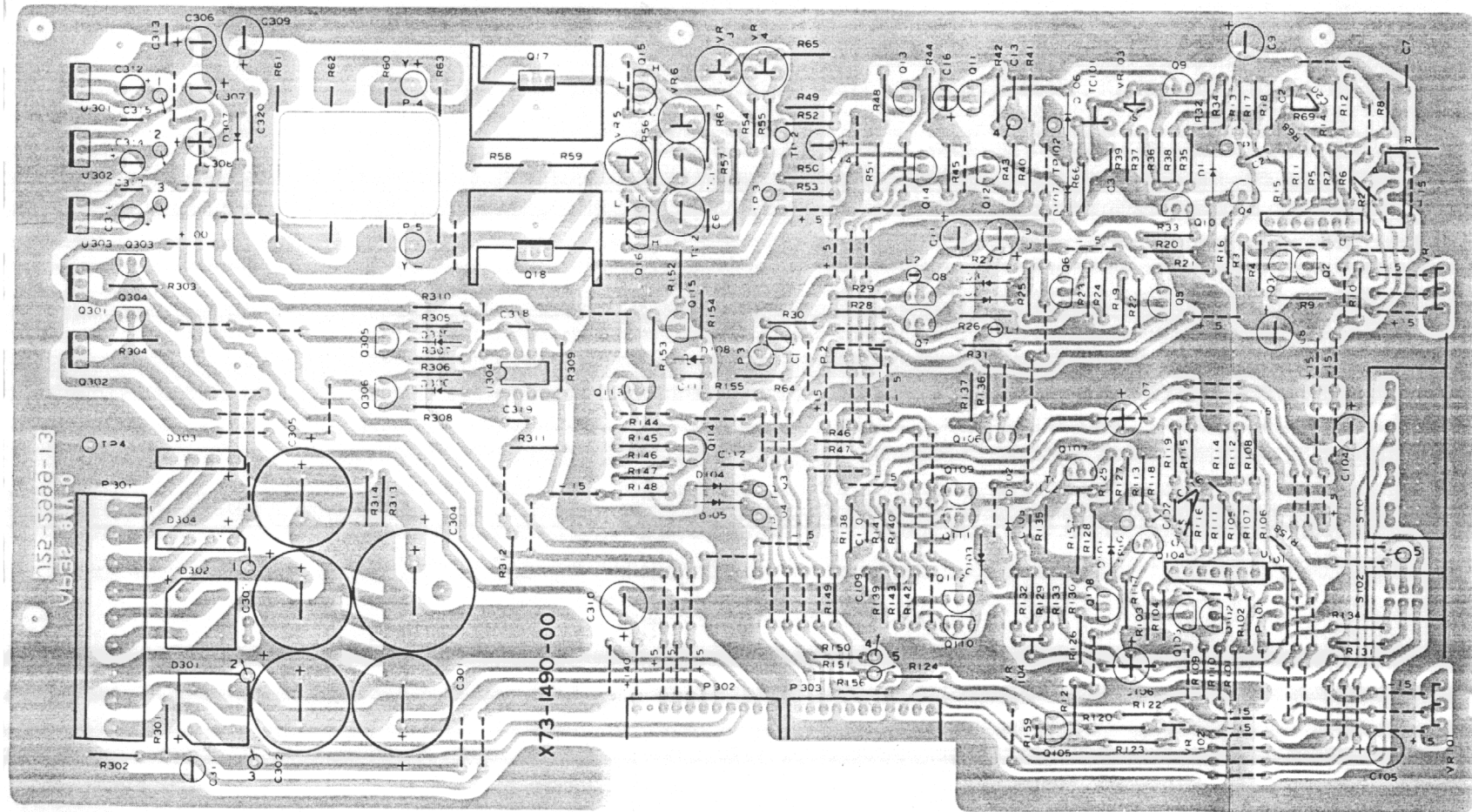

CRT SOCKET UNIT (X81-1250-00)

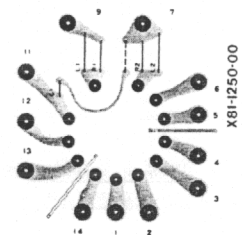

V. FINAL AMP UNIT (X73-1630-00)

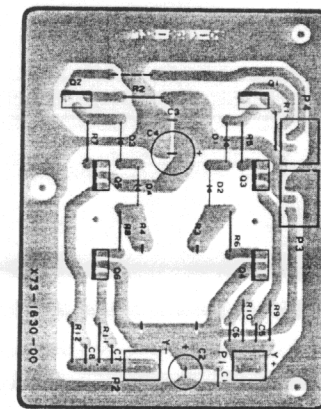

P.C. BOARD

VERTICAL ATTENUATOR UNIT (X75-1140-00)

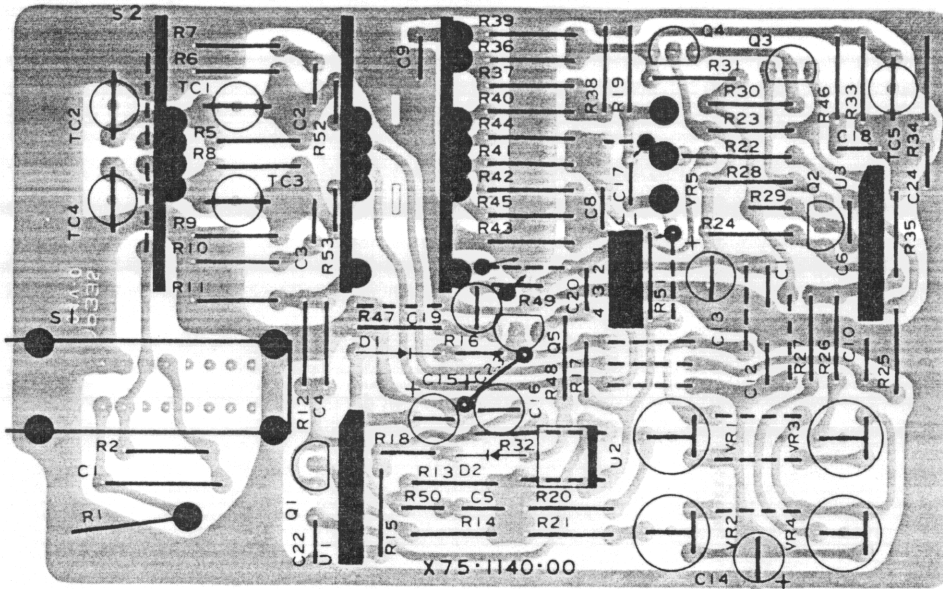

CONNECTION UNIT (X77-1260-00)

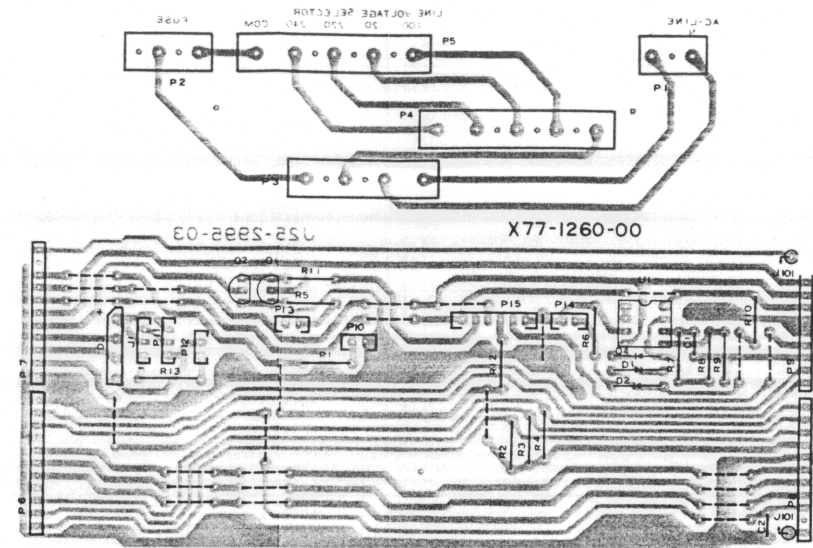

HORIZONTAL & HIGH VOLTAGE UNIT (X74-1340-00)

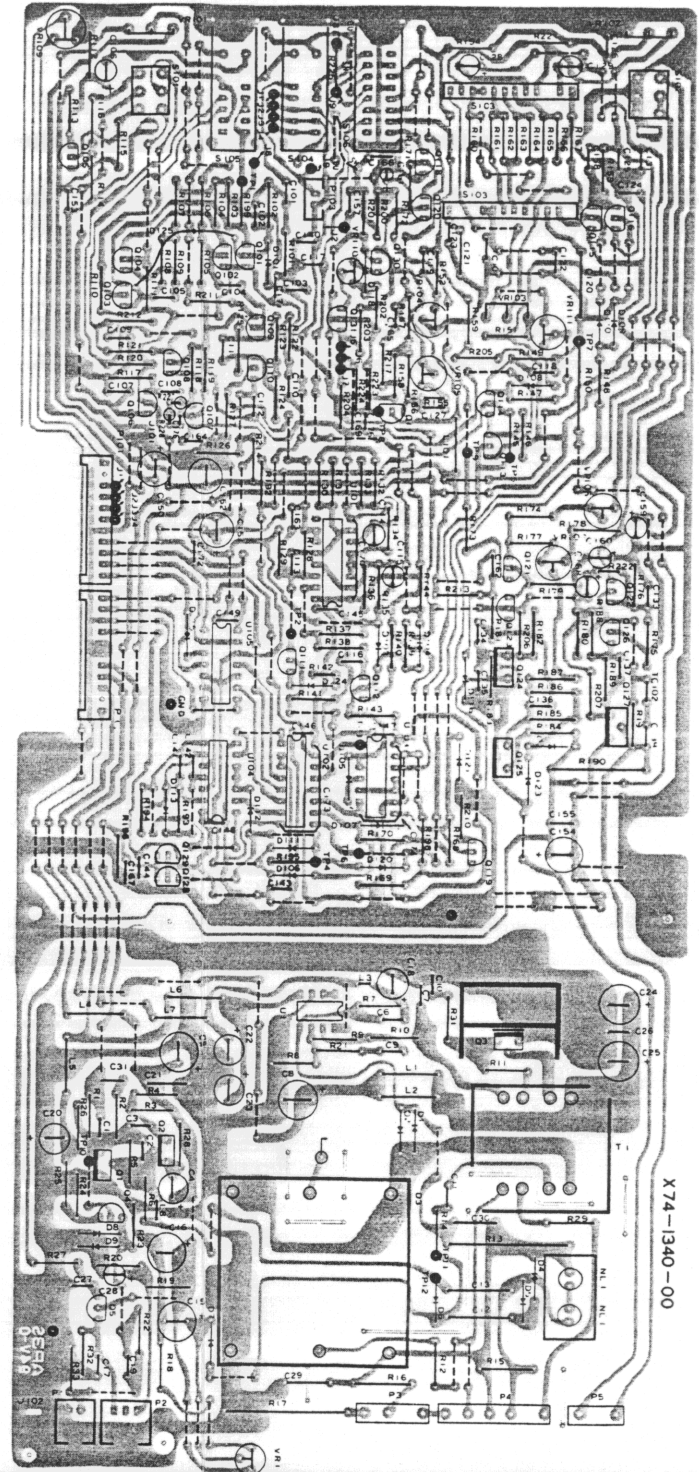

VERTICAL AMP & POWER UNIT (X73-1490-00)

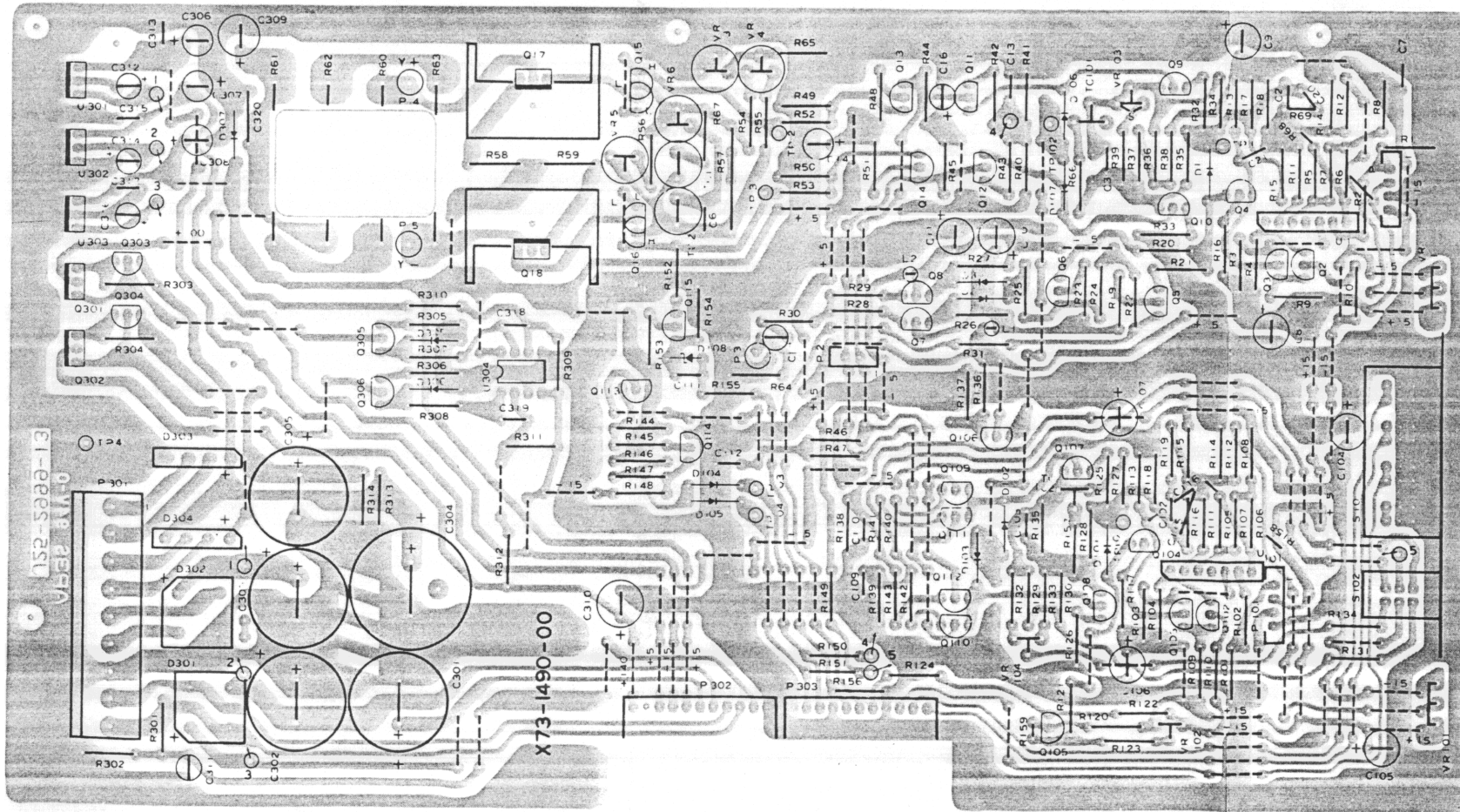

CRT SOCKET UNIT (X81-1250-00)

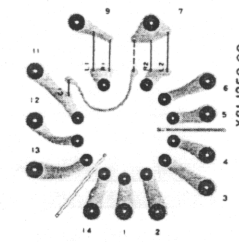

V. FINAL AMP UNIT (X73-1630-00)

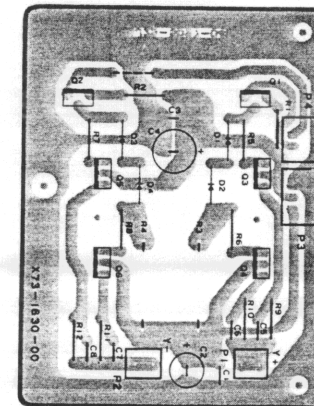

CS-1022 SCHEMATIC DIAGRAM

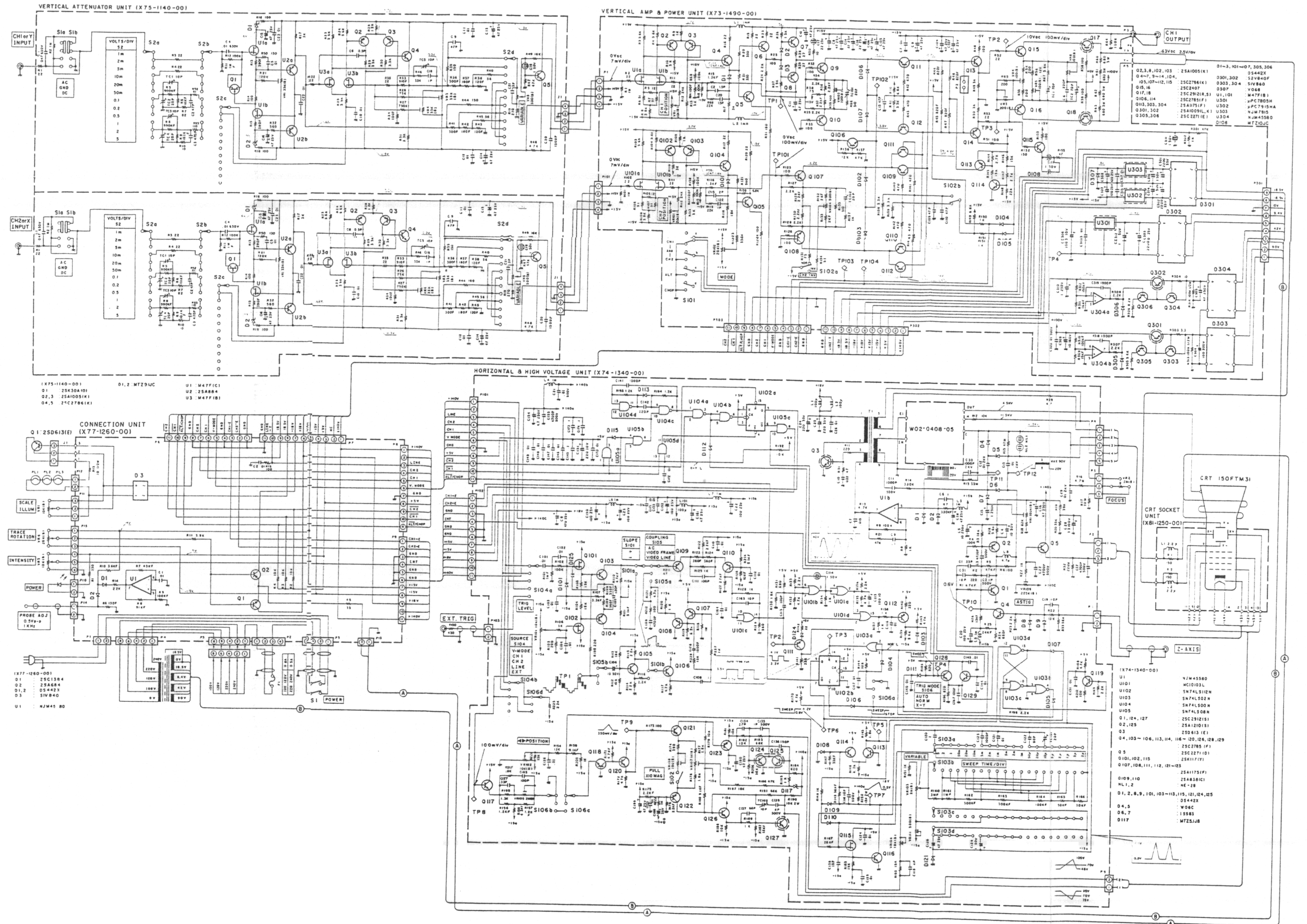

CS-1020 SCHEMATIC DIAGRAM

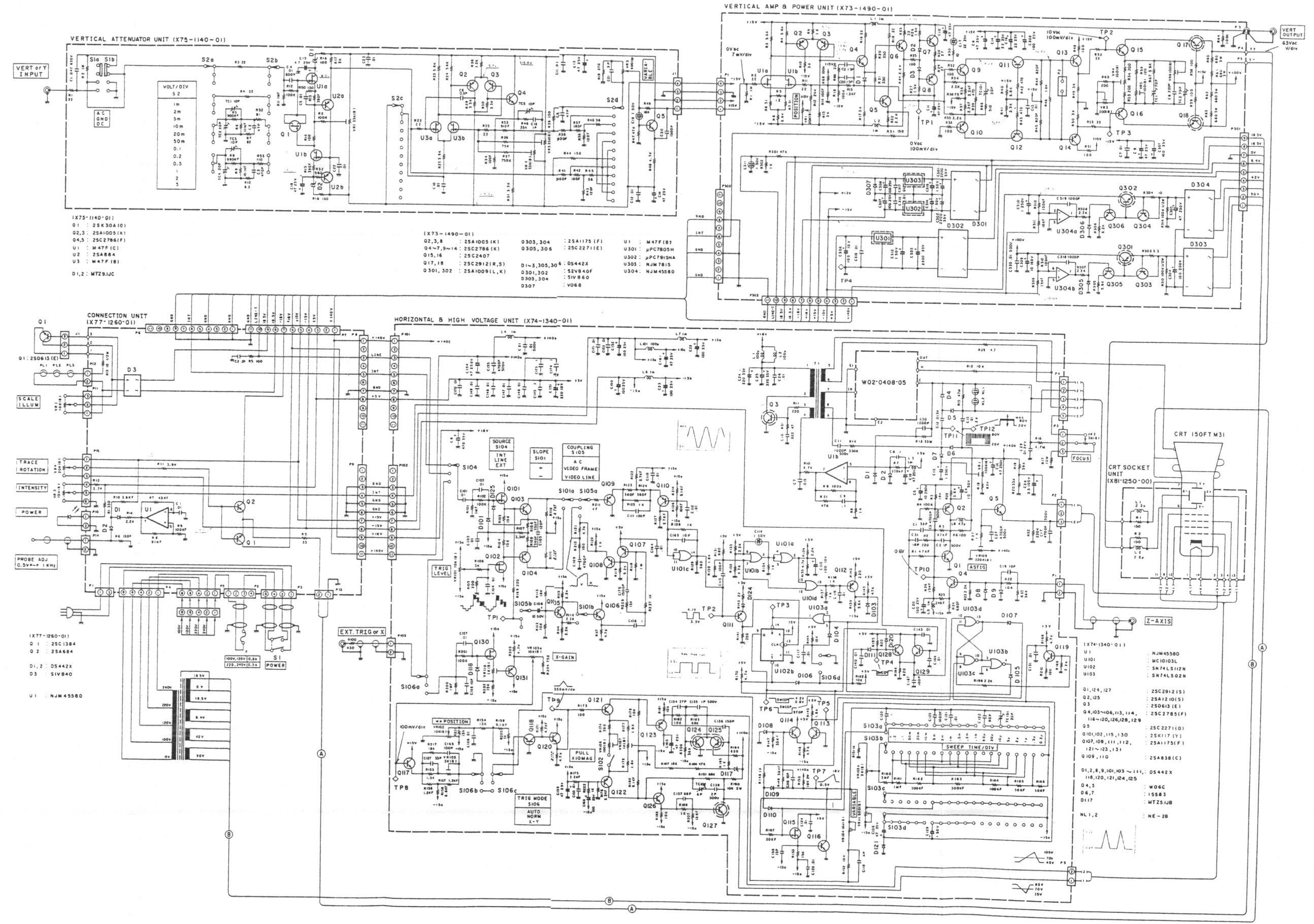

CS-1012 SCHEMATIC DIAGRAM

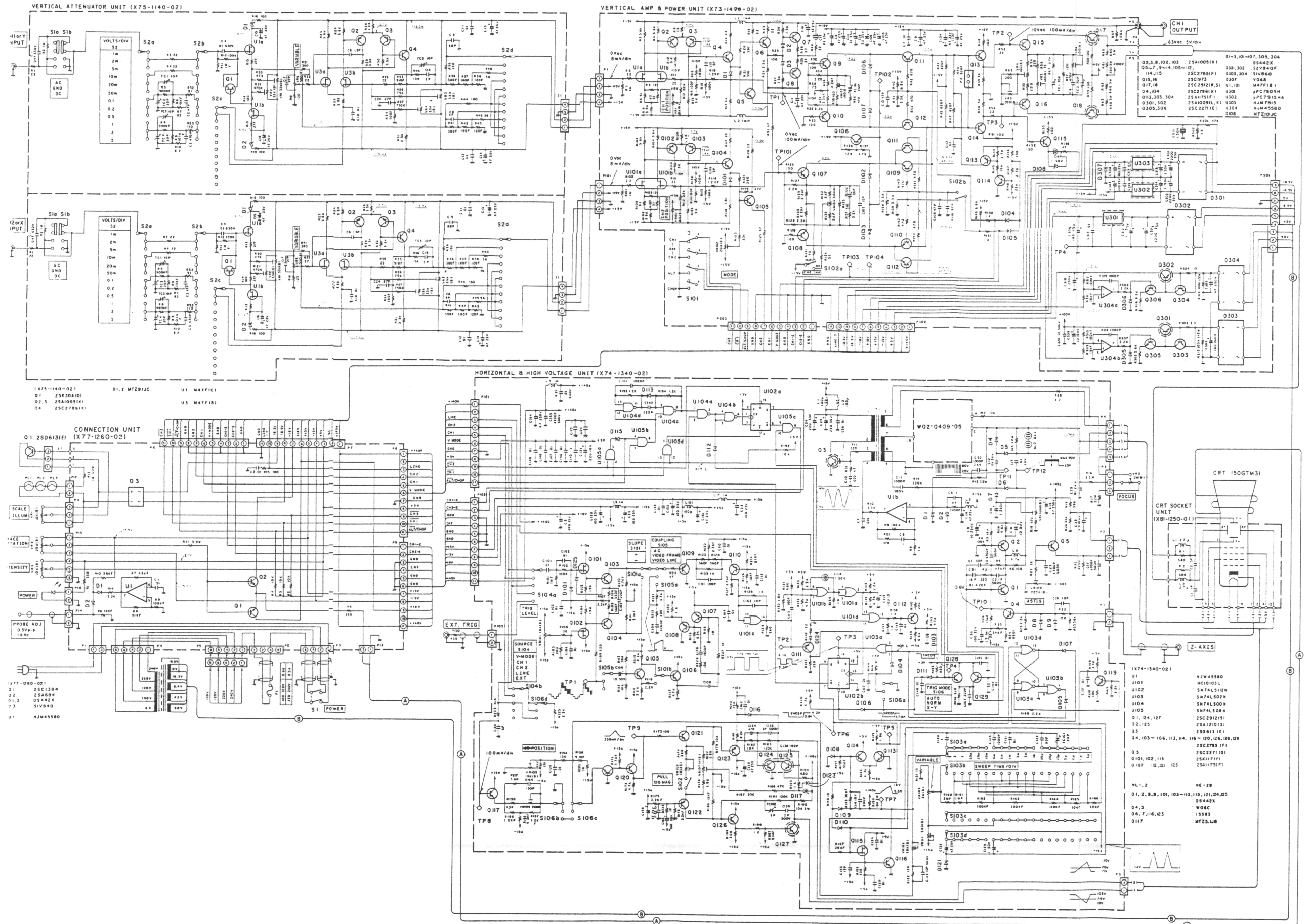

CS-1010 SCHEMATIC DIAGRAM

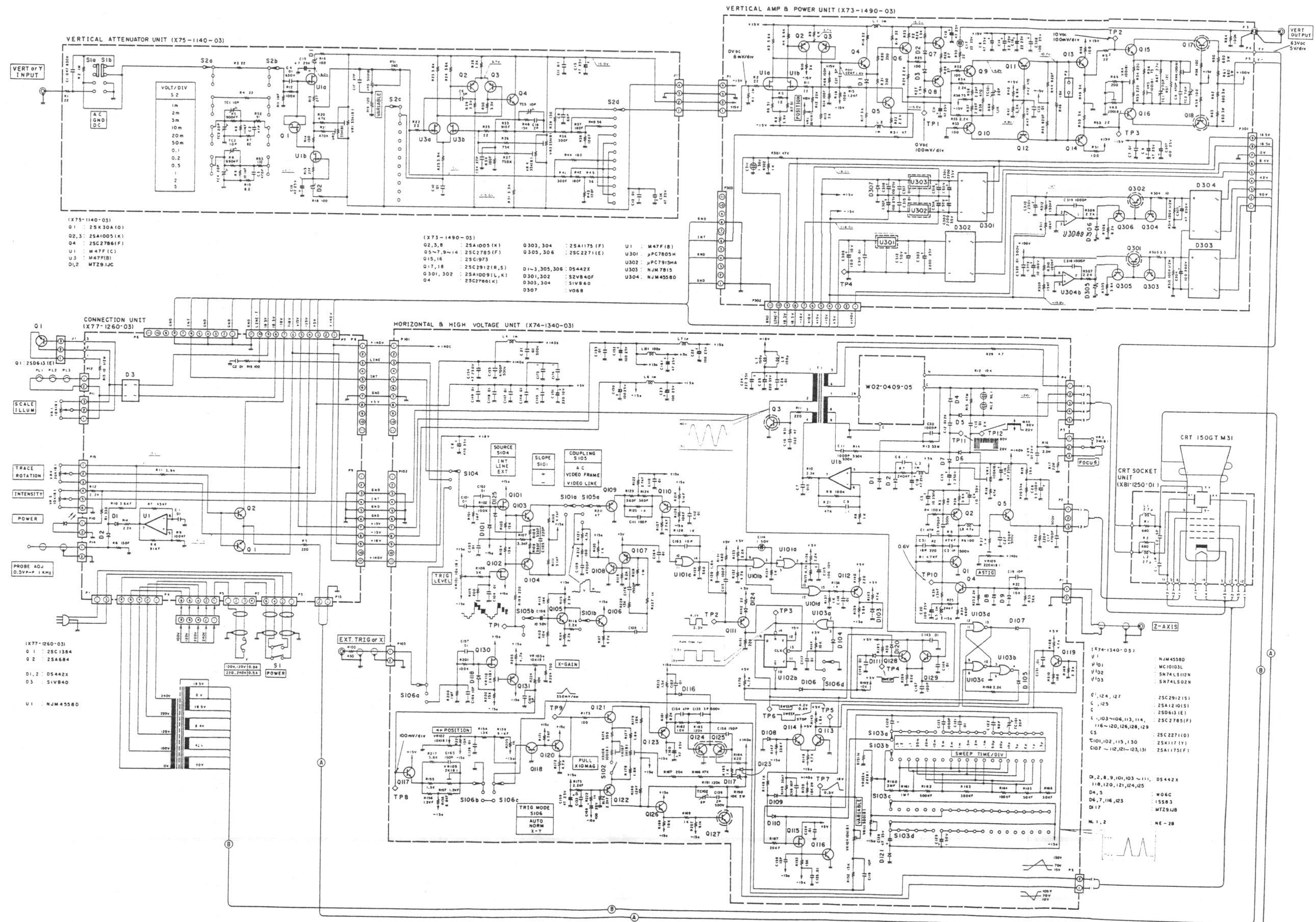

- (X75-1140-03)
 Q1 : 2SK30A(D)
 Q2,3 : 2SA1005(K)
 Q4 : 2SC2786(F)
 U1 : M47F(C)
 U3 : M47F(B)
 D1,2 : MTZ91JC

- (X73-1490-03)
 Q2,3,8 : 2SA1005(K) Q303,304 : 2SA1175(F)
 Q5-7,9-14 : 2SC2785(F) Q305,306 : 2SC2271(E)
 Q15,16 : 2SC1973 D1-3,305,306 : DS442X
 Q17,18 : 2SC2912(R,S) Q301,302 : 5V840F
 Q301,302 : 2SA1009(L,K) Q303,304 : 5V860
 Q4 : 2SC2786(K) Q307 : V06B
 U1 : M47F(B)
 U301 : pCT803H
 U302 : pCT910HA
 U303 : NUM7815
 U304 : NUM4558D

- (X77-1260-03)
 Q1 : 2SC1384
 Q2 : 2SA684
 D1,2 : DS442X
 D3 : 5V840
 U1 : NUM4558D

- (X74-1340-03)
 U1 : NUM4558D
 U101 : MC10103L
 U102 : SN74LS12N
 U103 : SN74LS02N
 D1,12,4,127 : 2SC2912(S)
 C,125 : 2SA1210(S)
 C,126 : 2SD613(E)
 C,103-106,113,114,116-120,126,128,129 : 2SC2785(F)
 C5 : 2SC2271(D)
 C101,102,115,130 : 2SK117(Y)
 C107-112,121-123,131 : 2SA1175(F)
 D4,2,8,9,10,103-111 : DS442X
 D4,5 : W06C
 D6,7,116,123 : 15583
 D17 : MTZ91JB
 M1,2 : NE-28

CS-1021 SCHEMATIC DIAGRAM

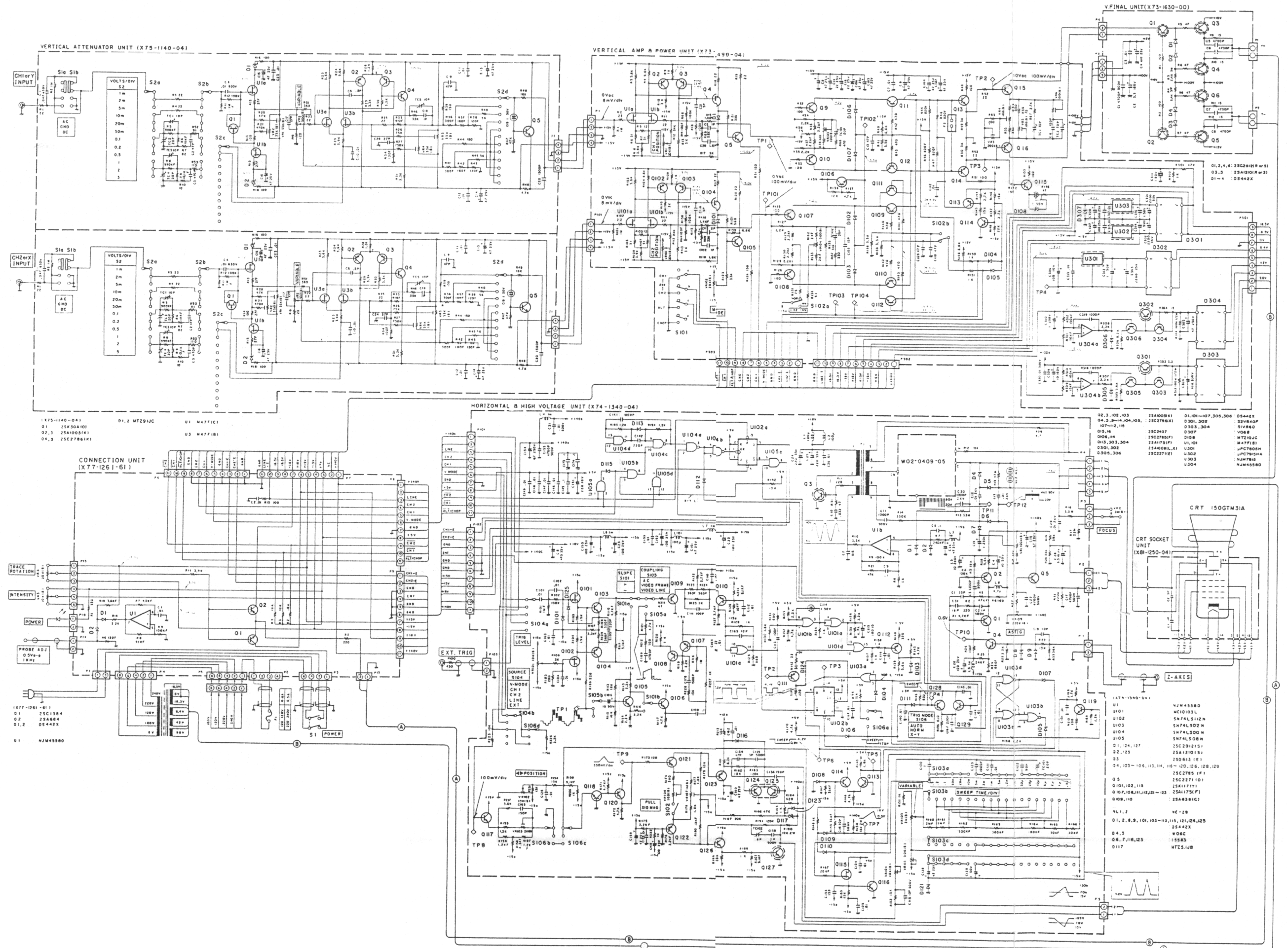

manual produced by

ElectronicsAndBooks@Yahoo.com

PO Box 5156

2000 GD Haarlem

Netherlands

manual produced by

ElectronicsAndBooks@Yahoo.com

PO Box 5156

2000 GD Haarlem

Netherlands