

*OPERATION MANUAL*

**COR5500U SERIES**

**DIGITAL OSCILLOSCOPE**

**COR5501U**

**COR5561U**

**READOUT OSCILLOSCOPE**

**COR5500U**

**COR5560U**

KIKUSUI PART No. Z1-000-122 IB000702

Fifth Printing May 1997

All or any parts of this manual may not be reproduced in any forms, without express written permission of Kikusui Electronics Corporation.

The contents of this manual, including the specifications of the instrument, are subject to change without notice.

HP-GL is a trademark of Hewlett-Packard Company.

©Copyright Kikusui Electronics Corporation, 1991-1997. All rights reserved.



### **ROM Version Number**

**This manual is applicable to the oscilloscope which has the following version of the ROM (read only memory):**

**1.10 or later**

**When making any inquiries on your instrument, please mention the ROM version number and the product number of your instrument.**

**The product number is indicated on a sticker on the rear panel of your instrument.**

**To find the ROM version, please refer to Section 2.4 "Checking the Oscilloscope Operation" under Chapter 2 "PRECAUTIONS."**

## AC Power Cable

One of the following three types of cables will accompany your oscilloscope.

1. For U.S.A. Part No. 85-10-0170
2. For European countries Part No. 85-10-0141
3. For Australia Part No. 85-10-0290

When replacing the AC plug of the AC power cable, be sure to replace it with a plug of the correct type and ratings, and to connect correctly the GND, NEUTRAL and LIVE wires which are color-coded as shown in Figure 1.

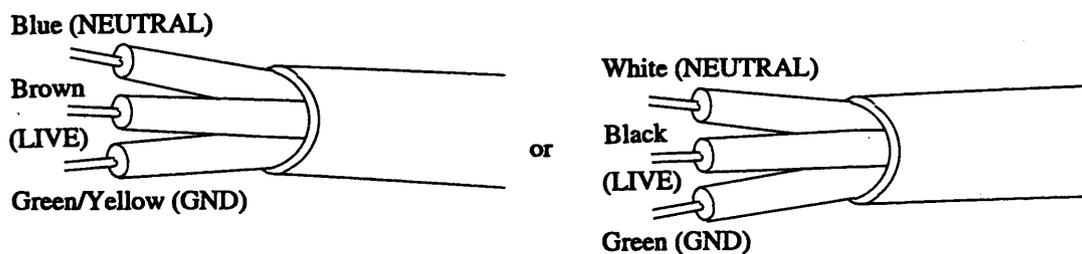

Figure 1

# TABLE OF CONTENTS

	PAGE
Indications for Cautions and Warnings .....	v
Cautions and Warnings for This Instrument .....	vi
1. GENERAL .....	1-1
1.1 Model Types .....	1-1
1.2 Features .....	1-1
2. PRECAUTIONS .....	2-1
2.1 Receiving Inspection .....	2-1
2.2 General Precautions .....	2-2
2.3 How to Use the Handle/Stand .....	2-5
2.4 Checking the Oscilloscope Operation .....	2-7
3. PREPARATION FOR MEASUREMENT .....	3-1
4. OPERATION METHOD .....	4-1
4.1 Real Mode .....	4-1
4.1.1 Vertical Axis .....	4-1
4.1.2 Triggering .....	4-4
4.1.3 Horizontal Axis (Timebase) .....	4-11
4.1.4 Z-axis Control .....	4-16
4.1.5 Comments .....	4-17
4.1.6 Cursors .....	4-22
4.2 Storage Mode (COR5501U, COR5561U) .....	4-30
4.2.1 Storage Mode and Real Mode .....	4-30
4.2.2 Storage Menu .....	4-32
4.2.3 Roll Mode .....	4-34
4.2.4 Repetitive Mode .....	4-36
4.2.5 Interpolation Mode .....	4-40
4.2.6 View Time .....	4-42
4.2.7 Pretrigger .....	4-44
4.2.8 Pause (Suspension of Operation) .....	4-45
4.2.9 Waveform Magnification/Window .....	4-46
4.2.10 Saving Memory .....	4-48
4.2.11 SINGLE Sweep in Storage Mode .....	4-50
4.2.12 Effective Storage Frequency Bandwidth .....	4-51
5. DESCRIPTIONS OF FRONT AND REAR PANELS .....	5-1
5.1 Power Switch and CRT Controls .....	5-1
5.2 Vertical Axes .....	5-2
5.3 Trigger .....	5-4
5.4 Horizontal Axis (Timebase) .....	5-7
5.5 Readout .....	5-9

5.5.1	Comments .....	5-10
5.5.2	Cursors .....	5-11
5.6	Display for Probes .....	5-16
5.7	Others .....	5-16
5.8	Rear Panel .....	5-17
5.9	Storage .....	5-18
6.	MAINTENANCE .....	6-1
6.1	Backup Battery .....	6-1
6.2	CRT and Filter .....	6-2
7.	SPECIFICATIONS .....	7-1
Index	.....	I-1

## Indications for Cautions and Warnings

For the maximum safety of the persons who may use the instrument, COR5500U series oscilloscopes have been designed and manufactured for full safety features and they are shipped after stringent inspections. And yet, it is unavoidable to request the persons to use the instrument to handle it carefully, in order to avoid damage to the instruments and hazards to the persons.

This manual gives notes and warnings which the persons using the instrument must take heed of and observe. The types of such notes and warnings are as follows.

### **NOTE**

Means a matter that calls for special attention for correct and efficient use of the instrument.

### **WARNINGS**

Means a matter which might lead to damage of the oscilloscope itself or other instruments.

The following symbols may be posted on the oscilloscope as well as indicated in this manual.



**“DANGER! HIGH VOLTAGE”**

This symbol means that the item can be charged up to a hazardous high voltage and must not be touched with bare hands.



**“Refer to the Corresponding Section”**

This symbol means that relative matters at other location of the manual should be referred to.

### **CAUTION**

Means a matter which can lead to electric shock hazards to the person who is operating the instrument or to damage of the instrument itself or other instruments.



**USE A 3-PIN PLUG**

For the plug of the AC input power cable, be sure to use a 3-pin type (one of the pins is used for safety grounding).

## **Cautions and Warnings for This Instrument**

### **AC Line Voltage**

Be sure to operate the oscilloscope on an AC line voltage within its correct range.

### **AC Power Cable**

Be sure to use an AC power cable of the correct type.

### **AC Power Fuse**

Be sure to use a power fuse of the correct ratings.

### **Do not remove the covers.**

This oscilloscope has hazardous high voltages internally.

Do not remove the covers of the oscilloscope lest you should expose yourself to such high voltages. The covers should be removed only by qualified experts.

## Chapter 1. GENERAL

### 1.1 Model Types

Kikusui COR5500U series Oscilloscopes are available in eight models, with different combinations of frequency bandwidths and a digital storage function to best suit your applications. The eight modes are:

- COR5501U: 100MHz oscilloscope, with 20MS/s digital storage**
- COR5500U: 100MHz oscilloscope**
- COR5561U: 60MHz oscilloscope, with 20MS/s digital storage**
- COR5560U: 60MHz oscilloscope**
- COR5541U: 40MHz oscilloscope, with 20MS/s digital storage**
- COR5540U: 40MHz oscilloscope**
- COR5521U: 20MHz oscilloscope, with 20MS/s digital storage**
- COR5520U: 20MHz oscilloscope**

This manual is applicable to Models COR5501U, COR5500U, COR5561U, and COR5560U oscilloscopes.

### 1.2 Features

#### (1) Easy to operate

You can easily use major functions of the oscilloscope which employs a direct knob control system.

#### (2) Compact and light

COR5500U series is very compact and light for its sophisticated functions and reliable performance. This has become feasible through dexterous use of flush-mount components.

#### (3) CRT readout

The CRT readout displays various items of information on the CRT screen, providing you with a powerful means for rapid but accurate measurements.

#### (4) Comment display

You can display comments by using this feature. If your oscilloscope has the digital storage function and operates with GPIB, the comment text you have written can be output to an HP-GL plotter via GPIB.

#### (5) Alternate magnified sweeps

This feature allows you to magnify readily any portion of the waveform you want to observe more closely. The timebase can be magnified by 5, 10, or 50 times. The Alternate Magnified Sweep mode, which runs a main sweep and a magnified sweep alternately, is also available.

**(6) Sampling rate up to 20MS/s**

The maximum sampling rate is 20MS/s. Each channel has an 8bit A/D converter, allowing you to store the single-shot data from both channels simultaneously. In Single Trigger Mode, you can capture frequency components up to 5.7MHz (when Curve Interpolation is used).

**(7) 4k words/channel memory capacity**

Each channel has a 4k word memory, and resolution of 400 points per one division horizontally. The digitally stored and reproduced waveforms closely resemble the original analog ones.

COR5500U series has two 4k-word Saving Memory units. The memory units are internally backed up so that the data is not destroyed even if the power is turned off. The data is maintained for a longer period.

**(8) Repetitive mode**

The COR5501U can store repetitive signals up to 100MHz and, COR5561U can store up to 60MHz in Random Sampling mode.

**(9) Printing screen data for HP-GL plotter**

If an optional GPIB Interface (IF01-COR) is attached to your oscilloscope, waveforms and all readouts can be directly output to a GPIB plotter if it accepts HP-GL commands.

## Chapter 2. PRECAUTIONS

### 2.1 Receiving Inspection

Prior to the shipment from our factory, the oscilloscope has been subjected to electrical and mechanical testing and guaranteed of satisfactory quality and performance. Nevertheless, you are kindly requested to make a receiving inspection to see if the oscilloscope has any in-transit damage. If you find any, inform the transportation company of such damages without delay.

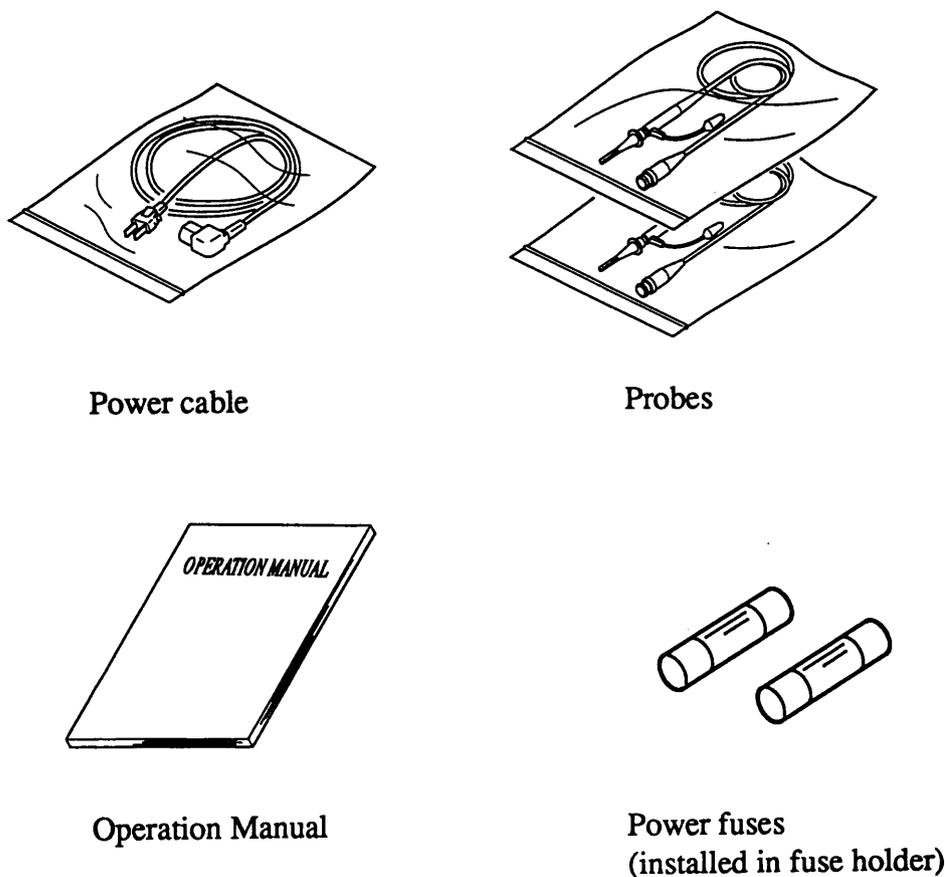

Figure 2-1. Accessories

Power cable .....	1
Probes .....	2
P100-8CE (COR5501U, COR5500U) .....	2
P060-6CE (COR5561U, COR5560U) .....	2
Operation manual .....	1
Power fuses .....	2

(Two fuses, one of these is for replacement spare, are put in the fuse holder cap.)

## 2.2 General Precautions

This section describes electrical and mechanical precautions for safe and correct use of the oscilloscope. Be sure to read this section before start using the oscilloscope.

### (1) Checking the AC line voltage and frequency

Operate the oscilloscope on its rated AC input voltage of 100 through 240V, frequency 50 through 400 Hz, although it is permissible to operate the oscilloscope on an AC line voltage of 90 - 250V, frequency 45 - 440 Hz.

### (2) Checking the type and ratings of fuse

Before connecting the power cable to the AC inlet of the oscilloscope, check the type and ratings of the power fuse. The fuse holder of the oscilloscope is structured integrally with the AC inlet. The fuse holder cap can be detached by using a screwdriver or a pointed tool as shown below. Two fuses (one of which is for replacement spare) are put in the cap.

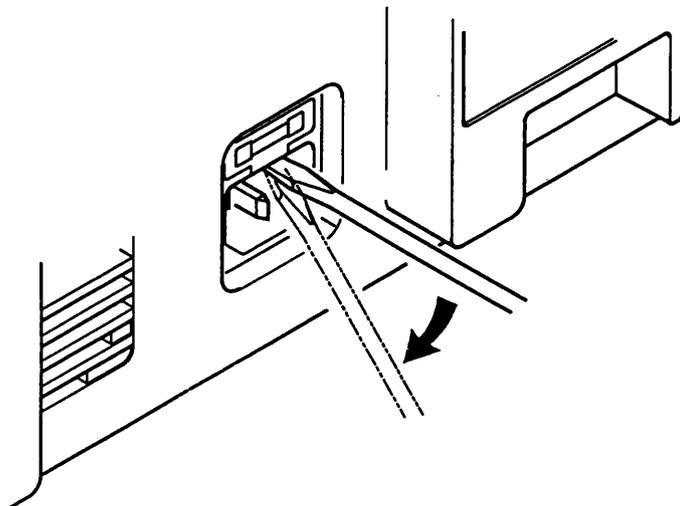

Figure 2-2. Fuse replacement

Take out the fuse and check that it is a slow-blow fuse of 250V AC, 2A (T). Return the fuse and cap to the original positions by following the take out procedure in the reverse order. Fully insert the cap until it clicks.

When you replace the fuse with new one, make sure to use a correct one. The spare fuse is put in the fuse holder cap. When the fuse has also used up, you may use a new one available on the market, but be sure that it is the correct type and ratings.

#### **WARNINGS**

*Never use a wrong or incorrect fuse. Never short-circuit the fuse holder terminals instead of the fuse. These operations might result in serious damage and hazards.*

**(3) Checking the power cable**

Be sure to use the power cable which is supplied as an accessory of the oscilloscope. The power cable has a 3-core wire and a 3-pin plug, and one of the three pins is used for safety grounding. Be sure to connect the plug to a 3-pin receptacle—one of the three pins being for safety grounding.

**(4) Environments**

Avoid to use the oscilloscope in environments as mentioned below.

**(a) High temperature**

Do not expose the oscilloscope to direct sunlight or other source of heat. (The ambient temperature range for the guaranteed performance is 10 to 40°C or 50 to 104°F).

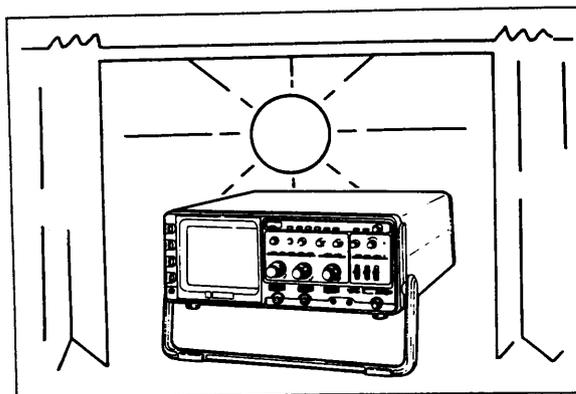
**(b) High humidity**

Do not use the oscilloscope in high humidity. (The humidity range for the guaranteed performance is up to 75% RH.)

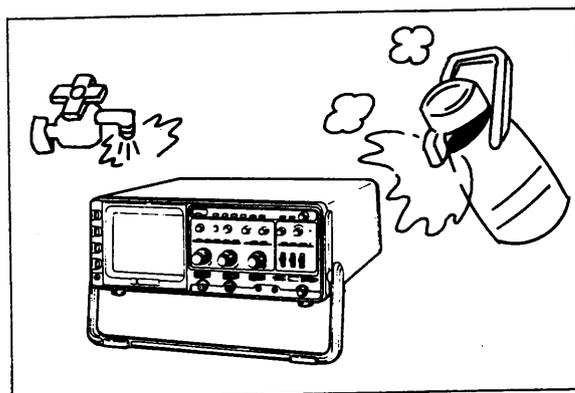
**(c) Electric or magnetic field**

Do not use the oscilloscope in strong electric or magnetic field, lest the displayed images should be distorted, or otherwise adversely affected.

When unscreened cables, or Oscilloscope Probes, are used on the input of this product, the display may indicate the presence of an RF electromagnetic field if its frequency is within the bandwidth of the oscilloscope. To minimize this effect it is recommended

that screened cables, possibly double screened, are used to connect the signal to the oscilloscope. With suitable screening the RF pick up may be reduced to typically 4 divisions p-p at 10mV/div when in a field strength of 3V/m. The deflection depends on the sensitivity setting and the field strength, and may be reduced by moving the oscilloscope away from the source of the interfering field.

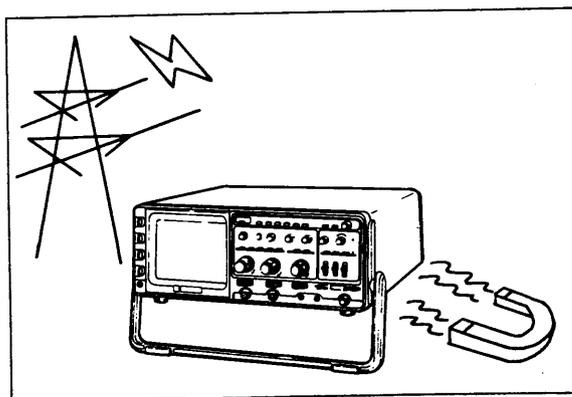

**(d) Unstable position**

Do not put the oscilloscope on a swaying bench or in other unstable position.

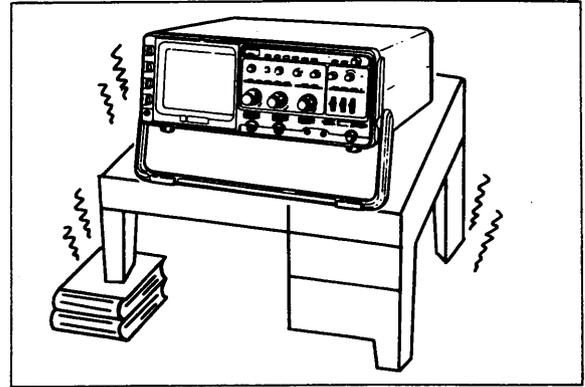

**(e) Flammable atmosphere**

Do not use the oscilloscope in flammable or explosive atmosphere, to prevent fire and explosion hazards.

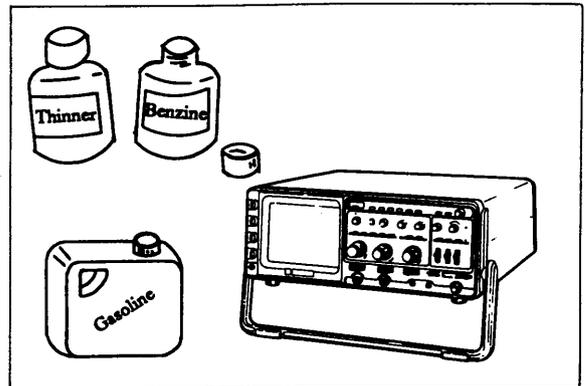

**(f) Blocked ventilation holes**

Do not block the ventilation holes of the rear, side, and bottom panels. Provide an ample space behind the rear panel, which the air-cooling fan is installed on.

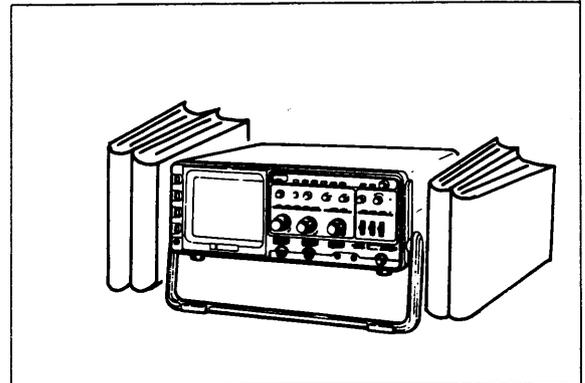

**(5) Preserving the CRT**

**CRT intensity**

In order to prevent permanent damage to the CRT phosphor, do not make the CRT trace excessively bright or leave the beam spot stationary for an unreasonably long time.

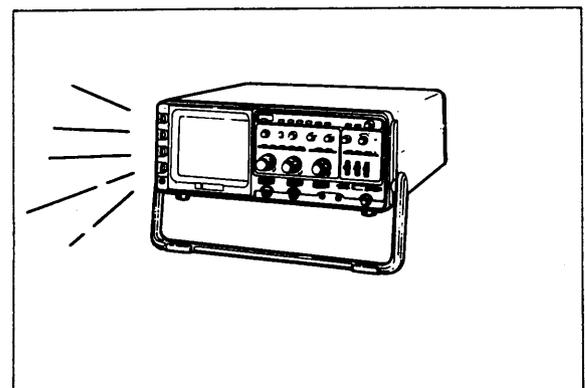

## 2.3 How to Use the Handle/Stand

The oscilloscope has a carrying handle, which can be used also as a scope-stand (a pillow, that is) to tilt the oscilloscope to a good viewing angle.

### (1) To use the handle/stand

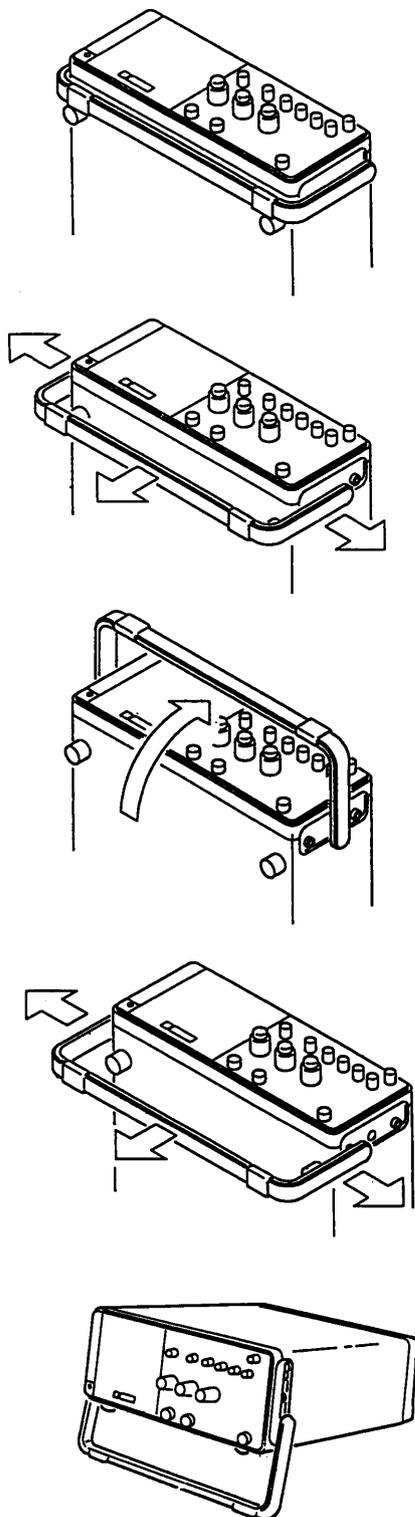

To move the handle to the usable position, be sure to put the oscilloscope in the vertical position with the handle positioned to your side as illustrated in the left.

#### (a) As a carrying handle

Pulling the roots of handle outside, move the handle toward you until the roots reach the center positions.

When the roots have reached the center, turn the handle toward the front panel. Be sure to turn it to the vertical position where it is locked.

#### (b) As a scope-stand

Pulling the roots of handle outside, move the handle toward you until the roots are locked. When the handle is in this position, it serves as a scope-stand to keep the oscilloscope in a tilted angle for a better viewing angle.

**Caution** *Be sure that the handle is in the locked position. Otherwise, the handle might retract abruptly—letting the oscilloscope drop causing damage to the instrument or hurting you. Make it double sure to place the handle in the locked position.*

Figure 2-3. To use the Handle

**(2) To retract the handle/stand**

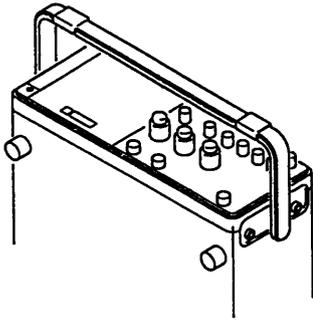

- (a) To retract the handle from the carrying-handle position, proceed as follows:**

Put the oscilloscope in the vertical position as illustrated in the left.

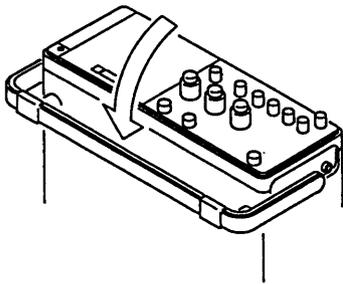

Turn down the handle to your side as illustrated.

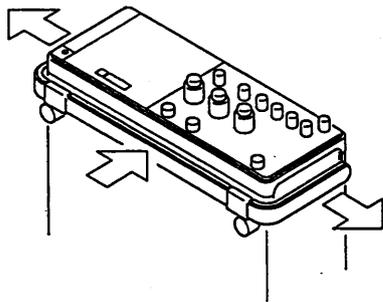

Pulling the roots of handle outside, push the handle in until the roots reach the locked positions.

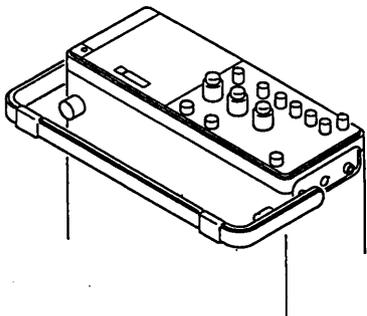

- (b) To retract the handle from the scope-stand position, proceed as follows:**

Put the oscilloscope in the vertical position as illustrated in the left.

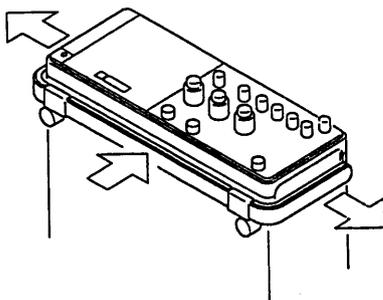

Pulling the roots of handle outside, push the handle in until the roots reach the innermost locked positions.

Figure 2-4. To retract the Handle

## 2.4 Checking the Oscilloscope Operation

Check the operation of the oscilloscope as explained in this section. The oscilloscope will automatically diagnose itself as you turn the power switch on.

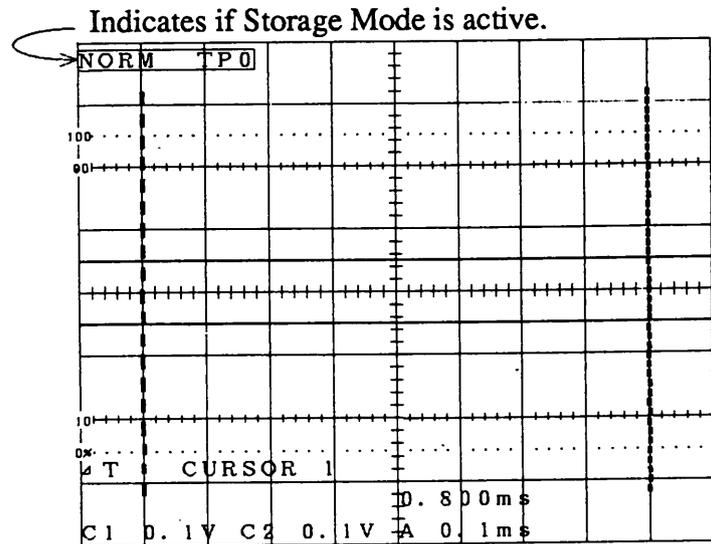
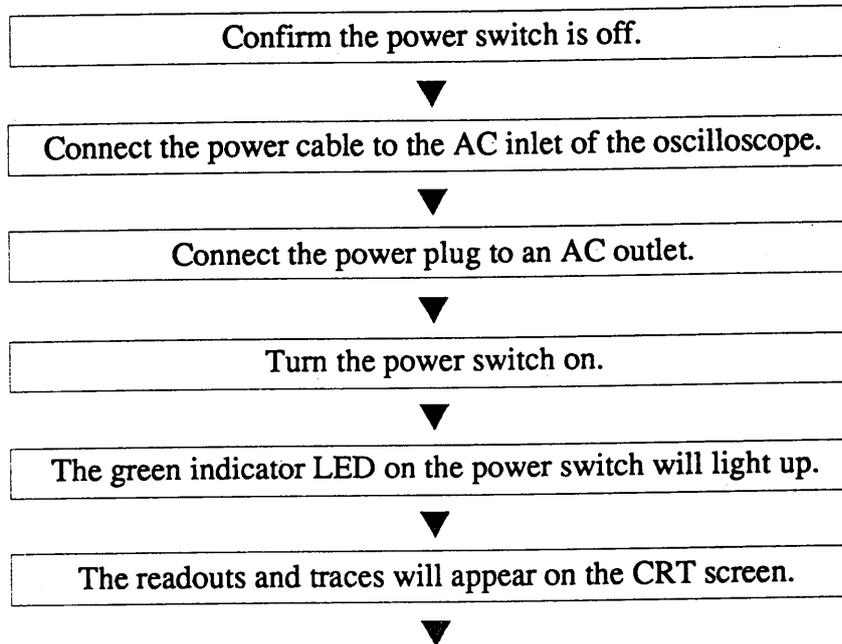
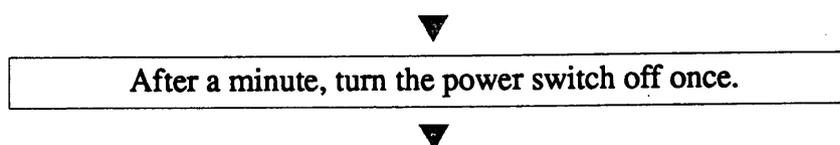

Figure 2-5. The Initial Setup Screen



Wait for several seconds and turn the power on again



You will see the following screen for about 2 seconds if the diagnostic results are passed.

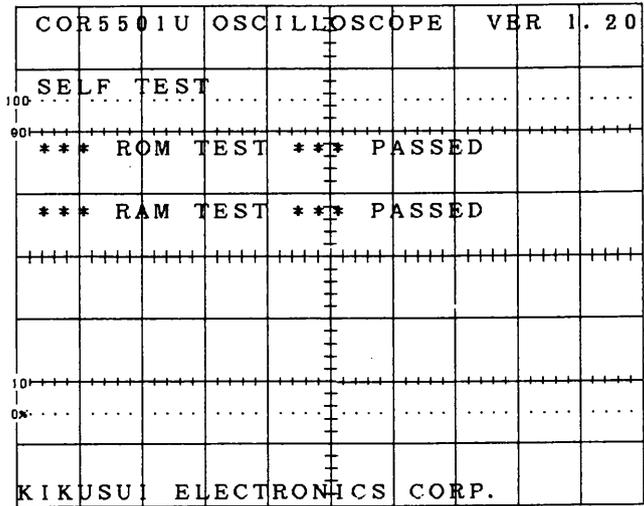

Figure 2-6. The Diagnosis Screen (results passed)



Diagnosis complete

If a diagnostic result is failed, a screen as shown in Figure 2-7 will appear. For trials to confirm the situation, turn the power switch on and off a few times—allowing several seconds each time before turning the power switch on. If such a situation still persists, this fact means that the oscilloscope has a trouble—the ROM or RAM of the oscilloscope might be failed. Stop using the oscilloscope and order your Kikusui agent for repair.

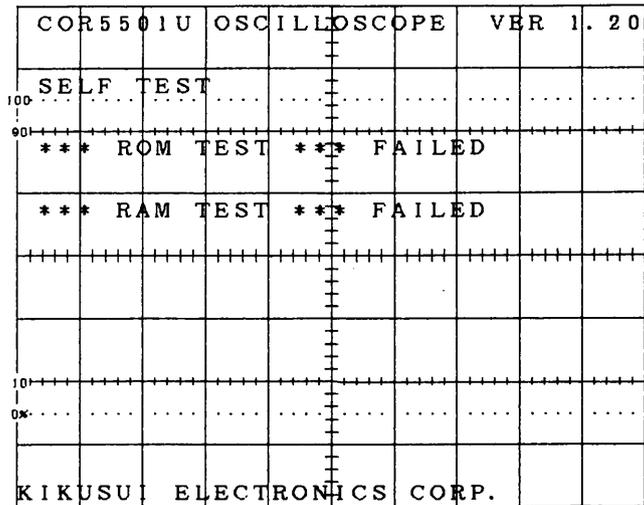
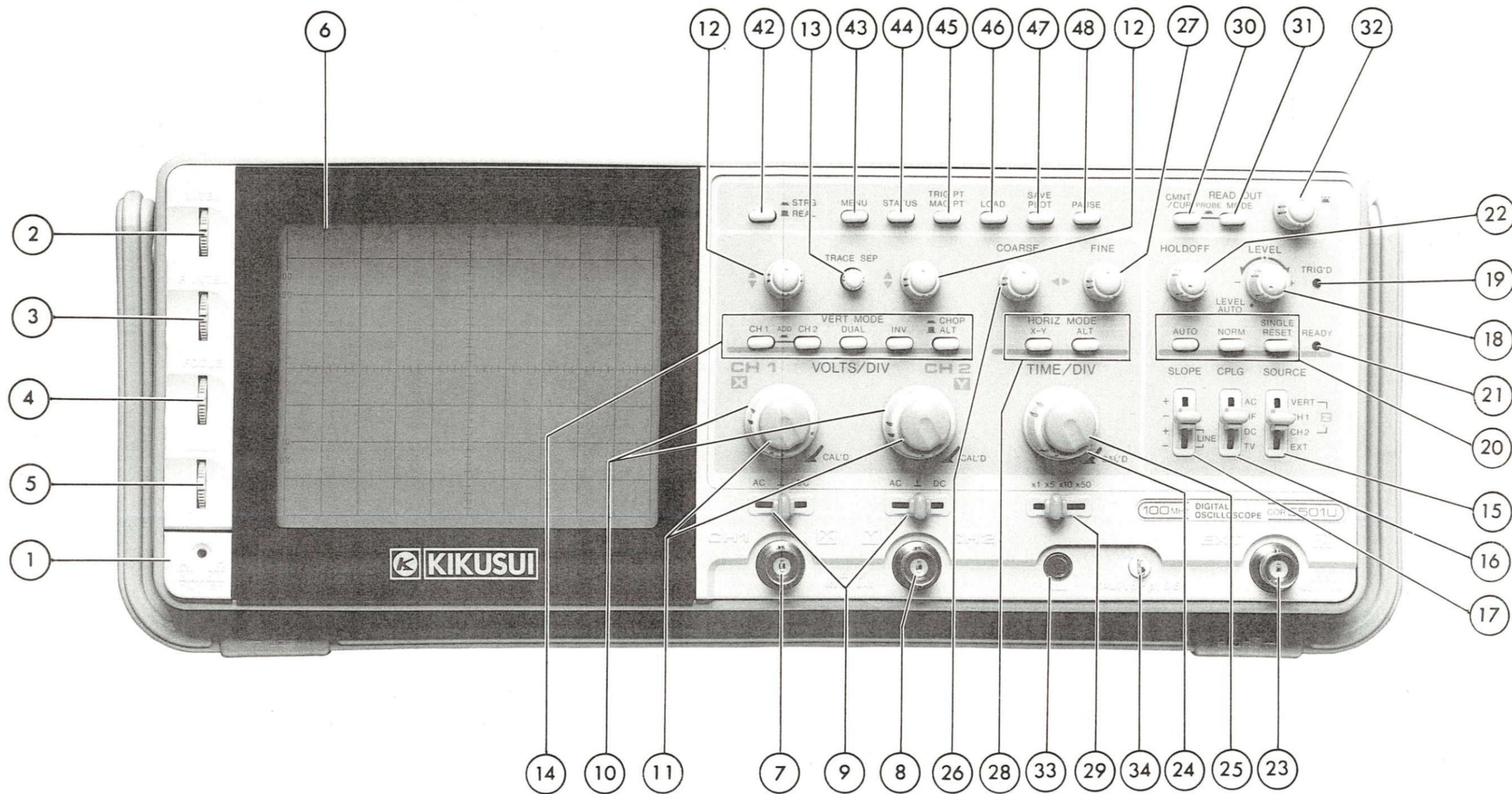
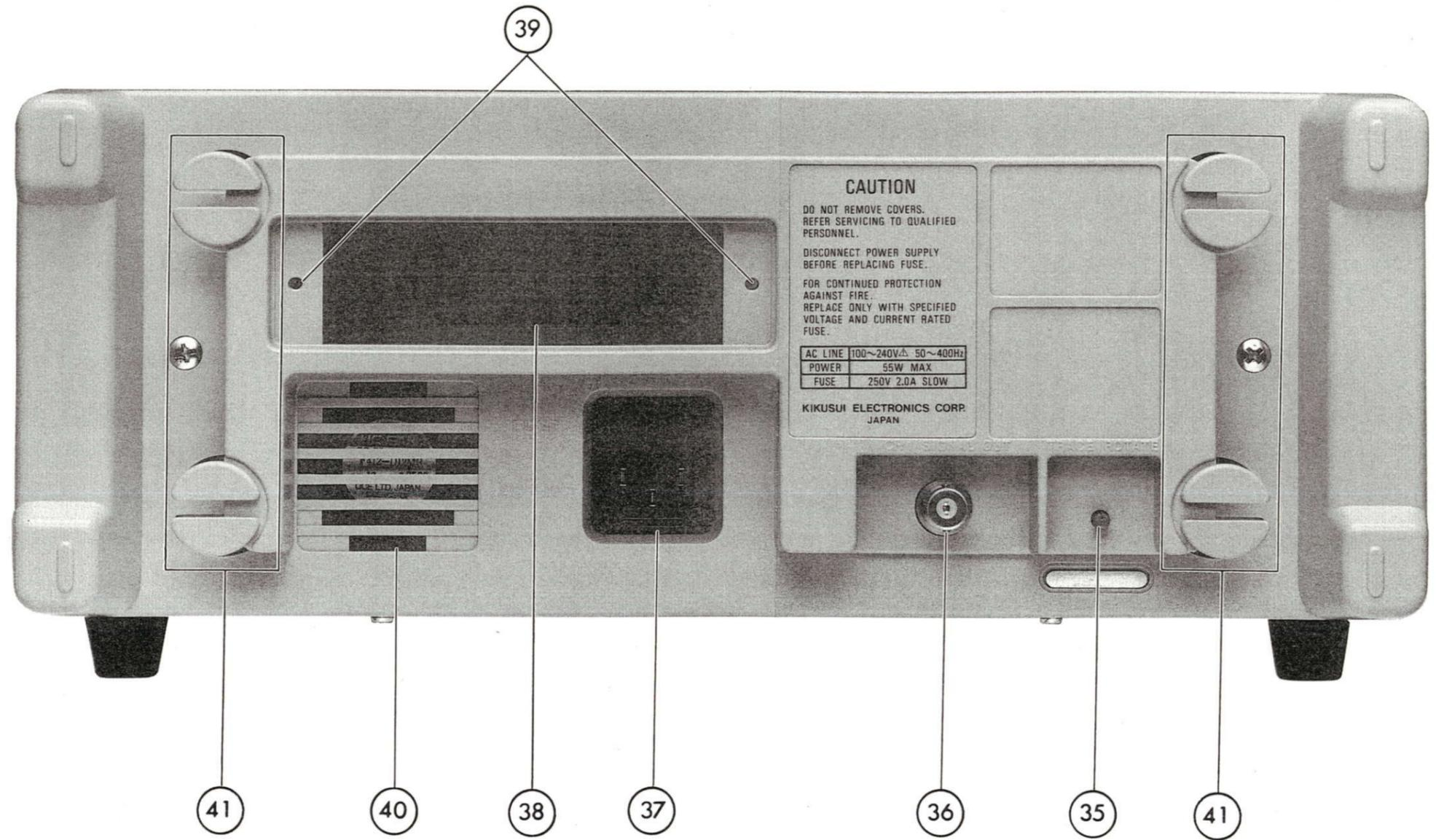

Figure 2-7. The Diagnostic Screen (results failed)





## Chapter 3. PREPARATION FOR MEASUREMENT

This section covers a simple preparative procedure to do first before using oscilloscope in order to measure waveforms or signals more efficiently and accurately. For the preparative procedure, proceed as follows:

**Caution** Be sure to read Chapter 2 "PRECAUTIONS" and do the following:

1. Checking the AC line voltage and frequency,
2. Checking the type and ratings of the fuse, and
3. Checking the oscilloscope operation.

### (1) Initial Setup

The initial setup when the oscilloscope is shipped from manufacturer is as shown in Table 3-1. If you use this oscilloscope first time, you had better to set it as shown in Table 3-1 (however, you may set the VOLTS/DIV ⑩ and TIME/DIV ⑳ to any positions).

Table 3-1. The Initial Setup

Item	No.	Position
POWER	①	Turned off
INTEN	②	Center (click) position
R INTEN	③	Center (click) position
FOCUS	④	Center (click) position
ILLUM	⑤	Center (click) position
VERT MODE	⑭	DUAL
POSITION	⑫	Approx. 12 o'clock position
VERT. VARIABLE	⑪	CAL'D (fully clockwise)
AC $\perp$ DC	⑨	$\perp$ (GND)
SOURCE	⑮	VERT
CPLG	⑯	AC
SLOPE	⑰	+
LEVEL	⑱	LEVEL AUTO (fully counterclockwise)
HOLD OFF	㉒	Minimum (fully counterclockwise)
TRIG MODE	㉔	AUTO
HORIZ. VARIABLE	㉕	CAL'D (fully clockwise)
COARSE	㉖	Approx. 12 o'clock position
FINE	㉗	Approx. 12 o'clock position
MAG switch	㉙	$\times 1$
X-Y	㉚	OFF
ALT	㉛	OFF
STRG/REAL	㉜	REAL (COR5501U and COR5561U only)

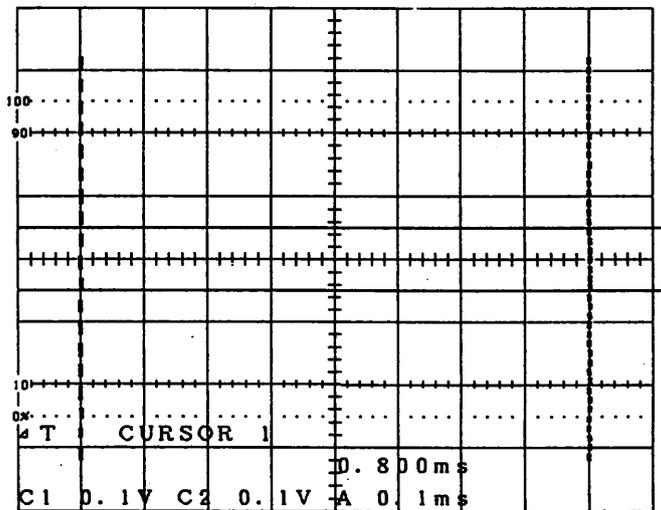
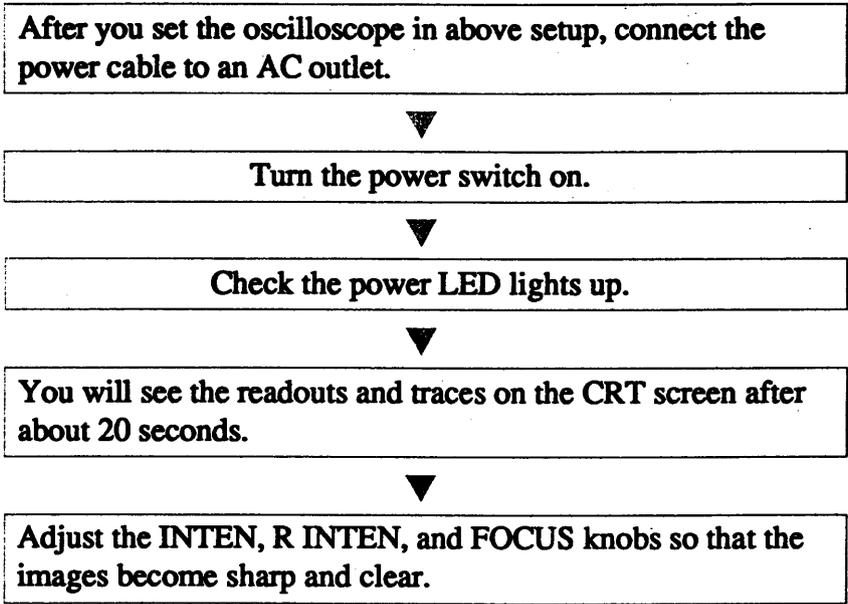
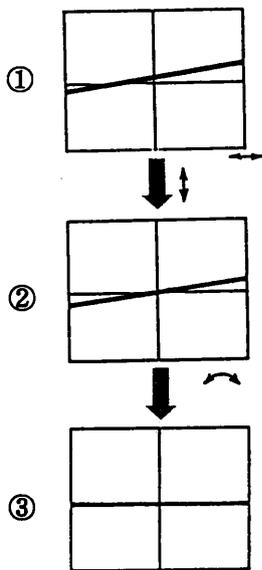

Figure 3-1. The Initial Setup Screen

If no images appear on the CRT screen even after one minute or more has elapsed, repeat the procedure all over again.

**(2) Trace Rotation**

Check the traces are placed in parallel with the horizontal graticule. (This check may be done with either CH1 or CH2 trace.)



Display the CH1 trace by setting the CH1 coupling switch to  $\perp$  (GND position).

Check the trace is in parallel with the horizontal graticule.

If the trace is not in parallel with the graticule as shown in Figure 3-2 ①, move the trace to the center of graticule with Horizontal and Vertical COARSE and FINE knobs. (Figure 3-2 ②)

Rotate the trace to parallel to the horizontal graticule, with the TRACE ROTATE knob on the rear panel.

The adjustment is complete if the trace is in parallel with the horizontal graticule. (Figure 3-2 ③)

Figure 3-2. Trace Rotation

**NOTE** The parallelism between the traces and the horizontal graticule is disturbed by the terrestrial magnetism. Whenever the position of the oscilloscope is changed, check the parallelism and correct it as required.

**(3) Probe Phase Compensation**

If you use a probe, you should adjust your probe for phase compensation before using it for measurement.

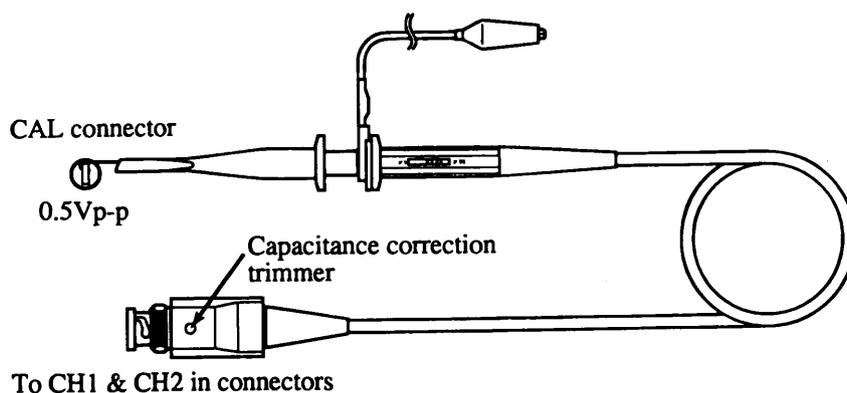

Figure 3-3. Probe

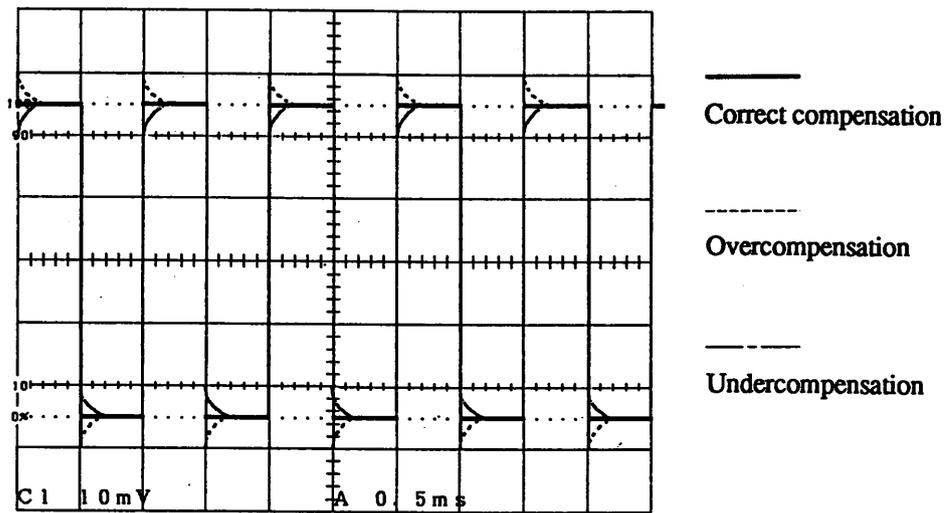
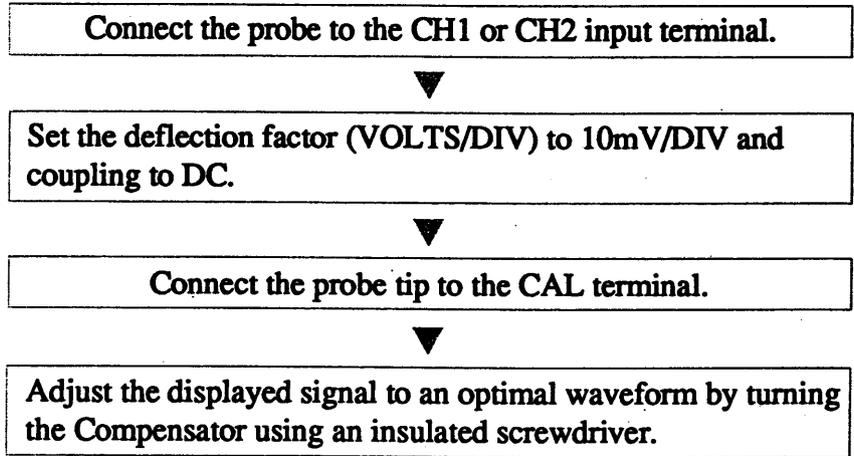

Figure 3-4. Probe Phase Compensation

- NOTE** (a) A probe performs actually a wide-band attenuator. Unless its phase compensation is correct, the displayed waveform might be distorted and measurement errors can be introduced.
- (b) The probe adjusted for a certain channel must not be used for another channel. If you want to use the probe on another channel, even already adjusted, perform the adjustment again for the channel.
- (c) For the phase compensation adjustment, use the signal of the CAL terminal on the front panel.

**(4) Changing Scale Factors When Using Probes**

When you use a probe, you can change the scale factor if it is more convenient for you. Normally the vertical deflection factor and  $\Delta V$  readout values are defined at each input terminal of the oscilloscope. When using the 10:1 probe, you may want to let the readout indicate the signal value as measured at the probe tip. You can do it by changing the scale factors in the following manner:

Press both readout CMNT/CUR switch and MODE switch simultaneously. As you do this, the following will occur.

With the first pressing, the CH1 scale factors are changed.

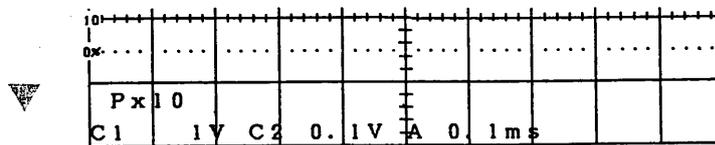

Figure 3-5. The Changed Scale Factor of CH1

With the second pressing, the CH2 scale factors are changed.

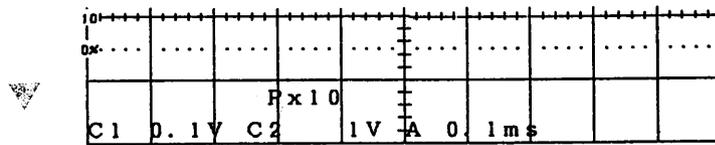

Figure 3-6. The Changed Scale Factor of CH2

With the third pressing, both CH1 and CH2 scale factors are changed at the same time.

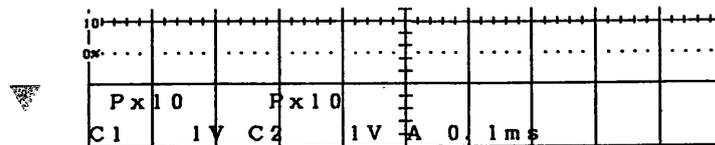

Figure 3-7. The Scale Factors of CH1 and CH2

With the fourth pressing, both CH1 and CH2 scale factors are reset to the unchanged regular scale factors.

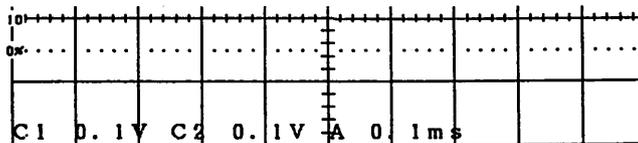

Figure 3-8. The Regular Scale Factors of CH1 and CH2

**NOTE** When you measure a signal voltage with cursors, the measured value is displayed instead of "PX10" message.

## Chapter 4. OPERATION METHOD

### 4.1 Real Mode

This section describes the functions and operation method for Real Mode, introducing some examples of actual measurements.

#### 4.1.1 Vertical Axis

If the oscilloscope is in the initial setup (Table 3-1, page 3-1), the signals of both channels are simultaneously displayed on the CRT screen. You can adjust the signal waveforms to easily readable amplitudes with the VOLTS/DIV and VARIABLE (hereafter, abbreviated as VAR) knobs. Whenever accurately measured values are needed, set the VAR knobs to their CAL'D positions (fully clockwise).

**NOTE** *If you use 10:1 probes, change each scale factor and perform the phase compensation adjustments. Refer to Chapter 3, (3) Probe Phase Compensation (page 3-3) and (4) Changing Scale Factors When Using Probes (page 3-5).*

##### (1) Selecting an Input Coupling

- Generally select the DC coupling.
- When you measure an AC signal which includes a DC component, select the AC coupling.
- When you check the zero-volt level on the CRT screen, set the input coupling switch to  $\perp$  (GND coupling).

**NOTE** *Note that the AC coupling will cause certain frequency response limit characteristics on lower frequencies.*

##### (2) Selecting Display Channels

- When you use the single channel trace, press the CH1 or CH2 switch you want to use.
- When you use both channels, press the DUAL switch.
- If no switch of VERT MODE is being pressed, the oscilloscope will automatically select CH1.
- When you press the CH1 and CH2 switches simultaneously, the oscilloscope will display the sum of the both signals (ADD).

**(3) Selecting a Sweep Mode (Chopping or Alternate Mode)**

To display DUAL channel traces on the CRT screen, each trace is switched among the two channels in a time-sharing manner—either in the Chopping or Alternate mode.

**Chopping mode:** Each trace is switched among the two channels with a chopping rate of approximately 500kHz. You should select this mode when the sweep speed is 1ms/DIV or slower. Otherwise the displayed image will flicker when the signal frequency is low.

**Alternate mode:** Each trace is switched each time one complete sweep cycle of each channel is complete. You should select this mode when the sweep speed is faster.

When the trigger SOURCE switch is set to VERT position, the oscilloscope automatically selects the Alternate Trigger mode. The trigger sources are switched among the respective channels for each trace. Thereby you can see the stationary waveforms of two signals even if they are not mutually synchronized.

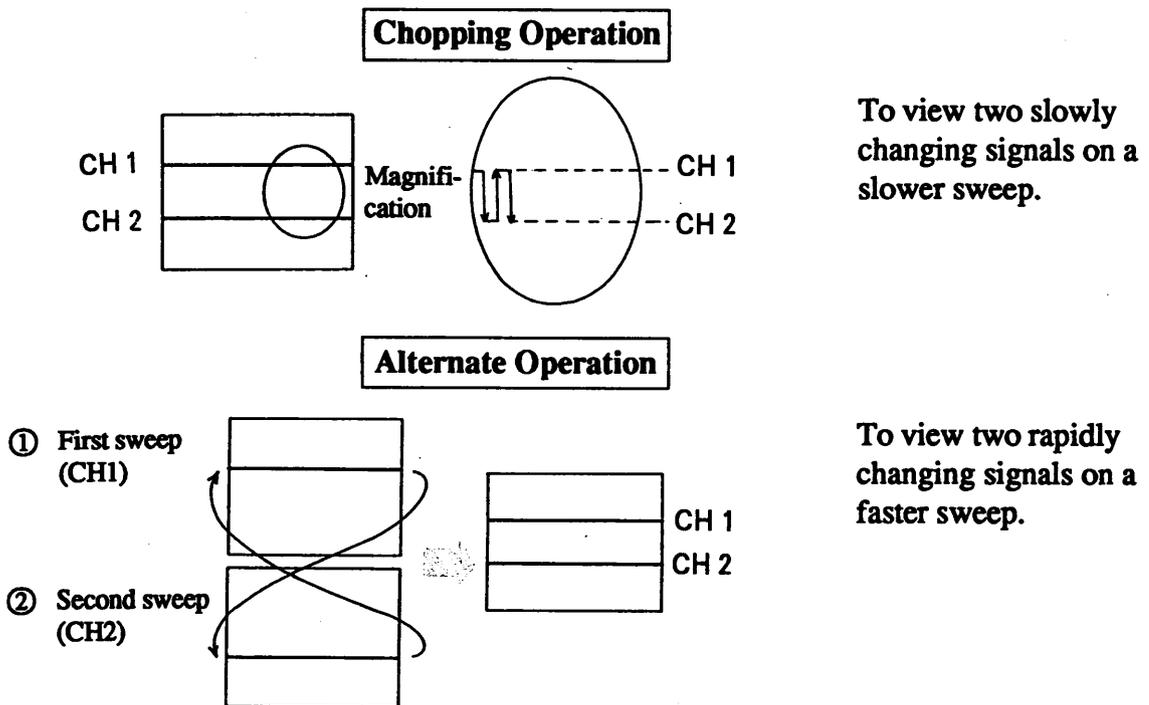

Figure 4-1. Alternate Mode and Chopping Mode

**(4) Selecting the Addition mode**

- To select the Addition mode, press the CH1 and CH2 switches simultaneously.
- In the Addition mode, the oscilloscope displays the sum of CH1 and CH2 signal.
- If you want to view the subtraction remainder of CH2 from CH1 signal, press the INV (invert) switch too.

**Selecting Addition**

Figure 4-2. Addition of Signals

**Selecting Subtraction**

For example, you can use this mode when you want to eliminate needless components from the signals and to determine the meaningful differential component alone, such as for common-mode signal rejection.

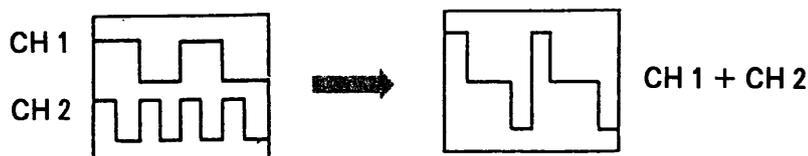
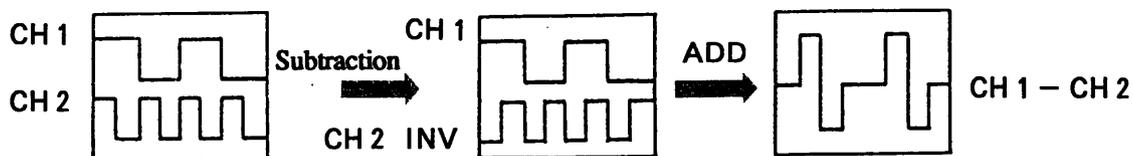

Figure 4-3. Subtraction of Signals

**Notes for the ADD Mode**

- Be sure that the input voltages of each channel do not exceed the allowable maximum range. This is especially true when determining the difference among the two signals.
- It is possible to move the waveform vertically either with the CH1 or CH2 VERT POSITION knob. However, you should position both knobs evenly, because the widest vertical dynamic range is attained at the center of CRT screen.
- If the TRIG SOURCE switch is placed at VERT position, the CH1 input signal is used for the trigger source signal.
- Measured data on the vertical axis with the cursors are displayed in DIV unit even if a VAR knob is set at CAL'D position. Then you cannot measure any voltages with cursors.

## 4.1.2 Triggering

Proper triggering is vitally important for proper operation of the oscilloscope. It is essential to understand how to trigger for making efficient use. The essentials of triggering are described here.

### Triggering Procedure

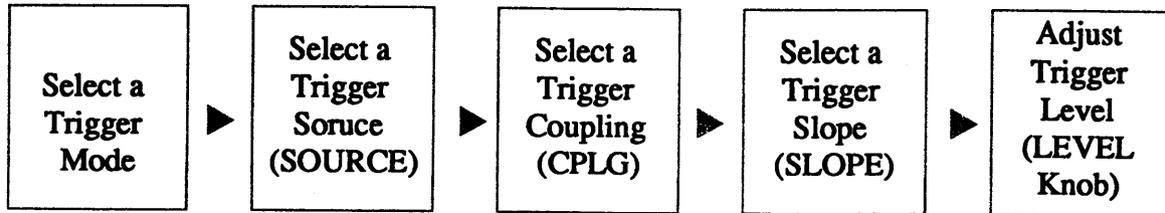

#### (1) Selecting a Trigger Mode

Select one of the modes mentioned below.

##### AUTO

Even if no trigger signal is applied, the sweep runs automatically at a certain rate. When a trigger signal is applied, the sweep will be triggered by the input signal.

**NOTE** When no external signal is applied or the trigger frequency is lower than 50Hz, the sweep runs freely—which is called as “free-running” state.

##### NORM

This mode is used for viewing low frequency signals less than 50Hz or phenomenal events.

**NOTE** The sweep runs only when triggered by external signal. When no trigger signal is applied, the sweep circuit keeps standby and no traces will appear on the CRT screen.

##### SINGLE

This mode is used for viewing unstable signals which cannot be stationary. This mode is also used to capture Single-shot signals.

**NOTE** The sweep runs only once when triggered by an external signal. For the subsequent sweep, you must press the RESET switch to return the trigger circuit to standby—the READY LED will light up while standby.

**(2) Select a Trigger Source (SOURCE Switch)**

To display and measure a stationary waveform, the signal itself or another synchronized signal must be applied as a trigger signal. The SOURCE switch selects a trigger signal source for this purpose.

Table 4-1. Trigger Signal Source Selection

SOURCE	VERT MODE	TRIGGER SIGNAL SOURCE
VERT	CH1	CH1
	CH2	CH2
	DUAL/ALT	CH1 and CH2 alternately
	DUAL/CHOP	CH1
	ADD	CH1
CH1	CH1, CH2, DUAL, ADD	CH1
CH2	CH1, CH2, DUAL, ADD	CH2
EXT	CH1, CH2, DUAL, ADD	EXT

**VERT:** When the oscilloscope operates the single trace mode, the input signal selected by VERT MODE switch is used as the trigger source automatically.

In the dual-trace Alternate mode, the CH1 and CH2 input signals are used as the trigger source signals for respective channels.

**NOTE** When the Trigger SOURCE switch is placed at VERT, note the following:

- (a) The VERT mode is not applicable to measure the phase difference among two signals.
- (b) When the Trigger Mode is NORM, the sweeps can run only when both input signals are applied and work as trigger signals.
- (c) The Alternate Trigger function might not work correctly when in the LEVEL AUTO state. (About LEVEL AUTO, it is explained later in this section.)

When viewing two signals which are mutually synchronized in any manner, you should select only one trigger source signal so that the two signals are displayed allowing you to determine the time relationship among them.

**CH1:** The CH1 input signal is used for the trigger source.

**CH2:** The CH2 input signal is used for the trigger source.

**EXT:** A signal applied to the EXT INPUT terminal is used for the trigger source.

**(3) Selecting a Trigger Coupling (CPLG Switch)**

Select Trigger Coupling which works as a trigger filter to suit the type of input signal.

**AC:** Most signals can be viewed with this coupling. Because this coupling eliminates DC component of the trigger signal, stable triggering can be attained without being affected by variance of DC component.

- (NOTE)**
- (a) Triggering might transiently become asynchronous when DC component changes sharply.
  - (b) This coupling attenuates the components of DC range (lower than 10 Hz). If the trigger signal frequency is lower than 10 Hz, use the DC coupling.
  - (c) When in the LEVEL AUTO, the AC coupling is automatically selected irrespective of setting of this switch.

**HF:** The HF coupling is identical with the DC coupling but, the HF eliminates the high frequency components (50kHz and above) of the trigger signal. For example, you may find the HF coupling to be useful when viewing a low frequency signal which includes high frequency noises.

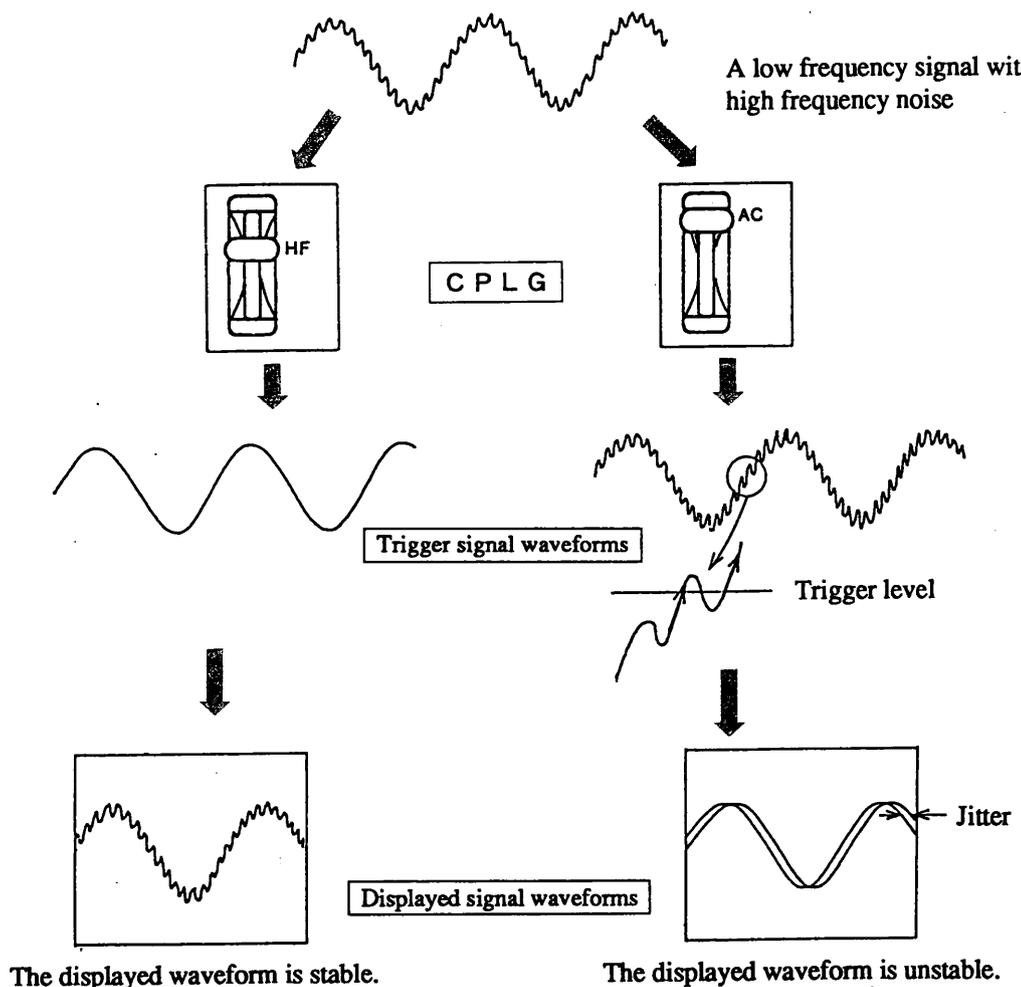

Figure 4-4. Trigger Signal Coupling

**DC:** The trigger source circuit is directly coupled to the trigger signal, without any conditioning on the trigger source signal. You may use this coupling to view DC components, very low frequency pulse signals, and pulse signals of large duty ratios.

**TV:** This coupling is provided especially for viewing video signals. In this coupling, the sweep is triggered by the horizontal or vertical synchronization signal picked off from the video signal to be viewed. Thereby, you can view the video signal very stably.

Selection between TV.H (for triggering horizontal synchronization) and TV.V (for triggering vertical) is linked to the timebase setting. The TIME/DIV switch selects one of those TV triggerings automatically.

**TV.V** : Timebase range 0.1ms/DIV through 0.5s/DIV (5s/DIV)  
 (The value enclosed in the parentheses is for the COR5501U or COR5561U operating in Storage Mode.)

**TV.H** : Timebase range of 20ns/DIV (50ns/DIV) through 50μs/DIV  
 (The value enclosed in the parentheses is for the COR5561U or COR5560U.)

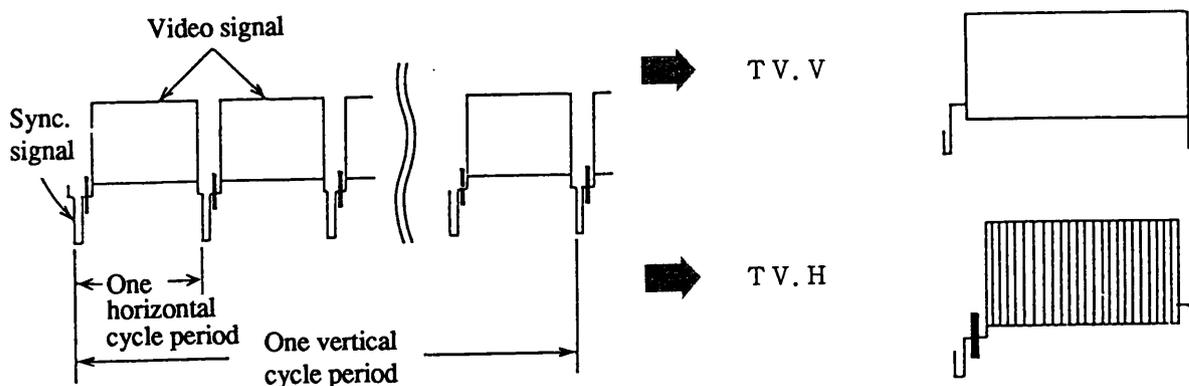

Set the SLOPE switch in conformity with the video signal as follows:

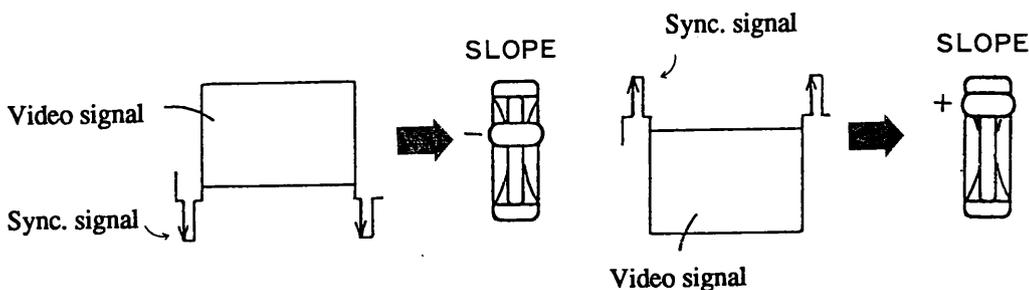

Figure 4-5. Triggering for Video Signals

**(4) Trigger Slope (SLOPE Switch)**

The SLOPE switch selects whether the sweep should be triggered at the positive direction or the negative direction. In other words, the switch selects whether the input signal waveform should appear on the CRT screen starting by a rising or a falling slope.

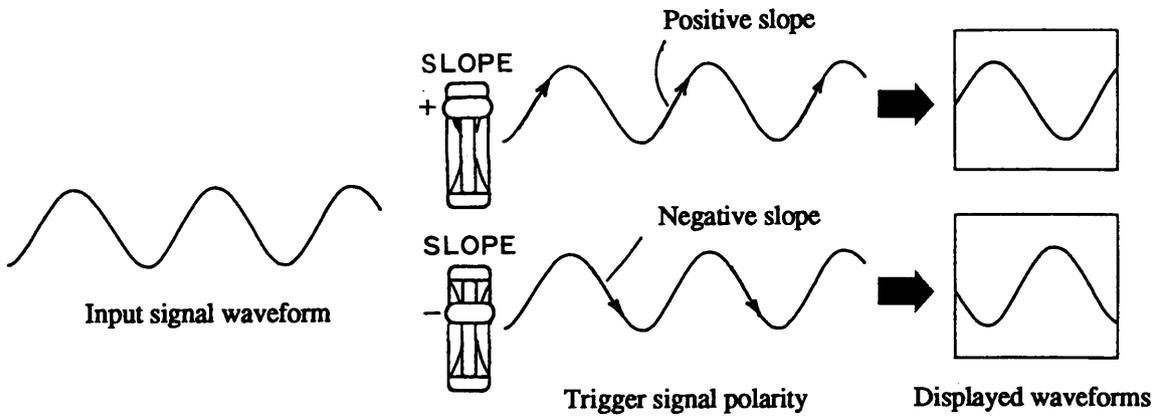

Figure 4-6. Triggering Slopes

Also, the SLOPE switch allows you to select the AC line signal for the trigger source signal, by setting it to the LINE positions. These positions are convenient for viewing signals which are synchronized with the AC line frequency.

### (5) Adjusting the Trigger Level (LEVEL knob)

The LEVEL knob is used to adjust the trigger level to make the displayed waveform more stable and to control the starting point of the sweep. The LEVEL AUTO position (fully counterclockwise position) provides automatic trigger adjustment at an optimal level.

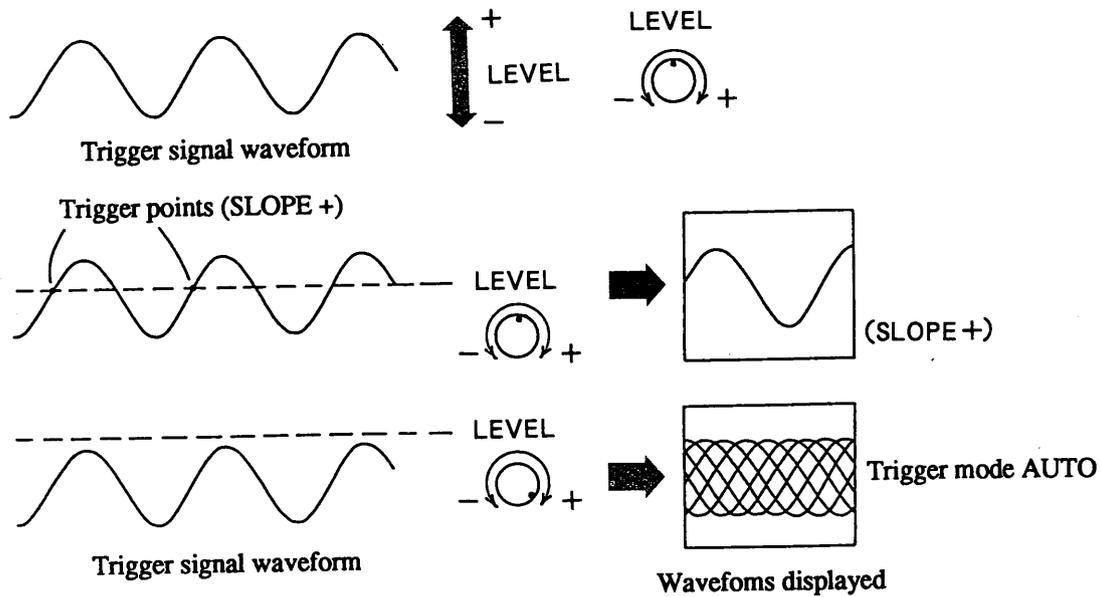

Figure 4-7. Effects of Trigger Level Adjustment

When in the LEVEL AUTO, the positive and negative peaks of trigger signal are detected and the trigger level is automatically maintained at a central position among the both peaks.

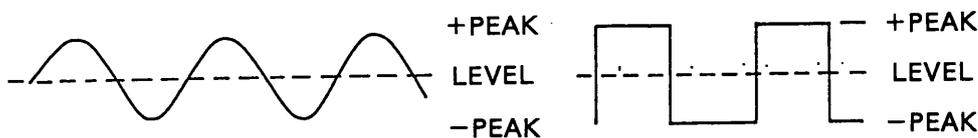

Figure 4-8. The LEVEL AUTO Function

- NOTE** (a) In the LEVEL AUTO, the Alternate Trigger function might not work correctly.
- (b) In the LEVEL AUTO, the triggering sensitivity will become lower than LEVEL manual.
- (c) In the LEVEL AUTO, the AC coupling is automatically selected irrespective of the CPLG switch setting.

**(6) Adjusting the Holdoff Time (HOLDOFF knob)**

The Holdoff function provides a pause period in a sweep time in order to trigger a sophisticated type of signals.

Today's advanced technologies deal with complex digital pulse signals, rather than only with simple signals of single continuous frequency. Typical examples are pulse-coded signals used in the digital audio technology.

A signal which involves two or more repeating periods can hardly be successfully displayed in a conventional manner with the LEVEL control alone as described in the above. The Holdoff function assists you in viewing such complex signals.

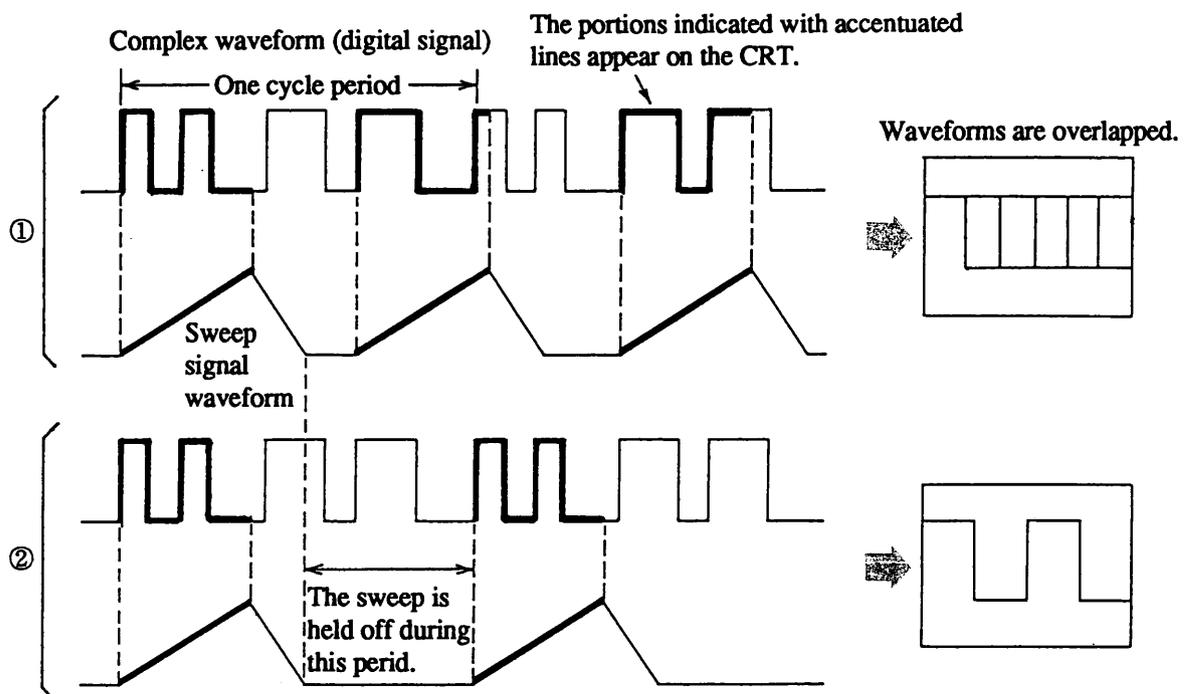

Figure 4-9. The Holdoff Function

Figure 4-9 ① : The displayed waveforms differ by individual sweep cycles. These different waveforms are overlapped as they are displayed on the CRT screen.

Figure 4-9 ② : Overlapping of diversiform waveforms is prevented by using the Holdoff function so that all sweeps start at the same pulse train.

### 4.1.3 Horizontal Axis (Timebase)

#### (1) Sweep Magnification

If you want to view more closely a certain portion of the displayed waveform, you can do it by using the MAG switch. The portion of interest can be horizontally magnified by a factor of 5, 10, or 50 times, with the center of the graticule as the center of magnification. When in this state, the magnification factor and the magnification timebase are displayed on the right hand side of the original timebase as shown in Figure 4-10.

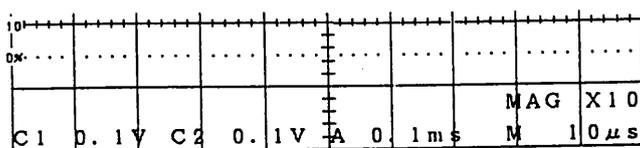

Figure 4-10. Sweep Magnification Data

The  $\times 50$  magnification factor is effective only when in the Real Mode with timebase 0.5μs/DIV through 0.5s/DIV.

**NOTE** Note that the timebase might be inaccurate if you use the  $\times 50$  factor without above conditions.

If you do this, a message

INVALID

will appear on the CRT for about 2 seconds, and a message

UNCAL

will appear at the magnification timebase display position to indicate that the timebase is not calibrated.

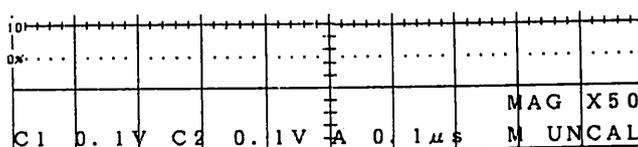

Figure 4-11. Uncalibrated Timebase Magnification

The fastest timebase is attained when the magnification factor is  $\times 10$ .

#### The Fastest Timebases

COR5501U, COR5500U	$20\text{ns}/\text{DIV} \times 1/10 = 2\text{ns}/\text{DIV}$
COR5561U, COR5560U	$50\text{ns}/\text{DIV} \times 1/10 = 5\text{ns}/\text{DIV}$

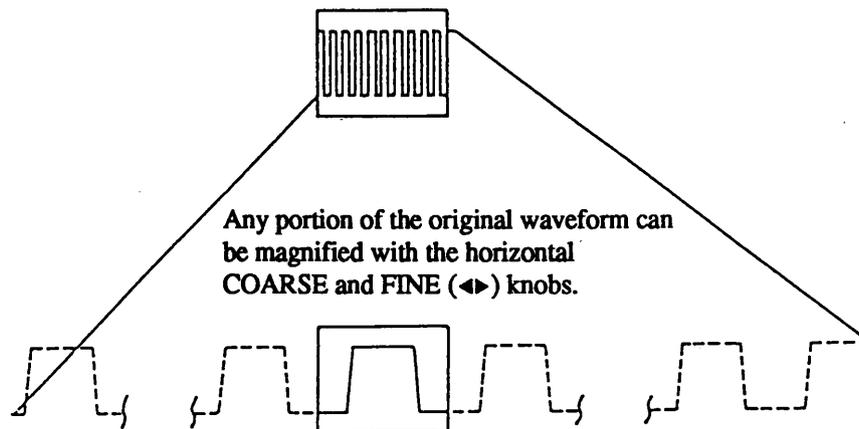

Figure 4-12. An example of Magnified Waveform

### Alternate Magnified Sweeps

- When you press the ALT switch of HORIZ MODE in the Magnification operation, the original waveform and magnified waveform are swept alternately, thereby attaining an Alternate Magnified Sweep mode.
- When in the Alternate Magnified Sweep mode, you can move the magnified waveform apart from the original waveform by up to  $\pm 4$  DIV with the TRACE SEP knob.
- The magnification factor and the magnified timebase are digitally displayed on the CRT screen.
- When the period or frequency is measured with the cursors, the results of measurement on the magnified timebase are also digitally displayed.

### Procedure for Alternate Magnified Sweep Operation

Select Real Mode and set the MAG switch to the  $\times 5$ ,  $\times 10$  or  $\times 50$  position.



Press the ALT switch of HORIZ MODE.

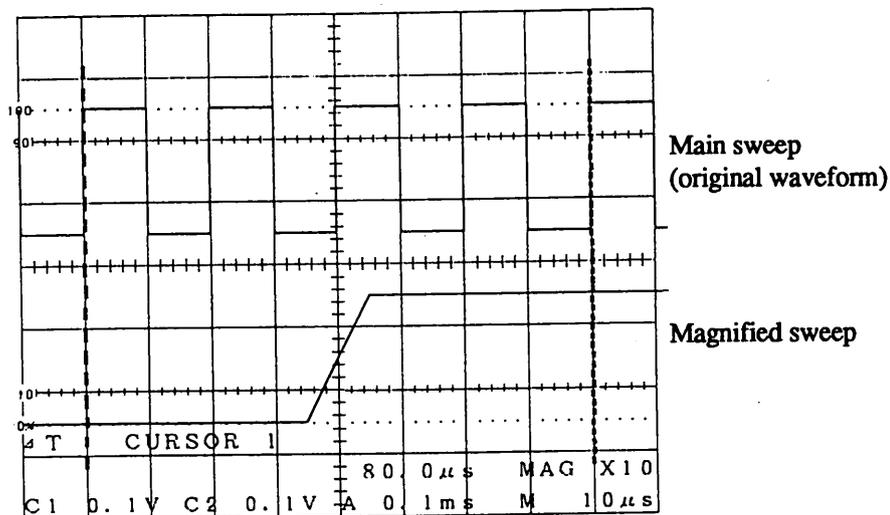
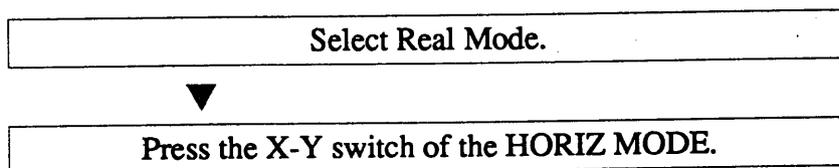

Figure 4-13. Alternate Magnified Sweep Operation

**(2) X-Y Operation**

The X-Y operation allows you to display Lissajous figures to determine the frequency or phase relationship among two signals.

**X-Y Operation Procedure**

- NOTE** (a) *Cursors don't work in the X-Y operation.*
- (b) *The X-Y operation is available on Real Mode only.*
- (c) *When viewing high frequency signals with the X-Y operation, pay attention to the difference of frequency and phase characteristics between X-axis and Y-axis. Also note that phase shifts might result at lower frequencies depending on the coupling mode. Whenever possible, set the input coupling of both axes (channels) to DC.*

**(a) Frequency Measurement with Lissajous Figures**

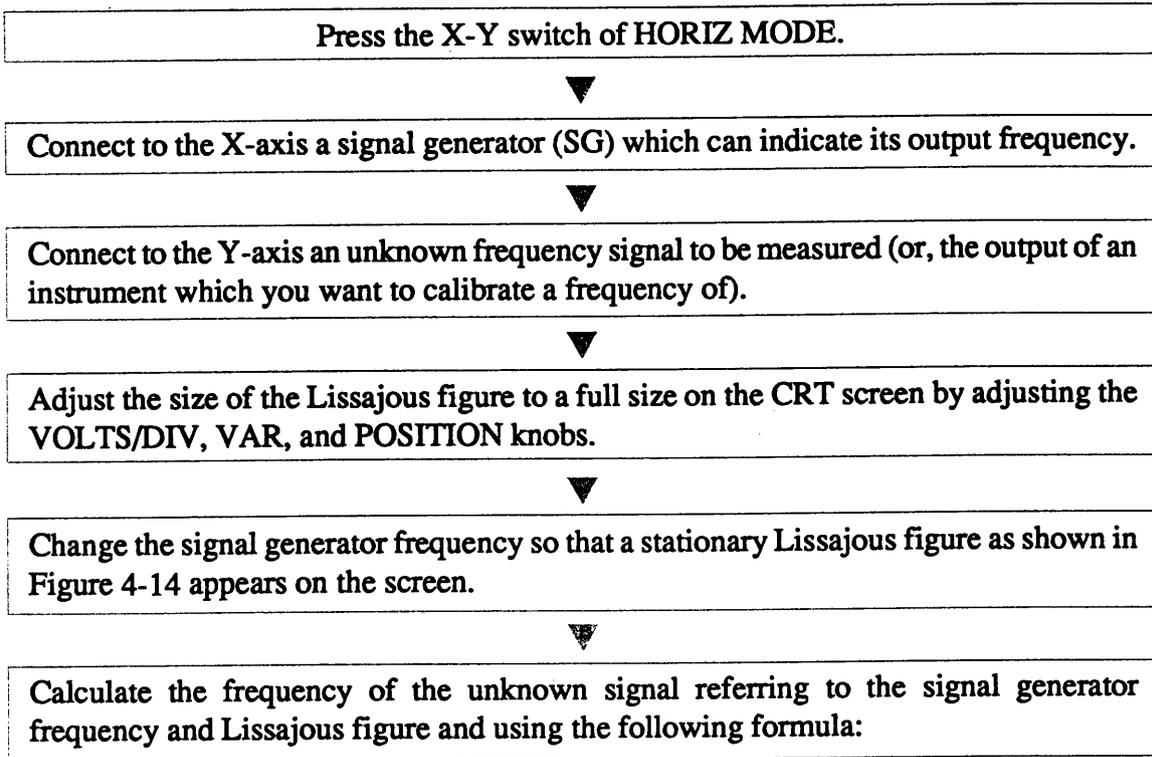

$$\text{Unknown frequency (Hz)} = \frac{\text{The number of crossing points over horizontal scale line}}{\text{The number of crossing points over vertical scale line}} \times \text{Frequency of signal generator (Hz)}$$

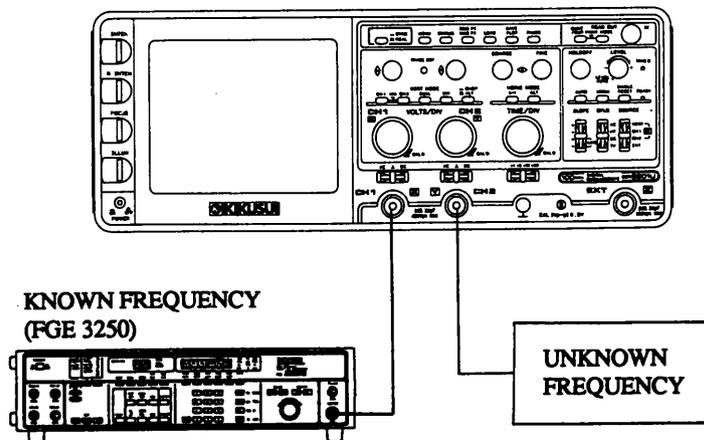
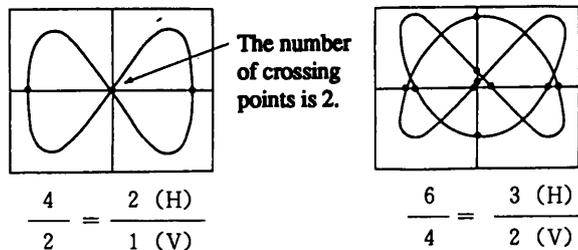
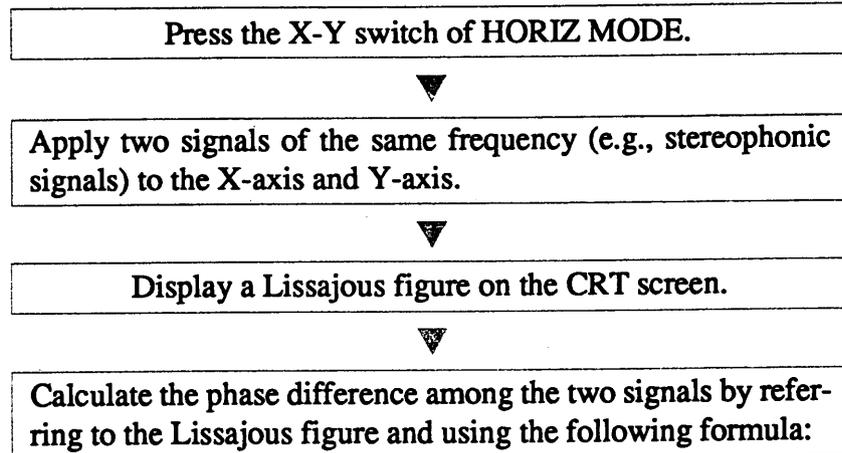

Figure 4-14. Frequency Measurement with Lissajous Figure

**(b) Phase Difference Measurement with Lissajous Figure**

$$\text{Phase difference } \theta = \sin^{-1} \frac{B}{A}$$

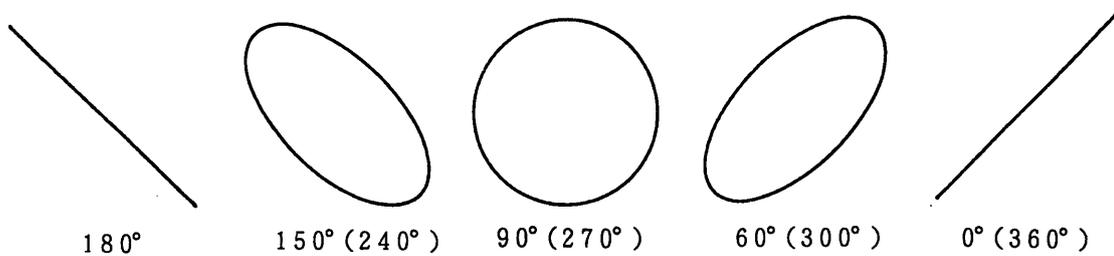
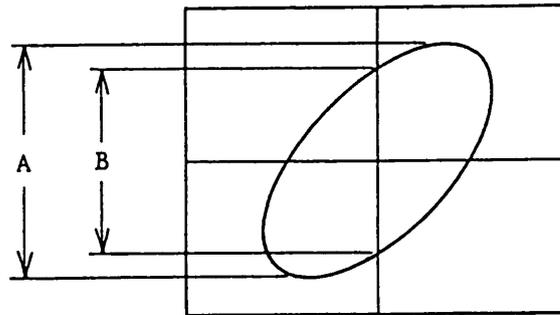

Figure 4-15. Phase Difference Measurement with Lissajous Figures

#### 4.1.4 Z-axis Control

The Z-axis control is used for a trace intensity modulation. By applying to the Z-axis a signal which is synchronized with the vertical signal, intensity-modulated markers can be introduced onto the displayed signal waveform. The intensity becomes higher as a negative voltage is applied to the Z-axis.

The EXT TRIG input terminal is also used in common for the Z-axis input terminal. It acts as a Z-axis input terminal when the TRIG SOURCE switch is placed at the VERT, CH1, or CH2 position.

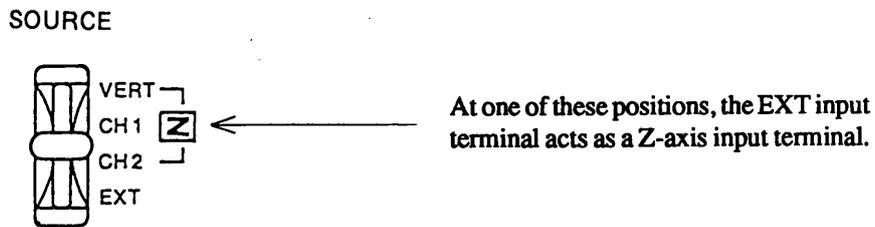

Figure 4-16. Selecting the Z-axis Control Function

**NOTE** *The Z-axis frequency bandwidth is DC to 5MHz. Note that the intensity-modulated points might become inaccurate depending on the input signal frequency and depending on the frequency bandwidth and phase differences as compared with vertical axes.*

## 4.1.5 Comments

The oscilloscope provides a comment display function. You can write your memoranda for measuring conditions, waveform description, and other data. Each piece of comments, which are displayed in the comment area on the CRT screen, may consists of two lines. Each line has up to 32 characters and symbols. The oscilloscope has two comment units, CMNT1 and CMNT2, dedicated to this purpose. The comments stored in the units may be selected and called out whenever you want to use them.

The commented data typically may include the date, measuring conditions, measured object, and operator name. You can take a photograph together with the displayed waveforms appearing on the CRT screen. When you use COR5501U or COR5561U Oscilloscope in Storage Mode, the data can be plotted out by HP-GL commands to a GPIB plotter.

**NOTE** To deliver the data to a GPIB plotter, an optional GPIB interface (IF01-COR) must be attached.

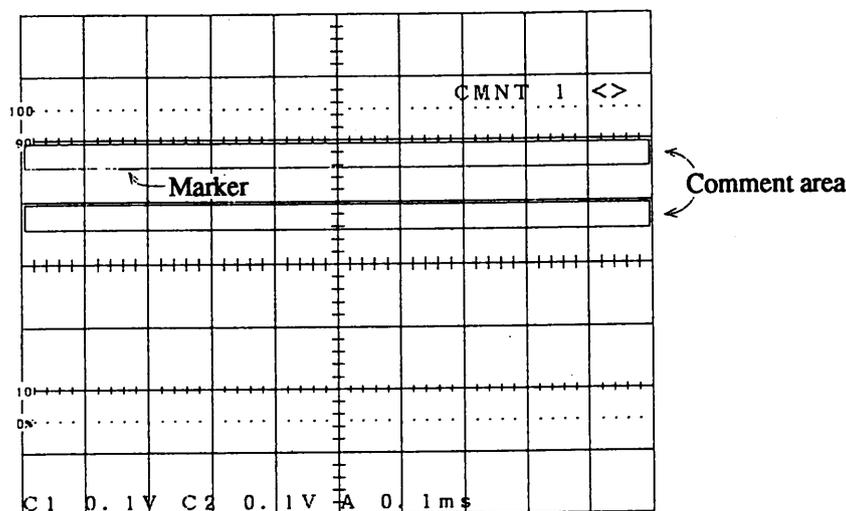

Figure 4-17. The Comment Area

### (1) Entry of Comments

Example of comments: XX. 01. 02  
CH1 SIG

Press the CMNT/CUR switch of READOUT.

▼ A message "CMNT" will appear for about 2 seconds.

Press the MODE switch of READOUT to enter the Comment Entry mode.

▼ Symbols "<>" will appear together with the message "CMNT1" that had disappeared once. A marker will blink at the comment area.

Move the marker to the top of comment text by turning the  knob.



Press the MODE switch.

- ▼ Symbols “<” will be replaced by “SEL” (select), indicating that the Comment Entry function is now in the Character Selecting action.

\*1 Select a character you want to enter, by turning the **SEL** knob.

- ▼ The selected character and the marker will appear alternately.

\*2 Press the **SEL** knob.

- ▼ The selected character will be recognized and the marker will move to the next column.

Repeat Steps \*1 and \*2 to enter all characters of the text.

- ▼ To write a blank space, press the **SEL** knob without turning. You can write continuous spaces by pressing the **SEL** knob many times.

Press the MODE switch twice to exit from the Comment Entry mode.

As you press the MODE switch, the readout message of Comment function changes in the order of < → SEL → SPC → ERS → off. The “off” message is invisible. As the Comment Entry mode is turned off, the “CMNT1” message disappears at about 2 seconds later. By above procedure, entry of the text for CMNT1 is complete.

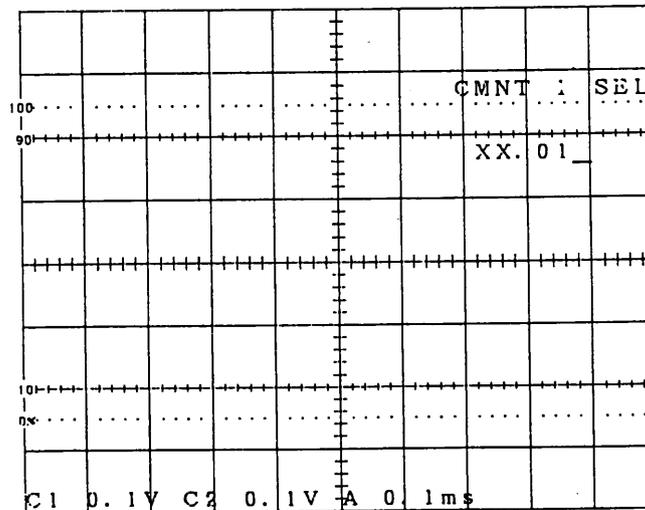

Figure 4-18. Entry of Comments



**(3) Deleting Comments**

**(a) Partial Deletion**

Example of deletion: CH1 SIG → SIG

Press the CMNT/CUR switch and select CMNT1.



Press the MODE switch thrice.



A message "SPC" (space) will appear together with the message "CMNT1" that had disappeared once. A marker will blink in the comment area.

Move the marker to character "C" to be deleted, by turning the knob.



The character and marker will appear alternately.

Press the knob.



Character "C" will disappear. The marker will move to the next column and will be displayed alternately with the next character "H."

Press the knob twice.



Comment text "CH1" will be deleted.

Press the MODE switch twice to exit from the Comment Entry mode.

Now, a partially deleted comment " SIG" will be left in the CMNT1 unit.

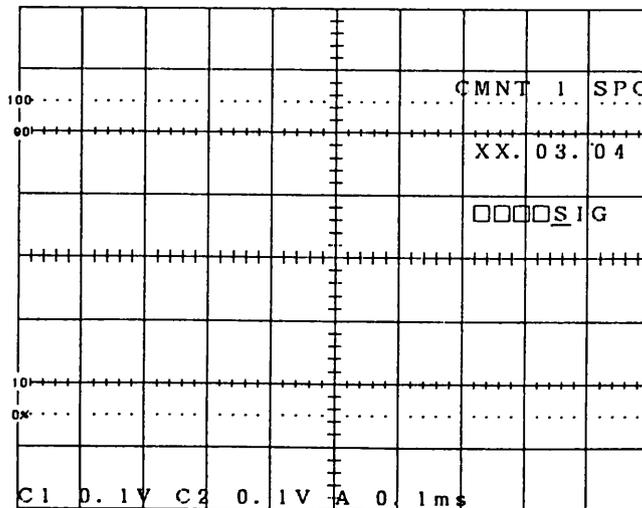

Figure 4-20. Partial Deletion

(b) Full Deletion

Press the CMNT/CUR switch and select CMNT1.



Press the MODE switch four times.



Message "ERS" (erasure) will appear together with "CMNT1" that disappeared once.

Press the  switch.

The contents of CMNT1 will disappear from the screen.

**NOTE** You cannot restore the deleted comment text.

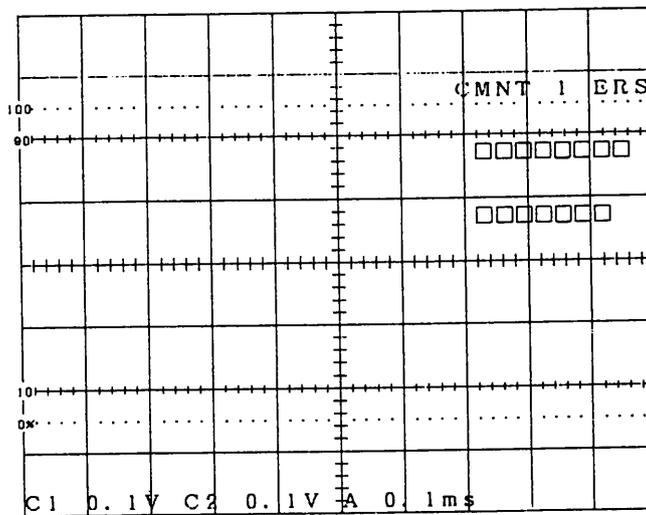

Figure 4-21. Deleting Comments

## 4.1.6 Cursors

The Cursors provide you with measurement functions for voltage, time interval, and frequency. The results of measurement are digitally displayed on the CRT screen.

### (1) $\Delta T$

#### (a) Time Interval Measurement

Here, we explain how to measure the time interval among two points on a displayed waveform. Assume that you want to determine a rise time of pulse waveform. Follow the procedure below:

Adjust the waveform with the VOLTS/DIV, VAR, and POSITION knobs.

- ▼ Adjust the waveform size vertically so that it is displayed as 5DIV and, position it so that the bottom is aligned with 0% graticule and the top with 100% graticule.

Adjust the waveform with the TIME/DIV.

- ▼ Adjust the waveform so that its rise up section can be viewed fully enlarged. You may use the MAG switch if necessary. Be sure that the horizontal VAR knob is at the CAL'D position (fully clockwise).

Press the MODE switch of READOUT to select  $\Delta T$  mode.

- ▼ Two vertical cursor lines (a broken line and a dotted line) will appear, and a message indicating the function of the  knob will appear at lower left on the screen.

By pressing the  knob, select CURSOR1.



By turning the  knob, align the CURSOR1 line (broken line) with the 10% marker on the graticule.



By pressing the  knob, select CURSOR2.



By turning the  knob, align the CURSOR2 line (dotted line) with the 90% marker on the graticule.



The result of measurement will be digitally displayed.

The value shown by Cursors denotes the rise time of the measured pulse signal. If Magnification function is active ( $\times 5$ ,  $\times 10$  and  $\times 50$ ), the displayed value is with the magnification factor taken into account.

**NOTE** If the VAR knob of TIME/DIV is not at the CAL'D position, the value cannot be determined and result will be "?."

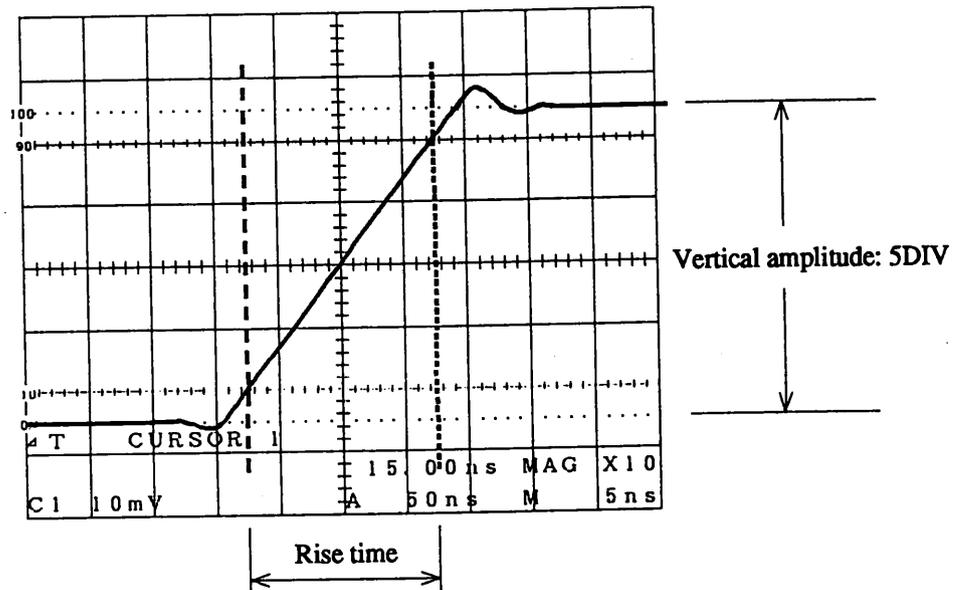
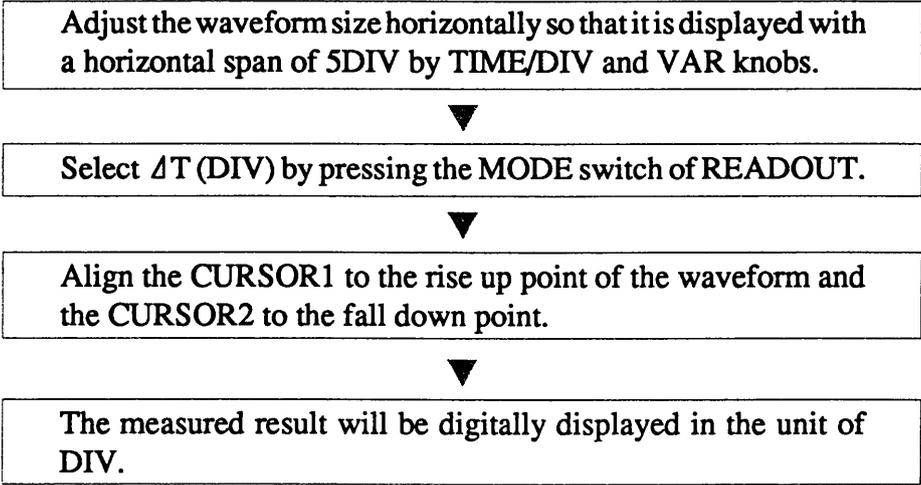

Figure 4-22. Rise Time Measurement

The fall time of a pulse signal can be also measured in a similar manner as above, but setting the Trigger Slope to minus (-).

**(b) Time Interval Ratio Measurement**

Here, you can learn how to measure the duty cycle ratio of a square waveform.



In the above case, taking 5DIV as a reference value, the measured value can be converted into a percent value with respect to the reference value by multiplying the measured value by 20. Since the measured value in this example is 2.55DIV as indicated in Figure 4-23, it can be converted into a percentage as follows:

$$2.55 \times 20 = 51$$

Thus, you can determine the duty ratio is 51:49.

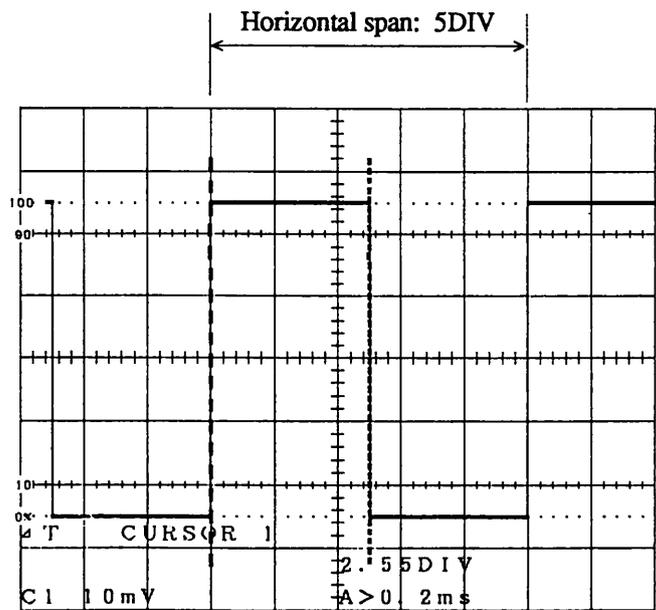
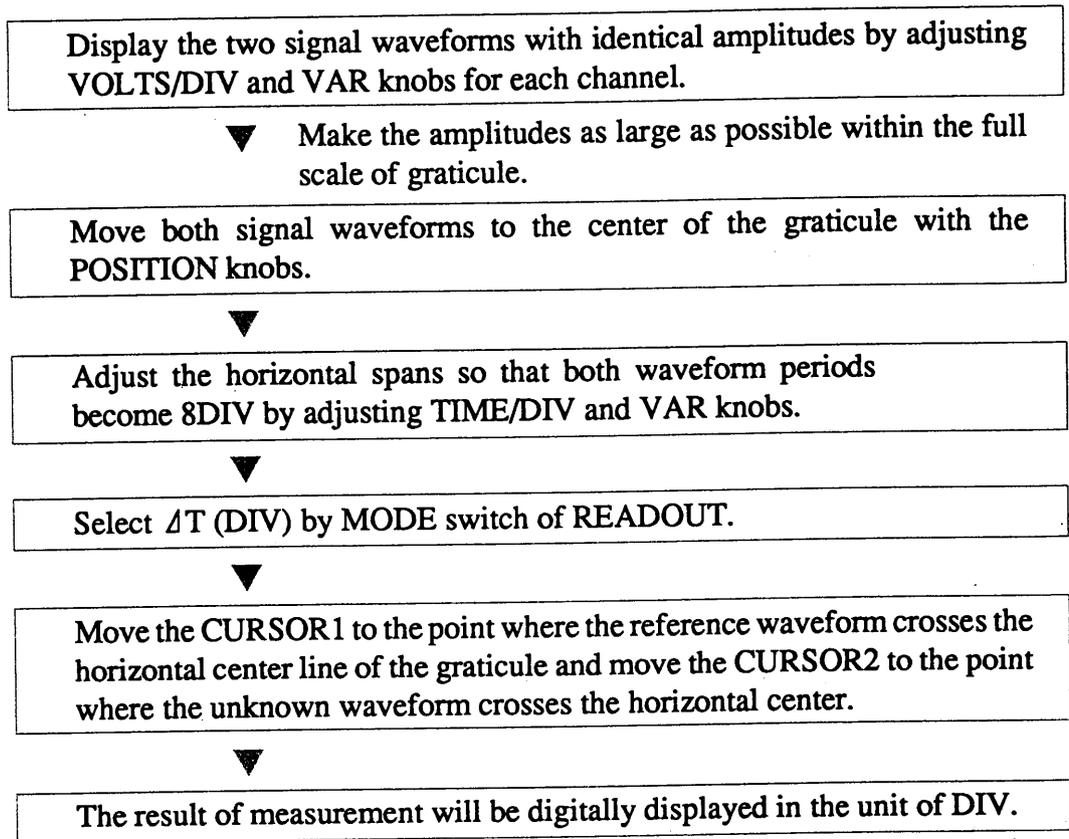

Figure 4-23. Duty Ratio Measurement

**(c) Phase Difference Measurement**

The phase difference among two signals can be measured as described below.



The phase difference per 1DIV is 45 degrees. By multiplying the measured value by 45, the phase difference among two signals can be determined in the unit of degree.

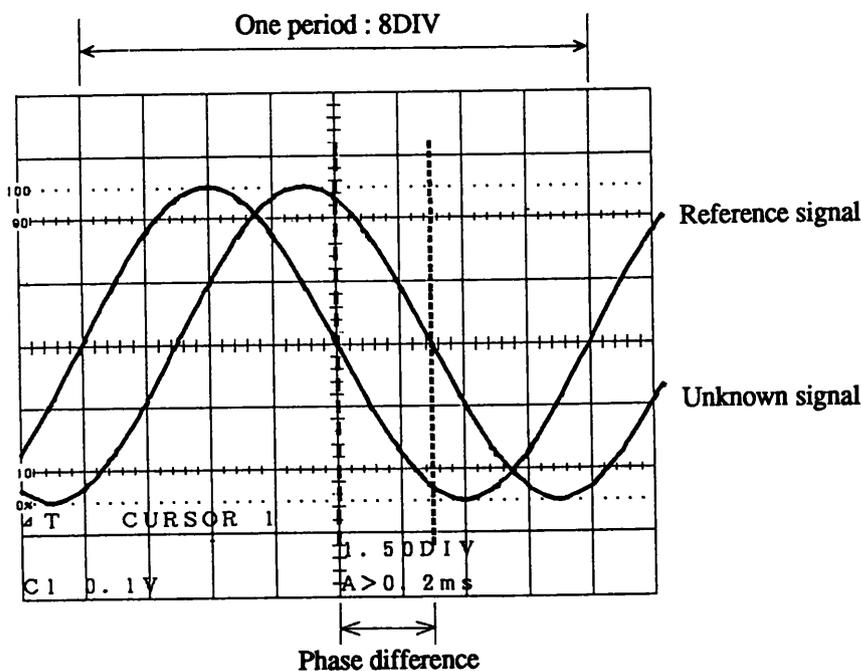

Figure 4-24. Phase Difference Measurement

(2) 1/ΔT

**Frequency Measurement**

Display one period of the waveform with as long wide as possible by adjusting the TIME/DIV knob.

▼ You may use the MAG switch if necessary, but you must set the VAR knob at the CAL'D position (fully clockwise position).

Select 1/ΔT by the MODE switch of READOUT.

▼ Move the CURSOR1 and CURSOR2 to the positions for the one period of the signal waveform.

▼ The result of measurement will be digitally displayed in the unit of Hz.

**NOTE** If the VAR knob of TIME/DIV is at UNCAL position, the value cannot be determined and the result will be "?."

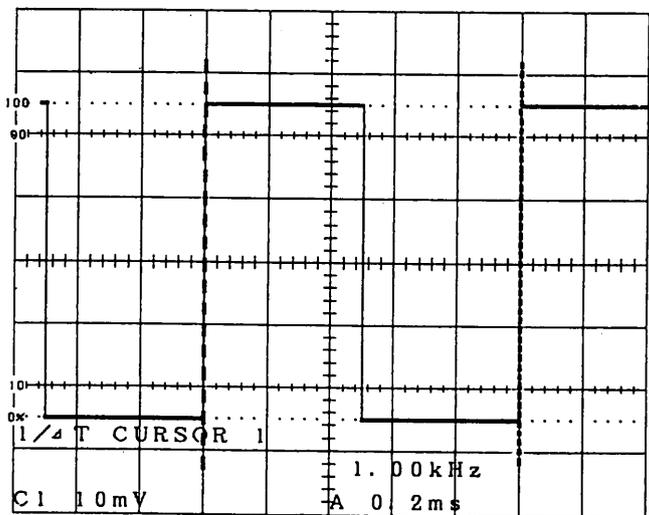

Figure 4-25. Frequency Measurement

(3)  $\Delta V$ 

## (a) Voltage Measurement

Here, we explain how to measure the voltage among two points on a displayed signal waveform. Assume that you want to determine the voltage of sine wave signal waveform.

Adjust the displayed signal waveform with the VOLTS/DIV and VAR knobs.

▼ Make the displayed signal amplitude as large as possible.

Select  $\Delta V$  by the MODE switch of READOUT.

Move the CURSOR1 to the top of the waveform and the CURSOR2 to the bottom.

The result of measurement will be digitally displayed.

**NOTE** If the VAR knob of VOLTS/DIV is set in the UNCAL position, the value cannot be determined and the result will be "?."

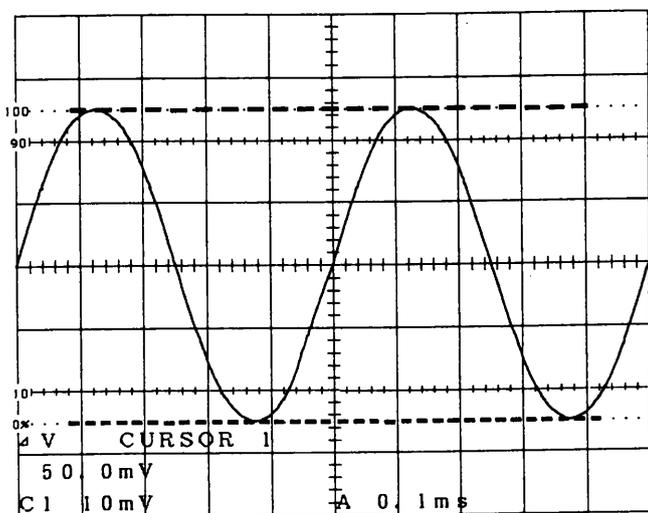

Figure 4-26. Voltage Measurement

**(b) Voltage Ratio Measurement**

Here, you can learn how to measure the voltage ratio, assuming you want to determine the overshoot of a pulse signal.

Adjust the displayed signal waveform with the VOLTS/DIV and VAR knobs.

- ▼ Adjust the waveform size vertically so that it is displayed as 5DIV and, position it so that the bottom is aligned with 0% graticule and the top with 100% graticule.

Adjust the TIME/DIV knob.

- ▼ Adjust the TIME/DIV knob so that the portion you want to look at should be displayed with a sufficient horizontal span. Then, you may use the MAG switch if necessary.

Select  $\Delta V$  (DIV) by the MODE switch of READOUT.



The result of measurement will be digitally displayed in the unit of DIV.

In this case, taking 5DIV as a reference value, the measured value can be converted into a percent value with respect to the reference value by multiplying the measured value by 20. Since the measured value in this example is 0.30DIV as indicated in Figure 4-27, it can be converted into a percentage as follows:

$$0.30 \times 20 = 6$$

Thus, you can determine the overshoot is 6%.

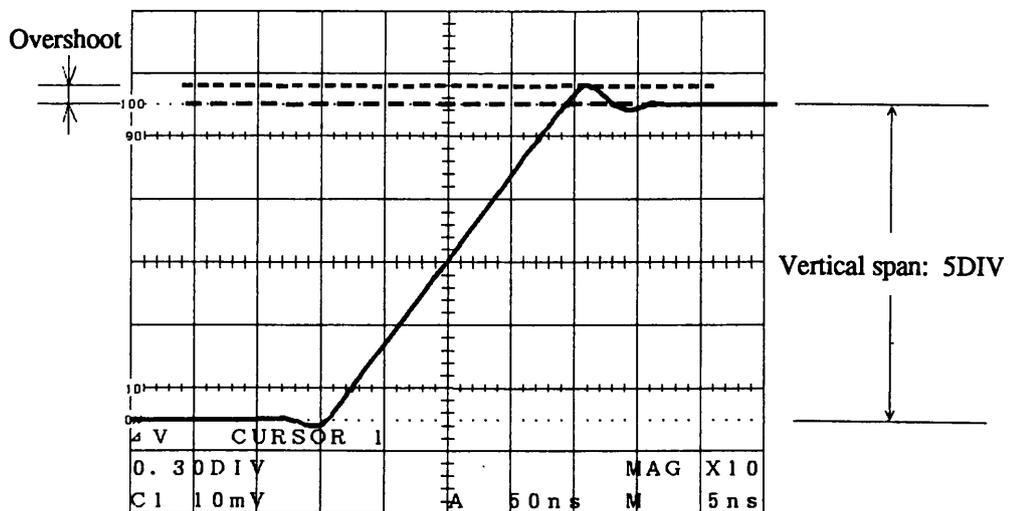

Figure 4-27. Overshoot Measurement

**(4) How to operate the Cursor when a Comment is being displayed**

The MODE switch of READOUT serves two functions, namely, Comment Entry mode and Cursor mode. You can change the cursor function from the Comment Entry mode to the Cursor mode, proceed as described below.

**(a) When a Comment is being displayed.**

Press the  knob.

**(b) When in Comment Entry mode:**

Press the MODE switch to exit from the Comment Entry mode.

▼ Press the MODE switch until no message such of Comment functions appears on the CRT screen.

Press the  knob.

## 4.2 Storage Mode (COR5501U, COR5561U)

This section describes the functions and operations for the Storage Mode of COR5501U and COR5561U, introducing typical examples of waveform viewing.

### 4.2.1 Storage Mode and Real Mode

The differences between Storage Mode and Real Mode are explained here. Storage Mode provides certain functions which are unattainable with Real Mode, however on the other hand, some advantages are provided on Storage Mode. Make yourself familiar with these matters before start using Storage Mode.

#### (1) CRT Control

- Even if the INTEN knob is fixed, the trace intensity might differ between Real Mode and Storage Mode in some timebase ranges. The reason for that is, because the sweep ratio varies depending on the timebase in Real Mode but Storage Mode remains it constant.

This oscilloscope is designed so that the trace intensity becomes identical for both Real and Storage Mode when the INTEN knob is centered (click position) and the timebase is at 1ms/DIV or near.

#### (2) Vertical Axes

- In Storage Mode, the CHOP/ALT switch of VERT MODE is disabled. The signals from both channels are constantly digitized. (Each channel has its own A/D converter.)

#### (3) Triggering

- The Single Trigger mode provides a special feature making use of an advanced function of Storage Mode. Refer to Section 4.2.11 "Single Sweep in Storage Mode."
- The VERT position of the Trigger SOURCE switch is ignored for the dual trace operation. Only the CH1 input signal is used for the trigger source at DUAL mode.
- The Holdoff function is disabled.
- Storage Mode allows you to view the signal waveform which existed before triggering—this is utterly unattainable with Real Model. Refer to Section 4.2.7 "Pretrigger."

**(4) Horizontal Axis (Timebase)**

- Storage Mode offers two display styles, depending on timebase settings. Refer to Section 4.2.2 "Storage Menu."

0.2s/DIV - 5s/DIV : ROLL mode is available.

20ns/DIV (50ns/DIV: COR5561U) - 10 $\mu$ s/DIV : REPETITIVE mode is available.

For details of each mode, refer to respective sections.

- The VAR knob is disabled.
- The X-Y and ALT switches of HORIZ MODE are disabled.
- The MAG switch for sweep magnification is enabled, but only the magnification factors  $\times 5$  and  $\times 10$  are effective. Although  $\times 50$  may be used, the sweep accuracy is not guaranteed. If you select  $\times 50$  in Storage Mode, the following message will appear on the CRT screen for about 2 seconds, alerting you to that the operation is not reliable.

INVALID

In the magnified timebase data display position, the following message will appear alerting you to that the measurement is not reliable.

UNCAL

The basic differences between Real Mode and Storage Mode are described in the above. With a view to understanding the advantageous features of Storage Mode, read the subsequent explanations for more information.

## 4.2.2 Storage Menu

The Storage Menu allows you to select display modes such as Roll, Interpolation, View Time and Repetitive modes.

### (1) Initial Setup of Menu

When the oscilloscope is shipped from manufacturer, the Storage Menu is set up as shown in Figure 4-28.

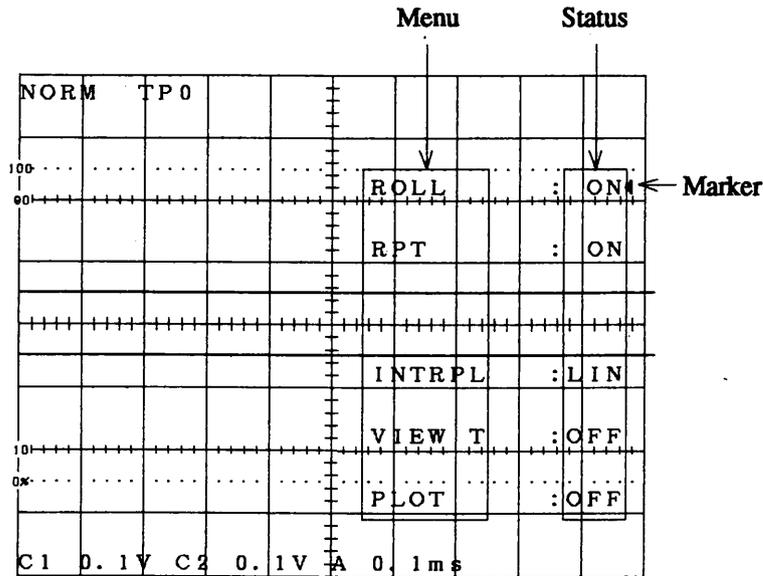

Figure 4-28. The Storage Menu

**NOTE** The "ON" status on Storage Menu means that the corresponding item is available within the specified timebase ranges and other conditions. When the conditions are met, the item is automatically turned on; when the conditions are not met, it is automatically turned off.

**ROLL (Roll Mode)** : 0.2s/DIV through 5s/DIV

**RPT (Repetitive Mode)** : 20ns/DIV (50ns/DIV for COR5561U) through 10μs/DIV

**INTRPL (Interpolation)** : 20ns/DIV (50ns/DIV for COR5561U) through 10μs/DIV

It is available when one of the following conditions is met:

- RPT mode off
- PAUSE MAG mode

**VIEW T (view time)** : It is available when one of the following conditions is met:

- Trigger mode AUTO
- Roll Mode operation at Trigger mode NORM
- RPT mode off

**PLOT (plot)** : To use this feature, an optional GPIB Interface (IF01-COR) must be attached. Refer to IF01-COR's operation manual.

**(2) Setting of Storage Menu**

Here, we explain how to use the Storage Menu, introducing VIEW T (View Time) changing OFF → ON for example. Proceed as follows:

Press the MENU switch.

▼ Storage Menu will appear on the CRT screen.

Further, press the MENU switch thrice.

▼ A marker (◀) will move to VIEW T.

Press the STATUS switch.

▼ The status will change from "OFF" to "ON." The View Time indicator (▲) will appear at upper right on the CRT screen.

Press the MENU switch.

The menu will disappear.

The same setting procedure is also applicable to other mode setting.

NORM	TPO						
100	90				ROLL	:	ON
					RPT	:	ON
					INTRPL	:	LIN
10	0x				VIEW T	:	OFF▲
					PLOT	:	OFF
C1	0.1V	C2	0.1V	A	0.1ms		

Figure 4-29. Setting of Storage Menu

**NOTE** The View Time function is available on the Normal Trigger mode.

### 4.2.3 Roll Mode

The Roll Mode is suitable for viewing a slowly changing signal or a slowly repetitive signal. The waveform scrolls from right to left on the screen—fresh data coming in from the right hand end and old data going out from the left hand end.

**NOTE** The Roll Mode is available for timebase range 0.2s/DIV through 5s/DIV.

The Roll Mode shows different actions depending on the Trigger Mode as shown in Table 4-2.

Table 4-2. Trigger Mode and Roll Mode

Trigger Mode		ROLL Mode
AUTO		Irrespective of the trigger timing, the waveform constantly scrolls from right to left. This mode is suitable to watch variance of signal continuously.
	VIEW T OFF	
NORM	VIEW T ON	After the triggering condition has been met, the waveform scrolls until the trigger point on the waveform reaches the position specified by TRIG PT. When the trigger point has reached the specified position, the waveform stops there for about one second and then resumes scrolling. The waveform is displayed in this stop-and-go manner. Refer to Section 4.2.6 "View Time."
SINGLE		The waveform starts scrolling at the instant you press the RESET switch. After the triggering condition has been met, the waveform scrolls until the trigger point on the waveform reaches the position specified by TRIG PT. Refer to Section 4.2.11 "Single Sweep in Storage Mode."

## Description

In the regular sampling operation, the waveform displayed on the CRT screen is refreshed each time the following data acquisition cycle is completed.

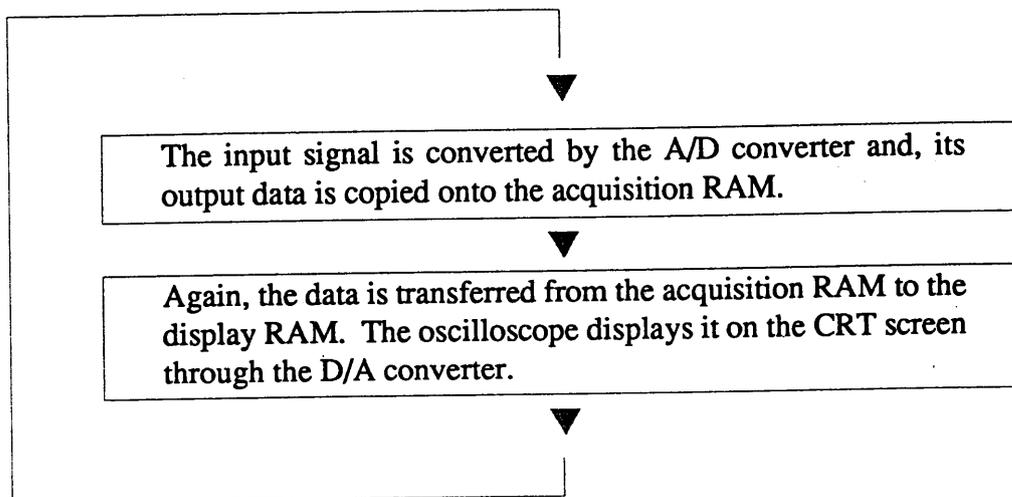

If you attempt to view a very slow repetitive signal on a slow timebase in the regular sampling operation, it will take a substantial time before the entire acquisition RAM is refreshed after the triggering. Therefore, the variance of the waveform is not displayed and you cannot watch it until the entire display cycle is completed.

This problem can be solved by using the Roll Mode, because it displays the waveform on the CRT screen while the waveform data is being transferred onto the acquisition RAM. (Above two sequences work simultaneously.)

The fresh data comes in from the right end and goes out from the left end. Thus, the waveform looks scrolling from right to left on the CRT screen.

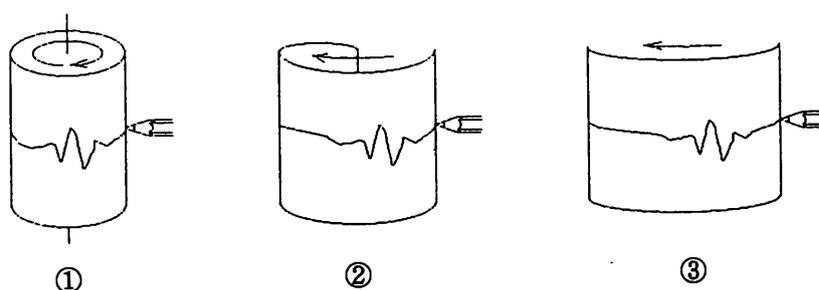

Figure 4-30. Roll Operation

This is analogous to a case that a signal waveform is recorded on a strip-chart pen recorder as shown in Figure 4-30. Assuming a recorder as shown in ①, the waveform for the second and further turns of chart drum will be overwritten on the waveform of the first turn. With the Roll Mode of the oscilloscope, it is analogous to that the waveform of the preceding cycle is erased continuously at the point where the fresh data is written. That is, as the newest data arrives at the right hand end of the displayed waveform pattern, the oldest data departs from the left hand end.

## 4.2.4 Repetitive Mode

The Repetitive Mode is used to digitize a repetitive signal which involves frequency components higher than the maximum Realtime Sampling rate (20MS/s) of the oscilloscope.

- NOTE** • The Repetitive Mode can be used for the timebase range 20ns/DIV (50ns/DIV for COR5561U) through 10 $\mu$ s/DIV.
- The signals which can be digitized with the Repetitive Mode should be stable repetitive signals.

The Repetitive Mode provides a means to digitize a signal which involves frequency components higher than the maximum Realtime Sampling rate. It is equivalent to that the oscilloscope is provided virtually with a faster sampling rate. Thus, this sampling system is often called as “Equivalent Sampling System” as opposed to the “Realtime Sampling System.”

The Equivalent Sampling System of the COR5500U series is Random Sampling System. This sampling system, as well as the Realtime Sampling System, enables the pretrigger function to view waveform portions preceding the trigger point.

For the timebase range 20ns/DIV (50ns/DIV for COR5561U) through 0.1 $\mu$ s/DIV, the oscilloscope employs both Equivalent Sampling and Linear Interpolation in conjunction. Within this timebase range, the realtime sampling data would be as shown in Table 4-3. Skipped data except actually sampled points are supplemented by the Linear Interpolation.

Table 4-3. Sampling Systems and the Numbers of Actual Sample Data Points

Timebase (TIME/ DIV setting)	Sampling rate (samples/sec)	Number of actual sample points (points/DIV)	Sampling system
20 $\mu$ s	20MS	400 points	Maximum Realtime sampling
10 $\mu$ s	40MS	400	Equivalent sampling
5 $\mu$ s	80MS	400	
2 $\mu$ s	200MS	400	
1 $\mu$ s	400MS	400	
0.5 $\mu$ s	800MS	400	
0.2 $\mu$ s	2 GS	400	
0.1 $\mu$ s	2 GS	200	Equivalent sampling with Linear Interpolation
50 ns	2 GS	100	
20 ns	2 GS	40	

The highest frequency range attainable with the Equipment Sampling System is as follows:

COR5501U: 100MHz (–3dB)

COR5561U: 60MHz (–3dB)

- NOTE** The maximum Equivalent Sampling rate of COR5501U and COR5561U shall be virtually 2GS/s and the theoretical frequency bandwidth is calculated to be 200MHz. However, as a matter of fact, it is restricted by the frequency response of the vertical amplifiers of the oscilloscope. (Refer to Section 4.2.12 “Effective Storage Frequency Bandwidth.”)

## Description

Sampling systems are classified into Realtime Sampling System and Equivalent Sampling System. Further, the latter system is classified into Sequential Sampling System and Random Sampling System.

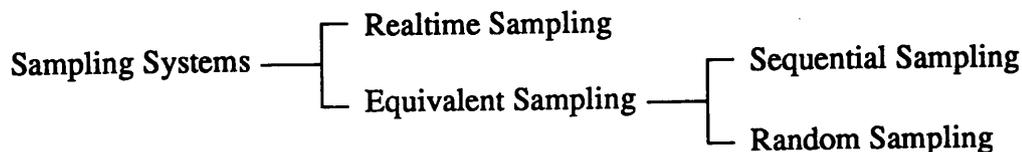

### (1) Realtime Sampling

The Realtime Sampling System samples all the data points which make up one display cycle of waveform in one sampling sequence. This sampling system is suitable for sampling of a signal whose frequency components are not higher than one-half of the sampling rate and for sampling of a non-repetitive signal. If the input signal involves frequency components higher than one-half of the sampling rate, an aliasing might occur.

### (2) Equivalent Sampling

The Equivalent Sampling System samples a part of an input signal per one sampling sequence, and repeats sampling in order to make up one display cycle of waveform. Therefore, the signal to be reproduced by this sampling system should be a stable repetitive signal. Equivalent Sampling System is classified into two systems described subsequently.

### (3) Sequential Sampling

The Sequential Sampling System samples a point at a certain position with reference to the trigger point of input signal per one sampling sequence, and the sampling position is shifted for each sampling sequence. Thus, if one display of waveform consists of 100 points, up to 100 sampling sequences are needed. Since the sampling positions are determined with reference to the trigger point, this sampling system is not applicable to viewing the pretrigger portions of the waveform.

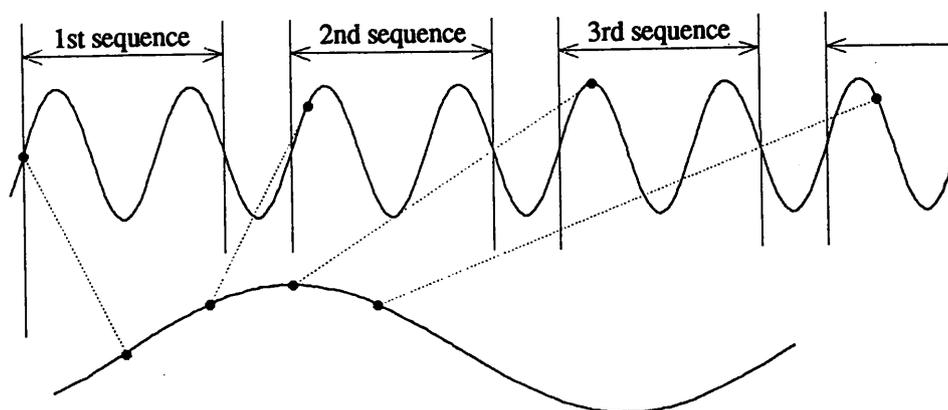

Figure 4-31. Sequential Sampling

**(4) Random Sampling**

The Random Sampling System samples a random point per one sampling sequence, maintaining the timing between the trigger point and the sampling point. This sampling sequence is repeated in order to collect a large number of data and reproduce the original waveform. Since the sampling points are random, the same portion of waveform might be sampled repeatedly. Therefore, the time required for sampling one complete waveform pattern is not accurately predictable. The Random Sampling System, however, allows you to view the pretrigger portions of the waveform as well as the Realtime Sampling System does. The Equivalent Sampling System (Repetitive Mode) of COR5500U series is the Random Sampling.

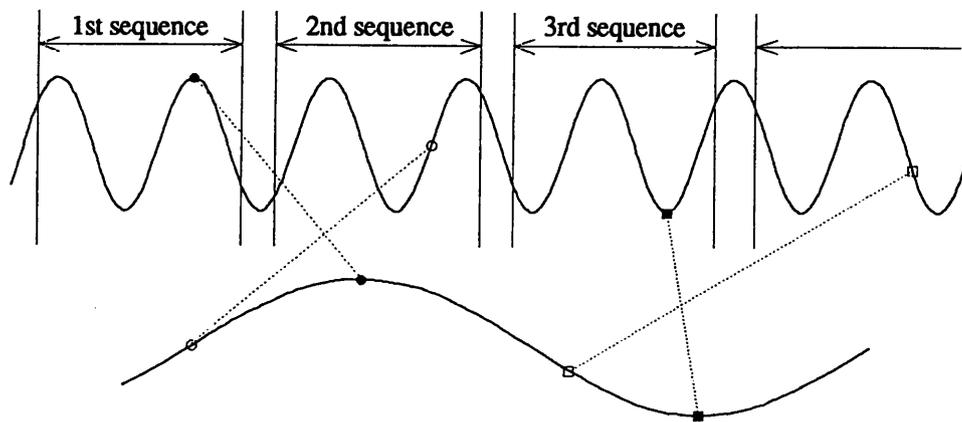

Figure 4-32. Random Sampling

**(5) Aliasing**

According to Nyquist's sampling theory, to reproduce completely an original waveform from digitized data, the sampling rate should be twice of the input signal frequency at least. If this condition is not met, an aliasing will occur. Aliasing is such that, if the input signal includes frequency components which are higher than one-half of the sampling rate (higher than the Nyquist frequency), the higher frequency components are turned into frequencies lower than the Nyquist frequency. Therefore, the original waveform cannot be reproduced.

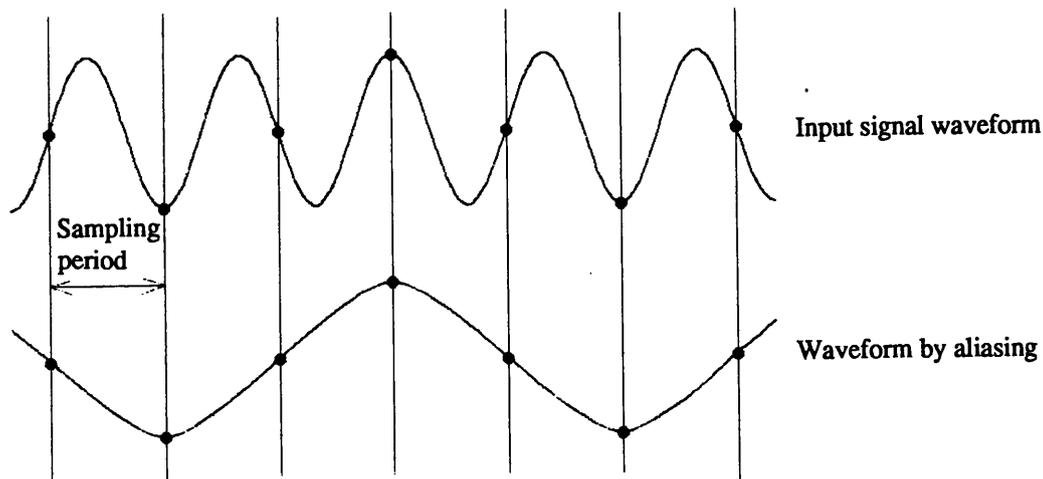

Figure 4-33. Aliasing

In the example shown in Figure 4-33, since the input signal frequency is higher than the Nyquist frequency, the reproduced waveform differs from the original one.

The only way to prevent the aliasing is, to employ a sampling rate twice or more of the input signal frequency or, to eliminate the higher frequency components from the input signal by using a filter (anti-aliasing filter). However, since the maximum available sampling rate is limited, limitations are also imposed on preparing filters which will ensure that the frequency components lower than the Nyquist frequency will not be lost.

The Real Mode enables you to identify whether the aliasing is being generated or not.

Even if the frequency components of input signal in fact are lower than the Nyquist frequency, as they become closer to the Nyquist frequency, the reproduced waveform might apparently become different from the original one. This type of inconformity is not the genuine aliasing but called as "Perceptual Aliasing." A Perceptual Aliasing can occur when a waveform is represented with dots alone and it is assumed to be a continuous waveform attained by connecting all of the two mutually closest points.

The COR5500U series has a vector generator circuit to display waveforms by connecting with a straight line between two data points. Thereby, it can eliminate some Perceptual Aliasing.

## 4.2.5 Interpolation Mode

The Interpolation Mode estimates skipped points of waveform data in order to make up a complete waveform. The Interpolation function is automatically brought into effect when in the Paused Magnification display or when the timebase is 20ns/DIV (50ns/DIV for COR5561U) through 10 $\mu$ s/DIV. However, in Repetitive Mode it does not work. You can select either the Linear Interpolation or the Curve Interpolation. When the oscilloscope is shipped by its manufacturer, it is set to Linear Interpolation.

**NOTE** You must select one of the Interpolation functions at least.

### (1) Linear Interpolation

Linear Interpolation estimates skipped waveform data assuming that two mutually adjoining data points are connected with a straight line. This type of interpolation is used primarily for viewing square waveforms and other pulse waveforms.

**NOTE** When the Linear Interpolation is used for a sine waveform, the original waveform can be almost completely reproduced if ten or more actual sample data are available. If it is less than ten or if peak levels of the original waveform are not sampled, the waveform reproduced with Linear Interpolation might differ from the original one. Refer to Section 4.2.12 "Effective Storage Frequency Bandwidth."

### (2) Curve Interpolation

Curve Interpolation estimates skipped waveform data assuming that data points are connected with a curved line. This type of interpolation is used primarily for viewing of sine waveforms and the like.

**NOTE** When the Curve Interpolation is used for a sine waveform, the original waveform cannot be reproduced if the number of the actual sample data is 3.5 or less. Refer to Section 4.2.12 "Effective Storage Frequency Bandwidth."

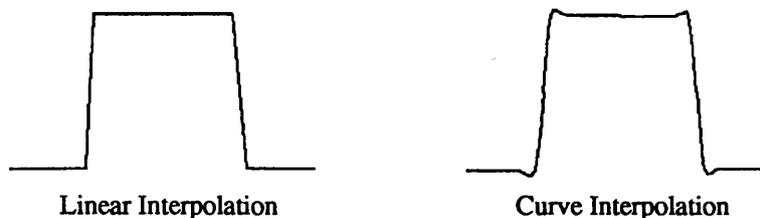

Figure 4-34. Types of Interpolation

## Description

The maximum sampling rate of COR5500U series is 20MS/s (50ns). The waveform line on the CRT screen consists of 400 points/DIV. Therefore, the fastest timebase where the Realtime Sampling Mode works without interpolation is calculated as follows:

$$50\text{ns (maximum sampling rate)} \times 400 \text{ (number of data points per DIV)} = 20\mu\text{s/DIV}$$

If a waveform is digitized by Realtime Sampling when the timebase is faster than 20μs/DIV, the faster timebase becomes, the more insufficient the number of actual sample data points become in order to make up a decent waveform. See the Table 4-4.

When you use the Paused Magnification, the number of actually captured data on the CRT screen will become insufficient for making up a decent waveform as the timebase becomes faster.

In such a case, an Interpolation function becomes active to estimate the skipped data points.

Table 4-4. Timebase and Number of Actually Sampled

Realtime sampling		Paused Magnification	
TIME/DIV	Data points/DIV	Magnification factor	Data points/DIV
20μs	400	× 1	400
10μs	200	× 2	200
5μs	100	× 4	100
2μs	40	× 5	80
1μs	20	× 10	40
0.5μs	10	× 20	20
0.2μs	4	× 40	10
0.1μs	2	× 50	8
50ns	1	× 100	4
20ns	0.4	× 200	2
		× 400	1
		× 500	0.8
		× 1000	0.4

20ns/DIV is available on COR5501U only.

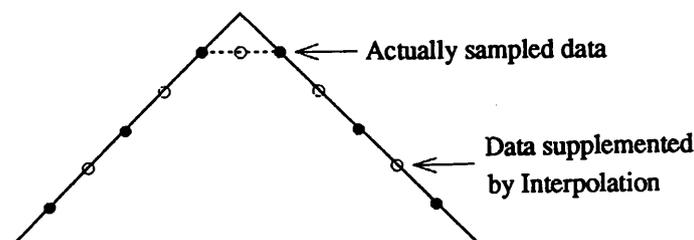
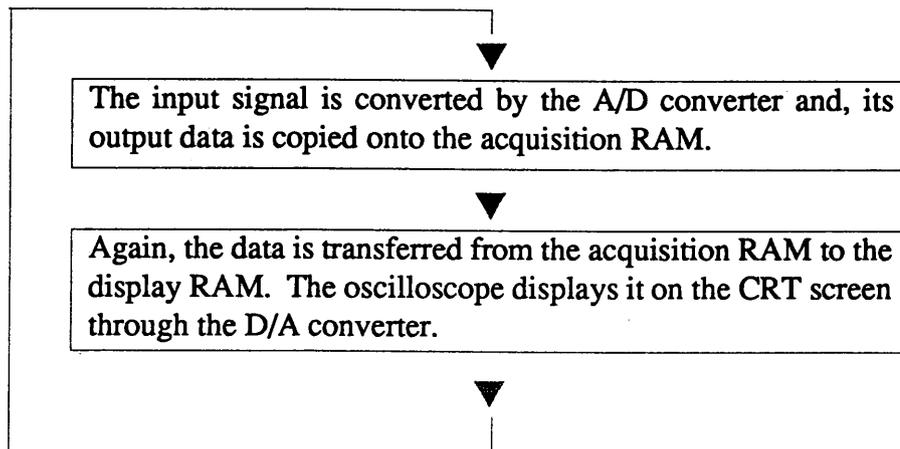

Figure 4-35. Interpolation

## 4.2.6 View Time

The View Time inserts a waiting time among the sequences of each acquisition display cycle. The oscilloscope provides a waiting time of approximately one second for intermittent display of waveforms.

In the regular sampling operation, the waveform displayed on the CRT screen is refreshed by repeating the following data acquisition and display cycle operation. It is previously described.



Acquisition and display cycle (view time OFF)

With the PAUSE switch, you can stop data acquisition and display cycle operation to freeze them at the current cycle. The View Time can pause the cycle operation for about one second and can repeat it successively.

When the View Time is turned on, the View Time indicator (▲) will appear at upper right on the CRT screen.

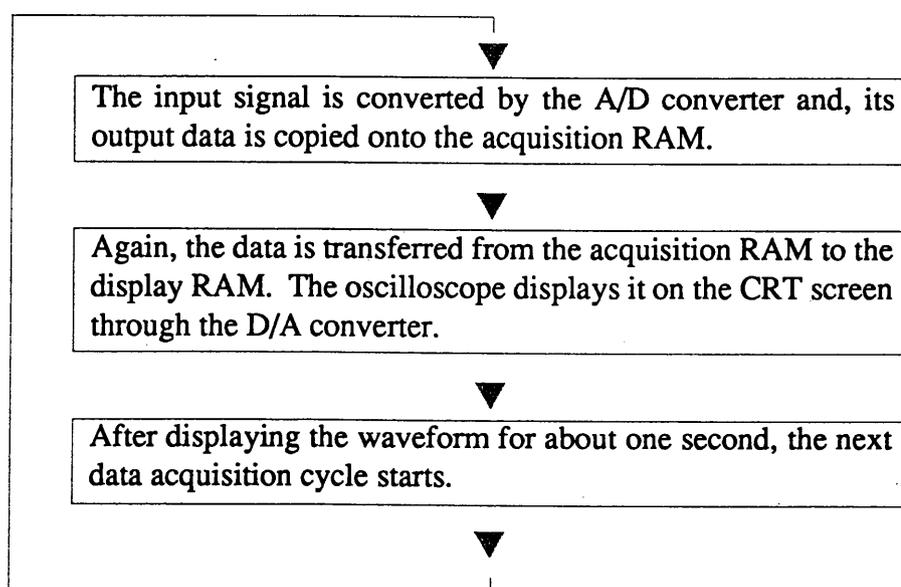

Acquisition and display cycle (view time ON)

### View Time Operation in Roll Mode (Trig'd Roll Mode)

If the View Time is set at ON when the display mode is Roll and the Trigger Mode is NORM, the oscilloscope operates in the Trig'd Roll Mode. The Trig'd Roll Mode works as follows:

The trace scrolls horizontally until the input signal meets the condition for triggering and the trigger point reaches the position on the screen specified by the TRIG PT switch. When the trigger point has reached the specified point, the Roll operation stops. After approximately one second, the Roll operation will resume.

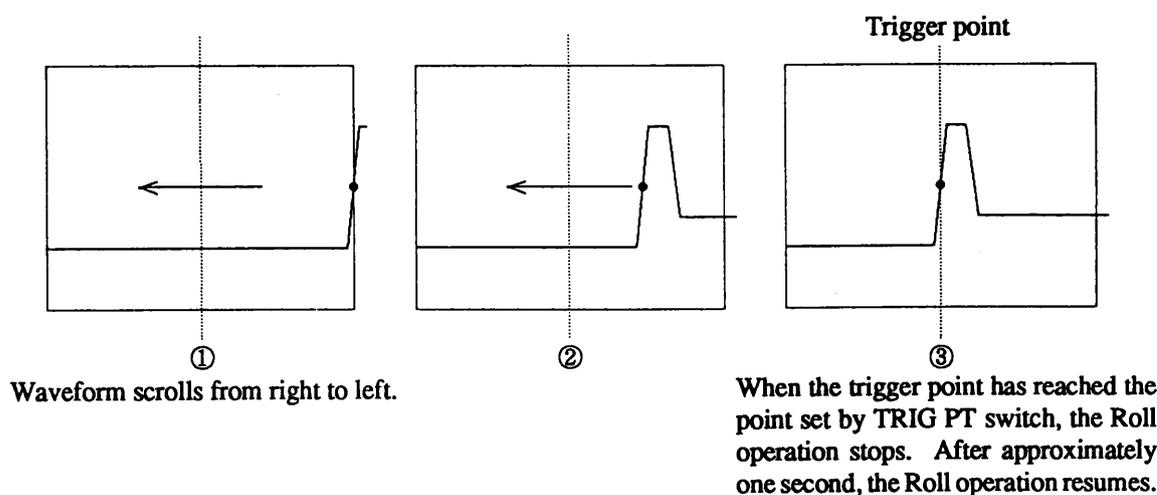

Figure 4-36. Trig'd Roll Operation

**NOTE** The View Time function is disabled when:

- In the Single Trigger Mode
- In the Auto Trigger Mode
- In the Repetitive Mode

*In one of the above cases, even if the VIEWT is set to "ON" on the Storage Menu, the View Time function is automatically turned off. Then, the View Time indicator (▲) on the screen also disappears.*

*When none of the above cases exist, the View Time function is turned on.*

## 4.2.7 Pretrigger

The Pretrigger function allows you to view the waveform preceding the trigger point. The trigger point can be set at 0 (Post Trigger), 1DIV, 5DIV, or 9DIV position on the CRT screen graticule with the TRIG PT switch.

**NOTE** The position of trigger point is based on the starting position of the trace, which is placed at the left end on the graticule.

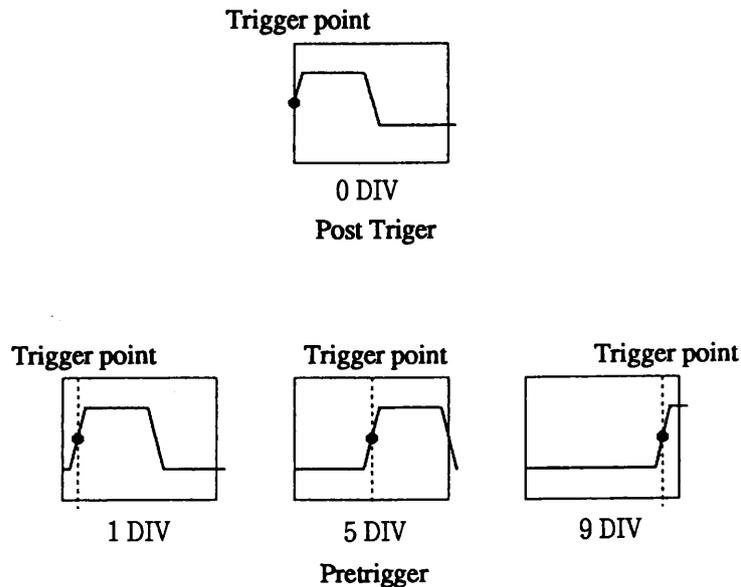

Figure 4-37. Pretrigger

### Description

A conventional analog oscilloscope, including an analog storage oscilloscope that employs a storage-type CRT, cannot view the waveform preceding the trigger point because the sweep starts only after the trigger point. Although delay lines may be used to retard the input signal against the trigger signal in order to show a pretrigger portion of waveform, the maximum practicable delay time is only several hundred nanoseconds.

When this oscilloscope operates in the digital Storage Mode, the input signal is constantly digitized and the trigger signal is used to determine the end of digitizing. Thereby, it allows you to view a waveform preceding trigger point. This operation is named "Pretrigger," as opposed to the "Post Trigger" which shows the waveform after the trigger point similarly to the Real Mode operation.

### 4.2.8 Pause (Suspension of Operation)

The PAUSE function freezes the operation that starts the next acquisition cycle after digitizing and displaying. You may use this function when you want to view a currently displayed waveform for a longer period or when you want to store it onto a Saving Memory.

As you press the PAUSE switch, the acquiring operation will stop and refreshing of waveform will be frozen. When in this state, the following message will appear in the left center on the CRT screen.

PAUSE

To release Pause function, press the PAUSE switch again.

**NOTE** The oscilloscope is automatically released from the paused state when:

- The power is turned off and turned on again, or
- The oscilloscope is changed to Real Mode with the STRG/REAL switch.

Even if in the paused state, you can expand the frozen waveform horizontally with the TIME/DIV switch. (Refer to Section 4.2.9 "Waveform Magnification/Window.")

**NOTE** In the paused state, only the following switches and knobs are enabled:

TIME/DIV (COARSE, FINE)	SAVE/PLOT
MENU	READOUT CMNT/CUR,
STATUS (only PLOT item.)	MODE
MAG PT	
LOAD	

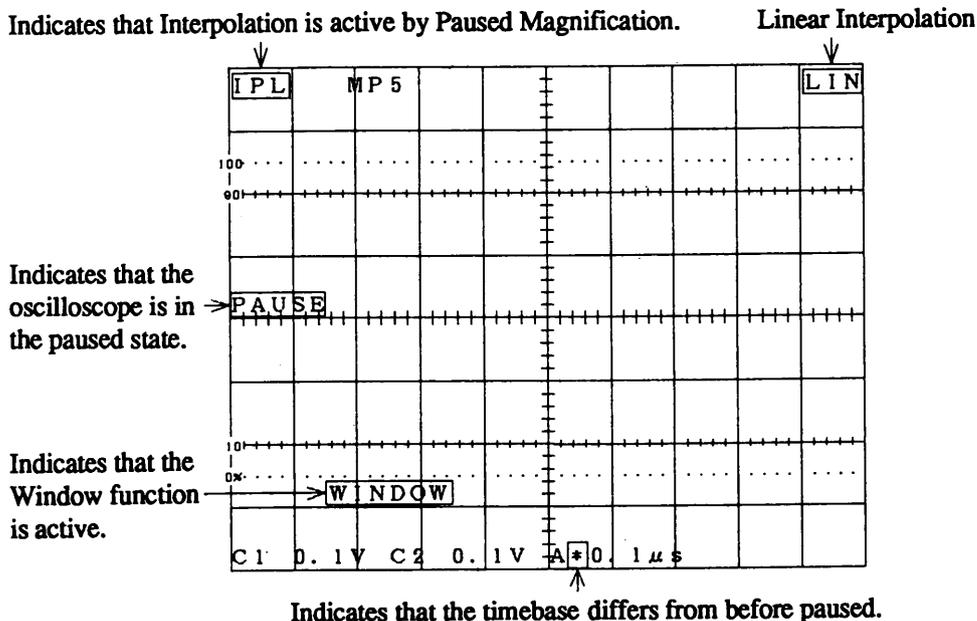

Figure 4-38. Paused Display

## 4.2.9 Waveform Magnification/Window

In the paused state, you can magnify the displayed waveform horizontally. (Paused Magnification)

### (1) Waveform Magnification

Press the PAUSE switch.

- ▼ Data acquisition stops and the displayed waveform is frozen.

Select a Magnification Point by MAG PT. (TRIG PT switch works as MAG PT switch when in the paused state.)

- ▼ Select a magnification point at 0, 1, 5 or 9 DIV. The default Magnification Point is the same position as the TRIG PT specified before paused.

Turn the TIME/DIV switch clockwise.

The waveform will be magnified by a magnification factor corresponding to the ratio between the timebases after and before Pause. The MAG PT decides the center of magnification. You can magnify the waveform up to 9 steps or 1000 times.

$$\text{Magnification factor} = \frac{\text{Timebase after Pause}}{\text{Timebase before Pause}}$$

In the Paused Magnification, an asterisk (\*) appears near the timebase readout on the CRT screen. The asterisk disappears when you select magnification factor at  $\times 1$ .

**NOTE** Waveforms stored in Saving Memories (MEM1 and MEM2) cannot be magnified.

**(2) Window**

In the Paused Magnification (the magnification factor is greater than  $\times 2$ ), the displayed waveform can scroll horizontally.

Select the WINDOW by the MODE switch of READOUT.

▼ The  knob function indication will become "WINDOW."

Turn the  knob.

As you turn the knob clockwise, the waveform scrolls rightward; as you turn the knob counterclockwise, the waveform scrolls leftward.

### 4.2.10 Saving Memory

The Saving Memory stores the digitized waveform data, which can be recalled as needed (e.g., for comparison with the input signal waveform). COR5500U series oscilloscope has two Saving Memory units, namely "MEM1" and "MEM2," each has a 4k words capacity. The Saving Memory is backed up by a battery and the stored data will not be lost even if the oscilloscope is turned off.

(1) To store the waveform data, proceed as follows:

Press the PAUSE switch.

▼ The storage operation will be frozen.

Press the LOAD switch to select a Saving Memory.

▼ Each time as you press the LOAD switch, the Saving Memory selection will advance in the order of MEM1 → MEM2 → MEM12 → off and the existing waveform data will be displayed. MEM12 means that the waveforms of both MEM1 and MEM2 are displayed simultaneously.

Press the SAVE switch.

▼ Then, a new waveform data will be stored. This waveform data can include the vertical position data before saved. By this action, the previous waveform data should be lost.

**NOTE** After you have stored a new waveform, you cannot resume previous one anyhow.

The data to be stored are assigned to the memory units depending on the setting of the VERT MODE switches and the loaded states of the Saving Memory units as shown in Table 4-5.

Table 4-5. Assignment of Saving Memory Units

	MEM1	MEM2	MEM12
CH1	CH1 waveform is stored in MEM1.	CH1 waveform is stored in MEM2.	CH1 waveform is stored in MEM1 and MEM2.
CH2	CH2 waveform is stored in MEM1.	CH2 waveform is stored in MEM2.	CH2 waveform is stored in MEM1 and MEM2.
ADD	ADD waveform is stored in MEM1.	ADD waveform is stored in MEM2.	ADD waveform is stored in MEM1 and MEM2.
DUAL	CH1 waveform is stored in MEM1.	CH2 waveform is stored in MEM2.	CH1 waveform is stored in MEM1 and CH2 waveform is stored in MEM2.

**(2) Saving a Magnified Waveform Data**

You can also store a magnified waveform data onto the Saving Memory. To do this, execute the saving procedure when the waveform is displayed in Paused Magnification State. The stored timebase data will be a magnified timebase.

**NOTE** The magnification factor is not stored.

**(3) To recall the waveform data, proceed as follows:**

Press the LOAD switch to select the Saving Memory.

Each time as you press the LOAD switch, the Saving Memory selection will advance in the order of MEM1 → MEM2 → MEM12 → off and the existing waveform data will be displayed.

COR5500U series oscilloscope allows you to view the both saved waveforms together with the current CH1 and CH2 waveforms—four waveforms in total at the same time. It also allows you to view the stored waveforms in the Roll Mode.

**NOTE** The saved waveforms do not scroll in the rolling manner.

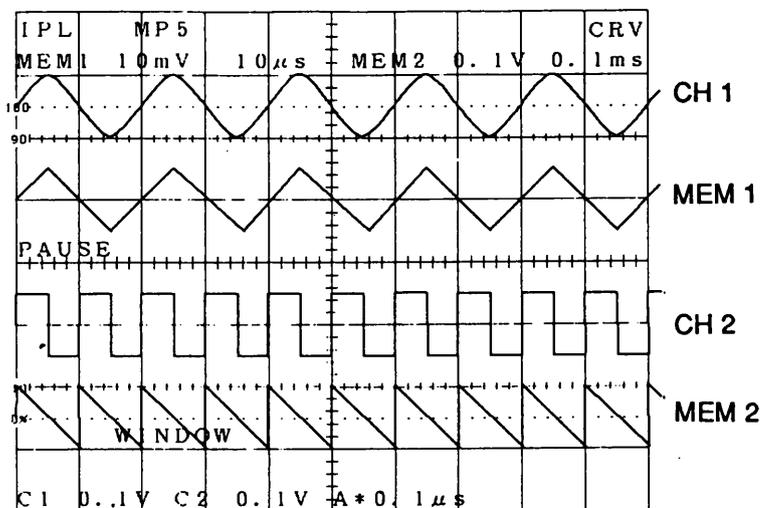

Figure 4-39. Simultaneous display of Current Waveforms and Saved Waveforms

### 4.2.11 Single Sweep in Storage Mode

The SINGLE of the Trigger Mode employed in the Storage Mode serves certain features of convenient uses as described in this section.

#### (1) Single Sweep in regular sampling operation

Waveform data acquisition starts by pressing the RESET switch. As the input signal has met the condition for triggering and, after the waveform data following the trigger point has been digitized, the waveform displayed on the CRT screen will be refreshed.

#### (2) Single Sweep in Roll Mode

The Roll operation starts by pressing the RESET switch. The Roll operation continues until the input signal is triggered and the trigger point reaches the point specified by TRIG PT switch. When the trigger point has reached the specified point, the Roll operation will stop.

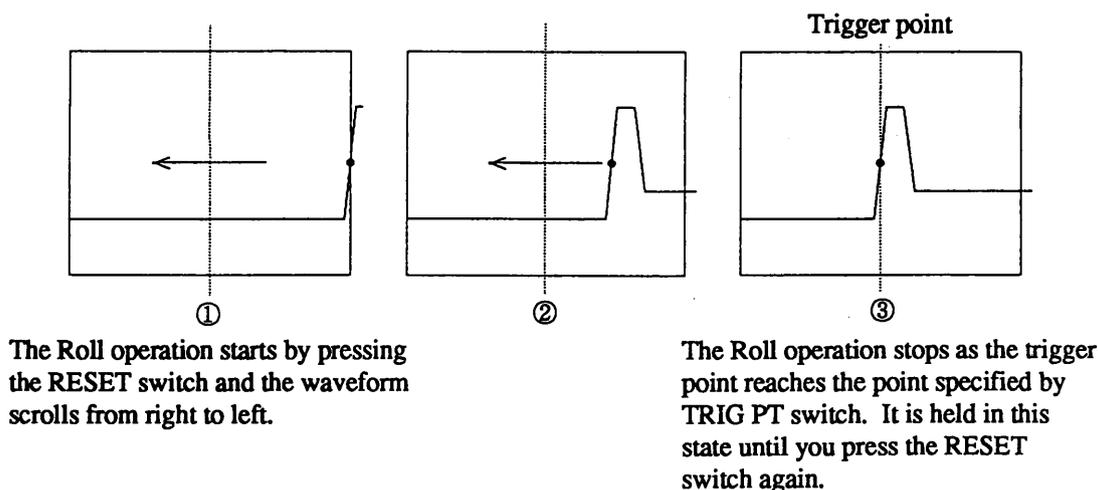

Figure 4-40. Single Sweep Operation in Roll Mode

#### (3) Single Sweep in Repetitive Mode

For the Single sweep operation in the Repetitive mode range, 20ns/DIV (50ns/DIV for COR5561U) through 10 $\mu$ s/DIV, the sampling rate is fixed at 20MS/s (equivalent to timebase 20 $\mu$ s/DIV) and the waveform data digitized on this timebase will be magnified and displayed with Interpolation. For example, if a Single sweep operation on the timebase 1 $\mu$ s/DIV is done, the waveform displayed on the CRT screen has already been magnified by 20 times with the Interpolation function (with the type of Interpolation you have selected on the Storage Menu).

$$\frac{20\mu\text{s}/\text{DIV}(20\text{MS}/\text{s})}{1\mu\text{s}/\text{DIV}} = 20\text{times}$$

#### **NOTE**

The waveform data digitized in the Single sweep operation cannot be directly magnified or stored onto the Saving Memory. To do such, you must set to the paused state by pressing the PAUSE switch. If you alter the TIME/DIV, VOLTS/DIV, MENU, STATUS, TRIG PT or STRG/REAL switch after the waveform data has been digitized in the Single sweep operation before the PAUSE switch, the waveform on the CRT screen will be lost and a baseline trace will be displayed alone on the center of the graticule.

## 4.2.12 Effective Storage Frequency Bandwidth

The performance of an analog oscilloscope is evaluated primarily from the viewpoint of how faithfully it can display the signal waveforms with accurate amplitudes and accurate frequencies. The performance of a digital oscilloscope is evaluated primarily from the viewpoint of the effective storage frequency bandwidth, which represents the maximum sine wave frequency effectively digitized.

It is a generally accepted criterion that the data of approximately 25 sample points are needed to reproduce one cycle of sine waveform for the dot representation. This oscilloscope, however, as it always displays waveforms by drawing vector lines among sampled points, one cycle of sine waveform can well be reproduced by only 10 sampled points.

The maximum effective storage frequency of the oscilloscope is calculated by following formula:

$$\text{Effective storage frequency} = \frac{\text{Maximum effective sampling rate}}{10} = \frac{20\text{MS/s}}{10} = 2\text{MHz}$$

With the Equivalent Sampling, it is calculated by following formula:

$$\text{Effective storage frequency} = \frac{\text{Maximum Equivalent sampling rate}}{10} = \frac{2\text{GS/s}}{10} = 200\text{MHz}$$

As a matter of fact, however, since it is limited by the frequency response of the vertical amplifiers, the actual effective storage frequencies are as follows:

COR5501U: 100MHz (-3dB)

COR5561U: 60MHz (-3dB)

The effective storage frequency with an Interpolation function can be also calculated in a similar manner as above.

When a sine wave is digitized employing Curve Interpolation, the one cycle of waveform can be well reproduced by employing only 3.5 samples. Thus, the maximum effective storage frequency with Curve Interpolation is calculated by following formula:

$$\text{Effective storage frequency} = \frac{\text{Maximum effective sampling rate}}{3.5} = \frac{20\text{MS/s}}{3.5} = 5.7\text{MHz}$$

The effective storage frequency of the oscilloscope is given in terms of the maximum sine wave frequency which can be displayed by using the Curve Interpolation.

When a sine wave is digitized employing a Linear Interpolation, one cycle of waveform requires 10 samples at least to be reproduced. Thus, the maximum effective storage frequency in the Linear Interpolation is calculated by following formula:

$$\text{Effective storage frequency} = \frac{\text{Maximum effective sampling rate}}{10} = \frac{20\text{MS/s}}{10} = 2\text{MHz}$$

**In the Paused Magnification mode, to display the waveform data digitized with Repetitive Mode, the effective storage frequencies are calculated by following formulas:**

**With Curve Interpolation**

$$\text{Effective storage frequency} = \frac{\text{Maximum Equivalent sampling rate}}{3.5} = \frac{20\text{GS/s}}{3.5} = 571\text{MHz}$$

**With Linear Interpolation**

$$\text{Effective storage frequency} = \frac{\text{Maximum Equivalent sampling rate}}{10} = \frac{20\text{GS/s}}{10} = 200\text{MHz}$$

**As a matter of fact, however, since it is limited by the frequency response of the vertical amplifiers, the actual effective storage frequencies are as follows:**

**COR5501U: 100MHz (-3dB)**

**COR5561U: 60MHz (-3dB)**

## Chapter 5. DESCRIPTIONS OF FRONT AND REAR PANELS

This chapter describes basic functions and operation methods of the panel switches, knobs, indicators, readouts, and other items on the COR5500U series oscilloscope.

### 5.1 Power Switch and CRT Controls

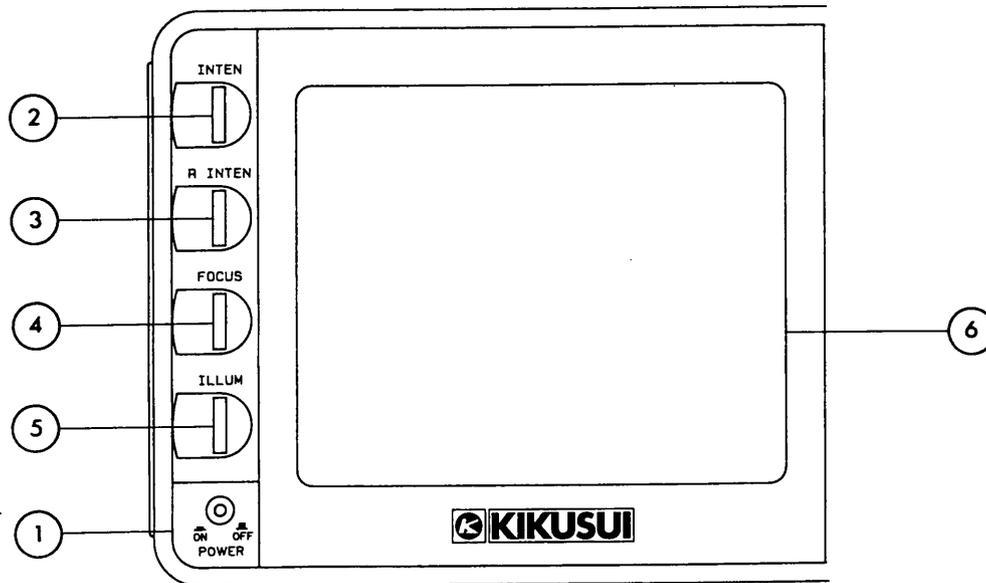

Figure 5-1. CRT Controls

- ① **POWER**      This is the power switch of the oscilloscope. Each time as you press the switch, the AC power of the oscilloscope is turned on or off.

While the power is turned off, the oscilloscope backs up all setup data. The COR5501U and COR5561U also keep the data about Storage Menu backed up. The stored data will resume when the power is turned on again.
- ② **INTEN**      Controls the intensity of the beam spot and traces. They become brighter as you turn the control upward.
- ③ **R INTEN**    Controls the intensity of the readout characters and cursors. They become brighter as you turn the control upward.
- ④ **FOCUS**      Controls the beam focus. Adjust this control so that the traces and characters are displayed clearly.
- ⑤ **ILLUM**      Controls the illumination brightness of the internal graticule of the CRT. The graticule becomes brighter as you turn the control upward.
- ⑥ **CRT**        This is a bright cathode-ray tube with an internal graticule. The effective screen size is 8 vertical scale divisions (1 DIV = 10 mm) × 10 horizontal scale divisions (1 DIV = 10 mm).

## 5.2 Vertical Axes

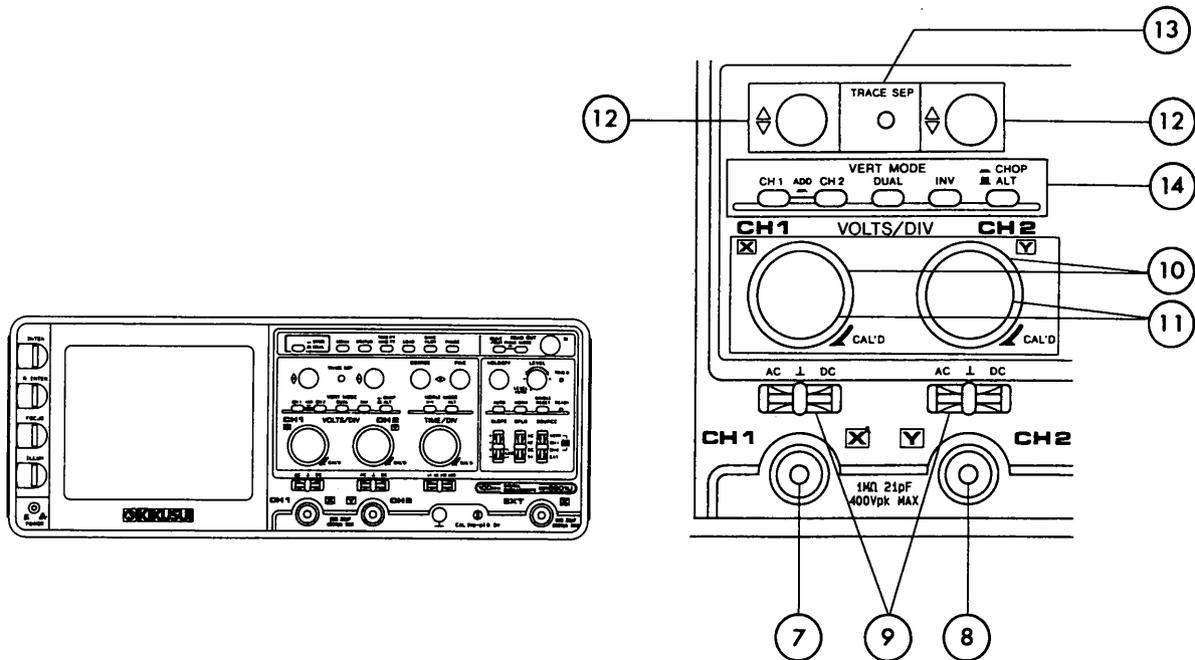

Figure 5-2. The Vertical Axis Control Section

- ⑦ **CH1 or X** This BNC terminal is used for the input of vertical channel 1, or for the X-axis (horizontal axis) when in X-Y mode.
- ⑧ **CH2 or Y** This BNC terminal is used for the input of vertical channel 2, or for the Y-axis (vertical axis) when in X-Y mode.
- ⑨ **Input Couplings** These levers select the couplings of input signal to the vertical amplifier, for each of CH1 and CH2.
  - AC** The input signal is coupled to the vertical amplifier via a capacitor which blocks the DC components. The lower limit frequency of AC coupling is 10Hz (-3 dB).
  - ⊥ (GND)** The input signal of the vertical amplifier section is short-circuited to the common level, however the input terminal is made open.
  - DC** The input signal is directly coupled to the vertical amplifier, without imposing any conditioning on the input signal.
- ⑩ **VOLTS/DIV (outer knobs)** These knobs select the vertical deflection factors of CH1 or CH2, for ranges covering from 1mV/DIV to 5V/DIV in a 1-2-5 sequence. The sensitivity becomes higher as you turn the knob clockwise. Although you may turn the knob clockwise or counterclockwise endlessly, the sensitivity will not change any further after reaching 1mV/DIV or 5V/DIV. Then, the following message will appear for about two seconds on the CRT screen to alert you that the sensitivity setting has reached end.

LIMIT

- ⑪ **VARIABLE**  
(inner knobs) These knobs are used for vernier controls of the vertical deflection factor, for each of CH1 and CH2. The fully clockwise position is the CAL'D (calibrated) position, where the setting of VOLTS/DIV is directly reliable for reading the input voltage. By turning this knob counterclockwise from the CAL'D position, you can finely adjust the vertical sensitivity down to 1/2.5 of the calibrated value. When the knob is not placed at the CAL'D position, the scale factor displayed on the CRT readout is preceded by a symbol ">" as shown in the following example:

C1>0.1V C2 0.1V A 0.1ms

- ⑫ **POSITION**  
 These knobs position the beam spot or the trace vertically, for each of CH1 and CH2. As you turn the knob clockwise, the trace moves upward. The moving direction of CH2 can be reversed when the INV switch of VERT MODE is being pressed.

When you use the X-Y mode, the CH1 knob also works as an X-axis (horizontal) position. As you turn the X-axis position clockwise, the trace will move rightward.

- ⑬ **TRACE SEP** This small knob adjusts the trace separation distance between the main sweep (original waveform) and the magnified sweep when they are swept in the Alternate Magnified mode. The magnified sweep can be set apart from the main sweep by up to approximately  $\pm 4$  DIV. This knob is enabled only in Real Mode.

- ⑭ **VERT MODE** These five switches select operation modes of the vertical axes.

The CH1, CH2, and DUAL switches are mutually linked. As you press the CH1, the oscilloscope operates as a single trace with channel 1 alone; as you press the CH2, the oscilloscope operates with channel 2 alone; as you press the DUAL, the oscilloscope operates as a dual trace scope with both channels. When no switches are being pressed, the oscilloscope selects CH1 alone automatically.

If you press both CH1 and CH2 switches simultaneously, the oscilloscope operates in the Addition mode and displays the sum of both channel signals. If the INV switch is also being pressed at the same time, the oscilloscope operates in the Subtraction mode and displays the difference among both channel signals.

The INV switch selects the polarity of the CH2 signal, enabling you to select either Addition or Subtraction of the two channel signals as follows:

$CH1 \pm CH2$

The ALT/CHOP switch is enabled only when you use the DUAL switch for dual trace oscilloscope. The ALT/CHOP switch selects whether the Alternate mode or the Chopping mode is to be active.

The Alternate mode displays CH1 and CH2 traces alternately after mutual sweeps. This mode is suitable for viewing of signals on a faster timebase.

The Chopping mode displays CH1 and CH2 traces in a time-sharing manner, by switching the channels in turns at a rate of approximately 500kHz. This mode is suitable for viewing of signals on a slower timebase.

### 5.3 Trigger

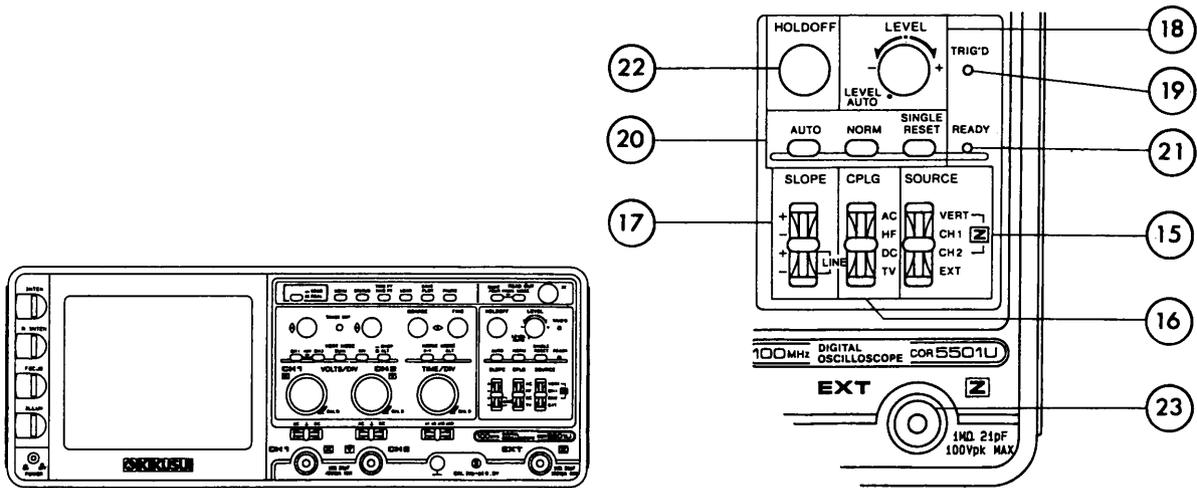

Figure 5-3. Trigger

**15 SOURCE**

This lever switch selects a source of the trigger signal which you want to apply to the trigger circuit. This switch has four select positions, namely, VERT, CH1, CH2, and EXT.

**VERT**

The term “VERT” stands for the Vert Mode Trigger. That is, an input signal selected by the VERT MODE switches is used as a trigger source signal.

When you use Alternate mode at dual trace operation, the trigger source signals are also switched alternately after each sweep so that the sweeps of CH1 and CH2 should be triggered by each signal. However, the CH1 signal is used for the trigger source in the following cases:

- The oscilloscope is in the Chopping mode at the dual trace operation, or
- The oscilloscope is in the Addition mode.

**CH1**

The input signal of CH1 is used for the trigger source.

**CH2**

The input signal of CH2 is used for the trigger source.

**EXT**

The signal applied to the EXT input terminal is used for the trigger source.

- ⑩ CPLG** This lever switch selects a type of coupling between the trigger signal source and the trigger circuit.
- AC** The trigger signal is coupled to the trigger circuit via a capacitor which blocks the DC components. AC components of lower than 50Hz will be also attenuated.
  - HF** It is identical with DC coupling except that AC components higher than 50kHz are attenuated. Even if the trigger source signal involves high frequency noises, stable triggering can be expected because high frequency components are eliminated. This coupling is suitable for viewing of a lower frequency signal which high frequency noise components are superimposed on.
  - DC** The trigger source signal is directly coupled to the trigger circuit, without any conditioning.
  - TV** This coupling is especially provided for viewing video signals. The trigger source signal (a video signal) is coupled to the internal TV-sync separator circuit which picks off the TV. V or TV. H sync signal for triggering. The switching operation between the TV. V (vertical sync) and the TV. H (horizontal sync) depends on the TIME/DIV switch.
    - TV. V: 0.1ms/DIV through 0.5s/DIV (Real Mode)  
0.1ms/DIV through 5s/DIV (Storage Mode)
    - TV. H: 20ns/DIV through 50 $\mu$ s/DIV (COR5501U and COR5500U)  
50ns/DIV through 50 $\mu$ s/DIV (COR5561U and COR5560U)
- ⑪ SLOPE** This lever switch selects which you use a positive slope or a negative slope for triggering. It can also select the AC line frequency for the triggering (LINE position). When you select the LINE, the AC line frequency is used for the trigger signal and the SOURCE switch is ignored. The LINE positions are useful for viewing signals which are synchronized with the AC line frequency.
- +** Triggering is effected as the trigger signal crosses the trigger level in the positive direction. Thus, the signal waveform will appear starting by rising up.
  - Triggering is effected as the trigger signal crosses the trigger level in the negative direction. Thus, the signal waveform will appear starting by falling down.
  - +LINE** Triggering is effected by a positive slope of the AC line signal.
  - LINE** Triggering is effected by a negative slope of the AC line signal.
- ⑫ LEVEL** This knob specifies the triggering threshold level and consequently adjusts the starting point of the waveform display. The fully counterclockwise position (click position) is for LEVEL AUTO, where the trigger level can be automatically adjusted to an optimal level.
- ⑬ TRIG'D** This LED lights up to indicate that the sweep is being triggered.

- ⑳ **Trigger mode switches** These three switches select a Trigger Mode. These switches are linked each other. The SINGLE RESET switch also works as a reset switch when the Trigger Mode is Single.
- AUTO** When no trigger signal is applied or the trigger frequency is lower than 50Hz, the sweep runs freely—this mode is referred to also as “free-running” state.
- NORM** The sweep runs only when a trigger signal is applied. Without any trigger signal, no sweep runs and no trace appears on the CRT screen. This mode is used primarily for viewing of repetitive signals of lower than 50Hz.
- SINGLE RESET** This switch selects the Single Trigger mode, it also acts as a reset switch. As you press this switch, the trigger circuit becomes the READY (standby) state. Then, at the instant of triggering, the trace will run only once. If you use the Alternate mode at the dual trace operation, the trace of CH1 and CH2 will run alternately each time a trigger condition is met.
- As you press the SINGLE RESET switch after the sweep is over, the trigger circuit will be reset to the READY state and the READY LED will light up. The LED goes out when the sweep starts running.
- ㉑ **READY** This LED lights up to indicate that the Trigger Mode is set to the Single and the trigger circuit has become ready to start. It goes out when the sweep has started.
- ㉒ **HOLDOFF** This knob adjusts the Holdoff time—between the end of the current sweep and beginning of the next sweep—which holds trigger circuit inactive. The Holdoff time is the shortest when the knob is placed in the full counterclockwise position (click position). The Holdoff function is especially convenient for viewing complex waveforms (such as digital pulse signals) which cannot be stably triggered with the Trigger Level adjustment alone.
- ㉓ **EXT** This input BNC terminal accepts an external trigger signal. It also works as an input terminal for the External Intensity Modulation, when the Trigger SOURCE switch is placed at VERT, CH1 or CH2.

## 5.4 Horizontal Axis (Timebase)

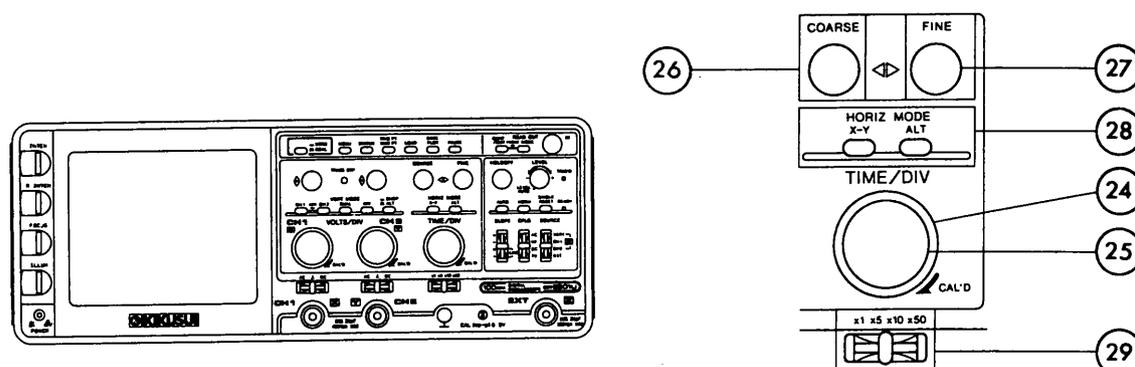

Figure 5-4. Horizontal Axis

- ②④ **TIME/DIV** (outer knob) This knob selects a horizontal sweep speed (timebase). The selectable timebase range depends on the models as follows:

Table 5-1. Available timebase ranges

<b>COR5501U:</b>	
Storage Mode	20ns/DIV - 5s/DIV, 26 way settings
Real Mode	20ns/DIV - 0.5s/DIV, 23 way settings
<b>COR5500U</b>	20ns/DIV - 0.5s/DIV, 23 way settings
<b>COR5561U</b>	
Storage Mode	50ns/DIV - 5s/DIV, 25 way settings
Real Mode	50ns/DIV - 0.5s/DIV, 22 way settings
<b>COR5560U</b>	50ns/DIV - 0.5s/DIV, 22 way settings

The sweep speed becomes faster as you turn the knob clockwise. Although you may turn the knob clockwise or counterclockwise endlessly, the timebase will not change any further after reaching 20ns/DIV (50ns/DIV for COR5561U and COR5560U) or 0.5s/DIV (5s/DIV in Storage Mode). Then, the following message will appear for about two seconds on the CRT screen to alert you that the timebase is at a selectable limit.

LIMIT

- ②⑤ **VARIABLE** (inner knob) This knob is used for vernier control of the timebase. The fully clockwise position is the CAL'D (calibrated) position. By turning the knob counterclockwise from its CAL'D position, you can finely adjust the sweep speed down to 1/2.5 of the calibrated value.

When the knob is not placed at the CAL'D position, the scale factor displayed on the CRT readout is preceded by a symbol ">" as shown in the following example:

C1 0.1V C2 0.1V A> 0.1ms

This knob is enabled only in Real Mode.

- ②⑥ **COARSE**      This knob is used for the coarse horizontal positioning of the trace. You can move the trace horizontally with this knob over  $\pm 6\text{DIV}$ , based on the position where the beginning of the trace is placed at the left end on the graticule.

◀▶
- ②⑦ **FINE**      This knob is used for the fine horizontal positioning of the trace. You can move the trace horizontally with this knob over  $\pm 6\text{DIV}$ , when it is magnified at  $\times 10$  Magnification. Thus, this knob is used primarily for vernier horizontal positioning in Magnified Sweep mode.

◀▶
- ②⑧ **HORIZ MODE**    These switches can select the X-Y mode and the Alternate Magnified Sweep mode.

  - X-Y**      This switch enables the X-Y mode, which assigns X-axis to CH1 and Y-axis to CH2. This switch is available only in the Real Mode.
  - ALT**      This switch enables the Alternate Magnified Sweep mode. When the MAG switch is placed at  $\times 5$  or more, you can select the Alternate Magnified Sweep mode in which the main sweep and the magnified sweep run alternately. This switch is available only in the Real Mode.
- ②⑨ **MAG Switch**    This switch selects a sweep magnification factor for  $\times 1$ ,  $\times 5$ ,  $\times 10$ , or  $\times 50$ . The trace can be magnified horizontally with the center of the graticule as the center of magnification. When the magnification factor is  $\times 5$  or more, the magnification factor and the magnification timebase will be displayed rightward the original timebase readout.

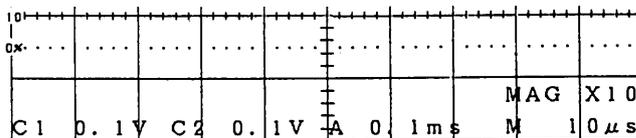

Figure 5-5. Magnification

Magnification factor  $\times 50$  is available only when you use the Real Mode and the timebase is within  $0.5\mu\text{s}/\text{DIV}$  through  $0.5\text{s}/\text{DIV}$ . If you set the MAG switch to  $\times 50$  is in the Storage Mode or without timebase range above, the following message will appear on the CRT screen for about two seconds.

INVALID

Further, the following message will appear near the readout of magnified timebase to indicate that the timebase is not calibrated.

UNCAL

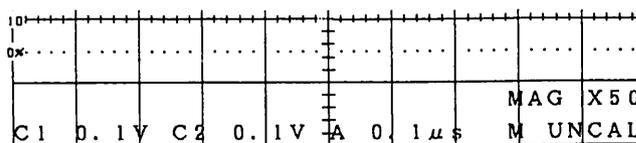

Figure 5-6. UNCAL Message in  $\times 50$  MAG

## 5.5 Readout

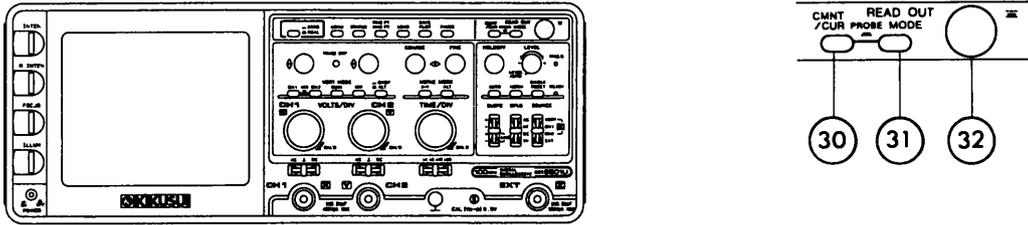

Figure 5-7. Readout

- ③⑩ **CMNT/CUR**      This switch selects the Comment Mode or the Cursor Mode. Each time as you press this switch, the mode changes in the sequence of CMNT1 → CMNT2 → “off,” however no message appears for off. Messages CMNT1 and CMNT2 mean that the corresponding comment texts are selected. If you select off, this switch works for Cursor Mode.
- ③⑪ **MODE**      In the Comment Mode, this switch selects a function of the  knob for comment entry. Each time as you press this switch, the mode changes in the sequence of <> → SEL → SPC → ERS → off, however no message appears for “off.”

In the Cursor Mode, this switch selects a measuring mode of the cursor function. In Real Mode, each time as you press this switch, the measuring mode of cursor changes in the sequence of  $\Delta V$  →  $\Delta V$  (DIV) →  $\Delta T$  →  $\Delta T$  (DIV) →  $1/\Delta T$  → off. In the storage mode, it changes in the sequence of  $\Delta V$  →  $\Delta V$  (DIV) →  $\Delta T$  →  $\Delta T$  (DIV) →  $1/\Delta T$  → WINDOW (in paused state only) → off. No message appears for “off.”
- ③⑫  (CURSOR knob)      In the Comment Mode, the CURSOR knob allows you to select a comment text character and to specify its entry position. When in the Cursor Mode, this knob allows you to select CURSOR1, CURSOR2 or TRACKING, and to move the cursors.

## 5.5.1 Comments

③⑩ **CMNT/CUR** This switch selects a comment number to be displayed. Each time as you press this switch, the comment number changes in the sequence of CMNT1 → CMNT2 → off.

③⑪ **MODE** When a comment text is displayed on the CRT screen, this switch specifies what you do in the Comment Mode. Each time as you press this switch, the mode changes in the sequence of <> → SEL → SPC → ERS → off and a message with these symbols or characters appears rightward CMNT1 or CMNT2 message. No message appears if you select off, and it means that a comment text is displayed on the CRT screen.

The MODE switch is also used to select a mode of Cursor.

<> This symbol denotes the mode which allows you to move the marker. You may use this mode to select a position where you want to enter or modify a character. As you select this mode, a marker will appear in the comment display area. The marker is a blinking prompt, which has one-character size. You can move it within the comment display area by turning the  knob.

**SEL** This symbol denotes the character select mode. As you select this mode, a marker appears in the comment display area.

As you turn the  knob, the marker and a character will appear alternately at the maker position. As you turn the  knob further, another character will appear. Repeat this until you find a character you want to enter.

When you have found the character you want, press the  knob. The marker will move to the next column and will blink there. You can skip entry by simply pressing the  knob without turning. Then, the existing comment character will not be altered.

By repeating the above procedure, you can enter other characters you need.

**SPC** This symbol denotes the space entry mode. Use it when you want to overwrite a blank character.

As you select this mode, a marker will appear in the comment display area. The marker is a blinking prompt, which has one-character size.

You can move the marker within the comment display area by turning the  knob. As you press the  knob, a blank character is overwritten in this position and the marker moves to the next column. If you want to enter blank characters continuously, press the  knob many times.

**ERS** This symbol denotes the comment erasing mode. This mode allows you to delete the entire comment text at once.

Select the ERS by the MODE switch. Then, press the  knob. All the comment characters will be deleted and, the contents of comment memory will be lost.

## 5.5.2 Cursors

### ③1 MODE

This switch specifies the measurement mode of Cursor functions. Each time as you press this switch in Real Mode, the measuring mode changes in the sequence of  $\Delta V \rightarrow \Delta V (DIV) \rightarrow \Delta T \rightarrow \Delta T (DIV) \rightarrow 1/\Delta T \rightarrow \text{off}$ . In Storage Mode, it changes in the sequence of  $\Delta V \rightarrow \Delta V (DIV) \rightarrow \Delta T \rightarrow \Delta T (DIV) \rightarrow 1/\Delta T \rightarrow \text{WINDOW (in paused state)} \rightarrow \text{off}$ . For the WINDOW function, refer to Section 4.2.9 "Waveform Magnification/Window."

This switch also serves the selecting function for the Comment Mode. If you want to change it to the Cursor Mode from the Comment Mode, press the  switch once. If the Comment Entry function is active, change it to the Comment Display function at first by the MODE switch and, then press the  switch.

### $\Delta V$

This mode measures a signal voltage. As you select this mode, two horizontal cursors, namely CURSOR1 (a broken line) and CURSOR2 (a dotted line), will appear and the voltage between two cursors will be displayed on the readout. In the dual trace operation, the voltages of both channel signals can be displayed simultaneously.

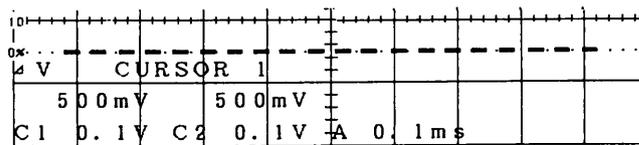

Figure 5-8. Measured Voltage Data displayed on readout

If the vertical VAR knob is not in the CAL'D position (fully clockwise position), a question mark (?) appears instead of the measured voltage data.

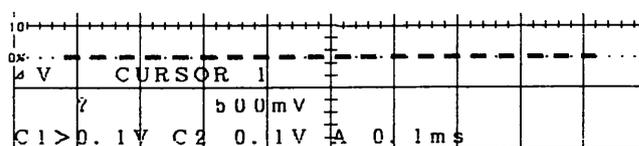

Figure 5-9. "?" for VAR knob in UNCAL

When you select Addition mode by the VERT MODE, the measured data appears on the position of CH1, in the unit of DIV.

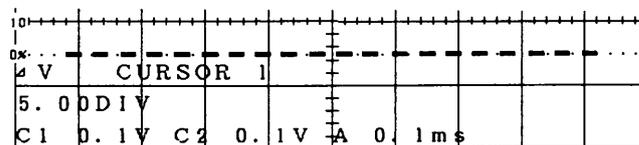

Figure 5-10. Measured Data in Addition Mode

**$\Delta V$  (DIV)** This mode measures the amplitude of waveform vertically. As you select this mode, two horizontal cursors will appear similarly to the  $\Delta V$  measurement and the value between the two cursors will be displayed on the readout, but in the unit of DIV. When you use the dual trace operation, the measured data will appear on the position of CH1.

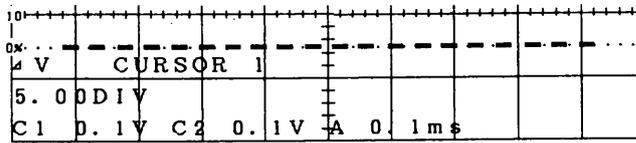

Figure 5-11. Measured Data in  $\Delta V$ (DIV) Mode

Even if the vertical VAR knob is not in the CAL'D position, the displaying in the DIV unit is immutable.

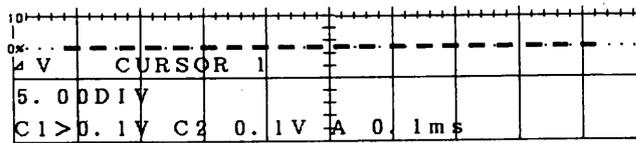

Figure 5-12. Measured Data when VAR knob is not CAL'D

When the Addition Mode is selected by the VERT MODE, the measured data appears in the position of CH1 in the unit of DIV.

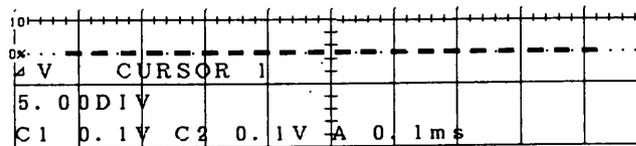

Figure 5-13. Measured Data in Addition Mode

$\Delta T$

This mode measures a time interval. As you select this mode, two vertical cursors (a broken line and a dotted line) will appear and the time span between the two cursors will be digitally displayed on the readout.

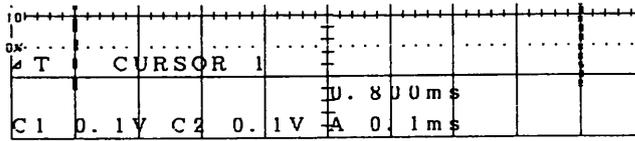

Figure 5-14. Measured Time Interval Data displayed on readout

If the VAR knob of the horizontal axis is not in the CAL'D position (fully clockwise position), a question mark (?) appears instead of the time interval data.

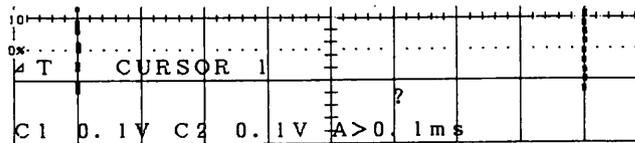

Figure 5-15. "?" for VAR knob in UNCAL

When the sweep magnification factor is  $\times 5$  or more, the timebase is calculated taking the magnification factor into account. It is similar to the operation of the Alternate Magnified Sweep mode.

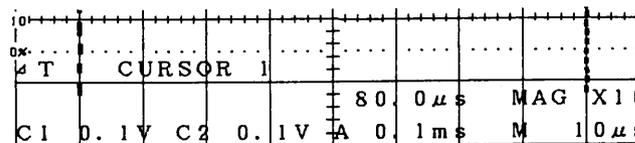

Figure 5-16.  $\Delta T$  Measurement with MAG

If you set the MAG switch to  $\times 50$  in Storage Mode or timebase without  $0.5\mu s/DIV$  through  $0.5s/DIV$ , a question mark (?) will appear in the measurement data display position.

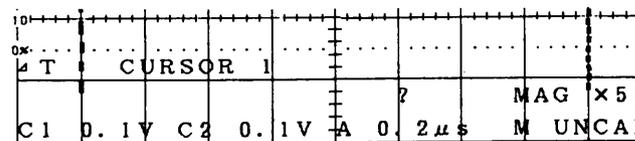

Figure 5-17. "?" for invalid Measurement Data

**$\Delta T$  (DIV)** This mode measures a horizontal span in the unit of DIV. As you select this mode, two vertical cursors will appear similarly to the  $\Delta T$  measurement and the value between the two cursors will be displayed on the readout.

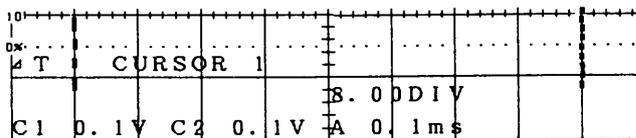

Figure 5-18. Measured Data in  $\Delta T$ (DIV) Mode

Similarly, the measured value is also displayed in the unit of DIV when:

- The VAR knob is not in the CAL'D position,
- Sweep magnification factor is  $\times 50$  on a timebase without the range  $0.5\mu\text{s}/\text{DIV}$  through  $0.5\text{s}/\text{DIV}$ , or
- In the Storage Mode.

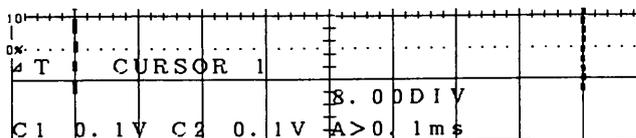

Figure 5-19. Data Displayed when VAR knob is UNCAL

**$1/\Delta T$**

This mode measures a frequency of waveform, by determining the time interval of the signal and calculating its reciprocal. As you select this mode, two vertical cursors (a broken line and a dotted line) will appear and the frequency—the reciprocal of the time interval—will be calculated and displayed on the readout.

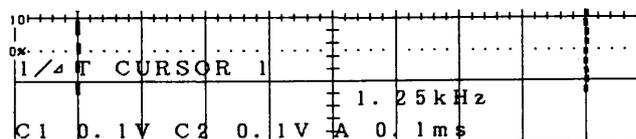

Figure 5-20. Measured Frequency displayed on readout

If the horizontal VAR knob is not in the CAL'D position (fully clockwise position), a question mark (?) appears instead of the frequency data.

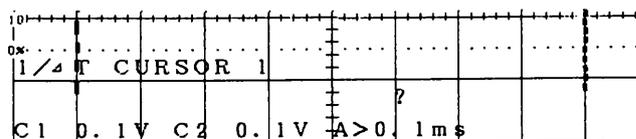

Figure 5-21. "?" for VAR knob in UNCAL

When the sweep magnification factor is  $\times 5$  or more, the frequency is calculated taking the magnification factor into account. It is similar to the operation of the Alternate Magnified Sweep mode.

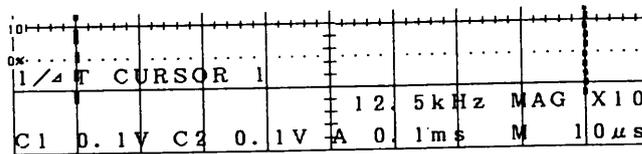

Figure 5-22.  $\Delta T$  Measurement with MAG

If you set the MAG switch to  $\times 50$  in Storage Mode or timebase without range  $0.5\mu s/DIV$  through  $0.5s/DIV$ , a question mark (?) will appear in the data display position.

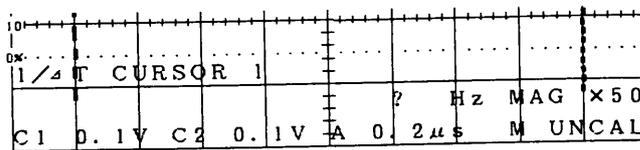

Figure 5-23. “?” for Invalid Measurement Data

③  (CURSOR knob)

In the Cursor Mode, you can adjust the position of the two cursor lines separately or simultaneously. As you select one of the above measuring modes, two cursors (a broken line and a dotted line) appear on the CRT screen, and the measuring mode and the control function of the  knob are displayed on the readout.

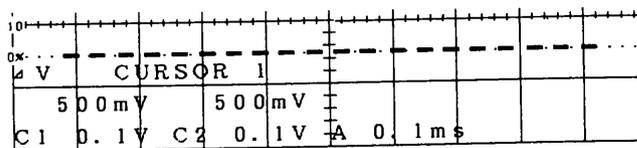

Figure 5-24. Measuring Mode and  Knob Function Displayed on Readout

Each time as you press the  knob, the function changes in the sequence of CURSOR1  $\rightarrow$  CURSOR2  $\rightarrow$  TRACKING.

CURSOR1 Moves the broken line cursor.

CURSOR2 Moves the dotted line cursor.

TRACKING Moves the two cursors simultaneously, keeping the distance between them constant.

Although you may turn the knob clockwise or counterclockwise endlessly, the cursor will stop at the corresponding end position (top, bottom, right, or left) of the graticule and will not move any further. If in the TRACKING mode, the cursors will stop moving when either one of them has reached the end position, maintaining the distance between them constant. In these cases, the following message will appear for about 2 seconds on the screen.

LIMIT

## 5.6 Display for Probes

If you press the CMNT/CUR switch and the MODE switch simultaneously, the vertical scale factor is changed to  $\times 10$  scale factor, which is suitable for using a 10:1 probe.

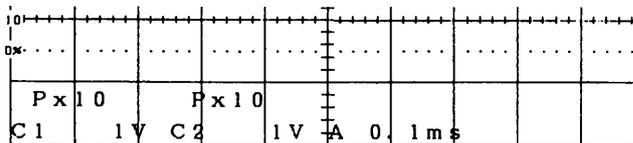

Figure 5-25. Scale Factor Messages for 10:1 Probes

**NOTE** The "Px10" messages are invisible when you use the cursors for vertical axis measurements.

## 5.7 Others

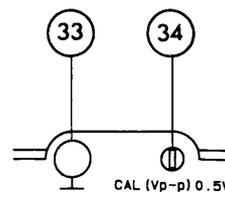
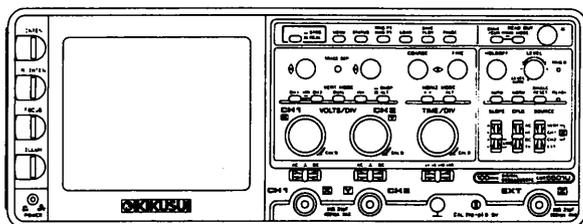

Figure 5-26. Calibrator

③③  $\perp$  (GND) This banana jack terminal is used for measuring grounding. You may use this terminal for the ground terminal of the circuit or instrument whose signals are to be measured.

**NOTE** Do not use this terminal for the safty grounding. It is only for the measuring grounding.

③④ CAL This terminal provides a positive square waveform calibration signal of voltage 0.5Vp-p, frequency 1kHz. Typically, this signal is used for phase compensation adjustment of the probes. Although this signal may be used for qualitative check of performance for vertical or horizontal axis, it cannot be used for quantitative calibration of these circuits.

## 5.8 Rear Panel

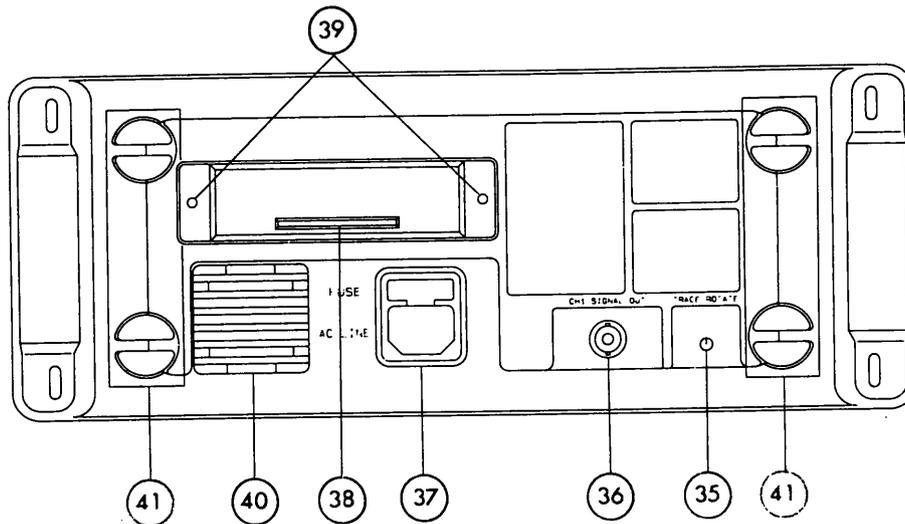

Figure 5-27. The Rear Panel

- ③⑤ **TRACE ROTATE** This control rotates the baseline trace so that it becomes in parallel with the horizontal lines of the graticule. As you turn the control clockwise (as viewed from the front panel), the trace on the CRT also rotates clockwise.
- ③⑥ **CH1 SIGNAL OUT** This terminal delivers an output signal which represents the CH1 input signal. The output signal voltage is corresponding to approximately 50 mV/DIV, and it becomes approximately 25 mV/DIV when a 50ohm load is connected to the terminal. For a typical example of use, the output signal may be fed to a standard frequency counter for the frequency calibration.
- ③⑦ **AC LINE** The AC input power connector. This connector also serves as a fuse holder.
- ③⑧ **Option Slot** This slot is used for an optional GPIB Interface Unit (IF01-COR) which is available for the COR5501U and COR5561U. If the IF01-COR is attached on the oscilloscope, the waveform data and readout data can be sent to a GPIB plotter by using HP-GL commands.
- For further details of the IF01-COR, refer to its operation manual.
- ③⑨ **Screw holes** These holes are used for screws to mount an Interface Unit.
- ④⑩ **Fan** The air exhaust holes for the fan for forced air cooling. Provide an ample space behind the rear panel so that the exhaust air flow is not impeded or blocked.
- ④① **Cable take-up** This take-up is used to take up the AC power cable when the oscilloscope is not in use.

## 5.9 Storage

This section describes basic functions and operation methods of the switches, knobs, readout, and other items which are used in Storage Mode operation for the COR5501U and COR5561U oscilloscope.

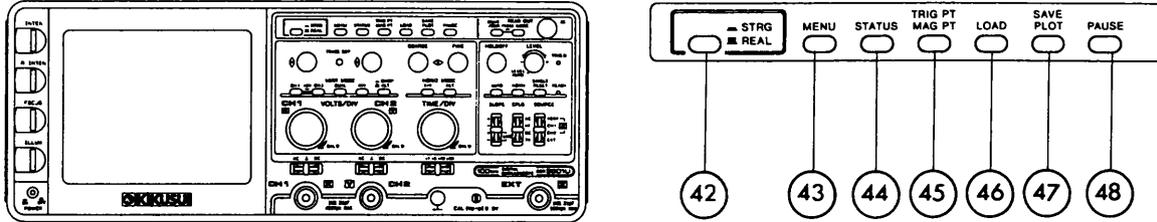

Figure 5-28. Storage Controls

- ④2 **STRG/REAL** This switch selects the Storage Mode or the Real Mode. If it is being pressed, the operation is the Storage Mode.
- ④3 **MENU** This switch invokes the Storage Menu. It lists the modes which are available for the storage operation and the statuses (ON or OFF) which are selectable for respective modes. A marker will appear rightward the status column, prompting you to select a state.

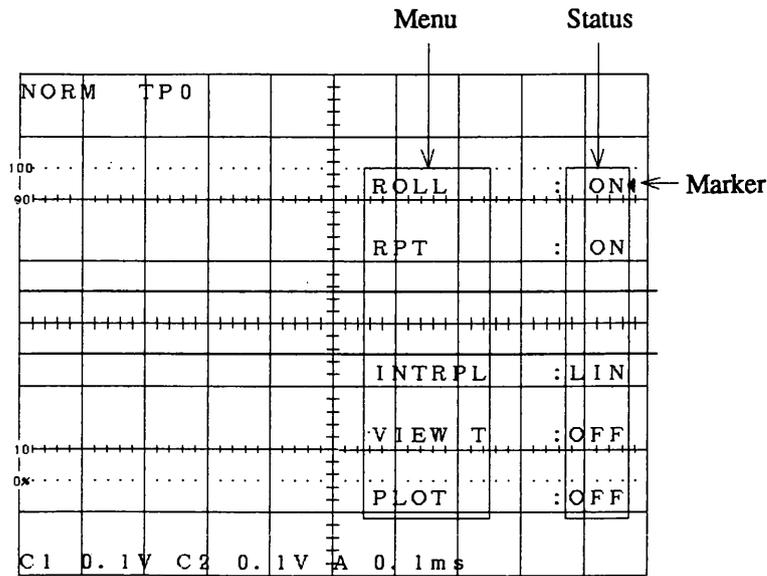

Figure 5-29. The Storage Menu

- ROLL** The Roll mode, such that the waveform scrolls leftward on the CRT screen, is enabled. The newest data comes from the right end and the oldest data goes away from the left. This mode is suitable for viewing slowly changing signals or slowly repetitive signals in the form of continuous traces.
- RPT** The Repetitive mode (Equivalent Sampling mode) enables the sampling of repetitive signals that contain the frequencies higher than the maximum effective storage frequency.
- INTRPL** When the acquisition of waveform data is being interrupted with the Pause function, the displayed waveform may be magnified horizontally. As the magnification factor becomes larger, the displayed waveform becomes less faithful to the original waveform. The Interpolation Mode provides a more faithful waveform by calculation. Two types of Interpolation are selectable, namely, the Linear Interpolation and the Curve Interpolation.
- VIEW T** The View Time inserts a waiting time (approximately one second) between the refreshing of the waveform and the displaying of the waveform. It can freeze the waveform display temporarily.
- PLOT** The waveform data and readout data of the oscilloscope can be sent to a GPIB plotter by using HP-GL commands. This menu item is used for setting a printing size and location for the pictures on the plotter.

To send the screen data to a GPIB plotter, an optional GPIB Interface Unit (IF01-COR) must be attached.

Each time as you press the MENU switch, the marker moves down. If you press the MENU switch when the marker is in the PLOT row, the Storage Menu will go out. It appears again as you press the MENU switch again.

#### ④ STATUS

This switch enables or disables each menu item. Each time as you press this switch, the status of the menu item will change as follows:

ROLL : ON↔OFF

PRT : ON↔OFF

VIEW : ON↔OFF

INTRPL: LIN↔CRV

PLOT : N→S1→S2→S3→S4→CTR→OFF

To set each mode status, proceed as follows:

- Press the MENU switch to invoke the Storage Menu.
- Move the marker to the row of the item which you want to enable or disable.
- Select a status you need, by the STATUS switch.

The timebase ranges available when in the Roll or Repetitive mode are restricted as follows:

ROLL : 0.2s/DIV through 5s/DIV

RPT : 20ns/DIV (50 ns/DIV for COR5561U) through 10 $\mu$ s/DIV

If you select a timebase outside the above range, the corresponding mode will automatically turned off even if the "ON" state has been selected. Depending on the state of operation, the status indications of Storage Mode show as Table 5-2.

Table 5-2. Storage Mode Indications

	ON	OFF	
ROLL	ROLL	NORM	"NORM" is indicated constantly if the timebase is set to invalid range for the Roll or Repetitive mode.
RPT	RPT	NORM	

④⑤ **TRIG PT  
MAG PT**

This switch selects a trigger point when in the Pretrigger Mode for viewing a waveform which precedes the trigger point. It also selects a position for the MAG point (sweep magnification point) when you use the Paused Magnification function. Each time as you press this switch, the point will change in the sequence of TP0 (MP0) → TP1 (MP1) → TP5 (MP5) → and TP9 (MP9).

④⑥ **LOAD**

This switch selects the Saving Memory units. COR5500U series has two Saving Memory units, namely, MEM1 and MEM2. Each time as you press this switch, it will select them in the sequence of MEM1 → MEM2 → MEM12 → off. When MEM1 or MEM2 is selected, the existing waveform in the memory unit 1 or 2 is displayed respectively. When MEM12 is selected, the both existing waveforms are displayed simultaneously.

④⑦ **SAVE PLOT**

If you press this switch when the PAUSE switch has been pressed and the displayed waveform is frozen, the frozen waveform will stored onto the Saving Memory. If you press this switch from the PLOT on the Storage Menu, the CRT screen data will be sent to the GPIB plotter.

④⑧ **PAUSE**

This switch is used to pause the acquisition of the input signal data. At the instant you have pressed this switch, the existing waveform will be frozen and kept in this state. Then, the following message will appear at the left center of the CRT screen.

PAUSE

To release the paused state, press this switch again.

In the paused state, the frozen waveform data can be stored onto the Saving Memory and the displayed waveform can be magnified. However, the number of switches will be disabled in the paused state.

## Chapter 6. MAINTENANCE

### 6.1 Backup Battery

Several memories of the oscilloscope are backed up with a battery so that the data of certain items shall not be destroyed even if the power switch is turned off.

**The data items protected with the backup battery are as follows:**

- Vertical Deflection Factor
- Timebase
- Cursor position and cursor-measured data
- Comments
- Storage Menu
- Waveform data stored in Saving Memories

**The life expectancy of the backup battery:**

Three years from shipment of the oscilloscope by the manufacturer

**Replacing the backup battery:**

When turning the power on, if the contents of the backup data differ from the contents before turning off or, if the following message appears on the CRT screen, you should replace the battery.

BACK UP BATTERY EMPTY?

For replacement of backup battery, please order your Kikusui agent.

The message will disappear as you operate one of the following switches:

VOLTS/DIV, TIME/DIV, CMNT/CUR, MODE, , MENU, STATUS, TRIG PT, LOAD, SAVE/PLOT, and PAUSE.

Normally, even if the above message has appeared, other functions of the oscilloscope will not be adversely affected and you may use the oscilloscope if you want to.

## 6.2 CRT and Filter

When the surfaces of the CRT screen and filter have become dusty or dirty, clean them by using a soft dry cloth. The filter can be detached as shown in Figure 6-1.

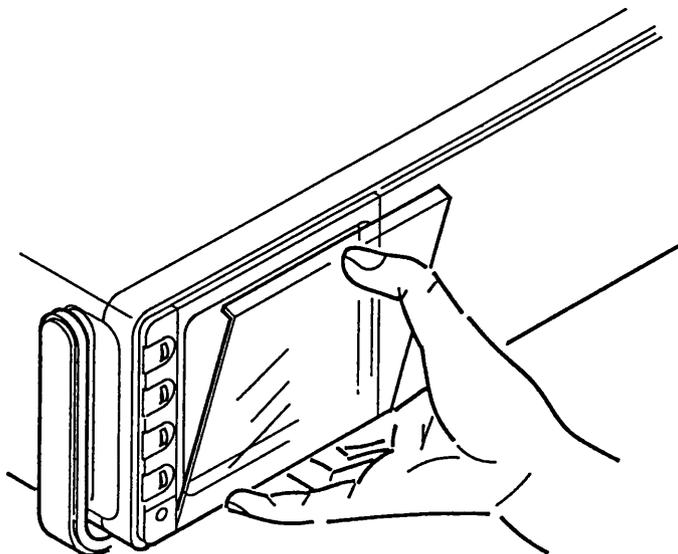

Figure 6-1. Detaching the CRT Filter

**Caution** *Never use benzine, thinner or other volatile chemical detergents on the oscilloscope. In the worst cases, the filter, panels or knobs might be deformed or the paint finish of the top and bottom panel might be impaired.*

## Chapter 7. SPECIFICATIONS

## ○ Vertical Axes

Item	Specification	Remarks
CH1 CH2		
Deflection factor	1mV/DIV - 5V/DIV	1-2-5 sequence, 12 way setups
Deflection factor accuracy	5mV/DIV - 5V/DIV : $\pm 3\%$ 1mV/DIV, 2mV/DIV : $\pm 5\%$	15 to 35°C (59°F to 95°F); 1kHz, 4 - 5DIV reference; in Real Mode
Variable control	Attenuates down to 1/2.5 or less from the sensitivity selected by VOLTS/DIV switch.	
Frequency bandwidth	COR5500U, COR5501U DC - 100MHz, -3dB DC - 20MHz, -3dB (1mV/DIV, 2mV/DIV) AC coupling lower limit frequency: 10Hz	15 to 35°C (59°F to 95°F); 50kHz, 8DIV reference in Real Mode.
	COR5560U, COR5561U DC - 60MHz, -3dB DC - 20MHz, -3dB (1mV/DIV, 2mV/DIV) AC coupling lower limit frequency: 10Hz	15 to 35°C (59°F to 95°F); 50kHz, 8DIV reference in Real Mode.
Rise time	COR5500U, COR5501U 3.5ns or faster 17.5ns or faster (1mV/DIV, 2mV/DIV)	15 to 35°C (59°F to 95°F); 5DIV reference; in Real Mode
	COR5560U, COR5561U 5.8ns or faster 17.5ns or faster (1mV/DIV, 2mV/DIV)	15 to 35°C (59°F to 95°F); 5DIV reference; in Real Mode
Square waveform characteristics	5mV/DIV - 0.5V/DIV ranges Overshoot : 3% or less Ringing : 3% or less Aberration : 5% or less Lower frequency distortion (sag) of 100Hz - 100kHz: 2% or less Pulse wave performance in Addition mode: Above values plus 3%	15 to 35°C; 5DIV reference; in Real Mode



## ○ Trigger

Item	Specification	Remarks
Trigger sources	CH1, CH2, EXT, VERT. If the VERT is selected, the input channel selected by VERT MODE is used for the trigger source. In Additional mode or Chopping mode of dual trace, CH1 signal is used for the trigger source.	The VERT is enabled when in Alternate sweep, in Single Trigger or not in LEVEL AUTO.
Trigger couplings	AC, HF, DC, TV (TV.V, TV.H). Switching between TV.V and TV.H is linked to timebase selection. COR5500U, COR5501U TV.V: 0.1ms/DIV - 0.5s/DIV (5s/DIV) TV.H: 20ns/DIV - 50 $\mu$ s/DIV COR5560U, COR5561U TV.V: 0.1ms/DIV - 0.5s/DIV (5s/DIV) TV.H: 50ns/DIV - 50 $\mu$ s/DIV	1s/DIV - 5s/DIV are available only for the Storage Mode.
Polarity	+, -, +LINE, -LINE	When +LINE or -LINE is selected, the AC line signal is automatically selected for the trigger source.
Sensitivity	COR5500U, COR5501U DC - 10MHz : 0.4DIV (0.2V) DC - 100MHz : 1.5DIV (0.75V) TV.V, TV.H : 1.5DIV (1.5V) AC : Frequencies lower than 10Hz are attenuated. HF : Frequencies higher than 50kHz are attenuated.	The figures enclosed in the parentheses are EXT trigger input sensitivities. Specification for TV.V and TV.H are applicable to NTSC field color bar signals.
	COR5560U, COR5561U DC - 10MHz : 0.4DIV (0.2V) DC - 60MHz : 1.5DIV (0.75V) TV.V, TV.H : 1.5DIV (1.5V) AC : Frequencies lower than 10Hz are attenuated. HF : Frequencies higher than 50kHz are attenuated.	The figures enclosed in the parentheses are EXT trigger input sensitivities. Specification for TV.V and TV.H are applicable to NTSC field color bar signals.
LEVEL AUTO	When in the LEVEL AUTO, add 0.5DIV (0.25V) to the above values.	For a sine wave, the LEVEL AUTO is attained when the LEVEL knob is turned fully counterclockwise.
Trigger modes	AUTO: When no trigger signal is applied, the sweep runs automatically (free run). NORM: When no trigger signal is applied, no sweep runs (the sweep remains in the ready state). SINGLE: When the trigger signal is applied, the sweep runs only once. It is reset to Ready state with the RESET switch. The READY LED lights up when in the Ready state or when the sweep is running.	In Real Mode.
EXT trigger input	The EXT Z-axis input terminal also works as EXT trigger input terminal.	
Input impedance	1M $\Omega$ $\pm$ 10%, 21pF $\pm$ 2pF	
Maximum allowable input voltage	100Vpeak (DC + ACpeak)	AC: 1kHz or below

## ○ Horizontal Axis (Timebase)

Item	Specification	Remarks
Sweep speed (timebase)	COR5501U Real : 20ns/DIV - 0.5s/DIV Storage : 20ns/DIV - 5s/DIV	1-2-5 sequence 23 way setups 26 way setups
	COR5500U: 20ns/DIV - 0.5s/DIV	1-2-5 sequence 23 ways
	COR5561U Real : 50ns/DIV - 0.5s/DIV Storage : 50ns/DIV - 5s/DIV	1-2-5 sequence 22 way setups 25 way setups
	COR5560U: 50ns/DIV - 0.5s/DIV	1-2-5 sequence 22 ways
Timebase accuracy	±3%	15 to 35°C (59°F to 95°F) Accuracy of timebase for 8DIV sweep in center of screen
Variable control of timebase	Slows the timebase down to 1/2.5 of the nominal timebase.	In Real Mode
Variable Holdoff	Provided	In Real Mode
Sweep magnification	5, 10, or 50 times COR5500U, COR5501U Maximum timebase: 2ns/DIV COR5560U, COR5561U Maximum timebase: 5ns/DIV	×50 is for 0.5μs/DIV to 0.5s/DIV only. Center of magnification: Center of CRT screen
Sweep magnification accuracy	×5, ×10: ±4% ×50: ±6%	15 to 35°C (59°F to 95°F) Accuracy of timebase in the central 8DIV of graticule, except 10% portions from both ends of sweep.
Sweep modes	Main sweep (original sweep), Alternate Magnified sweep, Magnified sweep	Alternate Magnified sweep mode: Main sweep and magnified sweep alternately.
Trace separation	±4DIV or more of separation distance among two traces	When in Alternate Magnified sweep mode, the magnified trace can be vertically moved apart from the main trace.
X-Y mode	X-axis: CH1 Y-axis: CH2	In Real Mode
Deflection factors	Identical with those of CH1 or CH2.	
Deflection factor accuracies	X-axis: ±4% (5mV/DIV - 5 V/DIV) ±6% (1mV/DIV - 2mV/DIV) Y-axis: The same as CH2.	15 to 35°C (59°F to 95°F) With reference to a standard signal of 1kHz, 5 DIV signal.
Frequency bandwidth	DC - 2MHz (-3dB) Y-axis: The same as CH2.	
X-Y phase shift	DC - 100kHz: Within 3 degrees	



Item	Specification	Remarks
<p>Setting display (continued)</p>	<p>For Storage Mode only</p> <ul style="list-style-type: none"> <li>A. ACQUISITION MODE NORM, ROLL, RPT, IPL</li> <li>B. TRIG POINT (TP) or MAG POINT (MP) TP0, TP1, TP5, TP9 or MP0, MP1, MP5, MP9</li> <li>C. reserved</li> <li>D. VIEW TIME ▲</li> <li>E. INTERPOLATE LIN, CRV</li> <li>F. SAVE MEMORY 1 SCALE FACTOR</li> <li>G. SAVE MEMORY 2 SCALE FACTOR</li> <li>H. STORAGE MENU ROLL ON/OFF</li> <li>I. STORAGE MENU RPT ON/OFF</li> <li>J. reserved</li> <li>K. STORAGE MENU INTRPL LIN/CRV</li> <li>L. STORAGE MENU VIEW T ON/OFF</li> <li>M. STORAGE MENU PLOT N, S1, S2, S3, S4, CTR, OFF</li> <li>N. PAUSE</li> <li>O. PLOT MODE PLOT OUT, PLOT ABORT, PLOT END, PLOT ERROR</li> <li>P. MESSAGE CAUTION</li> <li>Q. MESSAGE CHANGE GP-IB to TALK ONLY CHANGE HORIZ MAG to X1 PANEL SETUP differ with READOUT</li> <li>R. CURSOR KNOB FUNCTION WINDOW</li> </ul>	

Item	Specification	Remarks
$\Delta T$	Time interval measurement with CURSOR1 and CURSOR2	
Measuring range	$\pm 4.6\text{DIV}$ at the center of CRT screen	
Measuring accuracy	$\pm (3\% \text{ of reading} + 0.05\text{DIV})$	When MAG is off
$1/\Delta T$	$1/\Delta T$ (frequency) measurement by determining time interval	
$\Delta V$	Voltage measurement with CURSOR1 and CURSOR2	
Measuring range	$\pm 3.6\text{DIV}$ at the center of CRT screen	
Measuring accuracy	$\pm (3\% \text{ of reading} + 0.05\text{DIV})$	
$\Delta T(\text{DIV})$	Horizontal span measurement with CURSOR1 and CURSOR2	
Measuring range	$\pm 4.6\text{DIV}$ at the center of CRT screen	
Measuring accuracy	$\pm (3\% \text{ of reading} + 0.05\text{DIV})$	When MAG is OFF
$\Delta V(\text{DIV})$	Vertical amplitude measurement with CURSOR1 and CURSOR2	
Measuring range	$\pm 3.6\text{DIV}$ at the center of CRT screen	
Measuring accuracy	$\pm (3\% \text{ of reading} + 0.05\text{DIV})$	

○ Storage Mode (COR5501U, COR5561U)

Item	Specification	Remarks
Vertical resolution	8 bits (25 points/DIV)	
Horizontal resolution	12 bits (400 points/DIV)	
Sampling rate	Regular sampling operation : 20S/sec - 20MS/sec Repetitive Sampling Mode : 20MS/sec - 2 GS/sec (virtually)	
Accuracy of sampling rate	±0.05% (at regular sampling)	
Vertical deflection factor accuracy	CH1, CH2 5mV/DIV - 5 V/DIV : ±(3% + 1LSB) 1mV/DIV, 2mV/DIV : ±(5% + 1LSB)	15 to 35°C (59°F to 95°F) with 1kHz, 4 - 5DIV as reference
Frequency bandwidth	COR5501U DC - 100MHz (-3dB) DC - 20MHz (-3dB) (1mV/DIV and 2mV/DIV)	15 to 35°C (59°F to 95°F) with 50kHz, 8DIV as reference
	COR5561U DC - 60MHz (-3dB) DC - 20MHz (-3dB) (1mV/DIV and 2mV/DIV)	15 to 35°C (59°F to 95°F) with 50kHz 8DIV as reference
Effective storage frequency	COR5501U 5.7MHz : with 10µs/DIV or faster, in Single Trigger mode, with Curve Interpolation 100MHz, -3dB : for repetitive signal, with timebase for Repetitive Mode	
	COR5561U 5.7MHz : with 10µs/DIV or faster, in Single Trigger mode, with Curve Interpolation 60MHz, -3dB : for repetitive signal, with timebase for Repetitive Mode	
Effective rise time	COR5501U 80ns or faster : with 10µs/DIV or faster, in Single Trigger mode, with Linear Interpolation 3.5ns or faster : for repetitive signal, with timebase for Repetitive Mode	
	COR5561U 80ns or faster : with 10µs/DIV or faster, in Single Trigger mode, with Linear Interpolation 5.8ns or faster : for repetitive signal, with timebase for Repetitive Mode	

Item	Specification	Remarks
Performance for pulse signals	5mV/DIV - 0.5V/DIV range Overshoot : (3% + 1LSB) or less Ringing : (3% + 1LSB) or less Aberration : (5% + 1LSB) or less Lower frequency distortion (sag) of 100Hz - 100kHz: (2% + 1LSB) or less In Addition mode: (Each of above value) + 3%	15 to 35°C (59°F to 95°F) with 5DIV as reference
Timebase range and channels	Simultaneous 2-channel sampling at all timebases	
Repetitive mode	20ns/DIV - 10μs/DIV for COR5501U (can be turned ON and OFF)	Random Equivalent Sampling, except when in Single Trigger mode
	50ns/DIV - 10μs/DIV for COR5561U (can be turned ON or OFF)	Random Equivalent Sampling, except when in Single Trigger mode
Roll mode	0.2s/DIV - 5s/DIV (can be turned ON or OFF)	
Paused Magnification function	In Paused state, sweep can be magnified by up to 1000 times by TIME/DIV knob. MP (magnification point): 0, 1, 5, or 9DIV	The sweep is magnified to right and left with the trigger point as a center of magnification.
Window function	Paused Magnification portion of the waveform can be horizontally scrolled with the Window function.	Available when magnification factor is twice or greater.
Magnification by MAG Switch	×5, ×10, and ×50 (×50 is uncalibrated)	When in ×50, "UNCAL" appears at screen data position 4.
Magnified portion of waveform	Center of CRT screen	
Magnification accuracy	×5, ×10: ±3%	
Display memory	4,096 words ×2 channels	
Saving memory	For two waveforms 4,096 words ×2 channels	Data can be stored onto the Saving Memory when in Paused state.
Pretrigger	Trigger point can be set at 0, 1, 5, or 9DIV position on CRT screen.	
View Time	Approx. 1 sec (can be turned ON or OFF)	

○  **GPIB Interface (Optional Feature for COR5501U and COR5561U)**

**(1) Interface Standards**

Based on ANSI/IEEE std488 - 1978, and IEC625

**(2) Interface Functions**

Code	Functions
SH1	With all source handshake functions
AH1	With all acceptor handshake functions
T5	With talker functions (basic output, serial poll, talk only, and talker release by listener designation)
L4	With listener functions (basic input, and listener release by talker designation)
SR1	With all service request functions
RL0	Without remote/local changing function
PP0	Without parallel polling function
DC1	With all device clear functions
DT0	Without device trigger function
C0	Without control function
E0	Without talker or listener expansion function

**(3) Formats**

Device commands : ASCII

Waveform data : Binary (BYTE, LWORD, and HWORD)

**(4) Commands**

**(a) Functions**

On/off for SRQ  
 On/off for EOI  
 Resetting the Single Trigger operation in Storage Mode.  
 Start or end block for waveform data transfer  
 Specifying a format for waveform data transfer

**(b) Data items readable**

Model name  
 Setting of VERT MODE  
 Settings of VOLT/DIV (deflection factor)  
 Setting of HORIZ MODE  
 Setting of TIME /DIV (timebase and magnification)  
 Settings of TRIGGER  
 Settings of Storage Menu or Active Display Mode  
 Setting and Measured data of CURSORS  
 Contents of COMMENTS  
 Waveform data (CH1, CH2, MEM1, and MEM2)

## ○ Z-axis

Item	Specification	Remarks
EXT Z input terminal	EXT TRIG input terminal is also used in common for EXT Z input.	The terminal serves as EXT Z input terminal when Trigger SOURCE switch is placed at VERT, CH1, or CH2.
Sensitivity and polarity	Intensity modulation discernible with 3 Vp-p input signal. Negative voltage for brighter trace and positive voltage for dimmer trace.	
Frequency bandwidth	DC - 5MHz	
Input resistance	1 M $\Omega$ $\pm$ 10%	
Maximum allowable input voltage	100 V peak (DC + AC peak)	AC: 1kHz or below

## ○ Calibration Signal

Item	Specification	Remarks
Waveform	Positive pulse signal	
Frequency	1kHz $\pm$ 5%	
Duty ratio	Within 45:55	
Output voltage	0.5 Vp-p $\pm$ 2%	
Output impedance	Approx. 2k $\Omega$	

## ○ CRT

Item	Specification	Remarks
Cathode-ray tube	6-inch square screen, with white internal graticule. Effective screen size: 8 $\times$ 10 cm (3.15 $\times$ 3.94in.)	
Acceleration voltage	COR5500U, COR5501U: Approx. 18 kV COR5560U, COR5561U: Approx. 12 kV	

## ○ AC Line Power Requirements

Item	Specification	Remarks
Line voltage	Rated line voltage range : 100V - 240V Allowable line voltage range: 90V - 250V	
Line frequency	Rated line frequency range : 50Hz - 400Hz Allowable line frequency range: 45Hz - 440Hz	
Power consumption	COR5501U, COR5561U: 62W (90VA) maximum COR5500U, COR5560U: 50W (72VA) maximum	

## ○ Environments

Item	Specification	Remarks
Ambient temperature		
To meet performance specifications	+ 10 to + 40°C (50°F to 104°F)	
Allowable range (in operation)	0 to + 50°C (32°F to 122°F)	
When not operating (storage range)	- 40 to + 71°C (- 40°F to 159°F)	
Humidity		
Allowable range (in operation)	10 to 30°C (50°F to 86°F) : 95% RH 31 to 40°C (87°F to 104°F) : 75% RH 41 to 50°C (105°F to 122°F) : 45% RH	
When not operating	0 to 50°C (32°F to 122°F) : 95% RH	
Altitude		
Allowable range (in operation)	Up to 4500 meters When altitude is higher than 1500 meters, the maximum operable temperature falls at a rate of 1°C per 300 meters	
When not operating	Up to 12,000 meters	
Mechanical vibration	Frequency 10 - 55Hz Sweep time : 15 minutes Amplitude : 0.3 mm Acceleration : 1.8G (55Hz)	
Mechanical shocks	30G, sine half-wave, duration 11msec, applied three times in each of the positive and negative directions on each of the three mutually perpendicular axes (total 18 times)	
EMI	Based on VDE 0871 Class B, and FCC Class B	
EMC	Complied with the following standards European Community Requirements (89/336/EEC) EN 55011 Radiated Emissions Class A Conducted Emissions Class A EN50082-1 IEC801-2 Electro-static Discharge IEC801-3 Radiated Susceptibility IEC801-4 Fast Burst Transient	*1
Safety	Complied with the following standards European Community Requirements (73/23/EEC)	*1

\*1 : CE markings are put only on the product sold in Europe.

○ **Memory Backup**

Data items backed up : Panel setup data and waveform data  
 Backup battery : Lithium battery  
 Life expectancy of battery : 3 years (at 25°C) after shipment by oscilloscope manufacturer

○ **Dimensions and Weight**

Dimensions (excluding protrusions) : 330 W × 125 H × 360 D (mm)  
 12.99 W × 4.92H × 14.17 D (in.)  
 (Maximums) : 360 W × 145 H × 420 D (mm)  
 14.17 W × 5.71H × 16.54 D (in.)

Weight COR5501U, COR5561U : Approx. 6.5 kg (14.3lbs.)  
 COR5500U, COR5560U : Approx. 6 kg (13.2lbs.)

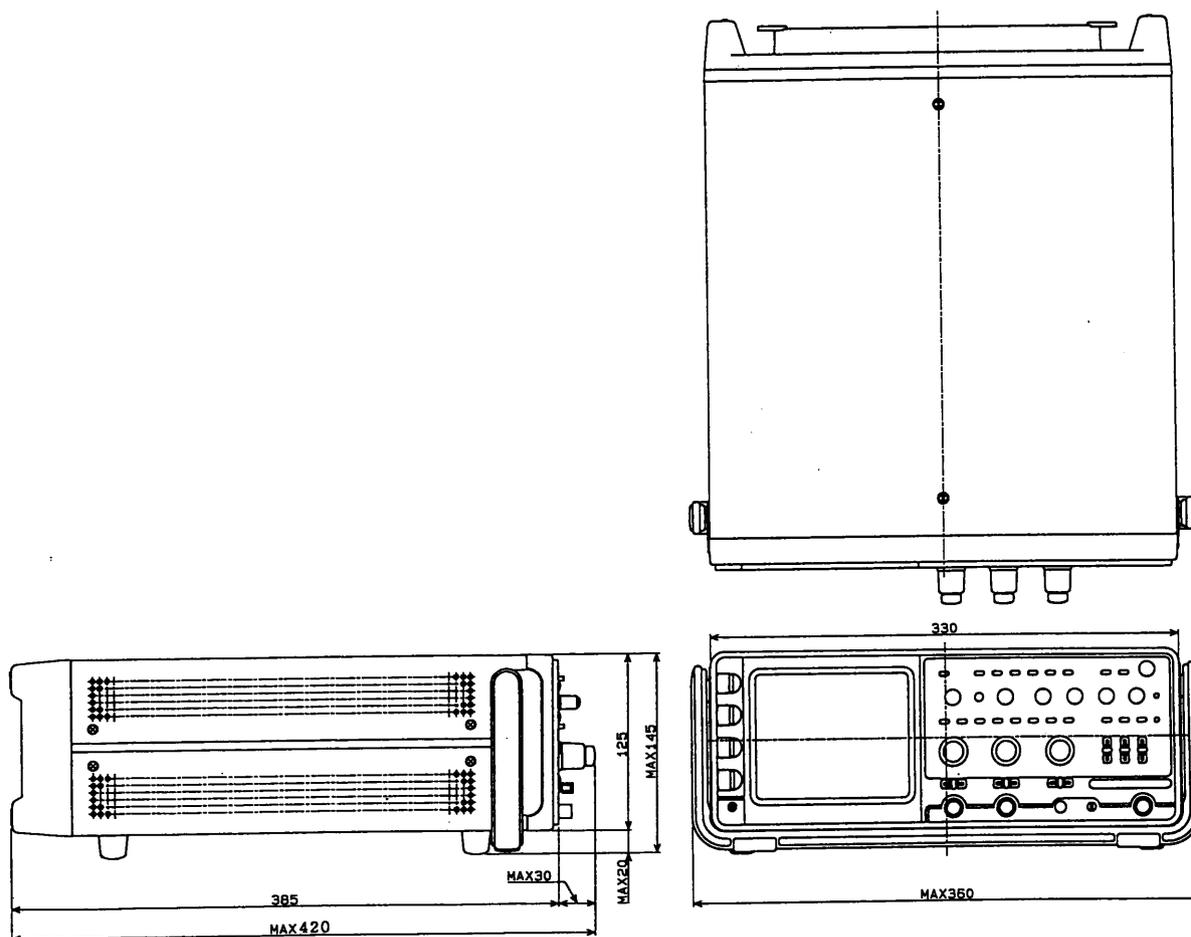

Figure 7-1. Overall Views and Dimensions

SPECIFICATIONS

○ **Accessories**

AC power cable ×1 (shown in page ii)

AC power fuse ×2 Two fuses (one for replacement spare) are put in the holder cap. (99-00-0026)

Operation manual ×1 (Z1-000-123)

Probe

COR5500U, COR5501U: P100-8CE (10:1) ×2  
(89-03-0421)

COR5560U, COR5561U: P060-6CE (10:1/1:1) ×2  
(89-03-0411)

○ **Optional Items**

Protective front cover

Camera mount

GPIB Interface (IF01-COR)

(available on COR5501U or COR5561U)

Enhanced magnetic shield cylinder for CRT

(factory option)

# Index

## Front and Rear Panels

AC -----	5-2, 5-5	PLOT -----	5-19
AC LINE -----	5-17	POSITION -----	5-3
ADD -----	4-3	POWER -----	5-1
ALT -----	5-8	PROBE -----	3-3
ALT/CHOP -----	5-3	R INTEN -----	5-1
AUTO -----	5-6	READY -----	5-6
CAL terminal -----	5-16	RESET -----	4-4
CAL'D -----	5-3, 5-7	ROLL -----	5-19
CH1 SIGNAL OUT -----	5-17	RPT -----	5-19
CH1 X -----	5-2	SAVE -----	4-48
CH2 Y -----	5-2	SAVE PLOT -----	5-20
CMNT/CUR -----	5-9	SINGLE/RESET -----	5-6
COARSE -----	5-8	SLOPE -----	5-5
CPLG -----	5-5	SOURCE -----	5-4
DC -----	5-2, 5-5	STATUS -----	5-19
DUAL -----	5-3	STRG/REAL -----	5-18
EXT -----	5-4, 5-6	TIME/DIV -----	5-7
FINE -----	5-8	TRACE ROTATE -----	5-17
FOCUS -----	5-1	TRACE SEP -----	5-3
GND terminal -----	5-16	TRIG PT -----	5-20
HF -----	5-5	TRIG'D LED -----	5-5
HOLD OFF -----	5-6	TV -----	5-5
HORIZ MODE -----	5-8	VARIABLE, vertical -----	5-3
ILLUM -----	5-1	VARIABLE, horizontal -----	5-7
INTEN -----	5-1	VERT -----	5-4
INTRPL -----	5-19	VERT MODE -----	5-3
INV -----	5-3	VIEW T -----	5-19
LEVEL -----	5-5	VOLT/DIV -----	5-2
LEVEL AUTO -----	4-9, 5-5	X-Y -----	5-8
LINE (+, -) -----	5-5		
LOAD -----	5-20		
MAG -----	5-8		
MAG PT -----	5-20		
MENU -----	5-18		
MODE -----	5-9 through 5-11		
NORM -----	5-6		
PAUSE -----	5-20		

## Alphabetic

AC	
Input Coupling -----	4-1
Line Voltage -----	2-2, 7-11
Power Cable -----	ii
Power Fuse -----	2-2
Trigger Coupling -----	4-6
Addition Mode -----	4-3
Aliasing -----	4-39

Alternate Magnified Sweep -----	4-12	Horizontal Axis	
Alternate Mode -----	4-2	HORIZ MODE -----	4-11
Alternate Trigger Mode -----	4-2	Magnification -----	4-12, 4-46
Auto Trigger Mode -----	4-4	Position -----	4-12
Backup Battery -----	6-1	Timebase -----	4-11
CRT		Window -----	4-46
Control -----	3-2	Initial Setup -----	3-1
Filter -----	6-2	Input Coupling -----	4-1
Cable Take-up -----	5-17	Intensity Modulation -----	4-16
Channel display -----	4-1	Interpolation -----	4-40
Chopping Mode -----	4-2	Linear Interpolation -----	4-40
Comment		Lissajous Figure -----	4-14
Deletion -----	4-20	Magnification	
Display -----	4-17	Alternate -----	4-12
Entry -----	4-17	Magnification Point -----	4-46
Modification -----	4-19	Paused -----	4-46
Cursor		Window -----	4-46
CURSOR1, CURSOR2 -----	4-22, 5-15	Maximum Sampling rate -----	4-51
Knob (  ) -----	4-17, 4-22, 5-9, 5-15	Measurement	
MODE -----	4-22	Frequency -----	4-14, 4-26
TRACKING -----	5-15	Overshoot -----	4-28
$\Delta T$ -----	4-22, 5-13	Phase Difference -----	4-15, 4-25
$\Delta T(\text{DIV})$ -----	4-24, 5-14	Time Interval -----	4-22
$\Delta V$ -----	4-27, 5-11	Voltage -----	4-27
$\Delta V(\text{DIV})$ -----	4-28, 5-12	Model Types -----	1-1
$1/\Delta T$ -----	4-26, 5-14	Negative Slope -----	4-8
Curve Interpolation -----	4-40	Normal Trigger Mode -----	4-4
DC		Nyquist Frequency -----	4-39
Input Coupling -----	4-1	Option Slot -----	5-17
Trigger Coupling -----	4-7	Overshoot Measurement -----	4-28
Deflection Factor -----	4-1	Pause Function -----	4-45
Diagnosis -----	2-7	Paused Magnification -----	4-46
Dual Trace Operation -----	4-2	Perceptual Aliasing -----	4-39
Duty Ratio Measurement -----	4-24	Phase Difference Measurement -----	4-15, 4-25
Effective Storage Frequency -----	4-51	Position	
Equivalent Sampling -----	4-37	Horizontal -----	4-12
Fan -----	5-17	Vertical -----	4-3
Frequency Measurement -----	4-14, 4-26	Window Scroll -----	4-47
Fuse replacement -----	2-2	Positive Slope -----	4-8
GPIB -----	4-32, 7-10	Post Trigger -----	4-44
Handle/Stand -----	2-5	Pretrigger -----	4-44
Holdoff -----	4-10	Probe	
		Phase compensation -----	3-3
		Scale factor -----	3-5

ROM version -----	i	Trig'd Roll Operation -----	4-43
Random Sampling -----	4-38	Trigger	
Readout message		Coupling -----	4-6
BACKUP BATTERY		Level -----	4-9
EMPTY? -----	6-1	Mode -----	4-4
CMNT1, CMNT2 -----	4-17	Point -----	4-44
INVALID -----	4-11, 4-31	Slope -----	4-8
LIMIT -----	5-2, 5-7, 5-15	Source -----	4-5
MEM1, MEM2, MEM12 -----	4-48	Vertical Axis -----	4-1
PAUSE -----	4-45, 5-20	Video Signal -----	4-7
SEL, SPC, ERS, < -----	4-18	View Time -----	4-22
UNCAL -----	4-11, 4-31	Voltage Measurement -----	4-27
asterisk (*) -----	4-46	Voltage Ratio Measurement -----	4-28
Real Mode -----	4-1	Waveform	
Realtime Sampling -----	4-37	Magnification -----	4-11, 4-46
Repetitive Mode -----	4-36, 4-50	Memory Capacity -----	1-2
Rise Time Measurement -----	4-23	Resolution -----	1-2
Roll Mode -----	4-34, 4-50	Window -----	4-46
Sampling Mode		X-Y Operation -----	4-13
Equivalent -----	4-37	Z-axis -----	4-16
Interpolation -----	4-40		
Random -----	4-38		
Repetitive -----	4-36		
Sequential -----	4-37		
Sampling Rate -----	4-51		
Saving Memory -----	4-48		
Sequential Sampling -----	4-37		
Single Sweep -----	4-50		
Single Trace Operation -----	4-2		
Single Trigger Mode -----	4-4, 4-48		
Specifications -----	7-1 through 7-14		
Stand/Handle -----	2-5		
Storage Menu -----	4-32		
INTRPL -----	4-40		
PLOT -----	4-32		
ROLL -----	4-34		
RPT -----	4-36		
VIEW T -----	4-42		
Storage Mode -----	4-30		
Subtraction Mode -----	4-3		
Sweep Mode ALT/CHOP -----	4-2		
TV signal -----	4-7		
Time Interval Measurement -----	4-22		
Timebase -----	4-11		
Trace Rotation -----	3-3		