

INSTRUCTION MANUAL

OSCILLOSCOPE

MODELS COS5040/COS5041

KIKUSUI ELECTRONICS CORPORATION

TABLE OF CONTENTS

	<u>PAGE</u>
1. GENERAL	1
1.1 Description	1
1.2 Features	1
2. SPECIFICATIONS	3
3. PRECAUTIONS BEFORE OPERATING THE OSCILLOSCOPE	10
3.1 Unpacking the Oscilloscope	10
3.2 Checking the Line Voltage	10
3.3 Environments	10
3.4 CRT Intensity	11
3.5 Withstanding Voltages of Input Terminals	11
4. OPERATION METHOD	12
4.1 Explanation of Front Panel	12
4.2 Explanation of Rear Panel	20
4.3 Basic Operation	25
4.4 Dual-channel Operation	27
4.5 ADD Operation	28
4.6 X-Y Operation and EXT HOR Operation	28
4.7 Triggering	30
4.8 Single-sweep Operation	35
4.9 Sweep Magnification	36
4.10 Waveform Magnification with Delayed Sweep	37
(COS5041 only)	
4.11 Calibration of Probe	41
* BLOCK DIAGRAM	

1. GENERAL

1.1 Description

Kikusui Model COS5040/5041 Oscilloscope is a dual-channel oscilloscope with frequency bandwidth DC - 40 MHz (-3 dB), maximum sensitivity 1 mV/DIV, and maximum sweep time 20 nsec/DIV. Model 5041 has a sweep magnification feature with B sweep. The oscilloscope employs a 6-inch rectangular type cathode-ray tube with red internal graticule.

The oscilloscope is sturdy, easy to operate, and exhibits a high operation reliability. It is incorporated with the various convenient features and excellent functions, making itself an ideal instrument for diversified types of research and development work of electronic devices and equipment it can also be efficiently used for production lines and for maintenance and service.

1.2 Features

(1) Compact, light, but sturdy:

The oscilloscope is made of aluminium diecast and it is compact, light, but sturdy.

(2) Excellent operability:

Light torque types of lever switches and pushbutton switches are used. These and other controls are laid out in the most rational locations taking purposes and frequencies of their uses into consideration, thereby attaining an excellent operability.

(3) High-brightness Domed-mesh type CRT, high post acceleration voltage. (12 kV):

The high acceleration voltage and high beam-efficiency of CRT ensures a bright trace for high speed sweep observation.

(4) High stability with less drift:

The oscilloscope employs a newly-developed temperature compensation circuit, thereby greatly reducing drift of base lines and DC balance disturbance caused by temperature change.

(5) A trigger level lock function which makes triggering adjustment procedure unnecessary:

A new trigger level lock circuit is incorporated. This circuit eliminates the requirement of troublesome triggering adjustment procedure not only for display of regular signals but also for that of video signals and large duty cycle ratio signals.

(6) TV sync triggering:

The oscilloscope has a sync separator circuit and triggering for TV V signal and TV H signal can be automatically switched being linked to the TIME/DIV switch.

(7) Linear focus:

Once the beam focus is adjusted to the optimum position, it is automatically maintained irrespective of intensity change, even for such waveforms with brightness variation as those displayed in the A INTEN mode.

2. SPECIFICATIONS

Vertical axes

Item	Specification	Remarks
Sensitivity	NORM: 5 mV - 5 V/DIV ×5 MAG: 1 mV - 1 V/DIV	1-2-5 sequence, 10 ranges
Sensitivity accuracy	NORM: ±3% or better ×5 MAG: ±5% or better	10 to 35°C (50 to 95°F), 1 kHz, at 4 or 5 DIV
Vernier vertical sensitivity	To 1/2.5 or less of panel-indicated value	
Frequency bandwidth	NORM: DC - 40 MHz, within -3 dB ×5 MAG: DC - 20 MHz, within -3 dB AC coupling: Low limit frequency 10 Hz	With reference to 50 kHz, 8 DIV
Rise time	NORM: Approx. 8.75 nsec ×5 MAG: Approx. 17.5 nsec	
Input impedance	1 MΩ ±2%, 25 pF ±2 pF	
Square wave characteristics	Overshoot: Not greater than 5% Other distortions: Not greater than 3% (At 10 mV/DIV range)	Other ranges: 3% added to the left values. 10 to 35°C (50 to 95°F)
DC balance shift	NORM: ±0.5 DIV ×5 MAG: ±2.0 DIV	
Linearity	±0.1 DIV or less of amplitude change when waveform of 2 DIV at graticule center is moved vertically.	
Display modes	CH1: CH1 single channel	When CH1 POSITION knob is pulled out (CHOP ONLY position), the two traces are displayed in the CHOP mode at all ranges.
	CH2: CH2 single channel	
	DUAL: CHOP: 0.5 sec - 1 msec/DIV ALT: 0.5 msec - 0.2 μsec/DIV	

Item	Specification	Remarks
	ADD: CH1 + CH2 algebraic addition	
Chopping repetition frequency	Approx. 250 kHz	
Input coupling	AC/GND/DC	
Maximum allowable input voltage	400 V (DC + AC peak)	AC: 1 kHz or lower
Common mode rejection ratio	50:1 or better at 50 kHz, sinusoidal wave	When sensitivities of CH1 and CH2 are set equal
Isolation between channels	At least 1000:1 at 50 kHz At least 30:1 at 40 MHz	At 5 mV/DIV range
CH1 signal output	Approx. 100 mV/DIV when open; approx. 50 mV/DIV when 50-ohm termination	
CH2 INV BAL	Balanced point variation, 1 DIV or less	PULL CH2 POSITION (Reference at center graticule)
Signal delay time	Approx. 40 nsec (with delay cable of approx. 120 nsec)	The displayed portion preceding the triggering point

Triggering

Item	Specification	Remarks
Triggering source	CH1, CH2, LINE, and EXT (CH1 and CH2 can be selected only when the vertical mode is DUAL or ADD. In other cases, triggering source is automatically selected by the VERT MODE switch.)	
Coupling	AC, HF REJ, TV, DC	
Polarity	+ or -	

Item	Specification	Remarks
Sensitivity	DC - 10 MHz: 0.5 DIV (0.1 V) DC - 40 MHz: 1.5 DIV (0.2 V) Video signal: 2.0 DIV (0.2 V) AC coupling: Attenuate signal components of lower than 10 Hz HF REJ: Attenuate signal components of higher than 50 kHz	The values enclosed in the parentheses are the input sensitivities when in the EXT triggering mode.
Triggering modes	AUTO: Sweeps run in the free mode when no triggering input signal is applied.	Satisfies the sensitivity specification for signal repetition frequency of 50 Hz or over.
	NORM: When no triggering signal is applied, the trace is in the READY state and not displayed. SINGL: One-shot sweep with triggering signal. Can be reset to the READY state by means of RESET switch. The READY lamp (LED) turns on when in the READY state or in the sweep operation.	
LEVEL LOCK	Satisfies the value of the above trigger sensitivity plus 0.5 DIV (0.05 V) for signal of duty cycle 20:80 and repetition frequency 50 Hz - 40 MHz.	
EXT triggering signal input	EXT HOR input terminal is used in common.	
Input impedance	1 M Ω \pm 2%, approx. 25 pF	
Maximum allowable input voltage	100 V (DC + AC peak)	AC frequency not higher than 1 kHz
B triggering signal	The A triggering signal of main sweep is used as the B triggering signal.	<u>Model COS5041 only</u>

Horizontal axis

Item	Specification	Remarks
Horizontal axis display	A, A INT, B, B TRIG'D	COS5041 only
A sweep (main sweep)		
Sweep time	0.2 μ sec - 0.5 sec/DIV	1-2-5 sequence, 20 ranges
Sweep time accuracy	$\pm 3\%$	10 to 35°C (50 to 95°F)
Vernier sweep time control	To 1/2.5 or slower of panel-indicated value	
Holdoff time	Continuously variable to 2 times or over of sweep length (time) at 0.2 μ sec/DIV - 1 msec/DIV ranges	
B sweep		
Delay system	Continuous delay and triggered delay	COS5041 only. Triggered by A triggering signal
Sweep time	NORM: 0.2 μ sec/DIV - 0.5 msec/DIV $\times 10$ MAG: 20 nsec/DIV - 50 μ sec/DIV	
Sweep time accuracy	NORM: $\pm 3\%$	10 to 30°C (50 to 95°F)
Delay time	2 μ sec - 5 sec/DIV	
Delay time accuracy	$\pm 4\%$ of the value read on CRT	
Delay jitter	1/10,000 or less $\frac{\text{B sweep time}}{\text{A sweep time}} \times \frac{\text{jitter width}}{10 \text{ DIV}}$	Jitter width 0.5 DIV or less at A: 1 msec/DIV B: 1 μ sec/DIV
Sweep magnification	10 times (maximum sweep time 20 nsec/DIV)	
Magnified sweep time accuracy	0.1 μ sec/DIV - 0.5 sec/DIV ranges: $\pm 5\%$ 0.2 μ sec/DIV - 0.5 μ sec/DIV ranges: $\pm 8\%$	10 to 35°C (50 to 95°F)
Linearity	NORM: $\pm 3\%$ $\times 10$ MAG: $\pm 5\%$ ($\pm 8\%$ for 0.2 μ sec and 0.5 μ sec/DIV)	

Item	Specification	Remarks
Position shift caused by sweep magnification	Within 1 DIV at CRT screen center	
X-Y mode	X-axis: CH1 input signal Y-axis: CH2 input signal	
Sensitivity	Same as CH1 vertical axis	
Sensitivity accuracy	NORM: $\pm 4\%$ $\times 5$ MAG: $\pm 6\%$	10 to 35°C (50 to 95°F), 1 kHz, at 4 or 5 DIV
Frequency bandwidth	DC - 2 MHz (-3 dB)	
X-Y phase difference	Not greater than 3° at DC - 100 kHz	
EXT HOR mode	Trace swept by an external horizontal signal applied to the EXT TRIG IN terminal. Vertical axis modes are CH1, CH2, DUAL and ADD modes in the CHOP mode.	
Sensitivity	Approx. 0.1 V/DIV	
Frequency bandwidth	DC - 2 MHz (-3 dB)	
Phase difference between vertical axis	Within 3° (at DC - 100 kHz)	

Z axis

Item	Specification	Remarks
Sensitivity	3 Vp-p (Trace becomes brighter with negative input.)	
Frequency bandwidth	DC - 5 MHz	
Input resistance	Approx. 5 k Ω	
Allowable input voltage	50 V (DC + AC peak)	AC frequency not higher than 1 kHz

Calibration voltage

Item	Specification	Remarks
Waveform	Positive-going square wave	
Frequency	1 kHz \pm 20%	
Duty ratio	Within 45:55	
Output voltage	2 V _{p-p} , \pm 2%	
Output resistance	Approx. 2 k Ω	

CRT

Item	Specification	Remarks
Type	6-inch rectangular type, internal graticule	
Phosphor	P31	
Acceleration voltage	Approx. 12 kV	
Effective screen size	8 \times 10 DIV	1 DIV = 10 mm (0.39 in.)
Graticule	Internal graticule; continuously adjustable illumination	

Line power requirements

Voltage: 100 V, 115 V, 215 V, 230 V; with \pm 10% allowance.

Selectable by connector change

Frequency: 50 Hz or 60 Hz

Power consumption: Approx. 35 VA

Mechanical specifications

Mainframe dimensions: 280 W \times 150 H \times 370 D mm
(11.02 W \times 5.91 H \times 14.57 D in.)

Maximum dimensions: 285 W \times 175 H \times 440 D mm
(11.22 W \times 6.89 H \times 17.32 D in.)

Weight: Approx. 7.4 kg (16.3 lbs)

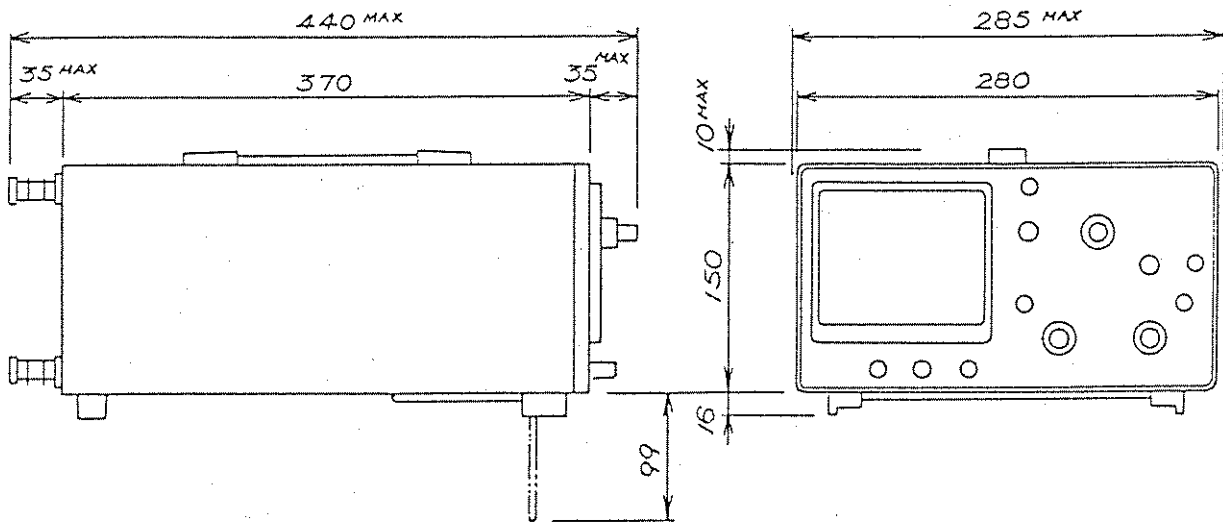

Operating environment

To satisfy specifications: 5 to 35°C (41 to 95°F), 85% RH

Maximum operating ranges: 0 to 40°C (32 to 104°F), 90% RH

Accessories

P060-S probes (10:1, 1:1, 1.5 m) ...	(89-03-0300)	2
942A terminal adaptors	(W4-986-011)	2
Power cord		1
Instruction manual		1

o Specifications and contents on this manual are subject to change without notice.

3. PRECAUTIONS BEFORE OPERATING THE OSCILLOSCOPE

3.1 Unpacking the Oscilloscope

The oscilloscope is shipped from the factory after being fully inspected and tested. Upon receipt of the instrument, immediately unpack and inspect it for any damage which might have been sustained when in transportation. If any sign of damage is found, immediately notify the bearer and/or the dealer.

3.2 Checking the Line Voltage

The oscilloscope can operate on any one of the line voltages shown in the below table, by inserting the line voltage selector plug in the corresponding position on the rear panel. Before connecting the power plug to an AC line outlet, be sure to check that the voltage selector plug is set in the correct position corresponding to the line voltage. Note the oscilloscope may not properly operate or may be damaged if it is connected to a wrong voltage AC line.

When line voltages are changed, replace fuses also as required.

Selector plug position	Nominal voltage	Voltage tolerance	Fuse
A	100 V	90 - 110 V	0.5 A(S.B)
B	115 V	104 - 125 V	
C	215 V	194 - 236 V	0.3 A(S.B)
D	230 V	207 - 250 V	

3.3 Environments

The normal ambient temperature range of this instrument is 0 to 40°C (32 to 104°F). Operation of the instrument outside of this temperature range may cause damage to the circuits.

Do not use the instrument in a place where strong magnetic or electric field exists. Such fields may disturb the measurement.

3.4 CRT Intensity

In order to prevent permanent damage to the CRT phosphor, do not make the CRT trace excessively bright or leave the spot stationary for an unreasonably long time.

3.5 Withstanding Voltages of Input Terminals

The withstanding voltages of the instrument input terminals and probe input terminals are as shown in the following table. Do not apply voltages higher than these limits.

Input terminal	Maximum allowable input voltage
CH1, CH2, inputs	400 V (DC + AC peak)
EXT TRIG input	100 V (DC + AC peak)
Probe inputs	600 V (DC + AC peak)
Z AXIS input	50 V (DC + AC peak)

Note: AC frequency not higher than 1 kHz.

4. OPERATION METHOD

4.1 Explanation of Front Panel (See Figures 4-1 and 4-2.)

o CRT circuits:

- POWER ③ Main power switch of the instrument.
When this switch is turned on, the
LED ② above the switch is also
turned on.
- INTEN ④ Controls the brightness of the spot
or trace
- B INTEN ⑤ Semi-fixed potentiometer for adjusting
(COS5041 only) trace intensity when in B sweep mode.
- FOCUS ⑥ For focusing the trace to the sharpest
image.
- ILLUM ⑧ Graticule illumination adjustment.
- TRACE ROTATION ⑦ Semi-fixed potentiometer for aligning
the horizontal trace in parallel with
graticule lines.
- Bezel ③⑤ For installing a camera mount in
one-touch operation.
- Filter ③⑥ Blue filter for ease of waveform
viewing. Can be removed in one-
touch operation.

o Vertical axis:

- CH1 (X) input ⑪ Vertical input terminal of CH1.
During X-Y operation, this becomes
X-axis (abscissa) input terminal.

CH2 (Y) input (18)

Vertical input terminal of CH2.

During X-Y operation, this becomes Y-axis (ordinate) input terminal.

AC-GND-DC (10) (19)

Switch for selecting connection mode between input signal and vertical amplifier.

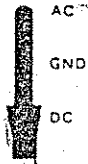

AC: AC coupling

GND: Vertical amplifier input is grounded and input terminals are disconnected.

DC: DC coupling

VOLTS/DIV (12) (16)

Select the vertical axis sensitivity, from 5 mV/DIV to 5 V/DIV with 10 ranges.

VARIABLE (13) (17)

Fine adjustment of sensitivity, with a factor of 1/2.5 or higher of the panel-indicated value. At the CAL'D position, sensitivity is calibrated to the panel-indicated value. When this knob is pulled out (x5 MAG state), the amplifier sensitivity is multiplied by 5 times.

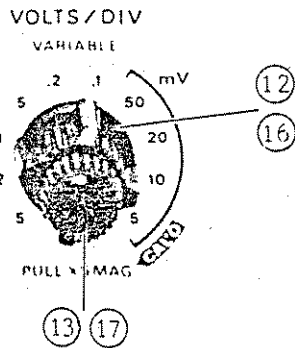

POSITION (9) (20)

Vertical positioning control of trace or spot.

VERT MODE (14)

Selects operation modes of CH1 and CH2 amplifiers. Also selects internal triggering source signal.

CH1: The oscilloscope operates as a single-channel instrument with CH1 alone. The CH1 input signal is used as the internal triggering source signal.

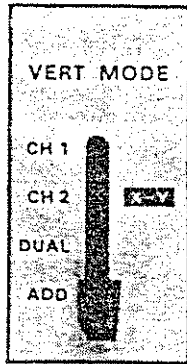

CH2: The oscilloscope operates as a single-channel instrument with CH2 alone. The CH2 signal is used as the internal triggering source signal.

DUAL: The oscilloscope operates as a dual-channel instrument with both CH1 and CH2. The internal triggering source signal is selected by SOURCE switch (26).

ADD: The oscilloscope displays the algebraic sum (CH1 + CH2) or difference (CH1 - CH2) of the two signals. The pulled out state of CH2 POSITION knob (20) provides the difference (CH1 - CH2). The internal triggering source signal is selected by SOURCE switch (26).

o Triggering

EXT TRIG (EXT HOR) .. (23) input terminal

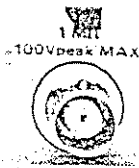

This terminal is used in common for external triggering signal and external horizontal signal. To use this terminal, set SOURCE switch (26) to the EXT position.

SOURCE (26)

Selects the internal triggering source signal. Also select the EXT HOR input signal.

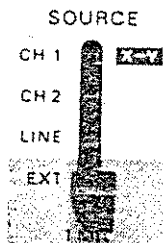

CH1 X-Y : When the VERT mode switch (14) is set at the DUAL or ADD position, selects CH1 for the internal triggering source signal. During the X-Y mode operation, selects CH1 for the X-axis signal.

CH2: When the VERT mode switch (14) is set at the DUAL or ADD position, selects CH2 for the internal triggering source signal.

EXT: The external signal applied through EXT TRIG (EXT HOR) input terminal (23) is used for the external triggering source signal. During the X-Y, EXT HOR mode operation, the X-axis operates with the external sweep signal.

Note: When the VERT MODE switch is set to the CH1 or CH2 position, internal triggering source signal selection cannot be made by the SOURCE signal. In such cases, a triggering source signal is set by the VERT MODE switch.

COUPLING (25) Select coupling mode between triggering source signal and trigger circuit; select connection of TV sync trigger circuit.

COUPLING

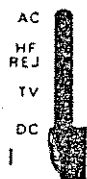

AC: AC coupling

HF REJ: AC coupling, with components higher than 50 kHz rejected.

DC: DC coupling

TV: The trigger circuit is connected to the TV sync separator circuit and the sweeps are synchronized with the TV V or TV H signal at a rate selected by the TIME/DIV switch (30).

TV V: 0.5 sec/DIV - 0.1 msec/DIV.

TV H: 50 μ sec/DIV - 0.2 μ sec/DIV.

SLOPE (24) Selects the triggering slope.



"+": Triggering occurs when the triggering signal crosses the triggering level in the direction of signal increase (i. e., positive direction).

"-": Triggering occurs when the triggering signal crosses the triggering level in the direction of signal decrease (i. e., negative direction).

"+" slope

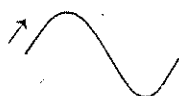

Triggering point

"-" slope

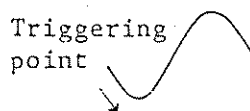

HOLDOFF (21) These double-knob controls are for

LEVEL (22) holdoff time adjustment and triggering level adjustment.

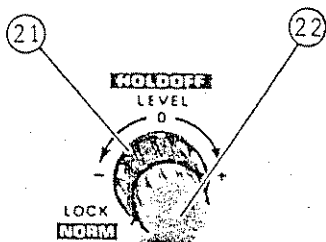

The HOLDOFF time control is used when the signal waveform is complex so that stable triggering cannot be attained with LEVEL knob (22) alone.

The LEVEL knob is for displaying a synchronized stationary waveform and setting a start point for the waveform.

As this knob is turned in "+ + " direction, the triggering level moves upward on the displayed waveform; as the knob is turned in " - - ", the triggering level moves downward.

When set in the LOCK position, the triggering level is automatically maintained at an optimum value irrespective of the signal amplitude (from very small amplitude to large amplitude), requiring no manual adjustment of triggering level.

o Time Base

A TIME/DIV AND DELAY TIME (COS5041 only) (30)

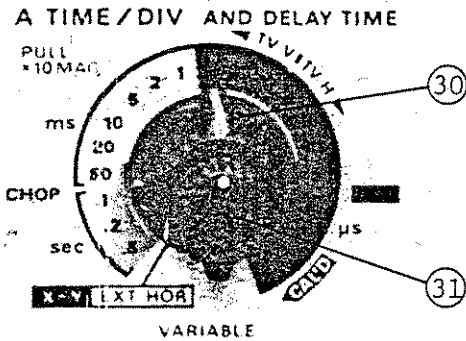

Selects the sweep time for the A sweep or the delay time when in the delayed sweep mode. When this switch is set to the X-Y EXT HOR position, the oscilloscope operates as an X-Y scope with CH1 for the X-axis or operates in the EXT HOR mode with an external sweep input signal for the horizontal signal.

(For details, see Page 28 and 29.)

TIME/DIV (COS5040 only) (30)

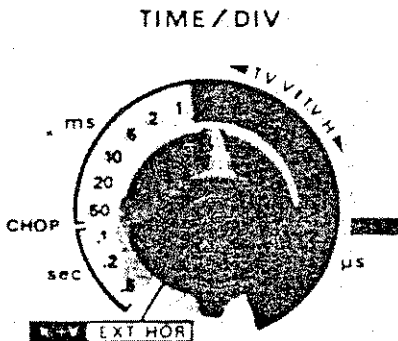

Selects the sweep time.

VARIABLE (31)
PULL ×10 MAG

Vernier control of sweep time (the A sweep for COS5041). The sweep time can be made slower by a factor of 2.5 or more of the panel-indicated value.

The panel-indicated values are calibrated with this knob set in the CAL'D position.

The pulled out position of this knob is for the $\times 10$ MAG state.

- POSITION (32) Vertical adjustment of the trace or spot.
- B TIME/DIV (33) Selects the sweep time for delayed sweep (B sweep).
(COS5041 only)

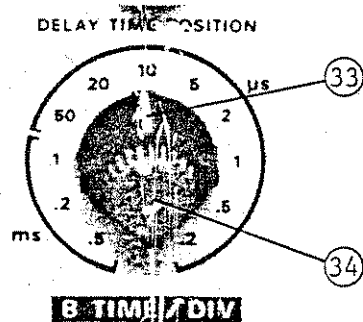

- DELAY TIME POSITION.. (34) Vernier control of the delay time selected by the A TIME/DIV AND DELAY TIME switch (30), to finely select the portion of the A sweep waveform to be magnified.

- SWEEP MODE (28) Selects the desired sweep mode.

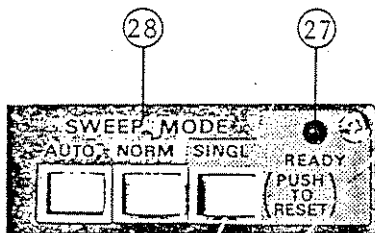

AUTO: When no triggering signal is applied or when triggering signal frequency is less than 50 Hz, sweep runs in the free run mode.

NORM: When no triggering signal is applied, sweep is in a ready state and the trace is blanked out. Used primarily for observation of signals of 50 Hz or lower.

SINGLE: Used for single sweep
PUSH operation (one-shot sweep
TO operation), and in common
RESET as the reset switch.

When the three buttons are in the pushed out state, the circuit is in the single sweep mode. The circuit is reset as this button is pressed. When the circuit is reset, the READY lamp (27) turns on. The lamp goes off when the single sweep operation is over.

DISPLAY (29) Selects A and B sweep mode as follows:
(COS5041 only)

A: Main sweep (A sweep) mode for general waveform observation.

A INT: This sweep mode is used when selecting the section to be magnified of the A sweep, in preparation for delayed sweep. The B sweep section (delayed sweep) corresponding to the A sweep is displayed with high brightness.

B: Displays the delayed sweep (B sweep) alone.

B TRIG'D: Selects between continuous delay and triggered delay.

Π : For continuous delay. The B sweep starts immediately after the sweep delay time set by DELAY TIME switch (30) and DELAY TIME POSITION knob (34) has elapsed.

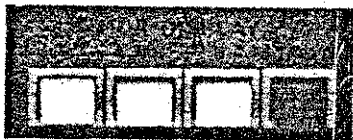

⏏: For triggered delay. The B sweep starts when the triggering pulse is applied after the sweep delay time set by DELAY TIME switch and DELAY TIME POSITION knob has elapsed.

(The triggering signal is used in common for both A sweep and B sweep.)

o Others

CAL (Vp-p) ① This terminal delivers the calibration

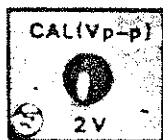

voltage of 2 Vp-p, approximately 1 kHz, positive square wave. The output resistance is approximately 2 kΩ.



..... ② Ground terminal of oscilloscope mainframe.

4.2 Explanation of Rear Panel

o Z AXIS INPUT ③ Input terminals for external intensity modulation signal.

o CH1 SIGNAL OUTPUT ... ④ Delivers the CH1 signal with a voltage of approximately 100 mV per 1 DIV of graticule. When terminated with 50 ohms, the signal is attenuated to about a half. May be used for frequency counting, etc.

o AC Power Input Circuit

AC power input connector ... (40)

Input connector of the AC power of the instrument. Connect the AC power cord (supplied) to this connector.

FUSE (41) Fuse in the primary circuit of the power transformer. Fuse rating is as shown in Table (44).

AC voltage selecting connector ... (42)

For selecting the AC voltage of the instrument.

AC voltage selector plug ... (43)

For selecting the AC voltage of the instrument by aligning its arrowhead mark in the corresponding position as shown in Table (44).

o Studs (39) Studs for laying the oscilloscope on its back to operate it in the upward posture. Also used to take up the power cord.

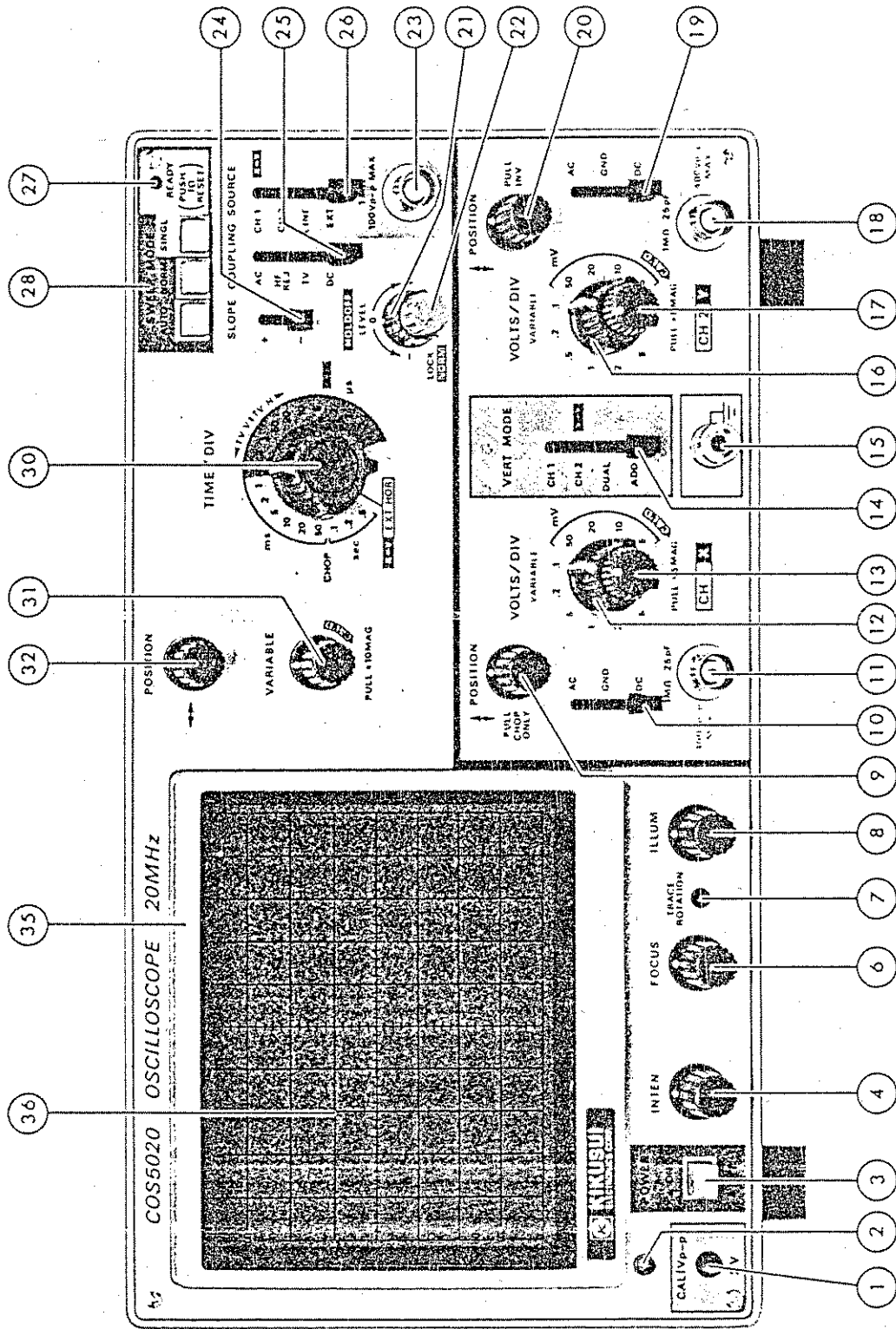

Figure 4-1 (Model COS5020)

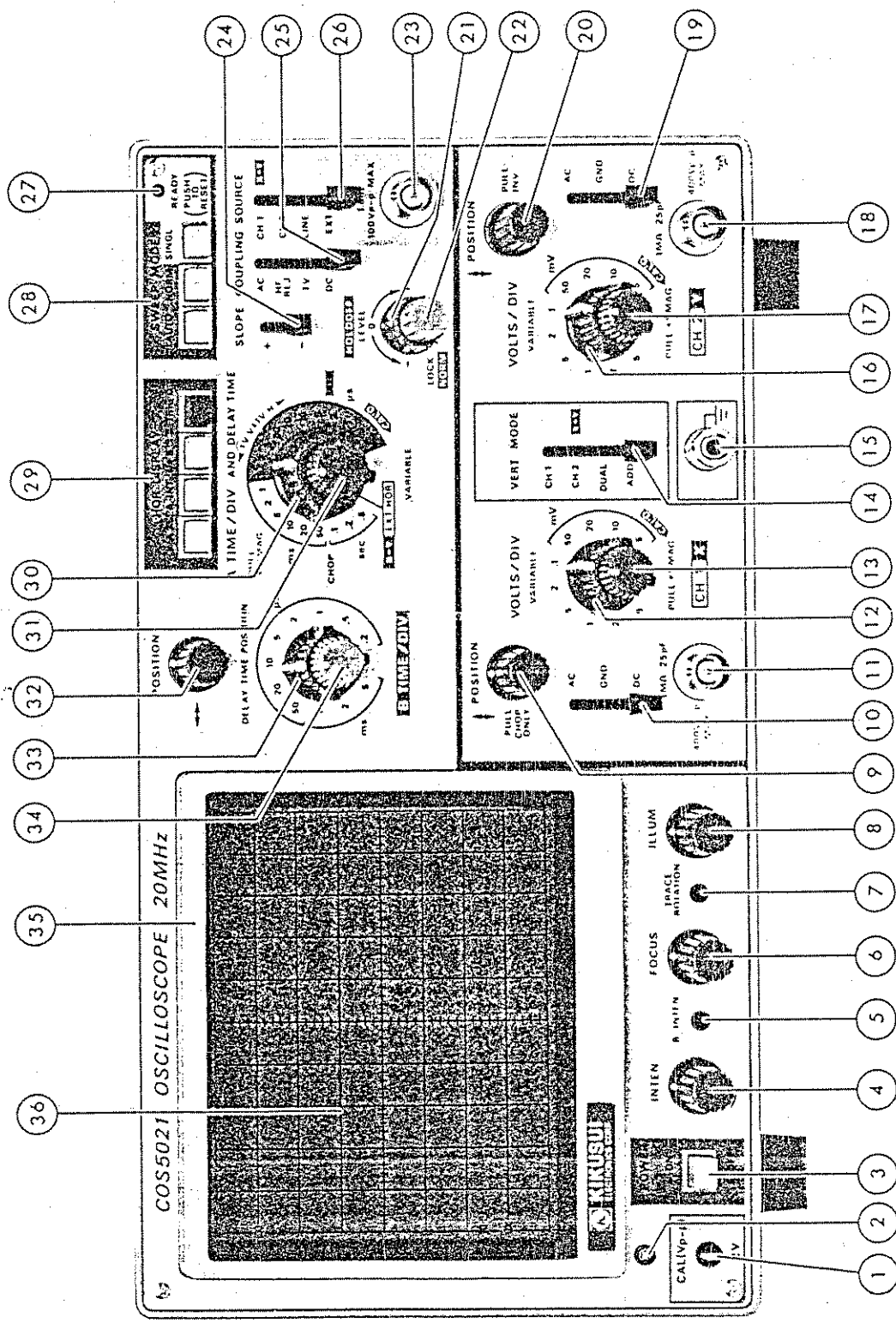

Figure 4-2 (Model COS5021)

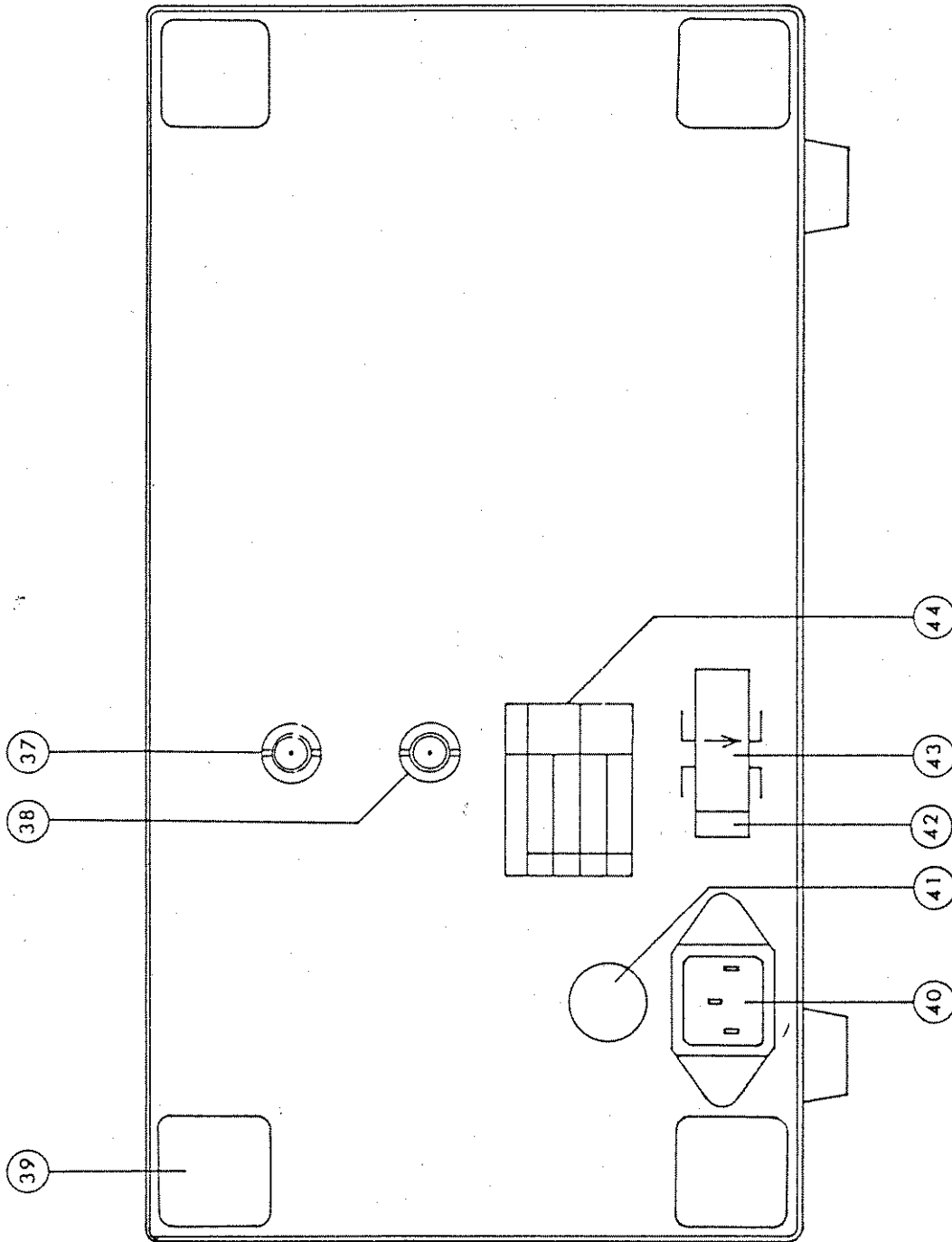

Figure 4-3

4.3 Basic Operation

Before connecting the power cord to an AC line outlet, check that the AC line voltage selector plug on the rear panel of the instrument is correctly set for the AC line voltage. After ensuring the voltage setting, set the switches and controls of the instrument as shown in the following table.

Item	No.	Setting
POWER	③	<input checked="" type="checkbox"/> OFF position
INTEN	④	Clockwise (3-o'clock position)
FOCUS	⑥	Mid-position
ILLUM	⑧	Counterclockwise position
VERT MODE	⑭	CHI
↑ POSITION	⑨ ⑳	Mid-position, pushed in
VOLTS/DIV	⑫ ⑰	500 mV/DIV
VARIABLE	⑬ ⑱	CAL'D (clockwise position), pushed in
AC-GND-DC	⑩ ⑲	GND
SOURCE	⑳	Be selected automatically to CHI
COUPLING	㉕	AC
SLOPE	㉔	+
LEVEL	㉒	LOCK (counterclockwise)
HOLDOFF	㉑	NORM (counterclockwise)
MODE (SWEEP)	㉘	AUTO
HOR DISPLAY	㉙	A (COS5041 only)
TIME/DIV	㉚	0.5 msec/DIV
VARIABLE	㉛	CAL'D (clockwise), pushed in
↔ POSITION	㉜	Mid-position

After setting the switches and controls as indicated above, connect the power cord to the AC line outlet and, then, proceed as follows:

- 1) Turn-ON the POWER switch and make sure that the power pilot LED is turned on. In about 20 seconds, a trace will appear on the CRT screen. If no trace appears even after about 60 seconds, repeat the switch and control settings as shown in the above table.
- 2) Adjust the trace to an appropriate brightness and to the sharpest image with the INTEN control and FOCUS control.
- 3) Align the trace with the horizontal center line of graticule by adjusting the CH1 POSITION control and TRACE ROTATION control (screwdriver adjustment).
- 4) Connect the probe (supplied) to the CH1 INPUT terminal, and apply the 2 V_{p-p} CALIBRATOR signal to the probe tip.
- 5) Set the AC-GND-DC switch in the AC state. A waveform as shown in Figure 4-4 will be displayed on the CRT screen.

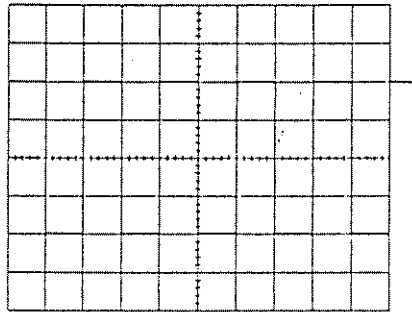

Figure 4-4

- 6) Adjust the FOCUS control until the sharpest trace image becomes available.
- 7) For signal viewing, adjust the VOLTS/DIV switch and TIME/DIV switch to appropriate positions so that the signal waveform is displayed with an appropriate amplitude and an appropriate number of peaks.

- 8) Adjust the \updownarrow POSITION and \leftrightarrow POSITION controls to appropriate positions so that the displayed waveform is aligned with the graticule and the voltage (V_{p-p}) and period (T) can be read as desired.

The above procedure is the basic operating procedure of the oscilloscope for single-channel operation with CH1. Single-channel operation with CH2 also can be made in a similar manner. Further operation methods are explained in the subsequent paragraphs.

4.4 Dual-channel Operation

Change the VERT MODE switch to the DUAL position so that the other trace (CH2) also is displayed. (The trace explained in the preceding section was for CH1.) At this state of procedure, the CH1 trace has the square wave of the calibration signal and the CH2 trace has a straight line since no signal is applied to this channel yet.

Now, apply the calibration signal also to the vertical input terminal of CH2 with the probe as was the case for CH1. Set the AC-GND-DC switch at the AC position. Adjust vertical POSITION knobs (9) and (20) so that two channels of signals are displayed as shown in Figure 4-5.

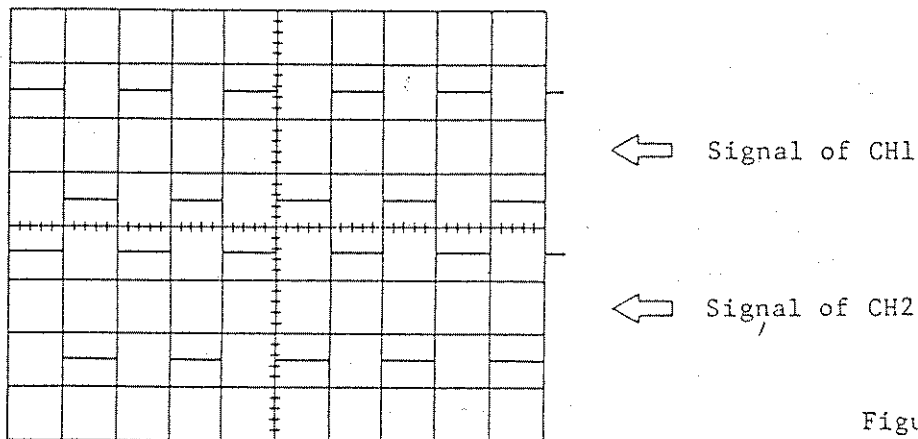
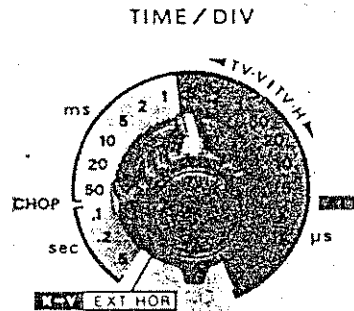

Figure 4-5

During the dual-channel operation (DUAL or ADD mode), either the CH1 or CH2 signal must be selected as the triggering source signal by means of the SOURCE switch. If both CH1 and CH2 signals are in a synchronized state, both waveforms can be displayed stationary; if not, only the signal selected by the SOURCE switch can be displayed stationary.

Selection between CHOP mode and ALT mode is automatically made by the TIME/DIV switch. The 1 msec/DIV and lower ranges are used with the CHOP operation and the 0.5 msec/DIV and higher ranges are used with the ALT operation.

Figure 4-6



When the \updownarrow POSITION knob is pulled out, the two traces are displayed with the CHOP operation over the entire ranges.

4.5 ADD Operation

An algebraic sum of the CH1 and CH2 signals can be displayed on the screen by setting the VERT MODE switch at the ADD position. The displayed signal becomes the difference between CH1 and CH2 signals if the CH2 POSITION knob is pulled out (PULL INV).

For accurate addition or subtraction, it is a prerequisite that the sensitivities of the two channels be adjusted accurately at the same value by means of the VARIABLE knobs. Vertical positioning can be made with the \updownarrow POSITION knob of either channel. In view of the linearities of the vertical amplifiers, it is most advantageous to set both knobs in their mid-positions.

4.6 X-Y Operation and EXT HOR Operation

When the TIME/DIV switch is set at the X-Y EXT HOR position, the internal sweep circuit is disconnected and the trace in the horizontal direction is driven by the signal selected by the SOURCE switch. When the switch is set to the CH1 X-Y position, the oscilloscope operates as an X-Y scope with the CH1 signal for the X-axis; when it is set to the EXT position, the oscilloscope operates in the EXT HOR (external sweep) mode.

o X-Y operation

The X-Y mode is operated with the VERT MODE switch selected for CH2 **X-Y** and the TIME/DIV switch in the fully counter clockwise position. CH1 becomes the X axis while CH2 becomes the Y axis, whose position is controlled by the horizontal position knob. The bandwidth of the X axis becomes DC to 1 MHz (-3 dB).

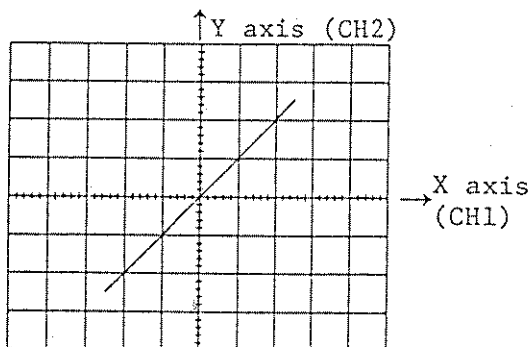

Figure 4-7

o EXT HOR (external sweep) operation

The external signal applied through the EXT HOR terminal (23) drives the X axis. The Y axis is controlled with any channel or channels as selected by the VERT MODE switch. When the DUAL mode is selected by the switch, both CH1 and CH2 signals are displayed in the CHOP mode.

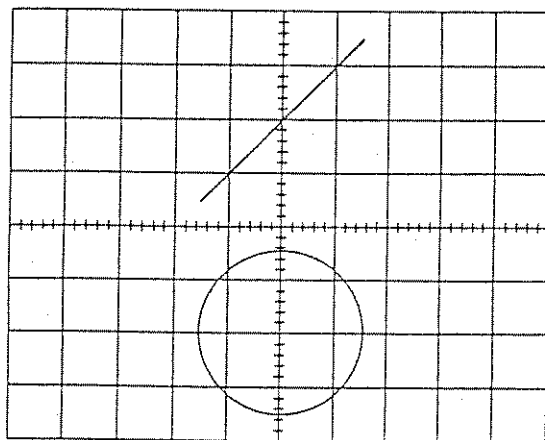

Figure 4-8. Dual-channel X-Y operation

4.7 Triggering

Proper triggering is essential for an efficient operation of the oscilloscope. The user of the oscilloscope must become thoroughly familiar with the triggering functions and procedures.

(1) Functions of SOURCE Switch:

To display a stationary pattern on the CRT screen, the displayed signal itself or a trigger signal which has a time relationship with the displayed signal is required to be applied to the trigger circuit. The SOURCE switch selects such a triggering source.

CH1: This internal trigger method is used most commonly. The CH2: signal applied to the vertical input terminal is branched off from the preamplifier and is fed to the trigger circuit through the VERT MODE switch. Since the triggering signal is the measured signal itself, a very stable waveform can be readily displayed on the CRT screen.

During the single-sweep mode operation, the signal of the channel selected by the VERT MODE switch is used as the triggering source signal.

During the DUAL or ADD operation, the signal selected by the SOURCE switch is used as the triggering source signal.

LINE: The AC power line frequency signal can also be used as the triggering signal. This method is effective when the measured signal has a close relationship with the AC line frequency, especially for measurements of low level AC noise of audio equipment, thyristor circuits, etc.

EXT: The sweep is triggered with an external signal applied to the external trigger input terminal. An external signal which has a periodic relationship with respect to the measured signal is used. Since the measured signal is not used as the triggering signal, waveform can be displayed more independently of the measured signal.

The above triggering source signal selection function are summarized in the following table.

VERT MODE SOURCE	CH1	CH2	DUAL	ADD
CH1	Triggered by CH1 signal	Triggered by CH2 signal	Triggered by CH1 signal	
CH2			Triggered by CH2 signal	
LINE	Triggered by LINE signal			
EXT	Triggered by EXT TRIG input signal			

(2) Functions of COUPLING switch:

This switch is used to select the coupling of the triggering signal to the trigger circuit in accordance with the characteristics of the measured signal.

AC: This coupling is used for AC triggering which is used most commonly. As the triggering signal is applied to the trigger circuit through an AC coupling circuit, stable triggering can be attained without being affected by the DC component of the input signal. The low-range cut off frequency is 10 Hz (-3 dB).

When the ALT trigger mode is used and the sweep speed is slow, jitter may be produced. In such a case, use the DC mode.

HF REJ: The triggering signal is fed to the trigger circuit through an AC coupling circuit and a low pass filter (approximately 50 kHz, -3 dB). The higher components of the trigger signal are rejected through the low pass filter and the lower components alone of the trigger signal are applied to the trigger circuit.

TV: This coupling is used for TV triggering for observation of TV video signals. The triggering signal is AC-coupled and fed via the trigger circuit (level circuit) to the TV sync separator circuit. The separator circuit picks

off the sync signal, which is used to trigger the sweep. Thus, the video signal can be displayed very stably.

Being linked to the TIME/DIV switch, the sweep speed is switched for TV.V and TV.H as follows:

TV.V: 0.5 sec - 0.1 msec

TV.H: 50 μ sec - 0.2 μ sec

The SLOPE switch should be set in conformity with the video signal as shown in Figure 4-9.

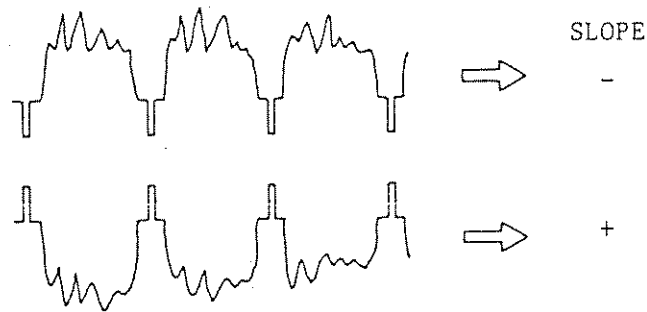

Figure 4-9

DC: The triggering signal is DC-coupled to the trigger circuit. This mode is used when triggering is desired with the DC component of the triggering signal or when a very low frequency signal or a signal of large duty cycle ratio is needed to be displayed.

(3) Functions of SLOPE switch:

This switch selects the slope (polarity) of the triggering signal.

"+": When set in the "+" state, triggering occurs as the triggering signal crosses the triggering level in the direction of signal increase (i.e., positive direction).

"-": When set in the "-" state, triggering occurs as the triggering signal crosses the triggering level in the direction of signal decrease (i.e, negative direction).

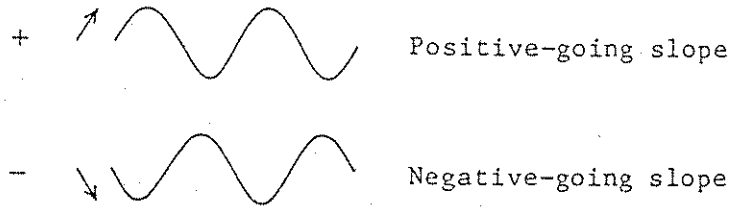

Figure 4-10

(4) Functions of LEVEL (LOCK) control:

The function of this control is to adjust the triggering level and display a stationary image. At the instant of the triggering signal crossing the triggering level set by this control, the sweep is triggered and a waveform is displayed on the screen.

The trigger level changes in the positive direction (upward) as this control knob is turned clockwise and it changes in the negative direction (downward) as the knob is turned counter-clockwise. The rate of change is set as shown in Figure 4-11.

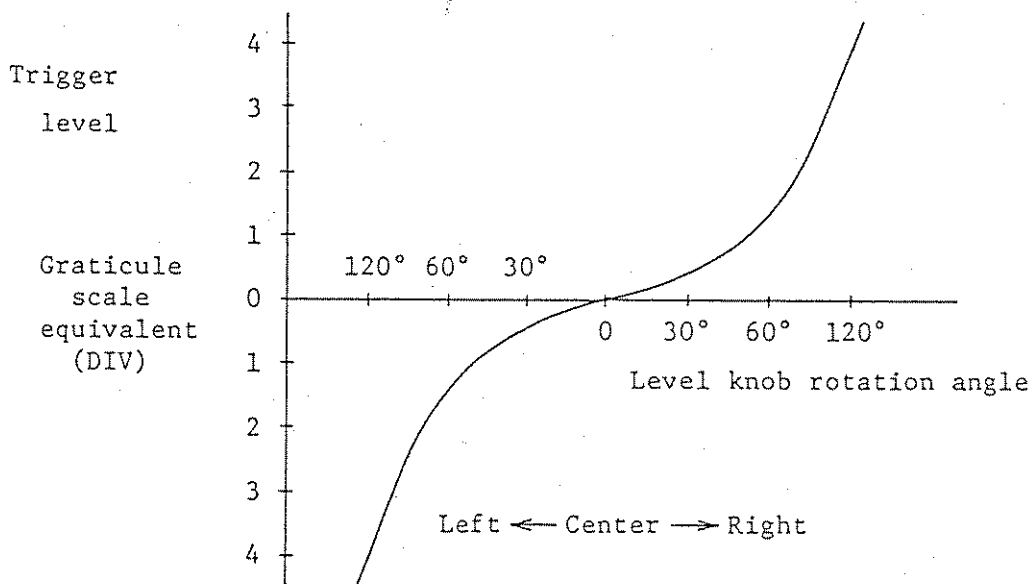

Figure 4-11

o LEVEL LOCK

When the LEVEL knob is set at the LEVEL LOCK position, the triggering level is automatically maintained within the amplitude of the triggering signal and stable triggering is made without requiring level adjustment (although jitter may not be suppressed during the ALT mode operation). This automatic level lock function is effective when the signal amplitude on the screen or the input voltage of the external triggering signal is within the following range:

50 Hz - 10 MHz: 1.0 DIV (0.15 V) or less

50 Hz - 40 MHz: 2.0 DIV (0.25 V) or less

(5) Functions of HOLD OFF control:

When the measured signal has a complex waveform with two or more repetition frequencies (periods), triggering with the above-mentioned LEVEL control alone may not be sufficient for attaining a stable waveform display. In such a case, the sweep can be stably synchronized to the measured signal waveform by adjusting the HOLD OFF time (sweep pause time) of the sweep waveform. The control covers at least the time of one full sweep, for sweeps faster than 0.2 sec/DIV.

Figure 4-11 (1) shows a case for HOLD OFF knob at the NORM position. Various different waveforms are overlapped on the screen, making the signal observation unsuccessful.

Figure 4-11 (2) shows a case in which the undesirable portion of the signal is held off. The same waveforms are displayed on the screen without overlapping.

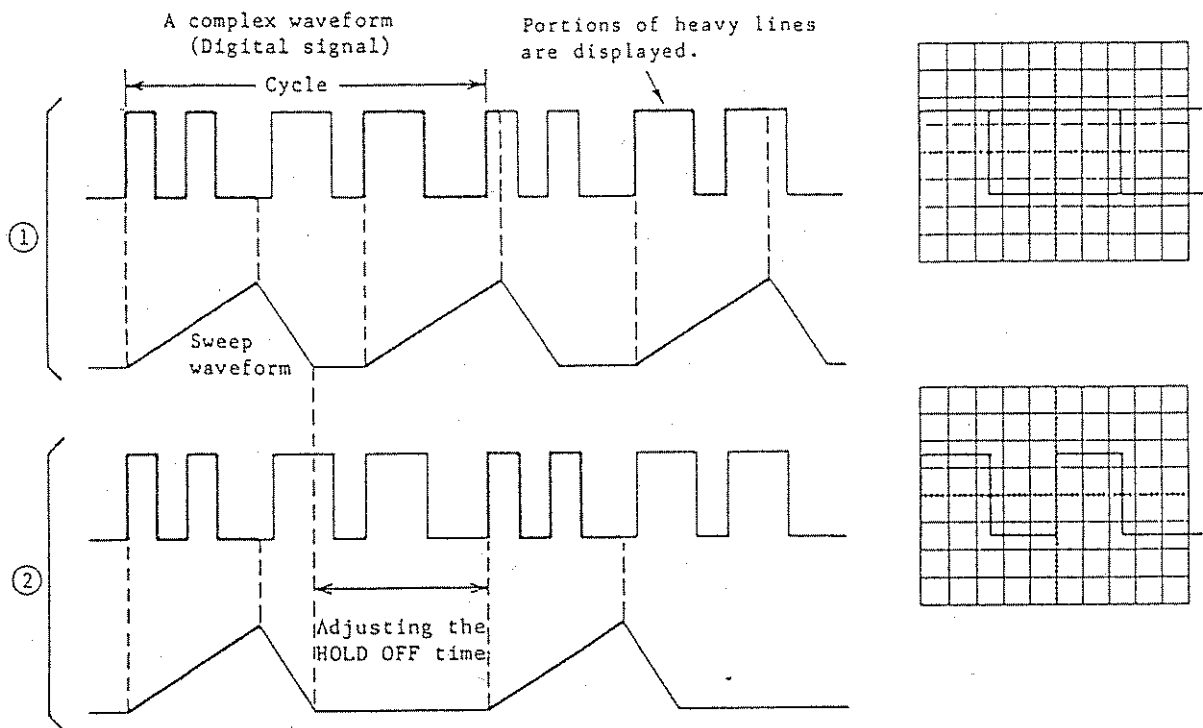

Figure 4-12

4.8 Single-sweep Operation

Non-repetitive signals and one-shot transient signals can hardly be observed on the screen with the regular repetitive sweep operation. Such signals can be measured by displaying them in the single-sweep mode on the screen and photographing them.

o Measurement of non-repetitive signal:

- (1) Set the SWEEP MODE at the NORM position.
- (2) Apply the measured signal to the vertical input terminal and adjust the triggering level.
- (3) Set the SWEEP MODE at the SINGLE position (the three pushbutton switches are pushed out).

(4) Press the RESET button. The sweep will run only for one cycle and measured signal will be displayed only once on the screen.

o Measurement of one-shot signal:

- (1) Set the SWEEP MODE at the NORM position.
- (2) Apply the calibration output signal to the vertical input terminal, and adjust the triggering level at a value corresponding to the predicted amplitude of the measured signal.
- (3) Set the SWEEP MODE at the SINGLE position. Apply the measured signal, instead of the calibration signal, to the vertical input terminal.
- (4) Depress the RESET button. The sweep circuit will become in the ready state and the READY lamp will light on.
- (5) As the one-shot signal occurs in the input circuit, the sweep runs only for one cycle and the one-shot signal is displayed on the CRT screen.

The single-sweep operation can be done also with A INTEN B sweep. However, it cannot be done in the dual-channel ALT mode operation. For dual-channel one-sweep operation, use the CHOP mode.

4.9 Sweep Magnification

When a certain position of the displayed waveform is needed to be expanded timewise, a faster sweep speed may be used. However, if the required portion is far away from the starting point of the sweep, the required portion may run off the CRT screen. In such a case, pull out (set in the x10 MAG state) the sweep VARIABLE KNOB (31). When this is done, the displayed waveform is expanded by 10 times to right or left with the center of screen at the center of expansion.

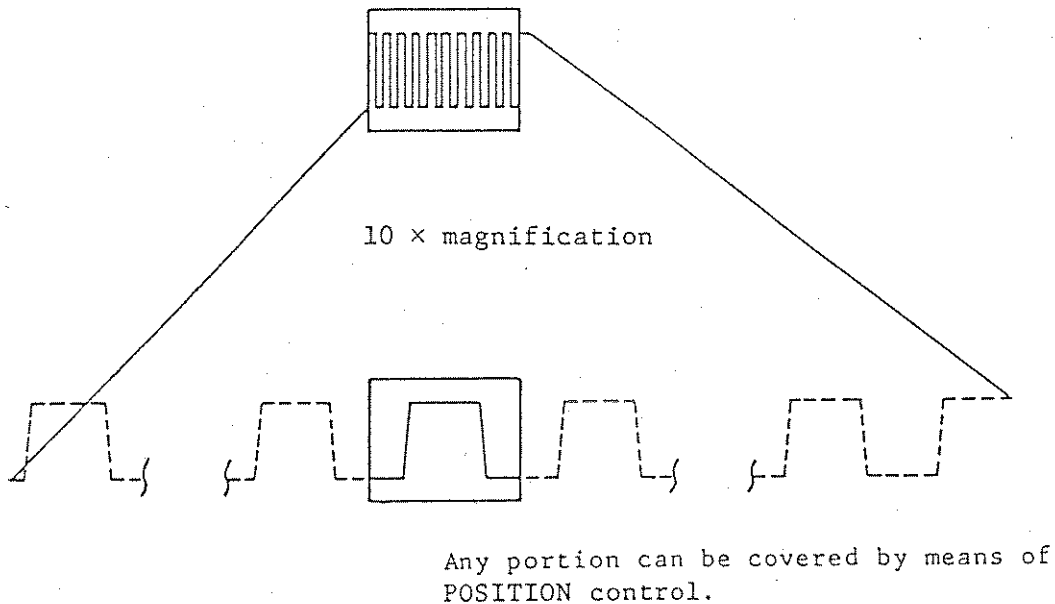

Figure 4-13

The sweep time during the magnification operation is obtained as follows:

$$(\text{Value indicated by TIME/DIV switch}) \times 1/10$$

Thus, the unmagnified maximum sweep speed ($0.2 \mu\text{sec}/\text{DIV}$) can be made faster with magnification as follows:

$$0.2 \mu\text{sec}/\text{DIV} \times 1/10 = 20 \text{ nsec}/\text{DIV}$$

When the sweep is magnified and the sweep speed has become faster than $0.2 \mu\text{sec}/\text{DIV}$, the trace may become darker. In such a case, the displayed waveform should be expanded in the B sweep mode explained in the subsequent paragraphs (COS5041 only).

4.10 Waveform Magnification with Delayed Sweep (COS5041 only).

With sweep magnification of the preceding paragraph, although the magnification method is simple, the magnification ratio is limited at 10. With the delayed sweep method of this paragraph, on the other hand, the sweep can be expanded for a wide range from several times to several thousand times according to the ratio between A sweep time and B sweep time.

As the measured signal frequency becomes high and the A sweep range for the non-expanded signal becomes higher, the available expansion ratio becomes smaller. Furthermore, as the magnification ratio becomes larger, the trace intensity becomes lower and the delay jitter increases. To cope with these situations, a continuously-variable delay circuit and a triggered delay circuit are incorporated into the oscilloscope.

(1) Continuously-variably delay:

Set the HOR DISPLAY switch to A and display the signal waveform with the A sweep in the regular operation method.

Next, set the B TIME/DIV switch at a position faster by several steps than the A TIME/DIV switch.

After ensuring that the B TRIG'D button of the HOR DISPLAY switch is at the pushed out position () , turn the HOR DISPLAY switch to the A INTEN position. A portion of the displayed waveform will be accentuated as shown in Figure 4-14, indicating the state ready for delayed sweep. The portion of the accentuated brightness indicates the section corresponding to the B sweep time (DELAYED SWEEP). This portion is expanded on the B sweep.

The period from the start of the A sweep to that of the B sweep (the period to the start of trace accentuation) is called "SEEP DELAY TIME." This period is continuously variable by means of the DELAY TIME POSITION knob.

Next, change the HOR DISPLAY switch to the B position. The B sweep time will be expanded for the full span of the CRT screen as shown in Figure 4-15.

The B sweep time is set by the B TIME/DIV switch and the magnification ratio becomes as follows:

$$\text{Magnification ratio} = \frac{\text{A TIME/DIV indication}}{\text{B TIME/DIV indication}}$$

The sweep delay time can be read on the CRT screen. For more accurate determination, the DELAY TIME MULTI dial should be used.

$$\text{Sweep delay time} = \text{A TIME/DIV indication} \times \text{DELAY TIME MULTI dial setting}$$

HORIZ DISPLAY
A INTEN

Figure 4-14

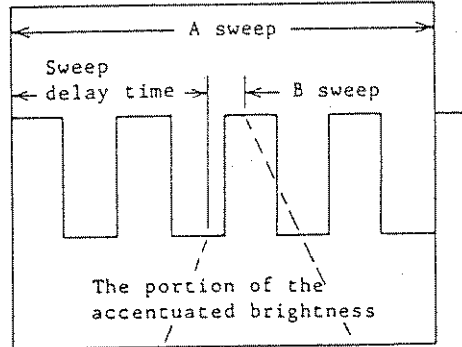

HORIZ DISPLAY
B

Figure 4-15

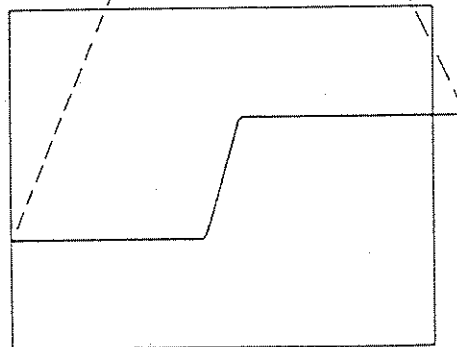

(2) Triggered delay:

When the displayed waveform is magnified by 100 times or higher in the above-mentioned continuous delay method, delay jitter is produced. To suppress the jitter, the triggered delay method may be used.

With the triggered delay, delay jitter is reduced by triggering the B sweep again after a sweep delay time as effected by the continuous delay method has elapsed.

For this operation the A trigger circuit continues to operate even after the B TRIG'D button is pushed in (A) and the B sweep is triggered by the triggering pulse. Therefore, even when the delay time is continuously varied by turning the TIME DELAY POSITION knob, the starting point of the sweep moves discretely, not continuously. In the A INTEN mode, this operation is characterized by discrete shifts of the brightness-accentuated section of the sweep across the CRT screen; while in the B mode this section remains stationary.

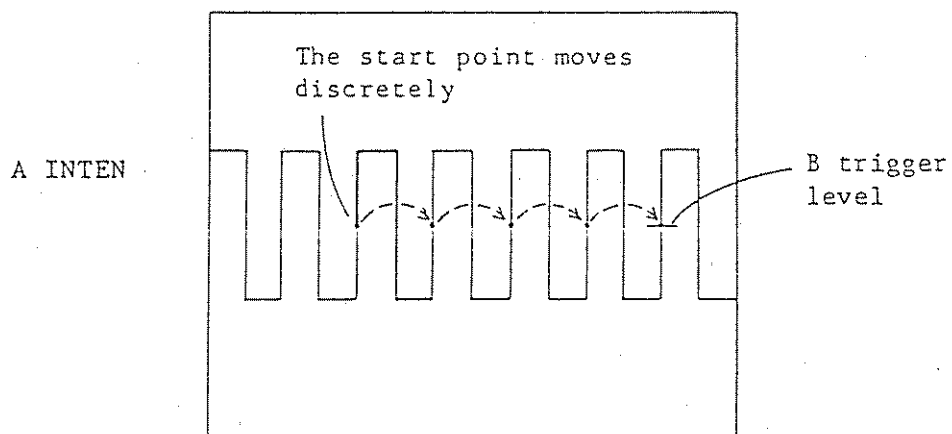

Figure 4-15

4.11 Calibration of Probe

As explained previously, the probe makes up a wide-range attenuator. Unless phase compensation is properly done, the displayed waveform is distorted causing measurement errors. Therefore, the probe must be properly compensated before use.

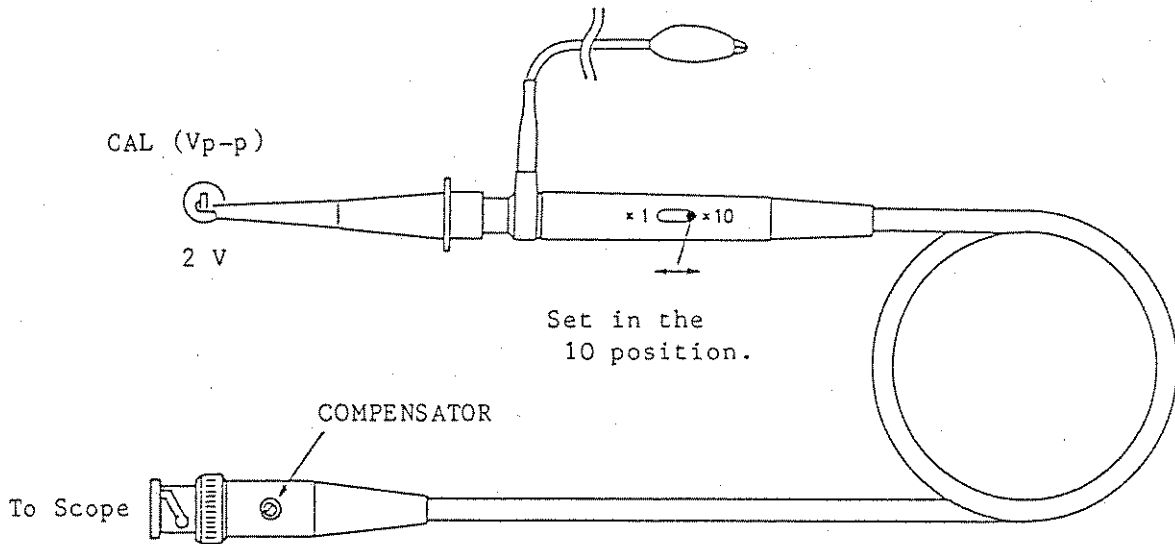

Figure 4-17

Connect the probe BNC to the INPUT terminal of CH1 or CH2 and set VOLTS/DIV switch at 50 mV. Connect the probe tip to the calibration voltage output terminal and adjust the COMPENSATOR control with an insulated screwdriver so that an ideal waveform as illustrated below is obtained.

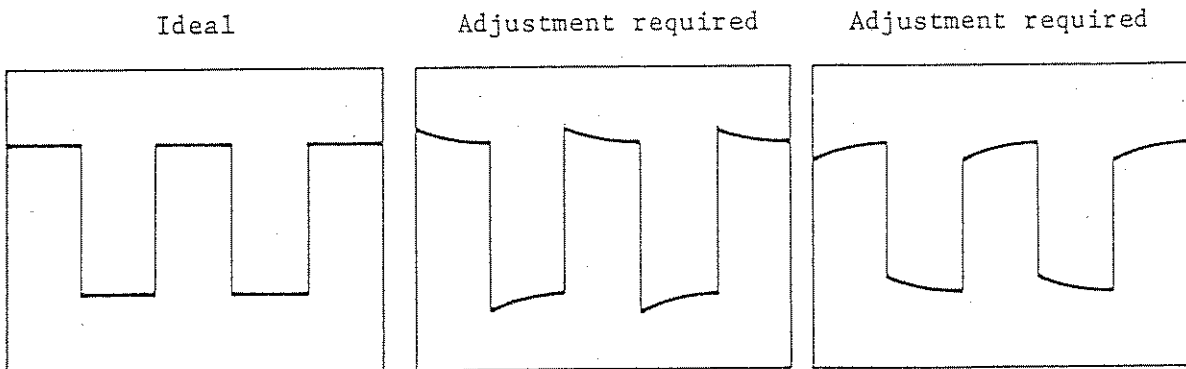
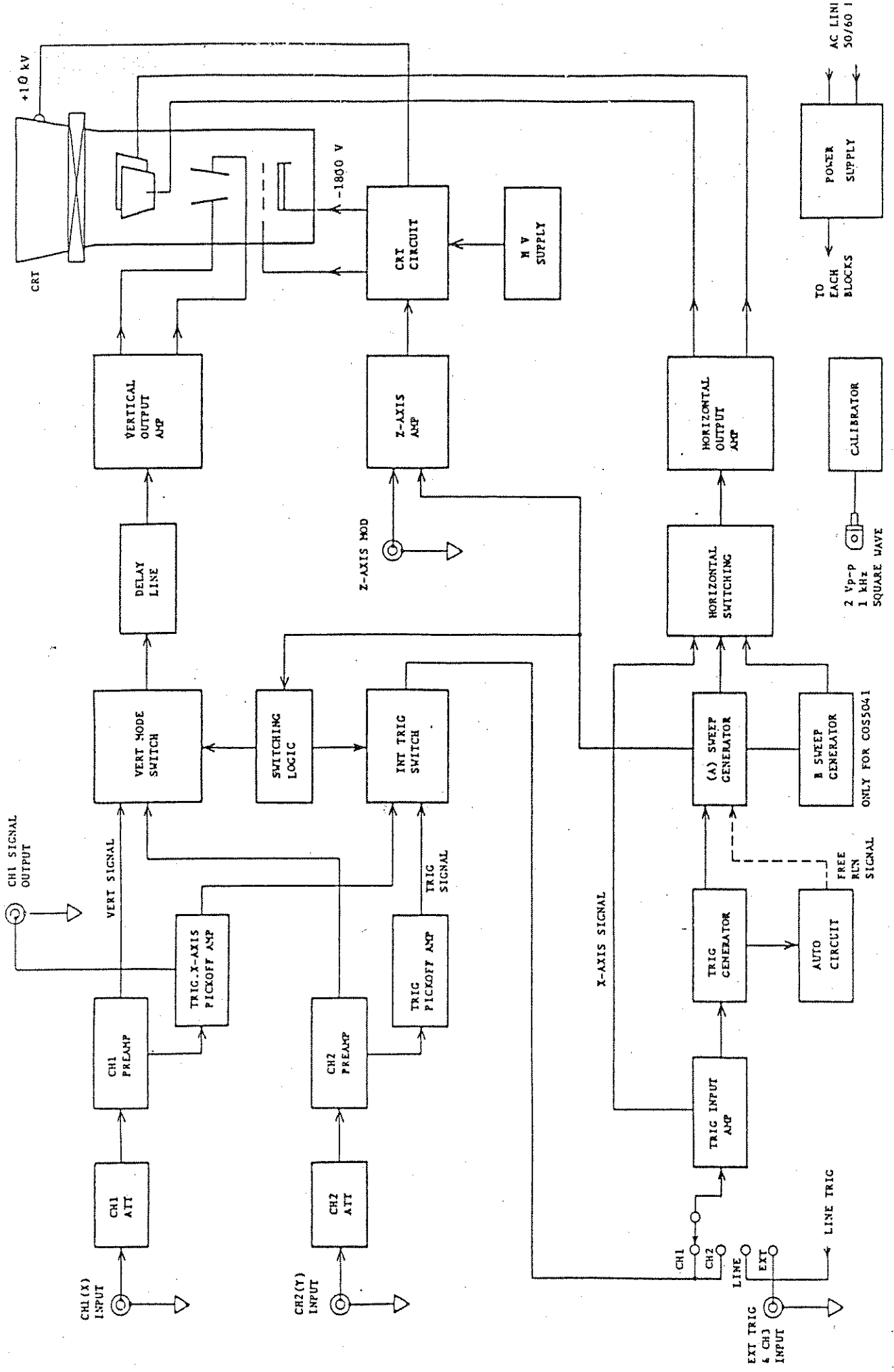

Figure 4-18



BLOCK DIAGRAM