

**Model 9210
300 MHz
Programmable
Pulse Generator**

**March 1, 1995
Rev. B**



Innovators in Instrumentation

Corporate Headquarters

700 Chestnut Ridge Road

Chestnut Ridge, NY 10977-6499

Tel: (914) 578-6020, Fax: (914) 589-5985

European Headquarters

2, chemin-Pre-de-la Fontaine

1217 Meyrin 1

Geneva, Switzerland

Tel.: (022) 719 21 11

Copyright© March 1, 1995, LeCroy. All rights reserved. Information in this publication supersedes all earlier versions. Specifications subject to change without notice.

TABLE OF CONTENTS

1	9210 QUICK START	1
	Purpose	1
	Quick Start Instructions.....	1
2	GETTING AROUND THE FRONT PANEL	5
	Accessing the Control Displays	5
	Selection of Parameters	6
	Adjusting Parameters with the Numeric Keypad	7
	Adjusting Parameters with the Rotary Knob.....	7
	Non-Numeric Entries	8
	Storing & Recalling Setups.....	8
	Executing Action Commands.....	9
	Manually Triggering the Generator.....	11
	Alternate Parameter Formats	11
	Restoring Local Control	11
	Module Controls - Enabling or Inverting the Pulse Output.....	12
	Power - Turning the Generator On & Off.....	13
3	CHANNEL A & B CONTROLS	15
	General Information	15
	Controlling Vertical Characteristics.....	15
	Width - Controlling Horizontal Duration	17
	Delay - Controlling Horizontal Position	20
	Controlling Transition Rates	21
	Dynamic Range and Transition Rates	24
	Double Pulse Operation.....	25
	Controlling Repetition Rate.....	26
	Parameter Conflicts	27
	Load Compensation.....	30
	Logic Family Presets	32
	Limiting the Output Levels	32
	Module Considerations	32
4	TRIGGER CONTROLS	39
	General Information.....	39
	The Trigger Output	39
	The Trigger Input	39
	Frequency Counter.....	40

Table of Contents

Trigger Modes	41
Normal Mode.....	41
Single Mode	42
Gate Mode	43
Burst Mode.....	44
External Width Mode.....	46
Double Pulse Interactions	47
Normal Mode.....	47
Single Mode	47
Gate Mode	47
Burst Mode.....	47
External Width Mode.....	48
Setting the Trigger Level and Slope.....	48
Setting the Trigger Level Automatically.....	48
Parameter Limits and Triggering.....	49
Setting the Internal Trigger Rate.....	49
Using The Manual Trigger Button	49
Adjusting the Trigger Output Offset.....	50
Selecting the Trigger Input Impedance	51
Trigger Output Presets.....	51
5 THE "MORE" MENU - UTILITIES AND FEATURES.....	53
Invoking Self-Calibration	53
Invoking Selftest.....	55
Calibration and Selftest Results.....	56
Monitoring the GPIB Interface.....	57
Testing the User Interface.....	57
The Configuration Menu.....	58
The Screen Saver	58
Disabling the Touch Screen	59
Display Brightness.....	59
Temperature Compensation	59
6 REMOTE OPERATIONS	61
General Information	61
Terminology	61
Numeric Representation	61
Header Compounding.....	62
Coupled Commands	62
Responses	62
Status Reporting	63
Common Commands	63

7	GPIB COMMANDS	65
	General Information	65
	Commands Which Correspond To Local Controls	66
	*CAL	66
	*RCL	67
	*SAV	67
	*TRG	67
	*TST	68
	AMP	68
	AUTOL	69
	BASE	69
	BC	70
	BRI	70
	DBL	71
	DEL	71
	DISA	72
	DISP	72
	DUTY	73
	FREQ	73
	INV	74
	LEAD	74
	LIM	75
	LVH	75
	LVL	76
	LOADC	77
	MED	78
	OUT	79
	OUTBar	79
	PER	80
	PHA	80
	SCRNSAVE	81
	SLEW_L	81
	SLEW_T	82
	TEMPC	83
	TOUCH	83
	TRAIL	84
	TRIM	84
	TRLV	85
	TRMD	85
	TROV	86
	TROV_SET	86
	TRSL	87

Table of Contents

VHI.....	87
VLO.....	88
VSET	89
WID.....	89
Commands Which Have No Corresponding Local Controls	90
*CLS.....	90
*ESE.....	90
*ESR	91
*IDN.....	91
*LRN.....	91
*OPC	92
*OPT	93
*RST	93
*SRE	94
*STB.....	94
*WAI	95
CHDR.....	95
CHK.....	96
DEGC_CHG.....	96
ERR.....	97
MSG	97
TER.....	98
APPENDIX A Specifications.....	99
LeCroy 9210 300 MHz Programmable Pulse Generator Mainframe	99
LeCroy 9211 250 MHz, Variable Edge Output Module.....	105
LeCroy 9212 300 MHz, 300 psec, Variable Edge Output Module.....	109
LeCroy 9213 50 MHz, 16V Amplitude Output Module.....	113
LeCroy 9214 300 MHz, 300 psec, Fixed Edge Output Module.....	116
APPENDIX B Warranty.....	119
Unpacking and Inspection.....	119
Warranty.....	119
Calibration	120
Documentation Discrepancies.....	120
APPENDIX C Service	121

APPENDIX D GPIB Documentation 123

- General Information..... 123
- GPIB Interface Function Subsets 123
- Addressing Information..... 124
- Restoration of Settings 124
- Commands and Queries..... 124
- Device Specific Commands..... 126
- Data Elements 126
- Query Responses 127
- Implemented Commands and Queries..... 127
- State After Calibration..... 127
- Identification Response 128
- Reset, Save, Recall and Learn..... 128
- Selftest..... 129
- Status Data Structure 136
- Sequential Processing..... 139
- Operation Complete..... 139
- Additional Notes..... 140

APPENDIX E Error Messages..... 141

- GPIB Error Queue 141
- Command Errors 142
- Execution Errors 146
- Query Errors 147
- Device Specific Errors 148
- Displayed Error Messages..... 151

APPENDIX F Glossary 159

- Ampl..... 159
- Base..... 159
- Burst Mode 159
- Delay..... 161
- Double Pulse 162
- Duty Cycle 162
- External Width Mode 163
- Frequency..... 163
- Gate Mode 164
- Lead..... 164
- Load Compensation..... 165

Table of Contents

Median	165
Normal Mode.....	165
Period.....	166
Phase.....	167
Single Mode	167
Slew	168
Temperature Compensation	168
Trail	168
Trigger Level	169
Trigger Slope.....	169
Trigger Output Level	169
Vhigh.....	169
Vlow	169
Width.....	170
Appendix G 9210 Pulse Generator Manual Addenda	171
Important Notice.....	171
For Mainframe Firmware Versions 2.7 and up.....	171
For 9212 users with Module Firmware Versions 1.6 and up.....	172
Firmware Versions 2.8 and up	172
Changes and additions to 9112 Output Module Specifications.....	172
Additional Feature for the 9212 Output Module	173
Appendix H 9210-50/250 100 MHz Pulse Generator Mainframe Specifications	175
Important Notice.....	175
Timing Characteristics.....	175
Inputs and Outputs.....	176
Programmability	177
Triggering Modes	178
Operating Features	178
Additional Capabilities.....	179
Environmental	179
Power	179
Miscellaneous.....	180
Appendix I 9215 50 MHz, 15V Amplitude Output Module Specifications	181
Timing Characteristics.....	181
Pulse Performance.....	182

Appendix J 9211MOD100 100 MHz Output Module Specifications 185
 Timing Characteristics 185
 Output Characteristics 185
 Output Levels..... 185
 Pulse Performance 187
 Module Controls..... 188

INDEX 189

Purpose

The intent of this chapter is to familiarize the first-time user of the LeCroy 9210 Pulse Generator with the instrument's uniquely user-friendly control scheme. The information presented herein is intended to "get you up to speed" in as short a time as possible. Detailed answers to specific questions that may arise will be found in other chapters.

Quick Start Instructions

- 1) To install an Output Module into slot A of the 9210 Pulse Generator Mainframe, push open the leftmost of the two self-closing cover doors on the right side of the 9210 front panel, and make sure that the module is properly placed in the guide rail. Tilt the module's front panel downwards slightly to assure proper alignment. Firmly push the module back into the mainframe assembly until it seats properly and the module front panel is approximately flush with the mainframe front panel. Do not force modules into position, as doing so may damage the connectors at the rear of the module or their mating connectors in the mainframe.

Repeat this installation procedure for module position B if a second output module is used.

NOTE: Mainframe power should be OFF when inserting and removing output modules.

- 2) Connect the 9210 to a power source that meets the instrument specification; 115/220 VAC $\pm 20\%$, 48 Hz to 448 Hz. The 9210 will automatically adjust to the local line voltage.
- 3) Make certain that the Main Circuit Breaker/Line switch, on the rear panel, is in the ON position.

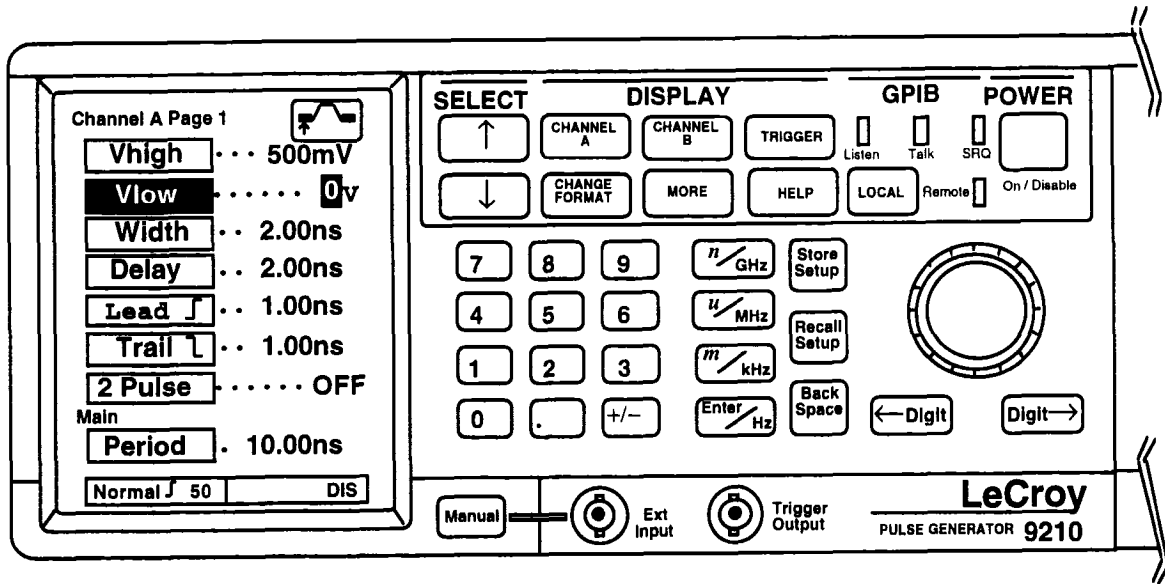

- 4) Push the front panel **[POWER]** key. The 9210 will perform power-up calibration for approximately 30 seconds, then display the Channel A control menu screen.
- 5) Most of the pulse parameters and their controls are accessed by touching the **CRTkeys** on the **TouchCRT**. Throughout this manual, the following symbols will be used to distinguish soft **CRTkeys** from actual front panel pushbuttons:

{Width} CRTkey

[Invert] Front Panel Key

- 6) Touch **{Period}**. The key should highlight.
- 7) Release the **CRTkey** and turn the Outer Ring Knob (range). The Period changes in a 1-2-5 sequence.

- 8) Turn the Center Knob (vernier). The Period will change smoothly.
- 9) Try varying the sensitivity of the vernier Knob using the [**←Digit**] and [**Digit→**] keys.
- 10) Change the Period to 1.5 microseconds by pressing [**1**], [**.**], [**5**], [**u/MHz**].
- 11) Press [**Recall Setup**], and touch **{Standard}** and **{Execute}** to recall the factory default setup. The generator will now be in the **NORMAL** trigger mode, which is free running.
- 12) Connect the **OUTPUT** of the Module to a vertical input of an oscilloscope with a 50 Ω cable, terminated at the scope end.
- 13) Press [**Disable**] on the Module to enable the Output. Adjust the scope to see the Pulse stream. Verify that the parameters on the generator's CRT match those of the scope trace.
- 14) Touch **{Vhigh}**, and turn the vernier knob to vary the Pulse high level.
- 15) The pulse parameters are defined below. Vary each and observe its effect on the scope trace. Note that the highlighted portion of the pulse icon on the display's upper right indicates graphically what has been selected for adjustment.

{Vhigh} High level. This is the active level if Invert is not on.

{Vlow} Low level. This is the quiescent level if Invert is not on.

{Width}	Pulse Width is measured from the start of the leading edge to the start of the trailing edge.
{Delay}	Delay of the module Pulse output from the Trigger output, not including a fixed delay of typically 13 nsec. This also controls the time between the 2 pulses in double pulse mode.
{Lead}	Leading edge transition time, 10% to 90%.
{Trail}	Trailing edge transition time, 10% to 90%.
NOTE:	Transition times ({Lead} and {Trail}) cannot be varied in the 9214 module.
{2 Pulse}	Turns double pulse mode ON or OFF.
{Period}	Defines the time between Output Pulses in NORMAL , GATE and BURST trigger modes.



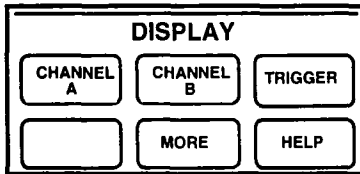

2

GETTING AROUND THE FRONT PANEL

Accessing the Control Displays

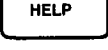

Control Menus are brought to the 9210's display by pressing one of the five blue **DISPLAY** keys on the front panel. Press [**TRIGGER**] once to bring up the main Trigger control menu display. Press [**TRIGGER**] again and a second page of less frequently used trigger controls will be displayed. Repeated presses of the key will toggle the display between these two menus. The other four **DISPLAY** keys operate in a similar manner. See the table below for details.

<i>Keys</i>	<i>Display</i>
   (on module)	Channel Parameter Menu (2 pages)
	Trigger Parameter Menu (2 pages)
	Utilities and Features Menu
	On-Screen Operating Summary

Selection

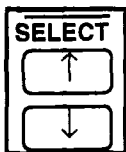

The selected parameter is the one that is highlighted (backlit). Parameters are selected by touching their corresponding **CRTkey**, or by pressing the **SELECT** [\uparrow], [\downarrow] keys on the front panel until the desired parameter is highlighted. Note that when making selections with the **CRTkeys**, the selection process is not completed until the key is released.

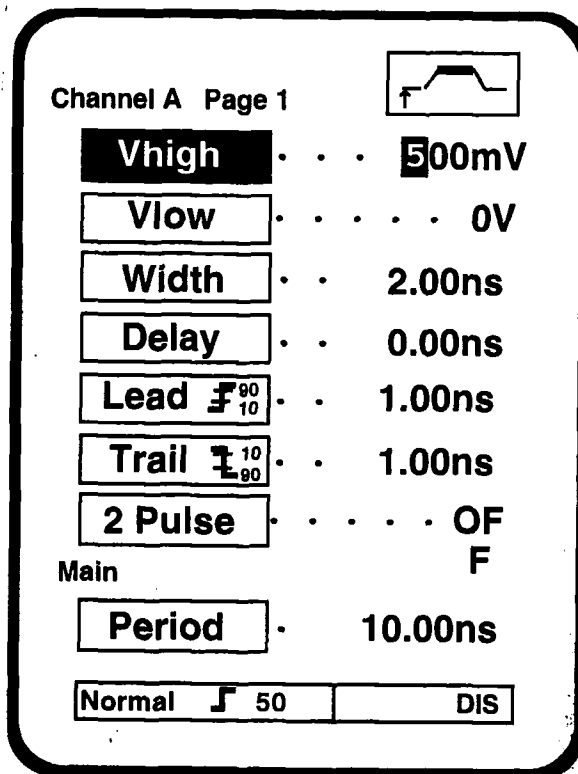

NOTE: If a 9214 module is installed in one of the module bays, the **{Lead}** and **{Trail}** **CRTkeys** will not be displayed in that channel's menu.

Adjusting Parameters with the Numeric Keypad

A precise value for the selected parameter can be entered by pressing the numbers on the numeric keypad. Each number pressed will be displayed in the information window at the bottom of the CRT. The [Back Space] key is provided for deleting erroneous key presses. The [+/-] key will toggle the sign of the number being entered, and may be pressed at any time before terminating entry. After the sign and numeric portion of the desired value have been punched in, entry with the appropriate multiplier is terminated by pressing one of the four unit/entry keys ([n/GHz], [u/MHz], [m/kHz], or [Enter/Hz]) at the right of the keypad.

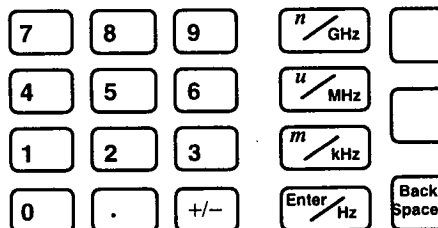

Adjusting Parameters with the Rotary Knob

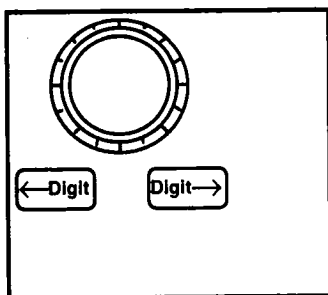

Continuous adjustment of the selected parameter can be accomplished using the concentric **Rotary Knob**. The **Outer Ring Knob** (range select) will set the parameter's value in a 1-2-5 sequence. As a convenience, if the Outer Knob is rotated by only one position and then turned back, the original value will be restored, even if that value was not a 1, 2 or 5. The **Center Knob** (vernier) will change the value in a continuous, analog fashion. The sensitivity of the vernier Knob is controlled by using the **Digit select keys** located below the Knob. The [Digit →] key will move the selected digit to the right, for finer adjustment, and the [←Digit] key will move the selected digit left, for more coarse adjustment. Note that the [←Digit] key allows for the changing of adjustment sensitivity beyond the digits currently displayed.

Non-Numeric Entries

Certain of the 9210's control parameters are non-numeric in nature. Examples are the **Load Compensation** feature, which can be turned on or off, and the **Trigger Mode**, which can assume one of five of states. The state of such parameters can be set by turning the **Outer Ring Knob** or by pressing either **Digit Select Key**.

Storing & Recalling Setups

The 9210 system can store up to 16 setups, including all output pulse and trigger parameters and operating conditions. To store a setup once all settings have been established, press [**Store Setup**]. The display will change, and a prompt will request a number. Assign a number from 0 to 15 to the setup and enter that number using the Numeric Keypad and [**Enter/Hz**].

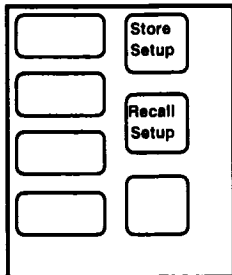

To recall a setup, press [**Recall Setup**]. The display will change, and a prompt will ask for a setup number. Enter the number of the desired setup using the Numeric Keypad and [**Enter/Hz**]. The factory default settings (see the table at the end of Chapter 3, "Channel A & B Controls") can also be recalled from this screen, by touching **{Standard}** and **{Execute}**. Additionally, the **{Previous}** setup (i.e., the state before the last recall) can be recalled from this screen in a similar manner.

Attempting to recall a setup that has not been previously stored will generate an error message. If a setup file is stored with one output module type installed in a given position, and is later recalled with a different type of module in that position, an error message is generated and the parameters will be set as closely as the new module's capabilities will allow.

Executing Action Commands

Some **CRTkeys** invoke actions instead of selecting parameters, but these actions do not take place immediately upon releasing the key. A confirmation box will appear on the screen, and **{Execute}** must be touched to continue with the selected action. If the action key was touched in error, **{Cancel}** can be touched and the action will not occur.

{Cal}, at the top of the More menu page is an example of an action key. The key is used to initiate a self-calibration cycle. When the key is touched, a box appears at the bottom of the display containing two new **CRTkeys**, **{Execute}** and **{Cancel}** (see figure below). If **{Execute}** is touched, the 9210 will proceed to calibrate itself. If **{Cancel}** is touched, no action will occur.

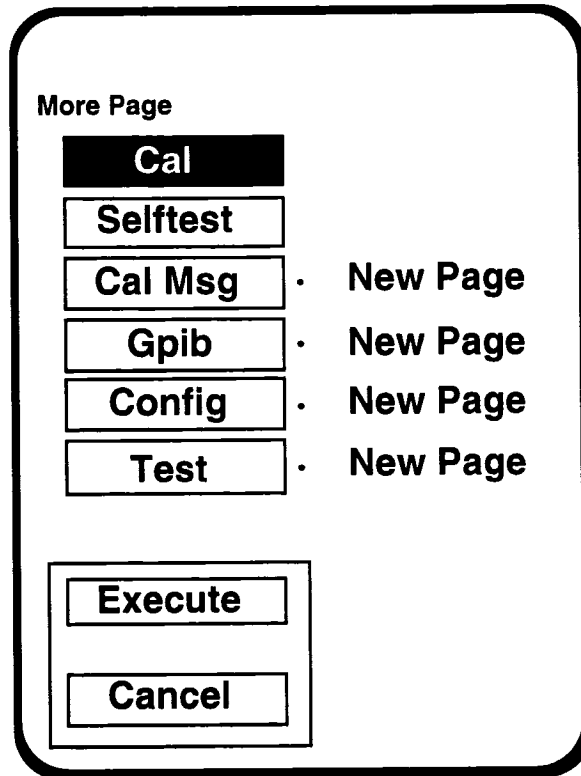

If the TouchCRT has been disabled by the user (see section entitled "Disabling the Touch Screen" in Chapter 5), action commands can be executed by using the **SELECT** [↑][↓] keys to highlight the appropriate **CRTkey**, then pressing [Enter/Hz]. This will bring the confirmation box mentioned above to the screen, with {**Execute**} highlighted. Press [Enter/Hz] to begin the action, or **SELECT** [↓] to highlight {**Cancel**}, and [Enter/Hz] to cancel the command request.

Manually Triggering the Generator

In **Single**, **Burst**, **Gate** and **External Width** Trigger modes, pressing [**Manual**] will trigger the generator, just as if a triggering signal had been delivered to the adjacent **Ext Input** connector. In **Gate** and **External Width** modes, the output continues for as long as the button is held in. See Chapter 4 (Trigger Controls) for further details.

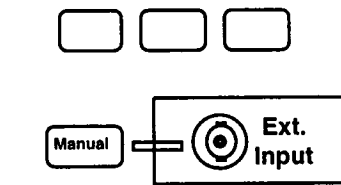

Alternate Parameter Formats

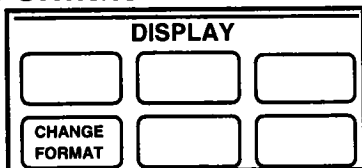

Certain pulse parameters may be controlled in alternate formats. **{Period}**, for example, displays and controls the time interval between pulses. If you press [**CHANGE FORMAT**] while **{Period}** is selected, the display will change to **{Freq}**. Now, you can control and read back the frequency at which pulses are output. Alternate formats are also available for other parameters, and these are detailed in Chapter 3. The available formats for a given parameter may be cycled through by repeated presses of the [**CHANGE FORMAT**] key. If no other formats are available for the selected parameter, a message will appear to tell you so.

Restoring Local Control

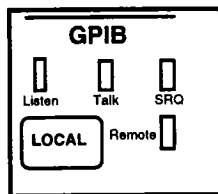

Front panel control capability can be restored to a 9210 that is operating under GPIB control, if Local Lockout has not been invoked by the Bus Controller, by pressing [**LOCAL**] under the GPIB heading. The Remote LED will be lit while the Generator is under bus control, and will go out when [**LOCAL**] is pressed. If the Bus Controller has asserted Local Lockout, pressing [**LOCAL**] will have no effect. See Chapters 6, 7, and Appendices D and E for more GPIB related details.

Module Controls - Enabling or Inverting the Pulse Output

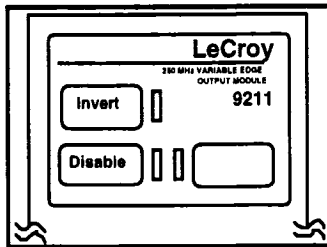

By factory default settings, the 9210 will initially power up with the Pulse Outputs from the modules disabled. Since the generator saves its state when power is turned off, this may only be true the very first time power is applied.

The output amplifiers of all the 9210's Output Modules connect to the outside world via a relay. This allows the module to protect itself from over-voltage conditions at its output by opening the relay (i.e., disabling the output) when such a condition is sensed. The **[Disable]** key on the module front panel acts as a toggle controlling the state of the output relay.

When the module's Output is disabled (i.e., when the red LED next to the key is lit), the relay is open and no Output pulses can be obtained. Also note that the legend DIS is displayed on the right side of the information window at the bottom of that module's control menu. In this case, pressing **[Disable]** will turn the LED off, remove the DIS legend from the display, and close the relay, thus enabling the Output.

The Output inversion function is also controlled by a key on the module's front panel. By our definition, when Invert is OFF, the True Output is more positive in the active state than in the quiescent state. Pressing **[Invert]** in this situation will make the True Output more negative in the active state than in the quiescent state.

The Invert function will automatically be invoked anytime a negative amplitude is requested.

Like **[Disable]**, **[Invert]** acts as a toggle. Accordingly, pressing **[Invert]** when Invert is ON will turn it OFF. A yellow LED next to the key will be lit when Invert is ON.

Power - Turning the Generator On & Off

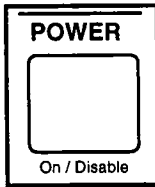

The 9210's power supply will automatically adjust to local power line voltages of 115 or 220 VAC, $\pm 20\%$ and to line frequencies between 48 Hz and 448 Hz. Just attach the power cord to the rear panel connector and plug it in. The Main Circuit Breaker switch on the rear panel should always be left in the ON position. This is a true circuit breaker, which will trip if the generator draws line current in excess of 5 Amps. The square, white **[On/Disable]** key, under the **POWER** heading on the front panel acts as a toggle. Pressing this key will turn the generator on and off.

3

CHANNEL A & B CONTROLS

General Information

In most cases, the controls for Channels A and Channel B operate identically, regardless of which Output Module is installed in which slot. Considerations specific to the Model 9211, 9212 9213 and 9214 Output Modules will be presented at the end of this chapter.

The term Pulse Output, as used in this chapter, refers to the signal at the Module's True Output, which is the upper connector, labeled **OUTPUT**, on the module's front panel. Some modules have a Complementary Output, labeled **OUTPUT**. This output will carry a signal of the same voltage levels as the True Output, but with opposite signal orientation

Controlling Vertical Characteristics

The first two lines of the first page of a Channel menu display control the Output Pulse's vertical (voltage) parameters. The default format (shown below), provides control as follows:

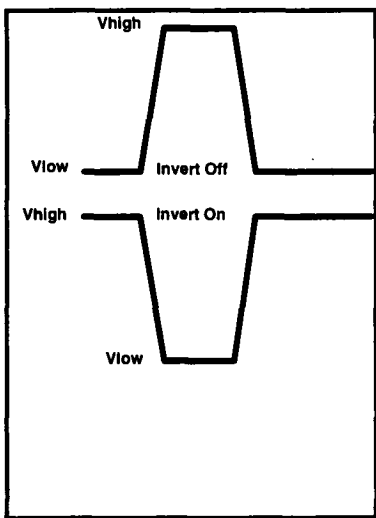

{Vhigh}: This is the active level of the Output Pulse if **Invert** is off, or the quiescent level if **Invert** is on.

{Vlow}: This is the quiescent level of the Output Pulse if **Invert** is off, or the active level if **Invert** is on.

The signal levels indicated by the Control Menu Display will be delivered into a 50.00 Ω load, or into any load connected to the module output within the compensation range if the load compensation feature is enabled. See the section entitled Load Compensation, later in this chapter, for further details.

Channel A Page 1 

Vhigh ... 500mV

Vlow 0V

Width .. 2.00ns

Delay .. 0.00ns

Lead \int_{10}^{90} .. 1.00ns

Trail \int_{90}^{10} .. 1.00ns

2 Pulse OFF

Main

Period . 10.00ns

Normal \int 50 DIS

*Channel Menu showing
Default Parameter
Formats.*

Channel A Page 1 

Ampl ... 500mV

Base 0V

Duty Cy .. 20.00%

Phase .. 0.0 P

Slew \int_{10}^{90} .. 400 $\frac{V}{\mu S}$

Slew \int_{90}^{10} .. 400 $\frac{V}{\mu S}$

2 Pulse OFF

Main

Freq .. 100MHz

Normal \int 50 DIS

*Channel Menu showing
Alternate Parameter
Formats.
NOTE: In a 3rd vertical format,
the 2nd line is Median.*

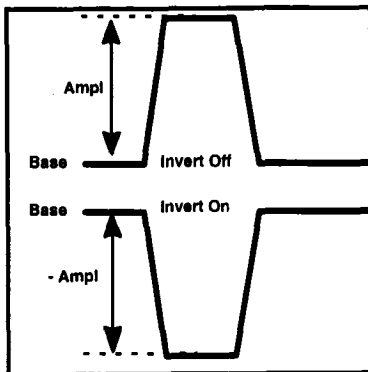

Pressing [CHANGE FORMAT] with either {Vhigh} or {Vlow} selected will change the display for both parameters. The second vertical format controls the Output Pulse in the following manner:

{Ampl}: This is the Pulse Amplitude, i.e., the difference between the quiescent and active levels of the Output Pulse.

{Base}: This is the quiescent level of the Output Pulse. Note that this value changes when the Output Pulse is inverted.

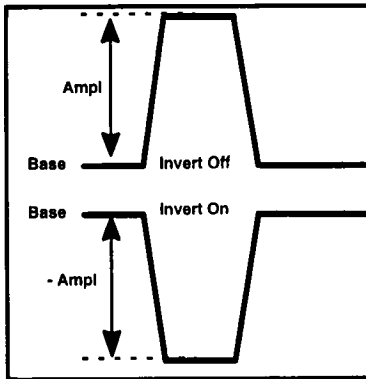

Pressing [CHANGE FORMAT] with either **{Vhigh}** or **{Vlow}** selected will change the display for both parameters. The second vertical format controls the Output Pulse in the following manner:

{Ampl}: This is the Pulse Amplitude, i.e., the difference between the quiescent and active levels of the Output Pulse.

{Base}: This is the quiescent level of the Output Pulse. Note that this value changes when the Output Pulse is inverted.

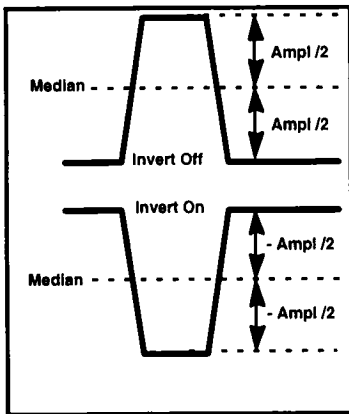

Pressing [CHANGE FORMAT] with either **{Base}** or **{Ampl}** selected will change the display for the **{Base}** parameter to **{Median}**. In this third vertical format, the controls function like this:

{Ampl}: Pulse Amplitude (see above).

{Median}: This is the midpoint between the quiescent and active levels of the Output Pulse.

In this format, changes in Amplitude will occur symmetrically about the Median.

Note that in all of the vertical formats, any time a negative-going Output Pulse or a negative Amplitude is requested, **Invert** will be turned **ON**.

Width - Controlling Horizontal Duration

The horizontal (time) duration of the Output pulse is controlled by third entry on the first page of the Channel menu display, whose default format is **{Width}**. This format provides control in the following manner:

{Width}: This parameter directly defines the time interval during which the Output Pulse is in the active state.

NOTE: By the accepted convention among manufacturers of programmable pulse generators, pulse width includes the entire transition time from the quiescent state to the active state, and excludes the entire transition time from active to quiescent. This convention allows pulse duration and edge rates to be independently adjusted, without affecting one another. However, this definition can differ significantly from the FWHM (Full Width, Half Max) definition, used by digital oscilloscopes for measuring pulse width, if the leading and trailing edge rates are not equal.

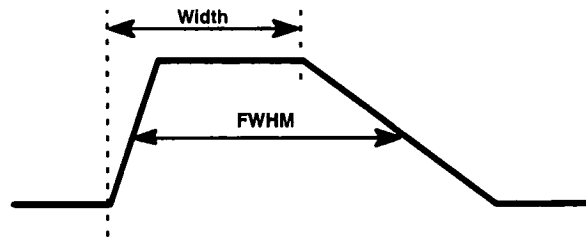

Changing Repetition Rate in the Duration Formats

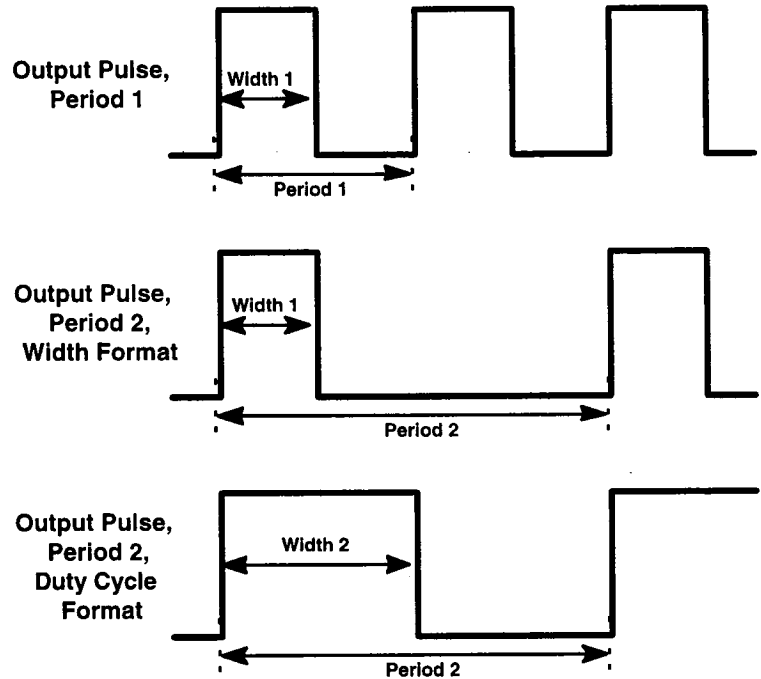

Pressing [CHANGE FORMAT] while **{Width}** is selected changes this parameter's display to **{Duty Cy}**. This changes the mode of control over the duration of the Output Pulse as follows:

{Duty Cy}: Duty Cycle defines the percentage of the **{Period}** (see below) over which the Output pulse is in the active state.

In **{Duty Cy}** mode, the Output Pulse duration varies proportionally with the **{Period}**, while in **{Width}** mode the duration is unaffected by **{Period}**.

Duty Cycle mode is merely a method the generator uses to derive pulse **{Width}** values. In modes where **{Period}** has no operational meaning (such as Single trigger mode - see Chapter 4), the **{Width}** is determined by **{Duty Cy}** X **{Period}** X 0.01.

Delay - Controlling Horizontal Position

Control of the Output Pulse's horizontal (time) position is provided by the fourth line of the first page of the Channel menu display. This control is effected as follows:

{Delay}: This parameter defines the time interval from the Trigger Output to the Output Pulse, excluding a fixed time offset of approximately 13 nsec. See Chapter 4 (Trigger Controls) for more details about the Trigger Output in the various Trigger Modes.

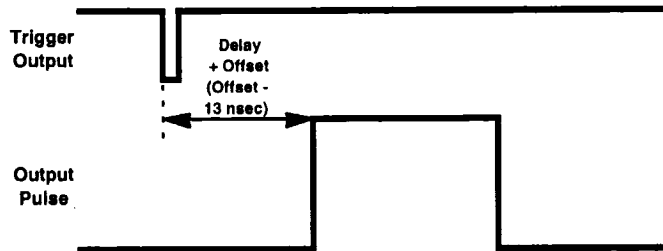

If [CHANGE FORMAT] is pressed while **{Delay}** is selected, The displayed name for this parameter changes to **{Phase}**. The mode of parametric control is changed as follows:

{Phase}: Phase mode provides delay control in a manner proportional to **{Period}**, similar to the way Duty Cycle format controls pulse duration. In this operating mode, the pulse's position is expressed as a phase angle, with 0_ corresponding to the minimum **{Delay}** setting (i.e. the offset). This phase angle is maintained as **{Period}** is varied. When **{Phase}** has been set, the Pulse **{Delay}** = $\text{{Phase}}/360 \times \text{{Period}}$.

Resolution in **{Phase}** format is always 0.1_ (i.e. one part in 3600). Depending upon the **{Period}** setting, this may be more or less resolution than the **{Delay}** format provides.

Controlling Transition Rates

The fifth and sixth lines of the first page of a Channel menu display control the Output Pulse's transition time (edge speed). The default format for these parameters provide control as follows:

{Lead}: This controls the time required for the leading edge of the Output Pulse to make the transition from 10% to 90% of its total amplitude.

{Trail}: This controls the time required for the trailing edge of the Output Pulse to make the transition from 90% to 10% of its total amplitude.

*Changing Repetition Rate
in the Position Formats*

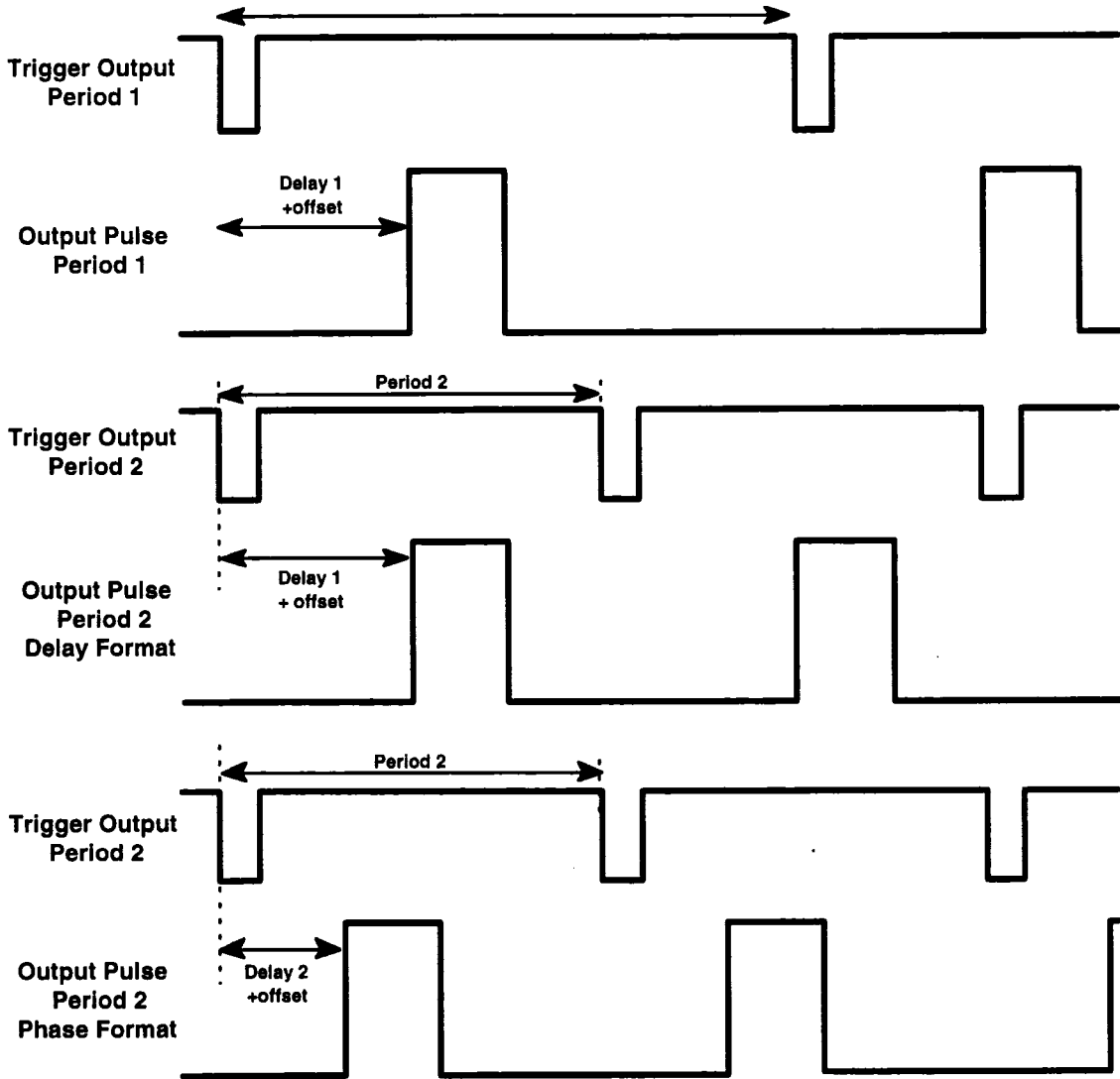

Pressing [CHANGE FORMAT] when either {Lead} or {Trail} is selected will change the display for both these parameters to {Slew}. Note that the icon within each CRTkey denotes which edge's slew rate that key will control. The mode of control changes as follows:

{Slew}: Slew Rate defines the slope of the selected edge during its 10% to 90% (or 90% to 10%) transition.

Changing Amplitude in the Transition Time formats

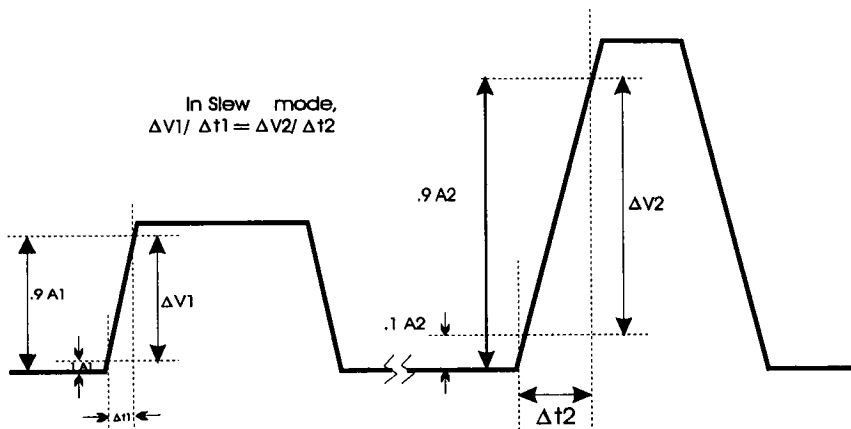
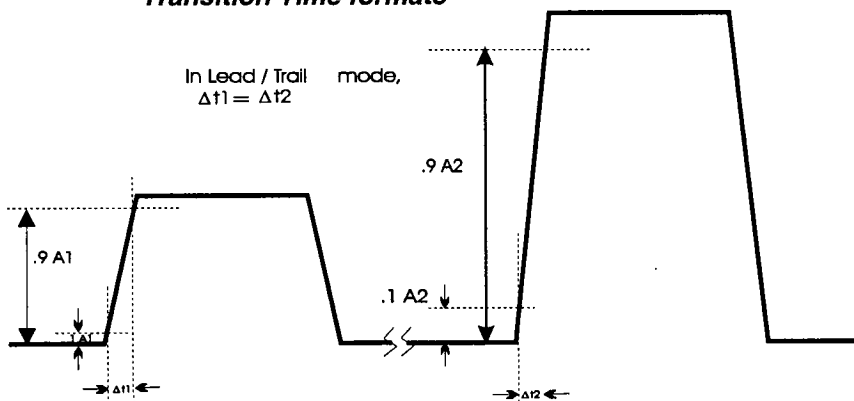

It follows from the parameter definitions that changing the amplitude of the Output Pulse in **{Lead}/{Trail}** mode will cause a change in the edge slopes, while in **{Slew}** mode, the slopes will remain constant.

Note that in the 9214 module, transition time is a fixed parameter. Therefore, **{Lead}**, **{Trail}**, and **{Slew}** cannot be adjusted in that module. Additionally, the **{Slew}** format is not supported in the 9212 module.

Dynamic Range and Transition Rates

In the 9211 and 9213 Output modules, linear edge transitions are created by the charging (or discharging) of capacitors by a programmable current source. The wide range of edge speeds offered by these modules is achieved by switching among a series of capacitors in ranges appropriate to the edge rates requested. This results in each of these modules having several edge speed ranges. Each range covers a span of values of approximately 25:1. Additionally, each range overlaps the next slower range over an area of about 2.5:1, except at the boundary of the two fastest ranges, where the overlap is 2:1.

If an attempt is made to create a pulse with edge speeds sufficiently different from one another as to exceed the boundaries of a given range, priority will be given to the currently selected edge. The range will be switched to accommodate the value requested for the selected edge, the displayed value for the other edge will be updated, and an asterisk (*) will be placed on the display to the left of the other edge's CRTkey, to alert the user that the value has been altered due to the change in ranges. The previous value for the unselected edge is saved in memory and will be restored when possible (i.e. when the boundary range is re-crossed by the selected edge). For information about the range boundaries for a given Output Module, see the Module's Technical Data Sheet.

Double Pulse Operation

The state of the Double Pulse operating mode is controlled by the **{2 Pulse}** CRTkey. In Normal and Single Trigger modes, when **{2 Pulse}** is **OFF**, one Output Pulse will follow each Trigger Output. Turning **{2 Pulse}** **ON** in either of these trigger modes will result in two Output Pulses for each Trigger Output. Be aware that **{Delay}** must be set to a value greater than **{Width}** in order to see the second pulse.

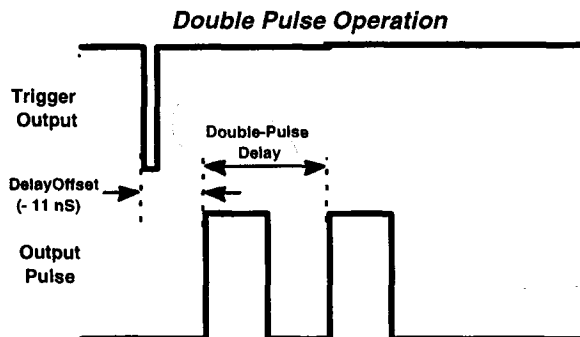

Note that the first of the two Output Pulses in this operating mode will occur approximately 2 nsec sooner than a single Output Pulse programmed for zero delay will. In other words, the delay offset for Double Pulse operating mode is about 2 nanoseconds less than in the standard operating mode.

Double Pulse Operation is compatible with all Trigger Modes except External Width. See the section entitled "Double Pulse Interactions" in Chapter 4 (Trigger Controls) for further details.

Controlling Repetition Rate

The last line of the first page of a Channel menu display provides control over the Output Pulse repetition rate. The default format is:

{Period}: This defines the time between Output Pulses in Normal, Burst and Gate Trigger Modes.

Pressing [CHANGE FORMAT] when **{Period}** is selected will change the display for this parameter to:

{Freq}: This controls the frequency of Output Pulses in Normal, Burst and Gate Trigger Modes.

The difference between these formats is only in the way the rate is specified, and not in any sense an operational difference. This parameter has meaning in Single Trigger Mode only if the pulse duration is specified in **{Duty Cy}** format, in which it is used to calculate the Output Pulse's Width, or if pulse position is specified in **{Phase}** format, where **{Period}** will be used to calculate the Delay. See the "Trigger Modes" section of Chapter 4 for further details.

This parameter is also available on the first page of the Trigger menu.

Parameter Conflicts

It is possible that while adjusting the parameters detailed above, a situation will arise where the requested parameter set is in violation of the basic parameter definitions (see the Glossary, Appendix F, for a listing of the parameter definitions). In such a case, blinking question marks (?) will appear next to each of those parameters involved in the Conflict condition. This occurs when a requested set of parameters is beyond the specified range of operation due to the interaction of two or more parameters.

Pictorial representation of Pulse Parameters

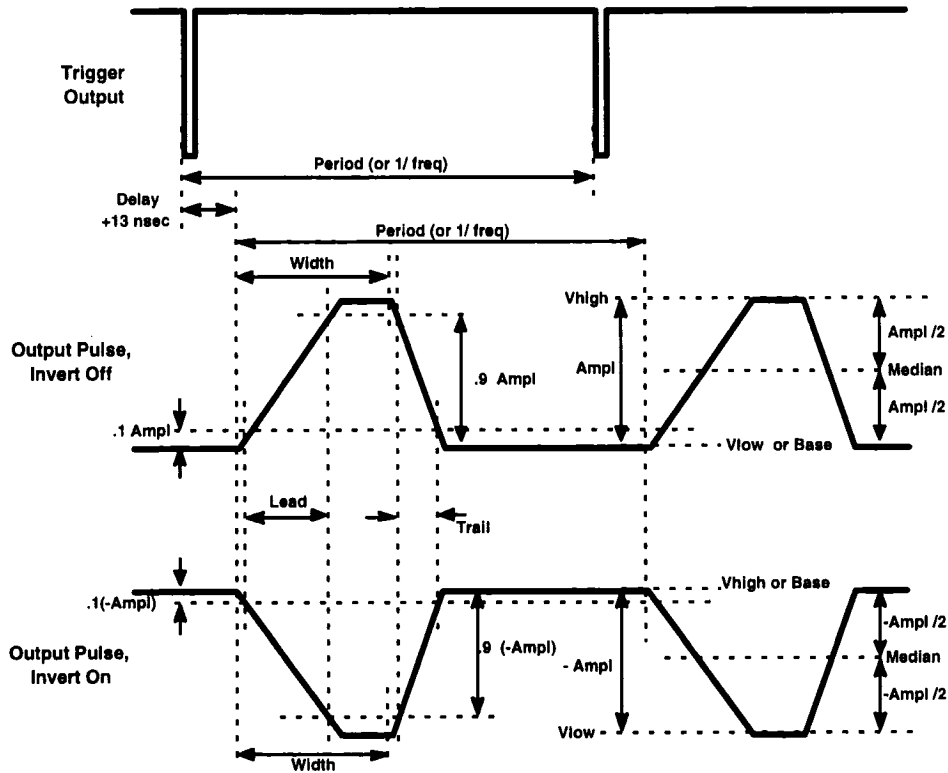

- Notes: 1) Duty Cycle = $(\text{Width} / \text{Period}) \times 100\%$
 2) Phase = $(\text{Delay} / \text{Period}) \times 360^\circ$

Guided by the requirements of your application, select from among the indicated parameters those which can be altered to both resolve the conflict and satisfy the demands of your measurement. The following conditions must be true in order to avoid conflict:

- 1) $V_{\text{high}} > V_{\text{low}}$
- 2) $\text{Lead} < \text{Width}$
- 3) $V_{\text{high}} - V_{\text{low}} \geq \text{Min. Amplitude}$
- 4) $V_{\text{high}} - V_{\text{low}} \leq \text{Max. Amplitude}$
- 5) $1.25 \times \text{Lead} < \text{Width}$

if Limits are enabled (see the section entitled Limiting the Output Levels, below):

6) $V_{high} \geq V_{max}$

7) $V_{low} \leq V_{min}$

if {2 Pulse} is OFF and Trigger Mode is Normal, Burst or Gate:

8) $Width + (1.25 \times Trail) < Period$

9) $Width + Retrig < Period$

10) $Delay + Retrig < Period$

if {2 Pulse} is ON:

11) $Width + (1.25 \times Trail) < Delay$

12) $Width + Retrig < Delay$

if {2 Pulse} is ON and Trigger Mode is Normal, Burst or Gate:

13) $Delay + Width + (1.25 \times Trail) < Period$

14) $Delay + Width + Retrig < Period$

NOTES: The 0% to 100% transition time needed to determine conflicts is 1.25 times greater than the 10% to 90% displayed {Lead} and {Trail} times.

"Retrig" is a time interval during which one of the 9210's timing generators cannot be re-triggered without possibly compromising proper device operation. The exact magnitude of Retrig is dependent upon several operating conditions. It is usually negligibly small and always less than 5 nsec.

Load Compensation

At the top of the second page of the Channel menu display is a CRTkey which controls the state of the 9210's Load Compensation feature. When **{Loadcomp}** is **OFF**, the load is assumed to be 50.00 Ω . The voltage levels delivered to the actual load, based on that assumption, may be up to two times those specified, dependent on the actual load resistance. When **{Loadcomp}** is turned ON, the generator measures the load connected to the Module Output, and calculates a correction factor. It then uses that factor to make the necessary DC corrections to deliver the displayed voltage levels to any load resistance from 47 Ω to 1M Ω . If the load resistance is subsequently changed, **{Loadcomp}** must be turned OFF, then ON again to recalculate the correction factor.

Channel A Page 2 

Loadcomp	OFF
TTL set		
ECL set		
Limits	OFF
V max	...	500mV
V min	...	-500mV

Return New Page

Normal	J 50	DIS
--------	------	-----

Note that the Load Compensation algorithm used in the 9210 is valid for resistive loads only, and cannot correct for damping, ringing or oscillations caused by reactive loads, or for reflections due to transmission line mismatching. Nor can it correct for loads terminated to voltages other than ground (e.g. 50 Ω to -2 V).

Logic Family Presets

{TTL set} and **{ECL set}** are action keys (see "Executing Action Commands" in Chapter 2) which allow the user to quickly assign standard logic family voltage levels to the Output Pulse.

{TTLset} will set **{Vlow}** to 300 mV and **{Vhigh}** to 3.5 V. If the Vertical format is other than **{Vhigh}/{Vlow}**, it will be changed to this format .

{ECLset} will set **{Vlow}** to -1.9 V and **{Vhigh}** to -800 mV.

Limiting the Output Levels

The last three lines of the second page of a Channel menu display provide the user with a means of limiting the requested voltage levels of the Output Pulse, to protect a delicate device under test from application of potentially harmful signal levels.

If **{Limits}** is **ON**, then **{Vhigh}** cannot be set above **{Vmax}**, and **{Vlow}** cannot be set below **{Vmin}**. Any attempt to exceed either limit will produce the message "Value limited to user limit". With **{Limits}** **OFF**, the Module's full specified output swing is available.

Module Considerations

The 9212 and 9214 Output Modules, which feature very fast edge rates (as fast as 300 psec), have slightly different Control Menu Displays. The first pages of the menus for these two modules are pictured below. In the 9212 module, the transition times of both edges of the Output Pulse are adjusted in common. Therefore, there is no **{Trail}** **CRTkey**. Both edges are adjusted by selecting **{Lead}**, but the value of **{Trail}** is updated on the display. Transition time is fixed at 300 psec in the 9214 module, so there are no **CRTkeys** for **{Lead}** or **{Trail}** on that module's control menu.

Channel A Page 1 

Vhigh ... 500mV

Vlow 0V

Width .. 2.00ns

Delay .. 0.00ns

Lead $\begin{matrix} +400ps \\ -300ps \end{matrix}$.. 0.5ns

Trail $\begin{matrix} 10 \\ 90 \end{matrix}$.. 0.50ns

2 Pulse OFF

Main

Period . 10.00ns

Normal \int 50 DIS

**9212 Module Control
Menu Display - Page 1**

Channel B Page 1 

Vhigh ... 500mV

Vlow ... 0V

Width .. 2.00ns

Delay .. 0.0ns

2 Pulse OFF

Main

Period . 10.00ns

Normal \int 50 DIS

**9214 Module Control
Menu Display - Page 1**

The 9210 Mainframe's display also indicates the specified Transition Time tolerances for any given setting in the 9212. When the LEAD menu box is selected on the 9210's TouchCRT, the tolerance window will be displayed to the right of the parameter's name (where the edge symbol appears when the key is not selected). For example, when LEAD is set to 0.7 nsec, the displayed tolerance window will be ± 440 psec. These limits will be updated as the value is varied. Note that the tolerance window applies to the trailing edge as well as the leading edge.

Channel A Page 2 

Loadcomp OFF

TTL set

ECL set

Limits OFF

Vmax ... 500mV

Vmin ... -500mV

Output **ON**

/Output OFF

Return · New Page

Normal | **J 50** | **DIS**

**9212 and 9214 Module
Control Menu Display -
Page 2**

Because of the very fast edges these modules can generate, the output amplifiers in the 9212 and 9214 require matching terminations on their two outputs in order to maintain proper edge fidelity. To allow the user to leave unused outputs unterminated, options have been added to the second page of the control menus for these modules to disconnect and internally terminate either of the outputs in 50 Ω . This menu is shown above.

When **{Output}** is turned **ON**, the output relay for the module's normal output connects the output amplifier to the SMA connector on the front panel. When **{Output}** is turned **OFF**, the output relay for the module's normal output connects the output amplifier to an internal 50½ precision resistor. The same applies to **{/Output}** and the complemented output.

These **CRTkeys** interact with the **[Disable]** pushbutton on the module's front panel, which disconnects both outputs simultaneously. For example, the complementary output is only enabled when **{/Output}** is **ON** and **[Disable]** is **OFF** (i.e. when the red LED on the module's front panel is not lit).

In the 9212 and 9214 modules, transition times are specified from 20% to 80% of the full-scale transition, rather than from 10% to 90%. This method of specifying transition time is typical of fast transition time devices, such as ECL and GaAs logic IC's.

The table on the following page lists the factory default settings for the Models 9211, 9212, 9213 and 9214 Output Modules. These are the settings which will be obtained when the **{Standard}** option is executed after the **[Recall Setup]** key has been pressed. The Trigger parameters listed below (from Mode through Input Z) are explained in Chapter 4, "Trigger Controls".

**Default Settings for Output Modules for the
LeCroy 9210 Programmable Pulse Generator**

Module	9211	9212	9213	9214
Vhigh	1.000 V	500 mV	1.000 V	500 mV
Vlow	0 mV	0 mV	0 mV	0 mV
Width	20.00 ns	2.00 ns	20.00 ns	2.00 ns
Delay	0.00 ns	0.00 ns	0.00 ns	0.00 ns
Lead	1.00 ns	0.40 ns	5.00 ns	n/a
Trail	1.00 ns	0.40 ns	5.00 ns	n/a
2 Pulse	OFF	OFF	OFF	OFF
Period	100 ns	100 ns	100 ns	100 ns
Loadcomp	OFF	OFF	OFF	OFF
Limits	OFF	OFF	OFF	OFF
Vmax	500 mV	500 mV	500 mV	500 mV
Vmin	-500 mV	-500 mV	-500 mV	-500 mV
Output	ON	ON	ON	ON
/Output	ON	ON	ON	ON
Mode	Normal	Normal	Normal	Normal
Burst Ct	3	3	3	3
Level	0.10 V	0.10 V	0.10 V	0.10 V
Slope	Positive	Positive	Positive	Positive
Outlvl	0.10 V	0.10 V	0.10 V	0.10 V
Input Z	50 Ω	50 Ω	50 Ω	50 Ω
Invert	OFF	OFF	OFF	OFF
Disable	ON	ON	ON	ON

The table on the following page lists the specified limits for the parameters detailed in this chapter for the Models 9211, 9212, 9213 and 9214 Output Modules. Vertical specifications listed in parentheses () apply when driving a high impedance load ($\geq 10 \text{ k}\Omega$), those without parentheses apply when driving 50Ω .

Output Module Parameter Limits for the LeCroy 9210 Modular Pulse Generator								
Parameter	Model 9211		Model 9212		Model 9213		Model 9214	
	Min	Max	Min	Max	Min	Max	Min	Max
{Vhigh}	-4.95 V (-9.90 V)	+5.00 V (+10.00 V)	-4.50 V (-4.00 V)	+5.00 V (+5.00 V)	-7.98 V (-15.96 V)	+8.00 V (+16.00 V)	-4.50 V (-4.00 V)	+5.00 V (+5.00 V)
{Vlow}	-5.00 V (-10.00 V)	+4.95 V (+9.90 V)	-5.00 V (-5.00 V)	+4.50 V (+4.00)	-8.00 V (+16.00 V)	+7.98 V (+15.96 V)	-5.00 V (-5.00 V)	+4.50 V (+4.00)
{Ampl}	50 mV (100 mV)	5.00 V (10.00 V)	500 mV (1.00 V)	5.00 V (10.00 V)	20 mV (40 mV)	16.00 V (32.00 V)	500 mV (1.00 V)	5.00 V (10.00 V)
{Base}	-5.00 V (-10.00 V)	+5.00 V (+10.00 V)	-5.00 V (-5.00 V)	+5.00 V (+5.00 V)	-8.00 V (-16.00 V)	+8.00 V (+16.00 V)	-5.00 V (-5.00 V)	+5.00 V (+5.00 V)
{Median}	-4.975 V (-9.950 V)	+4.975 V (+9.950 V)	-4.75 V (-4.50 V)	+4.75 V (+4.50 V)	(-7.99 V) (-15.98V)	(+7.99 V) (+15.98 V)	-4.75 V (-4.50 V)	+4.75 V (+4.50 V)
{Width}	2 nsec	450 msec	1.2 nsec	450 msec	5 nsec	450 msec	1.2 nsec	450 msec
{Duty Cy}	1%	99%	1%	99%	1%	99%	1%	99%
{Delay}	0 nsec	450 msec	0 nsec	450 msec	0 nsec	450 msec	0 nsec	450 msec
{Phase}	0 _	359.9 _	0 _	359.9 _	0 _	359.9 _	0 _	359.9 _
{Lead}	1.2 nsec	10 msec	300 psec	1 nsec	6.5 nsec	95 msec	300 psec	300 psec
{Trail}	1.2 nsec	10 msec	300 psec	1 nsec	6.5 nsec	95 msec	300 psec	300 psec
{Slew}	0.1 V/msec	3.3 kV/ μ sec	N/A	N/A	0.1 V/msec	2.3 kV/ μ sec	N/A	N/A
{Period}	4 nsec	450 msec	3.33 nsec	450 msec	20 nsec	450 msec	3.33 nsec	450 msec
{Freq}	2.2 Hz	250 MHz	2.2 Hz	300 MHz	2.2 Hz	50 MHz	2.2 Hz	300 MHz

Values above the bold double line in the table are the actual minimum and maximum values which will be accepted by the mainframe. Values below the bold double line are guaranteed specifications but the mainframe may accept values outside the indicated range. Certain combinations of the above parameters may not be achievable simultaneously. See the section of this chapter entitled Parameter Conflicts for details.

Specifications subject to change without notice.

4

TRIGGER CONTROLS

General Information

The 2 Output Modules in the 9210 are driven from a common timebase, i.e. the channel outputs are both referenced to the same trigger. This does not mean that the two channels must both output their pulses at the same time, or that they must be of identical width, but merely that the repetition rates and Trigger modes of the 2 channels must be the same.

The Trigger Output

The signal available at the 9210's **Trigger Output** connector is a negative-going pulse, synchronized with the **{Ext Input}** signal, if any, and the 9210's internal timebase. **{Delay}** is relative to this signal's leading (negative) edge. The width of the **Trigger Output** is dependent upon the selected Trigger **{Mode}** and other operating conditions. Its amplitude will be 1 V into a 50 Ω load (2 V into an open circuit), and its quiescent level is programmable (see the section entitled "Adjusting the Trigger Output Offset", below).

The Trigger Input

The 9210 can be adjusted to trigger on any signal connected to the **Ext Input** connector whose amplitude is greater than 200 mV, at frequencies up to 300 MHz, (note that not all Output Modules will be able to deliver pulses at the mainframe's maximum trigger frequency). Trigger pulses as narrow as 1.5 nsec can be accommodated.

The impedance of the Trigger Input can be programmed to either 10 k Ω , or 50 Ω ($\pm 5\%$). See the section entitled "Selecting the Trigger Input Impedance" below for further details. The signal levels at the **Ext Input** must not exceed ± 5 V into 50 Ω , or ± 20 V into 10 k Ω .

Trigger Page 1

Normal
 Single
 Gate
 Burst
 Ext Wid

Mode . . . **Single**

Burst Ct 3

Level 260mV

Slope . Positive

Auto lvl

Period . 10.00ns

Single	┌ 50	. DIS
--------	------	-------

Frequency Counter

In the externally triggered modes (Single, Burst, Gate and External Width), the 9210's internal frequency counter measures the frequency of the signal at the **Ext Input**, and displays the result of the measurement in the information window while the Trigger Menu is displayed.

Trigger Modes

The CRTkey at the top of the first page of the Trigger menu display, **{Mode}**, is used to select the 9210's Trigger Mode. When **{Mode}** is selected, the modes are listed on the screen in a box at the upper right (see above). The operating characteristics of the Trigger Modes are described below. See the section entitled "Non-Numeric Entries" in Chapter 2 of this manual for details on making selections from this menu.

Normal Mode

{Normal} trigger mode produces a continuous Pulse stream at the selected **{Period}** and **{Width}**. One **Trigger Output** will occur for each Output Pulse. The width of the **Trigger Output** will be dependent upon the repetition rate. See the table below for details. The Output Pulse follows the **Trigger Output** by **{Delay}**, plus an offset of ≈ 13 nsec.

Normal Trigger Mode is free - running, requiring no external trigger signal.

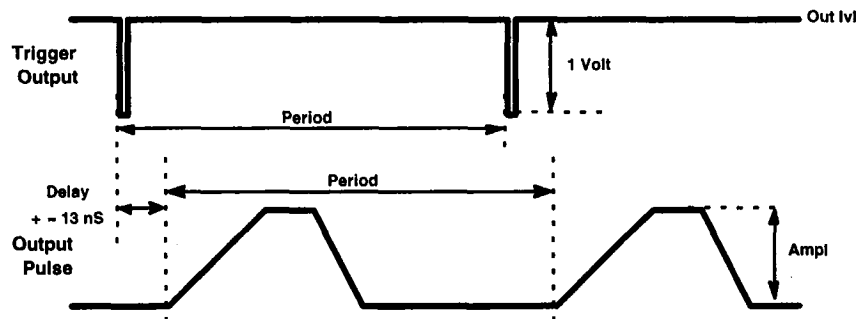

Nominal Trigger Output Widths in Normal Trigger Mode	
If the Period is...	The Trigger Output Width will be...
<7.2 nsec	1.8 nsec
7.2 nsec < Period < 50 nsec	3.6 nsec \leq Trigger Out Width \leq 7.2 nsec
> 50 nsec	25 nsec

Single Mode

{Single} mode is triggered externally, either from the front panel **Ext Input**, the **Manual** Trigger button, or via GPIB command. The trigger starts the 9210's timebase. One **Trigger Output** follows each trigger by ≈ 21 nsec. The **Trigger Output** width is dependent upon the Output Pulse **{Width}**. If **{Width}** is 40 nsec or less, the **Trigger Output** will be 1.8 nsec wide. If **{Width}** is greater than 40 nsec, the **Trigger Output** will be 25 nsec wide. If 2 Output Modules are installed, the larger **{Width}** setting is used to determine the **Trigger Output** width.

Single Trigger Mode produces 1 Output Pulse per Trigger Input, or 1 Pulse Pair per trigger if 2-Pulse is ON.

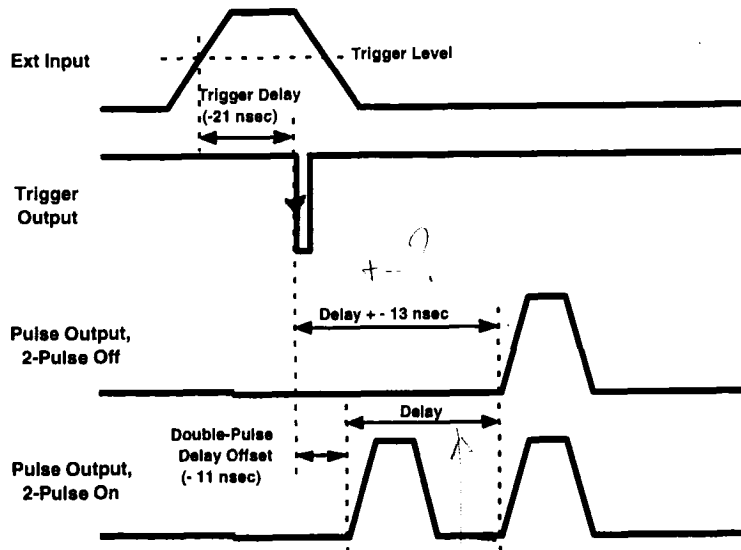

* Appendix A
NS-103

set delay time.

As above, the Output Pulse will follow the **Trigger Output** by **{Delay}** + ≈ 13 nsec. The **{Period}** parameter has no meaning in **Single** Trigger Mode, unless the **{Duty Cy}** format is selected, in which case **{Period}** is used to calculate the Width of the Output Pulse, or if **{Phase}** format is selected, where **{Period}** will be used to calculate Delay.

Gate Mode

In **{Gate}** mode, Output Pulses of the programmed **{Width}** occur at the rate specified by **{Period}** as long as the signal at the **Ext Input** is in the state defined as true (see the section entitled "Trigger Slope and Level", below). One **Trigger Output** Pulse follows each external input by ≈ 21 nsec. The width of the **Trigger Output** will be roughly equal to the width of the External Input signal.

In Gated Trigger Mode, Output Pulses start after the Delay, and continue to run at the rate defined by Period, for the duration of the true state of the Gate Input

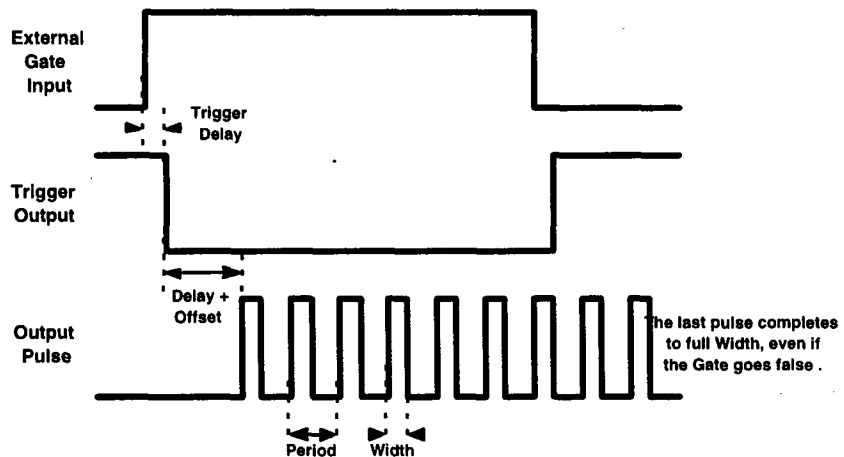

The first Output Pulse follows the **Trigger Output** by **{Delay}** + ≈ 13 nsec. If the external input goes false while an Output Pulse is active, the **{Width}** and **{Trail}** will be completed as specified by the parameter settings.

NOTES:

- 1) To allow the 9210's internal timing generator circuits to fully re-initialize, there is a minimum re-trigger interval (i.e. dead time) of 20 nsec after the completion of the last Output Pulse in Gate Mode.
- 2) The front panel **Manual** Trigger button can be used to simulate a Gate input. The output will remain active for as long as the button is held in.

Burst Mode

{Burst} mode is similar to **{Single}** mode, but a programmed number of Output Pulses is generated for each external input, rather than just one. This number may be programmed from 3 to 4095 by selecting and setting **{Burst Ct}** (burst count), on the second line of the first page of the Trigger menu display. A burst of two pulses can be created in **{Single}** mode via Double Pulse operation (see "Double Pulse Operation" in Chapter 3, and "Double Pulse Interactions", below).

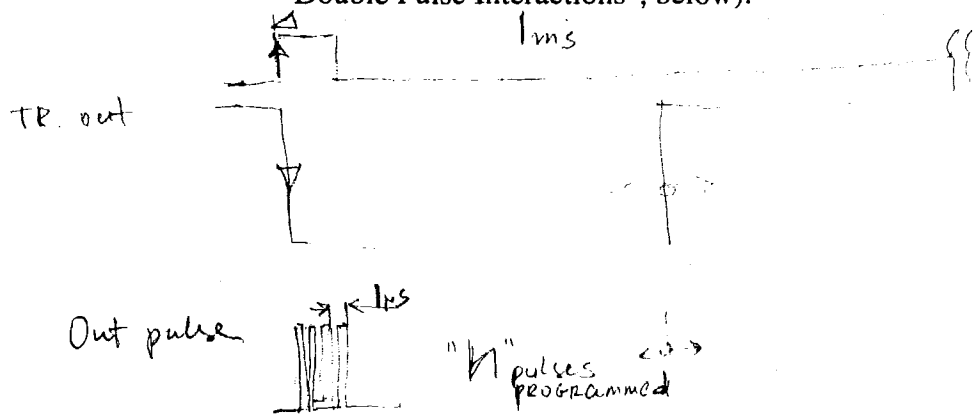

In Burst Trigger Mode, a programmed number (the Burst Count) of pulses are output for each trigger. The Trigger Output's width will be equal to Period X (Burst Count - 1).

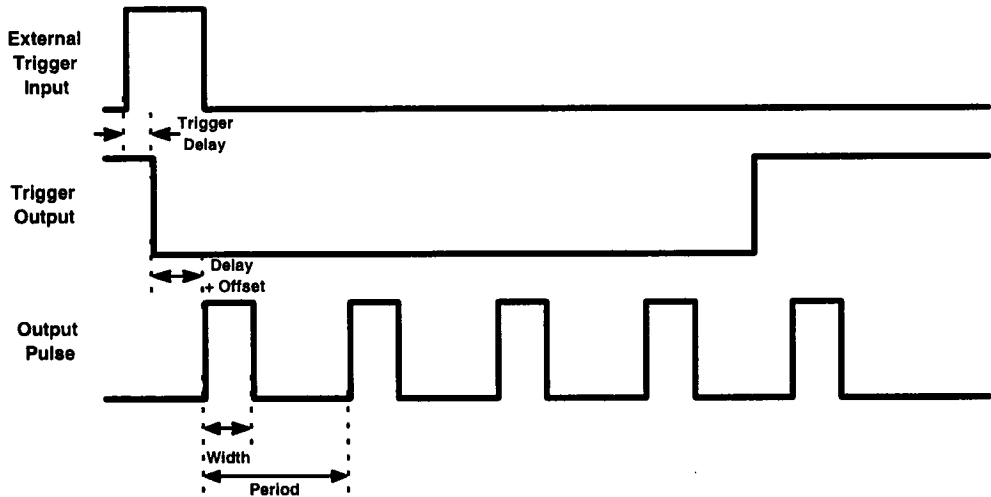

One **Trigger Output** follows each trigger by ≈ 21 nsec. The **Trigger Output** width will be equal to the **{Period}** times the **{Burst Ct}** - 1. **{Delay}** (+ ≈ 13 nsec) specifies the time from the leading edge of the **Trigger Output** to the leading edge of the first Output Pulse, the time between Output Pulses is specified by **{Period}** and the duration of each Output Pulse is specified by **{Width}**.

NOTE: To allow the 9210's internal timing generator circuits to fully re-initialize, there is a minimum re-trigger interval (i.e. dead time) of 50 nsec after the completion of the last Output Pulse in Burst Mode.

In External Width Mode, the signal at the Ext Input is reproduced at the Output with programmable transition times and voltage levels

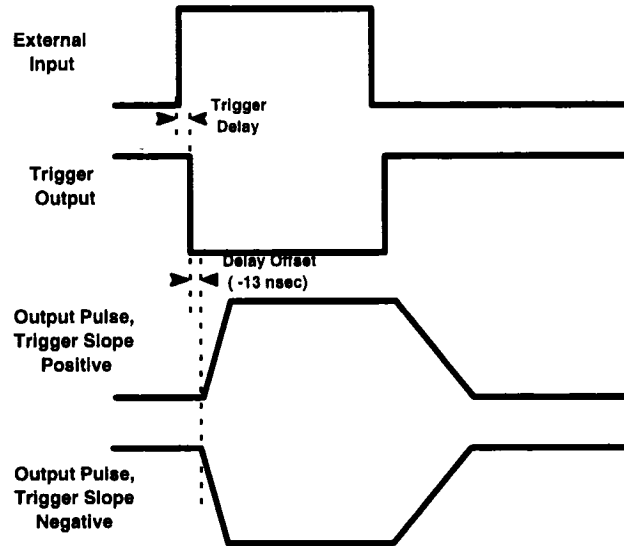

External Width Mode

In **{Ext wid}** (external width) mode, the signal at the **Ext Input** is reproduced at the Module Output with programmable transition times and output voltage levels. If the trigger **{Slope}** (see "Setting the Trigger Level and Slope" below) is set to **Negative**, the module's normal output will be inverted with respect to the **Ext Input**. If **{Slope}** is **Positive**, the normal output follows the **Ext Input** directly. A **Trigger Output** follows each input signal by ≈ 21 nsec, and the width of the **Trigger Output** will be roughly equal to that of the external input signal. The Output Pulse follows the **Trigger Output** by the ≈ 13 nsec delay offset.

{**Delay**}, {**Width**} and {**Period**} adjustments made when the generator is in {**Ext wid**} mode will become effective when the Trigger Mode is changed, but these settings are meaningless in External Width mode.

The front panel **Manual** Trigger Button can be used to simulate an input signal in {**Ext wid**} mode. The output will remain in the active state for as long as the button is held in.

Double Pulse Interactions

The interaction of Double Pulse operation with the various Trigger Modes is detailed below. Note that while the Trigger Mode is common to both channels, {**2 Pulse**} can be enabled in either channel independently of the other.

Normal Mode

Two Output Pulses follow each **Trigger Output** rather than 1. The first will trail the Trigger's leading edge by the double pulse delay offset of ≈ 11 nsec, and the second will follow the first by the {**Delay**}.

Single Mode

Same as **Normal** Mode, except that triggers must be received from some external source.

Gate Mode

Again, the same as **Normal** Mode, except only while the signal at the **Ext Input** is in the true state. (See "Setting the Trigger Level and Slope" below.)

Burst Mode

In this case {**Burst Ct**} specifies the number of Output Pulse pairs, rather than the number of Output Pulses, per trigger. The first pulse of the first pair in any burst will follow the leading edge of the **Trigger Output** by ≈ 11 nsec, the second pulse in any pair follows the first by {**Delay**}, and the first pulse of any pair follows the first pulse of the previous pair by {**Period**}.

External Width Mode

{Ext wid} Mode is incompatible with Double Pulse operation, i.e., its function is unaffected by the state of **{2 Pulse}**.

Setting the Trigger Level and Slope

The user may specify the point on the **Ext Input** signal at which the generator will trigger by utilizing the **{Slope}** and **{Level}** CRTkeys. The control provided by these keys is as follows:

{Level} selects the voltage threshold that must be crossed by the **Ext Input** signal in order to trigger the 9210.

{Level} can be set to any value between ± 2.5 V with 20 mV .

{Slope} determines the direction of the transition (**Positive** or **Negative**) through the specified voltage **{Level}** that will trigger the generator. **{Slope}** may also be set to **Disable**, in which case the generator will not respond to the external input at all. In External Width mode, setting **{Slope}** to **Negative** causes the pulse at the module's normal output to be inverted with respect to the signal at the **Ext Input**

Setting the Trigger Level Automatically

{Auto lvl} is an action key which enables the 9210 to determine an appropriate setting for **{Level}** such that the 9210 will trigger on the edge of the **Ext Input** signal specified by **{Slope}** (if **{Slope}** is set to **Disable**, executing **{Auto lvl}** will reset it to **Positive**). It will take a few seconds for the proper level to be found. Touching **{Auto lvl}** and **{Execute}** with no signal (or an inappropriate signal) connected to the **Ext Input** will bring an error message to the screen.

Parameter Limits and Triggering

When the maximum Width or Delay settings are approached (within about 500 psec) in **Single** trigger mode, the error message "TRIGGER TOO FAST" may appear in the information window. This occurs because the Width or Delay timing generator circuit has been re-triggered before it has recovered from the previous trigger. The message is meant to indicate that a trigger may have been missed. However, if a trigger is received during the first 500 psec after the timing generator asserts that it is actually ready to re-trigger, the error detection circuitry may still trip and produce the error message.

Setting the Internal Trigger Rate

In **Normal** Trigger Mode, the 9210 triggers itself at a rate determined by the **{Period}** parameter, which can be adjusted from the bottom line of the first page of the Trigger menu display, just as it can on the Channel Menus. (Internal triggers are also utilized in **Gate** and **Burst** Modes, but only after an external trigger has started the period generator.) The **{Freq}** format may also be used. See the section entitled "Controlling Repetition Rate" in Chapter 3 for further details.

Using The Manual Trigger Button

Pressing the **[Manual]** trigger button on the front panel is effectively identical to delivering a trigger pulse which exceeds threshold (see the section entitled "Setting the Trigger Level and Slope", above) to the **Ext Input** connector. Furthermore, in **Gate** and **External Width** modes, holding this button in causes the trigger "signal" to remain true until the button is released.

Adjusting the Trigger Output Offset

The top line of the second page of the Trigger menu display, **{Out lvl}**, controls the quiescent level of the **Trigger Output**. The range of programmable values for **{Out lvl}** is from -1.5 V to +1.5 V, with resolution of approximately 20 mV. The Trigger Output's active level will nominally be 1 V below the programmed quiescent level.

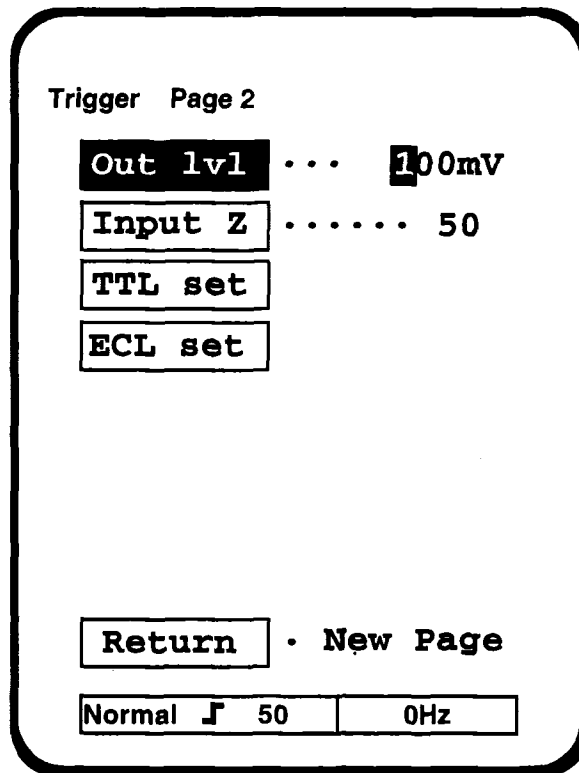

Keep in mind that the levels listed above assume operation into a load of 50 Ω . If the **Trigger Output** drives an open circuit, the quiescent level will be twice that reported by **{Out lvl}**, and the Trigger amplitude will nominally be 2 V.

Selecting the Trigger Input Impedance

The user may select the impedance presented by the 9210's **Ext Input**. **{Input Z}** can be set to either **50 Ω** or **HI_Z**. When set for **HI_Z**, the impedance is 10 k Ω .

Trigger Output Presets

{TTLset} and **{ECLset}** on the Trigger menu display are action keys which provide the user with a shorthand method of establishing voltage levels at the **Trigger Output** compatible with the standard logic families in use today.

Touching **{TTLset}** and then **{Execute}** will set **{Out lvl}** 1.24 V. While this is admittedly not a standard TTL high level, remember that the quiescent level doubles into a high impedance (which a TTL circuit will present to the generator), and 2.48 V is more than enough to be recognized as a high by any TTL-compatible logic family. The active pulse level in this case will be 480 mV, which will certainly be recognized as a TTL low.

Executing **{ECLset}** will make **{Out lvl}** -850 mV, well within the specified limits for an ECL high level. The high frequencies and fast edge rates common to ECL applications dictate the use of good co-axial cable with proper termination when introducing an external signal, so a 50 Ω load is assumed. The active **Trigger Output** level in this case will be -1.85 V, again, well within the specified limits for an ECL low.

5 THE "MORE" MENU - UTILITIES AND FEATURES

Invoking Self-Calibration

The top line of the More menu display, **{Cal}**, is an action key which, when **{Execute}** is touched, will cause the 9210's measurement system to begin a calibration cycle. Calibration insures the accuracy of all Voltage and Time parameters listed on the Channel menu displays.

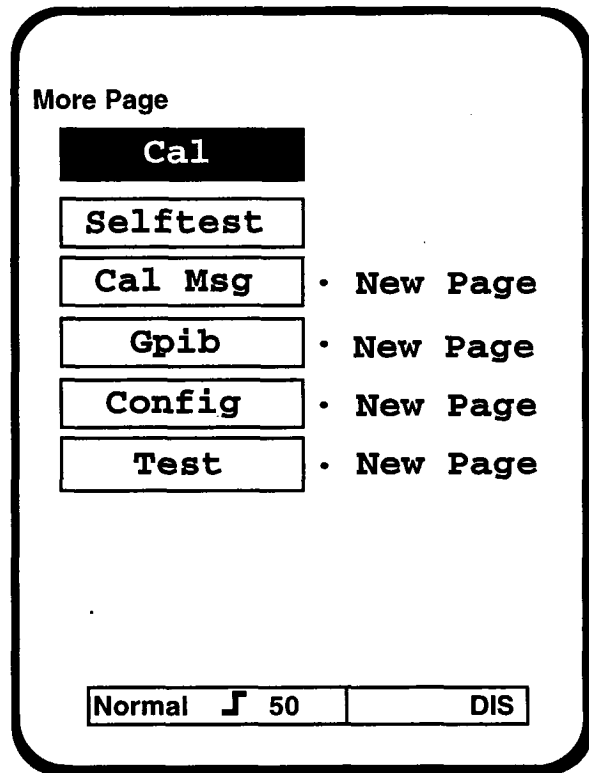

This action will require approximately 30 seconds to execute with one Output Module installed, somewhat longer with two Modules. The message "Calibration in progress" will occupy the display until the calibration is complete, at which time another message will appear to inform you of the success or failure of the procedure. A complete listing of the results of the calibration can be brought to the display via the **{Cal Msg}** key (see below). If calibration is canceled while it is in progress, those calibration parameters that have been derived during the process will be used, while those that had not been determined will retain their values from the previous calibration.

Calibration is automatically performed at power-up. In order for the 9210 and its installed Output Modules to meet their published specifications, a new calibration must be performed after about 15 minutes of operation, by which time the generator should be fully warmed up. The message "Self-Cal suggested" will appear in the information window at the bottom of the display 15 minutes after power-up to prompt the user. The message will be removed from the display as soon as any operation is performed.

The 9210's Temperature Compensation feature monitors and adjusts timing for operating temperature changes over a 5° C range. If the operating temperature changes by more than 5° C, the generator will issue the warning message "Self-cal suggested" to inform the user that this feature may no longer be able to make the necessary corrections. See the "Temperature Compensation" section at the end of this chapter for further details.

Invoking Selftest

{Selftest}, is an action key which, when **{Execute}** is touched, will cause the 9210 to perform a full Self-test cycle. Self-test includes the Calibration described above as well as various tests on system memory, video display circuitry, and the trigger, threshold and slope controls. **{Selftest}** requires about a minute to complete, slightly longer if two Output Modules are installed.

The results of **{Selftest}** can be brought to the screen via the **{Cal Msg}** key, as above. The calibration results are reported first, followed by the results of the additional tests.

NOTE: Signals with fast edge rates and large amplitude connected to the 9210's **Ext Input** may cause the Self-test to fail. It is therefore recommended that the **Ext Input** be left open while Self-test is in progress.

Previous Msg

```

Calibrate Starts.....
Test ADC.....Passed
Test FCNT.....Passed
Cal TDC.....Passed
    Pedestal: 252 to 260
                mean: 255
    62.5ns: 3402 to 3431
                mean: 3418
Cal Period vco.....Passed
Cal delay A vco.....Passed
Cal width A vco.....Passed
Cal delay B vco.....Passed
Cal width B vco.....Passed
  
```

Down

Return · New Page

*First page of Calibration
Message Screen*

Gpib Page

Mode LON

Address 1

Gpib Command	Error Code
CHDR OFF;	0

Return · New Page

*GPIB Control / Monitor
Screen*

Calibration and Selftest Results

A complete listing of the results of the last self calibration or self-test can be brought to the display by touching **{Cal Msg}**. The information contained within this multi-page listing is invaluable in determining the seriousness and possible causes of a self calibration or selftest failure. It is suggested that you review this listing before contacting your LeCroy service representative regarding such failures.

A description of the tests performed by **{Cal}** and **{Selftest}** can be found in Appendix D of this manual (GPIB Documentation), in the section entitled "Selftest".

Monitoring the GPIB Interface

Touching **{Gpib}** will bring to the CRT a screen on which all GPIB transactions involving the 9210 are displayed, along with any error codes which may have resulted, in a window at the center of the screen.

The top 2 lines of this screen allow the user to select the GPIB operating **{Mode}** for the 9210, and to select the Bus Address of the generator. **{Mode}** can be set for Addressed (**Addr**) or Listen Only (**LON**), and valid choices for Address are the integers from 0 to 30, inclusive. See Chapters 6 and 7, and Appendices D and E for further details about GPIB operation.

Testing the User Interface

Touching **{TEST}**, the sixth line of the More menu display, will bring a new screen to the 9210's display with 2 choices, **{Tch Test}** and **{Key Test}**.

The **{Tch Test}** screen contains 11 **CRTkeys**, each of which should highlight when touched. This screen can be exited by pushing any of the front panel **DISPLAY** keys. If this test is requested with the Touch Screen disabled, it will be automatically enabled.

The **{Key Test}** screen contains a representation of all the buttons on the 9210's front panel. Each symbol should light when the button it represents is pushed. The symbol labeled **FINE** represents the inner vernier knob, and the one labeled **COARSE** represents the outer ring. When either knob is turned, its symbol should both light up and indicate the direction (+1 or -1) of the turn. Note that the only way to exit this screen is by use of the **{Return} CRTkey** at the bottom of the display. For this reason, the TouchCRT will be automatically enabled if this test is requested with the Touch Screen disabled.

The Configuration Menu

The **{Config} CRTkey**, on the fifth line on the More menu page, will bring another menu page to the 9210 Mainframe's display. The Configuration menu contains **CRTkeys** to control the Screen Saver feature, to disable and enable the Touch Screen, to control the display's brightness, and to enable and disable the Temperature Compensation feature. This control menu is shown below.

Configuration Page

ScrnSave	OFF
Bright	12
TouchCRT	ON
TempComp	ON

Return	• New Page
---------------	-------------------

Normal	┌ 50	
--------	------	--

The Screen Saver

The 9210's Screen Saver feature will diminish the brightness of the CRT if no front panel controls (buttons, knobs or CRTkeys) have been manipulated for more than 7 minutes. This feature is enabled in factory default settings, but can be disabled by setting **{Scrn Save}** to **OFF**.

Disabling the Touch Screen

The 9210's TouchCRT user interface utilizes infra-red transmitter and receiver diodes as the sense elements. The operation of these optical diodes can be adversely affected if the unit is operated in intense sunlight or incandescent light. Should you need to operate under such conditions and experience problems with the interface, the Touch Screen can be disabled and the "SELECT" keys (up and down arrows) can be used to select the parameters to be programmed. The 9210's Touch Screen is enabled by factory default setting. It can be disabled, if desired, by setting **{TouchCRT}** to **OFF**.

The Touch Screen can also be disabled at power-up, by holding a finger on the screen while pushing the **[POWER]** button, and keeping it there until the "Calibration in Progress" message appears. Another message will then appear to alert the operator that the screen will be disabled.

Display Brightness

The brightness of the 9210's CRT display can be changed to a more comfortable level by adjusting the value of **{Bright}**. The range of values for this variable are the integers between 1 and 16, inclusive.

Temperature Compensation

The 9210 senses the internal temperature of its timing ICs and attempts to compensate for changes of 0.1°C or greater. This maintains timing accuracy within specifications over a range of temperature variation of greater than $\pm 5^\circ \text{C}$ since the last calibration. The timing shift caused by such small changes in temperature is always much smaller than the 9210's timing accuracy specification, and will not be noticeable in most situations. However, in some cases, it may be more desirable to permit the timing to drift gradually with temperature than to permit sudden changes of even small magnitude. For such cases, **{Temp Comp}** may be set to **OFF** from the bottom line of the More menu display.

When **{Temp Comp}** is **OFF**, timing can be expected to drift by as much as 0.2%/° C. **{Temp Comp}** is set to **ON** by factory default setting. We suggest that **{Temp Comp}** should only be turned **OFF** after a self calibration has been performed after at least 15 minutes of warm-up. **{Temp Comp} OFF** is appropriate in cases where sudden timing changes on the order of 0.03% (0.1% worst case) cannot be tolerated.

Note that starting 15 minutes after power-up, and at five minute intervals, the 9210 checks to see if temperature has changed by more than 5° C since the last self-calibration. If so, a message is displayed suggesting that you invoke a new self-calibration cycle, in order to assure the generator's specified accuracy. The temperature change since the last self-calibration is part of the **{Cal Msg}** created by each calibration cycle.

The change in temperature since the last self-calibration can be queried over the GPIB. See Chapter 7 for details.

6

REMOTE OPERATIONS

General Information

Remote operation of the 9210 is IEEE STD 488.2-1987 compatible. This ensures that input is accepted in a flexible way, and responses are presented in a strictly defined manner designed to be easy for the user to deal with. If you are not familiar with 488.2, you should read the following section in order to take advantage of some of its features.

Terminology

Commands and queries (commands which get an answer via GPIB) are called "program message units". A "program message" consists of one or more "program message units". On input, the "program message terminator" is EOI with the last character of the message or with Line Feed, or Line Feed alone. The "program message unit separator" (for separating multiple units in one program message) is ';'.

Numeric Representation

NRf stands for Numeric Representation, flexible. All of the following are equivalent as input using this representation:

```
100E-9
100.000000000000000000000000000000 E -9
000000100000E-000012
100n
100N
```

NOTE: Input is always case insensitive.

On output, one of three stricter formats, typically NR3, is used instead of NRf. NR3 never has leading zeroes or embedded spaces, or an unreasonably large number of digits, and always has an exponent of the form "E<sign><value>".

Header Compounding

The keyword part of a command or query is called a "header". Commands and queries which are made up of more than one word separated by ':' are compound headers. The only compound headers used in the 9210 are for module specific commands, where the commands are of the form <module ID>:<command>, for example A:VHI. The module ID must be either A or B. Commands which are not module specific must not have a module ID. If multiple module specific commands are sent in the same program message, the module ID is remembered and need not be used on each command. For example, the following is valid: "FREQ 100E6; A:VHI 3; VLO 5; TRMD SINGLE; LEAD 5ns". Note that VHI, VLO and LEAD all apply to module A.

Coupled Commands

Coupled commands are commands which interact. For example, in Normal trigger mode, Width must be less than Period. If the message "A:WIDTH 100E-9" is sent, it may or may not produce an invalid state depending on the current trigger mode and Period. If coupled commands are sent in one program message, they are all evaluated when the program message terminator is received. For example, the message "TRMD NORMAL; A:WIDTH 100E-9; PER 200E-9" can never produce an error due to the previous trigger mode or Period.

Responses

If a program message contains one or more queries, it will get one "response message". For example, "A:VHI?;VLO?" might get the answer: "1.00E+0;0.000E+0". The response message terminator is always line feed with EOI.

Status Reporting and Service Requests

The 9210 implements the 488.2 standard status byte and the standard event status register. In addition, we implement an "error queue". The error queue summary bit (1 when the queue is not empty) is bit 7 in the main status byte. The status byte and event status register are described in detail in Appendix D. For further information about the error queue, see the "ERR?" query in Chapter 7 (GPIB Commands), and the list of possible errors in Appendix E.

Common Commands

IEEE Std 488.2 defines certain commands which all instruments claiming to be 488.2 compatible must implement, and other commands which are optional but, if implemented, must be implemented in a manner defined in the standard. These are called common commands. The first character of all common command headers is "*". For example, all 488.2 instruments should respond to "*CAL?" by performing calibration and returning "0" if there were no errors.

General Information

This section describes the syntax of commands to control the 9210 via GPIB. It does not describe operation of controlled features; other parts of the manual describe operation.

Header names must match all the characters shown. Extra characters are ignored so, for example, you may send "WIDTH" for "WID" or "PERIOD" instead of "PER".

Exception: The first three characters of the received header are used to compute a hash value (look-up index).

Therefore, extra characters may not be added to headers shorter than three characters. Only one header, "BC", is shorter than three characters.

Character arguments are matched to a maximum of four characters so, for example, "TRMD NORM" will work as well as "TRMD NORMAL".

In the tables below, the first line of each header's documentation gives the header name, an English description, and a list of attributes which may include the following:

CMD - this header may be sent as a command.

QRY - this header may be sent as a query, i.e., with question mark immediately following it. A response will be generated.

MOD_ID - this header requires a module id. Either it must be preceded by "A:" or "B:", or some previous module specific command in the same program message must have been preceded by "A:" or "B:".

CPLD - This is a coupled command. The argument to this command may or may not cause an error depending upon the parameter settings enacted by other commands. Execution of these commands is postponed until the program message terminator is received, to give the user a chance to change multiple coupled items with one program message, without generating any error status.

Commands Which Correspond To Local Controls

***CAL** **Perform calibration and return error code** **QRY**

Query: No arguments.

Example: *CAL?

Notes: Returns 0 if no error.

Calibration takes about 30 seconds to complete with one Output Module installed, slightly longer with two Modules.

RCL Recall a saved state*CMD**

Command: 1 argument, NRf.

Units: dimensionless.

Example: *RCL 0

Notes: Valid arguments are the integers 0 to 15. See also *SAV.

SAV Save current state*CMD**

Command: 1 argument, NRf.

Units: dimensionless.

Example: *SAV 0

Notes: Valid arguments are the integers 0 to 15. See also *RCL.

TRG Trigger*CMD**

Command: No arguments.

Example: *TRG

AUTOL Trigger auto level set**CMD**

Command: No arguments

Example: AUTOLEVEL

BASE Pulse base level**CMD+QRY+MOD_ID+CPLD**

Command: 1 argument, NRf.

Units: Volts.

Example: A:BASE 0.2

Query: No arguments.

Example: A:BASE?

Notes: With INVert OFF:

AMP is positive.

BASE is the same as VLO

BASE plus AMP is VHI.

MEDIAN is BASE plus 1/2 AMP

With INVert ON:

AMP is negative

BASE is the same as VHI

BASE plus AMP is VLO

MEDIAN is BASE plus 1/2 AMP

BC **Burst Count****CMD+QRY**

Command: 1 argument, NRf, 3..4095.

Units: Dimensionless (count).

Example: BC 2352

Query: No arguments.

Example: BC?

BRI **Brightness adjust****CMD+QRY**

Command: 1 argument, NRf, 1..16.

Units: dimensionless.

Example: BRIGHTNESS 12

Query: No arguments.

Example: BRI?

DBL Double Pulse**CMD+QRY+MOD_ID**

Command: 1 argument [OFF | ON]

Example: A:DBL ON

Query: No arguments.

Example: A:DBL?

DEL Pulse Delay**CMD+QRY+MOD_ID+CPLD**

Command: 1 argument, NRf.

Units: seconds.

Example: A:DEL 100n

Query: No arguments.

Example: A:DEL?

Notes: Delay is coupled with LEADing edge, WIDTH and PERIOD in NORMAL trigger mode. Delay is the time from trigger out to pulse out, not including a fixed offset, see Chapters 3 and 4.

DISA Disable output**CMD+QRY+MOD_ID**

Command: 1 argument, [OFF | ON]

Example: A:DISA OFF

Query: No argument.

Example: A:DISA?

Notes: Disables pulse (and complement, if any) outputs.

When Disable is ON, the outputs are turned off.

DISP Display enable**CMD+QRY**

Command: 1 argument, [OFF | ON]

Example: DISP OFF

Query: No arguments.

Example: DISP?

Notes: Maximum speed of response to GPIB commands is achieved with DISPlay OFF, however this is not usually significant. DISPlay OFF can only be issued over the GPIB. Once local control has been re-established, DISPlay ON can be issued locally.

DUTY **Duty cycle****CMD+QRY+MOD_ID**

Command: 1 argument, NRf.

Units: percent.

Example: A:DUTY 50

Query: No arguments.

Example: A:DUTY?

FREQ **Frequency****CMD+QRY+CPLD**

Command: 1 argument, NRf.

Units: Hertz.

Example: FREQ 30M

Query: No argument.

Example: FREQ?

Notes: Coupled to WIDTH, DELAY, LEADing edge time and TRAILing edge time in NORMAL trigger mode.

LIM **Enable vertical parameter limits** **CMD+QRY+MOD_ID**

Command: 1 argument, [OFF | ON]

Example: A:LIM ON

Query: No argument.

Example: A:LIM?

Notes: Limits are enforced when turned on, and at all subsequent changes of VHI, VLO (or AMPL, BASE, MEDIAN) or max or min limits. If any limit has been exceeded, the offending value is set to the limit and error 507, "VALUE LIMITED TO USER LIMIT" is placed in the error queue (or displayed, depending on whether the source of the command was GPIB or the front panel).

LVH **Set most positive voltage limit** **CMD+QRY+MOD_ID**

Command: 1 argument, NRf.

Units: Volts.

Example: A:LVH 3.6

Query: No argument.

Example: A:LVH?

Notes: Only has effect when limits are on; see LIM.

LVL **Set most negative voltage limit**

CMD+QRY+MOD_ID

Command: 1 argument, NRF.

Units: Volts.

Example: A:LVL 0.2

Query: No argument.

Example: A:LVL?

Notes: Only has effect when limits are on; see LIM.

LOADC **Load Compensate****CMD+QRY+MOD_ID+CPLD**

Command: 1 argument, [OFF | ON]

Example: A:LOADCOMP ON

Query: No arguments.

Example: A:LOADCOMP?

Notes: VHI and VLO set voltage into 50 Ω if LOADComp is off, or voltage into the actual (resistive) load if LOADComp is on. The range of load resistances for which LOADComp will function is from 47 Ω to 1M Ω . The compensation factor is calculated and saved when the command LOADC ON is received. If the load is subsequently changed, LOADComp must be turned ON again to measure the new load. If LOADComp is OFF, for a module with 50 Ω output impedance (such as the 9212), the actual output voltage will be:

$$2 \times \text{Requested output voltage} \times (\text{load} / (\text{load} + 50))$$

LOADComp measures the output voltages and compares them to the current settings. For this reason, LOADC ON should be the last <PROGRAM MESSAGE UNIT> in a <PROGRAM MESSAGE> containing commands which change the output voltage levels.

LOADComp is not applicable to modules with other than voltage outputs.

MED **Median voltage**

CMD+QRY+MOD_ID+CPLD

Command: 1 argument, NRf.

Units: Volts.

Example: A:MED 0

Query: No arguments.

Example: A:MED?

Note: MEDIAN is $(VHI + VLO)/2$, which is the same as $BASE + 1/2 AMP$.

OUT	Normal Output Enable	CMD+QRY+MOD_ID
OUTBar	Complementary Output Enable	CMD+QRY+MOD_ID

Command: 1 argument, [ON | OFF].

Example: A:OUT OFF

Query: No arguments.

Example: A:OUT?

Note: These commands interact with the DISAble command, which disconnects both outputs simultaneously. For example, the complementary output is only enabled when OUTB is ON and DISA is OFF.

At the time of this writing, this command is applicable only to the 9212 and 9214 Output Modules.

PER Period**CMD+QRY+CPLD**

Command: 1 argument, NRf.

Units: seconds.

Example: PER 33.3n

Query: no arguments.

Example: PER?

Notes: Coupled to WIDTH, DELAY and LEADing edge time in NORMAL trigger mode.

PHA Phase**CMD+QRY+MOD_ID+CPLD**

Command: 1 argument, NRf, 0 to <360.

Units: degrees.

Example: A:PHA 90

Query: no arguments.

Example: A:PHA?

Notes: When Phase has been set, Pulse Delay = Phase/360*Period. Phase is displayed and set with a resolution of 0.1_, and is therefore always settable to one part in 3600 of the Period. Phase is coupled with LEADing edge and WIDTH in NORMAL trigger mode. Phase does not include the fixed delay offset from the Trigger Output (see Chapters 3 and 4).

SCRNSAVE Screen Save**CMD+QRY**

Command: 1 argument, [OFF | ON]

Example: SCRNSAVE ON

Query: No arguments.

Example: SCRNSAVE?

Notes: If SCRNSAVE is on, the CRT will be dimmed to approximately BRIGHTNESS 1 after seven minutes of no front panel activity. Any front panel activity restores the BRIGHTNESS setting and resets the seven minute timer. SCRNSAVE OFF restores the normal BRIGHTNESS setting. When SCRNSAVE is set to OFF, the CRT is never dimmed.

SLEW_L Slew rate, leading edge**CMD+QRY+MOD_ID+CPLD**

Command: 1 argument, NRf.

Units: Volts/second.

Example: A:SLEW_L 1e6

Query: No arguments.

Example: A:SLEW_L?

Notes: Coupled to VHI and VLO (or AMP) and WIDTH; also to DELAY and PERIOD if NORMAL trigger mode.

This command is not applicable to the 9212 and 9214 Output Modules.

SLEW_T Slew rate, trailing edge

CMD+QRY+MOD_ID+CPLD

Command: 1 argument, NRf.

Units: Volts/second.

Example: A:SLEW_T 1e6

Query: No arguments.

Example: A:SLEW_T?

Notes: Coupled to VHI and VLO (or AMP); also to DELAY, WIDTH and PERIOD if NORMAL trigger mode.

This command is not applicable to the 9212 and 9214 Output Modules.

TEMPC Temperature Compensation**CMD+QRY**

Command: 1 argument [OFF | ON]

Example: TEMPCOMP OFF

Query: No arguments.

Example: TEMPC?

Notes: Setting TEMPC OFF disables the automatic application of temperature compensation corrections. We suggest that this should only be done after a self calibration has been performed after at least 15 minutes of warmup. While TEMPCOMP is ON, the 9210 periodically calculates a correction factor based on the temperature change since the last calibration; when the factor grows large enough it is applied. TEMPCOMP OFF is appropriate where sudden timing changes on the order of 0.03% (0.1% worst case) cannot be tolerated. Whether TEMPCOMP is on or off, changing any timing parameter (period, delay or width) will cause it to be set appropriately for the current temperature.

TOUCH Touch screen enable**CMD+QRY**

Command: 1 argument, [OFF | ON]

Example: TOUCH OFF

Query: No argument.

Example: TOUCH?

TRAIL **Trailing edge time** **CMD+QRY+MOD_ID+CPLD**

Command: 1 argument, NRf.

Units: seconds.

Example: A:TRAIL 100E-9

Query: no arguments.

Example: A:TRAIL?

Notes: Coupled to DELAY, LEAD, WIDTH and PERIOD if NORMAL trigger mode.

This command is not applicable to the 9214 Output Module.

TRIM **Trigger input Impedance** **CMD+QRY**

Command: 1 argument [HIGHZ | FIFTY]

Example: TRIM FIFTY;

Query: No arguments.

Example: TRIM?

TRLV Trigger Level**CMD+QRY**

Command: 1 argument, NRf.

Units: Volts.

Example: TRLV 0.5

Query: No arguments.

Example: TRLV?

TRMD Trigger Mode**CMD+QRY+CPLD**

Command: 1 argument [NORMAL | SINGLE | GATE | BURST | E_WID]

Example: TRMD SINGLE

Query: no arguments.

Example: TRMD?

Notes: TRMD is coupled to PERIOD / FREQUENCY and therefore to everything they are coupled to, since in NORMAL trigger DELAY plus LEADING edge plus WIDTH must be less than the PERIOD.

TROV **Trigger Output Voltage** **CMD+QRY**

Command: 1 argument, NRF.

Units: Volts.

Example: TROV 1

Query: No argument.

Example: TROV?

Notes: This specifies the quiescent voltage for trigger output, assuming a 50 Ω load to ground, and may be from -1.5 V to +1.5 V. The output will swing -1 Volt when trigger occurs. Voltages double into high impedance. See also TROV_SET.

TROV_SET **Set Trigger Output for TTL or ECL compatibility** **CMD**

Command: 1 argument, [ECL | TTL]

Example: TROV_SET TTL

Notes: TROV_SET TTL sets TROV to 1.24V, so levels are 2.48 V (inactive) and .48 V (active) into high impedance. TROV_SET ECL sets TROV to -.85 volts, so levels are -.85 V (inactive) and -1.85 V (active) into a 50 Ω load to ground. The proper load on the trigger output is required to achieve the desired logic levels.

TRSL **Trigger Slope****CMD+QRY**

Command: 1 argument. [POS | NEG | DISABLE]

Example: TRSL POS

Query: No arguments.

Example: TRSL?

VHI **Pulse high level****CMD+QRY+MOD_ID+CPLD**

Command: 1 argument, NRF.

Units: Volts.

Example: A:VHI 3.2

Query: No arguments.

Example: A:VHI?

Notes: Coupled to VLO, SLEW_L and SLEW_T.

VHI sets the voltage into 50 Ω if LOADComp is off, or voltage into the actual (resistive) load if LOADComp is turned on after VHI is set, or if LOADComp was previously invoked into the present load.

VLO **Pulse low level**

CMD+QRY+MOD_ID+CPLD

Command: 1 argument, NRf.

Units: Volts.

Example: A:VLO 0.2

Query: No arguments.

Example: A:VLO?

Notes: Coupled to VHI, SLEW_L and SLEW_T.

VLO sets the voltage into 50 Ω if LOADComp is off, or voltage into the actual (resistive) load if LOADComp is turned on after VLO is set, or if LOADComp was previously invoked into the present load.

***ESR Read Out the Standard Event Status Register QRY**

Query: No argument.

Example: *ESR?

***IDN Identification QRY**

Query: No arguments.

Example: *IDN?

Notes: The response to *IDN must have four fields separated by commas which are: 1) manufacturer; 2) model#; 3) serial# or 0; 4) firmware rev or 0. Each field may contain any ASCII character 0x20 through 0x7E except comma and semicolon.

Overall length must be less than or equal to 72 characters.

The response is sent as an <ARBITRARY ASCII RESPONSE DATA> element, i.e., not a quoted string. This type of element must be the last in a response message, as it must be followed by the response message terminator (line feed with EOI); therefore *IDN? should be the last query in the program message which contains it.

***LRN Learn device setup QRY**

Query: No arguments.

Example: *LRN?

Note: *LRN? returns one large PROGRAM MESSAGE which contains PROGRAM MESSAGE UNITS capable of returning the system to its current state.

***OPC Operation complete**

CMD+QRY

Command: No arguments.

Example: *OPC

Query: No arguments.

Example: *OPC?

Notes: The command causes the Operation Complete bit in the standard event status register to be set when all commands in the program message have been completed.

The query causes a "1" to be placed into the output queue when all commands in the program message have been completed.

OPT Option identification*QRY**

Query: No arguments.

Example: *OPT?

Notes: Returns an <ARBITRARY ASCII RESPONSE DATA> element, therefore, *OPT? should be the last query in the program message which contains it. See the note for *IDN for further explanation.

The 9210's response to *OPT is five fields showing the module type and revision level for the installed modules, and a code for any installed mainframe options. As of this writing, there are no reportable mainframe options so the code will always be zero.

An example of *OPT? response could be:

MODULE A 9211, REV 1, MODULE B 9211, REV 1, MAINFRAME OPTIONS 0

RST Reset*CMD**

Command: No arguments.

Example: *RST

Note: *RST is equivalent to *RCL of a predefined state, plus it cancels *OPC command and query.

***SRE Service Request Enable**

CMD+QRY

Command: 1 argument, NRf, 0..255 .

Units: dimensionless.

Example: *SRE 160

Query: No argument.

Example: *SRE?

Notes: Bit 6 does not need an enable; the query always returns a value as if bit 6 is zero.
For example, "*SRE 255; *SRE?" would return 191.

***STB Read out the status byte**

QRY

Query: No argument.

Example: *STB?

Note: Bit 6 in this byte is the "Master Status Summary" from the time the status byte was created. It is not cleared by serial poll. This differs from bit 6 as read by serial poll, which is cleared by the serial poll.

***WAI** **Wait for pending operations**

CMD

Command: No arguments.

Example: *WAI

Note: The implementation of *WAI is mandatory according to IEEE 488.2. However, when a device implements sequential commands only, as is the case with the 9210, the command has no operational meaning.

CHDR **Enable Command Header with Query response**

CMD+QRY

Command: 1 argument, [OFF | ON | SHORT | LONG]

Example: CHDR OFF

Query: No argument.

Example: CHDR?

Notes: The arguments ON, SHORT and LONG are equivalent. SHORT and LONG are present for compatibility with other LeCroy instruments.

The intent of CHDR is to return query responses which are valid commands and easily readable. For example, with CHDR off, the TRMD? query might return SINGLE. With CHDR on, the same query would return TRMD SINGLE.

ERR Read out the next error queue entry QRY

Query: No argument.

Example: ERR?

Notes: The query returns a numeric error code (as an <NR1 NUMERIC RESPONSE DATA> element) and a quoted string (a <STRING RESPONSE DATA> element) with a brief description of the error. For example, ERR? might return:
121, "INVALID CHAR IN NUMBER".

The error queue can hold 31 entries. If 31 errors occur, the last entry will be 350, "TOO MANY EVENTS". See the list of possible errors in Appendix E.

MSG Display a message CMD

Command: 1 argument, a quoted string.

Notes: The message is displayed in large text as up to ten lines of up to eighteen characters each. Linefeed may be embedded in the string to advance to the next line, otherwise each line is filled to eighteen characters. The string may be delimited by single or double quotes; the other type may be used within the string. Whichever is used as the delimiter, if it occurs twice in succession it is interpreted as occurring once in the string. For example: MSG "He said ""She said 'Hi'"" shows: He said "She said 'Hi'".

TER Read TST/CAL Error Register**QRY**

Query: One argument, NRf.

Units: dimensionless.

Example: TER? 3

Notes: The argument is a number from 0 to 15. The response is a number to be interpreted as a 32 bit integer. Each integer provides more detailed information for one of the 16 bits in the response of *CAL? or *TST?. For example, if *CAL? returned 8, then TER? 3 will return a value with more information on why calibration failed. Each bit in the response of *CAL? or *TST may be thought of as a summary bit for one of the 32 bit registers read out by TER?

LeCroy 9210 300 MHz Programmable Pulse Generator Mainframe

IMPORTANT NOTE: *At least one Output Module (9211, 9212, 9213, or 9214) must be installed in the 9210 Pulse Generator Mainframe in order to obtain a pulse output.*

TIMING CHARACTERISTICS: Defined at 50% amplitude points and minimum transition times.

NOTE: *The minimum values listed below refer to the mainframe only, and may not be achievable with all output modules.*

Pulse Period: 3.33 nsec to 450 msec

Resolution: the greater of 0.1% of value or 10 psec

Accuracy: \pm (0.5% of value + 0.2 nsec) from 3.33 nsec to 450 msec

RMS Jitter: \leq 0.035% (350 ppm) of value + 35 psec

Temperature Coefficient: <250 ppm/°C typ. with Temperature Compensation ON

Frequency: Alternate format for Period. Settable from 300 MHz to 2.2 Hz with 0.1% resolution.

Pulse Width: 1.0 nsec to 450 msec

For Width setting \leq 7.2 nsec, max Width = Period - 0.75 nsec

For Width setting > 7.2 nsec, max Width = Period - 2.85 nsec

Resolution: the greater of 0.1% of value or 10 psec

Accuracy: \pm (0.5% of value + 0.3 nsec) from 1.6 nsec to 450 msec

RMS Jitter: \leq 0.035% of value + 35 psec

Temperature Coefficient: <250 ppm/°C typ. with Temperature Compensation ON

TIMING CHARACTERISTICS (continued):

Duty Cycle:	Alternate format for Width. Settable from 1% to 99% in 0.01% steps. In this format, Width is controlled as a percentage of Period
<u>Pulse Delay:</u>	0 nsec to 450 msec measured from the leading edge of Trigger Out to <u>beginning</u> of leading edge of Pulse Output (relative to fixed offset) For Period setting ≤ 8.0 nsec: max Delay = Period - 2.6 nsec For Period setting > 8.0 nsec: max Delay = Period - 4.7 nsec
Resolution:	the greater of 0.1% of value or 10 psec
Accuracy:	$\pm(0.5\%$ of value + 1.0 nsec)
RMS Jitter:	$\leq 0.035\%$ of value + 35 psec
Temperature Coefficient:	$<(250$ ppm + 50 psec)/ $^{\circ}\text{C}$ typ. with Temp. Comp. ON
Match Between Output Modules of the same type: 1.2 nsec	
Phase:	Alternate format for delay. Settable from 0° to 359.9° with 0.1° resolution. In this format, Delay = Phase/360 x Period
<u>Double Pulse Delay:</u>	4 nsec to 450 msec
Resolution:	the greater of 0.1% of value or 10 psec
Accuracy:	$\pm (0.5\%$ of value + 0.3 nsec)
RMS Jitter:	$\leq 0.035\%$ of value + 35 psec
Temperature Coefficient:	<250 ppm/ $^{\circ}\text{C}$ typ. with Temperature Compensation ON

INPUTS AND OUTPUTS:**External Input:**

Input Impedance:	10 k Ω or 50 Ω \pm 5%, selectable
Input Range:	\pm 5 V into 50 Ω or \pm 20 V into 10 k Ω
Min. Detectable Amplitude:	200 mV
Threshold Range and Resolution:	\pm 2.5 V adjustable in 20 mV steps
Threshold Level Accuracy:	\pm 100 mV
Max. Input Frequency:	300 MHz
Min. Pulse Width:	1.5 nsec
Min. Input Slew Rate	10 V/sec
Edge Selection:	Positive, Negative, neither edge (disabled).

Trigger Output:

Output Levels:	Nominal 1 V negative swing from base level into 50 Ω . Base level adjustable over \pm 1.5 V range with 20 mV resolution. (Into Hi Z: Amplitude = -2 V. Base level of \pm 3 V, 40 mV resolution)
Output Impedance:	50 Ω \pm 5%
Protection:	Protected against application of \pm 10 V.
Delay from Trigger Input:	21 nsec typ.
Width:	Dependent on Trigger Mode
Normal Mode:	Period \leq 7.2 nsec: Width = 1.8 nsec typ. 7.2 nsec < Period < 50 nsec: 3.6 nsec \leq Width \leq 7.2 nsec Period \geq 50 nsec: Width = 25 nsec typ.
Single Mode:	Pulse Width setting \leq 40 nsec: Trigger Output Width = 1.8 nsec typ. Pulse Width setting > 40 nsec: Trigger Output Width = 25 nsec typ.
Burst Mode:	Width = Period x (Burst Count - 1)

INPUTS AND OUTPUTS (continued):**Gate and External****Width Modes:**Trigger Output Width \approx Trigger Input Width

PROGRAMMABILITY: All generator functions are programmable over GPIB.
Command set conforms with IEEE 488.2-1987

TRIGGERING MODES:

- Normal:** Continuous pulse stream. Trigger output for each pulse output.
- Single:** Each external trigger input generates a single output pulse. One Trigger output for each trigger.
- Gated:** Signal at external input enables period generator. The first output pulse is synchronized with the gate's leading edge. Last pulse is allowed to complete. One Trigger output for each Gate input. 20 nsec retrigger (dead) time between Gate inputs
- Burst:** Each external trigger input generates a pre-programmed number of pulses (3 to 4095). Minimum time between two bursts is 50 nsec. One Trigger output for each trigger.
- External Width:** The signal at the external input is reproduced with programmable transition times and output levels. Trigger Output for each external trigger.

OPERATING FEATURES:

- Manual Trigger:** Front panel pushbutton generates an external trigger input. Each push provides one trigger pulse in Single and Burst Modes. Output remains active as long as button is pressed in Gate and External Width Modes.

Double Pulse Mode: When double pulse is set to ON, two pulses are produced for each trigger. The first pulse begins as soon as possible after the trigger (approximately the minimum Pulse Delay time). The Delay parameter now specifies the time from the leading edge of the first pulse to the leading edge of the second pulse. One Trigger Output occurs for each pulse pair. Compatible with all Trigger Modes except External Width.

ADDITIONAL CAPABILITIES:

Limit: When enabled, the maximum high and low level settability of the pulse outputs is limited to protect the device under test.

Setups: 16 setup configurations can be stored and recalled using the Store and Recall keys on the front panel.

Change Format: Enables the alternate representation of a parameter or enables an alternate mode of operation. Examples are Amplitude/Base or Amplitude/Median in lieu of VHigh/Vlow, Duty Cycle instead of Width, Phase instead of Delay, Frequency instead of Period, Slew Rate as opposed to Transition Time.

ENVIRONMENTAL: *The following specifications apply to the 9210 mainframe and to output modules (9211, 9212, 9213, and 9214).*

Storage Temperature: -40°C to 70°C (temp above 40°C may degrade battery life)

Operating Temperature: 5°C to 40°C at rated specifications, operational from 0°C to 50°C

Temperature & Self-Calibration: Generator and Output Modules will meet specifications over a $\pm 5^\circ\text{C}$ range without repeating Self-Calibration

Humidity Range: < 95% R.H. from 5°C to 40°C

POWER: 115/220 VAC \pm 20%; 48 - 448 Hz.
300 Watts Max. (180 typ)

MISCELLANEOUS:

Battery Backup Life: 10 years typ.

The following specifications apply to the 9210 mainframe and to output modules (9211, 9212, 9213 and 9214).

Recalibration Interval: 1 year
Warmup Time (to meet specs): 15 min, after which a new Self-Calibration must be performed.

9210 Mainframe:

Weight: 23 lbs. net
34 lbs. shipping

Dimensions: Height: 5"
Width: 17"
Depth: 21"

Output Modules:

Weight: 2 lbs. net
4 lbs. shipping

Dimensions: Height: 4.6"
Width: 2.4"
Depth: 14.7"

OPTIONS:

9210/SM Service Manual

9210/RM Rack Mount Kit

LeCroy 9211 250 MHz, Variable Edge Output Module**TIMING CHARACTERISTICS:**

Maximum Rep Rate:	≥ 250 MHz
Minimum Pulse Width:	≤ 2.0 nsec
Fixed Delay from Trigger Out:	13 nsec \pm 4 nsec

OUTPUT CHARACTERISTICS: Specified with both outputs terminated in 50.00 Ω (Ratings in { } are when driving an open circuit.)

Outputs:	Normal and Complementary Polarity
Short Circuit Output Current:	± 260 mA
DC Output Source Impedance:	50 \pm 1 Ω
Output Protection:	Protected against application of $\leq \pm 15$ V

OUTPUT LEVELS:

High Level	-4.95 V to + 5.00 V { -9.90V to +10.00 V }
Low Level	-5.00 V to + 4.95 V { -10.00 to +9.90 V }

Output Voltage Range:	± 5 Volts { ± 10 Volts }
	Maximum amplitude of 5 V { 10 V }
	Minimum amplitude of 50 mV { 100 mV }

Resolution:	5 mV { 10 mV }
--------------------	----------------

Level Accuracy:

Normal Output:	$\pm(1\%$ of Programmed Value + 1% of Amplitude + 40 mV) into 50.00 Ω
-----------------------	--

OUTPUT LEVELS (continued):**Level Accuracy (continued):**

Accuracy with Load Comp: The same accuracy as stated above will be maintained for user supplied load of 47Ω to $1 \text{ M}\Omega$ when load compensation feature is enabled.

Complementary Output:

$\pm(1\%$ of Programmed Value + 3% of Amplitude + 40 mV) into 50.00Ω

Accuracy with Load Comp:

$\pm(3\%$ of setting times the ratio of the load on the complemented output to the load on the normal output).
Measurements for the load compensating correction factors are made on the normal output.

PULSE PERFORMANCE:**Variable Transition Times** (10% to 90%):**Leading Edge:**

$\leq 1.2 \text{ nsec}$ minimum (1 nsec typ) to 10 msec

Trailing Edge:

$\leq 1.2 \text{ nsec}$ minimum (1 nsec typ) to 10 msec

Ranges:

7 ranges of 25:1, Minimum lead to trail dynamic range = 2.5:1, except 2:1 at first range break (see graph, below).

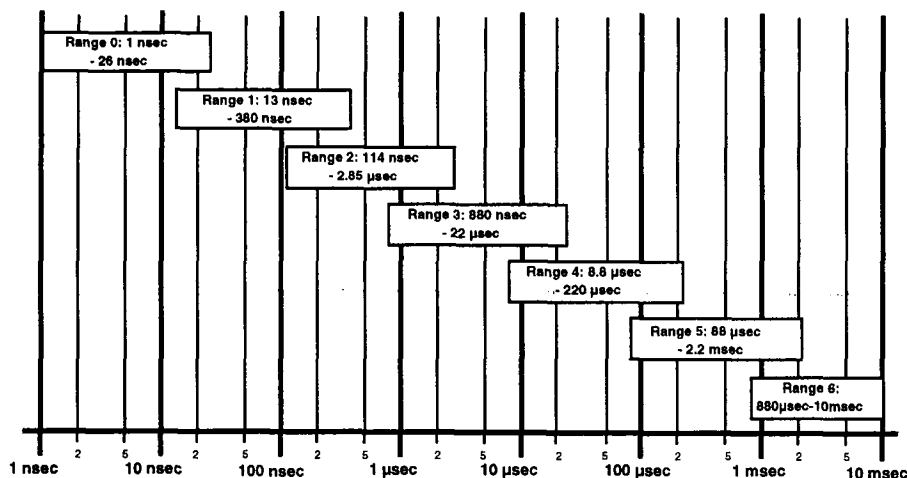

9211 Transition Time Ranges

PULSE PERFORMANCE (continued):**Variable Transition Times (continued):**

Resolution: the greater of 1% or 100 psec
Accuracy: $\pm(10\%$ of value + 300 psec)
Linearity: $\pm 3\%$ typ. (10-90%) for transition times > 50 nsec

Slew Rate mode: Settable down to 0.1 V/msec with 0.1% resolution and $\pm 10\%$ accuracy (separately settable for leading and trailing edge) Max. rate determined by amplitude setting & transition time limits stated above.

Overshoot and Ringing: the greater of $\pm 8\%$ of amplitude or ± 10 mV
Settling Time: ≤ 10 ns to 2% of amplitude change at fastest transition times

Normal to Complementary Output Skew: 200 psec max

MODULE CONTROLS:

The following controls are located on the front panel of the output module.

Invert:

Inverts normal output pulse levels. Quiescent and active levels exchanged.

Disable:

Output circuitry is disconnected via relay.

Display Channel:

Instructs mainframe to select and display all of the parameter settings for this module.

LeCroy 9212 300 MHz, 300 psec, Variable Edge Output Module**TIMING CHARACTERISTICS:**

Maximum Rep Rate:	≥ 300 MHz
Minimum Pulse Width:	≤ 1.2 nsec
Fixed Delay from Trigger Out:	13 nsec \pm 4 nsec

OUTPUT CHARACTERISTICS:

Specified with both outputs terminated in 50.00 Ω . (Ratings in { } are when driving an open circuit.)

Outputs:	Normal and Complementary Polarity
Short Circuit Output Current:	± 240 mA
DC Output Source Impedance:	50 \pm 1.0 Ω
Output Protection:	Protected against application of $< \pm 6$ V

OUTPUT LEVELS:

High Level:	-4.50 V to + 5.00 V {-4.00 V to + 5.00 V}
Low Level:	-5.00 V to + 4.50 V {-5.00 V to + 4.00 V}
Output Voltage Range:	± 5 Volts { ± 5 Volts} (Amplitude will double into a high impedance up to the 5 V limit). Max. amplitude of 5 V {10 V}. Min. amplitude of 500 mV {1 V}
Resolution:	5 mV {10 mV}

Level Accuracy:

Normal Output:	(1% of Programmed Value + 1% of Amplitude + 40 mV) into 50.00 Ω
-----------------------	--

Accuracy with Load Comp:	The same accuracy as stated above will be maintained for user supplied load of 47 Ω to 1 M Ω when load compensation feature is enabled.
---------------------------------	---

OUTPUT LEVELS (continued):**Level Accuracy (continued):**

Complementary Output: $\pm(1\%$ of Programmed Value + 3% of Amplitude + 40 mV) into 50.00 Ω

Accuracy with Load Comp: $\pm(3\%$ of setting times the ratio of the load on the complemented output to the load on the normal output).
Measurements for the load compensating correction factors are made on the normal output.

PULSE PERFORMANCE:

Minimum Transition Time: ≤ 300 psec guaranteed (20% to 80%) @ Lead/Trail set to 250 psec

Maximum Transition Time:	Transition Time	
	Amplitude	(@ Lead/Trail set to 1 nsec)
	0.50 V	≥ 450 psec
	0.75 V	≥ 540 psec
	1.00 V	≥ 580 psec
	2.00 V	≥ 675 psec
	3.00 V	≥ 720 psec
	4.00 V	≥ 745 psec
	5.00 V	≥ 750 psec

Transition Time Accuracy: $\pm(20\%$ of value + 300 psec), for values less than the maximum (see below)

Transition Time Symmetry: $|t_{\text{lead}} - t_{\text{trail}}| < 20\%$ of value ± 300 psec

Transition Time Resolution: 50 psec steps, worst case (at the module output)

Transition Time Repeatability: ± 100 psec (for identical module setup)

PULSE PERFORMANCE (continued):**Transition Time Variability:**

The 9212 has adjustable edge transition rates from 300 psec to about 1 nsec. Leading and Trailing edges are adjusted in common. The graph below describes the adjustability ranges for given amplitudes.

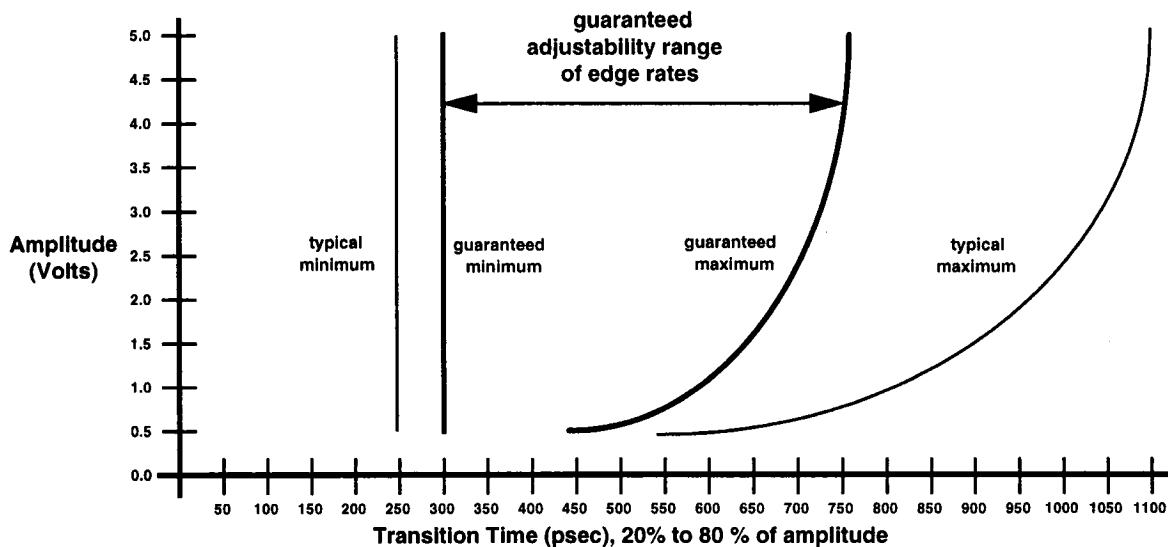
**Overshoot and Ringing:**

the greater of $\pm 10\%$ of amplitude or ± 10 mV

Settling Time:

≤ 10 nsec to 2% of amplitude change at fastest transition time.

Normal to Complemented Output Skew:

100 psec max at fastest transition time. (25 psec typ)

MODULE CONTROLS:

These controls are located on the front panel of the output module.

Invert:

Inverts normal output pulse levels. Quiescent and active levels exchanged.

Disable:

Output circuitry is disconnected via relay.

Display Channel:

Instructs mainframe to select and display the settings parameters for this module.

LeCroy 9213 50 MHz, 16V Amplitude Output Module**TIMING CHARACTERISTICS:**

Maximum Rep Rate:	≥50 MHz
Minimum Pulse Width:	≤10.0 nsec
Fixed Delay from Trigger Out:	13 nsec ± 4 nsec

OUTPUT CHARACTERISTICS: Specified with output terminated in 50.00 Ω.
(Ratings in { } are when driving an open circuit.)

Output:	Normal Polarity
Short Circuit Output Current:	±200 mA
DC Output Source Impedance:	50 ± 2.0Ω
Output Protection:	Protected against application of ≤±40 V

OUTPUT LEVELS:

High Level:	-7.98 V to +8.00 V {-15.96 V to +16.00 V}
Low Level:	-8.00 V to +7.96 V {-16.00 V to +15.96 V}
Output Voltage Range:	±8 Volts {±16 Volts}; Maximum Amplitude of 16 V {32 V}; Minimum Amplitude of 20 mV {40 mV}
Resolution:	5 mV {10 mV}
Level Accuracy:	±(1% of Programmed Value + 1% of Amplitude + 40 mV) into 50.00 Ω

Accuracy with Load Comp:

The same accuracy as stated above will be maintained for user supplied load of $47\ \Omega$ to $1\ M\Omega$ when load compensation feature is enabled.

PULSE PERFORMANCE:**Variable Transition Times** (10% to 90%):

Leading Edge: $\leq 6.5\ \text{nsec}$ to $95\ \text{msec}$

Trailing Edge: $\leq 6.5\ \text{nsec}$ to $95\ \text{msec}$

Ranges: 8 ranges of 25:1, Min. lead to trail dynamic range = 2.5:1, (except for lowest range, see graph below)

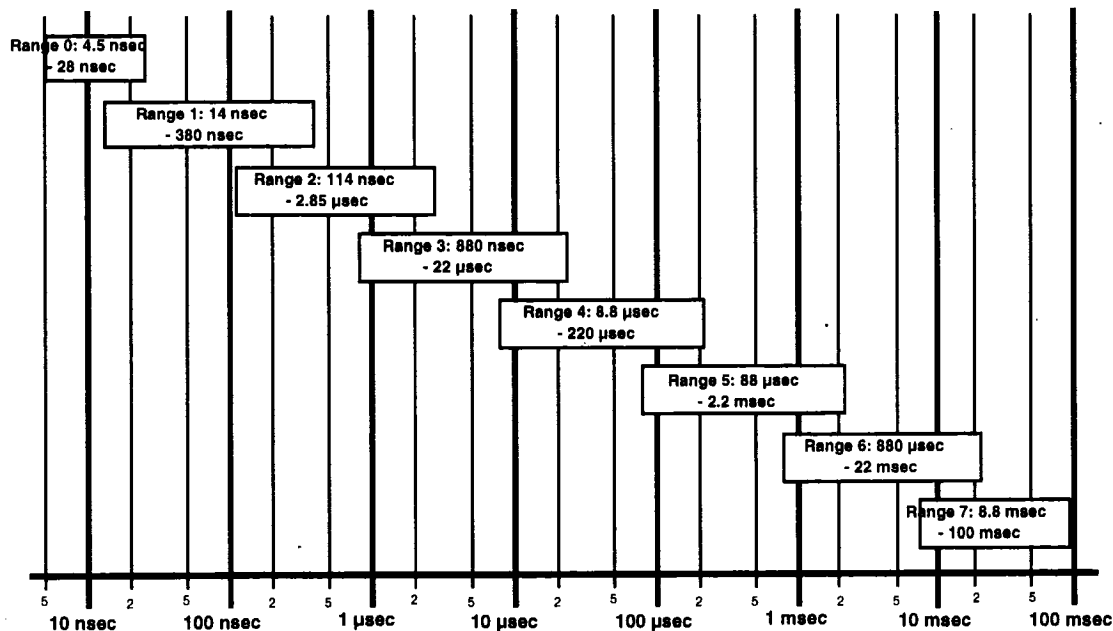

9213 Transition Time Ranges

PULSE PERFORMANCE (continued):**Variable Transition Times** (continued):

Resolution:	the greater of 1% or 100 psec
Accuracy:	$\pm(8\%$ of value, + 0.5 nsec)
Linearity:	$\pm 3\%$ typ. (10-90%) for transition times > 100 nsec
Slew Rate mode:	Settable down to 0.1 V/msec with 0.1% resolution and $\pm 8\%$ accuracy (separately settable for leading and trailing edge) Max. rate determined by amplitude setting & transition time limits stated above.
Overshoot and Ringing:	the greater of $\pm 8\%$ of amplitude or ± 10 mV
Settling Time:	≤ 50 nsec to 2% of amplitude change for amplitudes ≤ 10 V or to 3% of amplitude change for amplitudes > 10 V (at fastest transition times).
MODULE CONTROLS:	The following controls are located on the front panel of the output module.
Invert:	Inverts normal output pulse levels. Quiescent and active levels exchanged.
Disable:	Output circuitry is disconnected via relay.
Display Channel:	Instructs mainframe to select and display the settings parameters for this module.

LeCroy 9214 300 MHz, 300 psec, Fixed Edge Output Module**TIMING CHARACTERISTICS:**

Maximum Rep Rate: ≥ 300 MHz
Minimum Pulse Width: ≤ 1.2 nsec
Fixed Delay from Trigger Out: $13 \text{ nsec} \pm 4 \text{ nsec}$

OUTPUT CHARACTERISTICS: Specified with both outputs terminated in 50.00Ω . (Ratings in { } are when driving an open circuit.)

Outputs: Normal and Complementary Polarity
Short Circuit Output Current: ± 240 mA
DC Output Source Impedance: $50 \pm 1.0 \Omega$
Output Protection: Protected against application of $< \pm 6$ V

OUTPUT LEVELS:

High Level: $-4.50 \text{ V to } + 5.00 \text{ V}$ { $-4.00 \text{ V to } + 5.00 \text{ V}$ }
Low Level: $-5.00 \text{ V to } + 4.50 \text{ V}$ { $-5.00 \text{ V to } + 4.00 \text{ V}$ }
Output Voltage Range: ± 5 Volts { ± 5 Volts } (Amplitude will double into a high impedance up to the 5 V limit).
Max. amplitude of 5 V { 10 V }.
Min. amplitude of 500 mV { 1 V }
Resolution: 5 mV { 10 mV }

Level Accuracy:

Normal Output: (1% of Programmed Value + 1% of Amplitude + 40 mV) into 50.00Ω

Accuracy with Load Comp: The same accuracy as stated above will be maintained for user supplied load of 47Ω to $1 \text{ M}\Omega$ when load compensation feature is enabled.

OUTPUT LEVELS (continued):**Level Accuracy (continued):**

Complementary Output: $\pm(1\%$ of Programmed Value + 3% of Amplitude + 40 mV) into 50.00 Ω

Accuracy with Load Comp: $\pm(3\%$ of setting times the ratio of the load on the complemented output to the load on the normal output).
Measurements for the load compensating correction factors are made on the normal output.

PULSE PERFORMANCE:

Transition Time: ≤ 300 psec guaranteed (20% to 80%)

Overshoot and Ringing: the greater of $\pm 10\%$ of amplitude or ± 10 mV

Settling Time: ≤ 10 nsec to 2% of amplitude change.

Normal to Complemented Output Skew: 100 psec max. (25 psec typ.)

MODULE CONTROLS: These controls are located on the front panel of the output module.

Invert: Inverts normal output pulse levels. Quiescent and active levels exchanged.

Disable: Output circuitry is disconnected via relay.

Display Channel: Instructs mainframe to select and display the settings parameters for this module.

Unpacking and Inspection

LeCroy recommends that the shipment be thoroughly inspected immediately upon delivery. All material in the container(s) should be checked against the enclosed Packing List and shortages reported to the carrier promptly. If the shipment is damaged in any way, please notify the carrier. If the damage is due to mishandling during shipment, you must file a damage claim with the carrier. The LeCroy field service office can help with this. LeCroy tests all products before shipping and packages all products in containers designed to protect against reasonable shock and vibration.

Warranty

LeCroy warrants the Models 9210, 9211, 9212, 9213 and 9214 to operate within specification under normal use and service for a period of 5 years from the date of shipment. Replacement parts, and repairs are warranted for "duration of the original warranty or one (1) year, whichever is longer". This warranty extends only to the original purchaser. Longer warranty periods are available.

In exercising this warranty, LeCroy will repair or, at its option, replace any product returned to the Customer Service Department or an authorized service facility within the warranty period, provided that LeCroy's examination discloses that the product is defective due to workmanship or materials and has not been caused by misuse, neglect, accident or abnormal conditions or operations.

The purchaser is responsible for the transportation and insurance charges arising from the return of products to the servicing facility. LeCroy will return all in-warranty products with transportation prepaid.

This warranty is in lieu of all other warranties, express or implied, including but not limited to any implied warranty of merchantability, fitness, or adequacy for any particular purpose or use. LeCroy shall not be liable for any special, incidental, or consequential damages, whether in contract, or otherwise.

Calibration

Although LeCroy warrants the 9210, 9211, 9212, 9213 and 9214 to meet specification for five (5) years with no adjustment, it is recommended that the user have the generator and modules calibrated once each year. If adjustments are necessary, they will be made at no charge.

**Documentation
Discrepancies**

LeCroy is committed to providing state-of-the-art instrumentation and is continually refining and improving the performance of its products. While physical modifications can be implemented quite rapidly, the corrected documentation frequently requires more time to produce. Consequently, this manual may not agree in every detail with the accompanying product. Where any such inconsistencies exist, please be assured that the unit you have received contains the most up-to-date features.

We will make every effort to update documentation as often as possible. If you feel that your version is outdated, call (914) 578-6020.

**Service and
Procedures**

Products requiring maintenance should be returned to an authorized service facility. Under warranty, LeCroy will repair or replace the product at no charge. The purchaser is only responsible for the transportation charges arising from return of the goods to the service facility.

For all LeCroy products in need of repair after the warranty period, the customer must provide a Purchase Order Number before any inoperative equipment can be repaired or replaced. The customer will be billed for the parts and labor for the repair as well as for shipping.

All products returned for repair should be identified by the model and serial numbers and include a description of the defect or failure, name and phone number of the user. In the case of products returned, a Return Authorization Number is required and may be obtained by contacting the Customer Service Department at 914-578-6020. Outside the U. S. A., call your local LeCroy Sales Office or Representative.

REQUIRED DEVICE DOCUMENTATION FOR IEEE 488.2-1987 (GPIB)

General Information

The 9210's GPIB interface is IEEE 488.2-1987 compatible. Section 4.9 of IEEE 488.2-1987 contains a list of device documentation requirements. This section contains required device documentation not covered elsewhere in the manual. For items which are covered elsewhere, the appropriate section of this manual is referenced.

GPIB Interface Function Subsets

1) The 9210 implements the following 488.2 Interface Function subsets:

- SH1 - Source handshake complete capability
- AH1 - Acceptor handshake complete capability
- T6 - Basic talker, Serial poll, unaddress if MLA, no Talk Only
- L3 - Basic listener, Unaddress is MTA, Listen ONLY mode
- SR1 - Service request complete capability
- RL1 - Remote/Local complete capability
- PP0 - No parallel poll capability
- DC1 - Device Clear (and Selected Device Clear) complete capability
- DT1 - Device Trigger complete capability
- C0 - No controller capability
- E2 - Tri-state lines (except SRQ, NRFD, NDAC)

Addressing Information

- 2) It is not possible to set the device's address outside the range of 0 to 30. An attempt to do so causes an error message to be displayed, indicating that the requested value is out of range, and the address is not changed.
- 3) A user initiated address change is recognized immediately.

Restoration of Settings

- 4) The 9210's device settings at power on are restored to the values they had when the 9210 was powered off. (Note that "device settings" is a standard-defined term. Other items, such as the status data structures and enable registers, are cleared at power on.)

Commands and Queries

- 5) a) The input buffer is 257 bytes, the last byte of which is inside a commercial integrated circuit which implements IEEE 488.1. The input buffer cannot overflow. If the input buffer becomes filled, one byte is accepted as each byte is removed from the input buffer by the 9210's parser.
- b) The only query returning more than one <RESPONSE MESSAGE UNIT> is "ERR?". Query responses are further documented in Chapter 6 (Remote Operations) and Chapter 7 (GPIB Commands) of this manual.
- c) All queries generate a response when parsed.
- d) No queries generate a response when read.

e) The following commands are "coupled" to at least one other command:

AMP	Pulse Amplitude
BASE	Pulse quiescent level
DEL	Pulse Delay
FREQ	Frequency
LEAD	Leading edge time
LOADComp	Load Compensate
MED	Pulse median amplitude (BASE + AMP/2)
PHA	Phase
PER	Period
SLEW_Lead	Slew rate, leading edge
SLEW_Trail	Slew rate, trailing edge
TRAIL	Trailing edge time
TRMD	Trigger Mode
WID	Pulse Width
VHI	Pulse high level
VLO	Pulse low level

The effect of "coupled" commands is described in Chapter 7 of this manual (GPIB Commands). All other commands are also documented in Chapter 7

Device Specific Commands

- 6) The 9210's device specific commands can be built using all functional elements defined in IEEE 488.2-1987 section 7.3.3 except **<EXPRESSION PROGRAM DATA>**. It is never necessary to use **<NON-DECIMAL NUMERIC PROGRAM DATA>**. (Commands that accept **<DECIMAL NUMERIC PROGRAM DATA>** will also accept **<NON-DECIMAL NUMERIC PROGRAM DATA>** - time in picoseconds, volts in microvolts, dimensionless values in units). **<ARBITRARY BLOCK PROGRAM DATA>** elements, although accepted by the parser, are not used in any of the 9210's commands and will therefore generate a command error.

Data Elements

<compound command program header> elements are used. From a syntactic point of view, all commands have compound headers: they can all accept the optional leading ":". More information on the 9210's use of **<compound command program header>** elements is found in the section entitled "Header Compounding" in Chapter 6 of this manual (Remote Operations).

- 7) The size of a block data element is limited by the size of the parser's buffer. The **<PROGRAM MESSAGE UNIT>** which contains the block data element must fit entirely within the parser's 300 byte buffer.

NOTE: At the moment no 9210 command uses **<ARBITRARY BLOCK PROGRAM DATA>** elements.

- 8) **<EXPRESSION PROGRAM DATA>** elements are not supported.

Query Response

- 9) The response syntax for every query is specified in Chapter 7 of this manual (GPIB Commands).
- 10) The 9210 does not send any message which does not comply with the rules for **<RESPONSE MESSAGE>** elements.
- 11) The 9210 does not produce any block data responses.

Implemented Commands and Queries

- 12) The following IEEE 488.2 common commands and queries are implemented:

***CAL? *CLS *ESE *ESE? *ESR? *IDN?
*LRN? *OPC *OPC? *OPT? *RCL *RST
*SAV *SRE *SRE? *STB? *TRG *TST?
*WAI**

This list includes fourteen mandatory commands and five optional commands. Further information on these commands can be found in Chapter 7 of this manual (GPIB Commands).

State After Calibration

- 13) After calibration, the 9210 is automatically returned to its state before calibration.

Identification Response

- 16) The response to *IDN is an <ARBITRARY ASCII RESPONSE DATA> element (an unquoted string) as specified by IEEE 488.2. It is of the form:

LECROY,9210,0,1.2:910322

The first field is the manufacturer. The second field is the model number. The third field is the serial number or 0 if not available. The fourth field is Firmware level or equivalent.

Reset, Save, Recall and Learn

- 19) The states affected by *RST, *SAV, *RCL and *LRN? are:

Mainframe: Period, frequency, trigger mode, trigger level, trigger slope, trigger input impedance, burst count, trigger output level

For each module: width, duty cycle, delay, phase, vhigh, vlow, amplitude, base, median, lead, trail, slew_lead, slew_trail, double pulse, invert, disable, load compensation, limit, voltage max limit, voltage min limit, and the normal and complementary output enables, if applicable.

In addition to the above, the display format is affected. The display format selects the following: Vhigh and Vlow or amplitude and base or amplitude and median, period or frequency, width or duty cycle, delay or phase, lead and trail or slew lead and slew trail.

NOTE: Some module dependent parameters may not be controllable on all modules. If a module is installed where some parameters cannot be controlled, those parameters which cannot be controlled are not saved by *SAV, not reported by *LRN?, and are not affected by *RCL or *RST.

Selftest

20) The scope of selftest performed by *TST is as follows:

CALIBRATION

Top level procedure:

CAL_ADC:

Purpose: Check ADC functionality. Note: not really a calibration.

Procedure: take 10 readings at ground, and nominal 2.5V from resistive voltage divider.

Error bit: Bit 0 (value 1) set in *CAL? answer if error
Details (Error codes in cal msg and TER? 0):

1: More than 10 code spread from max to min reading at one voltage.

2: Out of limit: Ground > 1 code, or 2.5V > 2150 or < 1945 (+/- 5% of 2048)

Displayed message: Either "Cal ADC... Passed" or "Cal ADC... Failed," followed by the numeric code shown in "details" above, followed by a line showing the sum of the ten readings of 2.5V (should be approximately 20480) and the sum of the ten readings for Ground (should be approximately 0).

TEST_FCNT:

Purpose: Check frequency counter functionality

Procedure: Count 16 MHz clock (through TDC start MUX) for 3 msec gate, 10 times.

Error bit: Bit 1 (value 2) set in *CAL? answer if error

Details (Error codes shown in cal msg and TER? 1):

- 1: Failed. Gate end interrupt did not occur within a reasonable number of milliseconds.
- 2: Excessive spread: max reading - min reading greater than 10 counts.
- 4: Out of limit: Average reading was not between 47992 and 48008. These limits were chosen to account for 400 nsec gate error plus one count.

CAL_TDC:

Purpose: find code for 0 time (pedestal) and fsec per code for fast TDC.

Note: fast TDC is time to voltage converter, then the 12 bit ADC.

Procedure: Using the 16 MHz reference clock as start and stop, sum 1000 readings of 1 cycle time (use second stop = on), then sum 250 readings of pedestal reading, i.e., start and stop on same edge - multiply by four to scale as if 1000 readings. Save pedestal code * 1000, and tdc_fs_per_code = (sum of 1 cycle - (pedestal * 1000)) / 62500000.

Error bit: Bit 2 (value 4) set in *CAL? answer if error.

Details (Error codes in cal msg and TER? 2):

- 1: Failed. TDC STOPPED interrupt did not occur within a reasonable number of milliseconds.
- 2: Excessive spread: >64 codes spread on pedestal readings, or >220 codes spread on 62.5 nsec readings.
- 4: Out of limit: Pedestal limits are 50 to 400, 62.5 nsec limits are 3000 to 4000 codes. Limit is checked on average of readings.

Displayed message: Either "Cal TDC... Passed" or "Cal TDC... Failed" followed by minimum, maximum and average readings for pedestal and 62.5 nsec, in codes.

CAL_VCO:

Purpose: This routine calibrates the 9210's timing circuits. It is called five times, for PERIOD, DELAY_A, WIDTH_A, DELAY_B, and WIDTH_B timing circuits, in the order shown.

Procedure: The frequency counter is used to measure each VCO's free-running frequency (prescaled by 64) at 76 selected control voltage points. The points have been selected so that linear interpolation between the points will result in a maximum error of less than 0.05% for the expected control voltage vs. frequency curve. The VCO frequency is varied from maximum to minimum. The first count is made with a gate time of 9 msec, which should result in a count of over 50000 (count of 65535 at 466 MHz, 50000 at 355.6 MHz) As the VCO is slowed down, the gate time is increased by a factor of 1.25 whenever a count under 30000 is seen. Since the expected accuracy of the frequency counter is better than 400 nsec gate accuracy +/- 1 count, the calibrated points should be accurate to better 1 part in 20000.

Error bit: Bit 4 in *CAL? response

Details: (TER? 4 response)

1: Unreasonable frequency reading (less than 25000 counts) OR fastest reading > 2.8 ns or slowest reading ² 19 ns.

2: Non-monotonic VCO frequency change

4: Aborted (very unreasonable reading, less than 20000 counts)

Displayed message: Either "... Passed" or "... Failed" followed by either the fastest and slowest readings in ps if not aborted, or if aborted, the last frequency counter count.

CAL_PLUGIN_A:

Purpose: Calibrate amplitude, offset and slew rates.

Procedure: Different for each module type. Verifies all module specs except linearity, settling time, overshoot and ringing.

Error bit: Bit 8 in *CAL? response

Details: (TER? 8 response)

CAL_PLUGIN_B:

Purpose: Calibrate amplitude, offset and slew rates.

Procedure: Different for each module type. Verifies all module specs except linearity, settling time, overshoot and ringing.

Error bit: Bit 9 in *CAL? response

Details: (TER? 9 response)

CAL_DISP_TEMPERATURE:

Purpose: Append temperature to cal message.

CAL_DISP_REV_INFO:

Purpose: Append firmware revision information to cal message.

SELFTEST

Top level procedure:

CALIBRATE:

Performs calibration (see above).

STEST_MAIN_PROM:

Purpose: sumcheck main Prom

Procedure: Add bytes to 32 bit sum. Start: 0. End: 0x1FFFB. If 1FFFC to 1FFFF is not 0, assume it is expected checksum. Compare, show PASS or FAIL. If it is zero, just display computed checksum - never fail.

Error bit (in *TST? response): ERRBIT_STEST, bit 15

Details (in TER? 15 response): 4 = main PROM checksum test failed

STEST_PLUGIN_PROM:

Purpose: sumcheck plugin's Prom. Called twice, for A and B.

Procedure: Add bytes to 32 bit sum. If plugin installed:

For plugin A Start: 0x80000. End: 0x87FFB.

For plugin B Start: 0x88000. End: 0x8FFF B.

If 4 bytes following END are not 0, assume they are expected checksum. Compare, show PASS or FAIL. If zero, just display computed checksum - never fail.

Error bit: ERRBIT_STEST

Details (in TER? 15 response):

8 = plugin A checksum failed

16 = plugin B checksum failed

STEST_BBRAM:

Purpose: perform a ram test on battery backed up
RAM, from 7C000 to 7FFFF, 8K bytes.

Procedure: for as many 1K blocks as necessary:

Disable processor interrupts

Save 1K byte block

Write block with start pattern, low to high address
(forward)

Read forward and compare start pattern

Write backward complement of start pattern

Read backward and compare complement pattern

Restore block's original contents

Enable interrupts

check_delays() - updates watchdog

Note: this test is based on "Efficient algorithms for
Testing Semiconductor Memories" by R. Nair et al,
IEEE Transactions on Computers Vol. C-27 No. 6,
June 1978. This test will catch any stuck data line,
cell fault or coupling and, as implemented, faults in
the lowest 10 address lines or in the RAM chip's
decoding of these lines.

Error bit: ERRBIT_STEST

Details (in TER? 15 response): 1 = battery backed-up
RAM test failed

STEST_RAM:

Purpose: same as stest_bbram, but for main ram at
40000 to 47FFF.

Error bit: ERRBIT_STEST

Details (in TER? 15 response): 2 = main RAM test failed

STEST_VIDEO:

Purpose: Verify that Horizontal and Vertical Sync signals are being generated and are approximately the expected frequency.

Procedure: Run frequency counter: source Hsync, 10 msec gate. Check that result is 189 to 231, i.e., 18.9 to 23.1 kHz. Run frequency counter: source Vsync, 800 msec gate. Check that result is 35 to 50, i.e., 43.75 to 62.5 Hz.

Error bit: ERRBIT_STEST

Details (in TER? 15 response): 32 = video test failed

TRIGGER_CIRCUIT_TEST:

Purpose: make sure trigger input comparators work, both slopes

Procedure: Save trigger mode, trigger slope, trigger level. Set trigger mode to External Width. Turn on "trigger test" - ground trigger input through FET. For positive slope, negative slope, and trigger input disabled:
Set the trigger comparator threshold to 2.5V. Start the TDC on output of Period generator. Swing the trigger input threshold to -2.5V. Expect trigger if trigger slope positive, else not. Start the TDC again on the output of the period generator. Swing the trigger input threshold back to +2.5V. Expect trigger if trigger slope negative, else not. Check that TDC fired when expected and timed out otherwise.

Restore trigger mode, trigger slope, trigger level

Error bit: ERRBIT_STEST

Details (in TER? 15 response): 64 = trigger test failed

TRIGGER_DELAY_TEST (errbit_delay,0):

Purpose: Make sure that Period->Width->Delay chain is unbroken, with a reasonably short fixed delay.

Procedure: Save trigger mode, trigger slope, and A and B width and delay. Set trigger mode SINGLE, slope DISABLED, and Channel A and B widths to 100 nsec, and delays to 0.

For channel A and B: Set TDC MUX to start on Period out and stop on Channel (width up). Sum 64 TDC readings, using manual trigger to fire period gen. Check that TDC always fired and reading < 20 nsec (approx.). Restore trigger mode, trigger slope, and A and B width and delay

Error bit: ERRBIT_DELAY = bit 3

Details: 1 = excessive prop delay in channel A

2 = excessive prop delay in channel B

Status Data Structure

21) The status data structures in the 9210 are:

Status Byte Register: Contains status summary messages. The 488.2 standard defines the following bits:

- MAV** - Message Available - true when the output queue is not empty.
- ESB** - Event Status Bit - true when an enabled bit in the Standard Event Status Register has been set since the last reading or clearing of the Standard Event Status Register (see below).
- RQS** - Indicates that this device is requesting service. This bit is only readable by serial poll, and is cleared after being read once.
- MSS** - Indicates that an enabled bit in the status byte register is true. This bit replaces **RQS** when the status byte is read by "***STB?**", as shown in the diagram below.

In addition, we define:

- ERQ** - Error Queue summary bit - true when the error queue is not empty.

Service Request Enable Register: Each bit (except bit 6) of this register "enables" the corresponding bit in the Status Byte Register when true. Bit 6 in the Status Byte Register cannot be disabled. This register is completely defined by 488.2.

Standard Event Status Register: IEEE 488.2 defines all of the bits in this register. It is read by ***ESE?**.

- Bit 7 - Power on
- Bit 6 - User Request (not used by 9210)
- Bit 5 - Command Error
- Bit 4 - Execution Error
- Bit 3 - Device Dependent Error
- Bit 2 - Query Error
- Bit 1 - Request Control (not used by 9210)
- Bit 0 - Operation Complete (used for *OPC command)

Standard Event Status Enable Register: Defined by 488.2. Each bit "enables" the corresponding bit of Standard Event Status Register when 1. If any enabled bit becomes set, the Event Summary Bit (**ESB**) in the Status Byte register becomes set.

Output Queue: defined in 488.2. Our implementation holds 257 bytes. If a larger response needs to be generated, the 9210 finishes placing the response in the buffer as the first part is read out.

In addition to these registers and the output queue, which are defined by 488.2, we define an Error Queue. The Error Queue summary bit is bit 7 in the Status Byte Register, and has already been discussed. The error queue holds 31 entries. It is read by the **ERR?** query.

Successive readings get successive entries. If the queue is empty, **ERR?** returns **0,"NO ERROR"**. If the error queue is full when an error occurs, then **ERR?** will return **350,"TOO MANY EVENTS"** after returning the 31 entries in the queue, (i.e. on the 32nd query). A complete list of error codes appears in the Appendix E of this manual.

STATUS BYTE AND SERVICE REQUEST ENABLE REGISTER LAYOUT

	7	6	5	4	3	2	1	0
Status Byte Register (as read by Serial Poll)	ERQ	RQS	ESB	MAV	0	0	0	0
(as read by *STB?)	ERQ	MSS	ESB	MAV	0	0	0	0
Service Request Enable Register (read by *SRE?, written by *SRE <NRf>)	7	X	5	4	3	2	1	0

Sequential Processing

22) All 9210 commands are sequential, the 9210 has no "overlapped" commands. The only exception to strict sequential processing is for coupled commands (see 5e, above) as described in 488.2-1987 section 6.4.5.3.

Operation Complete

23) Op Complete is generated when all <PROGRAM MESSAGE UNITS> in a <PROGRAM MESSAGE> have completed execution. Op Complete generation is the final action, after the completion of coupled commands (if any), caused by a <PROGRAM MESSAGE>. The GPIB Commands Chapter of this manual (Chapter 7) documents the functional criteria that are met by each command.

Additional Notes

- I) Items 14, 15, 17, 18 are only required if certain optional common commands (macro commands, ***PUD**, and ***RDT**) are implemented. The 9210 does not implement these commands.

- II) The above required documentation is correct for the set of documented 9210 commands. The 9210 contains a few headers which are meant only for testing and are not documented in this manual.

GPIB Error Queue

This section lists the possible responses to the ERR? query. Each response is a decimal numeric error code followed by a quoted string with a very brief explanation of the error. This section presents a more detailed explanation for each error.

The list of errors is divided into groups reflecting which bit is set in the Standard Event Status Register (read by *ESR?) when each error occurs. Because the 9210's error queue contains more detail than the ESR, it is not necessary to use the ESR. The ESR is included for IEEE Std 488.2 compliance.

When the error queue is empty, the query ERR? produces the following response:

0,"NO ERROR"

One other possible response which may be caused by any error is:

350,"TOO MANY EVENTS"

This indicates that all 31 entries in the error queue were full when another error occurred.

Errors in the range of 100 to 199 set the Command Error bit (bit 5, value 32) in the Standard Event Status Register.

Command Errors

Command errors are detected while parsing commands received from GPIB. No attempt is made to execute a command which causes a command error. If the command error is caused by an error in 488.2 syntax, the parser will ignore the remainder of the program message; these errors are noted below.

102, "SYNTAX ERROR"

Possible causes: misspelled or unknown header, EOI in impossible place (such as with a '*' at the beginning of a header or before any alpha character after header path such as "A:").

106, "INVALID PGM DATA SEP"

The only legal program data separator is comma, with optional surrounding white space. After a program data element, the parser expects either a program data separator (indicating another program data element will follow), a program message separator or program message terminator. If something other than these is found this error is generated. The remainder of the input message is ignored.

108, "TOO MANY PARAMS"

At least one more program data element was parsed than is needed for the command or query. Example: A:VHI 2.0,3.0

109, "MISSING PARAM"

At least one less program data element was parsed than is needed for the command or query.

112, "PGM MNEM TOO LONG"

IEEE Std 488.2 specifies that all program mnemonics must be 12 characters or less. However, the 9210 does not produce this error message upon receiving a 13th character, but on receiving a program mnemonic too large to fit in the parser's buffer (over 256 characters!). The remainder of the input message is ignored.

113, "UNDEFINED HEADER"

Either a command was received whose header is valid only as a query, or what appears to be an invalid header path was found, or an impossibly short (1 character) header was found.

114, "INVALID HEADER"

The only valid characters for a program message header are A through Z (case does not matter), 0 through 9, and underscore. The first character must be alpha. The remainder of the input message is ignored.

115, "INVALID HEADER COMPOUNDING"

Missing header path (module ID) on a header that requires it, or header path is present on a header that does not need it.

118, "QUERY NOT ALLOWED"

A query has been received whose header is only valid as a command.

121, "INVALID CHAR IN NUMBER"

Either a non-numeric argument occurred where a number was expected, or an invalid character occurred within a numeric argument. In the latter case the remainder of the input message is ignored.

123, "NUMERIC OVERFLOW"

A number was parsed which was too large to fit in the internal representation of that value.

124, "TOO MANY DIGITS"

The number of digits of what the parser believes is a numeric field exceeded the length of the parser's buffer. The parser's buffer is 300 characters long, part of which is used for the program message header.

141, "INVALID CHARACTER DATA"

Character data was expected, but the parsed element either isn't character data, contains an illegal character (not A to Z, 0 to 9 or underscore) or does not match any recognized option for this header. For example, setting the trigger mode to ON with the command TRMD ON would produce this error.

NOTE: Only the first four characters of Character data elements are used by the parser, so TRMD NORM is the same as TRMD NORMAL, for example.

144,"CHAR DATA TOO LONG"

IEEE Std 488 specifies that character data elements are limited to 12 characters. The 9210 produces this error only when the character data is too large to fit in the parser's buffer. The remainder of the input message is ignored.

151,"INVALID STRING DATA"

Either a character outside the ASCII character set was found in a quoted string, or EOI occurred before the quotes were closed, or a string data element was expected but some other type of data was encountered. In the first two cases the remainder of the input message is ignored.

161,"INVALID BLOCK DATA"

Either EOI occurred during the count in a definite length block header, or an EOI occurred before the length was satisfied for a definite length block, or a block data element was expected but a different type of element was encountered.

162,"INVALID BLOCK DATA HEADER"

The character following the '#' was not a valid block format. The remainder of the input message is ignored.

163,"BAD CHAR IN COUNT"

The count in a definite length block header contained character outside the range 0 - 9.

Execution Errors

Errors in the range of 200 to 299 set the Execution Error bit (bit 4, value 16) in the Standard Event Status Register.

Execution errors are detected when a properly parsed header cannot be executed because a program data element is out of range, or cannot be properly executed because of some other device condition.

221,"SETTINGS CONFLICT"

Otherwise valid device settings cannot all be valid together. For example, VHI 3.0V is valid, unless VLO is greater than 3.0V. Please see the section on Parameter Conflicts in Chapter 3 of this manual for more information.

222,"DATA OUT OF RANGE"

Numeric program data element is outside of the device's capability for this header; this setting can never be valid. No attempt is made to execute the command.

Example: FREQUENCY 1273 GHz

223,"TOO MUCH DATA"

String data or block data element too large to fit in the parser's buffer was encountered. The remainder of the input message is ignored.

241,"HARDWARE MISSING"

A module specific command or query was parsed for a module which is not installed.

Query Error

Errors in the range of 400 to 499 set the Query Error bit (bit 2, value 4) in the Standard Event Status Register.

410,"INTERRUPTED"

The device received a complete program message which included a query, but the response was not completely sent before another program message arrived. The output queue is cleared, i.e., the unwanted query response is discarded.

420,"UNTERMINATED"

The controller attempted to read from this device without first sending a complete (terminated) query message. The output queue is cleared, i.e., any partial response message is discarded.

430,"DEADLOCKED"

The device is deadlocked when it cannot accept another character because the input buffer is full, the parser is blocked because the output buffer is full and a query has been parsed, and the controller is waiting to send more bytes to the device. The output queue is cleared to break the deadlock, and does not enqueue any response for output for the remainder of the current program message.

440,"QUERY INDEF QUERY"

This error occurs when an indefinite length response element (whose end can only be signified by EOI) is already enqueued for output and another query is encountered in the same program message. Multiple query message units within one message are supposed to generate one response message, with response message units separated by ';', but in this case the ';' and subsequent responses cannot be queued for output without causing ambiguity in the length of the indefinite length response element.

**Device Specific
Errors**

Errors in the range of 500 and above set the Device Dependent Error bit (bit 3, value 8) in the Standard Event Status Register.

These errors are detected by device functions and are not specifically related to GPIB; most device functions can be invoked from front panel operation also. The error queue only reports errors due to GPIB messages (except for errors 508 and 509, see below). Errors due to front panel operations cause messages to be displayed on the bottom of the 9210's screen.

501, "TOO MANY HASH TBL COLLISIONS"

At power on, the 9210 creates a hash table to speed up the parsing of commands received over GPIB. This error indicates that the maximum depth of the hash table has been exceeded. This error should never occur.

502, "TOO MANY COMMANDS FOR HASH TABLE"

At power on, the 9210 creates a hash table to speed up the parsing of commands received over GPIB. The hash table is updated when a module is inserted or removed. The hash table contains values in three ranges, indicating whether the command is in the mainframe's command table or added by module A or module B. This error indicates that a number too large to fit in the proper range would be needed. This error should never occur.

503, "CAN'T RECALL EMPTY FILE"

Produced by *RCL when the requested file does not contain device settings.

505, "INCORRECT MODULE TYPE"

Produced by CHK when the module type specified does not match the installed module's type.

507, "VALUE LIMITED TO USER LIMIT"

Produced either when LIMits are turned on if VHI and VLO are outside the limits, or if an attempt is made to set VHI and VLO outside the limits while LIMits are ON. This error indicates that either VHI or VLO, or both, have been changed to be within the limits.

508, "MODULE IS TOO HOT TO ENABLE"

Produced when the module overheats, or when an attempt is made to re-enable the module while it is still overheated. When the module overheats, this message is queued into the error queue, the device dependent error bit is set in the ESR, and the screen displays the message "MODULE A DISABLE DUE TO OVERHEATING" (or "MODULE B...", as appropriate).

509, "MODULE AUTO DISABLED"

Produced when the module disables itself due to some cause other than overheating. In current modules, the only possible cause is overvoltage protection. When this occurs, this message is queued into the error queue, and the device dependent error bit is set in the ESR. No error message is displayed on the screen, but the "disabled" LED on the module is turned on and the status line at the bottom of the screen is updated.

Displayed Error Messages

Errors due to front panel operations cause messages to be displayed on the bottom of the 9210's screen.

Some of the messages due to front panel operations are identical to strings which ERR? returns due to errors caused by GPIB operations. Examples are: SETTINGS CONFLICT, CAN'T RECALL EMPTY FILE, and VALUE LIMITED TO USER LIMIT. These are errors detected by device functions which may be activated by either command source. The remainder of this appendix lists messages which only appear on the display.

Value too small.....set to the limit

Occurs only due to counterclockwise turning of the outer knob. The outer knob changes a numeric value in a 1, 2, 5 sequence. The next lower step in this sequence is beyond the range of the parameter.

Value too large.....set to the limit

Occurs only due to clockwise turning of the outer knob. The outer knob changes a numeric value in a 1, 2, 5 sequence. The next higher step in this sequence is beyond the range of the parameter.

Value out of range. Range is shown with entry field

A value entered through the numeric keypad is beyond the range of the parameter. The parameter is not changed.

Value rounded or truncated

This error may occur after the CHANGE FORMAT button is pressed. For example, a 30 nsec period is not representable as frequency in a finite number of digits. The screen would show 33.333 MHz. Pressing the FORMAT button never causes hardware settings to be updated. However, any change using the fine knob (for example incrementing the rightmost digit, so the display shows 33.334MHz) causes the hardware to be set to exactly what the display shows. Since this is not exactly .001 MHz greater than the previous value, this error message is generated.

This error may also occur when the "left arrow" button is pressed to move the highlight to a leading zero, causing a non-zero digit to vanish on the right. The hardware is immediately set to the value shown on the display.

Value at the limit

This error will occur when the selected parameter is already at its maximum value when an attempt is made to increment it, or when a parameter is already at its minimum value when an attempt is made to decrement it.

No alternate format

The CHANGE FORMAT button was pressed while a field was selected which can only be displayed in one way, i.e., it has no alternate format.

Invalid keypad entry

One of the four numeric entry terminating keys (Enter/Hz, m/kHz, u/MHz, n/GHz) was pressed while a numeric entry field was not displayed, i.e., before any digits, sign or decimal point had been entered.

Step too large...cannot decrement

Occurs on an attempt to decrement a digit using the fine knob which would cause the parameter to be out of range. The parameter is not changed.

Step too large...cannot increment

Occurs on an attempt to increment a digit using the fine knob which would cause the parameter to be out of range. The parameter is not changed.

At the maximum step

Cannot move the highlighted digit to the left, the highlight is on the leftmost digit that this parameter can ever have non-zero.

At the minimum step or the last digit

Cannot move the highlighted digit to the right.

Value too small to truncate

Cannot move the highlighted digit to the left, because the value is already four leading zeros and one significant digit. Moving the highlight left again would lose the last significant digit and make the value 0, which is out of range for this parameter.

No field selected or not applicable

The FORMAT button has been pressed while either no field was selected, or the highlighted field has no parameter associated with it (i.e., it is not selectable). The latter case can occur by positioning the highlight with the up and down keys.

In remote...key ignored

Every front panel key which may effect the device's state, except LOCAL, is ignored in remote state. Pressing LOCAL exits remote state. Remote state is set by the GPIB controller.

In remote with lockout...key ignored.

Every front panel key which may effect the device's state, including LOCAL, is ignored in remote with lockout state. If you must exit remote with lockout using the front panel, your only option is to power down the device.

Invalid numerical string

One of the four numeric entry terminating keys (Enter/Hz, m/kHz, u/MHz, n/GHz) was pressed while the numeric entry field contained a string which could not be interpreted as a number, such as "-".

Returned to local

This is not an error. This message is to highlight the fact that front panel control has been returned. This may occur when the LOCAL button is pressed, or when the REMOTE signal is made false on GPIB.

Already in local

The LOCAL button has been pressed while local control was already enabled.

Local to remote occurred

This is not an error. This message is to highlight the fact that front panel control has been disabled from GPIB. Pressing the LOCAL button will restore local control unless remote with lockout has been set from GPIB.

Recalled standard

Not an error. Default settings have been recalled.

Recalled previous

Not an error. Settings that were in effect prior to the last Recall have been restored. These settings were automatically saved when the Recall was performed.

Recalled file <number>

Not an error. A Recall has been performed.

File <number> module mismatch

The file which has just been recalled was saved when different module types were installed, or the modules were in different slots. Settings which are not applicable are ignored; settings beyond the range of the currently installed modules are defaulted.

Trigger is too fast

This message is produced when part of the 9210's timing hardware was retriggered while it was still busy responding to the previous trigger. The 9210's timing is pipelined. This message is produced when any stage in the pipeline is retriggered while busy. The benefit of pipelining is that the first stage can be triggered even though subsequent stages are busy. For example, consider Single trigger mode with Delay 50 nsec and Width 40 nsec. Triggers can be accepted approximately every 50 nsec because after 50 nsec the Delay timing is completed, and only width generation is in progress.

Can't find trigger level

Trigger auto level find failed because it could not detect a trigger signal at any level checked. Either the trigger is very slow, or too small a signal to detect.

Manual trigger

Not an error. Just confirmation that the Manual Trigger button has been pressed.

Ampl

This is the Pulse Amplitude, i.e., the difference between the quiescent and active levels of the Output Pulse.

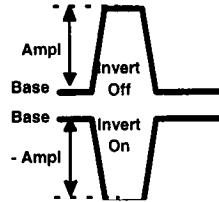

Base

This is the quiescent level of the Output Pulse, regardless of the state of Invert.

Burst Mode

In Burst mode, a programmed number of Output Pulses is generated for each external input. This number may be programmed from 3 to 4095 by setting the burst count.

In Burst Trigger Mode, a programmed number (the Burst Count) of pulses are output for each trigger. The Trigger Output's width will be equal to Period X (Burst Count - 1).

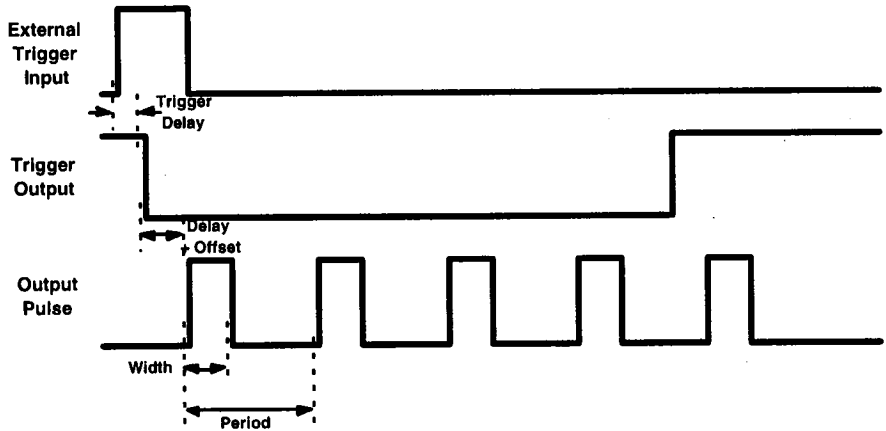

Pictorial representation of Pulse Parameters

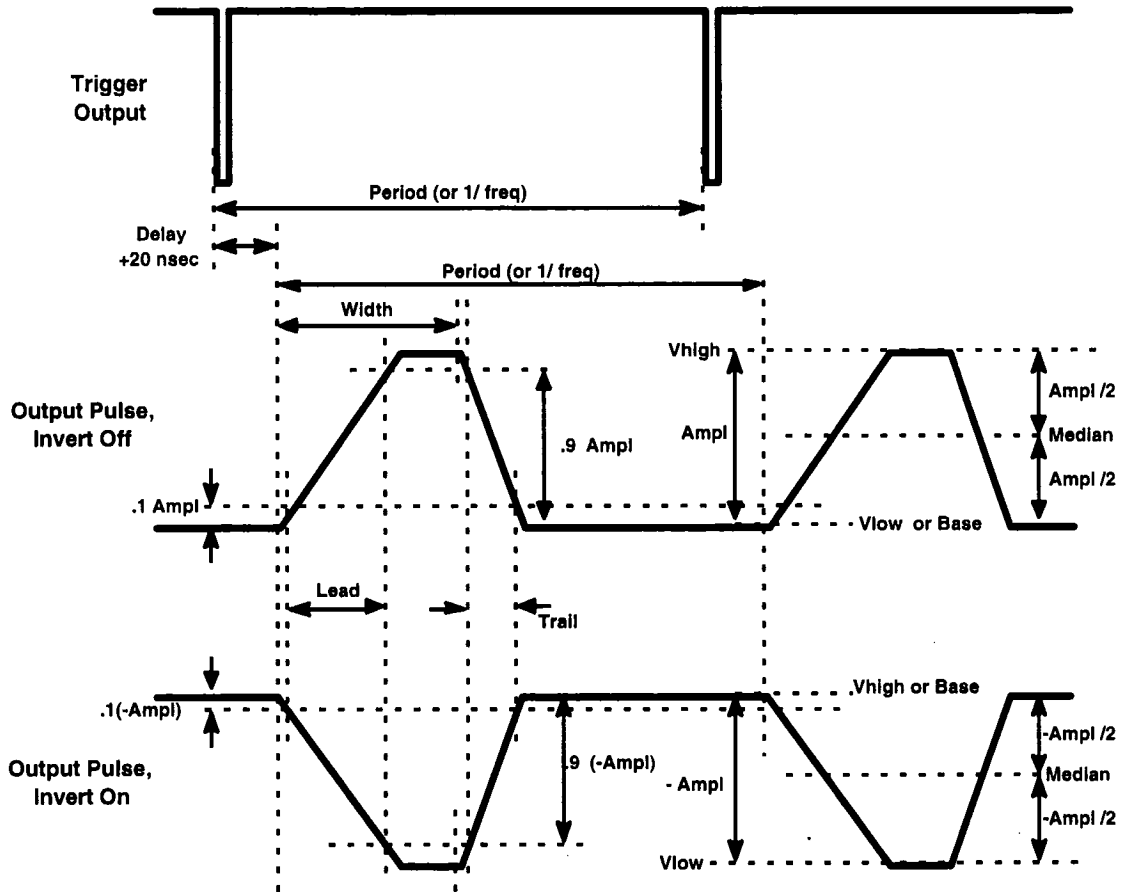

- Notes: 1) Duty Cycle = (Width / Period) X 100%
 2) Phase = (Delay / Period) X 360°

Delay

This parameter defines the variable time interval from the Trigger Output to the Output Pulse, excluding a fixed time offset of approximately 13 nsec.

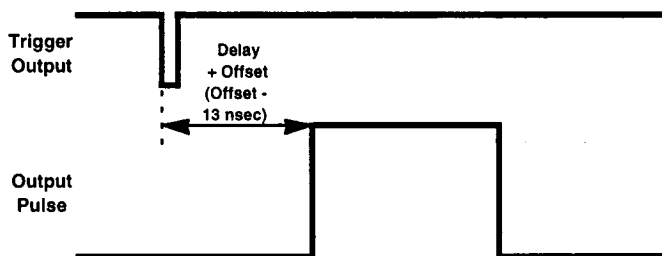
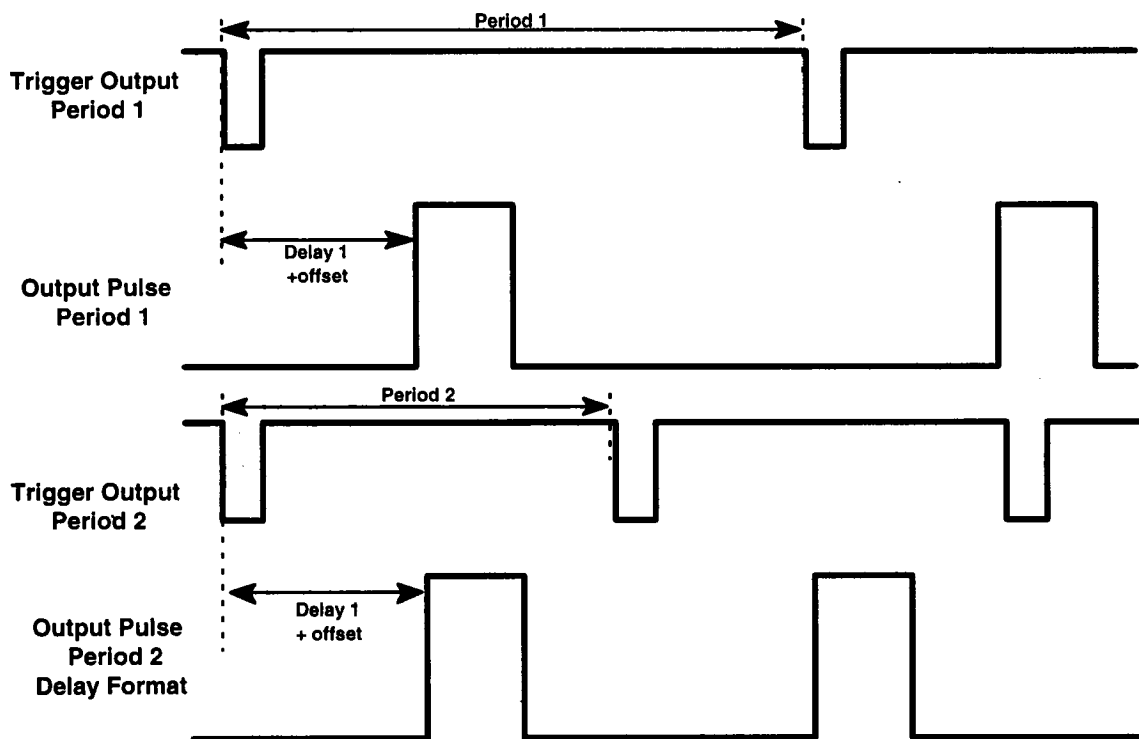
***Changing Repetition Rate
in Delay Format***

Double Pulse

Turning 2 Pulse ON will result in two Output Pulses occurring for each pulse that was output with 2 Pulse OFF. See the section entitled “Double-Pulse Interactions” in Chapter 4 of this manual (Trigger Controls) for a description of how 2 Pulse works in the various trigger modes.

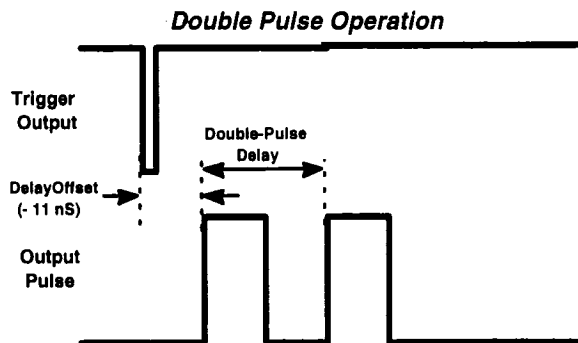

Duty Cycle

The percentage of the Period over which the Output pulse is in the active state.

Changing Repetition Rate in Duty Cycle Format

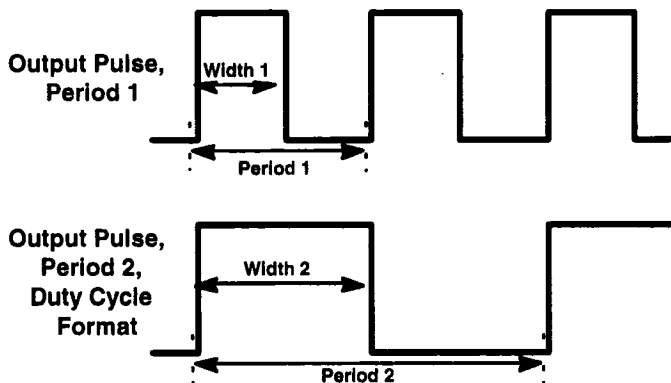

External Width Mode

In External Width mode, the signal at the External Input is reproduced at the Module Output with programmable transition times and output voltage levels. The polarity of the Output Pulse is dependent upon the trigger slope selection. Setting trigger slope to Negative cause the Output Pulse to be inverted with respect to the External; Input. No inversion occurs id trigger slope is set to Positive.

In External Width Mode, the signal at the Ext Input is reproduced at the Output with programmable transition times and voltage levels

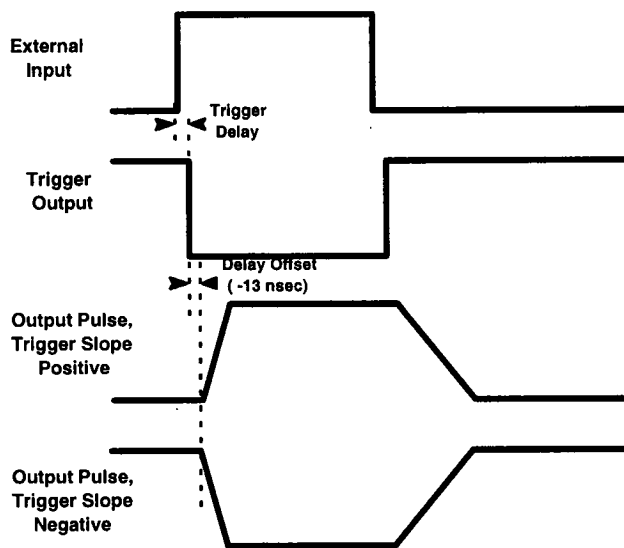

Frequency

The inverse of Period. The repetition rate of the Output Pulse expressed in Hz.

Gate Mode

In Gate mode, Output Pulses of the programmed Width occur at the rate specified by Period as long as the signal at the Ext Input is in the state defined by Trigger Slope and Trigger Level as true.

In Gated Trigger Mode, Output Pulses start after the Delay, and continue to run at the rate defined by Period, for the duration of the true state of the Gate Input

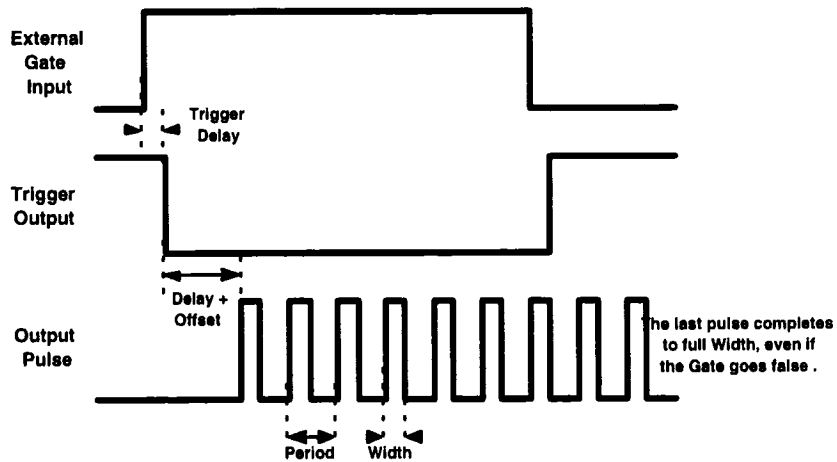

Lead

This is the time required for the leading edge of the Output Pulse to make the transition from 10% to 90% of its total amplitude.

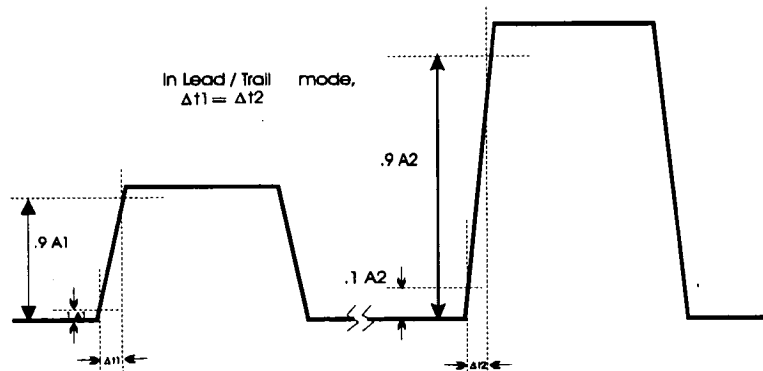

Load Compensation

When the Load Compensation feature is turned ON, the generator measures the load connected to the Module Output, and calculates a correction factor. It then uses that factor to make the necessary DC corrections to deliver the displayed voltage levels to any load resistance from 47Ω to $1M\Omega$.

Median

This is the midpoint between the quiescent and active levels of the Output Pulse.

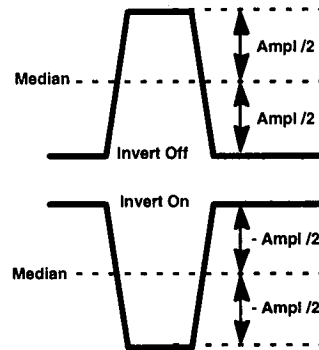

Normal Mode

Normal trigger mode produces a continuous Pulse stream at the selected Period and Width.

*Normal Trigger Mode is free - running,
requiring no external trigger signal.*

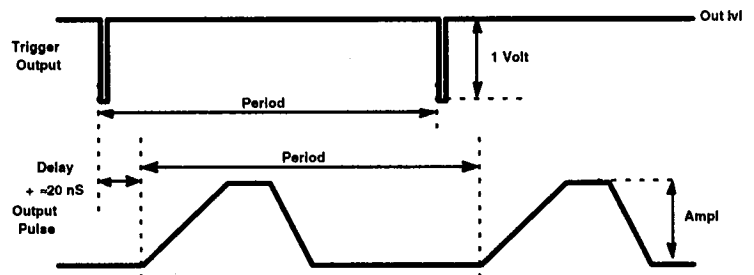

Period

This is the time between Output Pulses in Normal, Burst and Gate Trigger Modes.

Changing Repetition Rate in Phase Format

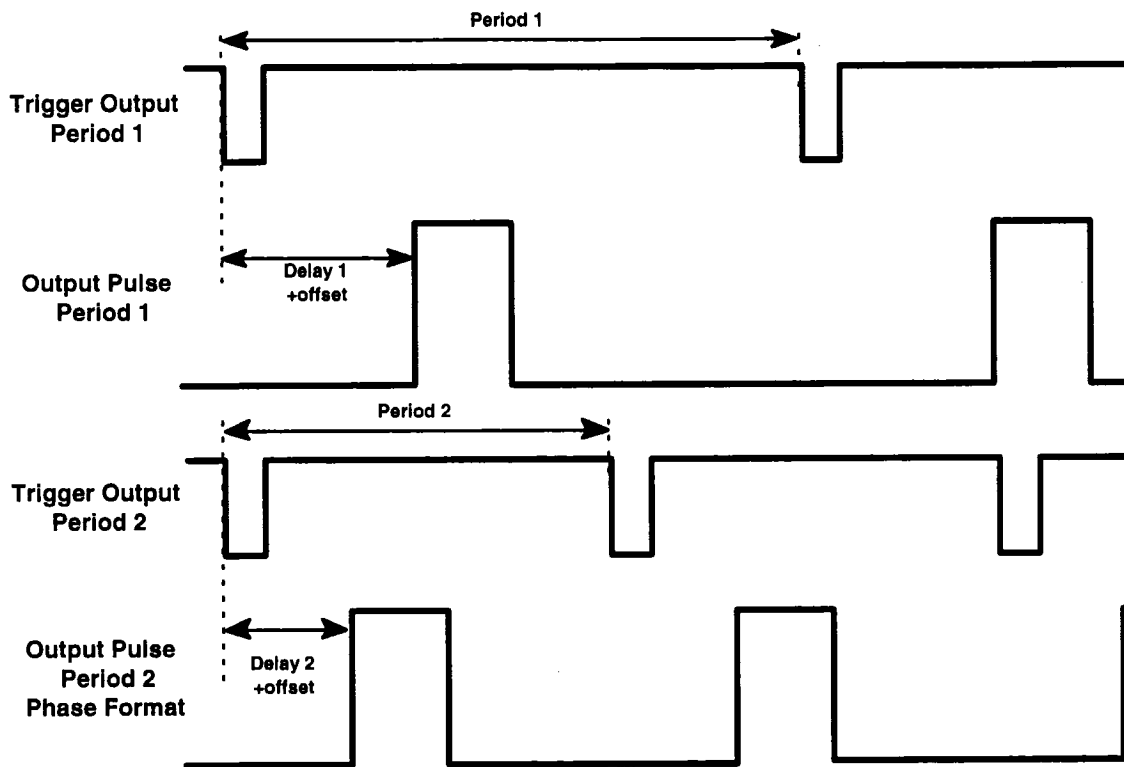

Phase

Phase mode is an alternate Delay format which works in a manner proportional to Period, similar to the way Duty Cycle format controls pulse duration. In this operating mode, the pulse's position is expressed as a phase angle, with 0_ corresponding to the minimum Delay setting (i.e. the offset). This phase angle is maintained as Period is varied. When Phase has been set:

$$\text{Pulse Delay} = \text{Phase}/360 * \text{Period}.$$

Single Mode

Single mode is triggered externally, either from the front panel Ext Input, the Manual Trigger button, or via GPIB command. The trigger starts the 9210's timebase. One Output Pulse of the programmed width will follow the Trigger Output by the programmed Delay plus a fixed offset of about 13 nsec.

Single Trigger Mode produces 1 Output Pulse per Trigger Input, or 1 Pulse Pair per trigger if 2-Pulse is ON.

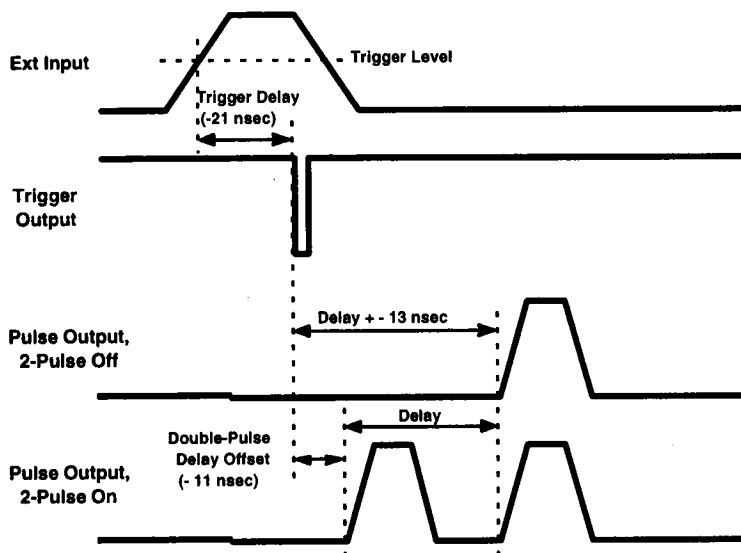

Slew

Slew Rate defines the slope of the selected edge during its 10% to 90% (or 90% to 10%) transition.

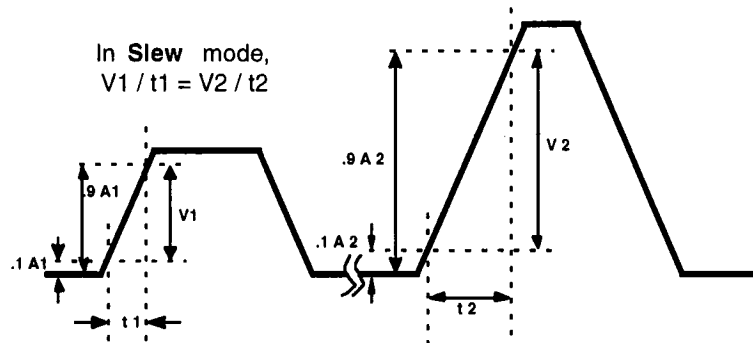
**Temperature Compensation**

This feature maintains the 9210's timing accuracy within specifications over a range of temperature variation of greater than $\pm 5^\circ\text{C}$ since the last calibration.

Trail

This is the time required for the trailing edge of the Output Pulse to make the transition from 90% to 10% of its total amplitude.

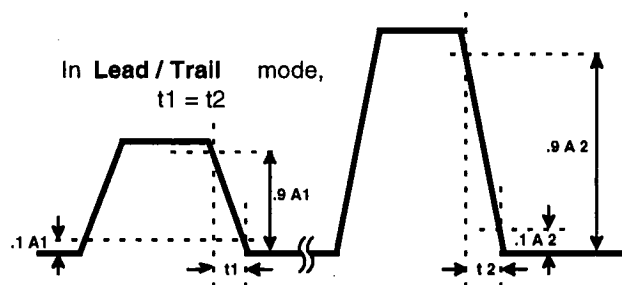

Trigger Level

The voltage threshold that must be crossed by the External Input signal in order to trigger the 9210. Trigger Level can be set to any value between ± 2.5 V with 20 mV resolution

Trigger Slope

The direction of the transition (Positive or Negative) through the specified Trigger Level that will trigger the generator. Trigger Slope may also be set to Disable, in which case the generator will not respond to the external input at all.

Trigger Output Level

The quiescent level of the Trigger Output. Out lvl can be programmed for values between ± 1.5 V into 50Ω , with 20 mV resolution.

Vhigh

This is the active level of the Output Pulse if Invert is off, or the quiescent level if Invert is on.

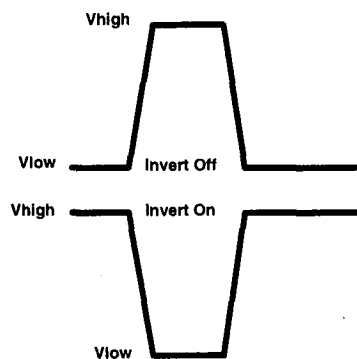
**Vlow**

This is the quiescent level of the Output Pulse if Invert is off, or the active level if Invert is on.

Width

This parameter directly defines the time interval during which the Output Pulse is in the active state.

Changing Repetition Rate in Width Format

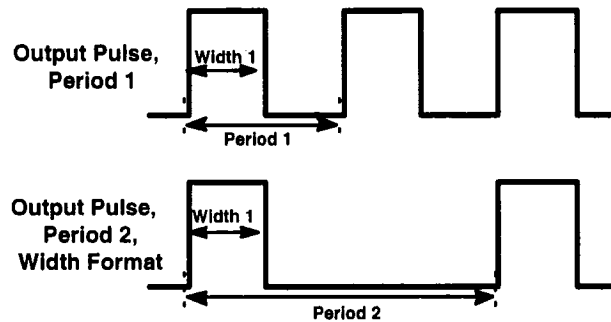

By the conventionally accepted definition among programmable pulse generator manufacturers, pulse width includes the transition time from the quiescent state to the active state, and excludes the transition time from active to quiescent. This convention allows pulse duration and edge rates to be independently adjusted, without affecting one another. However, this definition can differ significantly from FWHM (Full Width, Half Max), the definition used by digital oscilloscopes for measuring pulse width, if the leading and trailing edge speeds are not equal.

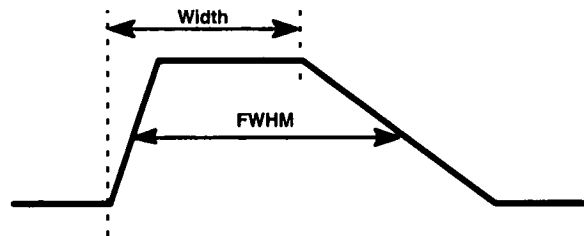

Important Notice - The 9210 Programmable Pulse Generator's "touch screen" user interface utilizes infra-red transmitter and receiver diodes as the sense elements. The operation of these optical diodes can be adversely affected if the unit is operated in intense sunlight or incandescent light. Should you need to operate under such conditions and experience problems with the interface, the "touch screen" can be disabled and the "SELECT" keys (up and down arrows) can be used to select the parameters to be programmed. The "touch screen" can be disabled via the "TOUCHCRT" selection in the CONFIGURE submenu, accessible under the MORE menu, or at power-up by holding a finger on the screen while pressing the power switch. See page 46 of this manual for further details.

For Mainframe Firmware Versions 2.7 and up (Mainframes shipped after 4/10/92) - The MORE menu display was revised under 9210 Mainframe firmware version 2.7. A new submenu, CONFIG, was added. The revised MORE menu and the new CONFIGURE page are shown below.

All selections on each of these pages behave exactly as described in Chapter 5 of this manual. The new sub-menu was added to uncrowd the menu displays and to achieve a better grouping of similar functions.

Due to the above changes, the displays shown in the manual on pages 9 and 39 will not appear on the TouchCRT exactly as depicted.

More Page	
CAL	
Selftest	
Cal Msg	New Page
Gpib	New Page
Config	New Page
Test	New Page
Normal 50	

Configuration Page	
ScrnSaveOFF
Bright12
TouchCRTON
TempCompON
Return New Page	
Normal 50	

For 9212 users with Module Firmware Versions 1.6 and up, and Mainframe Firmware Versions 2.8 and up (Units shipped after 6/10/92) -

A) Changes and additions to 9112 Output Module Specifications (see Appendix A of this manual, pages 93-95) -

- 1) Changes Specification (this information supersedes the specification stated in Appendix A of this manual, on page 93):
Minimum Pulse Width: ≤ 1.2 nsec
- 2) Added Specifications (this information supersedes the specification stated in Appendix A of this manual, on page 93):
Transition Time Accuracy: $\pm(20\%$ of value + 300 psec), for values less than the maximum (see below)

Transition Time Symmetry: $|t_{\text{lead}} - t_{\text{trail}}| < 20\%$ of value
 ± 300 psec:

Transition Time Resolution: 50 psec steps, worst case (at the module output)

Transition Time Repeatability: ± 100 psec (for identical module setup)

3) Clarified Specifications (the information below supplements that given in Appendix A of this Manual, at the bottom of page 94 under the heading "Pulse Performance", and in the graph on that page):

Minimum Transition Time: ≤ 300 psec @ Lead/Trail set to 250 psec

Maximum Transition Time:	Transition Time	Amplitude (@ Lead/Trail set to 1 nsec)
		0.50 V ≥ 450 psec
		0.75 V ≥ 540 psec
		1.00 V ≥ 580 psec
		2.00 V ≥ 675 psec
		3.00 V ≥ 720 psec
		4.00 V ≥ 745 psec
		5.00 V ≥ 750 psec

B) Additional Feature for the 9212 Output Module - Along with the new Transition Time Accuracy and Symmetry specifications (see above), a new feature has been added. The 9210 Mainframe's display will now indicate the specified Transition Time tolerances for any given setting in the 9212. When the LEAD menu box is selected on the 9210's TouchCRT, the tolerance window will be displayed to the right of the parameter's name (where the edge symbol appears in the figure on page 28 in Chapter 3 of this Manual). for example, when LEAD is set to 0.7 nsec, the displayed tolerance window will be ± 440 psec. These limits will be updated as the value is varied. Note that the tolerance window applies to the trailing edge as well as the leading edge.

LeCroy 9210MOD200 100 MHz Programmable Pulse Generator Mainframe

IMPORTANT NOTE: *At least one Output Module (9211MOD100 or 9215) must be installed in the 9210MOD200 Pulse Generator Mainframe in order to obtain a pulse output.*

TIMING CHARACTERISTICS: Defined at 50% amplitude points and minimum transition times.

NOTE: *The minimum values listed below refer to the mainframe only, and may not be achievable with all output modules.*

<u>Pulse Period:</u>	10 nsec to 4 sec
Resolution:	the greater of 0.1% of value or 10 psec
Accuracy:	± (0.5% of value + 0.2 nsec) from 3.33 nsec to 450 msec
RMS Jitter:	≤0.035% (350 ppm) of value + 35 psec
Temperature Coefficient:	<250 ppm/°C typ. with Temperature Compensation ON
Frequency:	Alternate format for Period. Settable from 100 MHz to 250 mHz with 0.1% resolution.
<u>Pulse Width:</u>	1.5 nsec to 450 msec
	For Width setting ≤7.2 nsec, max Width = Period - 0.75 nsec
	For Width setting > 7.2 nsec, max Width = Period - 2.85 nsec
Resolution:	the greater of 0.1% of value or 10 psec
Accuracy:	± (0.5% of value + 0.3 nsec) from 1.6 nsec to 450 msec
RMS Jitter:	≤0.035% of value + 35 psec
Temperature Coefficient:	<250 ppm/°C typ. with Temperature Compensation ON

Duty Cycle: Alternate format for Width. Settable from 1% to 99% in 0.01% steps. In this format, Width is controlled as a percentage of Period

Pulse Delay: 0 nsec to 450 msec measured from the leading edge of Trigger Out to beginning of leading edge of Pulse Output (relative to fixed offset)
 For Period setting ≤ 8.0 nsec: max Delay = Period - 2.6 nsec
 For Period setting > 8.0 nsec: max Delay = Period - 4.7 nsec

Resolution: the greater of 0.1% of value or 10 psec
Accuracy: $\pm(0.5\%$ of value + 1.0 nsec)
RMS Jitter: $\leq 0.035\%$ of value + 35 psec
Temperature Coefficient: $<(250 \text{ ppm} + 50 \text{ psec})/^{\circ}\text{C}$ typ. with Temp. Comp. ON
Match Between Output Modules of the same type: 1.2 nsec

Phase: Alternate format for delay. Settable from 0° to 359.9° with 0.1° resolution. In this format, Delay = Phase/360 x Period

Double Pulse Delay: 4 nsec to 450 msec

Resolution: the greater of 0.1% of value or 10 psec
Accuracy: $\pm (0.5\%$ of value + 0.3 nsec)
RMS Jitter: $\leq 0.035\%$ of value + 35 psec
Temperature Coefficient: $<250 \text{ ppm}/^{\circ}\text{C}$ typ. with Temperature Compensation ON

INPUTS AND OUTPUTS:

External Input:

Input Impedance: 10 k Ω or 50 $\Omega \pm 5\%$, selectable
Input Range: $\pm 5 \text{ V}$ into 50 Ω or $\pm 20 \text{ V}$ into 10 k Ω
Min. Detectable Amplitude: 200 mV
Threshold Range and Resolution: $\pm 2.5 \text{ V}$ adjustable in 20 mV steps

Threshold Level Accuracy:	± 100 mV
Max. Input Frequency:	100 MHz
Min. Pulse Width:	1.5 nsec
Min. Input Slew Rate	10 V/sec
Edge Selection:	Positive, Negative, neither edge (disabled).

Trigger Output:

Output Levels:	Nominal 1 V negative swing from base level into 50Ω . Base level adjustable over ± 1.5 V range with 20 mV resolution. (Into Hi Z: Amplitude = -2 V. Base level of ± 3 V, 40 mV resolution)
Output Impedance:	$50\ \Omega \pm 5\%$
Protection:	Protected against application of ± 10 V.
Delay from Trigger Input:	21 nsec typ.
Width:	Dependent on Trigger Mode
Normal Mode:	Period ≤ 7.2 nsec: Width = 1.8 nsec typ. 7.2 nsec < Period < 50 nsec: 3.6 nsec \leq Width \leq 7.2 nsec Period ≥ 50 nsec: Width = 25 nsec typ.
Single Mode:	Pulse Width setting ≤ 40 nsec: Trigger Output Width = 1.8 nsec typ. Pulse Width setting > 40 nsec: Trigger Output Width = 25 nsec typ.
Burst Mode:	Width = Period x (Burst Count - 1)
Gate and External Width Modes:	Trigger Output Width \approx Trigger Input Width

PROGRAMMABILITY: All generator functions are programmable over GPIB.
Command set conforms with IEEE 488.2-1987

TRIGGERING MODES:

- Normal:** Continuous pulse stream. Trigger output for each pulse output.
- Single:** Each external trigger input generates a single output pulse. One Trigger output for each trigger.
- Gated:** Signal at external input enables period generator. The first output pulse is synchronized with the gate's leading edge. Last pulse is allowed to complete. One Trigger output for each Gate input. 20 nsec retrigger (dead) time between Gate inputs
- Burst:** Each external trigger input generates a pre-programmed number of pulses (3 to 4095). Minimum time between two bursts is 50 nsec. One Trigger output for each trigger.
- External Width:** The signal at the external input is reproduced with programmable transition times and output levels. Trigger Output for each external trigger.

OPERATING FEATURES:

- Manual Trigger:** Front panel pushbutton generates an external trigger input. Each push provides one trigger pulse in Single and Burst Modes. Output remains active as long as button is pressed in Gate and External Width Modes.
- Double Pulse Mode:** When double pulse is set to ON, two pulses are produced for each trigger. The first pulse begins as soon as possible after the trigger (approximately the minimum Pulse Delay time). The Delay parameter now specifies the time from the leading edge of the first pulse to the leading edge of the second pulse. One Trigger Output occurs for each pulse

pair. Compatible with all Trigger Modes except External Width.

ADDITIONAL CAPABILITIES:

- Limit:** When enabled, the maximum high and low level settability of the pulse outputs is limited to protect the device under test.
- Setups:** 16 setup configurations can be stored and recalled using the Store and Recall keys on the front panel.
- Change Format:** Enables the alternate representation of a parameter or enables an alternate mode of operation. Examples are Amplitude/Base or Amplitude/Median in lieu of VHigh/Vlow, Duty Cycle instead of Width, Phase instead of Delay, Frequency instead of Period, Slew Rate as opposed to Transition Time.

ENVIRONMENTAL: *The following specifications apply to the 9210MOD200 mainframe and to output modules (9211MOD100, and 9215).*

- Storage Temperature:** -40°C to 70°C (temp above 40°C may degrade battery life)
- Operating Temperature:** 4°C to 40°C at rated specifications, operational from 0°C to 50°C
- Temperature & Self-Calibration:** Generator and Output Modules will meet specifications over a $\pm 5^\circ\text{C}$ range without repeating Self-Calibration
- Humidity Range:** < 95% R.H. from 4°C to 40°C
- Vibration:** Double amplitude displacement of 0.036" at a frequency from 5 Hz to 55 Hz non operating.
- Shock:** 15 g for 11 msec of half-sine wave shock non operating.
- POWER:** 115/220 VAC $\pm 20\%$; 48 - 448 Hz.
300 Watts Max. (180 typ)

MISCELLANEOUS:**Battery Backup Life:** 10 years typ.

The following specifications apply to the 9210MOD200 mainframe and to output modules (9211MOD100 and 9215).

Recalibration Interval: 1 year**Warmup Time (to meet specs):** 15 min, after which a new Self-Calibration must be performed.**9210MOD200 Mainframe****Weight:** 23 lbs. net
34 lbs. shipping**Dimensions:** Height: 5"
Width: 17"
Depth: 21"**Output Modules:****Weight:** 2 lbs. net
4 lbs. shipping**Dimensions:** Height: 4.6"
Width: 2.4"
Depth: 14.7"**OPTIONS:****9210-50/250-SM** Service Manual**9210/RM** Rack Mount Kit

LeCroy 9215 50 MHz, 15V Amplitude Output Module**TIMING CHARACTERISTICS:****Maximum Rep Rate:** 50 MHz**Minimum Pulse Width:** 10.0 nsec**Fixed Delay from Trigger:** 13 nsec \pm 4 nsec**Output Characteristics** Specified with output terminated in 50.00 ohms.**Output:** Unipolar positive or unipolar negative**Short Circuit Current:** \pm 500 ma typical**DC Source Impedance:** 50 ohms \pm 1%**Output Protection:** Protected against shorts to ground for 1 minute.**Output Levels****Unipolar Positive****High Active Level:** +0.2 volts to +15 volts**Low Quiescent Level:** 0.0 volt to +13.9 volts**Minimum Peak to Peak:** 200 mvolts**Maximum Peak to Peak:** 15 volts**Unipolar Negative:****High Active Level:** -0.2 volts to -15 volts**Low Quiescent Level:** 0.0 volts to -13.9 volts

Minimum Peak to Peak: 200 mvolts

Maximum Peak to Peak: 15 volts

Resolution: 10 mv

Amplitude Accuracy: $\pm(1\%$ of output level + 5 mv) into 50.00 ohms

PULSE PERFORMANCE:

Slew Rate Mode: Settable down to 0.1 volt/msec with 1% resolution and $\pm 20\%$ accuracy (separately settable for leading and trailing edge). Maximum rate determined by amplitude setting and transition time limits.

Variable Transition Times (10% to 90%):

Leading Edge: ≤ 5 nsec to 95 msec

Trailing Edge: ≤ 5 nsec to 95 msec

Ranges: 8 ranges of 25:1, Min. lead to trail dynamic range = 2.5:1, (except for lowest range, see graph below)

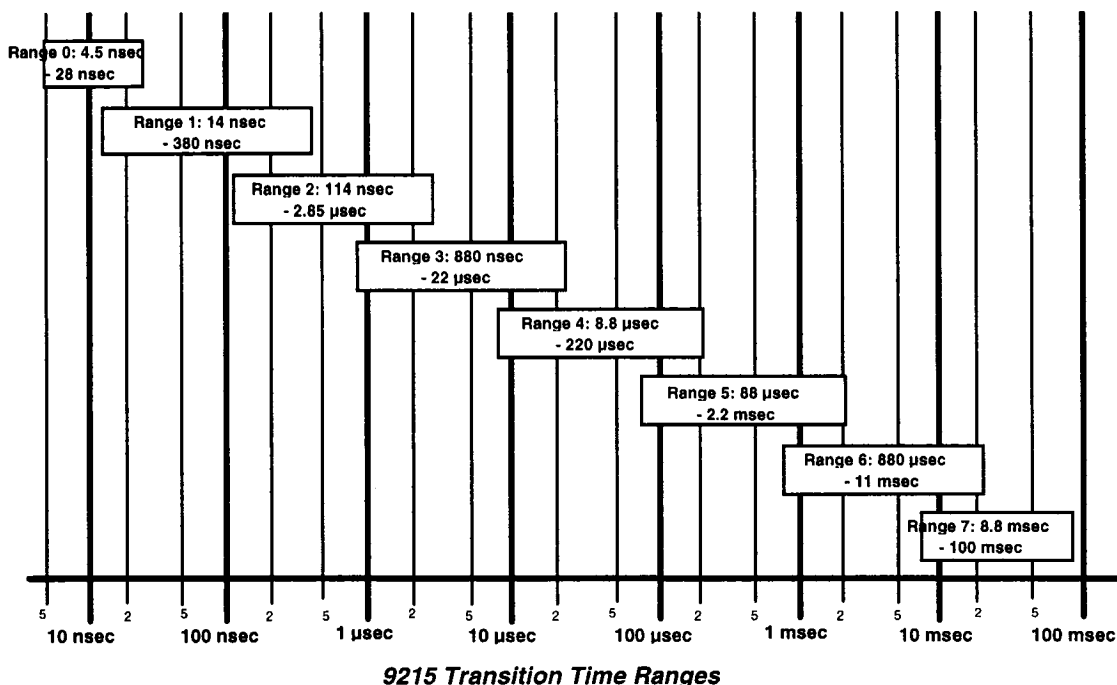

Resolution: the greater of 1% or 100 psec

Accuracy: $\pm(20\%$ of value, + 0.3 nsec)

Module Controls: The following controls are located on the front panel of the module.

Invert: Inverts normal output pulse levels. Quiescent and active levels exchanged.

Disable: Output circuitry is disconnected via relay.

Display Channel: Instructs the mainframe to select and display the settings and parameters for this module.

Mechanical and Environmental

Temperature:	+4°C to +40°C operating and - 40°C to 70°C nonoperating.
Humidity:	Up to 95% R.H. non-condensing while operating.
Vibration:	Double amplitude displacement of 0.036" at a frequency from 5 Hz to 55 Hz non operating.
Shock:	15 g for 11 msec of half-sine wave shock non operating.
Size:	2.4" (61 mm) wide x 4.6" (117 mm) high x 14.7" (374 mm) deep.
Weight:	2 lb. (3.63 kg).

LeCroy 9211MOD100 100 MHz, Variable Edge Output Module**TIMING CHARACTERISTICS:**

Maximum Rep Rate:	100 MHz
Minimum Pulse Width:	≤ 2.0 nsec
Fixed Delay from Trigger Out:	13 nsec \pm 4 nsec

OUTPUT CHARACTERISTICS: Specified with both outputs terminated in 50.00 Ω (Ratings in { } are when driving an open circuit.)

Outputs:	Normal and Complementary Polarity
Short Circuit Output Current:	± 260 mA typical
DC Output Source Impedance:	50 \pm 1 Ω
Output Protection:	Protected against application of $\leq \pm 15$ V

OUTPUT LEVELS:

High Level	-4.95 V to + 5.00 V { -9.90 V to +10.00 V }
Low Level	-5.00 V to + 4.95 V { -10.00 to +9.90 V }
Output Voltage Range:	± 5 Volts { ± 10 Volts } Maximum amplitude of 5 V { 10 V } Minimum amplitude of 40 mV { 80 mV }

Resolution: 5 mV { ± 10 mV}

Level Accuracy:

Normal Output: $\pm(1\%$ of output level +5 mV) into 50.00 Ω

Accuracy with Load Comp: The same accuracy as stated above will be maintained for user supplied load of 47 Ω to 1 M Ω when load compensation feature is enabled.

Complementary Output: $\pm(1\%$ of Programmed Value + 3% of Amplitude +40 mV) into 50.00 Ω

Accuracy with Load Comp: $\pm(3\%$ of setting times the ratio of the load on the complemented output to the load on the normal output). Measurements for the load compensating correction factors are made on the normal output.

PULSE PERFORMANCE:**Variable Transition Times** (10% to 90%):

Leading Edge: ≤ 1.2 nsec minimum (1 nsec typ) to 10 msec
Trailing Edge: ≤ 1.2 nsec minimum (1 nsec typ) to .10 msec

Ranges: 7 ranges of 25:1, Minimum lead to trail dynamic range = 2.5:1, except 2:1 at first range break (see graph, below).

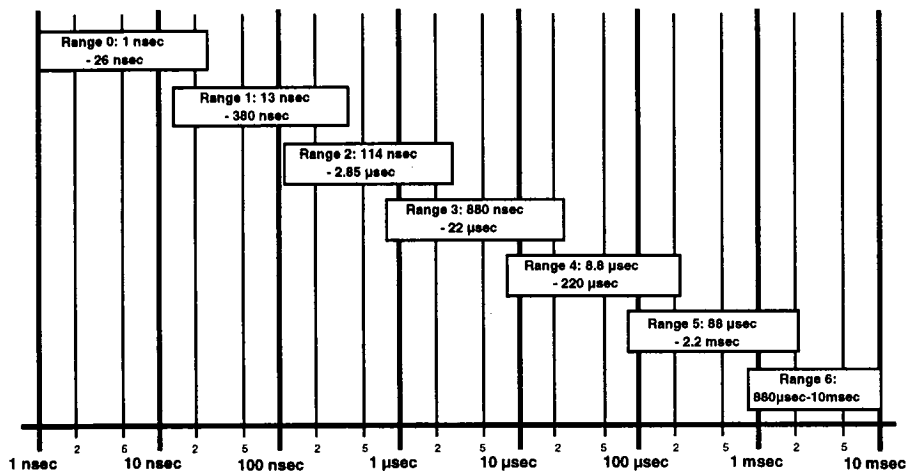

9211 Transition Time Ranges

PULSE PERFORMANCE (continued):**Variable Transition Times** (continued):

Resolution: the greater of 1% or 100 psec
Accuracy: $\pm(10\%$ of value + 300 psec)
Linearity: $\pm 3\%$ typ. (10-90%) for transition times > 50 nsec

Slew Rate mode: Settable down to 0.1 V/msec with 1% resolution and $\pm 10\%$ accuracy (separately settable for leading and trailing edge) Max. rate determined by amplitude setting & transition time limits stated above.

Overshoot and Ringing: the greater of $\pm 8\%$ of amplitude or ± 10 mV
Settling Time: ≤ 10 ns to 2% of amplitude change at fastest transition times

Normal to Complementary Output Skew: 200 psec max

MODULE CONTROLS: The following controls are located on the front panel of the output module.

Invert: Inverts normal output pulse levels. Quiescent and active levels exchanged.

Disable: Output circuitry is disconnected via relay.

Display Channel: Instructs mainframe to select and display all of the parameter settings for this module.

Specifications subject to change without notice.

[←Digit] and [Digit→] keys	3
← Digit	8
Digit →	8
2 Pulse	4, 25, 29, 36, 49, 50
9210	1, 6, 9, 10, 12, 13, 30, 31, 33, 36, 37, 14, 41, 42, 43, 44, 46, 47, 50, 51, 53, 55, 56, 57, 59, 60, 61, 62, 63, 64, 65, 67, 85, 95, 97, 101, 105, 106, 119, 120, 141, 143, 145, 148, 149, 151, 156
9210/RM	106
9210/SM	106
9211	15, 24, 35, 36, 37, 95, 98, 101, 105, 106, 119, 120
9212	15, 32, 33, 34, 35, 36, 37, 79, 80, 83, 84, 101, 105, 106, 111, 113, 119, 120
9213	15, 24, 36, 37, 101, 105, 106, 115, 119, 120
9214	4, 7, 15, 24, 32, 34, 35, 36, 37, 76, 80, 83, 84, 86, 101, 105, 106, 119, 120
*CAL	68
*CLS	91
*ESE	92
*ESR	92
*IDN	93
*LRN	93
*OPC	94
*OPT	95
*RCL	69
*RST	95
*SAV	69
*SRE	96
*STB	96
*TRG	69
*TST	70
*WAI	97
A	
action key	10, 57
active level	15, 17, 159, 169
active state	13, 18
Addr	59
Already in local	155
AMP	70, 71, 80, 83, 84
Ampl	17, 37, 59
AMPL	77

Index

Amplitude.....	17 , 59, 70
asterisk	25
At the maximum step.....	153
auto level	71
Auto lvl.....	50
AUTOL.....	71

B

BAD CHAR IN COUNT.....	146
Base.....	17, 37, 159
BASE	70, 71, 77, 80
Battery	106
BC.....	67, 72
BRI.....	72
Bright	61
brightness	60, 72
Burst	46, 51
burst count.....	46, 72
Burst Ct.....	36, 46, 49
Burst Mode	159
Bus Controller.....	12

C

Cal	10, 55
Cal Msg.....	56, 57, 58, 62
calibration	2, 55, 56, 57, 68
Can't find trigger level.....	157
CAN'T RECALL EMPTY FILE	149
Cancel.....	10
cannot decrement.....	153
cannot increment.....	153
Center Knob.....	3, 8
CHANGE FORMAT	12, 17, 19, 20, 23, 26
channel parameter menu.....	6, 16, 31, 33, 34
CHAR DATA TOO LONG.....	145
CHDR	97
Check	98
CHK	98
Clear status.....	91
CMD.....	67
COARSE.....	59

command.....	67
Command Error bit.....	141
Command Header.....	97
Commands.....	63
complement.....	74
Complementary Output.....	15, 80
complemented.....	35
complemented output.....	35
compound headers.....	64
Configuration.....	60
conflict.....	27, 28, 146
Control Menus.....	6
coupled.....	68
CPLD.....	68
CRTkeys.....	2, 7, 10, 59

D

DATA OUT OF RANGE.....	146
DBL.....	73
dead time.....	46, 47
DEADLOCKED.....	148
DEGC_CHG.....	98
DEL.....	73
Delay.....	4, 20, 21, 25, 36, 37, 41, 43, 45, 46, 47, 49, 51 73, 75, 76, 81, 84, 86, 87, 161, 167
delay offset.....	48
Device Dependent Error bit.....	148
Digit →.....	8
Digit select keys.....	8
DIS.....	13
DISA.....	74
Disable.....	3, 5, 13, 35, 36, 57, 74, 80
DISP.....	74
DISPLAY keys.....	6
Double Pulse.....	4, 26, 46, 49, 50, 73, 162
Double Pulse Interactions.....	46
duration.....	17
DUTY.....	75
Duty Cy.....	19, 20, 37, 45
Duty Cycle.....	19, 20, 21, 75, 162, 167

Index

E

ECL.....	32, 88, 90
ECL set.....	32
edge speed.....	21
enable.....	35
Enabling or Inverting.....	13
Enter/Hz.....	8, 9, 11
EOI.....	63, 64, 93
ERR.....	65, 99
ERR?.....	141
error queue.....	65, 99, 141, 148
ESR?.....	141
event status register.....	65, 92
Execute.....	3, 9, 10, 11, 50, 53, 55, 57
Execution Error bit.....	146
Ext Input.....	41, 42, 44, 45, 49, 50, 53, 57, 164, 167
Ext wid.....	48, 49
External Input.....	50, 169
External Width.....	26, 48, 51
External Width Mode.....	163

F

File <number> module mismatch.....	156
FINE.....	59
Freq.....	12, 26, 37, 51, 75
Frequency.....	75, 87, 163
front panel.....	151
Full Width, Half Max.....	18, 170
FWHM.....	18, 170

G

Gate.....	45, 51
Gate Mode.....	164
GPIB.....	12, 44, 59, 62, 63, 67

H

HARDWARE MISSING 147
 headers 64
 HI_Z 53
 Horizontal Position 20

I

Identification 93
 IEEE Std 488.2 63, 65, 141
 impedance 37
 In remote 154
 In remote with lockout 154
 INCORRECT MODULE TYPE 149
 information window 51
 Input Z 36, 53
 installation 1
 INTERRUPTED 147
 INV 70, 71, 76
 INVALID BLOCK DATA 145
 INVALID BLOCK DATA HEADER 145
 INVALID CHAR IN NUMBER 144
 INVALID CHARACTER DATA 144
 INVALID HEADER 143
 INVALID HEADER COMPOUNDING 143
 Invalid keypad entry 153
 Invalid numerical string 155
 INVALID PGM DATA SEP 142
 INVALID STRING DATA 145
 Invert 2, 13, 15, 17, 36, 159, 169
 INVert 70, 71, 76

K

key ignored 154
 Key Test 59

L

Lead 4, 21, 23, 24, 29, 32, 36, 37, 73, 75, 76, 81, 82, 86, 87, 164
 Leading edge 76
 Learn 93
 Level 36, 50
 LIM 77
 Limiting 32

Index

Limits	32, 36, 77
Line Feed.....	63
Line switch.....	1
Load Compensate	79
Load Compensation	31, 79, 165
LOADC	79
Loadcomp.....	30, 36
LOADComp	89, 90
LOCAL	12
Local Lockout	12
Local to remote occurred.....	155
LON	59
LVH.....	77
LVL	78

M

m/kHz	8
Main Circuit Breaker	1, 14
Mainframe.....	101
Manual	44
Manual trigger.....	51, 157, 167
MED.....	80
Median	17, 37, 70, 71, 77, 80, 165
memory.....	57
message	99
MISSING PARAM.....	142
MOD_ID.....	68
Mode.....	36, 41, 43, 59
Module	101
MODULE AUTO DISABLED	150
module ID	64, 68
MODULE IS TOO HOT TO ENABLE	150
module specific commands	64
More.....	55
MSG.....	99

N

n/GHz.....	8
negative voltage limit	78
No alternate format.....	152
NO ERROR	141
No field selected	154
Normal	43, 49, 51

NORMAL	73, 75, 76, 81, 82, 83, 84, 86, 87
Normal Mode	3, 165
Normal Output	80
NR3.....	63
NRf.....	63
numeric keypad	8, 9
NUMERIC OVERFLOW	144
Numeric Representation, flexible.....	63

O

On-Screen Operating Summary	6
On/Disable	14
Operation complete	94
Option	95
OPTIONS	106
OUT	80
Out lvl.....	52, 53
OUTB.....	80
OUTBar	80
Outer Ring Knob	2, 8
Outlvl.....	36
OUTPUT	3
output.....	35, 36, 74
Output Enable	80
Output Module	15, 41, 44
Output Pulse	17

P

parameter conflict	27, 28, 146
parameters	
Adjusting with the Numeric Keypad	8
Adjusting with the Rotary Knob	8
PER	67, 81
Period	2, 4, 12, 19, 20, 21, 26, 36, 37, 43, 45, 47, 49, 51
.....	164, 165, 166, 167
PERIOD	67, 73, 76, 81, 83, 84, 86, 87
PGM MNEM TOO LONG	143
PHA	82
Phase.....	20, 21, 37, 45, 82, 167
position	20
positive voltage limit.....	77
power.....	1, 2
POWER	14, 61
Presets.....	32

Index

Previous.....	9
program message.....	63
program message units.....	63
Pulse high level.....	89
pulse icon.....	3
Pulse low level.....	90

Q

QRY.....	67
queries.....	63
query.....	67
Query Error bit.....	147
QUERY INDEF QUERY.....	148
QUERY NOT ALLOWED.....	143
question mark.....	27
quiescent level.....	17, 159
quiescent state.....	13, 18

R

range select.....	8
re-trigger interval.....	46, 47
Recall.....	69
Recall Setup.....	3, 9, 35
Recalled file.....	156
Recalled previous.....	156
Recalled standard.....	155
Remote LED.....	12
Remote operation.....	63
repair.....	121
Reset.....	95
Resolution.....	21
response message.....	64
Return Authorization Number.....	121
Returned to local.....	155
Rotary Knob.....	8

S

Save.....	69
Screen Save.....	83
Screen Saver.....	60
Scrn Save.....	60

Index

SCRNSAVE	83
self calibration	58
Self-test	57, 70
service	121
Service Request	65
Service Request Enable	96
settings	9
SETTINGS CONFLICT	146
settings conflict	27, 28
settings default	36
setup	9
Single	44, 46
Single Mode	45, 167
Slew	23, 24, 37
Slew Rate	23, 70, 89, 90, 168
Slew rate, leading edge	83
Slew rate, trailing edge	84
SLEW_L	70, 83, 89, 90
SLEW_T	70, 84, 89, 90
slope	23, 36, 48, 50, 168
specifications	
9211	107
9212	111
9214	118
Standard	3, 9, 35
Standard Event Status Enable	92
Standard Event Status Register	141, 146, 147, 148
status byte	65, 96
Step too large	153
Store Setup	9
SYNTAX ERROR	142

T

Tch Test	59
Temp Comp	61, 62
TEMPC	85
Temperature Compensation	60, 85, 168
TER	100
termination	34
TEST	59
tolerance	33
TOO MANY COMMANDS FOR HASH TABLE	149
TOO MANY DIGITS	144

Index

TOO MANY EVENTS	141
TOO MANY HASH TBL COLLISIONS	149
TOO MANY PARAMS	142
TOO MUCH DATA	147
TOUCH	85
Touch Screen	60, 61
Touch screen enable	85
TouchCRT	2, 61
Trail.....	4, 21, 23, 24, 29, 32, 36, 37, 46, 168
TRAIL.....	75, 76, 86
Trailing edge	86
transition time	4, 18, 21, 32, 35
trigger.....	44, 69
TRIGGER	6
trigger button.....	51
Trigger control menu	6
Trigger input impedance.....	86
Trigger is too fast.....	156
Trigger Level.....	50, 87, 164, 169
trigger mode	43, 49, 87, 165
Trigger Modes	4, 41, 20, 26
Trigger Output	20, 25, 41, 43, 44, 45, 46, 47, 48, 49, 52, 53, 88, 167
Trigger Output Voltage	88
trigger parameter menu	6, 42, 52
Trigger Slope	50, 57, 89, 164, 169
trigger threshold.....	5, 50
TRIGGER TOO FAST	51
TRIM	86
TRLV.....	87
TRMD	87
TROV.....	88
TROV_SET.....	88
TRSL.....	89
True Output	15
TTL	32, 88, 90
TTL set	32
U	
u/MHz	8
UNDEFINED HEADER.....	143
unit/entry keys.....	8
UNTERMINATED	147
Utilities and Features Menu	6

Index

V

vernier knob	3
Vhigh.....	3
Vlow	3
vernier.....	8
vertical formats	17
Vhigh.....	169
Vlow	169
Vhigh.....	15, 17, 32, 36, 37
Vlow	15, 17, 32, 36, 37
Vmax	36
Vmin.....	36
voltage	15

W

Wait	97
Warmup.....	106
WID.....	67, 91
WIDTH.....	2, 4, 17, 18, 19, 20, 25, 36, 37, 43, 44, 45, 46, 47, 49, 51
.....	67, 73, 75, 76, 81, 82, 84, 86, 87, 91, 164, 165, 167, 170
