



Hands-On Guide

**LeCROY DIGITAL OSCILLOSCOPES
9300 SERIES**



LeCroy

Innovators in Instrumentation



LeCroy

Corporate Headquarters

700 Chestnut Ridge Road
Chestnut Ridge, NY 10977-6499
Tel: (914) 578-6020, Fax: 578-5985

European Headquarters

Mannheimerstrasse 175
D-69123 Heidelberg, Germany
Tel: (49) 6221 82700
Fax: (49) 6221 833827

European Manufacturing

2, rue du Pré-de-la-Fontaine
P.O. Box 341
1217 Meyrin 1/Geneva, Switzerland
Tel: (41) 22 719 21 11, Fax: 22 782 39 15

Copyright © March 1996, LeCroy. All rights reserved. Information in this publication supersedes all earlier versions. Specifications subject to change.



**LeCROY DIGITAL OSCILLOSCOPES
9300 SERIES**

Revision A — March 1996





LeCroy

Corporate Headquarters

700 Chestnut Ridge Road
Chestnut Ridge, NY 10977-6499
Tel: (914) 578-6020, Fax: 578-5985

European Headquarters

Mannheimerstrasse 175
D-69123 Heidelberg, Germany
Tel: (49) 6221 82700
Fax: (49) 6221 833827

European Manufacturing

2, rue du Pré-de-la-Fontaine
P.O. Box 341
1217 Meyrin 1/Geneva, Switzerland
Tel: (41) 22 719 21 11, Fax: 22 782 39 15

Copyright © March 1996, LeCroy. All rights reserved. Information in this publication supersedes all earlier versions. Specifications subject to change.

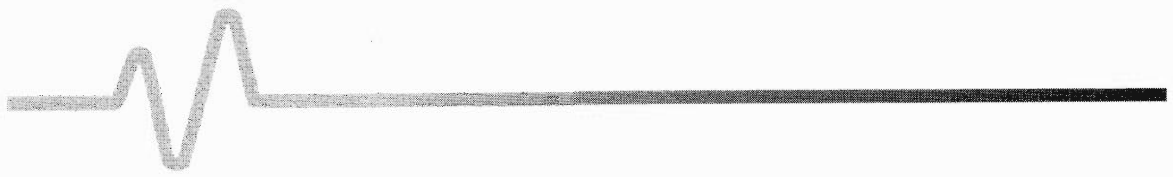

Hands-On Guide

to the LeCroy

9300-Series

Oscilloscope

All About the DSO

Getting Started

Sharpening Your Measuring Skills

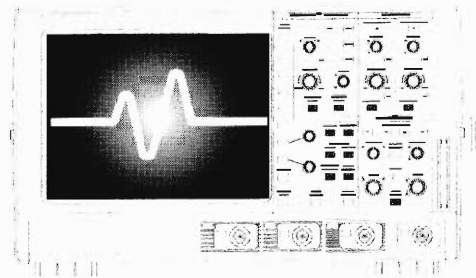

Table of Contents

Behind the Screen

A foreword to the guide and a word on LeCroy's philosophy. vii

Part 1 All About the DSO

A broad overview of the Digital Storage Oscilloscope, zooming on the 9300 Series.

Primary Specifications	1-2
Bandwidth	1-3
Sample Rate	1-3
Memory Length.....	1-4
Capturing	1-5
Acquisition Technique	1-5
Analog-Digital Conversion.....	1-6
Number of Channels.....	1-6
Triggering	1-6
Viewing	1-7
Measuring	1-8
Pulse Parameters	1-8
Waveform Math	1-8
Analyzing	1-9
Time Domain.....	1-9
Frequency Domain	1-9
Statistical Domain	1-10
Documenting	1-10
Removable Hard Disk Drive (HDD)	1-11
Interfaces.....	1-11

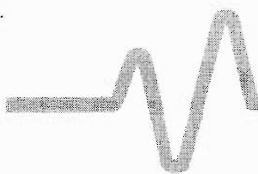

Part 2 Getting Started

An illustrated tour of the scope, then 'hands-on' for a run through its basic functions.

Front-Panel Controls	2-2
Installation Check	2-4
Initialization	2-4
Waveform Acquisition	2-7
TRACE ON/OFF.....	2-8
TIMEBASE Controls.....	2-9
Vertical Controls.....	2-10
TRIGGER Controls.....	2-11
ZOOM	2-12
CURSORS/MEASURE	2-14
Waveform Parameters	2-16
Summed Averaging.....	2-17
FAST FOURIER TRANSFORM (FFT).....	2-19
Waveform Storage.....	2-20
Setup Save and Recall.....	2-22

Table of Contents

Part 3 Sharpening Your Measuring Skills

Performing the most common measurements using the 9300-Series scope, in a series of easy-to-follow, step-by-step tutorials.

First Steps in Measuring.....3-2

The basic steps for setting up practically any measurement.

Digitizing with All Eight Bits3-6

How to set up the scope for digitizing on all eight bits.

Characterizing a Pulse.....3-9

Parameter measurement and statistical values made easy.

Accurate Measuring with Cursors3-16

Ensure accurate measurements.

Using Average to Remove Noise3-26

Reduce non-systematic noise and improve the signal-to-noise ratio.

Picturing Signal History.....3-31

Reveal the FM modulation of a sinewave.

Cutting Deadtime Between Events3-37

For a choice of single-shot waveform segments without deadtime.

The Scope as Spectrum Analyzer.....3-47

Perform signal power distribution as a function of frequency.

Precision Analysis with Histograms.....3-54

Use the WPO3 option to display and calculate signal jitter.

Interpolation = More Information.....3-71

Process acquisitions of a few sample points.

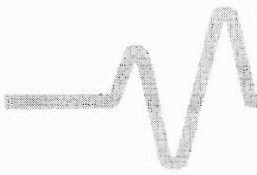

Testing Against a Telecom Mask	3-80
<i>Telecom-measure pulse-shaped signals to industry standards.</i>	
Storing to Removable Hard Disk.....	3-93
<i>The portable PC Card hard disk drive (HDD) simplifies storage.</i>	
Calculating on Long Waveforms.....	3-98
<i>Handle longer FFTs and multiple long-waveform zoom, math and storage.</i>	
SMART Glitch-Capturing	3-111
<i>Find and capture glitches with the SMART Trigger.</i>	
Capturing Rare Phenomena	3-119
<i>Use the SMART Trigger to increase knowledge of rare waveforms.</i>	
Triggering on Lost Signals.....	3-128
<i>Ideal for detecting interruptions in data streams.</i>	
Transferring Data to PC	3-134
<i>By GPIB, floppy or RS232 communication port.</i>	
Transferring Images to PC	3-141
<i>Copy screen TIFFs and BMPs to computer.</i>	

Behind the Screen...

Behind the screen of a 9300-Series oscilloscope there is not only the best and latest in digital technology, but a philosophy based on the continuous advancement of that technology.

At LeCroy, innovative thinking has led to award-winning design. Over the past ten years, LeCroy has been recognized throughout the world as a leader in the Test & Measurement industry, with eight IR-100 (R&D 100) Product Awards, *Test & Measurement Magazine's* Best In Test Award, a Top Ten Technology Award from *Laser & Optronics* and a Product of the Year Award from *Design News*.

Our engineers not only develop the most innovative technology, they strive to find new measurement solutions that meet your industry needs. Designing test & measurement instruments is our primary business. Thus our research and development efforts are focused on delivering the powerful and accurate tools you require to perform your design and research work most effectively — helping to increase productivity and reduce product-to-market cycle for a greater competitive advantage.

Innovative product design has enabled LeCroy to set the industry standard for DSO (Digital Storage Oscilloscope) memory length four times and sample rates twice. We designed the world's fastest and most powerful digital scopes and the first truly easy-to-use arbitrary waveform generator. Our screen sizes are up to 50% larger — allowing you to display signal details more accurately and evaluate the results more easily. New product features and options allow you to capture, view, measure, analyze and document signals with more ease and power — a real help for meeting ISO 9000 quality standards.

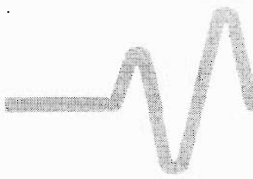

In the same spirit, this guide has been designed as a helping hand to both the beginner and the experienced user of DSOs. It can be opened anywhere and used — according to knowledge, needs and experience — to aid you in getting the most out of the scope.

Part 1 — All About the DSO — introduces digital oscilloscopes and how they function, including data sampling, triggering, recording, how sampling rate affects usable bandwidth and long memory improves sampling rate. Also covered are analysis functions such as standard parameters, frequency analysis (FFT) and statistical analysis (histograms). This is the full *scope* — in the broadest sense of the word!

Part 2 — Getting Started — ‘physically’ shows you around the scope and teaches, step-by-step, how to capture waveforms and perform simple measurements. You will get to know the instrument and start working with it quickly and effectively.

Part 3 — Sharpening Your Measuring Skills — describes systematically and, again, step-by-step how to make important measurements with maximum efficiency, providing detailed descriptions of how to use many of the scope’s advanced functions.

Hands on to explore a new, digital universe.

Reader's Comments

What Do You Think?



When you have finished reading this guide, LeCroy would be grateful for your advice on how to improve it. Help us by responding to the questions below with a tick or cross in the scope, and returning the completed form to the address on the reverse side of this page. To mail, fold and fasten. Or fax to: Marketing: ++41 22 782 39 15 (Switzerland).

Thank you in advance!

In general, how effective is the guide?



Very Effective



Effective



Fair



Poor

How accurate are its contents?



Very Accurate



Accurate



Fairly Accurate



Wrong

How complete?



Very Complete

Incomplete



Complete



Fairly Complete



Are its format and illustrations clear?



Very Clear



Clear



Fairly Clear



Unclear

Have you discovered any errors in the guide? If so, please specify each error and the number of the page on which it is to be found. Any other comments?

Name Date

Organization

Address

..... Country



BUSINESS REPLY MAIL
FIRST CLASS PERMIT NO. 164 SPRING VALLEY, NY

Postage will be paid by addressee:

NO POSTAGE
NECESSARY
IF MAILED
IN THE
UNITED STATES



LeCroy Corporation
ITI Division
700 Chestnut Ridge Road
Chestnut Ridge, NY 10977 - 9913



All About the DSO

Why and how is the Digital Storage Oscilloscope useful? What are the many ways in which it can be put to work for you?

In this introductory Part 1 of the guide, we give an overview of this subject of vast 'scope'. You will get a good idea — if you haven't one already — of the rich and varied digital landscape. And where to find and mine those riches.

You will then be more than ready to go on to handle the scope itself in Part 2, **Getting Started**.

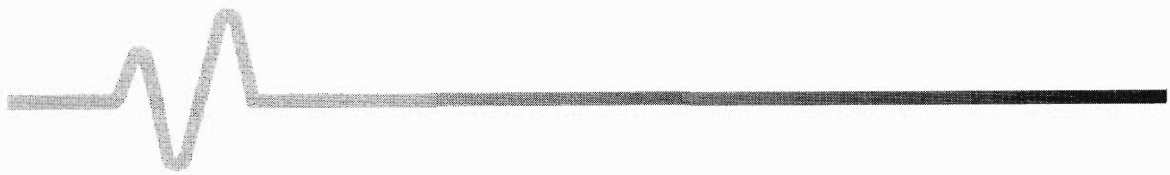

Primary Specifications

Digital storage oscilloscopes are the essential instrument for capturing, viewing, measuring, analyzing and storing electronic signals.

DSOs can be divided in three broad categories: top-end models with a bandwidth of around 400 MHz or more — suitable for R&D-type work; 100–200 MHz models — for professional and general purposes; and sub-100 MHz, low-cost scopes — for work on low-frequency signals.

The basic elements of a DSO are shown in the diagram on the facing page. They are: the **amplifier**, which amplifies the input signal so that it can be measured by the oscilloscope; the **analog-to-digital converter (ADC)**, which converts the analog signal into digital form by translating it into a series of sample points that are then measured and transformed into digital codes representing the signal samples; the **acquisition memory system**, which stores the resulting digital data; the **system memory** of up to 64 MB; the **processor**, which controls the entire system and performs special monitoring and measurement functions; and the **display system**, which translates the stored data into a graphic display of the original signal shape.

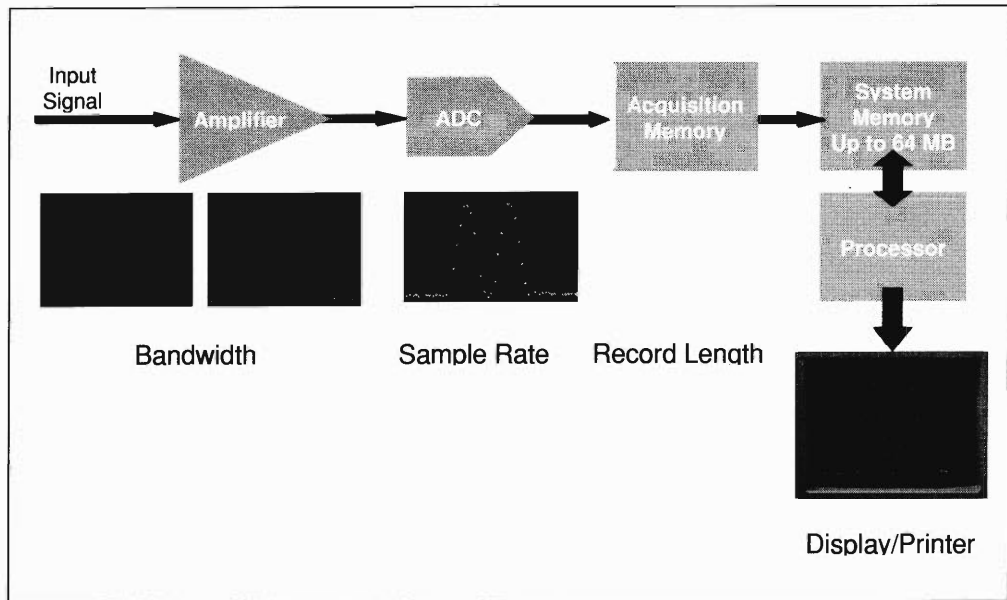

The character of your signals determines the primary specifications of the DSO you will use. Its secondary specifications are determined by the demands of your applications. In assessing the overall signal representation quality of a digital oscilloscope, particular consideration needs to be given to the cardinal parameters of **bandwidth, sample rate, and acquisition memory length.**

Bandwidth

The bandwidth specification of a DSO indicates the ability of its front-end amplifier to faithfully track an incoming signal. The DSO's bandwidth is defined as the frequency at which a sinusoidal input signal has been attenuated to about 70% of its real amplitude. This point, at which the vertical amplitude error is about 30%, is called the **-3db point**. It is generally advisable to use an instrument whose bandwidth is five times greater than the highest frequency component of the signal to be studied, in order to have better than 2% measurement accuracy.

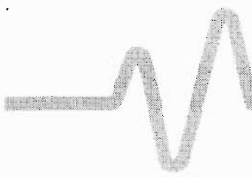

Sample Rate

The higher the sample rate the better the signal resolution. This is particularly important for single-shot waveform capture and measurement. The danger with low sample rates is that important information may be lost between samples. Accurate waveform capture requires a sample rate that is at least five times the bandwidth of the signal to be captured. For repetitive signals the sample rate is a less critical factor, as the signal can be captured over many cycles.

Memory Length

Acquisition memory length determines the number of input signal samples that can be stored. The greater the capacity for stored samples, the faster the possible sample rate for a given waveform duration — the signal captured with a long-memory DSO has a greater resolution. For short-memory DSOs, the high sample rates quoted are only available at a few fast time-base settings. Long-memory DSOs allow operation at the highest possible sample, over many more time-base settings.

How Are DSO Useful?

The DSO can perform the same operations as an analog oscilloscope — and much more, including:

Capture

Capture of one-off (single-shot) events and their storage in memory;

Capture and Display

Capture of very slow signals while the data stays on-screen;

View and Record

View of events before triggering, so that an event's cause and effect can be recorded;

Analysis

Analysis of signals, providing precise measurement results;

Documentation and Data Transfer

Documentation of signals and the transfer of the data via storage media to PC, or direct to printing by internal or external printer, or to plotter.

The instrument's fidelity in reconstructing the input signal is mainly affected by these three parameters (though by others, too). The bandwidth must be sufficient to allow all the signal components to pass through the signal-conditioning system. The sample rate has to be sufficient to provide a good definition of the signal. Long memory maintains the sample rate for large time windows. And the DC gain accuracy of the instrument must guarantee the correct signal amplitude.

Capturing

In addition to the primary specifications described above, the capture techniques, the trigger system, the number of channels, the probes available and the ADC specification all impact the usability and performance of a DSO.

Acquisition Technique

Single-shot acquisition is the DSO's basic acquisition technique, which makes the instrument very suitable for the study of signal phenomena that have a low-repetition rate, or that are not repeated at all — hence *single-shot*. The timebase sweeps only once, on receipt of a trigger signal, and the input data signal is captured into acquisition memory for viewing, measurement and analysis.

The DSO can also employ a technique called **Random Interleaved Sampling (RIS)** to increase its effective sampling rate in viewing repetitive signals. The maximum rate is 10 giga-samples per second on LeCroy's 9300-Series high-performance model.

For signals slower than 0.5 second per division, there exists the **Roll Mode**, where the signal being acquired can be displayed in real time while being captured in memory — it scrolls from left to right as if on a strip chart recorder.

Because digital scopes acquire input signals by sampling, they can miss glitches at the lower sample rates. But LeCroy's **Peak Detect System** captures glitches occurring between these samples. When



the system is activated, the scope samples at a very fast rate, continuously checking for glitches using a built-in algorithm. Meanwhile, it displays information in accordance with the sweep rate actually set. When a glitch is detected, the scope will display it as a thin spike on the displayed waveform. For a better look, the zoom feature may then be used to expand the glitch horizontally and vertically.

Another of the 9300-Series scope's methods for acquiring signals is the **Sequence Mode**, which captures multiple signals separated by long dead periods. When triggered in this mode, the scope grabs a pre-programmed number of samples, resets its trigger, and awaits another event. The resulting waveform is a splicing together of all the waveforms acquired. This, in effect, eliminates the information-poor deadtime that would appear between signals if the scope were triggered by the first event and then continued to run.

Analog-Digital Conversion

High-speed digital oscilloscope performance is made possible by advanced analog-digital converters (ADCs), whose vertical resolution guarantees a clear representation of the signal. The ADC measures the voltage level at evenly spaced intervals and stores the digitized value in high-speed dedicated memory. The shorter the intervals, the faster the digitizing rate, and the higher the signal frequency that can be recorded. The higher the resolution of the ADC, the better the sensitivity to small voltage changes; the more memory — the longer the recording time.

Number of Channels

The LeCroy 9300-Series DSO has either two or four channels. In addition, it possesses an external trigger channel and a CAL BNC output connector. The CAL BNC can be used as the source of a calibration signal, an output pulse on the occurrence of each trigger, or an output pulse signaling a **Pass/Fail** condition.

Triggering

The power of a DSO in any given application depends on a combination of several of its features, and particularly the ability to trigger on the event of interest.

Important is the flexibility and sophistication of the trigger. In order to capture rare phenomena such as glitches or spikes, logic states, missing bits, timing jitter, microprocessor crashes, network hang-ups

or bus contention problems, a trigger system far more sophisticated than that found in conventional oscilloscopes is needed.

Some companies put their 'best' trigger design into their more expensive scopes and use a less adequate trigger in lower-bandwidth, lower-priced scopes. But LeCroy believes all scope users at every bandwidth want both a simple standard edge trigger and the power of a **SMART Trigger** for capturing elusive events.

For the 9300 Series, a push-button control switches between the standard edge and SMART triggers. The user has available a variety of sophisticated trigger modes based on two important facilities. First, the ability to preset the logic state of the trigger sources

CH 1, CH 2, CH 3, CH 4, EXT, and EXT/10. And secondly, a counter that can be preset and used to count a number of events between 1 and 10^9 , or to measure time intervals from 2.5 ns–20 s in steps of 1% of the time scale.

Combined, these twin capabilities open the door to such a large variety of trigger conditions that the oscilloscope might be expected to become cumbersome and difficult to use. However, great care has been taken by LeCroy designers in making the SMART Trigger mode user-friendly without loss of versatility. On-screen, special trigger graphics illustrate the trigger conditions for every trigger mode, and these icons are shown below the on-screen grid. There is a **Single-Source Trigger with Hold-Off, Width Triggers (plus Glitch)**, a **Pattern Trigger**, a **Dropout Trigger**, **State-Qualified** and **Edge-Qualified Triggers**, and a **TV Trigger**.

Viewing

LeCroy offers the DSO industry's largest (9 inch diagonal) high-resolution display (810 x 696 pixels), which supports up to four grids and quad-zoom features. The screen shows internal status and measurement results, as well as operational, measurement, and waveform analysis menus. Hard copy of the screen is available at the press of a front-panel screen-dump button.

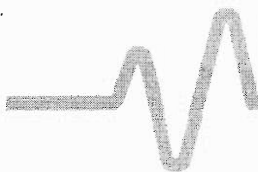

Multiple waveforms can be viewed on separate grids, ensuring the best utilization of the ADC dynamic range. XY and variable persistence displays are also provided, as is **Enhanced Resolution Mode**.

A wide range of processing functions can be performed. Four traces — A, B, C and D — are available for zooming exclusively or together with waveform mathematics. The horizontal expansion can be as large as 100 000 times — greatly improving the time resolution on the viewed trace. Several traces can be zoomed onto the same waveform for precise timing measurements.

Measuring

Measuring signal characteristics and analyzing circuit performance is at the heart of test engineering. LeCroy's parameter measurements and statistics allow worst-case analysis of circuit performance. Most DSOs can measure parameters, but it can be a time-consuming chore analyzing the parameter statistics. These tools make the job much faster.

Pulse Parameters

Cursor readouts allow a user to use the full resolution of the ADC to measure absolute and relative times and amplitudes on a waveform.

However, most users commonly measure the same waveform parameters. These include risetime, falltime, pulse width, overshoot, undershoot, peak voltage, peak-to-peak voltage, maximum, minimum, standard deviation, rms value, frequency, and period. All of these and many more are available with the 9300-Series.

Waveform Math

Waveform math allows the display of final answers, rather than raw data. For example, inputs from voltage and current transformers can be multiplied together to display power. An important feature of the LeCroy scopes is their ability to 'daisy-chain' math functions — a power trace can be integrated to display energy, for instance.

Analyzing

One of the great advantages of digitizing is data-analyzing capacity. Once the digitizer has converted the analog signal into digital data, either the internal digitizer processor or an external computer can analyze the data. Most current digitizers have a wide spectrum of built-in analysis. Consider some of what is available with the LeCroy scopes:

Time Domain

The optional time domain waveform analysis package includes zooming, summed averaging of up to one million sweeps, derivatives, logarithm, square root, absolute value, ratio, six digital filters and standard arithmetic operations. The zoom feature may also expand the waveform by up to 100 000 times on high-performance models.

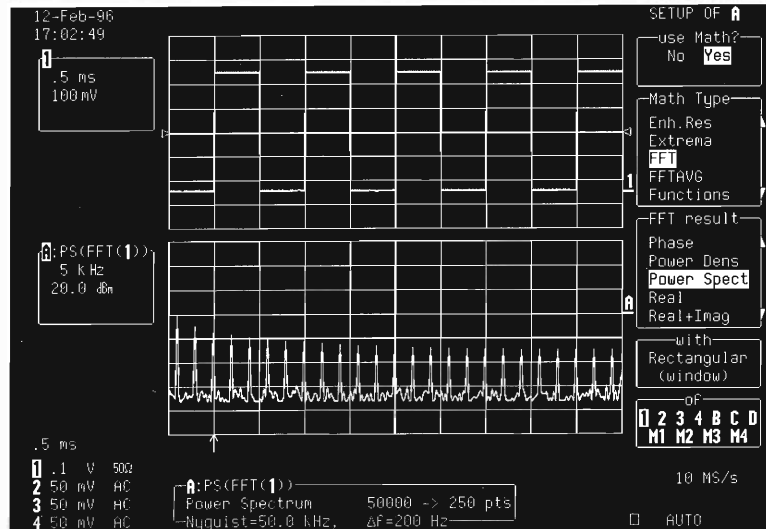

Frequency Domain

Spectrum analysis on a 9300-Series scope greatly extends its processing power. There are two clear advantages over **FFT (Fast Fourier Transform)** analyzers: higher frequency components, and the ability to monitor both time and frequency information. Fourier transform converts sampled waveform information into a unique set

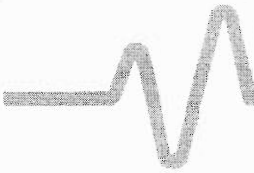

of sine wave components. The data is usually plotted as frequency vs amplitude. Two algorithms are common: the DFT (Discrete Fourier Transform) and FFT. The latter is more practical because it is many times faster calculating. It can expose information not easily visible in the time domain (time vs amplitude). Ideally, it can be used for such analyses as measuring frequency components of communication signals and monitoring drift in an oscillator. The frequency resolution of an FFT is directly proportional to the number of time-domain points the FFT algorithm can handle. Some other-brand scopes have 500 000 points, but their FFT algorithm can accept only 10 000. They have less than 1% the resolution of a LeCroy scope that can perform six-million point FFTs.

Statistical Domain

The existence of measured waveforms in digital representations permits convenient use of the data inherent in those measurements. As well as analysis of signals in the frequency domain and the ability to perform mathematical operations and signal averaging on data, trends can be determined and histograms of the data analyzed.

The **histogram** is a graph of the number of occurrences of a measured parameter. For example, in measuring the risetime of a repetitive signal for which all the measurements were equal, the histogram would be a straight vertical line without breadth. However, variations in the risetimes create a plot with some horizontal structure, implying variations in the measurements. The 9300-Series scope not only creates such histograms, but also allows measurement of their characteristics. This is extremely useful when analyzing pulse amplitudes, widths or timing jitter.

Other analysis techniques available with the LeCroy scopes include **Pass/Fail** testing, **Mask Comparison** testing, **EYE-diagram analysis for telecommunications**, and specialized testing for magnetic media applications (**disk drive measurements** and **Partial Response Maximum Likelihood (PRML)** testing).

Documenting

Storage and recording functions are key requirements in many test applications. The 9300-Series scopes produce excellent output — both in the form of digital data and hard-copy records — to support the user's documentation requirements.

Removable HDD

Many scopes can save files in TIFF format for importing into PCs and other computers. Thanks to technical advances and the advent of the PCMCIA standard for peripheral devices, there is a handy piece of new hardware available for the scopes — the **portable HDD (Hard Disk Drive)**. These PCMCIA Type III devices can be popped in and out of LeCroy scopes or computers with much of the ease of a floppy. However, they are much faster and have a capacity of more than 100 MB. Test data can be processed far more quickly inside a DSO and saved on the scope's internal hard drive than by transfer via GPIB link to computer.

The 512 kB PC/Memory card and built-in disk drive for floppy can also be used to store waveforms and screen shots. The built-in thermal printer is extremely convenient and surprisingly quick to produce a screen output plot. The serial port may also be used to connect a plotter, or the scope can output to a printer through the unit's parallel port.

Interfaces

The 9300-Series oscilloscope can be remote controlled through its IEEE-488 or RS-232 ports. As well as storage, printing and transfer to memory devices, the scope offers push-button transfer of waveforms and settings to the LW series of arbitrary waveform generators. This enables a reference waveform — for example — to be captured from a known good device and used as a test stimulus applied to other devices.

Parts 2 and 3 of the guide, which follow, demonstrate how to use these powerful tools in practice.

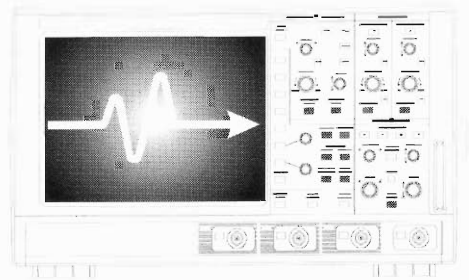

Getting Started

Part 2 of the guide shows the scope's main features and, step-by-step, how to use them. You will get to know the instrument and start working with it quickly and effectively.

After completing these simple steps, you will be ready to go on to Part 3, **Sharpening Your Measuring Skills**, and to connect your own signals to the scope for test and measurement.

Remember, for complete details on all features of your LeCroy 9300-Series oscilloscope, see the accompanying *Operator's Manual*.

Front-Panel Controls

The main controls and where to find them.

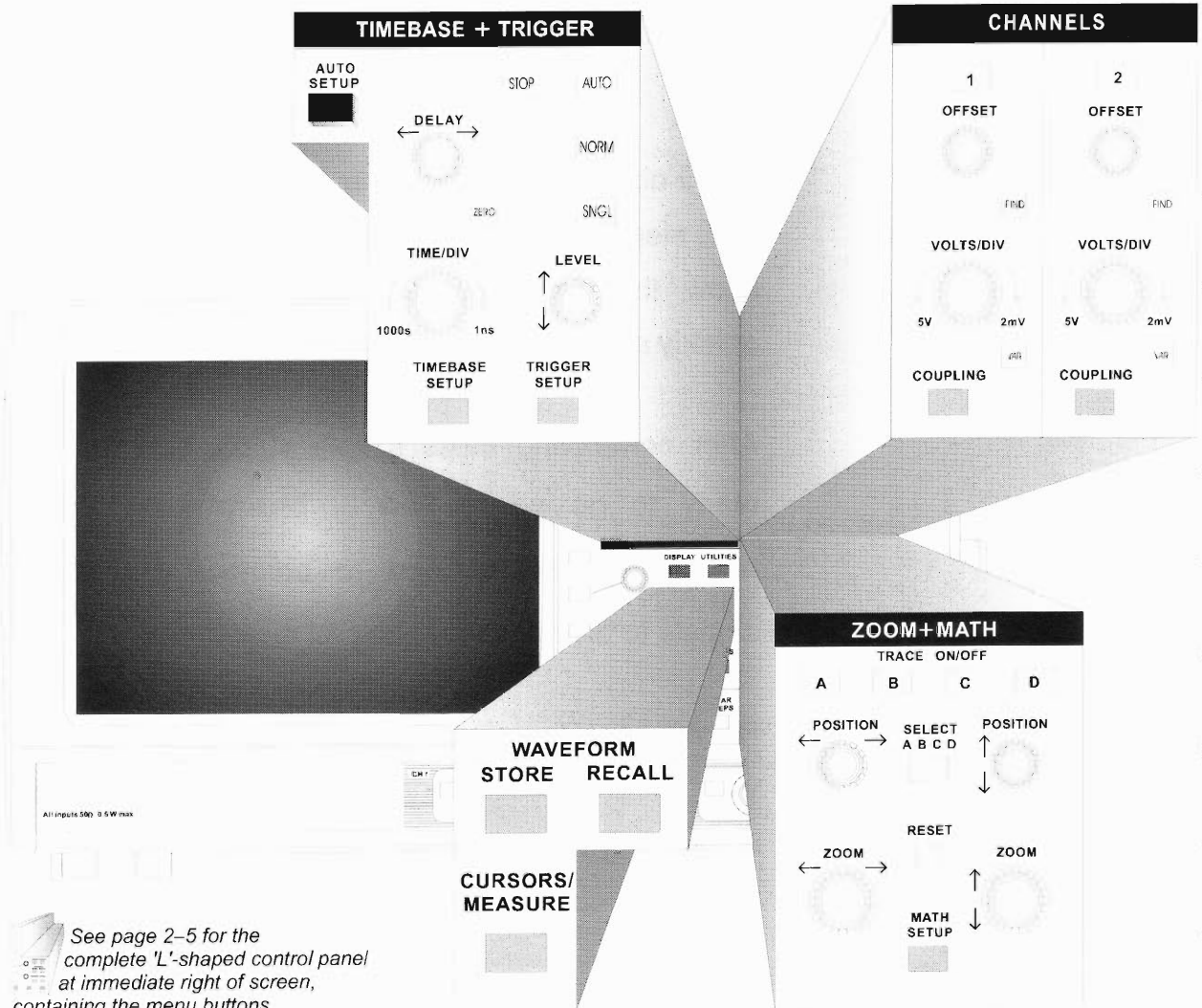

See page 2-5 for the complete 'L'-shaped control panel at immediate right of screen, containing the menu buttons.

AUTO SETUP

acquires and displays repetitive signals in less than two seconds.

TIMEBASE + TRIGGER

includes the trigger mode, level and position selection, and **TIME/DIV** control.

CHANNELS

turns the input channels on and off, and controls the **OFFSET** and the vertical sensitivity for input channels.

The **VAR** button, also on this control panel, gives variable, fully calibrated sensitivity throughout the scope's range.

ZOOM + MATH

allows the selected trace to be moved and expanded or have a mathematical operation applied. This may involve expansion of, or math operation on, any of the oscilloscope's channels or other Zoom/Math functions.

WAVEFORM STORE and RECALL

buttons enable data to be stored on removable hard disk, floppy or memory card, or all three of these mass storage options. Data can also be stored or recalled from the DSO's four internal memories

CURSORS/MEASURE

button gives access to a wide range of cursor and automatic measurements, and to **PASS/FAIL** testing.

Memory-Card Reader

Waveforms or instrument setups can be stored on Industry-Standard SRAM cards, offering easy data transfer to PC.

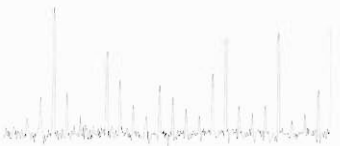

High-Resolution Display

One, two or four waveform grids can be shown, giving maximum clarity.



Installation Check

Important!

The oscilloscope operates from any AC power source of 90–250V, 50 or 60 Hz.

Before powering up, check that the local power source corresponds to the scope's range.

After verifying this, use the cable provided to connect to the power.

Switch on using the rocker switch on the rear panel.

Before a display appears, the instrument will perform hardware and software self-tests, followed by a full system calibration, all lasting less than 15 seconds.

Initialization

To initialize the scope to its default settings so that the screen displays are similar to those shown on the following pages:

PANEL
SETUPS

First, press  on the 'L'-shaped control panel, illustrated on the facing page.

Getting Started

Note: When a word or number is highlighted on-screen, front-panel controls will apply to the function, action or trace represented.

Each menu button in the column of buttons running down beside the screen corresponds to the menu box immediately next to it.

A column of menu boxes similar to the one shown here will appear on the right-hand side of the screen. Either 'Recall' or 'Save' will be highlighted in the top-most box.

Press the top menu  button and select 'Recall'.

Now press the FROM DEFAULT SETUP' menu  button.

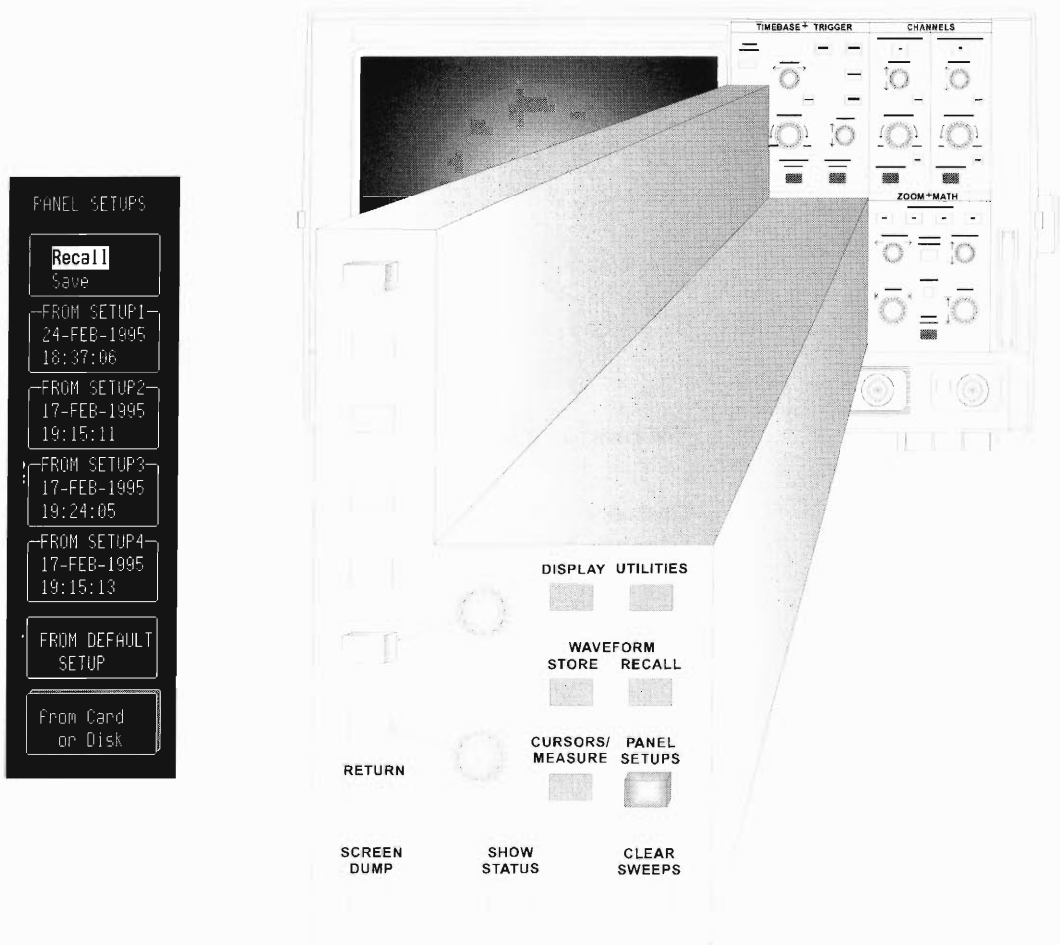

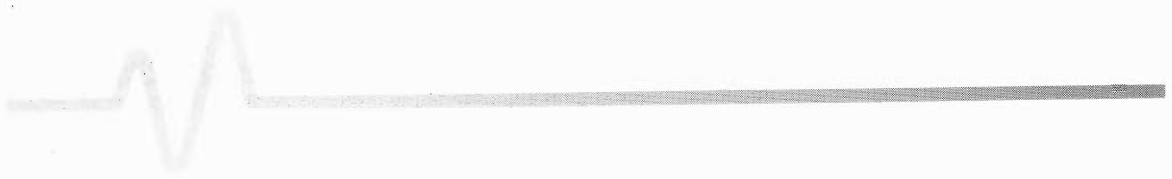

With the scope initialized, we are ready to explore some of its basic functions.

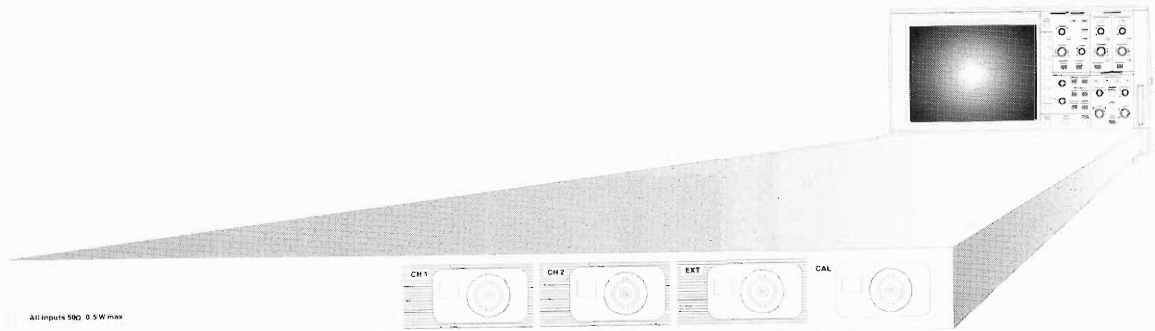

But first...

We need a signal!

Connect a BNC cable from the CAL output at right to the Channel 1 (CH 1) BNC input at left.

We can now go on to acquire and display waveforms.

Waveform Acquisition

Note: Auto Setup is a useful feature that facilitates the display of a wide range of repetitive signals, including those with duty cycles as small as 0.1%.

Press the blue  button on the TIMEBASE + TRIGGER control panel.

This will automatically set the trigger-level, timebase and vertical settings needed for displaying the input signal.

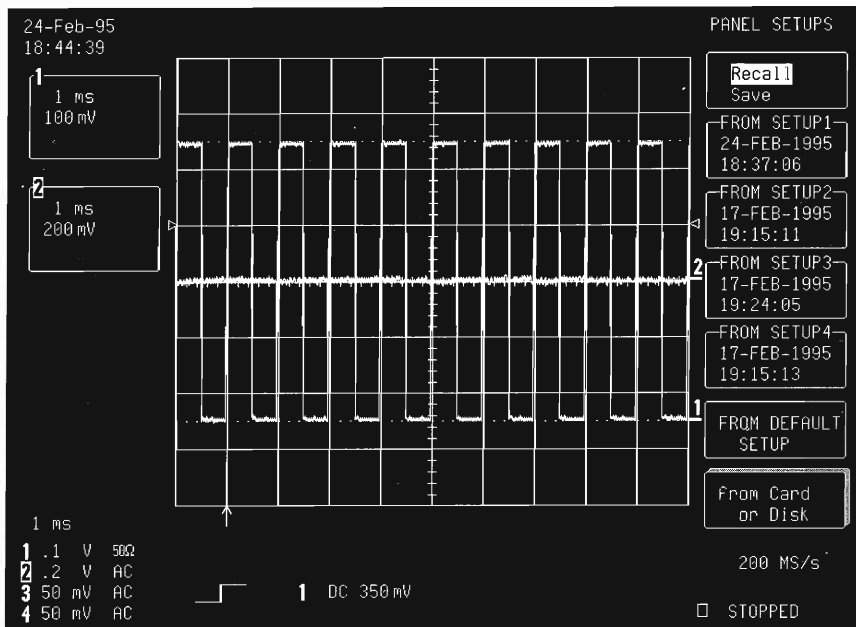

The screen will show a 1 kHz square wave. Both Channel 1 (the square wave) and Channel 2 (the horizontal line) are displayed.

The time (here, 1 ms) and volts (200 mV) per division of the channels are shown in the **trace labels**, at top-left of screen.

TRACE ON/OFF

To switch off a channel — Channel 2 in this example:

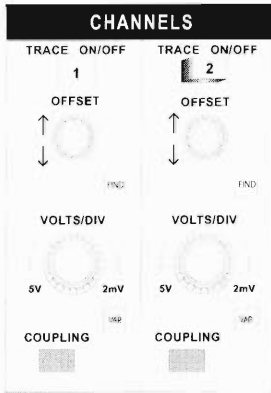

TRACE ON/OFF

Press the corresponding **2** button, located on the CHANNELS control panel.

Four-channel models: For reasons of simplification, the illustration at left shows the control-panel layout for a two-channel oscilloscope. Precisely the same action applies on four-channel models, whose channel controls are illustrated and described on *page 2-10*.

This action removes both the trace and its label from the screen.

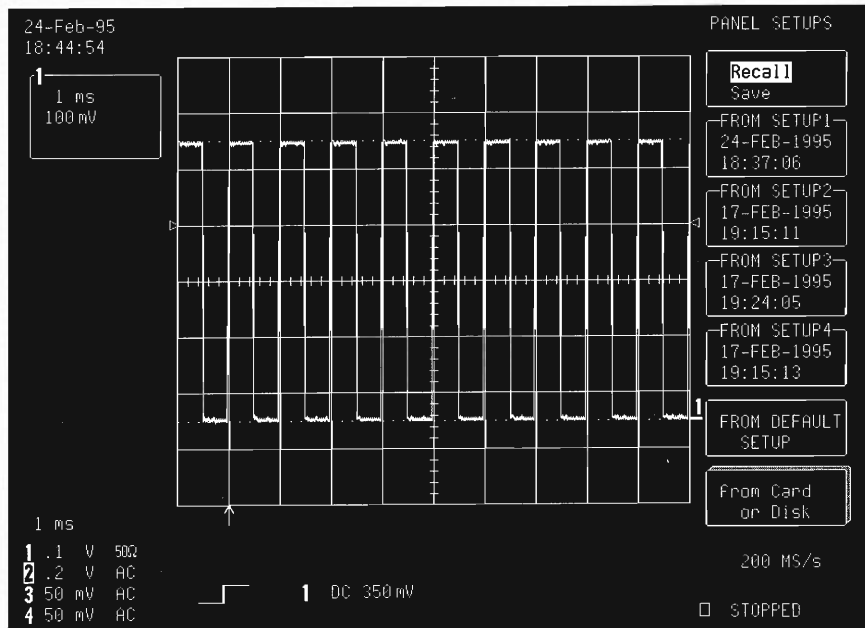

TIMEBASE Controls

Use the  knob to adjust the timebase.

The selected time/division setting is shown on the lower left-hand side of the screen — 1 ms in the example shown.

To capture the signal for a shorter period:

Now try changing the setting to 0.2 ms/div.

However, reset it to 1 ms/div for the remainder of these exercises.

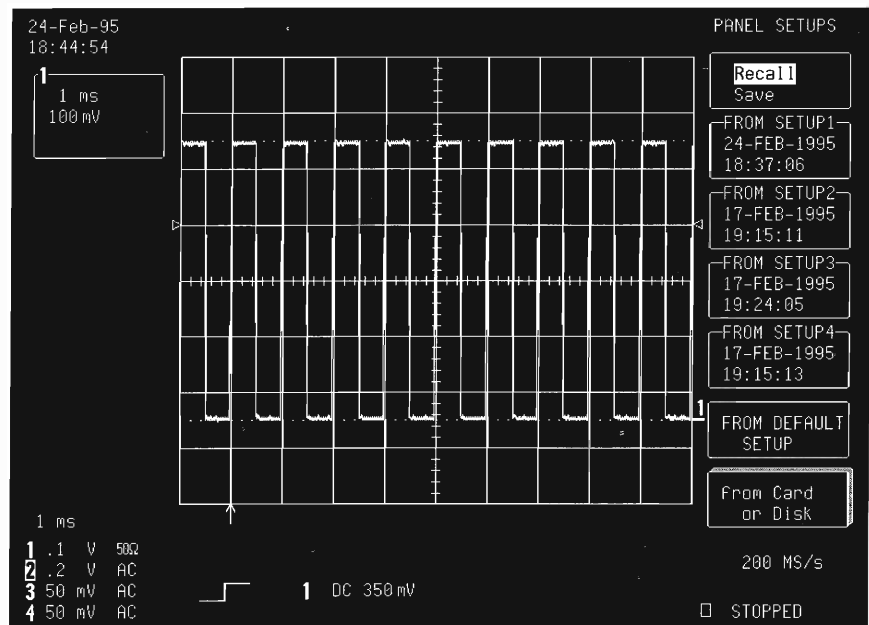

Vertical Controls

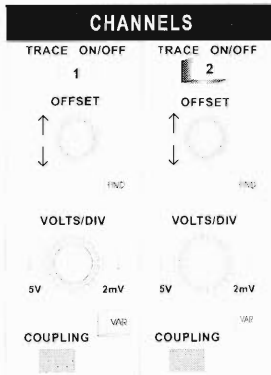

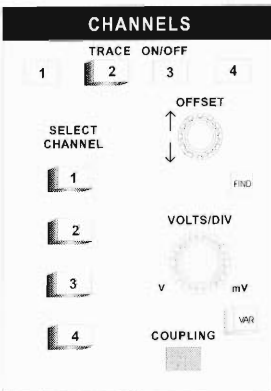

Two-channel models (above)

Four-channel models (below)



The VOLTS/DIV controls give a vertical gain selection of 2 mV–5 V/div, operating in a 1–2–5 sequence.

To reduce the sensitivity — here on Channel 1 — **Turn**  **and set the gain to 100 mV/div.** The selected volts/div setting is shown in the Channel 1 trace label.

To fine-tune the vertical gain: **Press the corresponding**  **button.**

Turn Channel 1  **through several complete rotations, so that the entire signal reaches from top to bottom of the grid.**

The volts/div setting still shows in the trace label



Filling the grid in this way ensures that the signal uses the full range of digitizing levels available — 8 bits = 256 levels — for the best vertical resolution.

To return the vertical gain to its 1–2–5 sequence: **Press**  **again.**

The  knob controls the vertical position of the acquired trace.

Note the  label marking the ground level for Channel 1, next to the menu boxes, *as shown on the screen on page 2–9.*

Turn on  **to see that this channel, too, has a trace label. Turn off Channel 2 by pressing the same button again.**

Four-channel models: When more than one trace is displayed on the screen, the number of the selected trace is highlighted on its respective trace label. The vertical controls — including VOLTS/DIV, OFFSET and COUPLING — will operate for this trace only. To choose another trace, press the appropriate SELECT CHANNEL button, to which the controls will then apply.

TRIGGER Controls



The TRIGGER  knob adjusts the trigger's horizontal position.

This position can be adjusted from 0% to 100% pre-trigger — from left- to right-hand edge of the grid.

The  can also be used for setting the post trigger in seconds up to 10 000 divisions.

The trigger position is shown by  the small arrow at the bottom of the grid.

The TRIGGER  knob adjusts the trigger's vertical threshold.

Arrows on either side  of the grid  indicate the threshold position. These arrows are only visible if the trigger source is one of the traces on the screen, and then only if that trace input is DC-coupled.

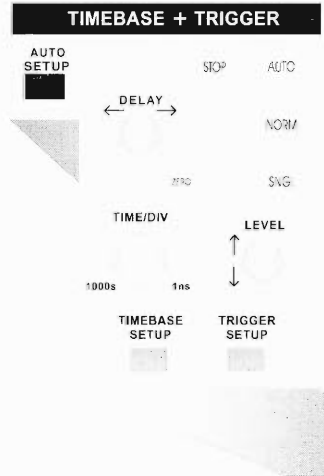

Note: The knobs described above and shown here at right (those of smaller size on the control panels) are acceleration-sensitive. The faster their rotation, the greater the increments.

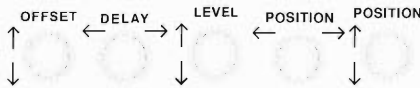

ZOOM

To expand — or 'zoom-in' on — a small section of the trace and see it in more detail:

Press 

Note: The ZOOM function is an important benefit of the scope's acquisition memory. It can also be considered as an additional timebase providing alternative sweep speeds.

Then press the corresponding menu  for the 'Grids' menu and select 'Dual'.

Now two grids are shown on the screen, giving optimum viewing of the expanded trace.

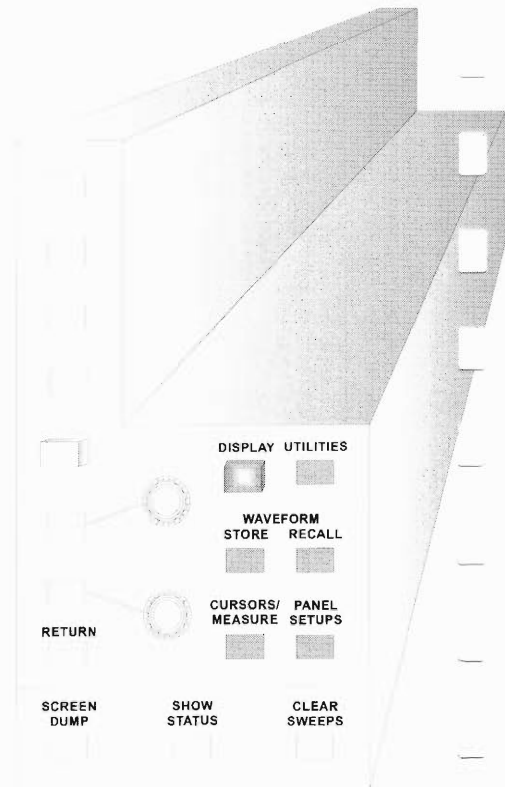
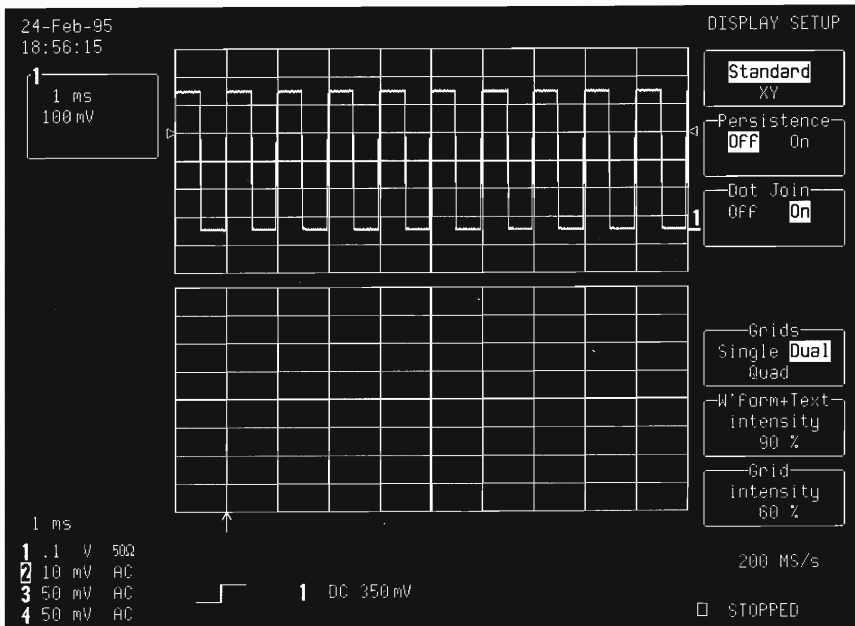

Now, press **A** to turn on Trace A.

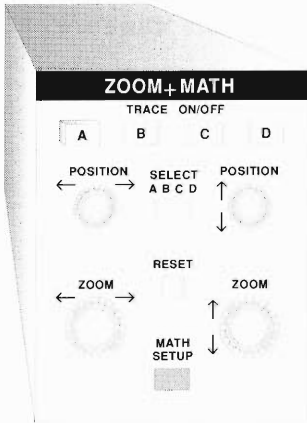

Turn Vertical  to move Trace A to the lower grid.

Turn Horizontal  to adjust the expansion factor and increase the amount of zoom or magnification.

Turn Horizontal  to move the magnified part of the upper trace.

Turn Vertical  to magnify vertically.

Note that the intensified part of the upper trace shows the section of the original waveform being viewed by the zoom.

Vertical and Horizontal settings for the zoomed waveform are shown here at right in the 'A' trace label.

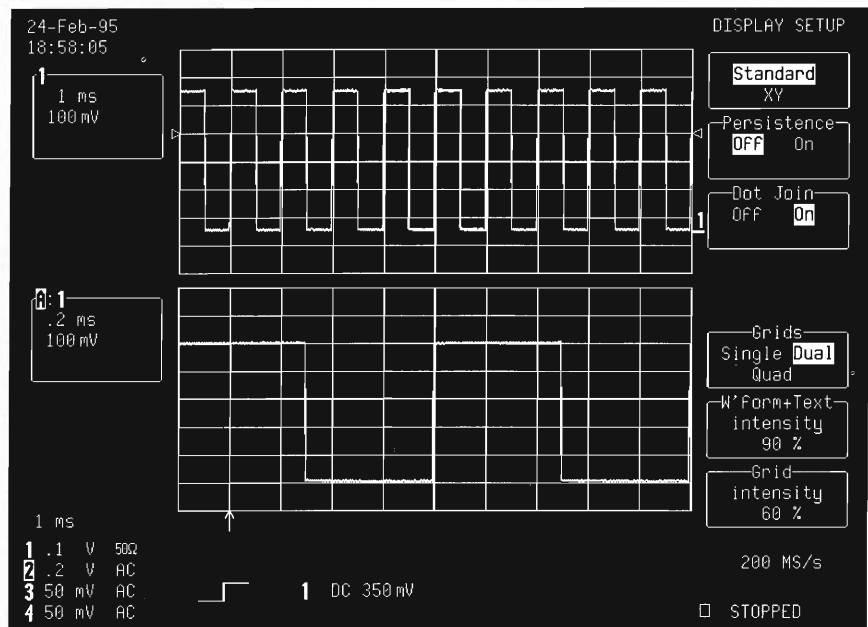

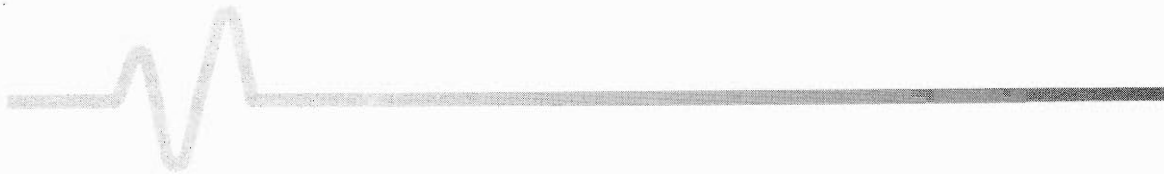

CURSORS/MEASURE

CURSORS/
MEASURE

Press 

Then use the respective menu s to select: **'Cursors'**, **'Time'** and **'Absolute'**.

Remember, the button(s) or knob for each menu is located immediately beside the screen menu box to which it relates.

Note: Use cursors to make fast, accurate measurements and eliminate guesswork.

Next, use the **'cursor position'**  knob to move the **cursor**, which shows as the cross-hair on the waveform. As the cursor moves, its time value in relation to the trigger point is shown at bottom of screen (1.485 ms), while its voltage value is shown in the trace label at top left of screen (379.8 mV).

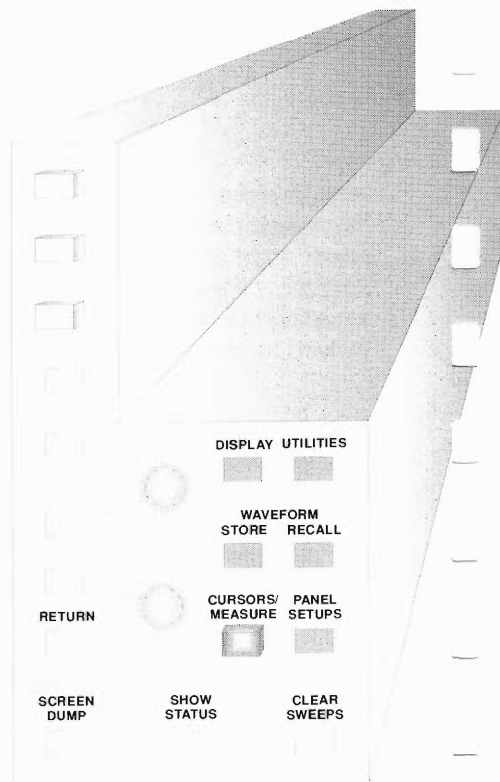
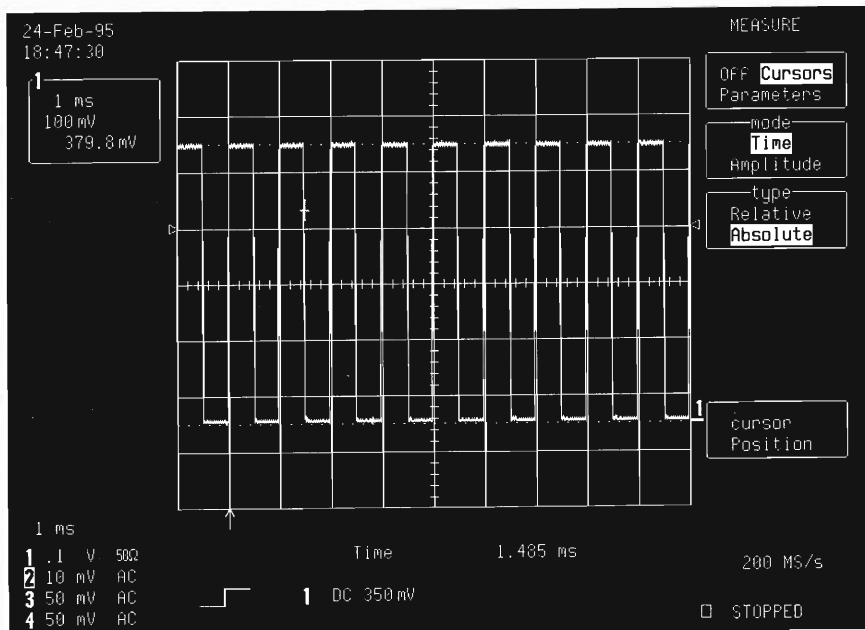

Getting Started

Press the corresponding menu to change the selection from 'Absolute' to 'Relative'.

Now *two* cursor menus are available, operated by the respective knobs:

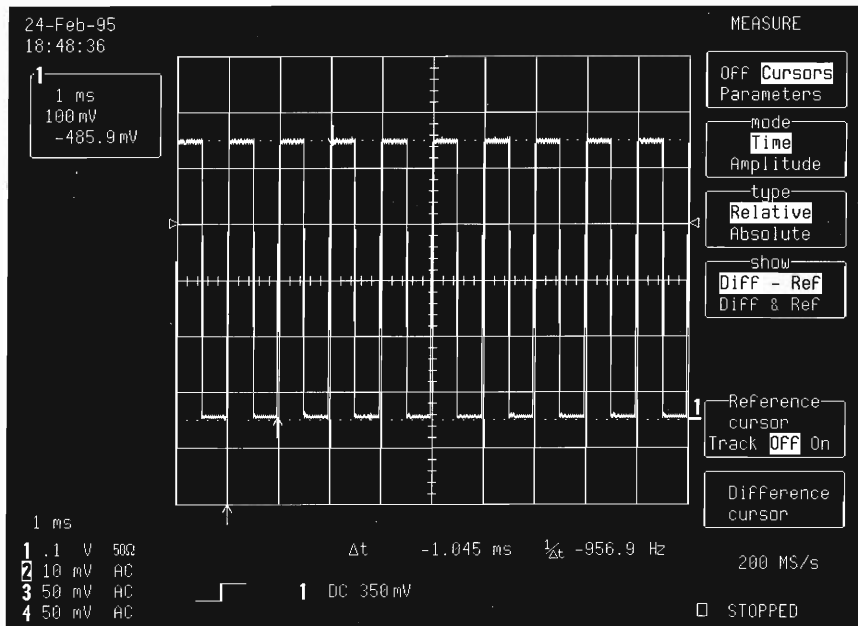

And now shown below the grid is the relative time and the voltage difference between the two cursors.

Waveform Parameters

Note: The scope's capacities go beyond cursor measurements to calculate useful pulse parameters — automatically and with high precision. This saves time, as cursors need not be positioned manually, nor do time and voltage values need to be estimated.

Press the top menu  to select 'Parameters'.

Appearing on-screen below the grid is a list of five different voltage parameters.

Press the corresponding menu  s to select from the 'mode' menu 'Std Voltage' and, next, 'Std Time'.

The list of voltage parameters on-screen will be changed by these selections. The parameters are computed each time the trace is updated.

From the 'statistics' menu: Press the corresponding menu  to select 'On'. You will now see the average lowest and highest values of each parameter and the standard deviation of the distribution of measurements

To return to normal operation: Press the top menu  to select 'Off'.

The 'statistics' menu is very useful for tracking drift or other changes in signal behavior.

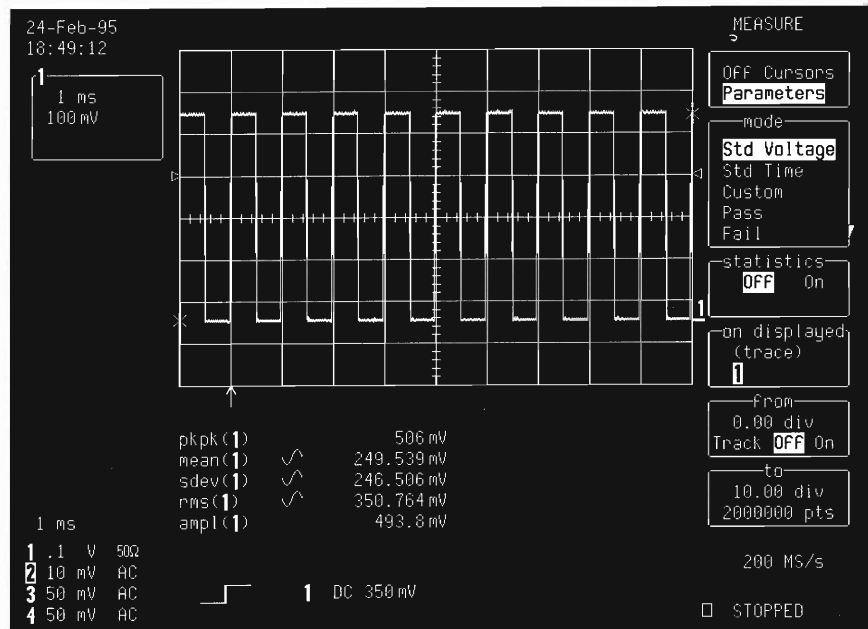

Summed Averaging

Use the Summed Averaging function to improve the vertical resolution of repetitive signals, or to average out unwanted noise on a live signal.

Press **A** to turn off Trace A and the ZOOM function.

Press **C** to turn on Trace C for the Summed Averaging function.

Now press **MATH SETUP**

The column of menu boxes shown below will appear on-screen.

Press the corresponding menu box to select 'REDEFINE C'.

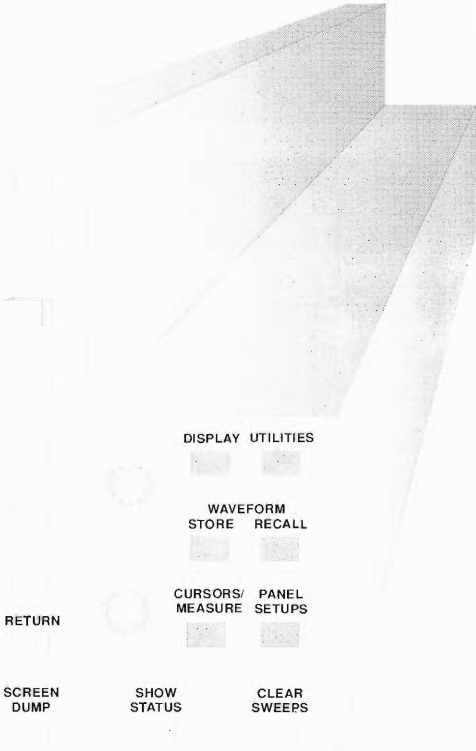
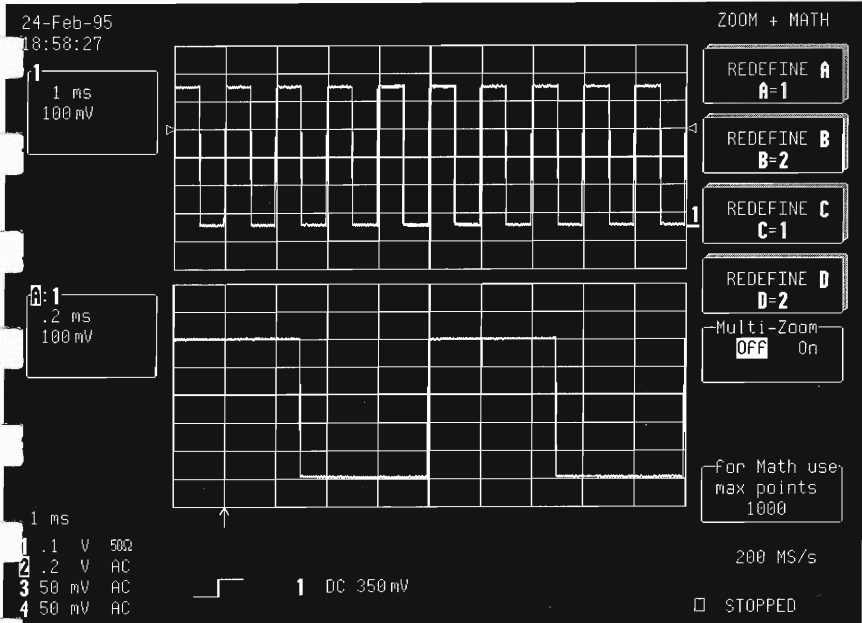
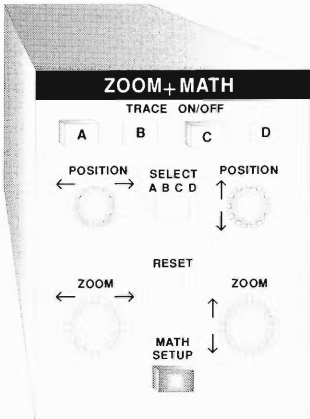

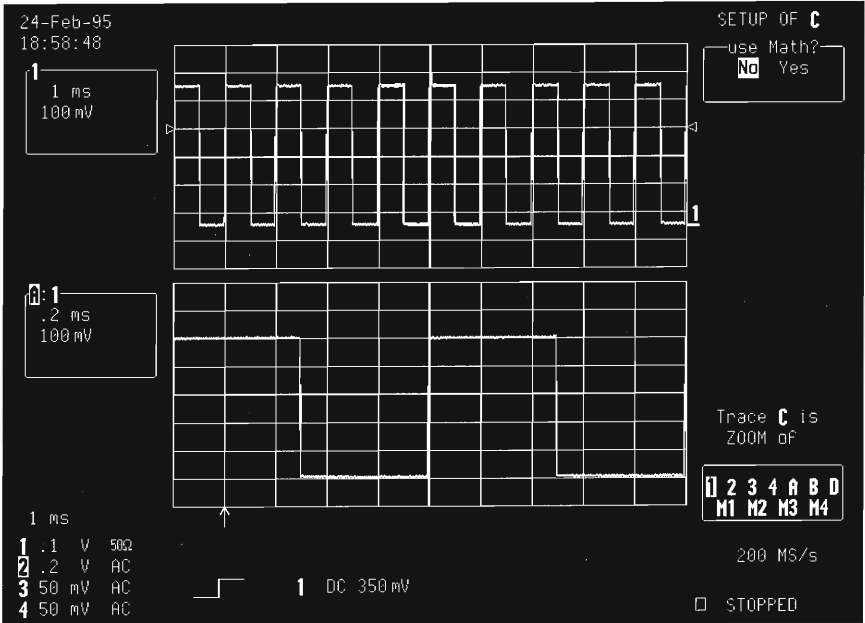

Press the top menu to select 'Yes' from the 'use Math?' menu.

The screen will change to display the menus shown below.

Now use the corresponding menu to select 'Average' from the 'Math Type' menu.

The scope may allow various types of averaging (see the 'Avg Type' menu) depending on its configuration.

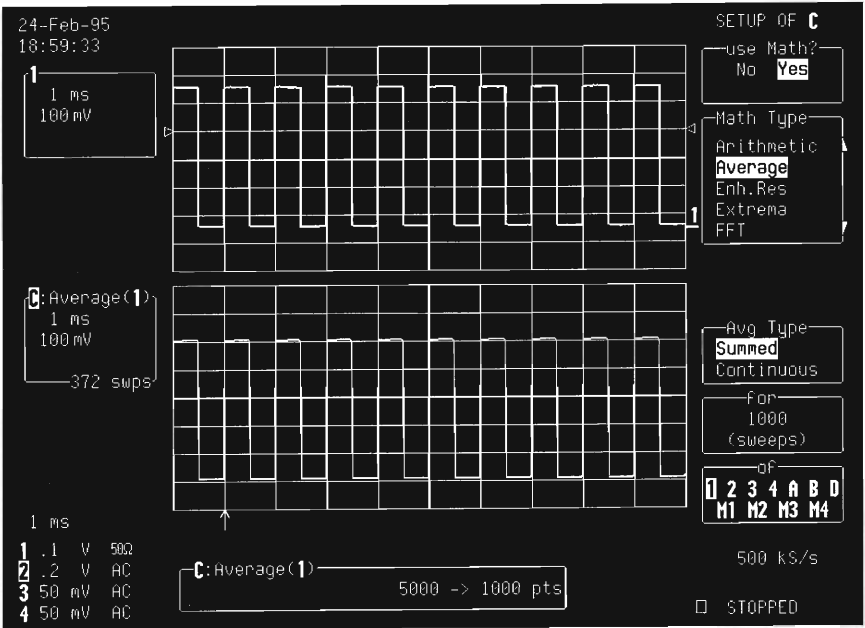

Turn to move Trace C — the averaging function — to the lower grid.

Press and use the respective menu to select 'Cursors', 'Absolute' and 'Horizontal'.

Turn to place the absolute horizontal cursor on the lower trace.

Note the measurement resolution's increase compared with the live trace.

FFT — FAST FOURIER TRANSFORM

Note: FFT allows acquired waveforms to be converted into frequency-domain traces, revealing valuable spectral information that would otherwise be impossible to detect on a time-domain record.

MATH SETUP
Press  again.

Press the corresponding menu  to select 'REDEFINE C'.

Press the respective menu  s to make the selections highlighted on-screen below.

The lower trace now shows the FFT transform of the square wave on Channel 1.

Now use the absolute horizontal cursor to make a frequency measurement...

Note: The STOP button can be used as here to improve all-round cursor and knob response.

But first, press 

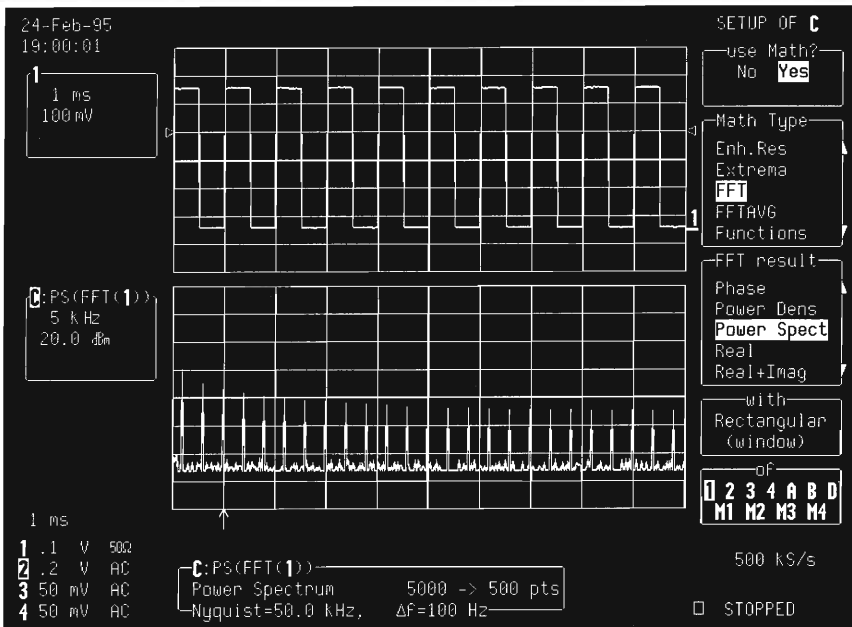
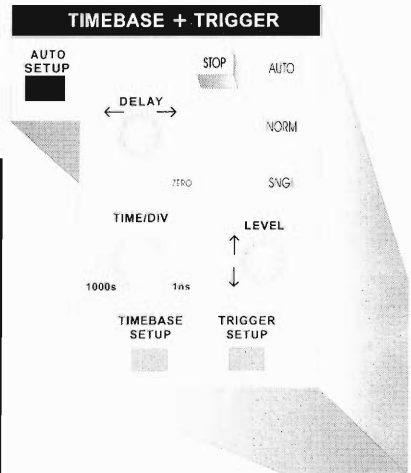

Next, press 

Then press the corresponding  to select 'Absolute' from the 'type' menu.

Move the cursor to the right of the upper trace until it reaches the FFT trace.

Note that the readings are now labeled in Hz (horizontal) and dBm (vertical).

The first frequency component at left of screen should be the square wave's fundamental frequency (1 kHz). The following components (3 kHz, 5 kHz, 7 kHz...) are the harmonics that contribute to building the square wave.

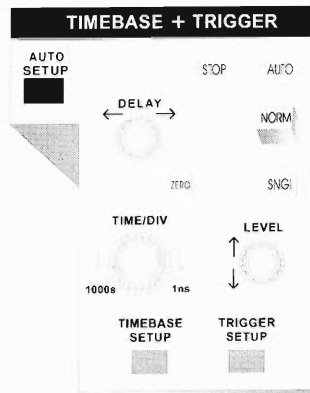

Now press  to return to normal triggering.

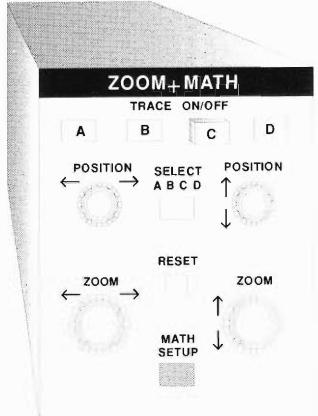

Waveform Storage

Note: Waveform memories allow the temporary saving of waveforms for later comparison or analysis — an important benefit of digital oscilloscopes.

The scope has four waveform memories: **M1, M2, M3 and M4.**

In this example, the waveform will be stored in **M2.**

Press  to turn off Trace C and the FFT.

Waveform Storage (continued)

Note: For large menus, two menu buttons can normally be used for traveling up or down a list. Knobs can also be used. As many as four waveforms can be saved and stored until overwritten by other waves or the scope is switched off. Trace A displays the waveform saved in M2, which can then be repositioned and expanded using the ZOOM controls.



Press WAVEFORM  STORE

Press either of the corresponding menu  s to select '1' from the 'store' menu, as indicated on the screen below.

Press the corresponding menu  to select 'M2' from the 'to' menu.

Then press the corresponding menu  for 'DO STORE'.

To display the stored trace: Press WAVEFORM  RECALL

Then press the corresponding menu  to select 'M2' from the 'from Memory' menu and the  for 'DO RECALL'.

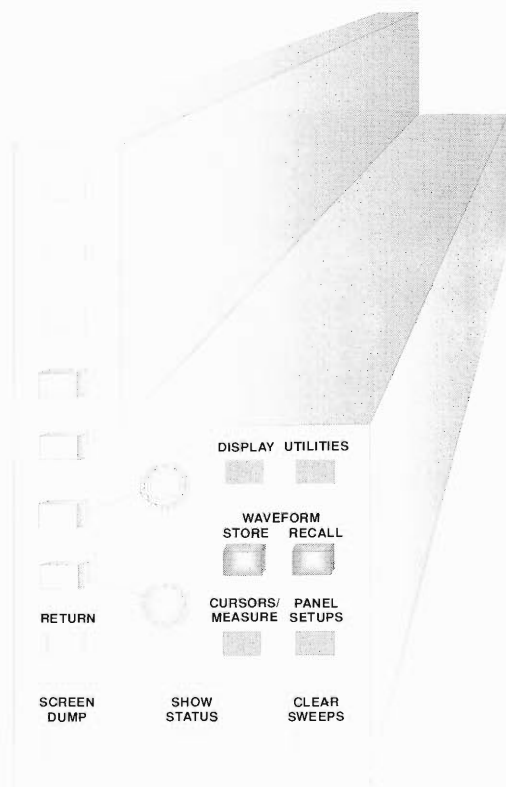
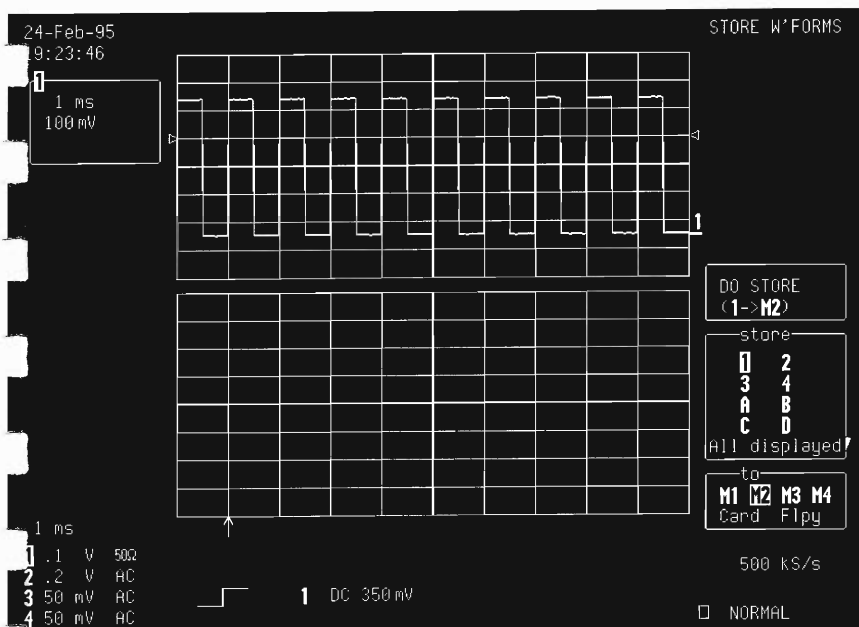

Setup Save and Recall

Note: Entire panel setups can be saved and stored in non-volatile internal memory for later recall — setups of often performed measurements, for example. Up to four setups can be stored in this way. However, with the optional DOS-compatible memory card, floppy or removable hard disk, thousands of setups can be stored. Note also that the time and date of storage will be shown.

PANEL
SETUPS



Press

Press the top menu  to select 'Save'.

Press the corresponding menu  for 'TO SETUP 1'.

As an exercise, randomly change Channel 1 and the Timebase.



Then recall the original settings:

Press the top menu  to select 'Recall'.

Finally, press the corresponding menu  for 'FROM SETUP 1'.

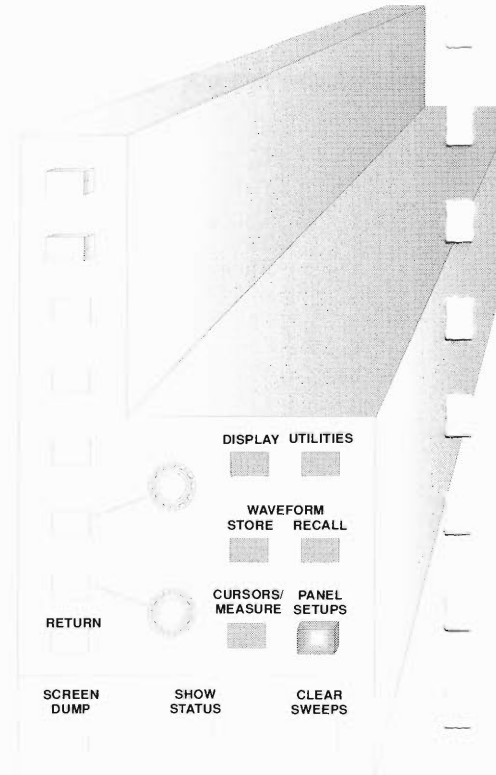
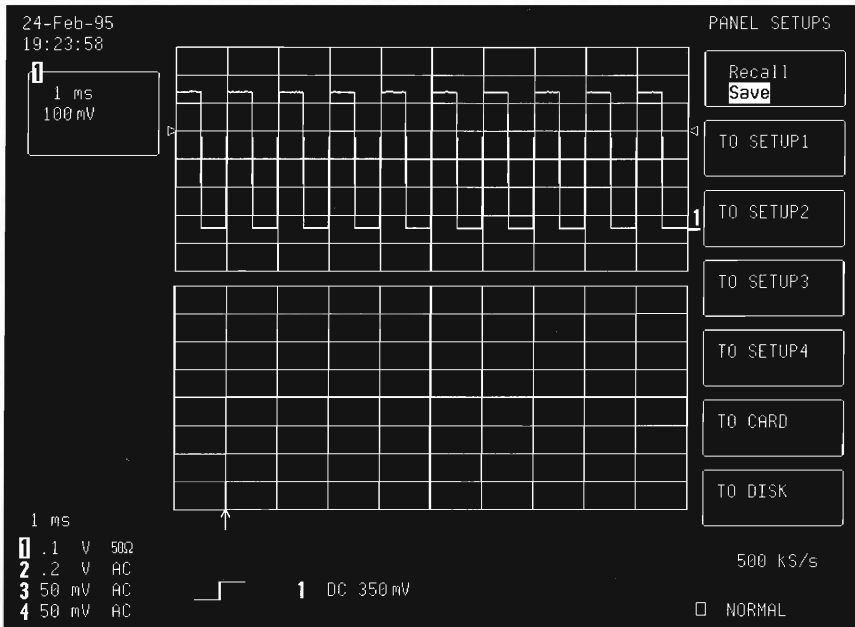

A Good Start ...

You have briefly used the oscilloscope to perform a number of basic but important functions.

You are by now familiar with the main controls — where they are and what they do. You have acquired, displayed, measured, processed and stored a waveform. And learned how to save and recall panel setups.

You have made a good start. Part 3 of the guide that follows explains how to use some of the scope's many powerful features in performing measurements. Connect your own signals and discover more.

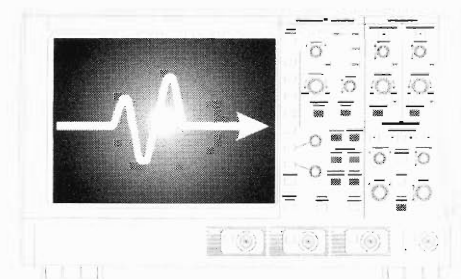

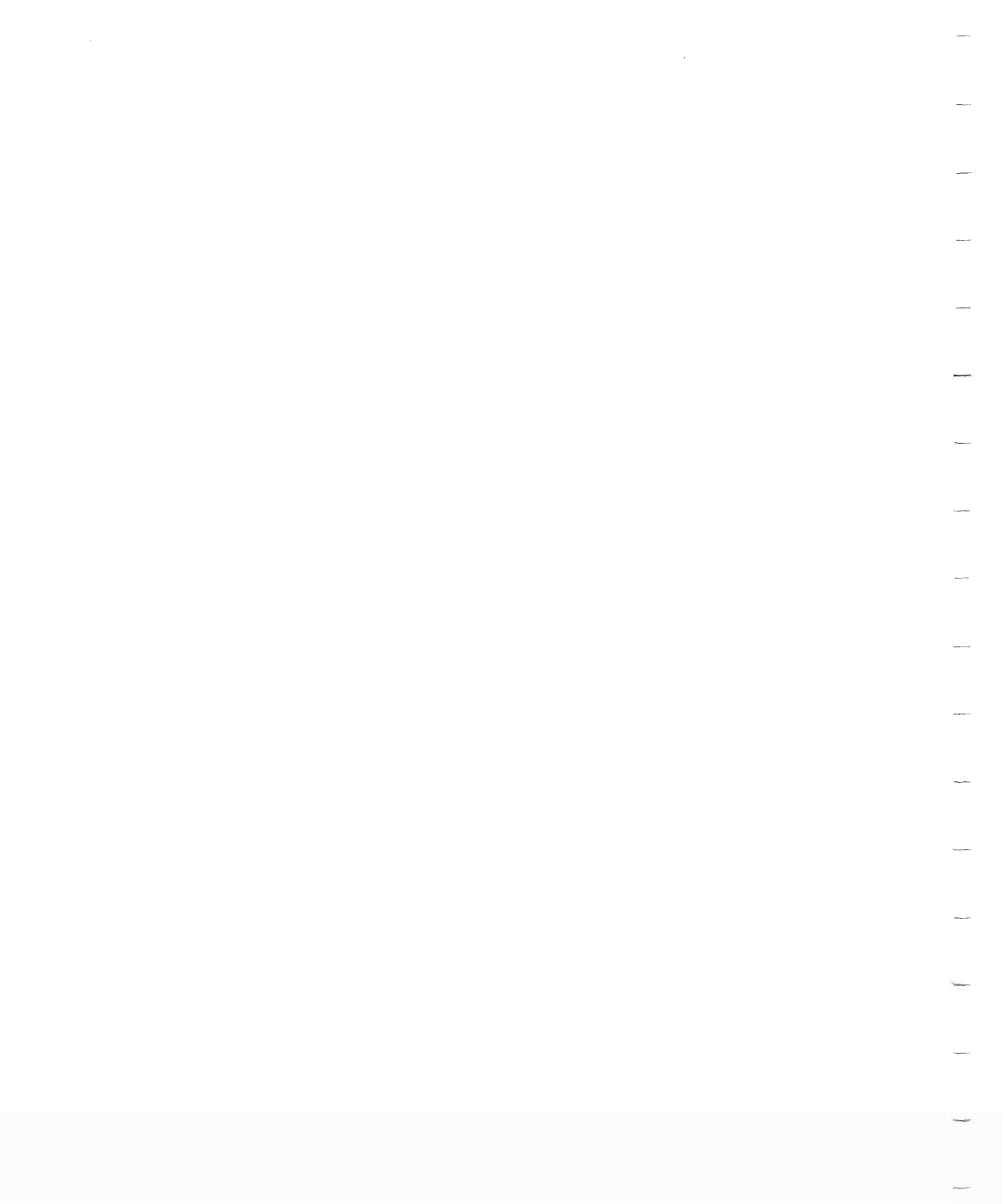

Sharpening Your Measuring Skills

Part 3 of the guide describes how to skillfully and confidently perform the most common types of measurements.

As with Part 2, the following collection of tutorials takes a practical, step-by-step approach to familiarizing you with the use of your LeCroy 9300-Series oscilloscope. And explains what is behind each action at every stage.

First Steps in Measuring

The initial, basic steps for most measurements.

Application Setup

Connect the signal to be measured — for example, the calibrator (CAL) — to the Channel 2 BNC input (CH 2).

At power-up, the scope will still be set to the last-used setup. After being reset (see Step 1, below), the scope will revert to its default power-up settings, with both Traces 1 and 2 on.

STEP 1

Reset: Press  , top menu  and  simultaneously.

Then press  to turn off Trace 1, and display:

Note: Generally, when the scope is switched on or reset, both channels on two-channel models and all four channels on four-channel models are automatically displayed. The traces shown depend on the previous setup used and are switched on or off using the corresponding TRACE ON/OFF button. Here, after the scope is reset (not to be confused with use of the RESET button, which applies only to ZOOM + MATH) both CH 1 and 2 will be on. When CH 1 is switched off using the TRACE ON/OFF button, Channel 2 alone will remain on.

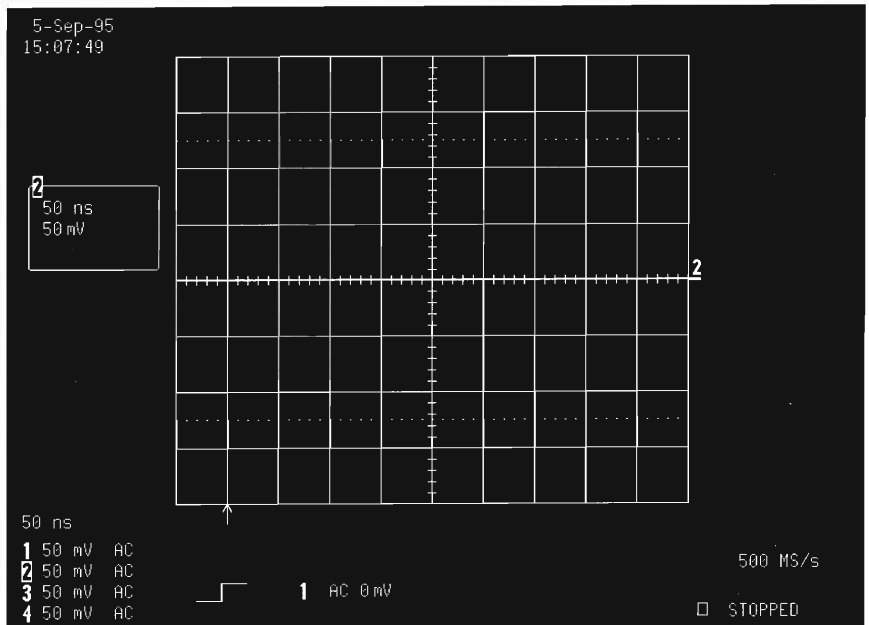

STEP 2

Note: The coupling must be well adapted to avoid reflections at input to the oscilloscope.

COUPLING
Press 

Then press the corresponding menu  to select from the 'Coupling' menu the coupling matching the source's impedance — 50 Ω in this case.

The screen will display:

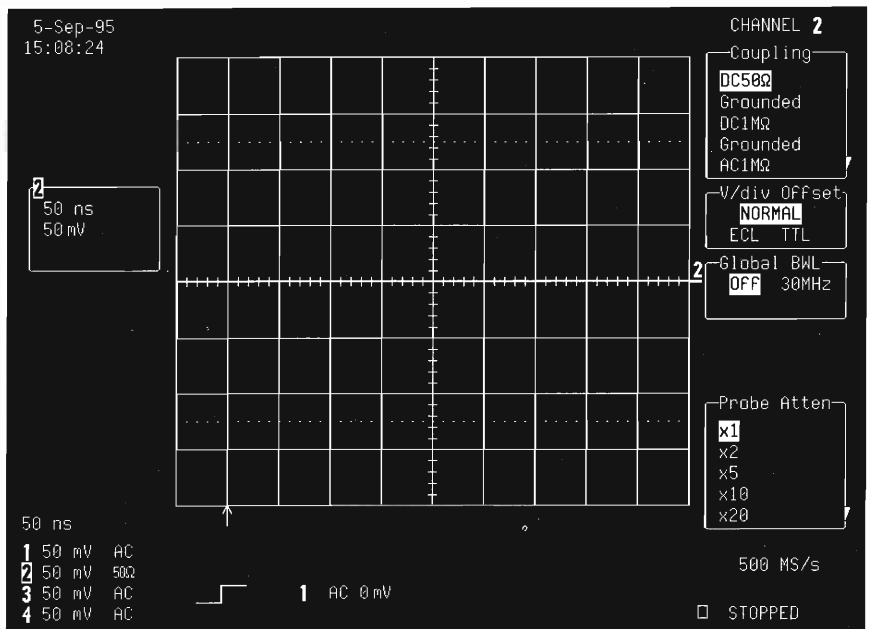

Four-channel vertical controls

Four-channel models: The four-channel model controls, illustrated above left, have a single COUPLING button, which — as with their other vertical controls — applies to the selected channel (highlighted on-screen) only.

Two-channel models have a COUPLING button for each of their two, separate, vertical controls.

STEP 3 

AUTO
SETUP
Press 

The screen will then display:

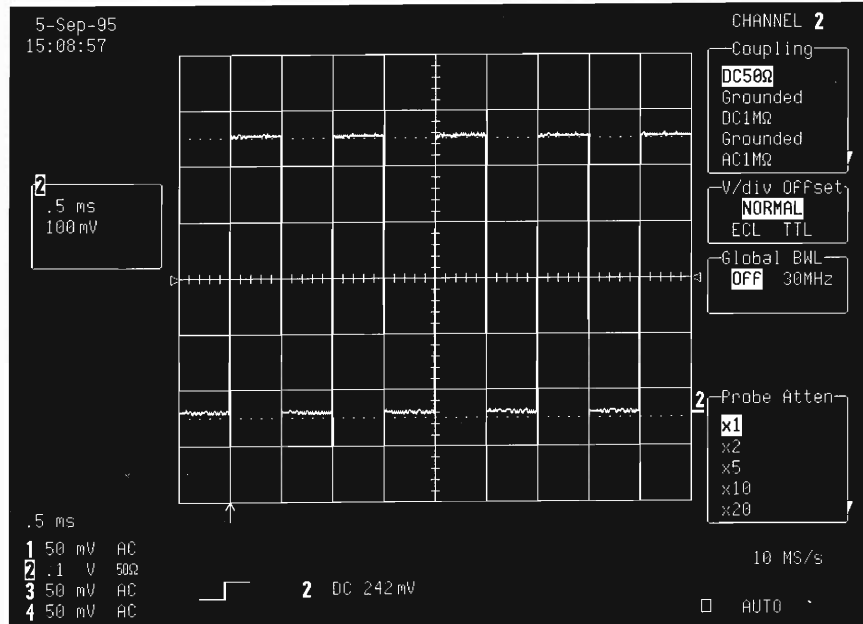

These three basic steps will be repeated as a prelude to performing most of the measurement descriptions that follow.



A Word about Moving Through Menus

As already mentioned, one or more of the menu buttons, or either of the two knobs also located on the 'L'-shaped control panel, may be used for moving up or down a single menu list.

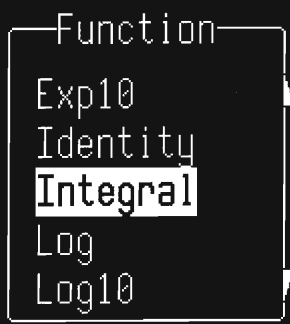

Where menus are too long to be shown on-screen in their entirety, there are arrow-like indicators on their inner edge such as those on the menu box at left. An upward pointing arrow means that the list continues *above* out of sight, whilst a downward-pointing one indicates more menu items *below* the visible part of the menu.

Those items not visible on-screen can be displayed in the normal way, by pressing the corresponding menu button or buttons, or by turning a knob.

(See also *Setting Menu Options* in the *Control of the Oscilloscope* chapter of the *Operator's Manual*.)

Best Digitizing with All Eight Bits

The scope's eight-bit analog-to-digital converter (ADC) offers 256 levels of quantization. Acquisition using all levels gives the best digitizing, the digitized signal covering all eight divisions of the screen without going off-screen ('clipping').

Shown here is how to set up the scope for digitizing on all eight bits.

Application Setup

Connect the signal to be measured — a 1 MHz, 100 mV (peak-to-peak) triangle wave — to CH 2.

STEP 1 

Reset: Press  , top menu  and  simultaneously.

Then press  to turn off Trace 1.

STEP 2 

Press 

Then press the corresponding menu  to select from the 'Coupling' menu the coupling matching the source's impedance — again, 50 Ω .

STEP 3 

Press 

The screen will display:

Note: The signal's amplitude is acquired on approximately six divisions, corresponding to $5/8 = 192$ levels or 7.32 bits of quantification used.

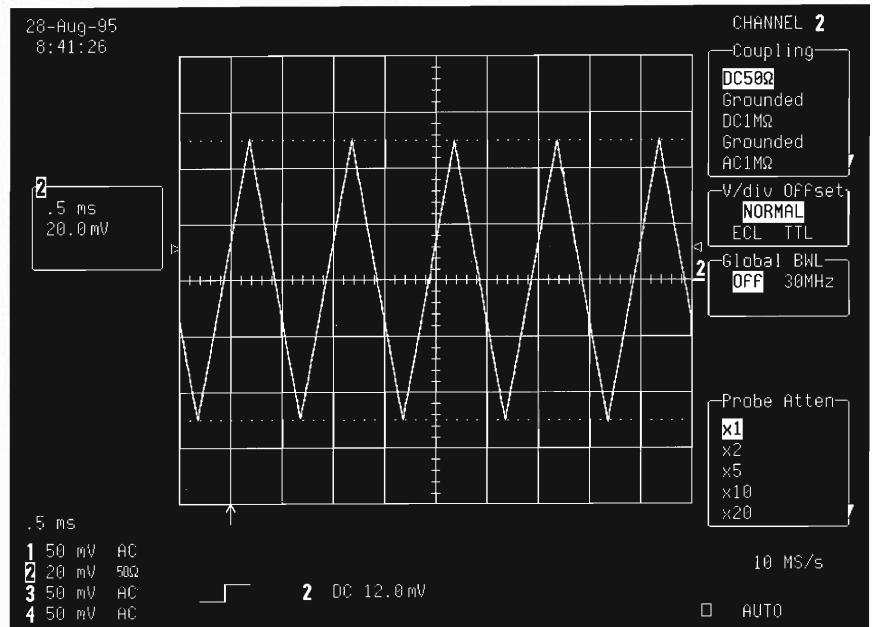

STEP 4

Use  to adjust the channel input sensitivity and have the signal filling all eight divisions of the screen.

To even more finely adjust the sensitivity, press .

Tips: Changing the sensitivity using the VAR button will give a non-rounded gain — for example, 12.8 mV/DIV. Determining the amplitude of the signal by reading visually from screen can be difficult. To avoid reading errors, use CURSORS (see page 3-16)

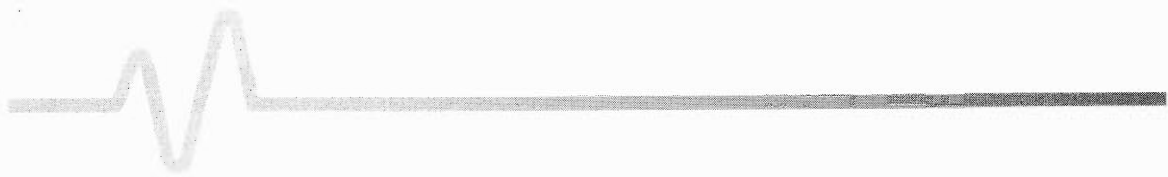

The screen will now display:

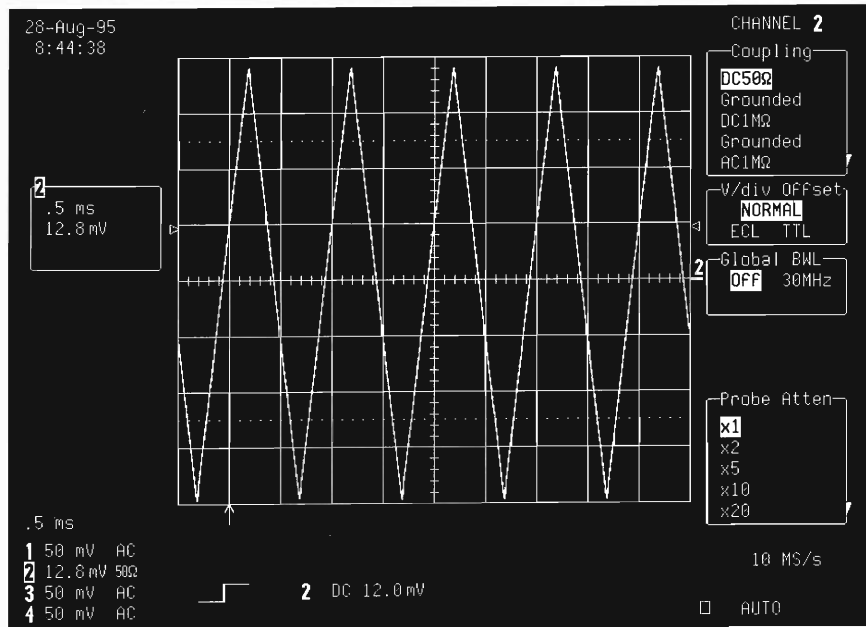

Characterizing a Pulse

One of the major advantages of DSOs is their accurate measurement of acquired data using standard parameters.

The 9300-Series scope offers two varieties of standard parameters — Voltage and Time — as well as parameter customization.

This tutorial shows how these standard parameters can be easily displayed to characterize pulses both vertically and horizontally, making automatic parameter measurement and statistical values readily obtainable

Application Setup

Connect the signal to be measured — a fast signal — to CH 1.



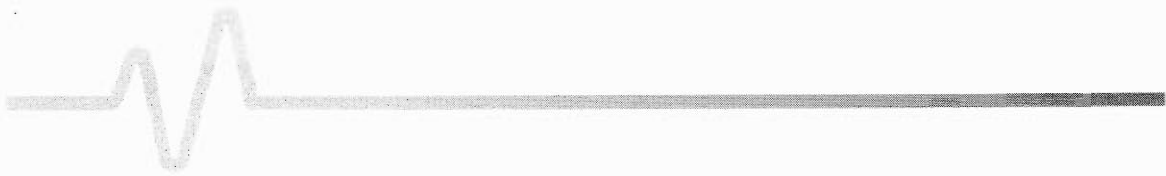

STEP 1 

Reset: Press **AUTO SETUP**, top menu  and **RETURN**  simultaneously.

Then press **TRACE ON/OFF**  to turn off Trace 2.

STEP 2 

Press **COUPLING** 

Then press the corresponding menu  to select from the 'Coupling menu the coupling matching the source's impedance — again, 50 Ω.

STEP 3 

Press **AUTO SETUP** 

The screen will display:

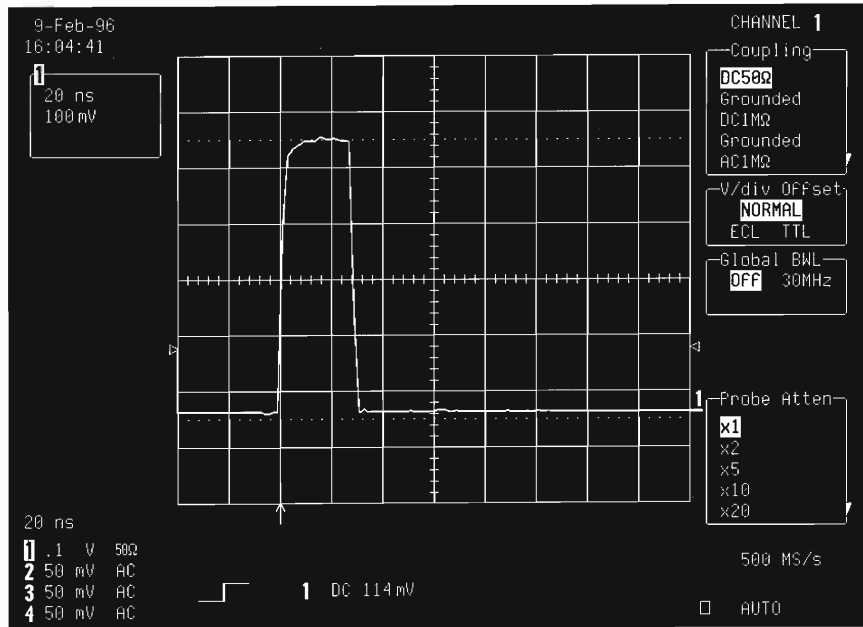

STEP 4 

CURSORS/
MEASURE
Press 

STEP 5 

Then press the corresponding menu  to select 'Parameters' from the top menu box.

The screen will display:

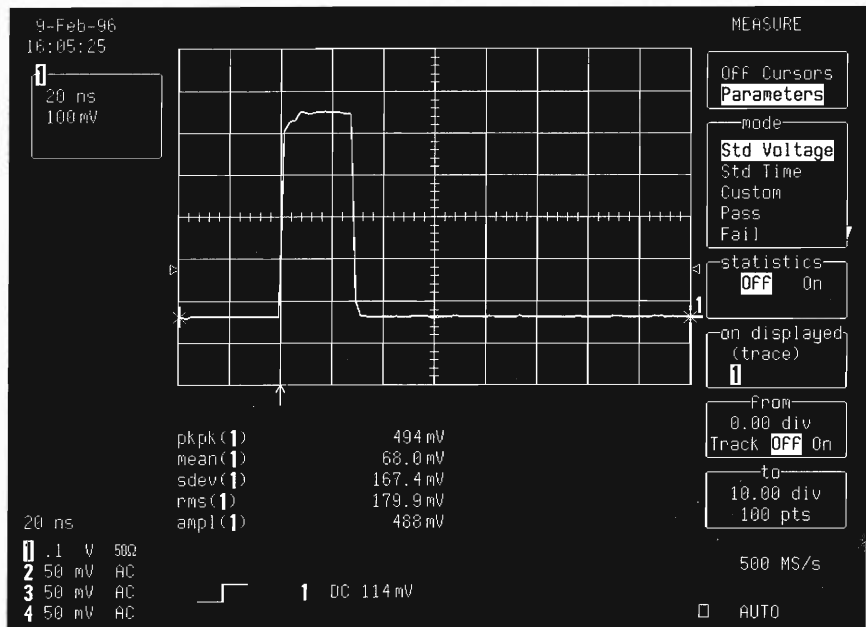

STEP 6 

Press 

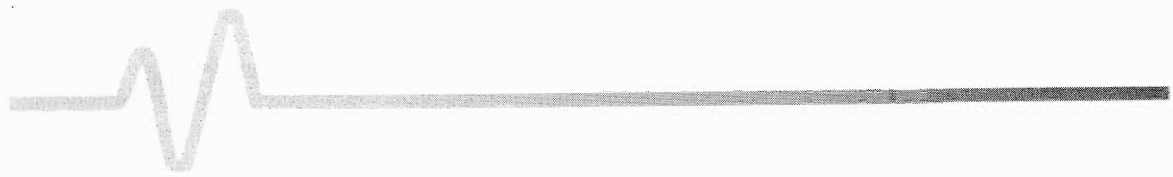

Vertical Parameters

The five main vertical parameters of the last acquisition displayed are:

pkpk — the difference between maximum and minimum data values

mean — the average of data values

sdev — the standard deviation of the data values from the mean value

rms — the square root of the sum of the squares of the data values divided by the number of points

ampl — the amplitude with noise and overshoot resistant estimator (amplitude = top base).

STEP 7

Press the corresponding menu  to select 'Std Time' from the 'mode' menu.

Horizontal Parameters

Now the five main horizontal parameters of the pulse are displayed (on the screen at the top of the facing page):

period — the duration of a full cycle at 50% crossings

width — of the first <50 pulses (+ or -) in the analyzed region

rise — the transition time on the rising edge for 10–90% amplitude

fall — the transition time for the falling edge from 90%–10% amplitude

delay — the time from the trigger (or $t=0$) to the first 50% transition.

Note: Acquiring only one pulse does not permit measurement of a signal period. Therefore, the period parameter is not calculated and no value is displayed.

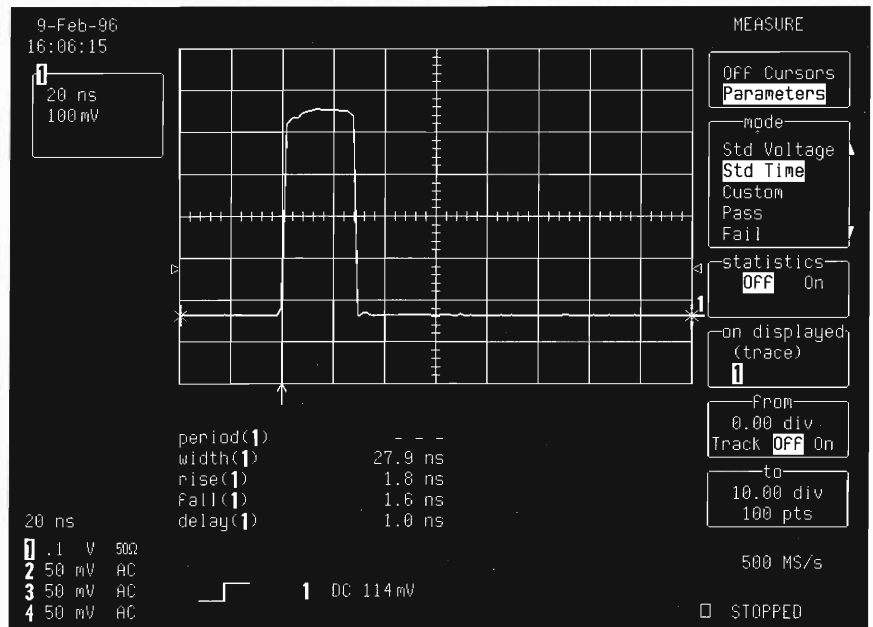

Tips: In order to perform the parameter calculation on a particular section of the signal, adjust the left and right cursors using the upper and lower cursor knobs, respectively.

Note: The number of points used to calculate the parameters is shown in the 'to' menu.

On this screen, an area of interest has been selected for measuring the pulse's peak-to-peak parameter only:

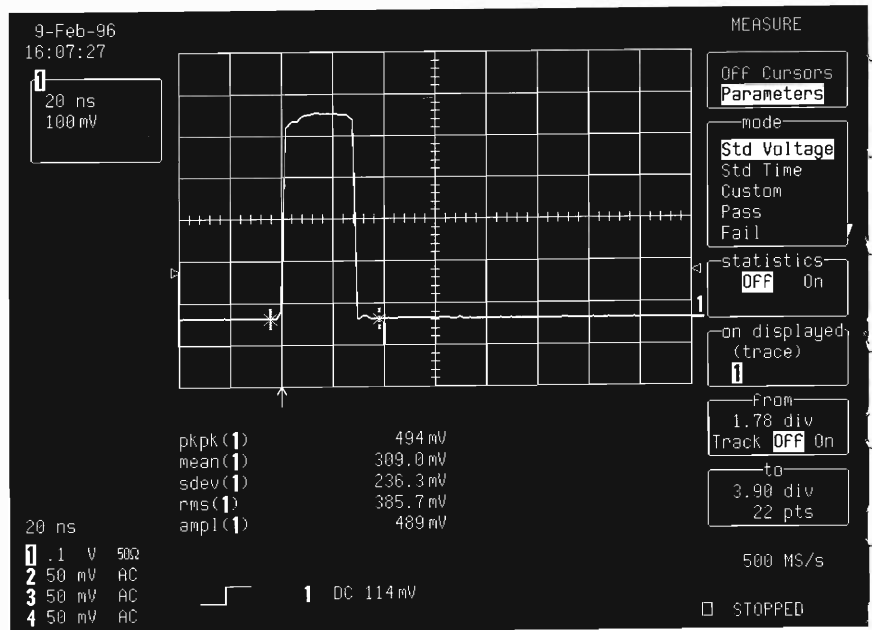

STEP 8

Press the corresponding menu  to select 'On' from the 'statistics' menu.

Four different values are displayed for each parameter: average value; lowest value; highest value; and sigma — the standard deviation of the data values from the mean value.

In order to be confident about the statistical values obtained, a number of acquisitions should be performed.

Now Press



Note: The sweeps number — here, 441 — that is shown immediately under the grid is the number of acquisitions concerned by the statistics calculated and displayed. To restart the statistics calculation, press the CLEAR SWEEPS button on the 'L'-shaped control panel. Only the future acquisitions will be included in the calculation.

All these parameters are readable from a PC linked to the scope by GPIB or RS232 remote control using the 'PArAmeter_VAlue?' query. It is also possible to select five different parameters relating to a variety of traces or memories between 36 standard parameters — even more with the WP03 option (see page 3–54) — using the Custom Mode.

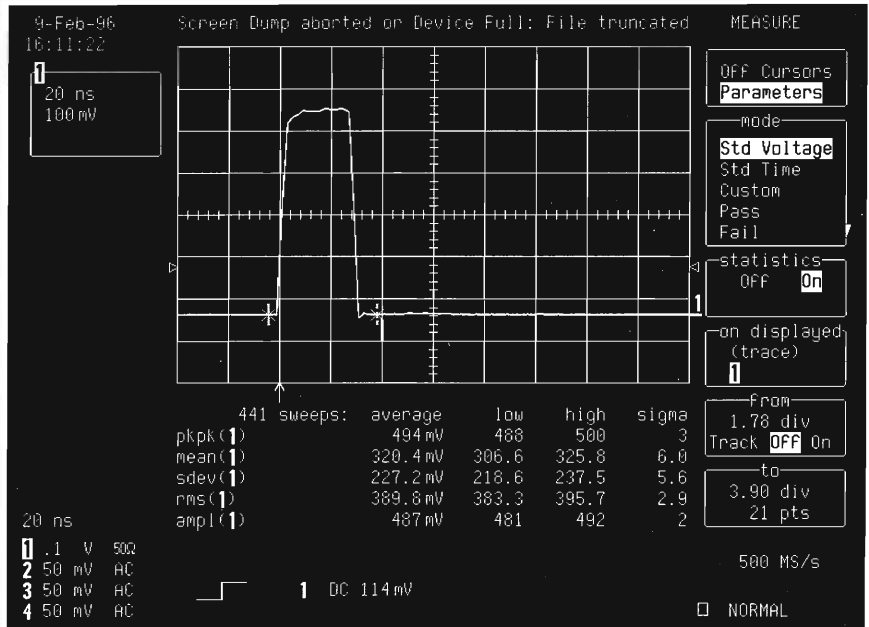

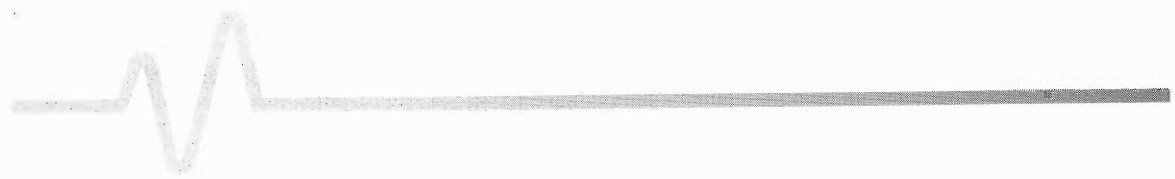

Accurate Measuring with Cursors

The vertical and horizontal cursors ensure accurate measurements.

The vertical cursor — a line that corresponds to the amplitude mode — is used to position on the trace a single line for absolute measurements or dual lines for relative measurements. This cursor reads the amplitude of the desired point. The horizontal (or time) cursor follows the data trace and is used to read the exact amplitude and time values for each data point.

The vertical cursor is useful for determining whether a waveform is within desired limits, while the horizontal one minimizes operator error by aligning with data.

Application Setup

Connect the signal to be measured — for example, the calibrator (CAL) — to CH 1.

Measuring Skills

STEP 1 

Reset: Press **AUTO SETUP**, top menu **RETURN** and **RETURN** simultaneously.

Then press **TRACE ON/OFF** **2** to turn off Trace 2.

STEP 2 

Press **COUPLING**

Then press the corresponding menu **50Ω** to select from the 'Coupling' menu the coupling matching the source's impedance — 50 Ω.

STEP 3 

Press **AUTO SETUP**

STEP 4 

Turn **TIME/DIV** **1ms** to adjust the timebase, and **VOLTS/DIV** **5V** to fill the screen with the signal.

Press **SNGL** to halt the scope. The screen will display:

Note: Single — represented by the SNGL button on the TIMEBASE + TRIGGER control panel — is a smooth way of stopping the scope to allow measurement of the waveform of interest captured on-screen.

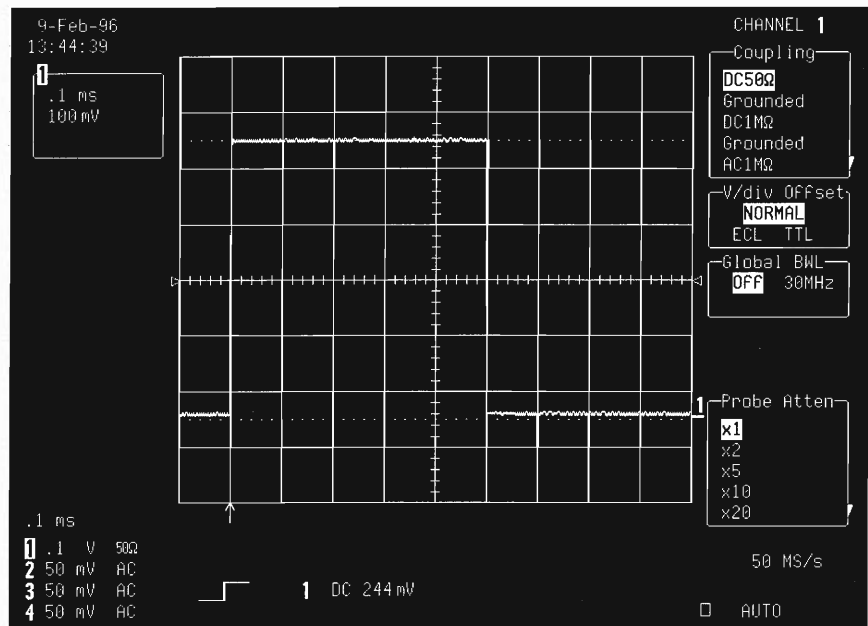

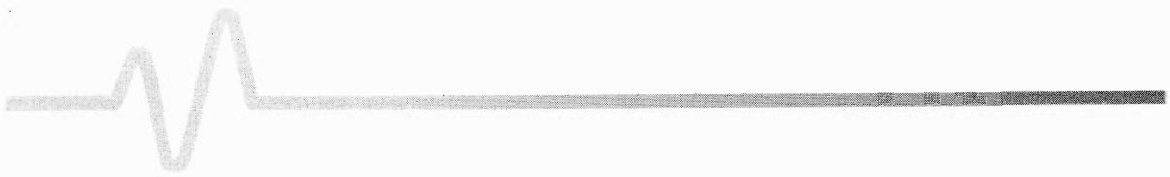

STEP 5 

CURSORS/
MEASURE
Press 

STEP 6 

Press the top menu  to select '**Cursors**'.

(**'Amplitude'** and **'Absolute'** will show as the default selections in the 'mode' and 'type' menus, respectively.)

The screen will display:

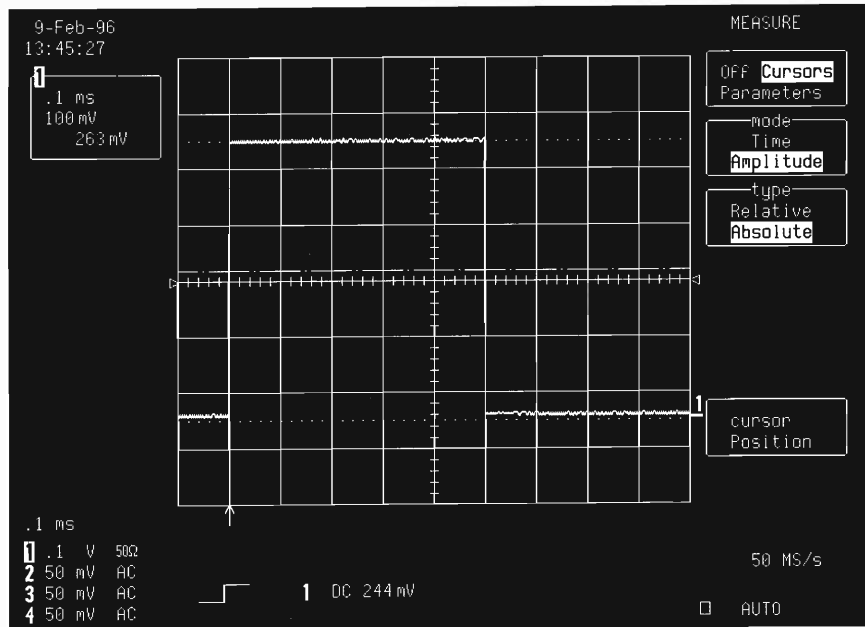

STEP 7 

Turn the upper '**cursor position**'  knob to set the horizontal cursor bar at the top of the signal.

The screen will then display:

Note: In the Absolute Amplitude Mode, selected here by default, a single cursor line is displayed. The vertical position can be adjusted by turning the upper cursor knob. The absolute measurement gives the difference in amplitude between the horizontal line adjusted by the user and the ground level represented on-screen by '1'. The numeric value is shown in the trace label at left-of-screen. Here, the difference between the ground and maximum levels of the acquired signal is 496 mV.

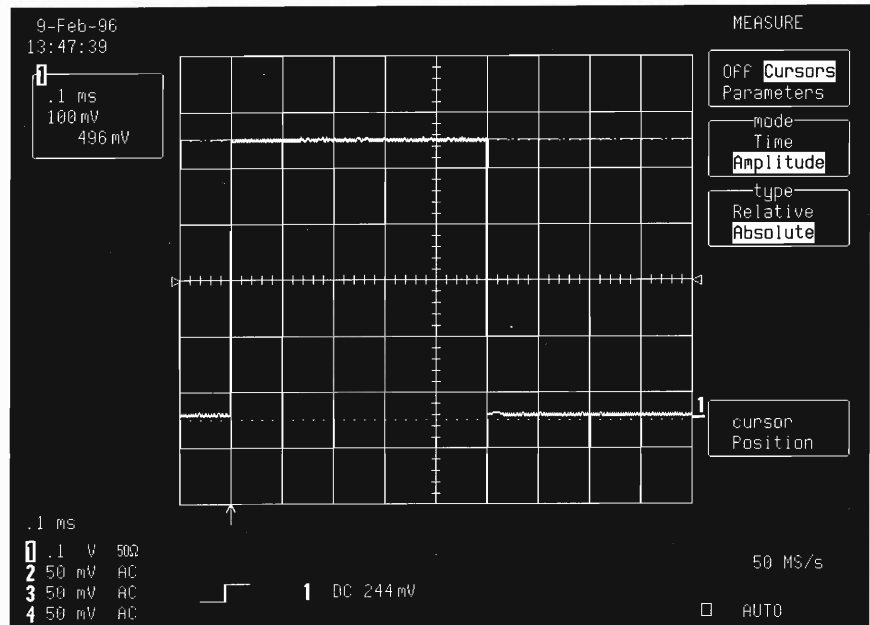

STEP 8

Press the corresponding menu  to select 'Relative' from the 'mode' menu. This will activate the Relative Amplitude Mode and cause the relative horizontal cursor bar to appear on-screen.



The screen will then display:

Note: In the Relative Amplitude Mode the reference cursor can be different from the ground level. For example, turning the upper cursor knob adjusts the reference level to the base level of the acquired signal's oscillations. The difference cursor is adjusted using the lower cursor knob to measure the amplitude difference anywhere on the acquired trace. The two lines on the screen shown here, for instance, are used to measure the amplitude of the oscillations on the square wave, measured as '11 mV'.

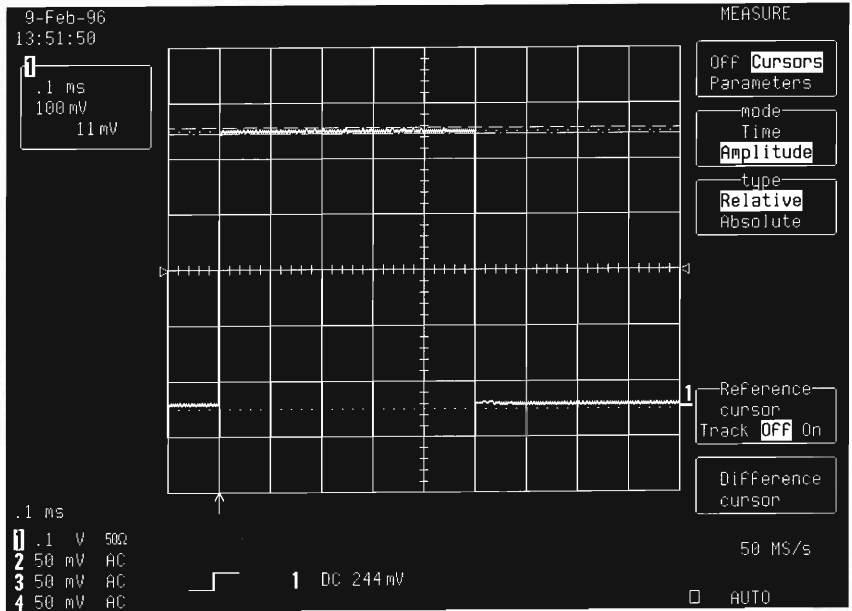

Tips: Press the corresponding menu button to select 'Track On' from the 'Reference' cursor menu. The difference between the two horizontal lines will now remain the same. When the reference line is changed, the two lines will move together. Turning the lower cursor knob changes the difference cursor position and modifies the difference. Press the same menu button to turn 'Track' off.

STEP 9

Press the corresponding menu buttons to select 'Time' and 'Absolute' from the 'mode' and 'time' menus, respectively, and to activate Absolute Time Mode.

The screen will then display:

Note: In Absolute Time Mode, the reference point ($t=0$) is the trigger point determined by the two horizontal, trigger-level arrows and the vertical arrow on the grid base. The absolute time cursor is a cross-hair that moves along the trace.

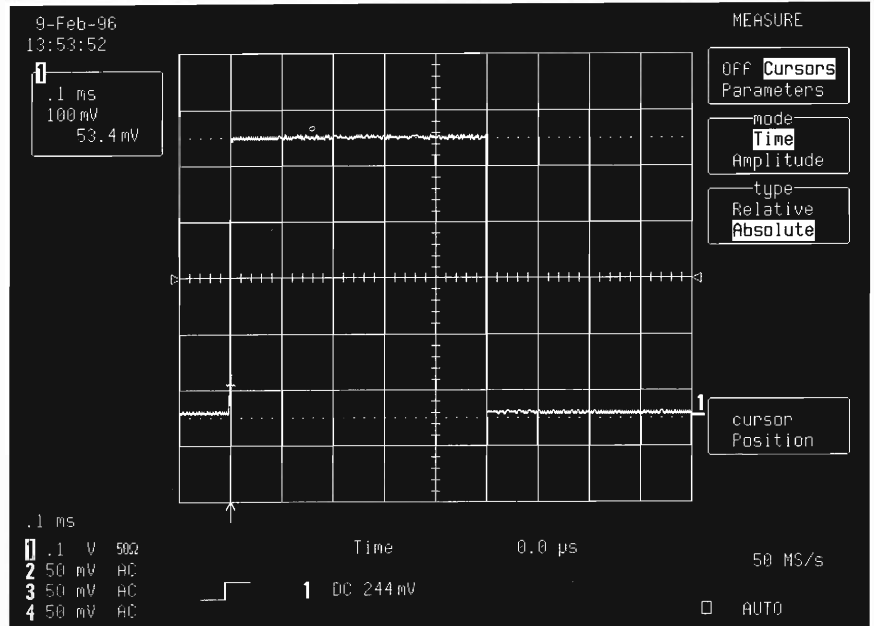

STEP 10 

Turn  to change the time cursor position.



The screen will then display:

The value measured between the absolute time cursor and the trigger point is displayed below the grid — 'Time 501 μ s' on the screen.

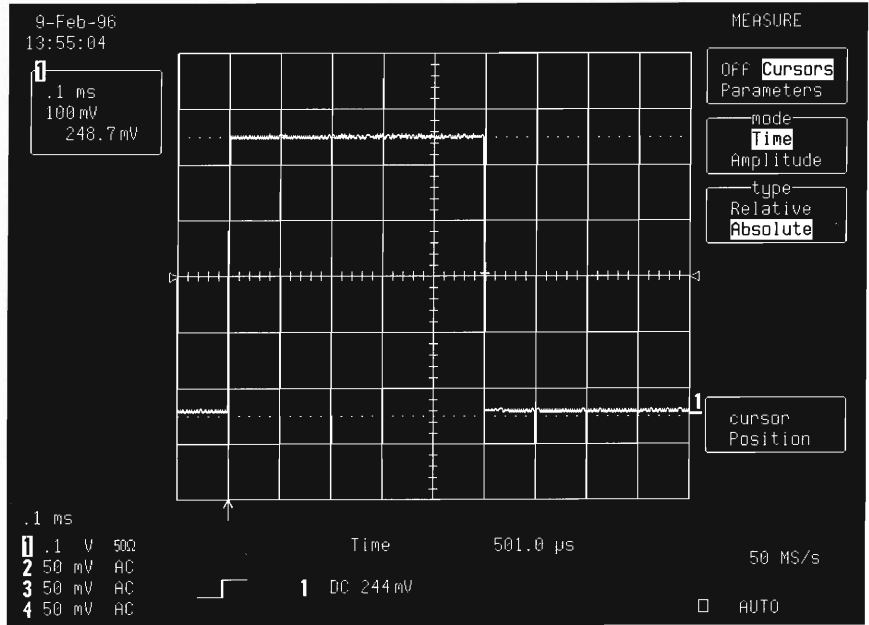

STEP 11

Press the corresponding menu to select 'Relative' from the 'type' menu, and to activate the Relative Time Mode

The screen will then display:

Note: In Relative Time Mode, the reference cursor (represented by the upward-pointing arrow in the bottom-left quadrant of the grid) can be changed and may be different from the trigger point. By turning the upper cursor knob, the reference cursor can be moved — for example — to the falling edge of the acquired signal's oscillations.

The difference cursor (downward pointing arrow) can also be moved using the upper knob, measuring the difference in time anywhere on the acquired trace.

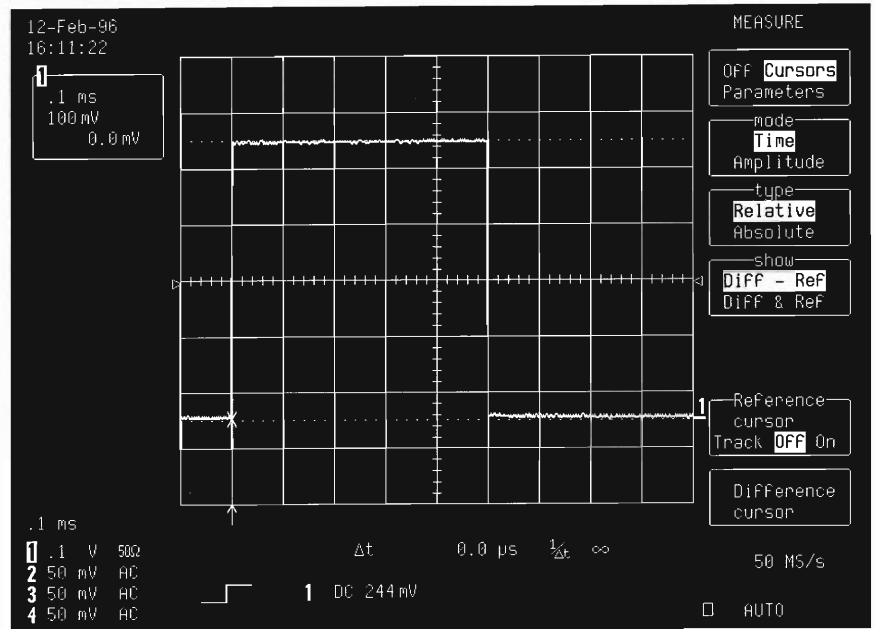

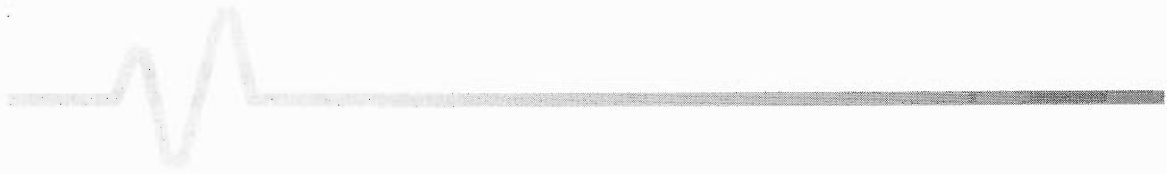

The next screen displays changes to the relative time cursor settings.

Note: On the screens shown here and on the previous page, the reference and difference cursors are used to measure the period and frequency of the oscillations on the square wave — itself measured as $\Delta t = 500 \mu\text{s}$ and together with $\text{freq} = 2 \text{ kHz}$ under the grid.

When 'Diff-Ref' is selected, as here and on the preceding page, the gain by division and the difference in amplitude between the cursors is displayed in the trace label — shown here as gain '200 mV/div' and difference between cursors '4.7 mV'.

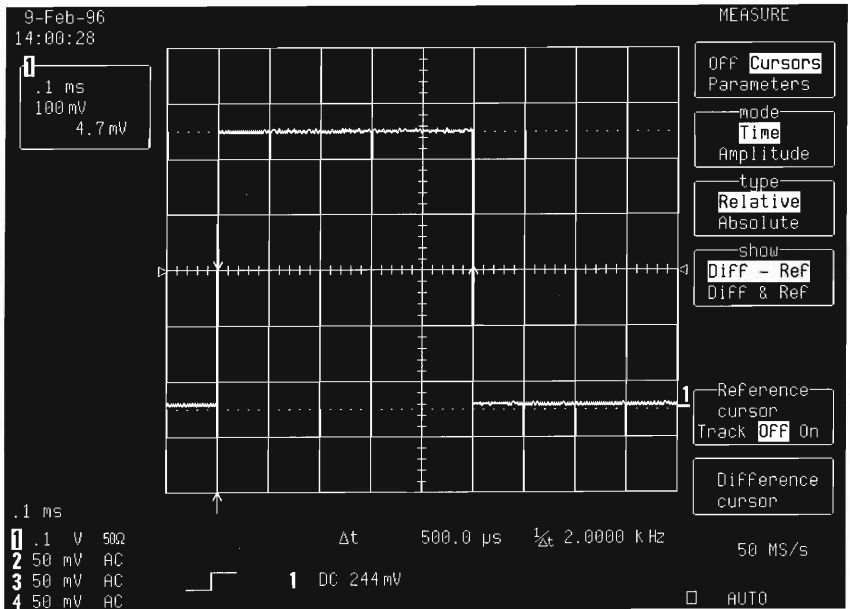

Tips: Press the corresponding menu button to select **Diff & Ref** and display in the trace label the absolute amplitude — relative to the ground level — of each cursor.

Measuring Skills

In this, the final screen in the description, the reference and difference cursors are, respectively, 248.7 mV and 247.1 mV from the ground.

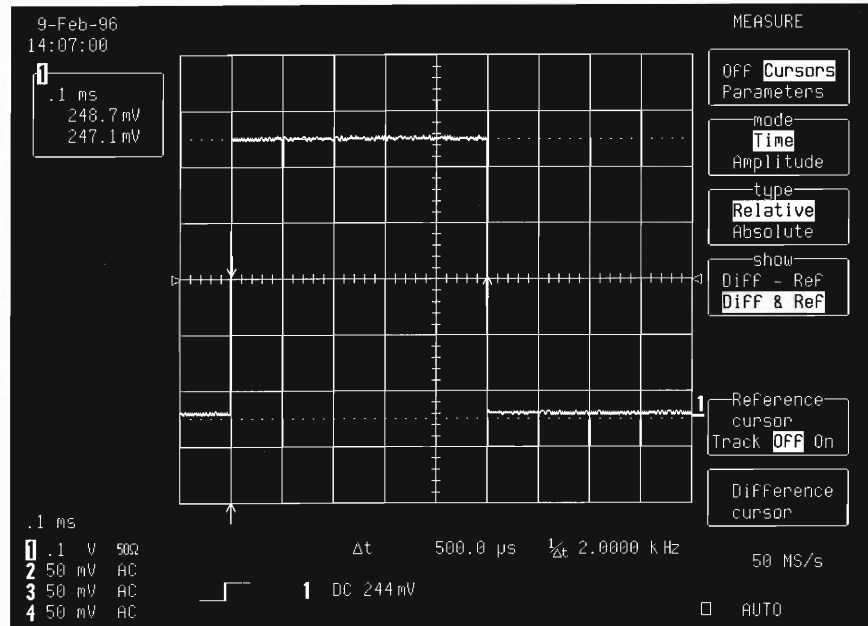



Using ‘Average’ to Remove Noise

‘Average’ is one of the scope’s important and powerful Math functions. Use it to reduce non-systematic noise and improve the signal-to-noise ratio.

Application Setup

Connect the signal to be measured — a 33 kHz, 1.0 V (peak-to-peak) square wave with noise — to CH 2.

STEP 1 

Reset: Press , top menu  and  simultaneously.

Then press  to turn off Trace 1.

STEP 2 

Press 

Then press the corresponding menu  to select from the ‘Coupling’ menu the coupling matching the source’s impedance — 50 Ω .

STEP 3 

Press 

The screen will display:

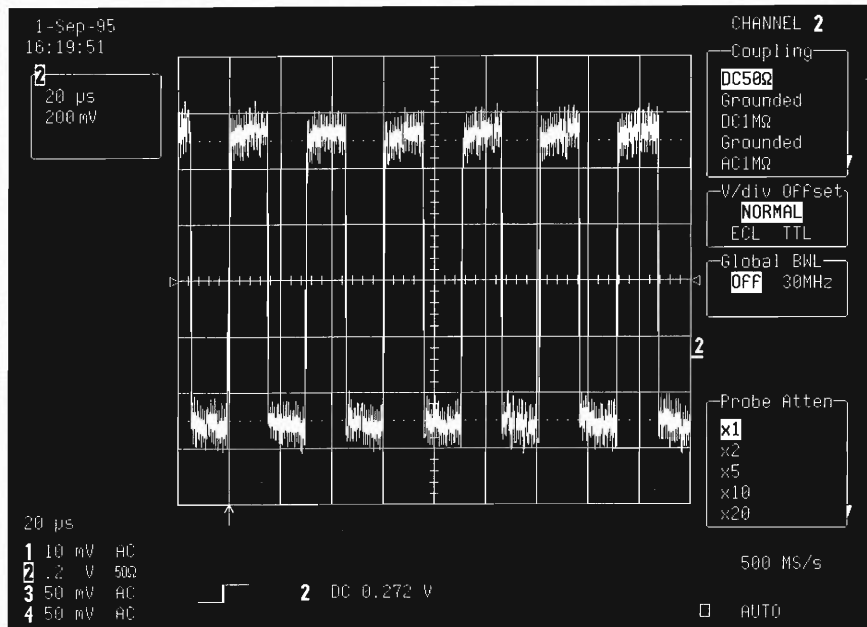

STEP 4 

Press 

STEP 5 

Press the corresponding menu  to select 'Dual' from the 'Grids' menu.



The screen will now display:

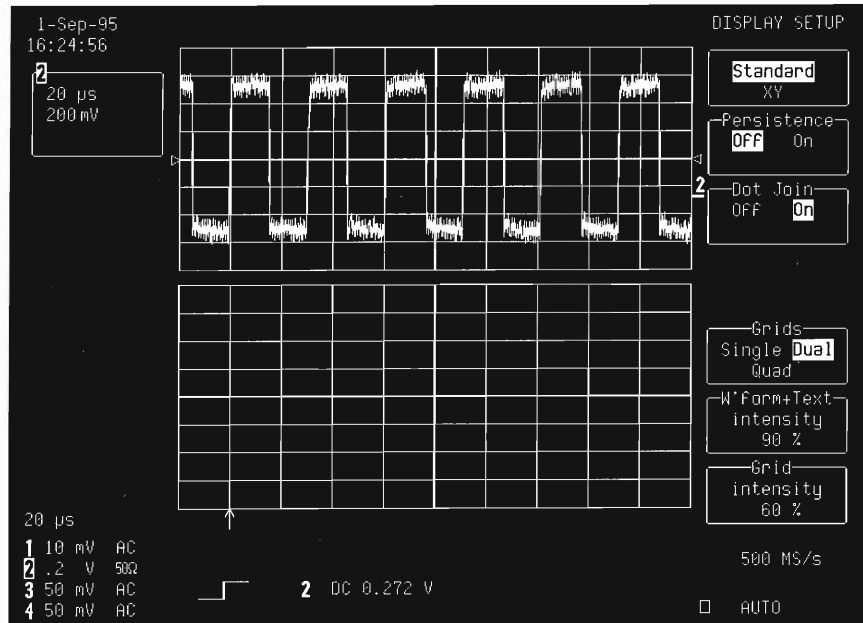

STEP 6 

**MATH
SETUP**
Press 

STEP 7 

Press the corresponding menu  to select 'REDEFINE A'.

STEP 8 

Press the corresponding menu  to select 'Yes' from the 'use Math?' menu.

STEP 9

Press the corresponding menu  to select 'Average' from the 'Math Type' menu.

STEP 10

Now, press  to turn on Trace A.

The screen will display:

Note: Depending on the scope's configuration, a choice of types of acquired signal averaging is available on the 'Avg Type' menu. The summed average gives all averaged data the same weight. While the continuous average can be set up to give data different weights—for example, the most recent acquisition could be given greater importance in the average calculation ratio defined by the user.

The desired number of sweeps—acquisitions taken into account in the averaging—can also be selected using the corresponding menu button. Here, an average of 1000 acquisitions is selected from the 'for' menu. Any trace can be averaged—CH 1 or CH 2, or CH 3 or CH 4 on four-channel models; Trace A, B, C, or D, or Memory 1, 2, 3 or 4.

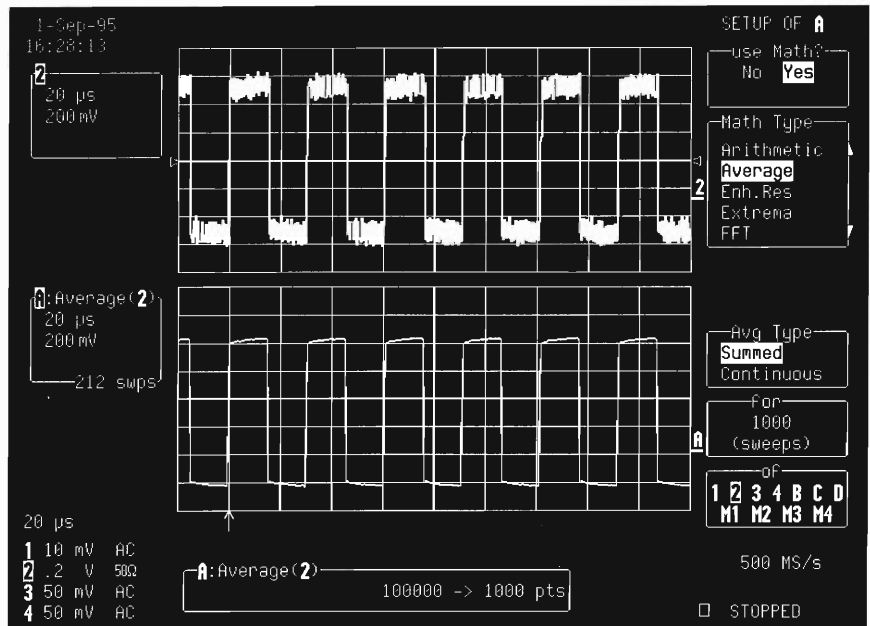

CLEAR SWEEPS

To restart averaging: Press 

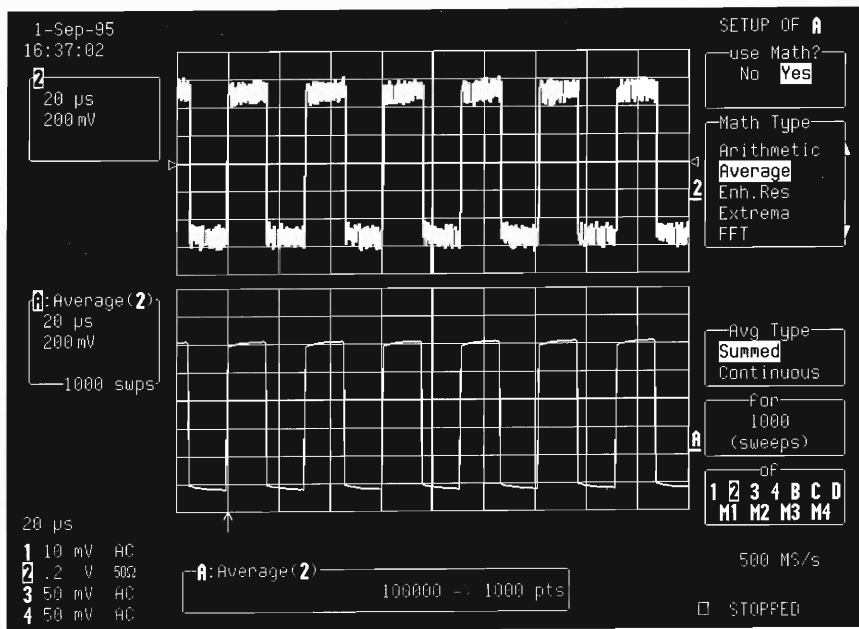
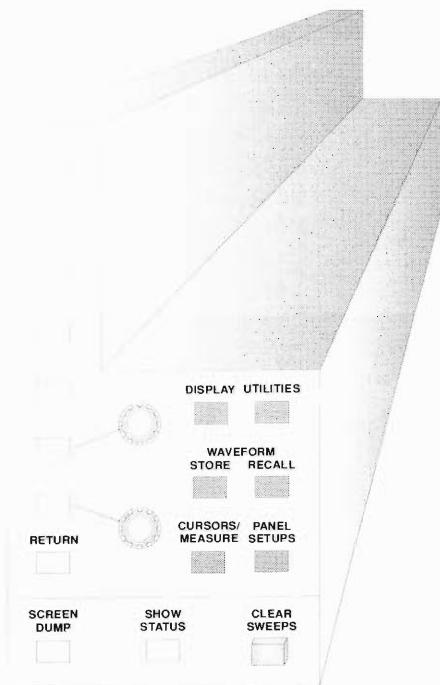

Note: With Trace A on, the sweep counter in the Trace A label at mid-left of screen will mount until the number of sweeps reaches that selected. In the meantime, the intermediate result of the average is displayed ('212 swps', as shown on the previous page). Once the selected sweeps number is reached, calculation stops and the final result of the average is displayed, as shown on the screen this page.

This screen shows the final result of the averaging of 1000 acquisitions.

The non-systematic noise has been greatly reduced — as can be seen from a comparison of a single CH 2 acquisition with the 1000-acquisition averaged result on Trace A.



Picturing Signal History

Persistence Mode makes it easier to view signal changes over time by accumulating on-screen points from numerous acquisitions. The following tutorial explains how to use this function to reveal the FM modulation of a sinewave.

Application Setup

Connect signal to be measured — an FM modulation of a 5 MHz sinewave with 100 kHz squarewave — to CH 2.

STEP 1 

Reset: Press , top menu  and  simultaneously.

Then press  to turn off Trace 1.

STEP 2 

Press 

Then press the corresponding menu  to select from the 'Coupling' menu the coupling matching the source's impedance — 50 Ω.

STEP 3 

Press 



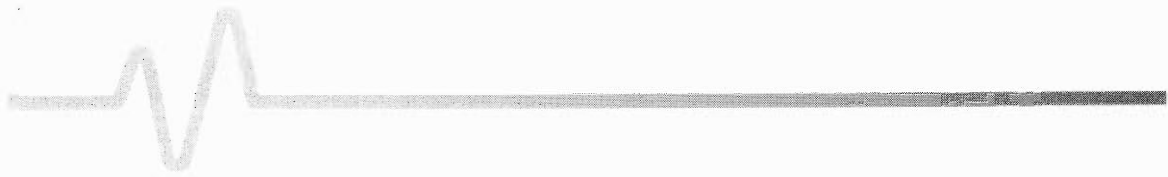

The screen will display:

Note: The FM modulation signal has a stable trigger. However, in the final periods the signal shows a number of jumps. It is not easy to characterize these modulation variations in the normal display mode, but Persistence Mode is very valuable for achieving this.

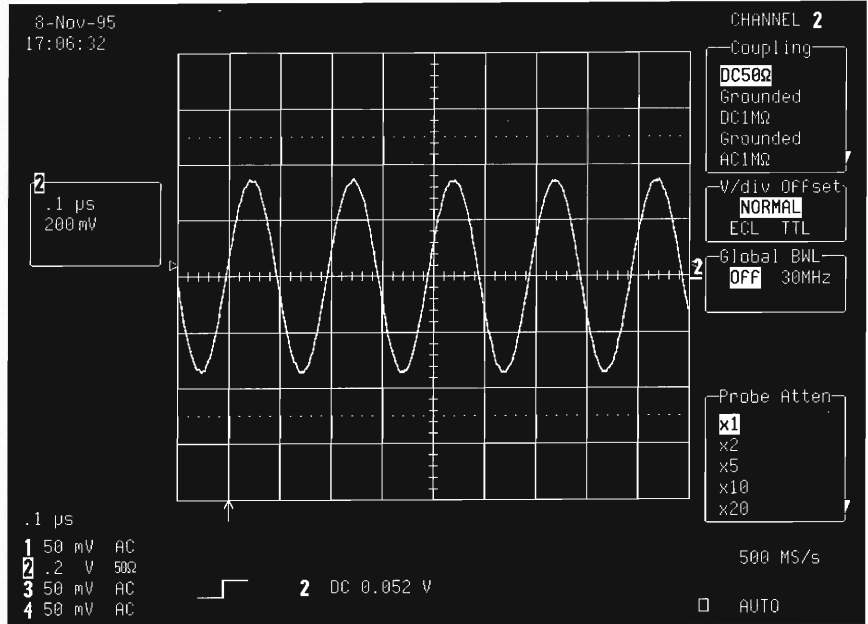



STEP 4

Now press

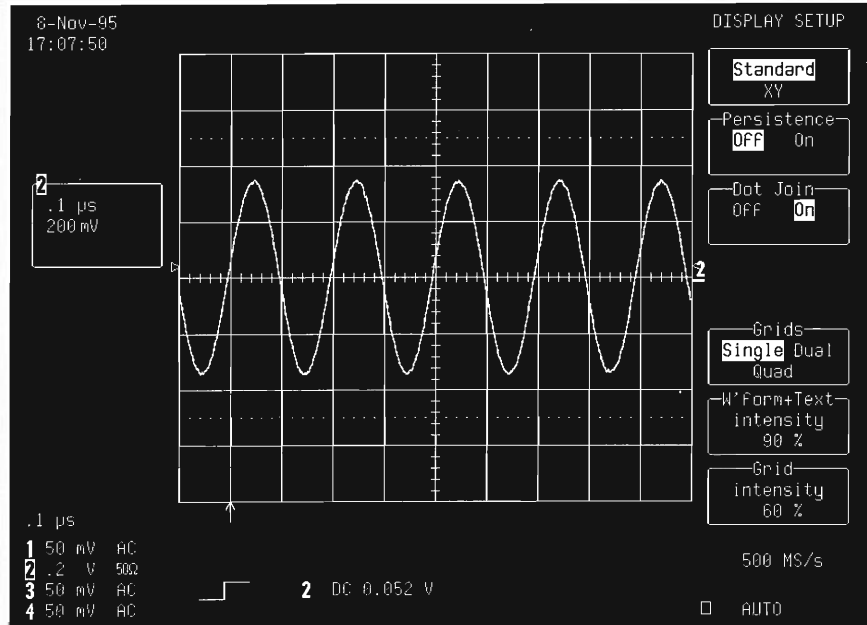
The screen will then display:



STEP 5 

Press the corresponding menu  to select 'On' from the 'Persistence' menu.

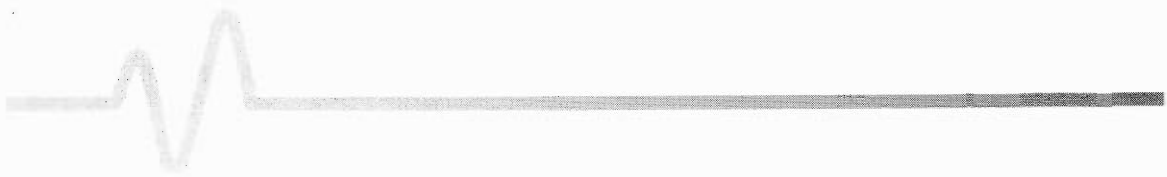

The screen will display:

Note: In Persistence Mode, modulation time variations appear clearly; because its source is a squarewave signal, the modulation shown here has two different states. The number of acquisitions included in the display (up to one million) is shown beneath the grid. In this example, 69 sweeps have been captured to obtain the result displayed. The most recent sweep is shown as a bright vector trace on top of the persistence display. Persistence is also available in XY and Sequence Modes.

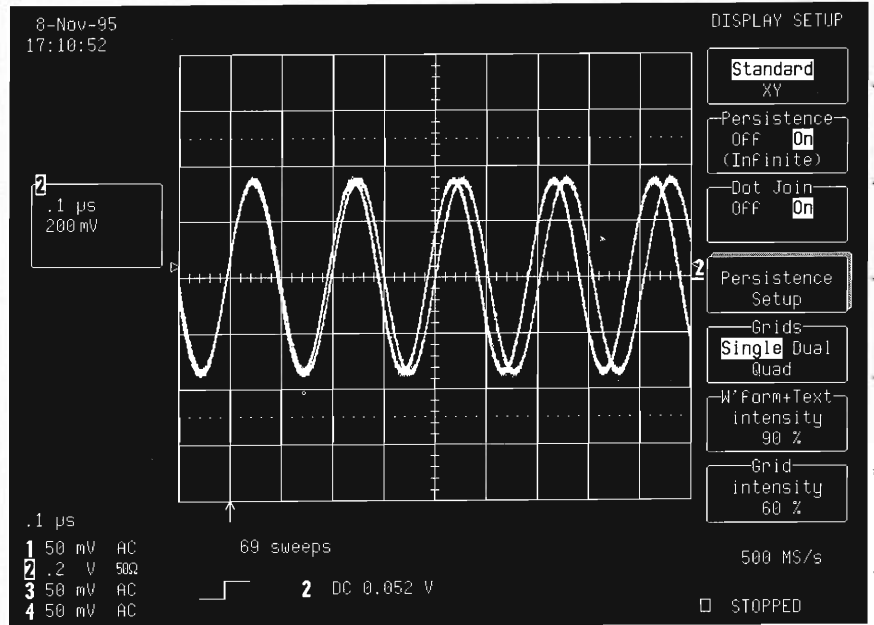

STEP 6

Press the corresponding menu for 'Persistence Setup'.

The screen will then display:

Note: The 'Persistence' menu — the upper box in the 'PERSISTENCE' menu group shown here — offers the means to apply persistence to all displayed traces, or merely the top two, when more than one trace is being displayed. Information on each trace will be shown in its respective trace label at left-of-screen, with 'Top 2' when selected relating to the first- and second-from-top labels that will appear with each additional trace. This is particularly useful when four traces or functions are shown on-screen and persistence is not to be applied to all of them.

At the same time, the lower menu box in the column, 'Persist for', offers a choice of persistence duration in seconds. If the duration is set — for example — at one second, as on the screen overleaf, then each acquired trace will be displayed for one second and then deleted. The default value for this menu is **'Infinite'**.

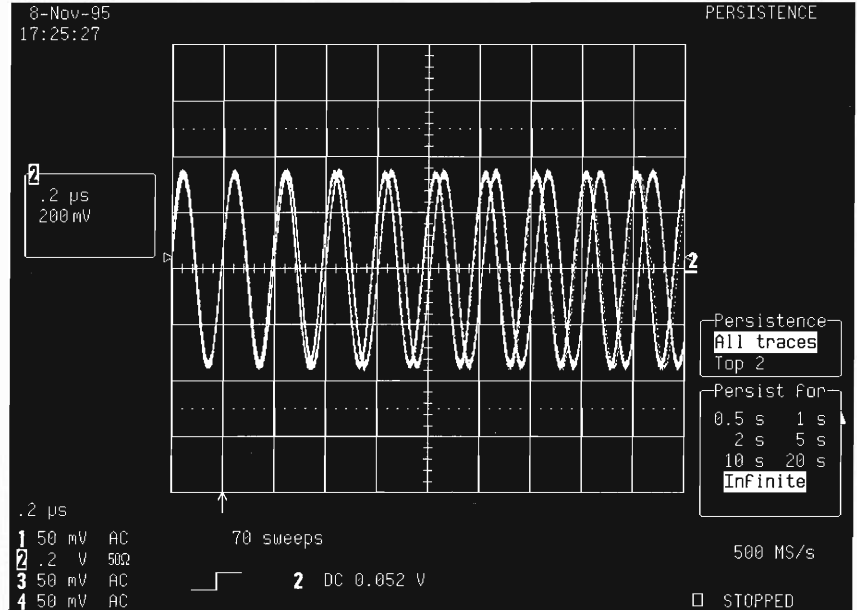

Tips: Persistence Mode can be cleared and reset manually by pressing the CLEAR SWEEPS button on the 'L'-shaped control panel or by changing any acquisition or waveform processing condition or the number of grids. Persistence is not available for traces of more than two million points.

The final screen in this tutorial displays the trace after the persistence duration has been set at one second.

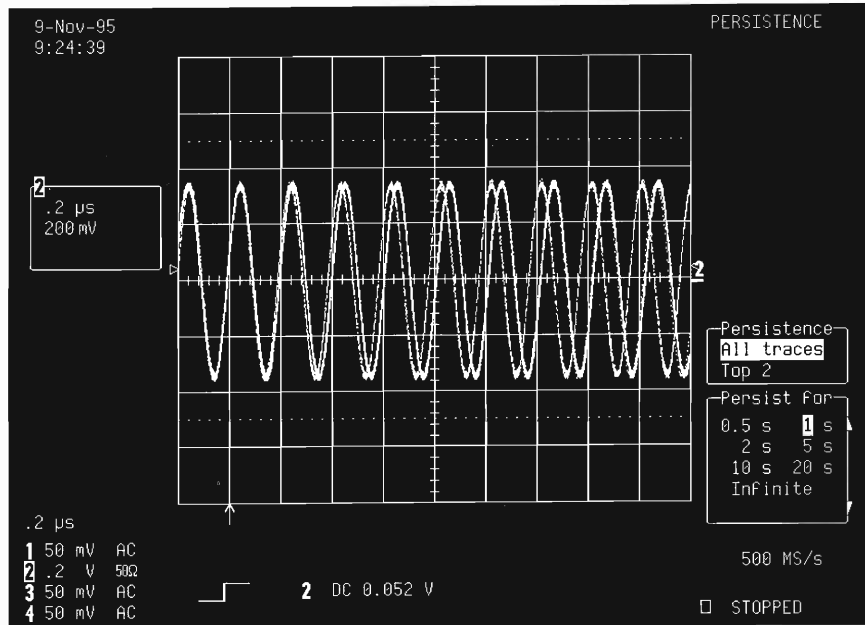

Cutting Deadtime Between Events

Sequence mode goes beyond single-shot acquisition. It offers a choice of fixed-size, complete-waveform segments acquired in single-shot mode, without unwanted deadtime (see *Appendix A* in the *Operator's Manual* for the limits).

The long intervals of deadtime often separating consecutive single-shot events are minimized in sequence mode. Complicated event sequences covering large time intervals are captured in fine detail — without the uninteresting periods between.

Application Setup

Connect the signal — a pulse train (each group of 12 pulses separated by a long signal that need not be acquired) — to CH 2.



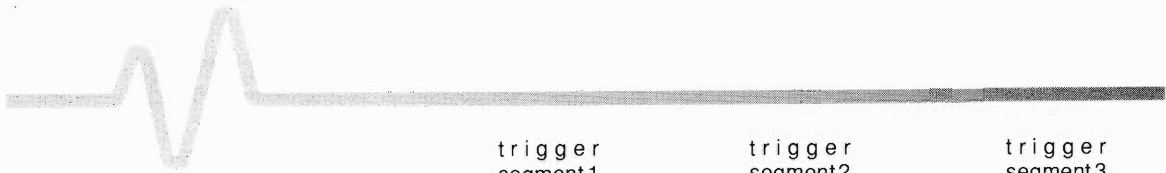

Segment	Time	since Segment 1	between Segments
1)	17-Feb-1995 09:16:01		
2)	17-Feb-1995 09:16:01	5.999983 ms	
3)	17-Feb-1995 09:16:01	11.999965 ms	5.999983 ms

Schema representing how Sequence Mode handles **sequence acquisition**. The screen displayed can be activated by using *SHOW STATUS*, and selecting 'Text & Times' from the menu then shown.

STEP 1 

Reset: Press **AUTO SETUP**, top menu **RETURN** and **RETURN** simultaneously.

Then press **TRACE ON/OFF 1** to turn off Trace 1.

STEP 2 

Press **COUPLING**
Then press the corresponding menu to select from the 'Coupling' menu the coupling matching the source's impedance — 50 Ω.

STEP 3 

Press **AUTO SETUP**

STEP 4 

Turn **TIME/DIV 1000s 1ns** to adjust the timebase, and **VOLTS/DIV 5V 2mV** to adjust the gain and fill the screen with the signal.

The screen will display:

Note: This screen shows only one of 12 train pulses.

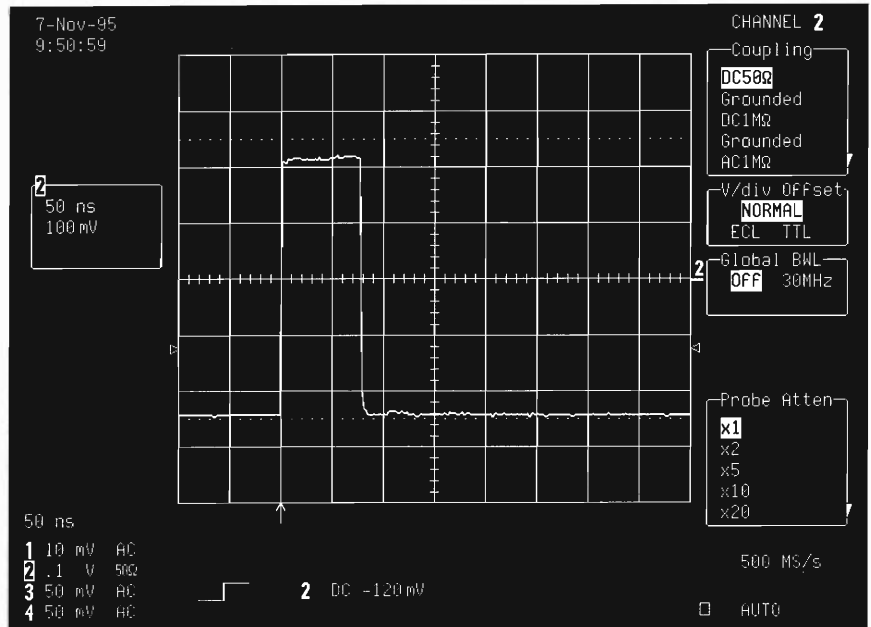
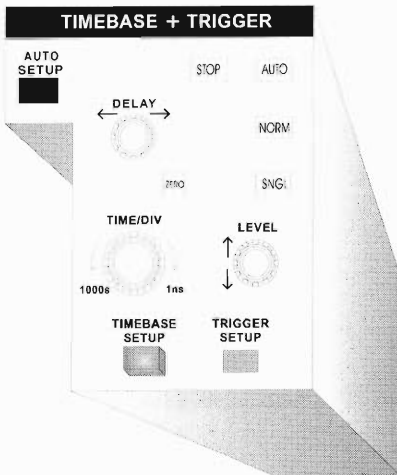

STEP 5

Again turn to adjust the timebase, this time to display all of the train's pulses.

STEP 6

Now press

Note: The 'TIMEBASE' information shown at top-right-of-screen, consists of, in this example:
Timebase value — 2 μ s/div;
Number of samples acquired — 10 000;
Sampling rate — 500 MS/s;
Time between samples — 2 ns/point;
Total time acquisition — 20 μ s.

The screen will now display:

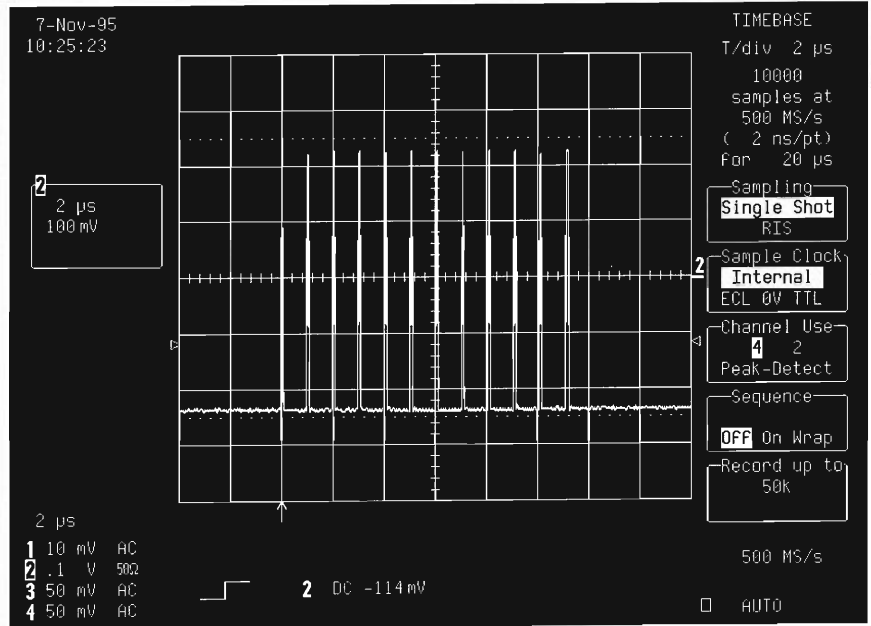

STEP 7 

Again turn  to adjust the timebase, this time until two pulse trains are acquired.

The screen will then display:

Note: As shown at top-right-of-screen, the sampling rate has decreased as the total window time acquisition has increased. Between two trains, a long ground-level signal of no interest has been acquired.

Sequence Mode, activated at the next step, is the best way of acquiring the zone of interest only.

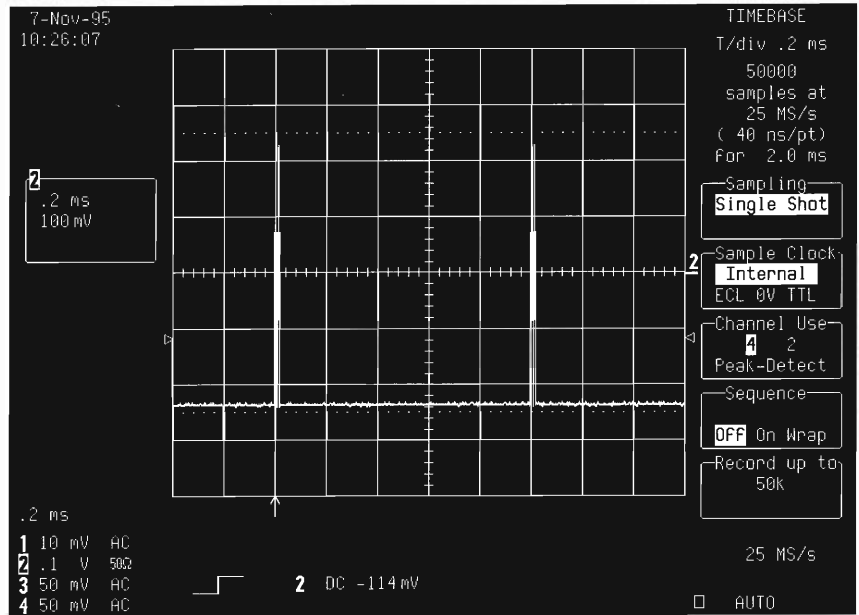

STEP 8 

Press 

Then press the corresponding menu  to select 'On' from the 'Sequence' menu.

Next, turn  and display '2 segments' in the 'Sequence' menu box.

Press 

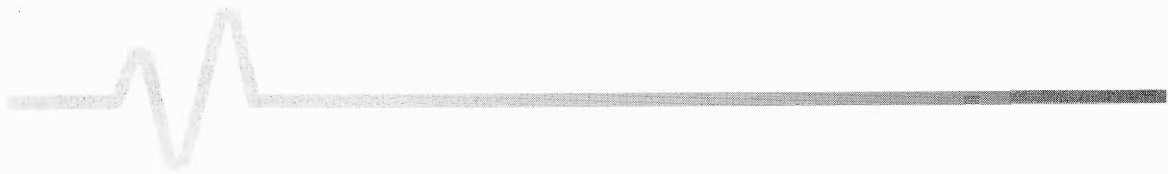

Now in Sequence Mode proper, the screen displays:

*Note: The number of trains acquired is now four, with the same sampling rate as for two. The sole difference is that now the duration between two train pulses is half what it was. In the trace label at left-of-screen, the symbol '2x' indicates two segments acquired in Sequence Mode. The TIMEBASE information shows that two segments of 50 000 points each ('2 * 50 000') have been acquired.*

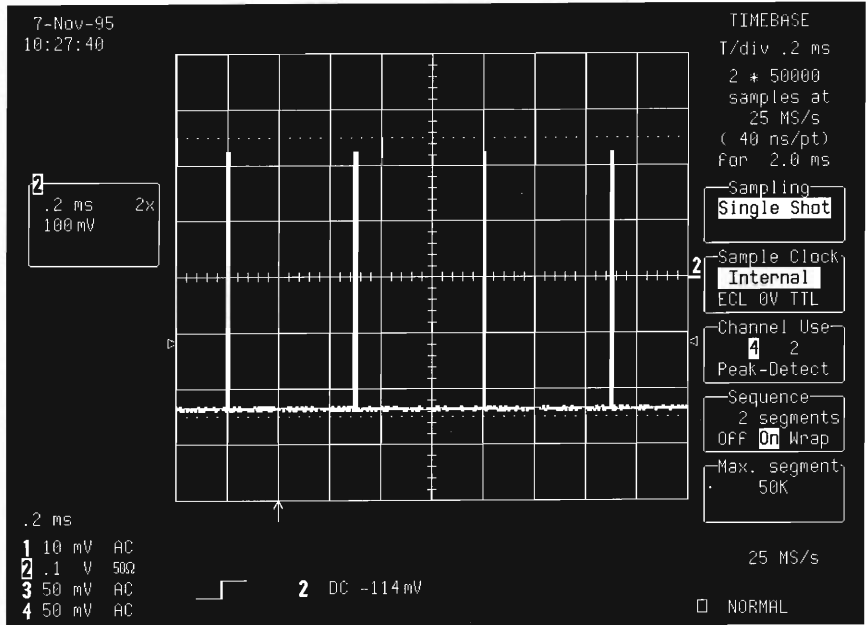

Tips: The bottom menu box shows the maximum number of points per segment—in this instance, 50 000 points. The sampling rate or the total number of acquired points can be adjusted.

The timebase setting in Sequence Mode is used for determining the acquisition duration of each segment— $10 \times \text{TIME/DIV}$. This setting, as well as the number of segments desired, the maximum segment length, and the total memory available, are used for arriving at the actual number of samples per segment, and the time per point.

Here, the Sequence Mode timebase of $2 \mu\text{s}/\text{div}$ has been selected (corresponding to a single train duration, as already covered at Step 5). The sampling rate is the maximum, and the two trains are captured with a very short delay between triggers. The acquisition is in fact two acquisitions, each a train of pulses.

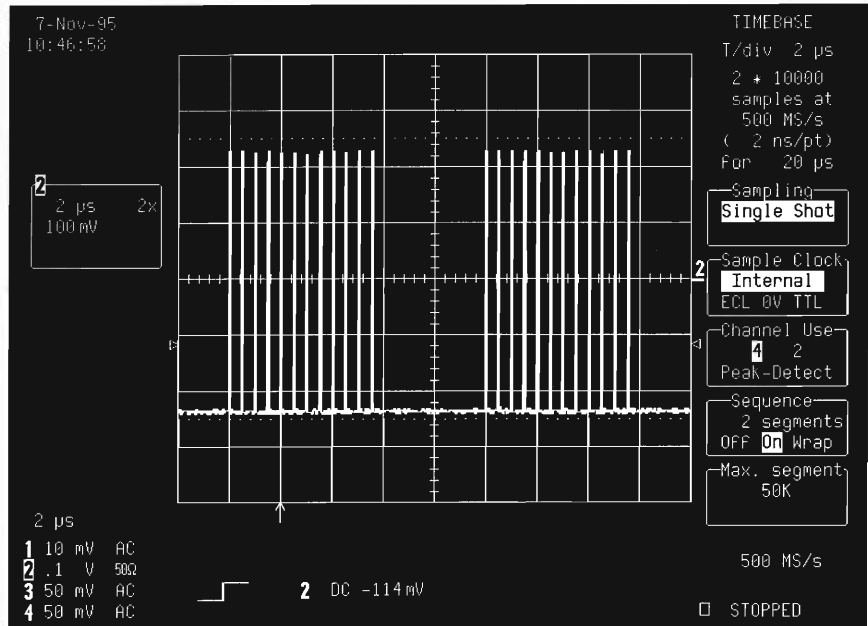



STEP 9

Turn  to set the number of segments.

On the example screen overleaf, the number of segments is set at eight.

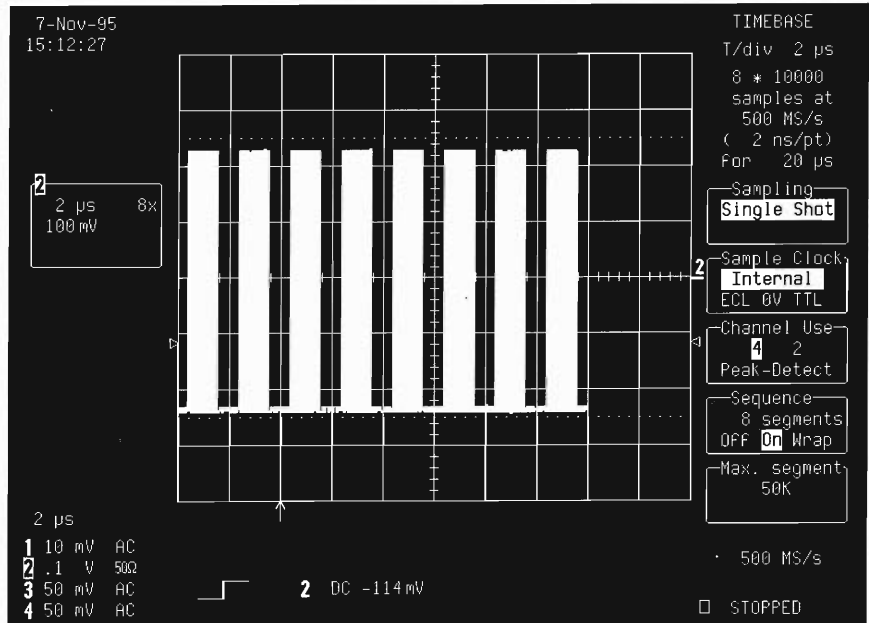
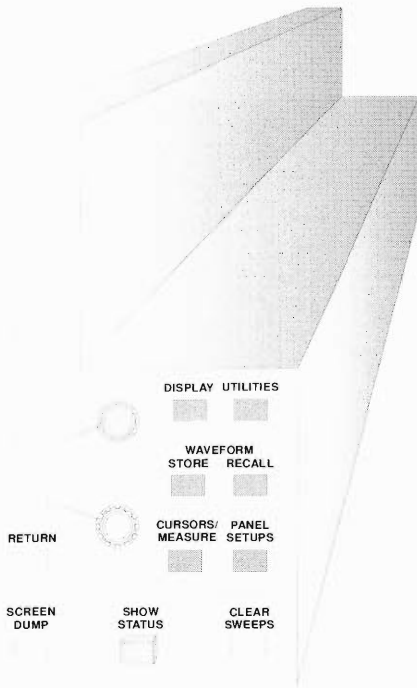
Note: The complete waveform with all its segments may not fill the screen entirely.



STEP 10 

Press  SHOW STATUS

Then (twice) press the corresponding menu  to select 'Text & Times' from the 'STATUS' menu.

Finally, the screen will display:

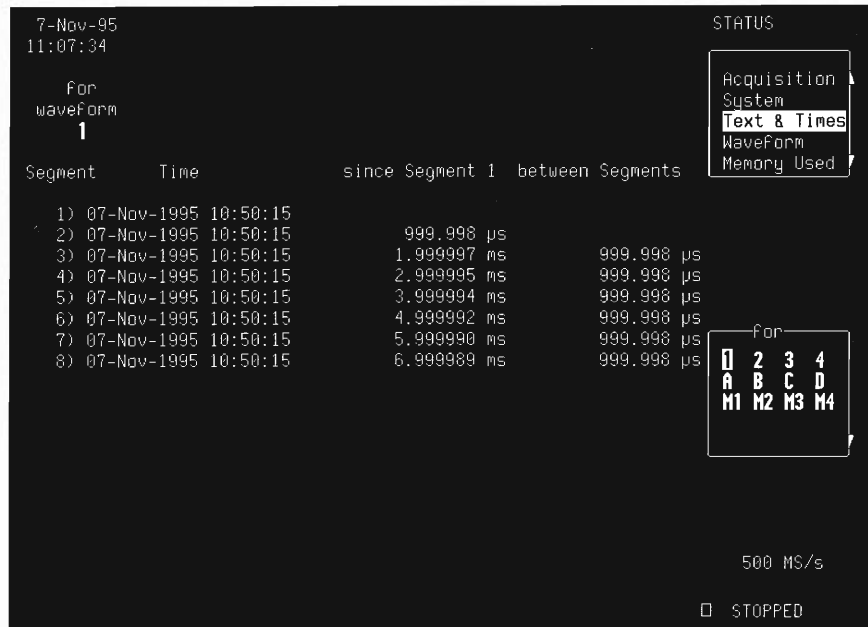

Time measurements are made between events on different segments of a sequence waveform using the full precision of the acquisition timebase. Trigger time stamps are given for each segment.

Tips: Each segment can be displayed using ZOOM, or used as input to the MATH package.

For remote operation, Sequence Mode can be activated for taking full advantage of the scope's large data-transmission capability.

Sequence mode is normally used for acquiring the desired number of segments and for terminating the waveform



acquisition. However, It can also be used with the WRAP option to acquire the segments continuously, overwriting older segments as required. A manual STOP order or time-out condition can then be used to terminate the acquisition.

*The operation of the STOP, SNGL, NORM, and AUTO buttons is modified when Sequence Mode is used (see Chapter 9 of the **Operator's Manual**).*

To ensure low deadtime between segments, button-pushing and knob-turning should be avoided during sequence acquisition.



The Scope as Spectrum Analyzer

The WP02 FFT (Fast Fourier Transform) option transforms the 9300-Series oscilloscope into a spectrum analyzer for frequency domain analysis. Showing the signal in the frequency domain, it eliminates the need for another, separate instrument. Explained here is how to measure signal power distribution as a function of frequency.

Application Setup

Connect the signal to be measured — a Dual Frequency Waveform of 0.5 MHz and 1.5 MHz — to CH 1.

STEP 1 

Reset: Press  , top menu  and  simultaneously.

Then press  to turn off Trace 2.

STEP 2 

Press 

Then press the corresponding menu  to select from the 'Coupling' menu the coupling matching the source's impedance — 50 Ω .





STEP 3 

AUTO
SETUP
Press 

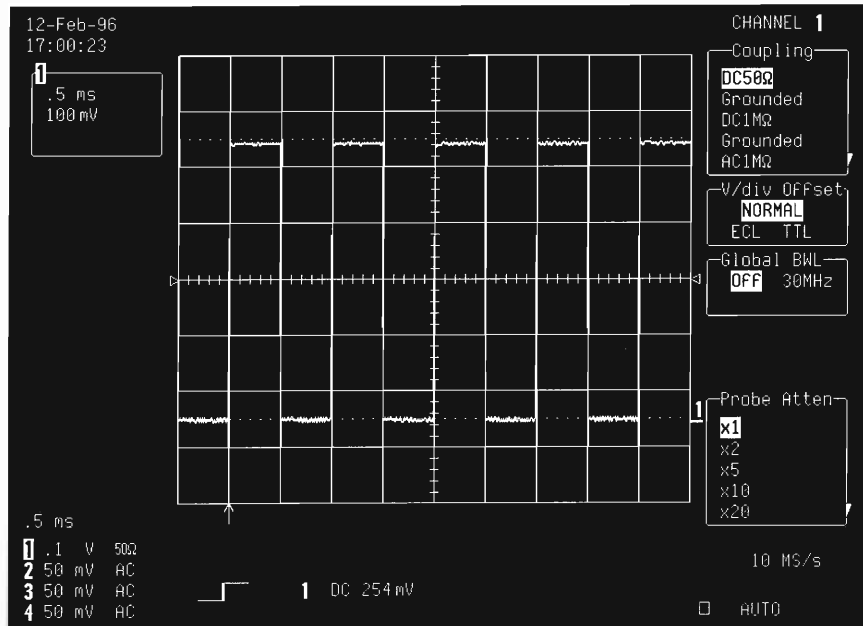
The screen will display:



STEP 4 

DISPLAY
Press 

STEP 5 

Press the corresponding menu  to select 'Dual' from the 'Grids' menu.

The screen will then display:

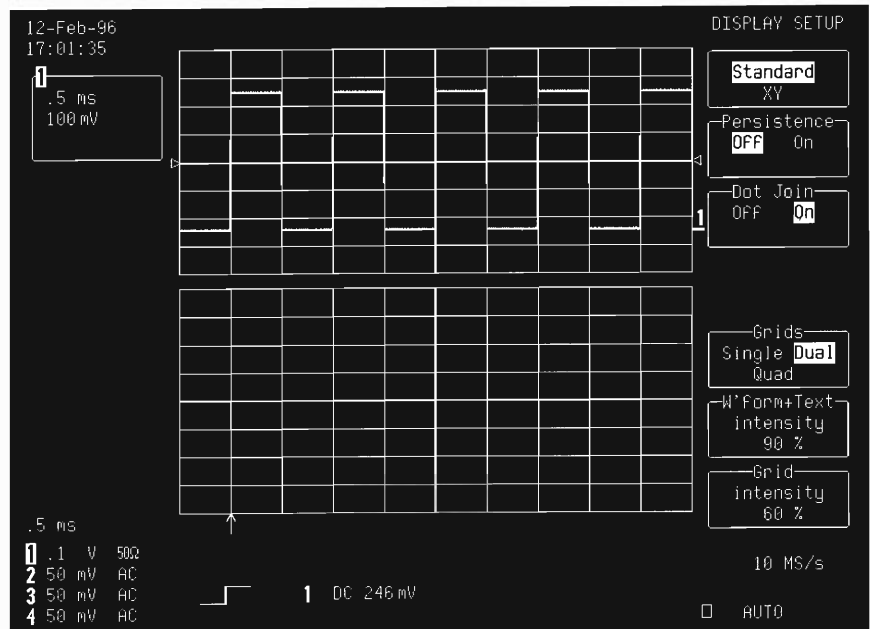



STEP 6 

Press 

STEP 7 

Press the corresponding menu  to select 'REDEFINE A'.

STEP 8 

Next, press the menu  to select 'Yes' from the 'use Math?' menu.

STEP 9 

Then press the menu  to select 'FFT' from the 'Math Type' menu.

STEP 10 

Now press  to turn on TRACE A.

The screen will now display:

Note: Several different types of FFT results, windows and sources can be selected from the 'FFT result' menu, shown here. See Appendix C of the Operator's Manual for details. On this screen, '**Power Spectrum**' has been selected for characterizing spectra containing isolated peaks.

FFT information is listed in the box beneath the grid, including:
Nyquist frequency — the input signal must have components of a frequency lower than that of the Nyquist in order to avoid aliasing;
 Δf — the distance in hertz between the center frequencies of two neighboring FFT bins, where
$$\Delta f = \frac{1}{\text{Time} / \text{Div} \times 10} ;$$

250 pts — the total number of FFT points.

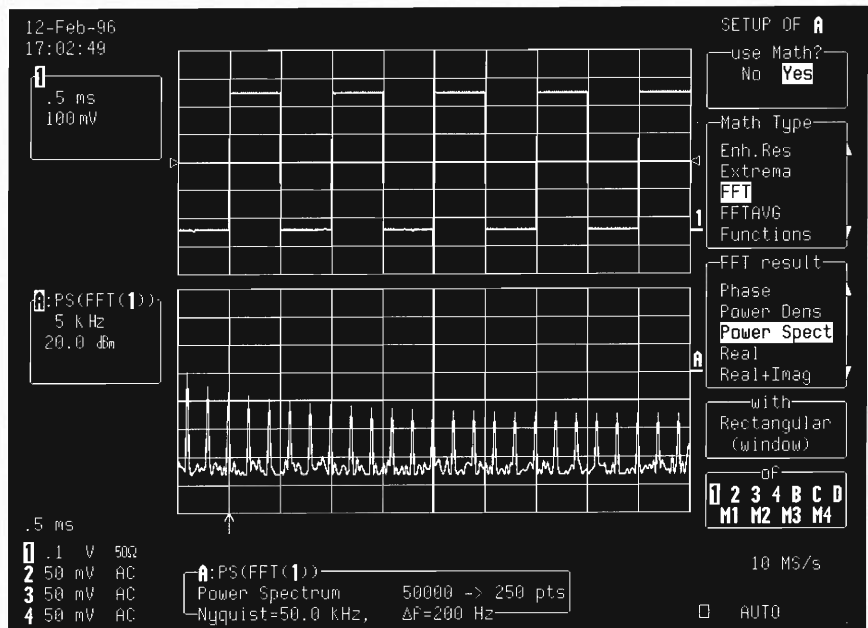

Tips: To enable any Math function to use more of the acquired data, press MATH SETUP and set 'for Math use Math points' to the maximum value — 10 million. The scope will use all of the acquired data. Calculations will be slower but more accurate. In this example, the FFT is performed on all 5000 points of acquired data.

STEP 11

Turn  to move the trace to the right of the screen and zoom the lower frequencies.

The screen will then display:

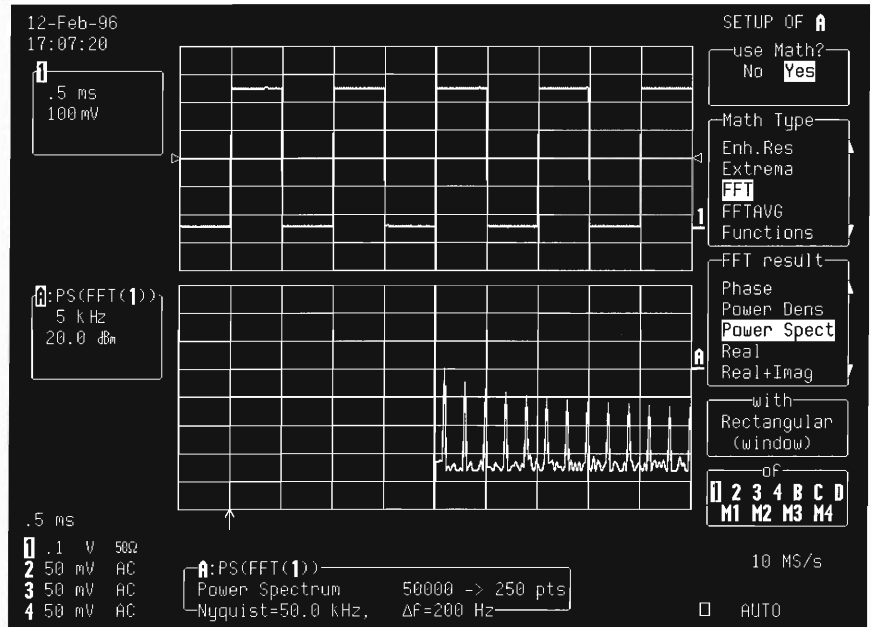

STEP 12

Turn  to obtain details of the lower frequencies.



The screen will then display:

Note: The scale in the 'Trace A' trace label at left-of-screen changes when zooming. Here, the dual frequencies are 1 kHz and 3 kHz.

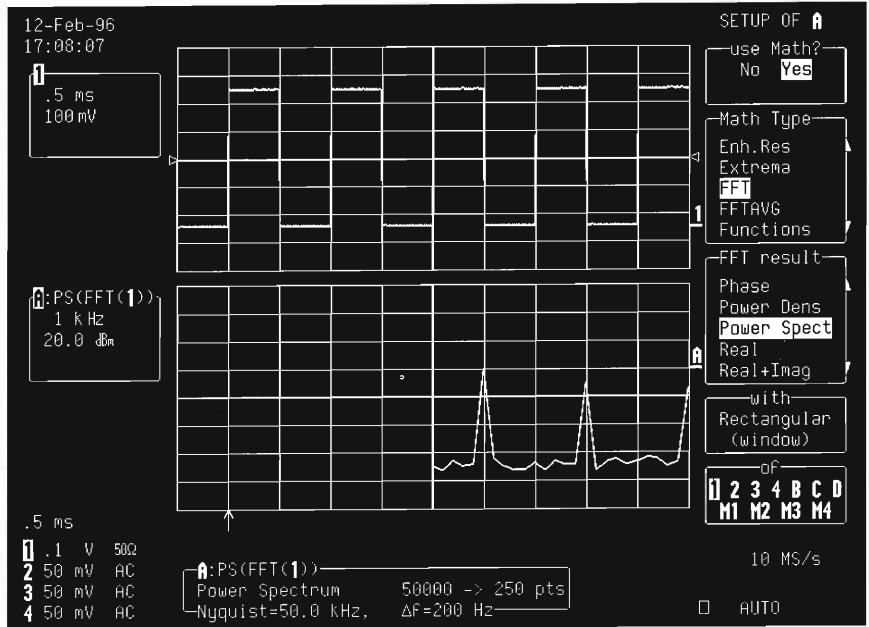

Tips: The frequency resolution can be made greater by increasing the number of points acquired. There are two ways of doing this — either by increasing the value in the TIMEBASE 'Record up to' menu, or by selecting a slower timebase whilst keeping the same sampling rate.

Measuring Skills

Note: Rather than zoom the FFT directly, it is possible to zoom on a copy of the FFT on Trace B (as is shown here), C or D.

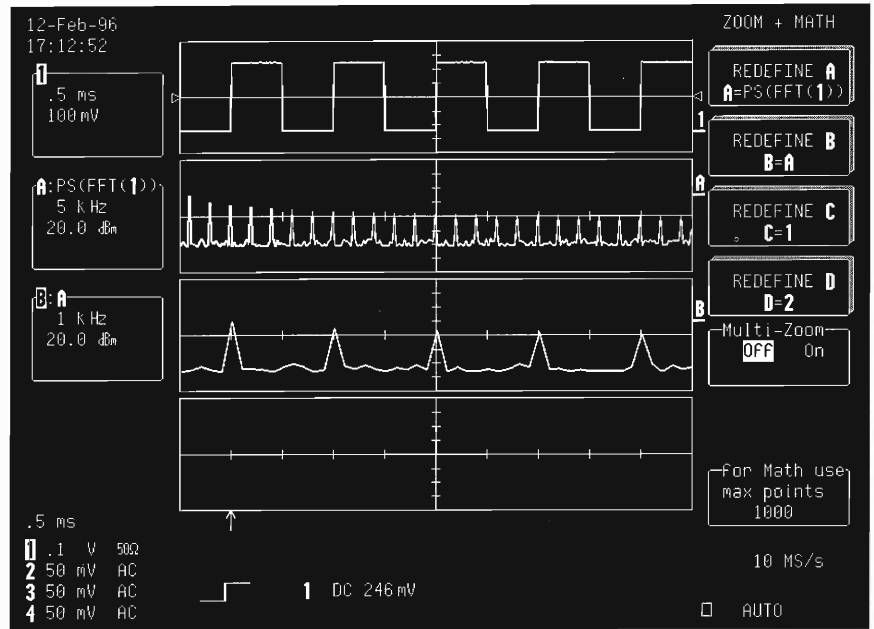

(From top) Squarewave signal, FFT and FFT zoom on Trace C:





Precision Analysis with Histograms

The WP03 Waveform Processing option — a powerful tool for the statistical analysis of waveform parameters — allows histograms to be made for any supported parameter, for quick, precise acquisition information.

The following tutorial shows how to use this parameter-distribution-analysis firmware with histogram to display and calculate signal jitter distributed across acquisitions.

Software Required

WP03 optional parameter-distribution-analysis firmware with histogram for the 9300-Series oscilloscopes .

Application Setup

Connect the signal to be measured — which should show edge jitter — to CH 2.

STEP 1 

Reset: Press  , top menu  and  simultaneously.

Then press  to turn off Trace 1.

STEP 2 

Press 

Then press the corresponding menu  to select from the 'Coupling' menu the coupling that matches the source's impedance — 50 Ω.

STEP 3 

Press 

STEP 4 

Turn  to select a single period of the signal.

The screen will display:

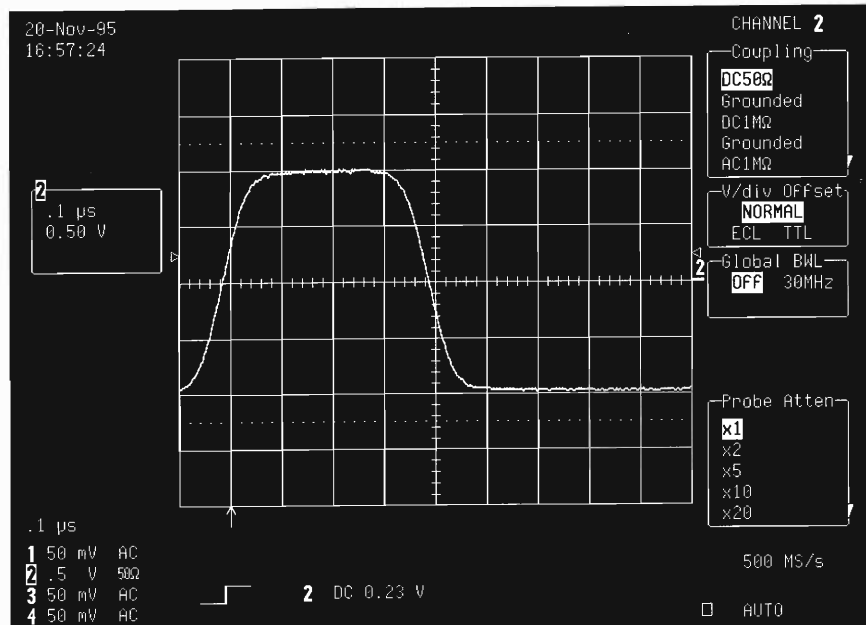



Tips: Persistence Mode can be used to show the width variation, or jitter, of the acquired signal. By pressing DISPLAY and then the corresponding menu button to select On from the 'Persistence' menu, the signal can be displayed with edge jitter in persistence mode, as shown here. Persistence should then be turned off.

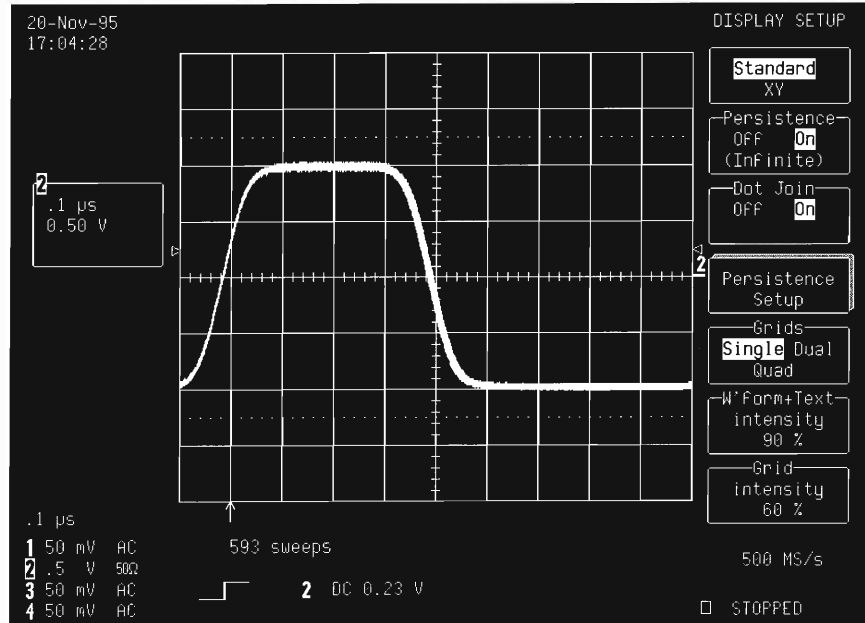



STEP 5 

Press  and then the corresponding menu  to select 'Yes' from the 'use Math?' menu.

The screen will now display:

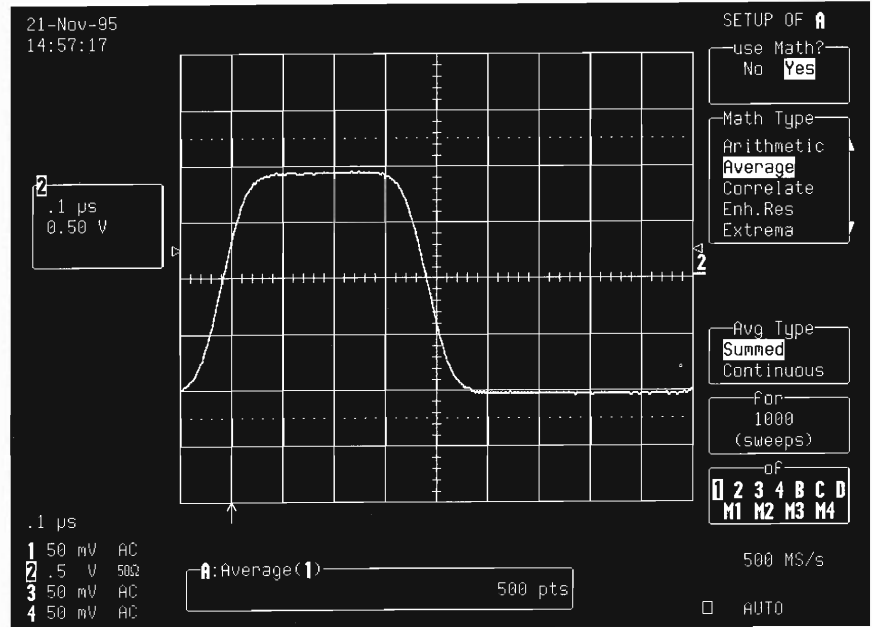
Note: The Average function in the 'Math Type' menu is selected by default. All functions that can be set up with all three of the available software options — WP01 (time domain arithmetic processing), WP02 (Frequency Domain Fast Fourier Transform/FFT) and WP03 (parameter distribution analysis firmware with histogram) — are shown in the menu. The availability of the various functions themselves depends on which of the three options are installed in the oscilloscope and thus which functions are supported.



STEP 6 

Press the corresponding menu  to select 'Histogram' from the 'Math Type' menu.

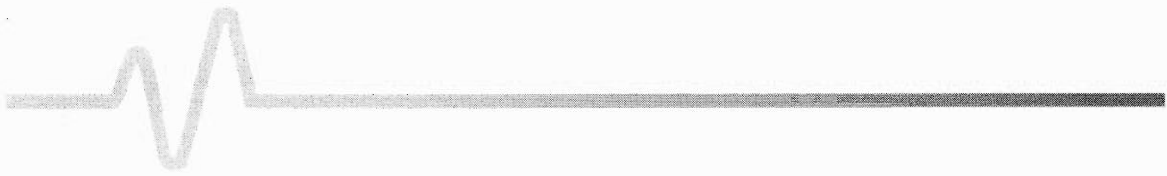

The screen will display:

Note: The Histogram function records the selected parameter values and presents data in a statistical form. It produces a waveform consisting of one point for each histogram bin, where the value of each point is equal to the number of parameter values falling into the corresponding bin. Analysis of histogram distributions is supported by a wide range of automated statistical parameters, and provides insight into, and quantitative analysis of, difficult-to-measure phenomena.

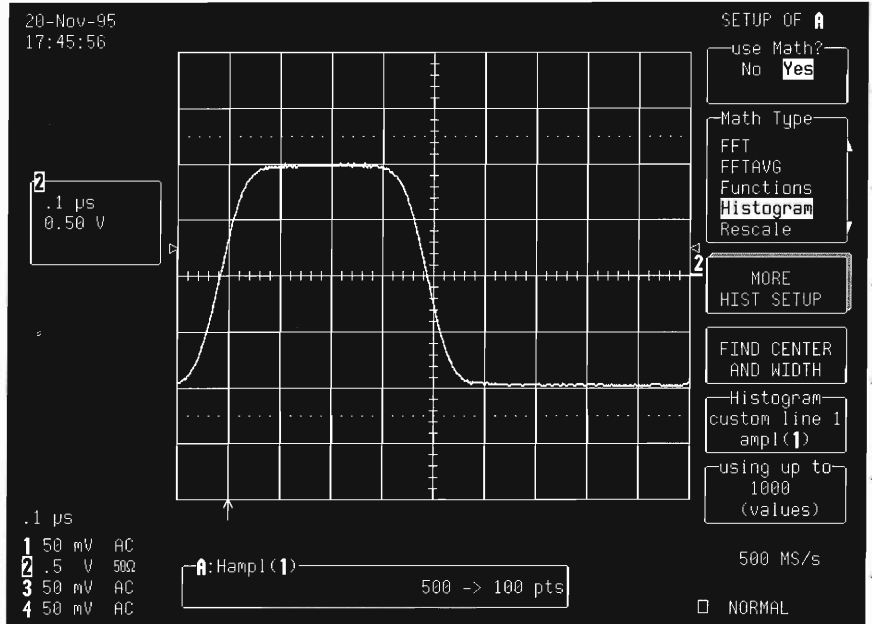

STEP 7

Press the corresponding menu  for 'MORE HIST SETUP'.

The screen will now display:

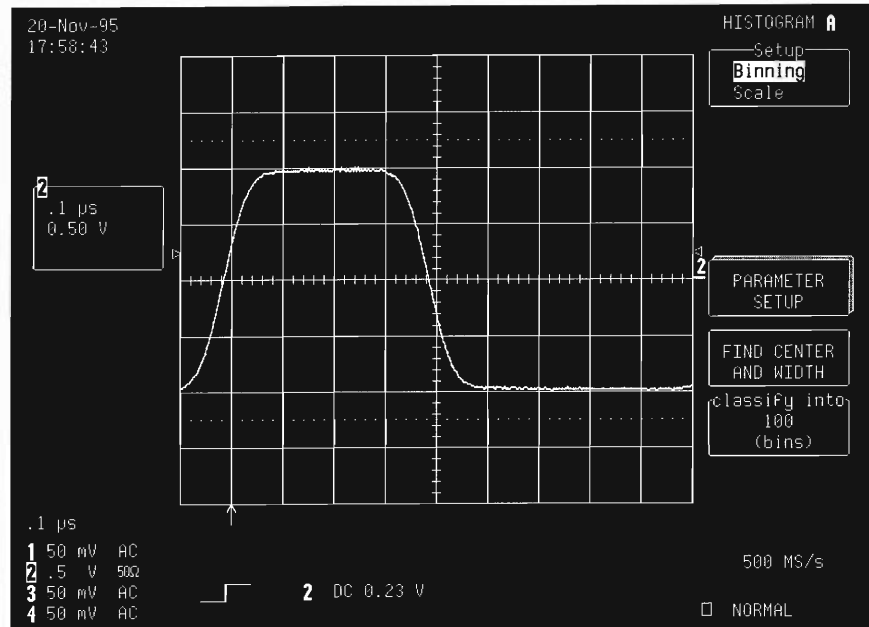

STEP 8 

Press the corresponding menu  for 'PARAMETER SETUP'.

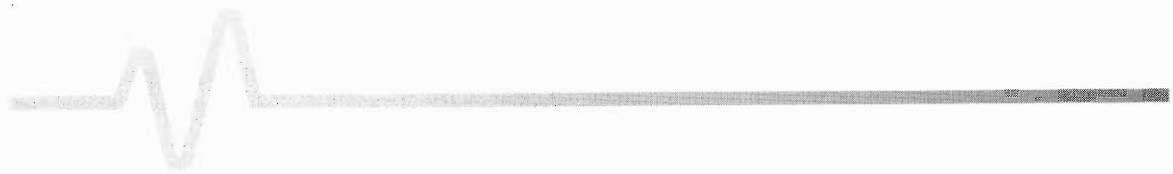

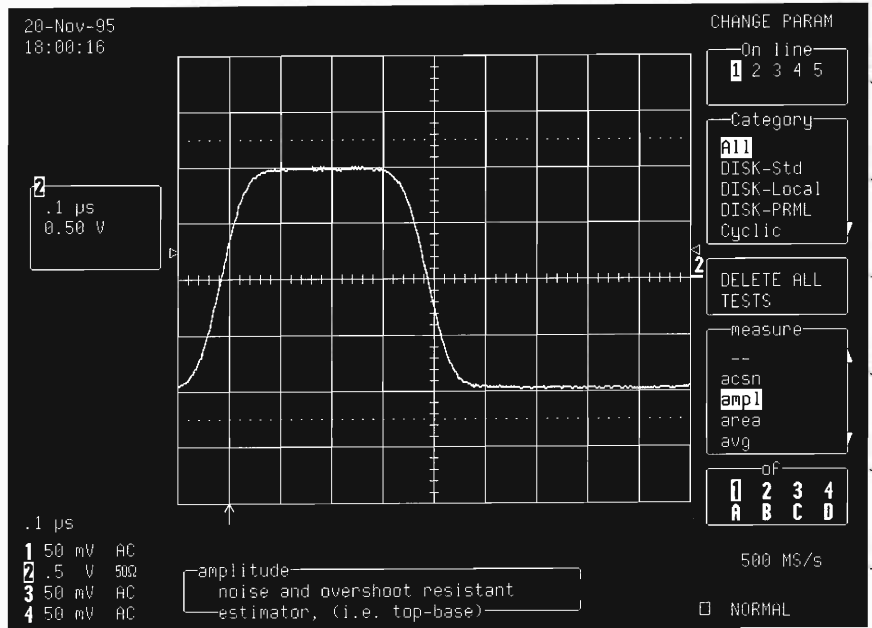

The screen will display:

Note: The software options installed in the oscilloscope determine which sets of parameter categories are available from the 'Category' menu. Categorizing the parameters simplifies their selection. For example, those parameters useful for characterizing histograms are grouped under 'Statistics' (further down the menu and not visible here). And, as the name suggests, 'All' category covers every parameter.



STEP 9

Press the corresponding menu s or turn  to select from the 'measure' menu the parameter for which the histogram is to be made — **width** in the example screen that follows.

Then press  or turn  to select the channel on which the measurement will be performed — **'2'** in this case.

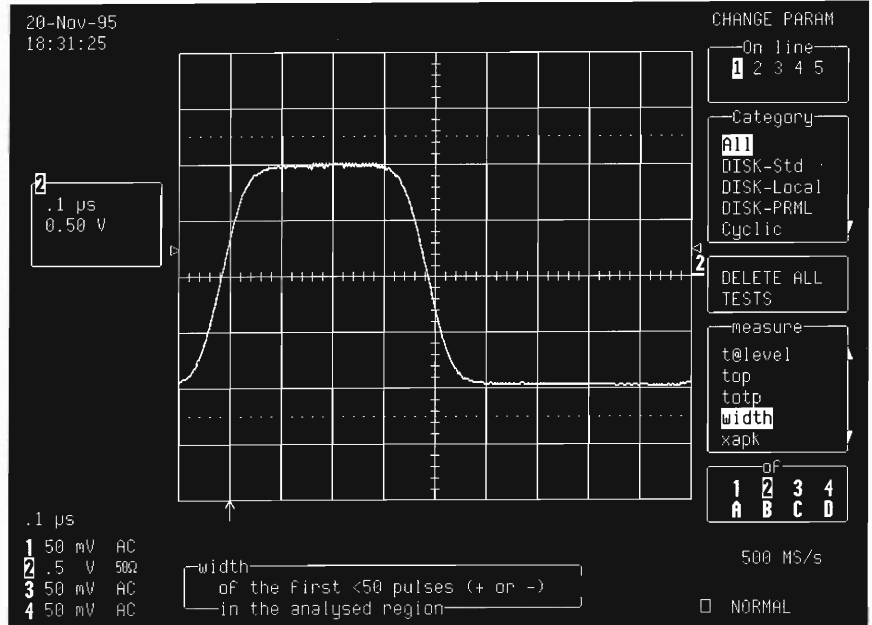

Measuring Skills

Note: A short definition of each parameter selected is displayed under the grid. (See the Operator's Manual or option directions for more details.)



Tips: Press the menu button for **DELETE ALL TESTS**. This menu is particularly useful if preliminary parameters have been set up in a previous acquisition, and ensures that the newly chosen parameters form the required set.

STEP 10 

TRACE ON/OFF
Press  2 to turn off CH 2, then press  A so that only Trace A — the histogram of the width of the trace acquired on CH 2 — is displayed.

The screen will display:

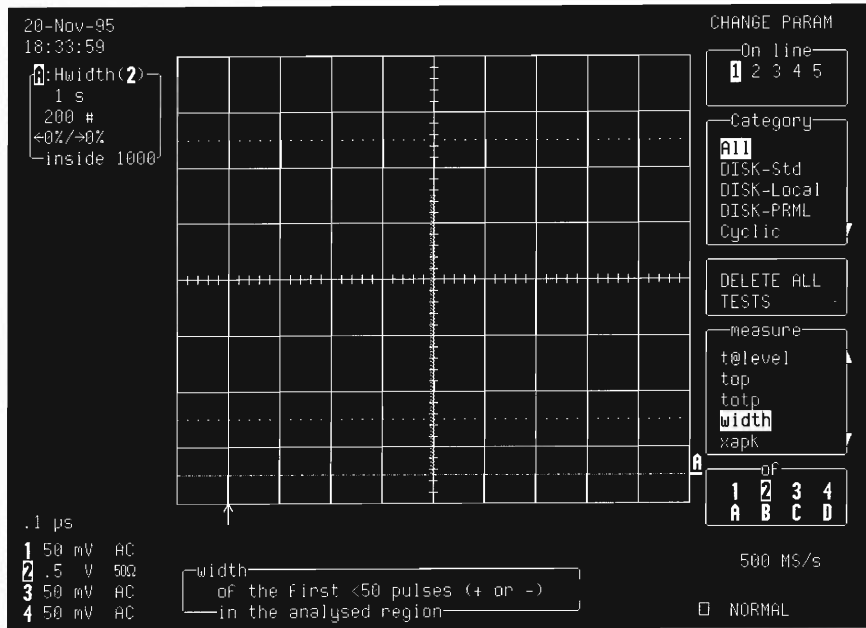

STEP 11 

RETURN

Press  to go back to the preceding menu, allowing the histogram to be set up.

Then press the menu  for 'FIND CENTER AND WIDTH'.

As shown on the next screen, the horizontal axis is set to a new scale, accurately showing the distribution.

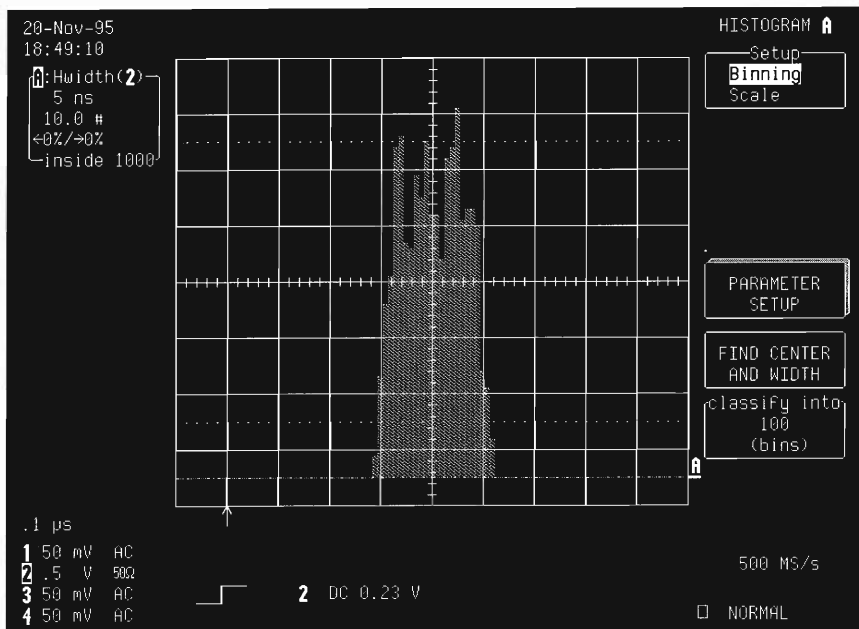
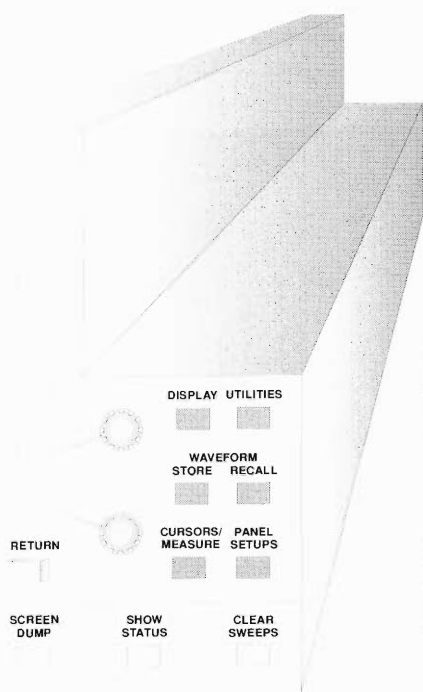

Note: The trace label shows the horizontal scale — here, 5 ns/div, which corresponds to the width values. It also displays the vertical scale — here, #10/bin, corresponding to the number of acquisitions for the same width value. As well, it shows the percentage of width values off-screen left and right — in this example, all width values are within screen limits. And, finally, it displays the number of acquired and measured parameter values used to create the histogram.

All values displayed in the trace label can be changed as required. Because Trace A is a function, horizontal and vertical scales and positions — and thus zoom — can be used for the histogram. Pressing the RESET button cancels all changes and displays the original histogram.

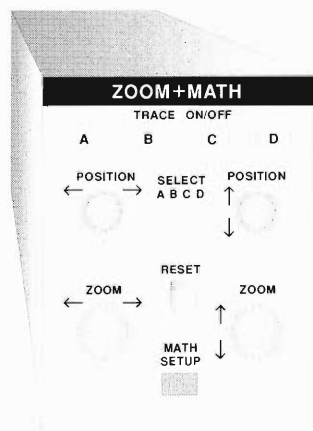



This screen shows a histogram whose horizontal and vertical display parameters have been adjusted.

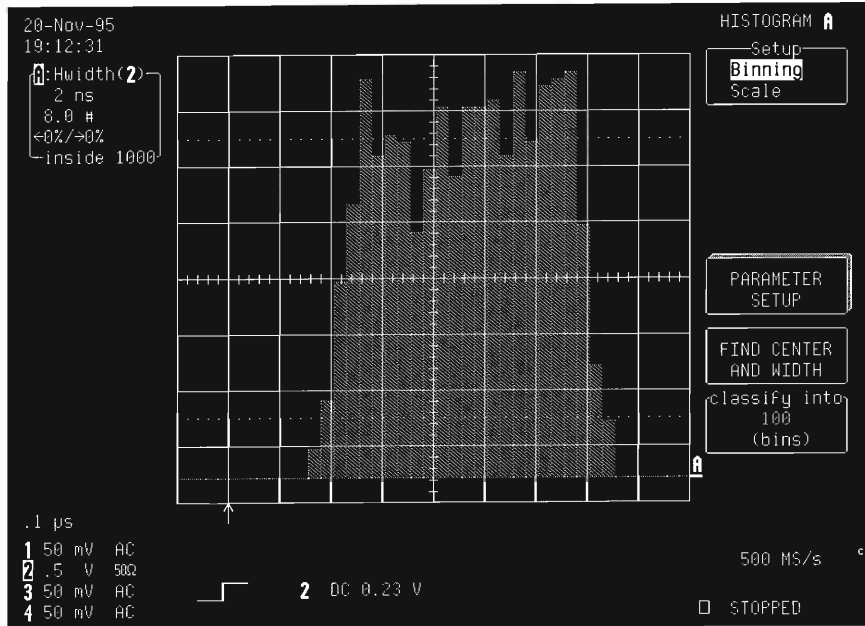

Turning  will change the number of bins that classify the different parameter values. When this number is changed, the new horizontal scale is adjusted and displayed in the trace label, as shown on the facing page.

This screen shows the histogram after bin-number adjustment:

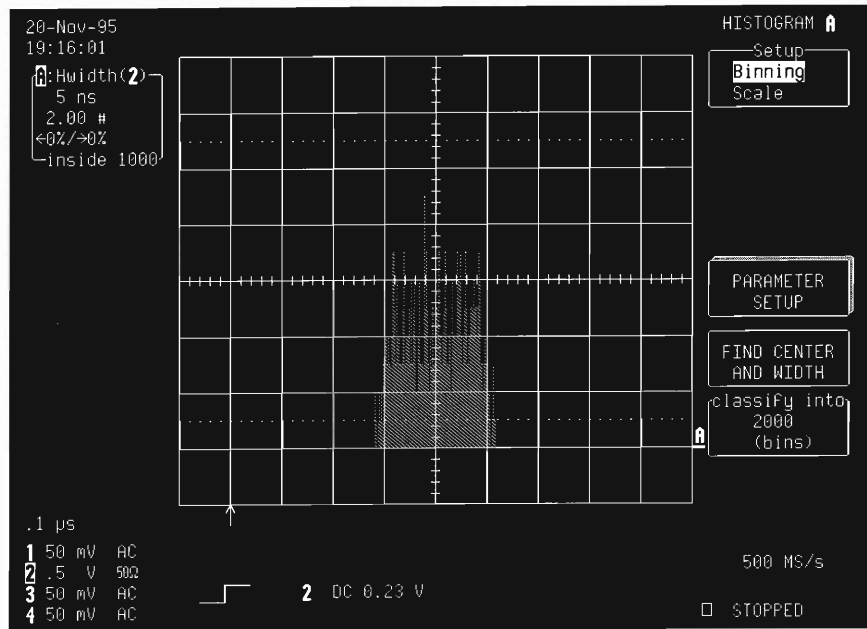

Tips: As many as two billion measurements can be included in a parameter histogram display. This limit is set by pressing the RETURN button in order to go back to the SETUP OF A menus. The appropriate menu button or knob is then used to set the required limit in the 'using up to' menu box (see screen following Step 6)

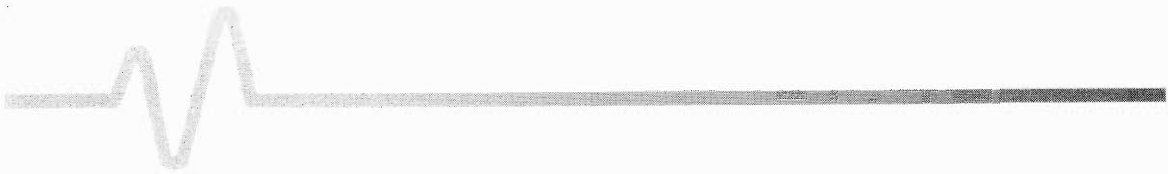



The final steps in this tutorial describe how to select parameters that characterize the histogram. Many statistical measurements can be made on the histogram for analysis of the characteristics of selected parameters — including the highest value, standard deviation, and the most common value of the histogram.

STEP 12 

CURSORS/
MEASURE

Press 

Then press the top menu  to select 'Parameters' from the top menu box, and the corresponding menu  to select 'Custom' from the 'mode' menu, thus choosing Custom Parameter mode.

The screen will display:

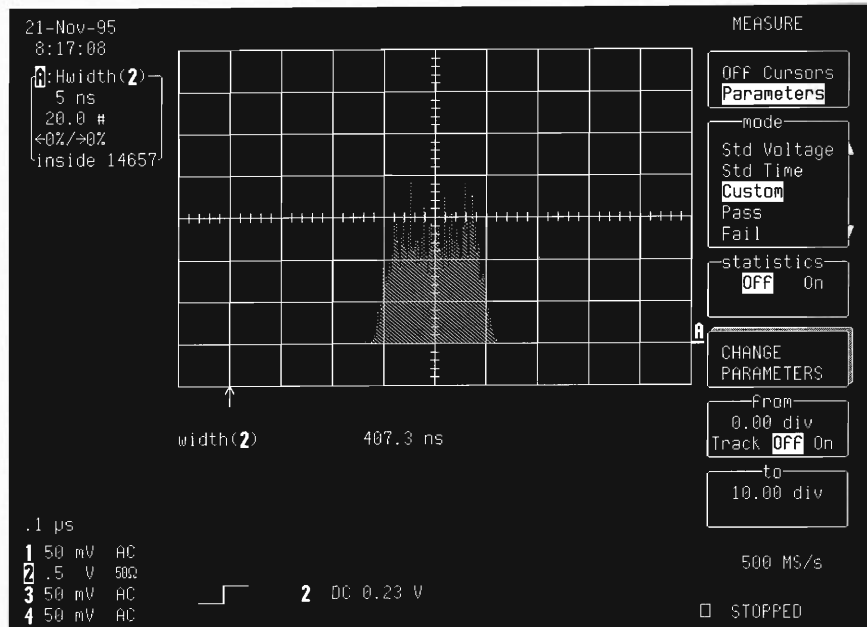

STEP 13

Press the corresponding for 'CHANGE PARAMETERS.

The screen will display:

Note: The Custom Parameter mode allows up to five parameters to be selected. The width parameter, set earlier in the 'Histogram' menu (Step 6), must be retained on line '1' in the 'On line' menu, as it has been used in the calculation of the histogram. However, the four other parameters may be added.

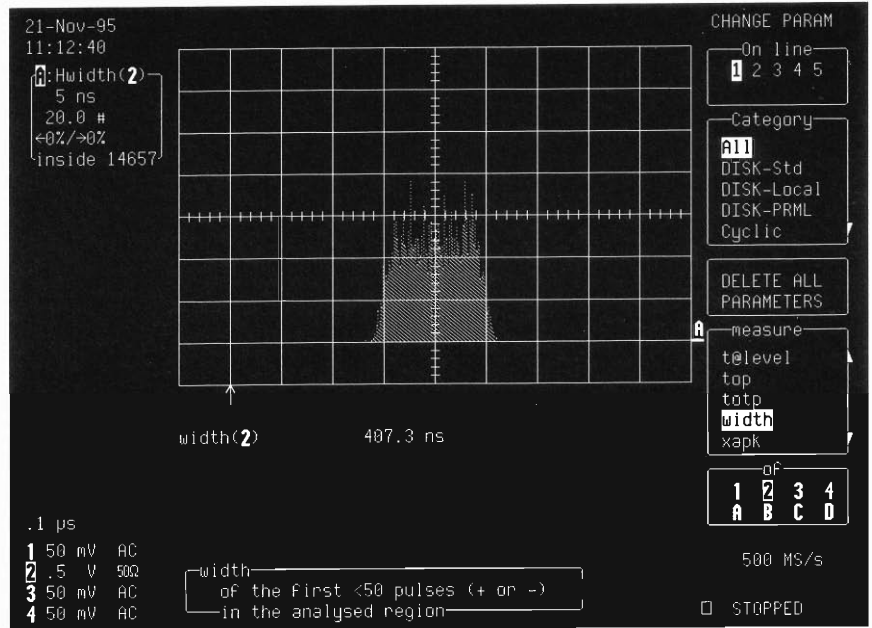

STEP 14

Press the top menu to select a line other than '1' from the 'On line' menu (to change this would lose the histogram data!).

Next, press the corresponding menu to select 'Statistics' from the 'Category' menu.

And then press the corresponding menu four times to select Histogram 'A' from the 'of' menu.

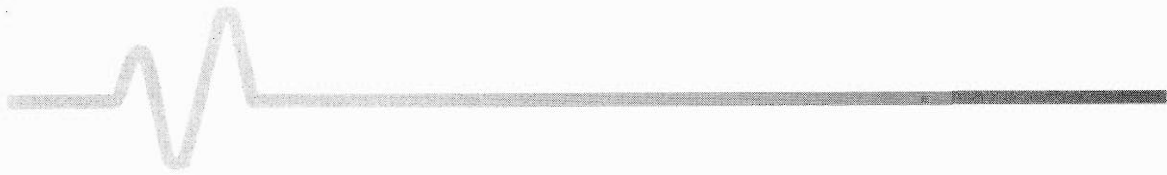

The screen will display:

Note: Step 14 may be repeated, adding four additional parameters for characterizing the histogram. A description of each of these parameters is given on-screen under the grid in accordance with the parameter selected.

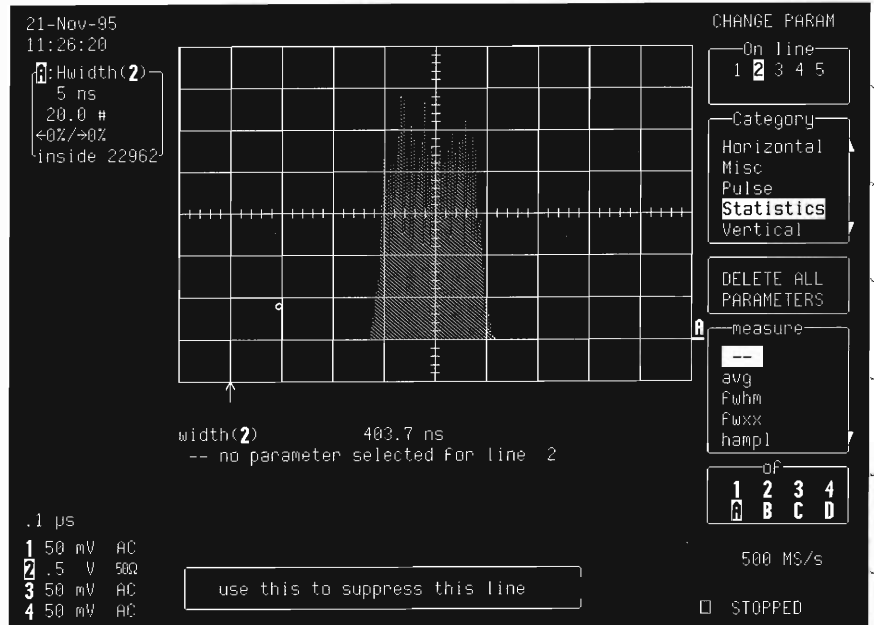

The next and final screen in this tutorial shows four different parameters characterizing the histogram of the width.

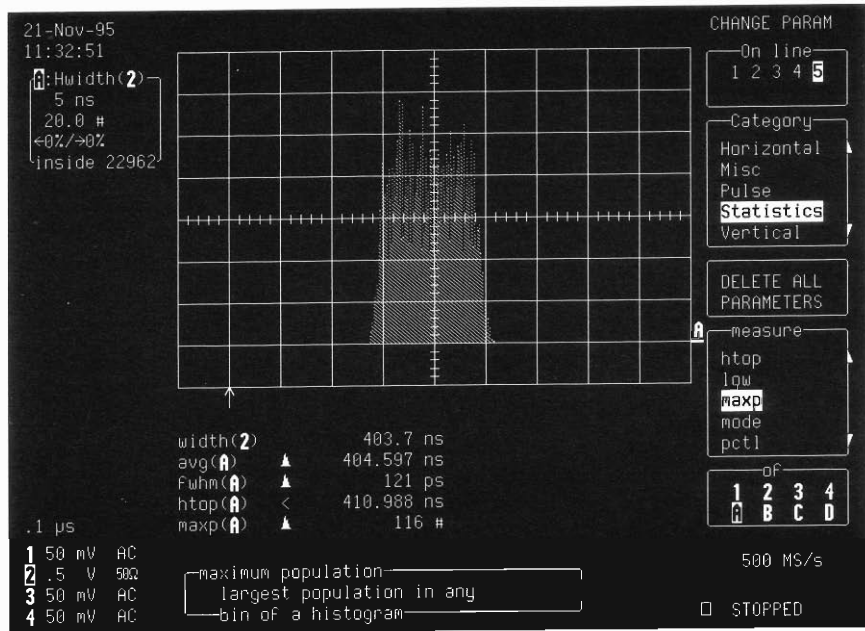

Tips: All the parameter values can be read on PC with the optional remote control using the PAVA? query .

Statistics On can be performed for all parameters. As shown on the final screen in this tutorial, four different values are displayed for each parameter. These are: average, lowest, highest, and sigma — the last being the standard deviation of the data values from the mean values.

Parameters can be applied to a chosen section of the histogram using the parameter cursors in the measure menu (see the following tutorial, Characterizing a Pulse).

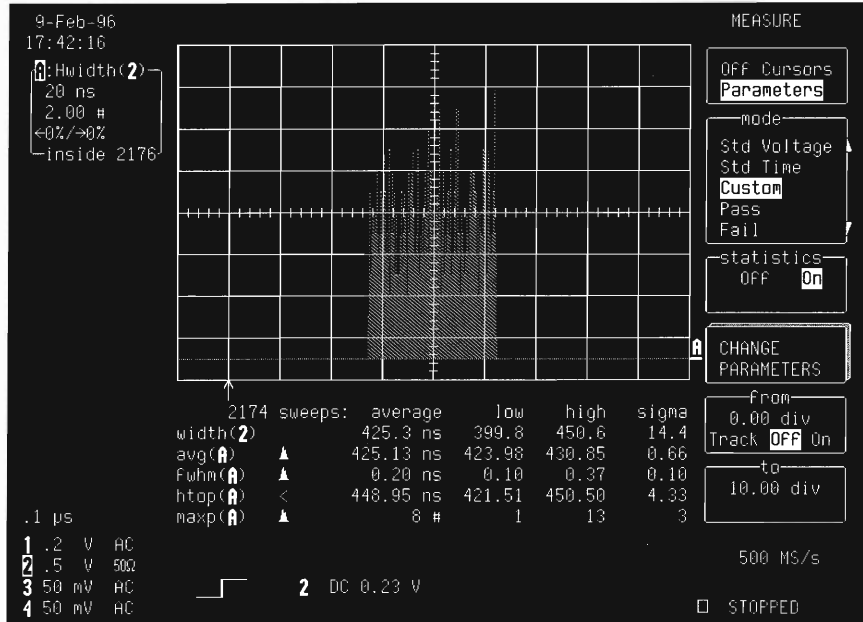
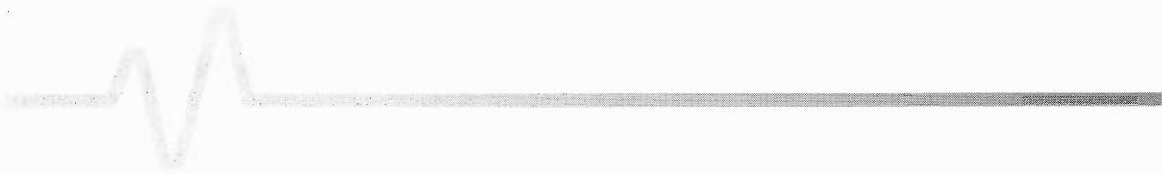

Interpolation = More Information

The Sin(x)/x interpolation — a standard feature of all LeCroy oscilloscopes — powerfully processes data acquisitions of a few sample points. It places nine interpolated sample points between each of the original data samples. This preserves the identity of the original raw data, allowing differentiation of raw data points from interpolated ones.

Because it must respect the Nyquist limit to avoid aliasing, it can be used only on signals having frequency components of less than half the sampling rate — here, a simple sinewave.

Application Setup

Signal to acquire on CH 2: 100 MHz sinewave

STEP 1 

Reset: Press  , top menu  and  simultaneously.

Then press  to turn off Trace 1.



STEP 2 

COUPLING

Press 

Then press the corresponding menu  to select from the 'Coupling' menu the coupling matching the source's impedance — 50Ω .

STEP 3 

AUTO
SETUP

Press 

The screen will display:

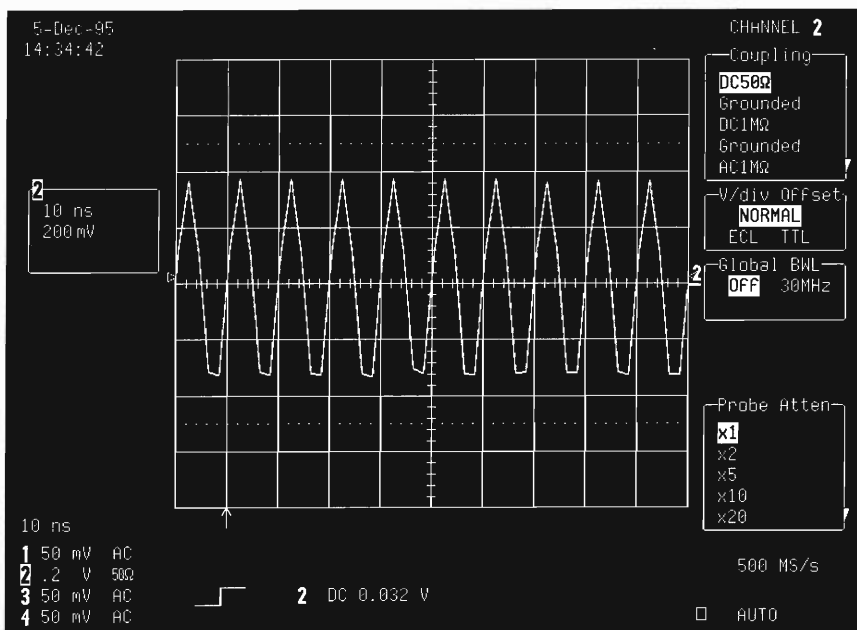

Tips: The 100 MHz sinewave is sampled at a rate of 500 MS/s. Thus each signal period has just five points — at the limit of obtaining a good representation of the signal.

Using the DISPLAY menus, one can show only the dots representing those points acquired. This is done by pressing the appropriate menu button to select **Off** from the 'Dot Join' menu, as shown here.

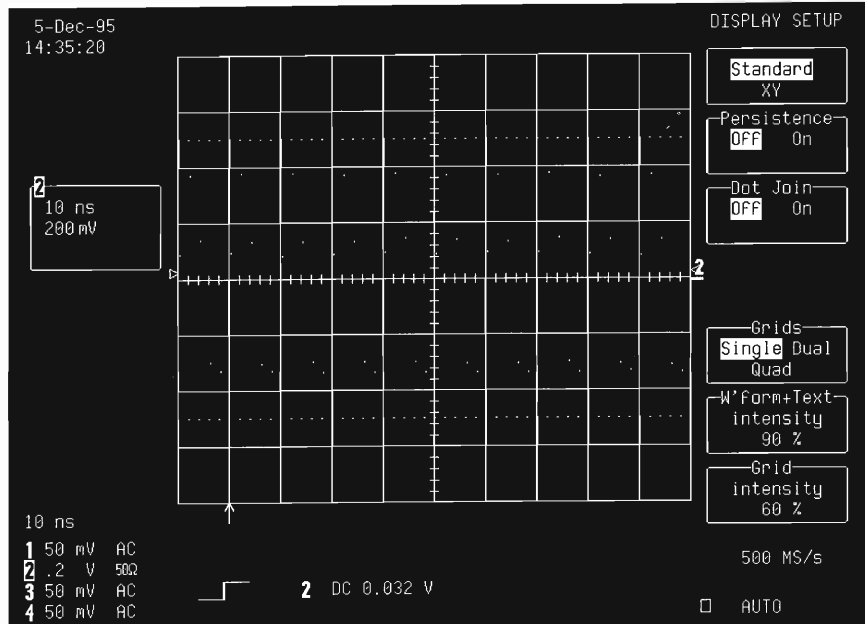

The number of points acquired, the time between the points, and the sampling rate of the acquisition are displayed when the TIMEBASE SETUP button is pressed. In this example, only 50 points are acquired, with 2 ns between each.

STEP 4 

**MATH
SETUP**
Press 

Then press the corresponding menu  to select 'REDEFINE A'.

The screen will display:

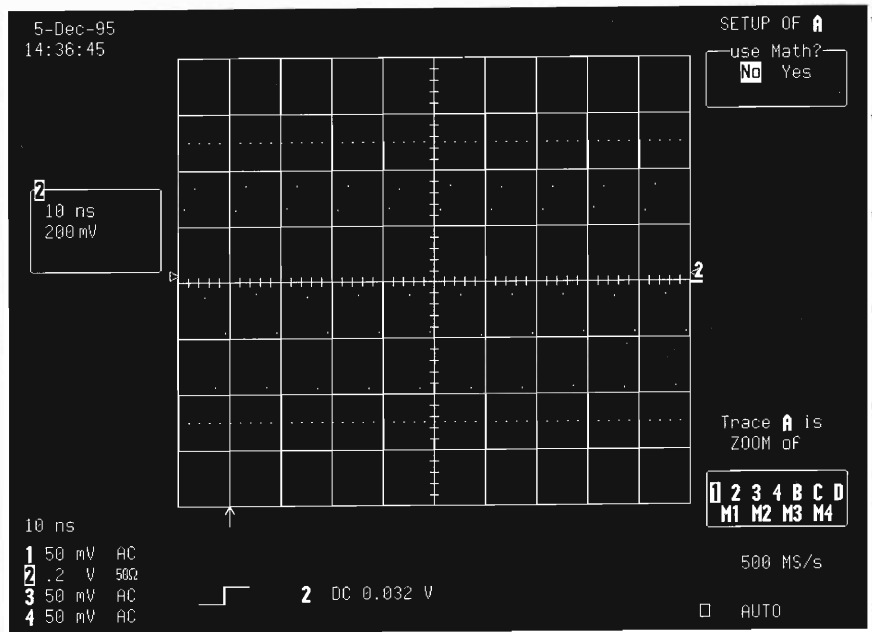

STEP 5 

Press the corresponding menu  to select 'Yes' in the 'use Math?' menu, then to select 'Functions' from the 'Math Type' menu.

The 'Math Type' Menu and the Software Options...

With each software option installed in your 9300-Series scope a different list of features becomes available for selection from the 'Math Type' menu. All the options and what is offered by each are set out here.

Standard

Summed Average up to 1000 sweeps, Arithmetic Operations (Add, Subtract, Multiply, Divide, Negate, Identity), and $\text{Sin}(x)/x$ interpolation function.

WP01

Summed Averaging up to one million sweeps, Continuous Averaging up to 1024 sweeps, Reciprocal, Rescale, Absolute Value, Derivative, Integral, Logarithm (e), Logarithm (10), Exponential (e), Exponential (10), Square, Square Root. Plus Enhanced Resolution — digital filtering allows 0.5–3-bit vertical resolution improvement.

WP02

Frequency domain analysis (FFT and FFT Power Averaging), as well as Rescale in both time and frequency domains.

WP03

Histogram function for over 40 different parameters and 18 histogram parameters.

STEP 6

Press the corresponding menu s to select '**SinX**' in the 'Function' menu, then to select '**2**' from the 'of' menu.

Note: With the $\text{Sin}(x)/x$ interpolation selected, a label appears under the grid giving information on the function. Here, the interpolation will generate 500 points from the 50 of the original trace. The sampling rate is 500 MS/s and the Nyquist Frequency limit 250 MHz. The 100 MHz sinewave signal contains components whose frequency is lower than the Nyquist. The interpolation $\text{Sin}(x)/x$ can be performed without aliasing.

The screen will now display:

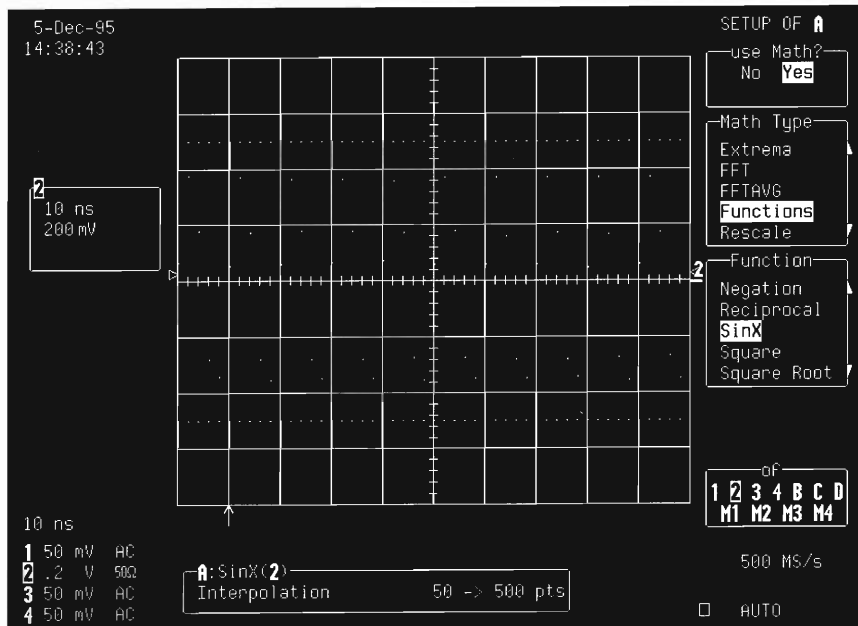

STEP 7 

DISPLAY
Press 

Then press the corresponding menu  s to select 'Dual' in the 'Grids' menu.

Tips: Two traces can be displayed in each grid in Dual Display Mode. The first or upper grid's traces are described in the two upper (first and second) trace labels, whilst the two traces corresponding to the lower (third and fourth) trace labels are displayed in the second grid.

Measuring Skills

On the previous screen, CH 2 is in the second position. The next trace selected for display will be in the first position and both traces in the upper grid. To display CH 2 and Trace A each on a different grid, CH 2's trace label must be placed in the first position — done by pressing the CH 2 TRACE ON/OFF button off and on successively (see screen below). TRACE A will then be placed automatically in the third position and thus displayed in the second grid.

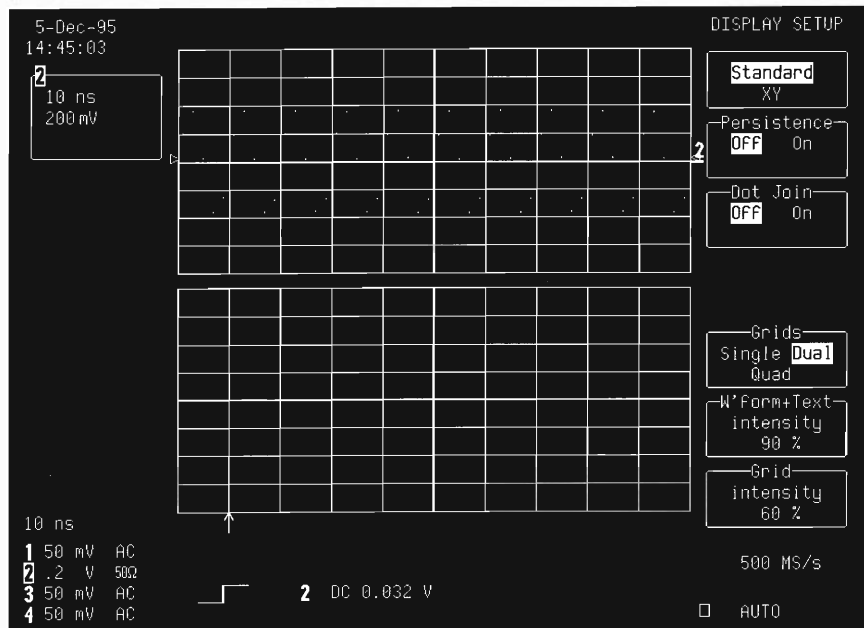

STEP 8 

Press **A** to display the interpolation of CH 2.

The screen will display:

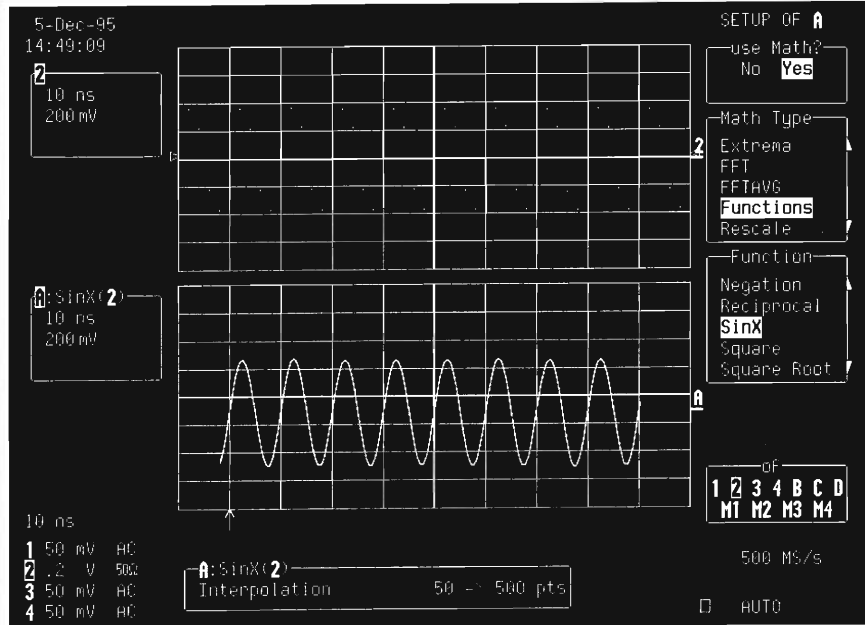

Tips: The $\text{Sin}(x)/x$ function is limited to 5000-point traces — a limit justified by the fact that an interpolation is designed to be performed on traces of only a few points. In addition, this limit avoids increasing the time taken for the calculation.

The exception, which needs to be approached a little differently, is acquisitions performed with a slow timebase. An example of this would be an acquired sinewave having 10 000 points but only four points per period. In such a case it is impossible to increase the number of points. However, the problem is solved by selecting a zoom of less than 5000 points on which to perform the $\text{Sin}(x)/x$ interpolation.

Measuring Skills

Note: Details of Trace A can be displayed using the vertical and the horizontal position and zoom knobs. In the final screen shown here, the timebase of A has been changed to show a detailed period of the signal on CH 2. There are 50 points per period on the interpolation of A, giving a better representation of the acquired sinewave when compared with the original CH 2 signal.

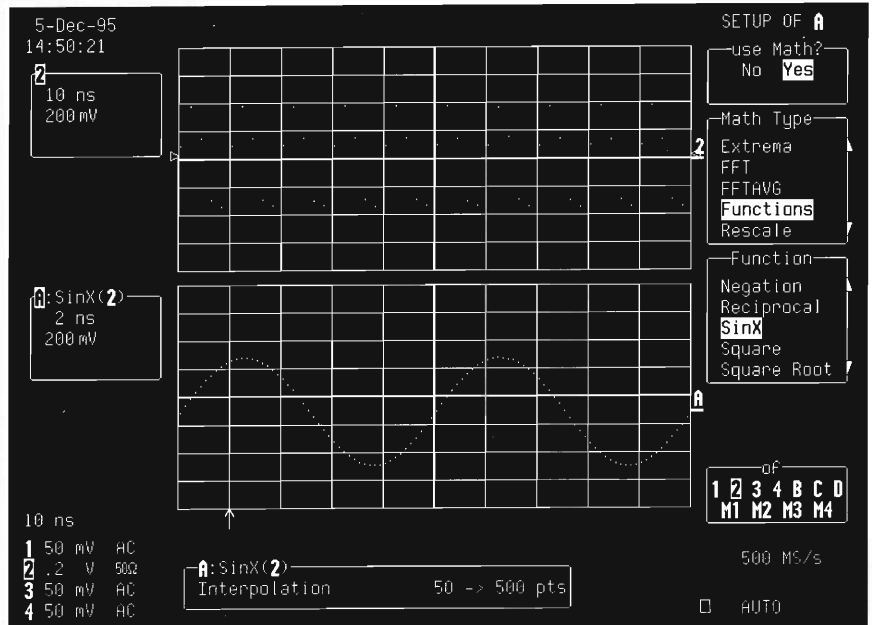

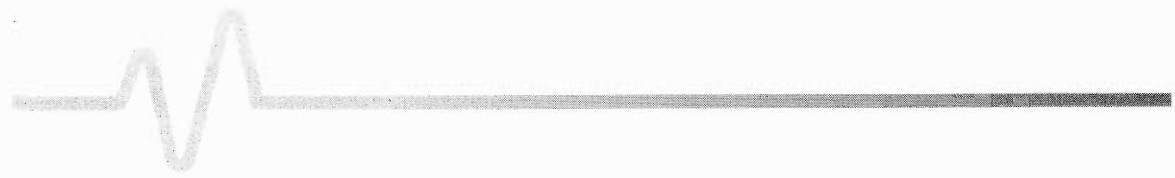

Testing Against a Telecom Mask

The scope's capacity to test waveforms against a defined mask makes possible the telecom measuring of pulse-shaped signals to CCITT, ANSI and ISDN standards, without mylar overlays. Mask measurements that would be time-consuming with analog machines become automatic with LeCroy's TC1 software. And the scope's computed Pass/Fail function offers greater accuracy along with ease in repeating measurements.

Another plus: when a test fails, a TTL pulse output (for example) can be used to drive a separate test device — eliminating the need for expensive production-testing software. Test masks are available on memory card or floppy and can be used on any LeCroy scope fitted with either of these options. Simply insert one or the other medium to transform the scope into a telecom physical-layer tester.

Software required

TC1, 27 Telecom Masks, option from LeCroy on floppy (Model 93XX-FD-TCI) or memory card (93XX-MC-TCI).

Application Setup

Connect the signal to be measured — and tested against the telecom mask — to CH 2.

STEP 1

Reset: Press  , top menu  and  simultaneously.

Then press  to turn off Trace 1.

STEP 2

Press 

Then press the corresponding menu  to select from the 'Coupling' menu the coupling matching the source's impedance — 50 Ω .

STEP 3

Press 

Having set up the scope with the first three steps, the next is to call up the telecom mask to be used for the test. For this example, from the TC1 option we use the mask CCITT G703 Fig 22 (97 728 kb), stored on floppy. However, any of the other masks available on floppy or memory card can be used.

STEP 4

Insert the floppy in the scope's drive and press 

Then press the corresponding menu  to select 'Flpy' from the 'from' menu.



The screen will display:

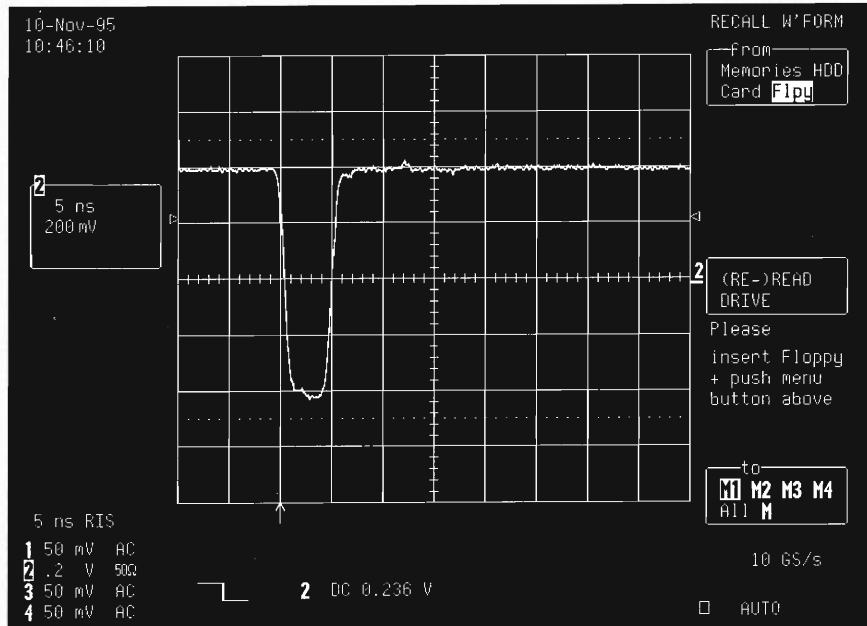

STEP 5

Press the corresponding menu for '(RE-) READ DRIVE'.

Then turn to select the desired mask — '**CCITT G703F22**'.

Next, press the corresponding menu for 'DO RECALL'.

Measuring Skills

The screen will then display:

Note: The message 'G703F22 recalled from floppy' will be displayed at top-of-screen. The mask is now stored in the volatile internal memory M1, as indicated in the 'to' menu.

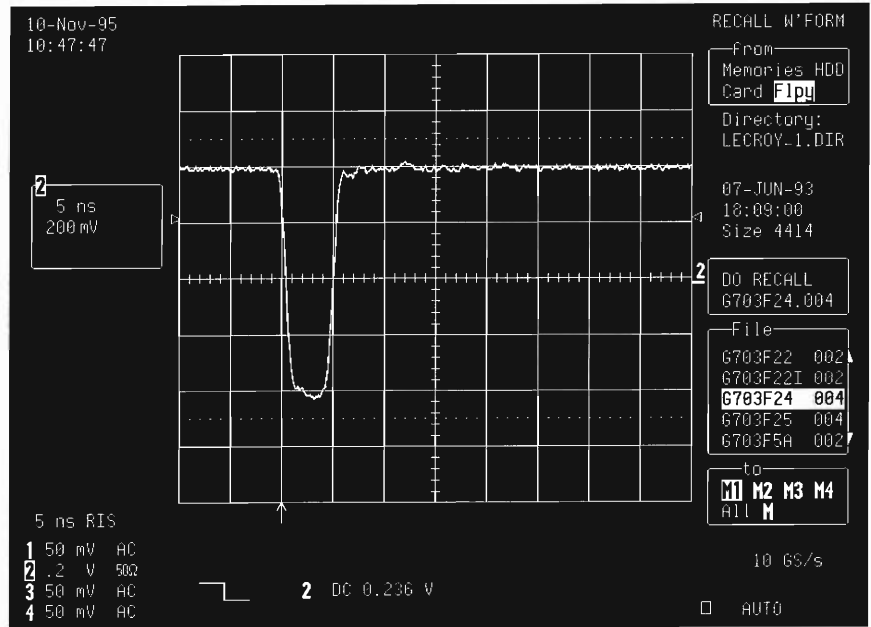

STEP 6 

To display the recalled mask: Press



Note: A maximum number of points can be selected in the 'for Math use' menu by turning the lower knob on the 'L'-shaped control panel. This can be for limiting the calculation or the amount of processing memory used or both. Here the function is performed simply to show the trace stored in M1 and can be considered as a zoom with a factor of one. The acquisition is a 500-point trace and the default value of 'up to 1000 points' would be sufficient.

The screen will display:

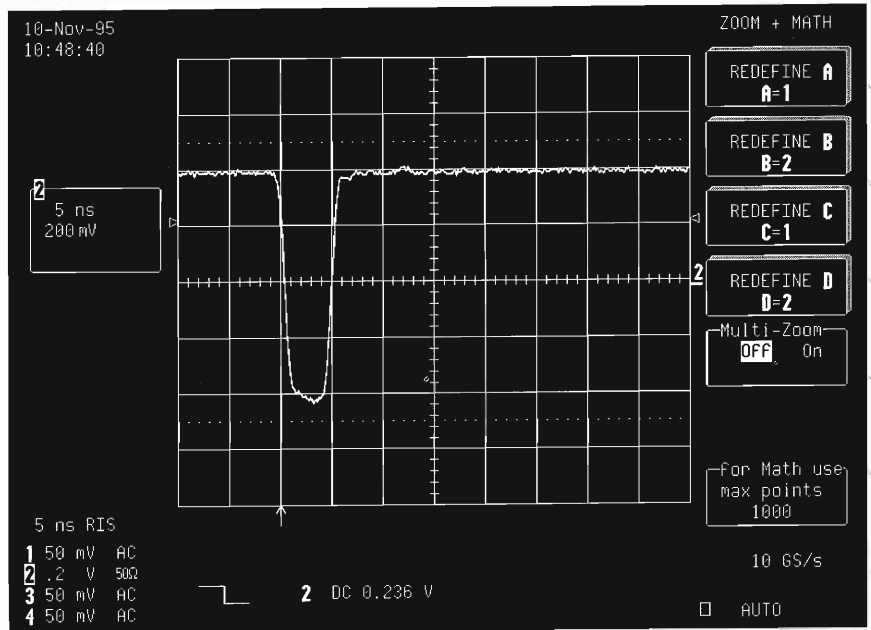

STEP 7 

Press the corresponding menu s for 'REDEFINE A' and then for 'Trace A is ZOOM of' 'M1'.

Then press A to turn on Trace A and display the mask.

The screen will then display:

Note: The following important information on the mask is given in the trace label... Horizontal: timebase is 1 ns/div. — the test will be performed only if the trace to be tested against the mask has the same timebase as the mask; Vertical: gain is 20% per division — meaning that each vertical division is equal to 20% of the difference between the mean top value accepted by the mask and the mask's mean base value.

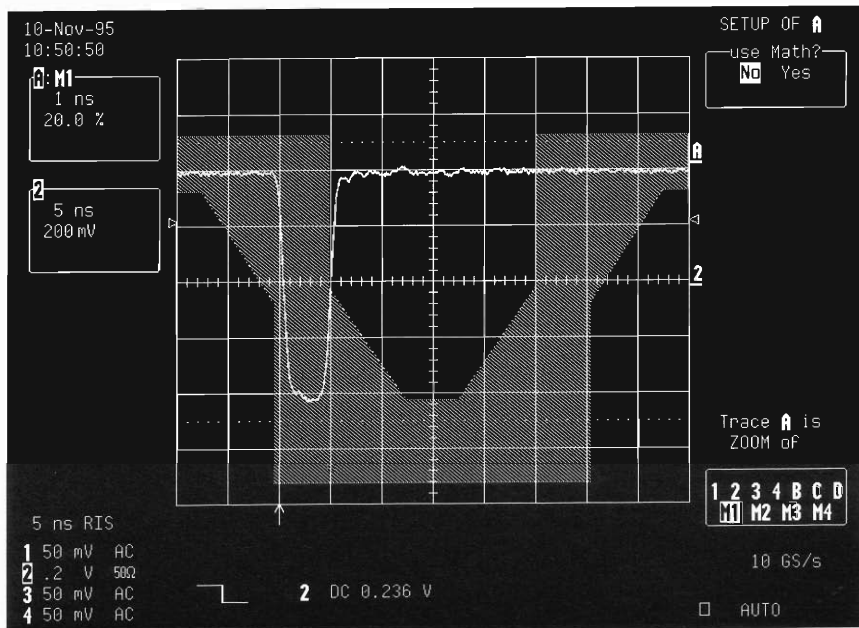

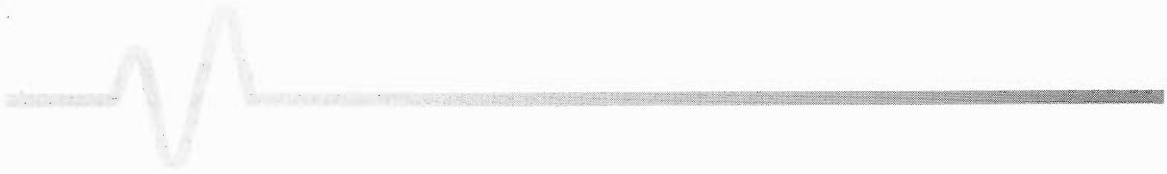

The mean top value accepted by the mask and the mean base value of the mask are shown, respectively, as the upper and lower horizontal dotted lines on the screen. The difference between the two represents five 20% divisions.



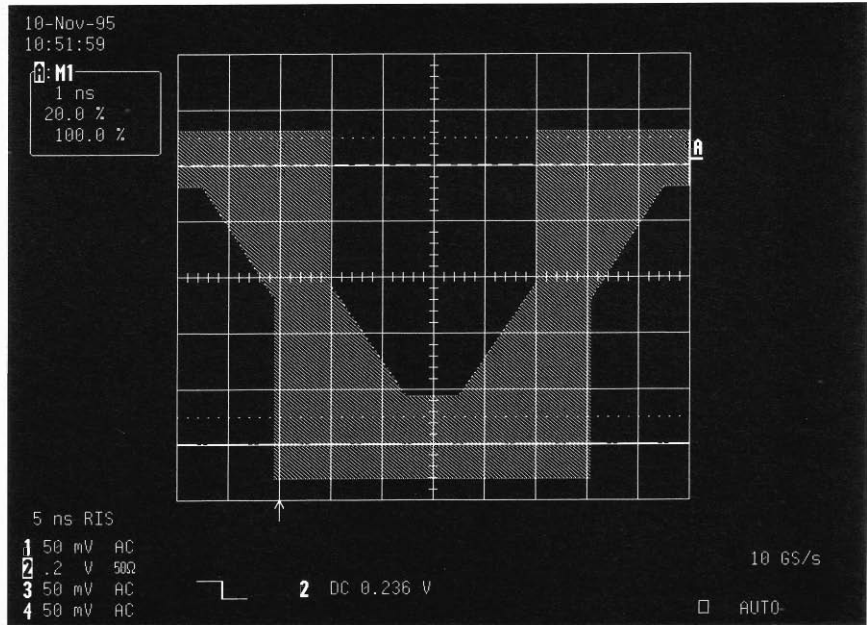

This screen displays the vertical unit of the mask:



STEP 8 

Turn  to obtain the same timebase for both trace and mask and match one to the other.

STEP 9 

Turn  to position the trace so that its mean-top and mean-base values correspond to those of the mask.

The screen will then display:

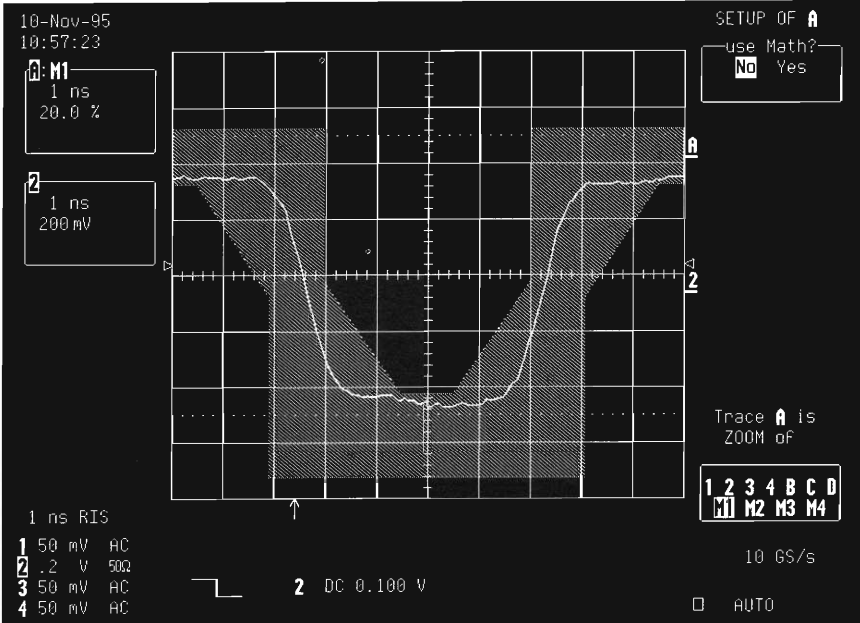

STEP 10 

Now, press  to do the test.

Then press the corresponding menu  to select 'Parameters'.

STEP 11 

Press the corresponding menu  to select 'Pass'.

This enables the test against masks or a parameter value to be made. This test should begin with 'testing' turned to 'Off'. Once the tests are set up, testing can then be turned 'On'.



The screen will then display:

Note: The test status is shown on the first line under the grid. The number of acquisitions that passed the test and the total number tested are given. In this example, 40 of 61 acquisitions passed the test. Shown at the end of the same line is the pass or failure of the current acquisition. The lines beneath indicate what has been tested; some CH 1 parameters are tested by default. These lines can be changed by pressing the appropriate menu button for 'CHANGE TEST CONDITIONS' (see next step), whereby the parameter or mask to be tested can be specified. Here only one line — CH 2 against the mask displayed as trace A — will be defined.

To stop or restart the test, press the corresponding menu button to select 'On' or 'Off' from the 'testing' menu.

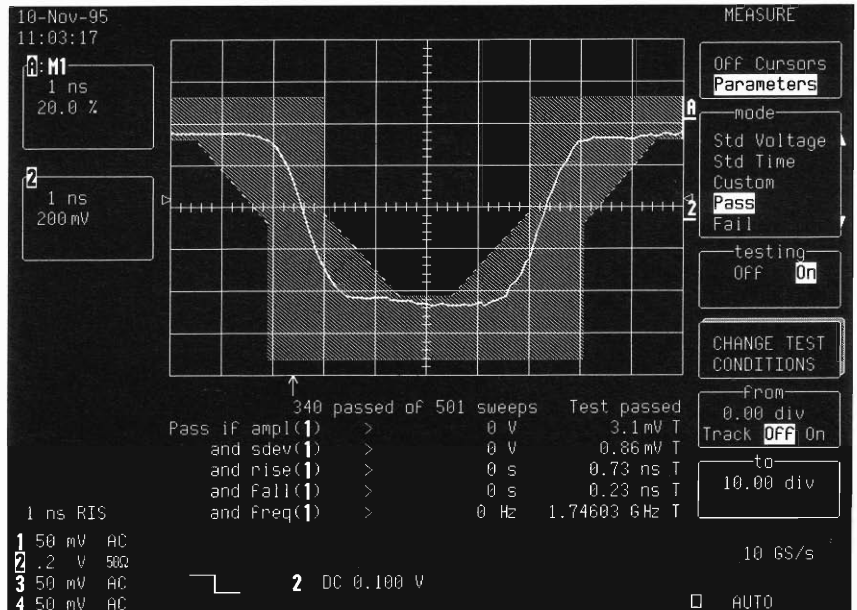

Tips: The test is performed only on points between the two vertical cursors. These cursors can be set by turning the upper and lower knobs on the 'L'-shaped control panel for left and right cursors, respectively. The test is applied on all acquired points by default.

STEP 12

Press the corresponding menu button for 'CHANGE TEST CONDITIONS', then for 'DELETE ALL TESTS', and then to select 'Mask' from the 'Test on' menu.

The screen will display:

Note: The test description appears on the first line. At this stage, the test is specified as: 'Pass' if all the CH 1 trace points are inside the mask stored in Trace D.

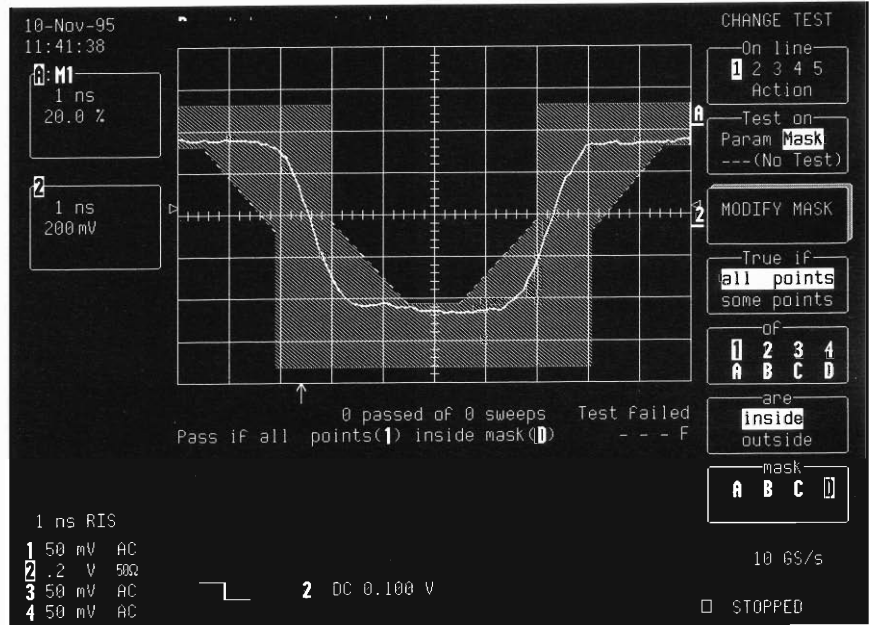

STEP 13

Press the corresponding menu s to select '2' and 'A' from the 'of' and 'mask' menus, respectively. CH 2 and Trace A will then be tested.

Now press NORM to run the test.

Note: To reset the test, press the CLEAR SWEEPS button on the 'L'-shaped control panel. Several conditions can be specified in testing by pressing the appropriate menu buttons — 'all points' or 'some points' may be selected from the 'True if' menu, and 'inside or 'outside' the mask from the 'are' menu.

The screen will now display:

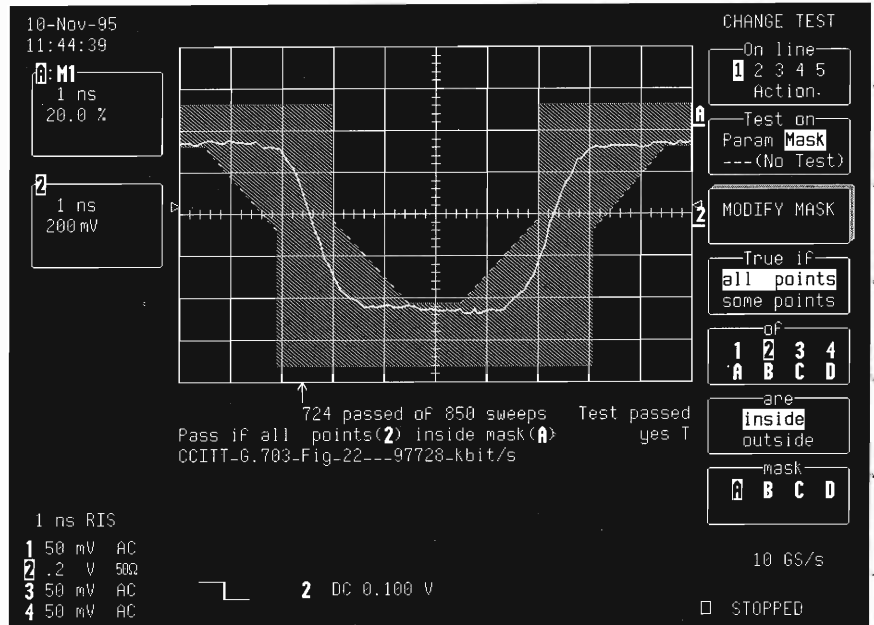

Tips: Whether the test is a 'Pass' or 'Fail', any or all of the following can be activated by selecting from the 'CHANGE TEST' menus:

- Stop capturing further signals
- Dump the screen image to a hard-copy unit
- Store selected traces to internal memory, memory card (optional), or floppy (optional) or hard disk
- Sound a beep
- Emit a pulse on the CAL BNC.

Measuring Skills

These final two screens display selections from the 'CHANGE TEST' 'Action' menus.

Note: To carry out one or more of these actions, make a selection from the 'If' menu — to set whether the action or actions are to be carried out in the case of a Pass or a Fail — next press the appropriate menu buttons to make the desired selection from the 'Then' and 'Stop' menus.

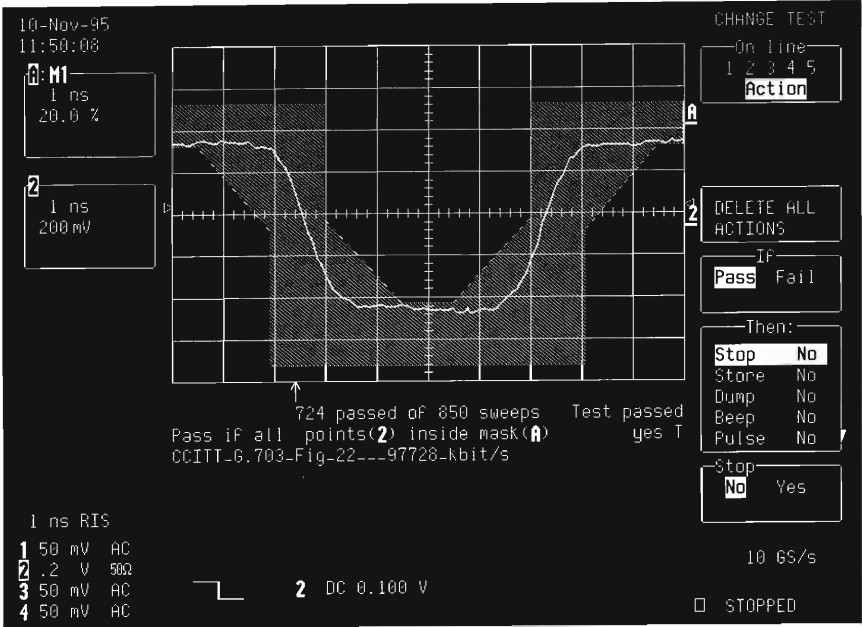

Note: With **'Store Yes'** selected, if the test is a Pass then Trace 2 will be stored to floppy.

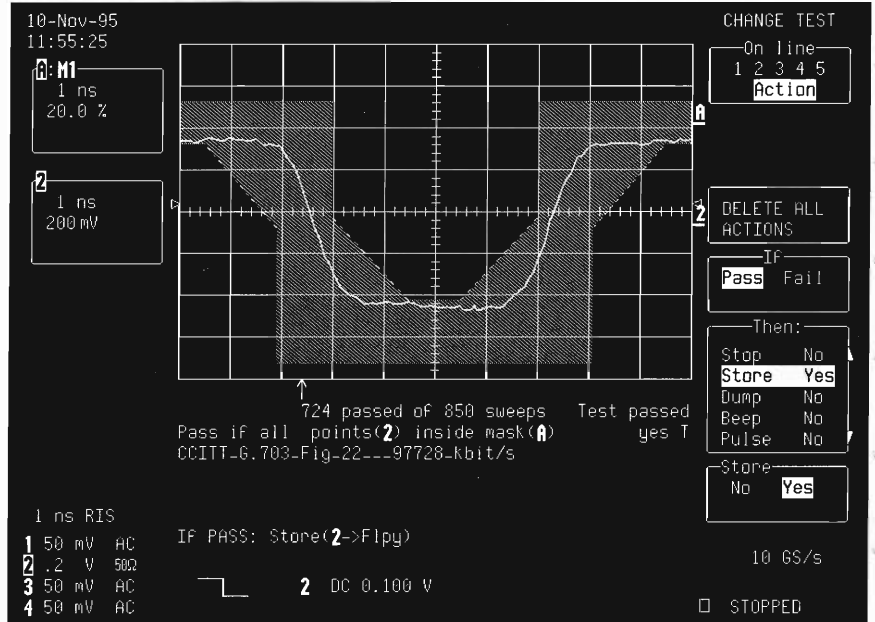

Storing to Removable Hard Disk

The 9300-Series offers many options for automatic storage of acquisition traces to mass storage media, including floppy and memory cards. Another is the portable, PC Card hard disk drive* — a fast, removable, compact storage medium for saving and retrieving waveforms and instrument settings. Used together with the scope's Auto-Store function, it stores automatically after each acquisition.

Hardware Required

HD01 Type III Hard Disk Adapter option (available for all LeCroy oscilloscopes).

Application Setup

Connect the waveform to be stored on CH 2.

Insert the PC Card hard disk drive in the adapter, located at the rear of the scope.

Perform this acquisition after carrying out any of the measurements in this section of the guide. An example signal is used here, shown on the next page.



* The PC Card hard disk drive is fully compatible with the computer industry's PCMCIA and JEIDA standards.

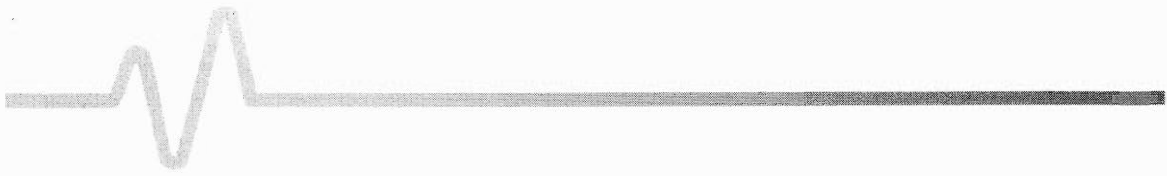

STEP 1 

Press  to complete the acquisition to be stored on the hard disk drive.

The screen will display:

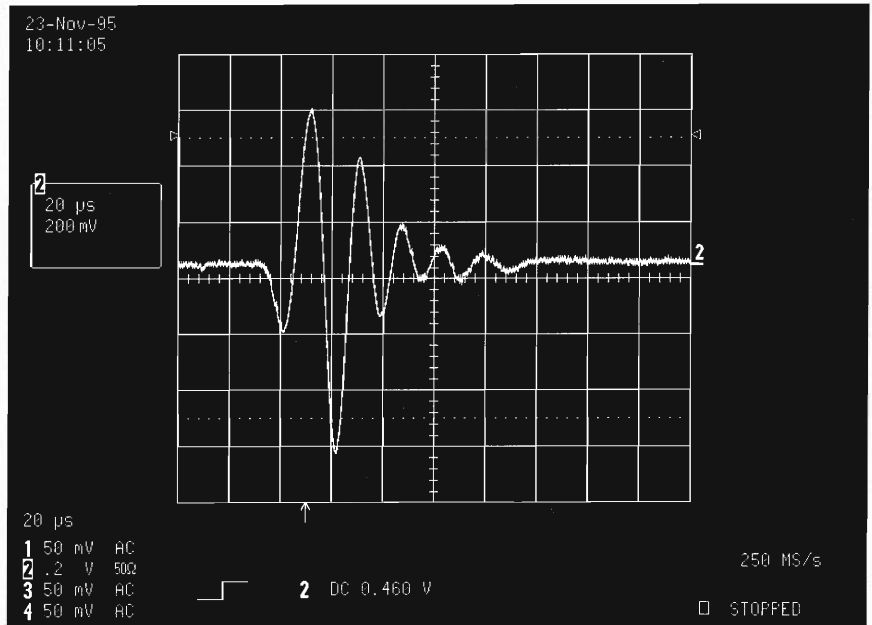

STEP 2 

Now press 

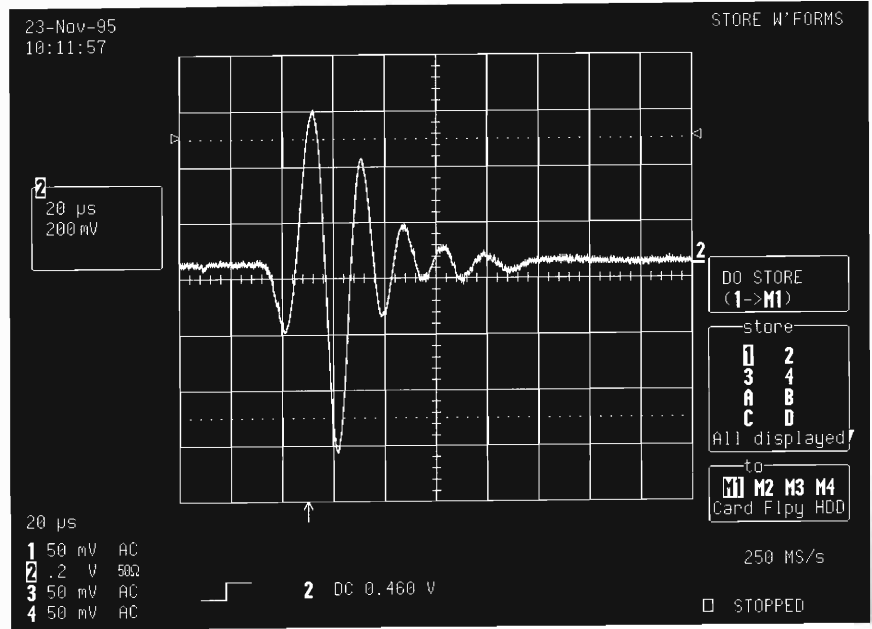

The screen will now display:

Note: The trace stored is generally CH 1 by default, along with target M1, a volatile internal memory. Depending on which mass-storage option or options are installed in the scope, the final box in the on-screen menu column will list a variety of waveform storage media. Here the menu offers 'Card' (PC Card memory card option WP01), 'Flpy' (floppy option FP01), and 'HDD' (PC Card Hard Disk Drive HD01). After selection of the particular storage medium, the procedure described in Steps 3–5 is the same for all.



STEP 3

Press the corresponding menu  or turn  to select '2' from the 'store' menu

Then press the corresponding menu  or  to select 'HDD' from the 'to' menu.

The screen will then display:

Note: When 'HDD' is selected, a variety of new menu items appear. They are: the total size of the inserted PC Card hard disk drive — in this case, 128 511 kB; the amount of space free on the hard disk drive — here, 127 194 kB; the name of the HDD directory in which the files will be stored — shown, the default file 'LECROY_1.DIR', created by the scope when a file is stored; and the Auto-store menu, whose description concludes this tutorial.

Each time a trace is stored, the 'Free' value is updated. The scope has a pre-defined naming convention for the eight-character file names. For manually stored waveform files, the format is Stt.nnn — where 'tt' defines the trace name of C1, C2, C3, C4, TA, TB, TC, TD, and 'nnn' denotes an automatically assigned, three-digit decimal sequence number starting at 001.

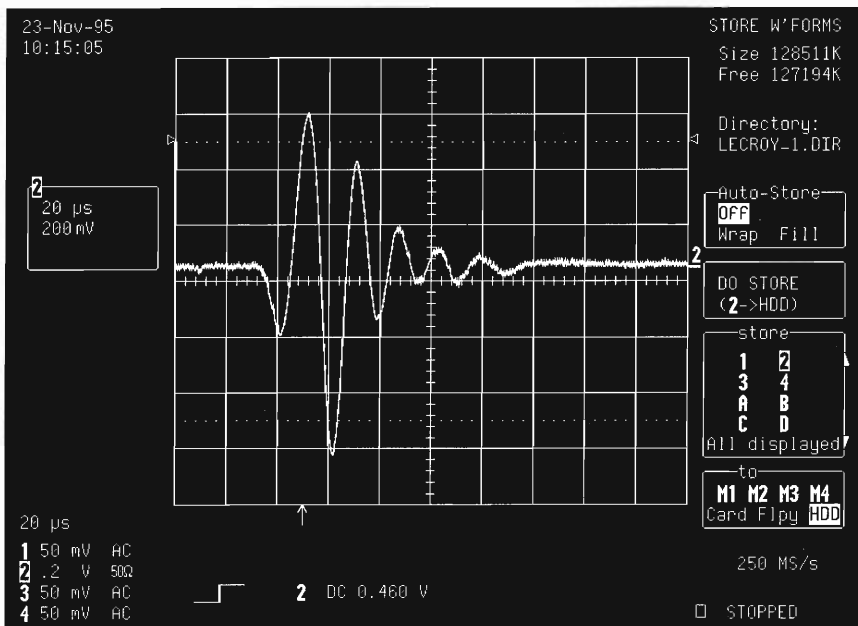

STEP 4

Press the corresponding menu  for 'DO STORE' to store the acquired signal on the hard disk drive.

A message confirming that this has been achieved — such as: '2 stored to SC2.001 on LECROY_1.DIR of HDD' — will be displayed at the top of the screen.

Auto-Store

When Auto-Store is selected, the waveform is stored automatically after each acquisition. Two varieties of Auto-Store are available:

'**Fill**', which stores the acquired waveform until the storage medium (PC Card hard disk drive, floppy or memory card) is completely full; and

'**Wrap**', which stores continuously to the chosen medium, while overwriting the oldest autostored files in a 'first in-first out' fashion.

STEP 5

Press the corresponding menu  to choose — for this example — '**Wrap**' from the '**Auto-Store**' menu.

The screen will display:

Note: In Auto-Store mode, the word RECORDING is displayed under the grid. If 'FILL' is selected and default names are used, the first waveform stored will be Axx.001, the second Axx.002, and so on, until the medium is full, the file number reaches 999, or more than 2040 files are stored in the current working directory. If 'WRAP' is selected, the oldest autostored waveform files will be deleted whenever the medium becomes full. Remaining autostored waveform files are then renamed — the oldest group of files becoming "Axx.001, the second oldest "Axx.002", and so on.

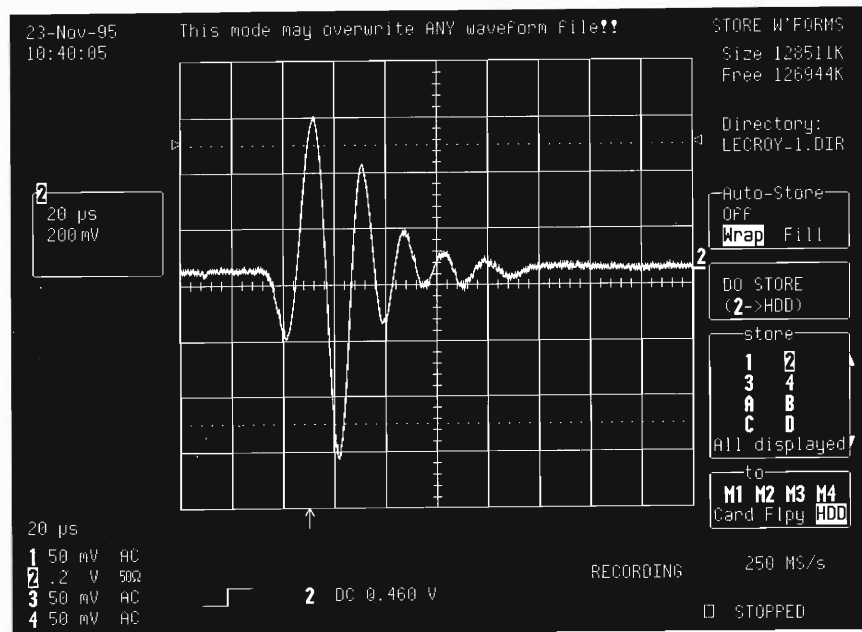

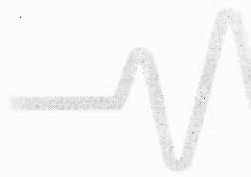

Calculating on Long Waveforms

The 930x-64 long-memory option provides maximum processing power, upgrading to 64 megabytes (MB) the RAM (Random Access Memory) of 9300-Series scopes possessing 16 MB of standard or boosted processing RAM*.

This tutorial shows how the 64 MB processing memory can be used to handle longer FFTs as well as multiple long-waveform zoom, math and storage.

Hardware Required

The LeCroy 930x-64 long-memory option installed in a LeCroy 9300-Series oscilloscope.

Software Required

WP01 and WP02 options for math functions and FFT.

Application Setup

Connect the signal to be measured — which must be a waveform of one million points or more — to CH 2. The signal to be acquired here is an example two-million-point acquisition, but acquisitions of up to eight million can be made, depending on the scope model.

* Around 1.5 MB RAM is used by the operating system, with the remainder normally available for waveform storage, zoom, advanced math and FFT.

STEP 1 

Reset: Press , top menu  and  simultaneously.

Then press  to turn off Trace 1.

STEP 2 

Press 

Then press the corresponding menu  to select from the 'Coupling' menu the coupling matching the source's impedance — again, 50 Ω.

STEP 3 

Press 

STEP 4 

Press , thus stopping the acquisition.

Then press 

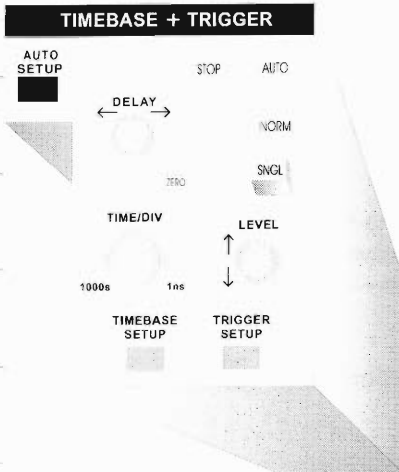

At the top of the column of TIMEBASE menus on the next-screen, overleaf, is shown the number of points acquired — 10 000 samples for this example. At the same time, the 'Record up to' menu, at the base of the column, shows the acquired sample limit set by the user — 50 000 in this case.

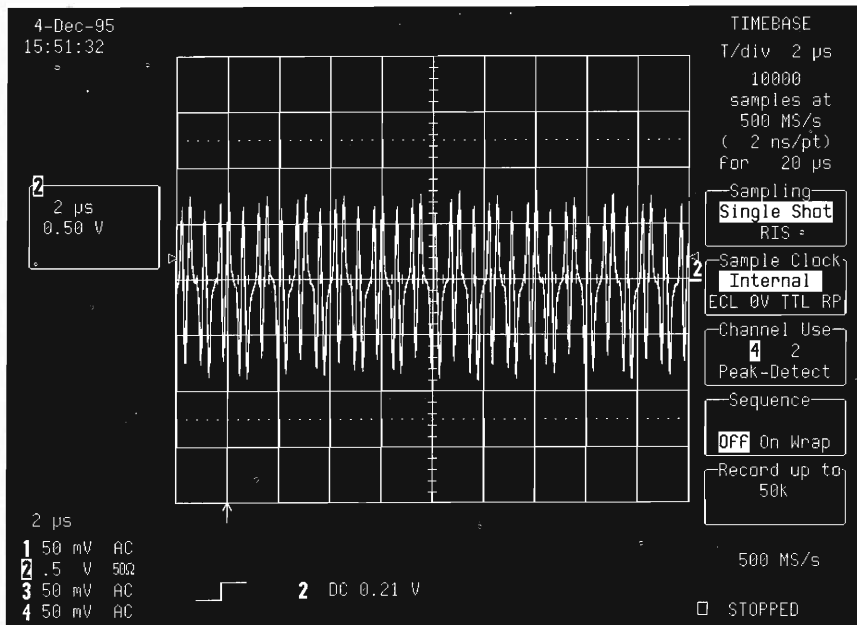
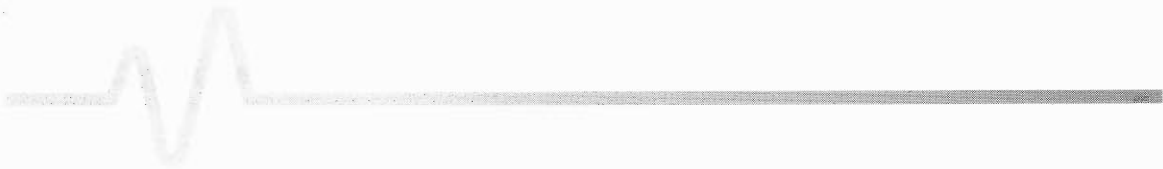

STEP 5 

Turn  so that the 'Record up to' number of samples is set to at least '1M' points — for this example it is set to '2M'.

Turn  in order to slow down the timebase, and obtain more time per division, until the number of acquired points displayed is the same as in this example — '2M' points.

Press  to perform a single two-million-point acquisition.

The screen will now display:

Note: With the long acquisition memory, the maximum sampling rate (here, 500 MS/s), and thus the scope's full bandwidth, is maintained at many more timebase settings than are possible with short-memory scopes. Particular advantages include:

- greater waveform detail
- high zoom factor
- protection against aliasing
- improved time resolution
- wider frequency spectrum.

(See the LeCroy Application Note ITI 008 for details).

The display here is only eight divisions because the capture of two million points with a sampling rate of 500 MS/s gives a window time acquisition of 4 ms. The sole possibility of displaying a 4 ms acquisition is to use eight divisions with a timebase of 0.5 ms/div.

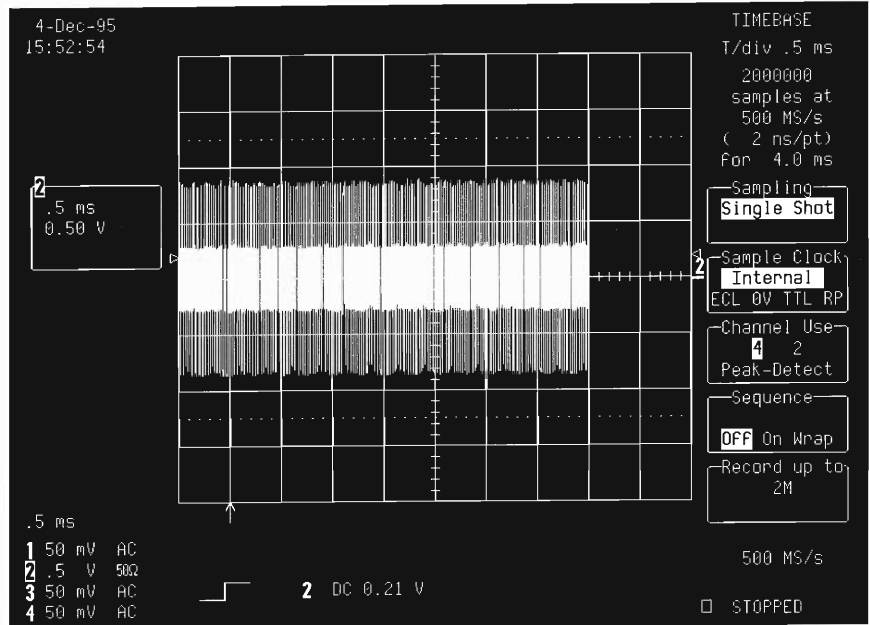

The next step illustrates just how practical is 64 MB memory processing — zooms or functions can be acquired on all two million points of the trace acquired in the preceding steps.

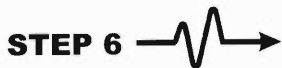

Press **DISPLAY**

Press the corresponding menu to select 'Quad' from the 'Grids' menu.

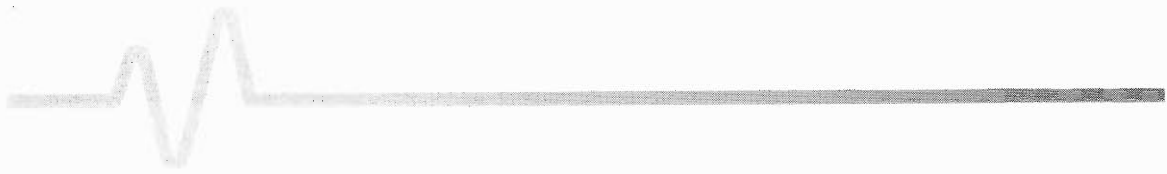

The screen will display:

Note: Functions or zooms can be selected on any channel or trace. The 9300-Series scope allows display of four different traces in as many grids, whilst preserving eight-bit resolution.

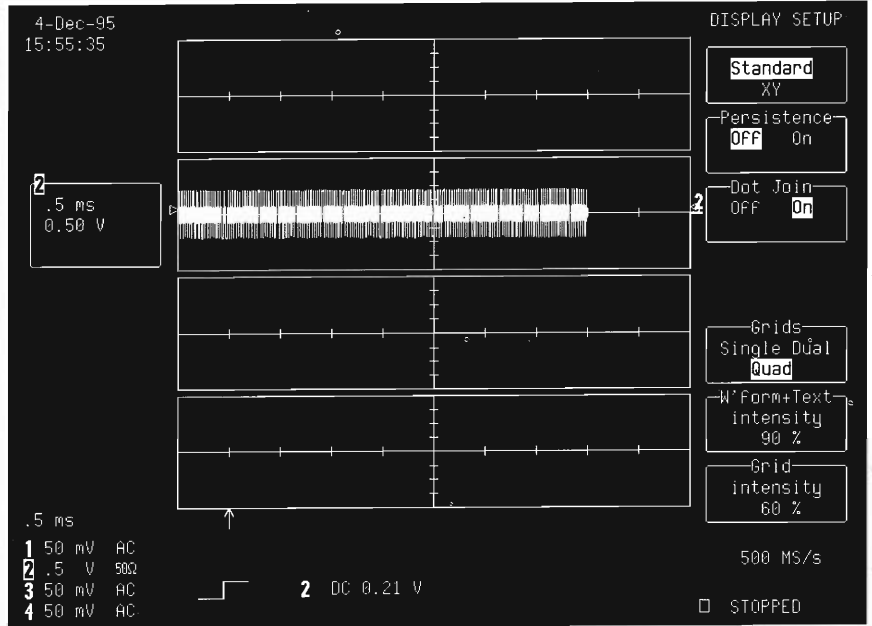

STEP 7 

**MATH
SETUP**
Press 

Then turn  to select 10 M points ('max points 10000000') in the 'for Math use' menu.

The screen will then display:

Note: The limit in the number of points must be equal to or higher than the actual number set in order to ensure performance of the function or zoom on all acquired points. This limit applies to all set functions or zooms, of which some may be set to reduce the number of points implied where processing memory size limitations apply — certainly not the case when the 64 MB option is installed!

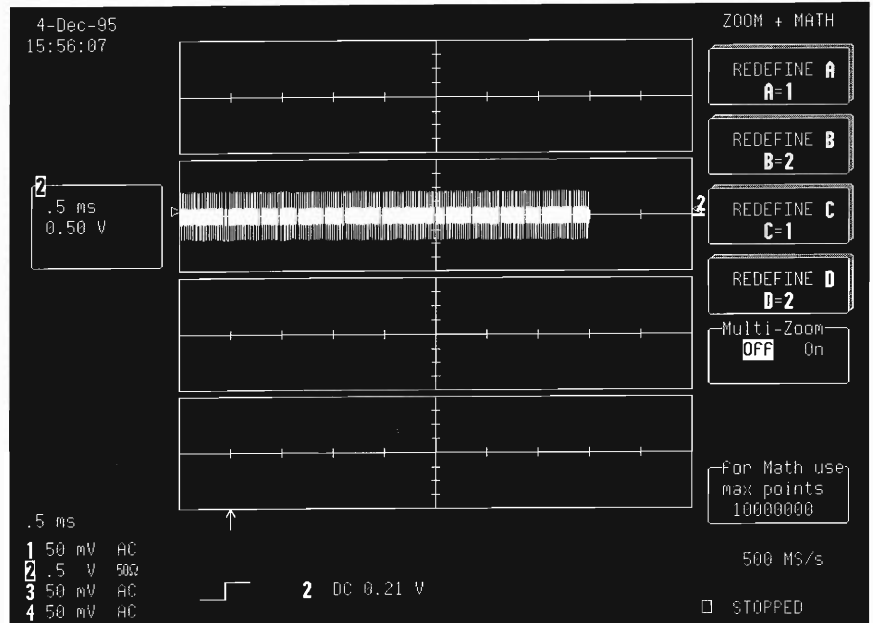

STEP 8

Press the corresponding menu  for 'REDEFINE B'.

Turn  to select '2'.

Then press  to turn on Trace B.





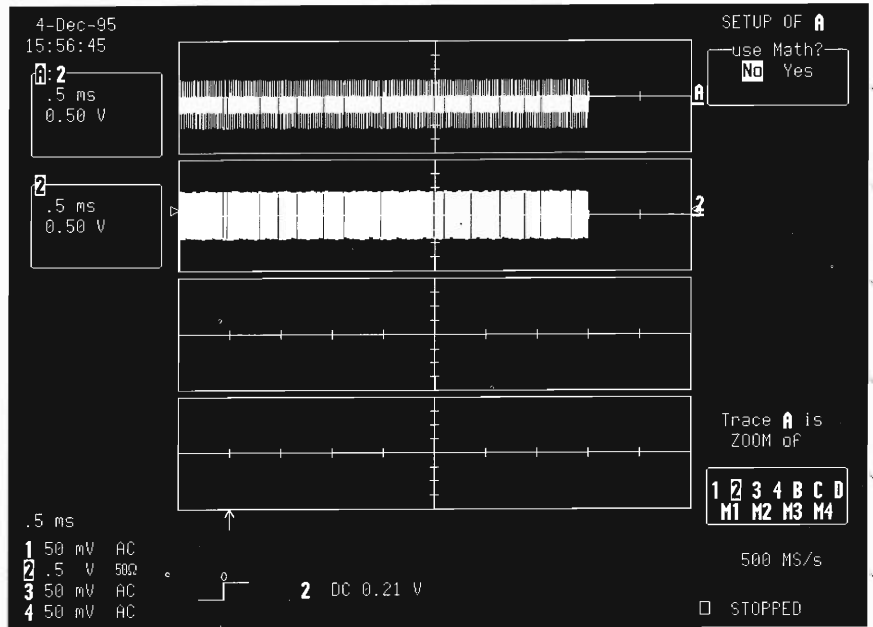

The screen will display:

Note: With Step 8 Trace B will be displayed as the zoom ('use Math?' 'No') of CH 2, indicated with the bottom menu in the 'SETUP OF B' menu column..



STEP 9 

Use  and  to select the original signal selection, the timebase (horizontal zoom) and the amplitude (vertical zoom). This will enable the selection of a portion of the original signal and expansion of that portion vertically or horizontally.

Use  and  to select the original signal selection, the timebase (horizontal zoom) and the amplitude (vertical zoom). This will enable the selection of a portion of the original signal and expansion of that portion vertically or horizontally.

Measuring Skills

The screen will then display a zoom (100 times) of CH 2 that indicates a zone of interest, as shown here:

Note: The selected section is shown on the original trace as reinforced video. The RESET button cancels all the zoom changes and redisplay the original trace

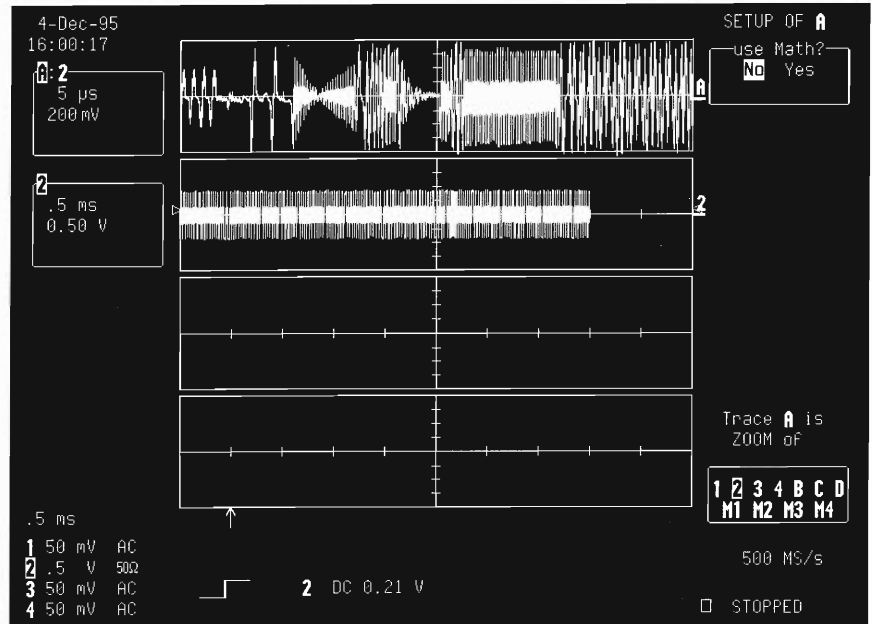

Tips: To check how much memory is being used and how much is still available, press the **SHOW STATUS** button on the 'L'-shaped control panel, then press the corresponding menu button until **Memory Used** is selected, as shown on the next screen, overleaf. The Memory used for storage of records readout at top-left-of-screen details the amount of memory taken up, the amount free and the total of memory.

When the performance of a function requires more processing memory than available, the message insufficient data memory (see show status) appears.



```
4-Dec-95
16:00:38

Memory used for storage of records

A          50 048  bytes
Free      65 511 808 bytes
Total     65 561 856 bytes

STATUS
Acquisition System
Text & Times
Waveform
Memory Used

M1 empty
M2 empty
M3 empty
M4 empty

CLEAR
INACTIVE

500 MS/s

[ ] STOPPED
```

STEP 10 

**MATH
SETUP**
Press 

Then press the corresponding menu  for 'REDEFINE D'.

Next, press the menu  to select 'Yes' from the 'use Math?' menu.

And then turn  to select CH 2, on which the trace is acquired.

The screen will now display:

*Note: Depending on the options installed, varieties of selections can be made from the 'Math Type' menu, including: **Standard** — summed averaging up to 1000 sweeps, arithmetic operations (add, subtract, multiply, divide, negate, identity), and the $(\sin(x)/x)$ interpolation function; **WP01** — summed averaging up to one million sweeps, continuous averaging up to 1024 sweeps, reciprocal, rescale, absolute value, derivative, integral, logarithm (e) and Logarithm (10), exponential (e) and exponential (10), square, square root; **Enhanced Resolution** — digital filtering allowing 0.5–3-bit vertical resolution improvement; **WP02** — frequency domain analysis (FFT and FFT power averaging), as well as rescale in both the time and frequency domains; **WP03** — histogram function for over 40 different parameters and 18 histogram parameters.*

STEP 11

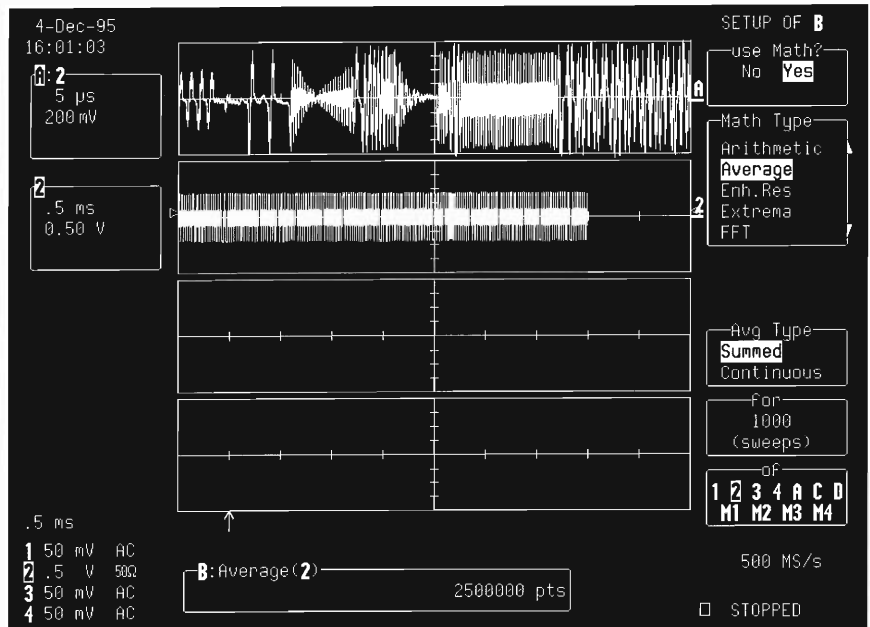

Each of the functions noted here uses processing memory according to the algorithm applied. An FFT — for example — consumes up to ten times the size of the original acquired signal. Thus, for a two-million-point trace, the minimum processing memory required would be 20 MB.

Press either of the corresponding menu  s to select a function for Trace B — FFT, for example, Trace B=PSFFT(2). The trace must be displayed for the calculation to be performed.

Therefore, press  B to turn on Trace B.



The screen will display:

Note: On long traces, it can take several minutes to calculate the data of functions such as FFT. The information 'B:Math' is displayed at the base of the screen while the scope is calculating the function that is to be displayed and stored in the memory.

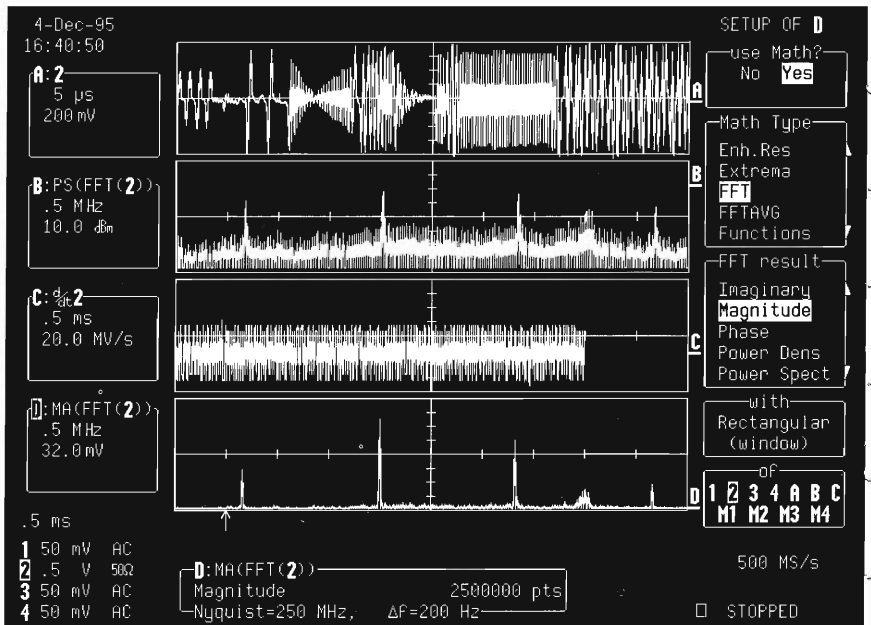

Tips: Again, in order to check how much memory is being used and how much is still available, press the **SHOW STATUS** button on the 'L'-shaped control panel, then press the corresponding menu button until **Memory Used** is selected.

STEP 12

Same as for Step 11, but this time:

Press the menu s to select a function for Traces C and D, selecting different functions on Trace 2 and displaying the result.

Measuring Skills

Tips: Four traces can be displayed simultaneously, as shown on the screen below. The original signal need not be displayed for calculations to be performed on it. And four functions can be performed on either of the originally acquired traces at the same time.

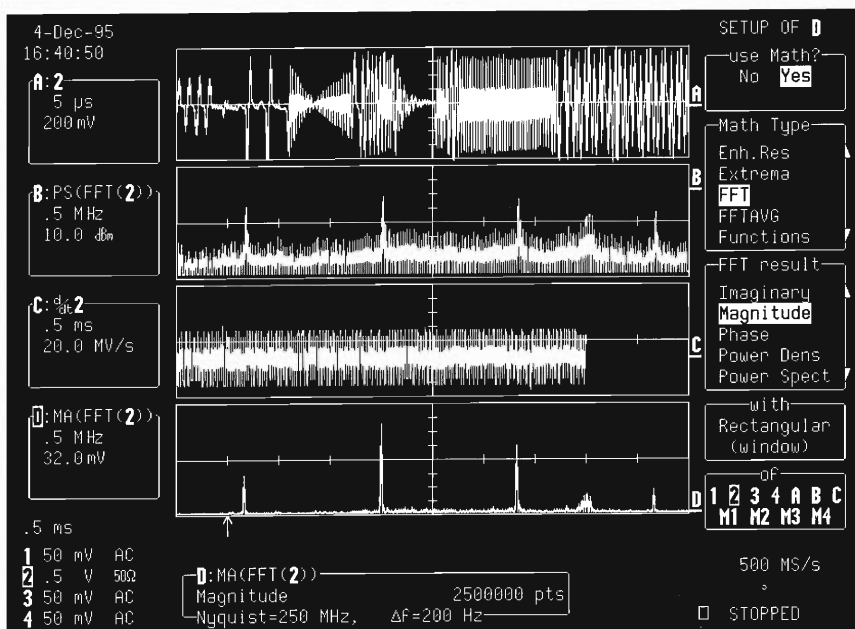

Note: In this final example, four functions performed on CH 2 are displayed. However, CH 2 itself is not displayed. The 'Memory Used' display details the processing memory used in performing all the calculations.

```

9-Feb-96
16:02:16

Memory used for storage of records

 2      5 000 028  bytes
 A      50 048   bytes
 B     15 000 060  bytes
 C      5 000 028  bytes
 D     15 000 060  bytes
Free   23 903 812  bytes
Total  63 954 036  bytes

To free some memory, you can
. clear Memory waveforms
. reduce the number of points used for Math (MATH SETUP)
. reduce the number of samples in the Record (TIMEBASE SETUP)
. turn off traces or parameters

STATUS
Acquisition
System
Text 8 Times
Waveform
Memory Used

M1 empty
M2 empty
M3 empty
M4 empty

CLEAR
INACTIVE

500 MS/s

 STOPPED

```



SMART Glitch-Capturing

Finding and capturing elusive glitches — faster-than-normal transitions or shorter-than-normal pulses in a signal — is simple with the glitch SMART trigger. Signal source, coupling, level, width and pulse can be specified for the glitch search. The range is vast, including digital and analog electronic development, telecommunications, automated testing equipment (ATE), electromagnetic interference (EMI), and magnetic media studies.

Application Setup

Connect the signal to be measured — here, for example, a 500 kHz sinewave with glitch — to CH 2.

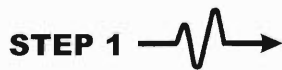

Reset: Press  , top menu  and  simultaneously.

Then press  to turn off Trace 1.

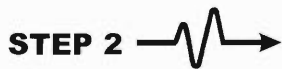

Press 

Then press the corresponding menu  to select from the 'Coupling' menu the coupling matching the source's impedance — again, 50 Ω .





STEP 3 

AUTO SETUP
Press 

The screen will display:

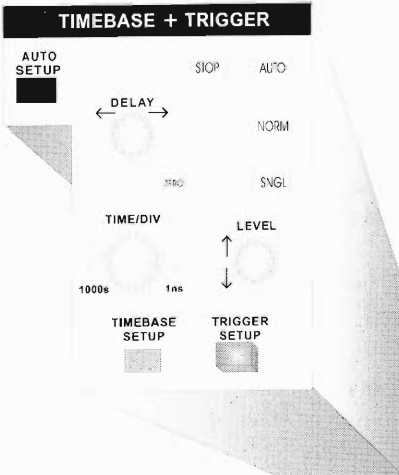
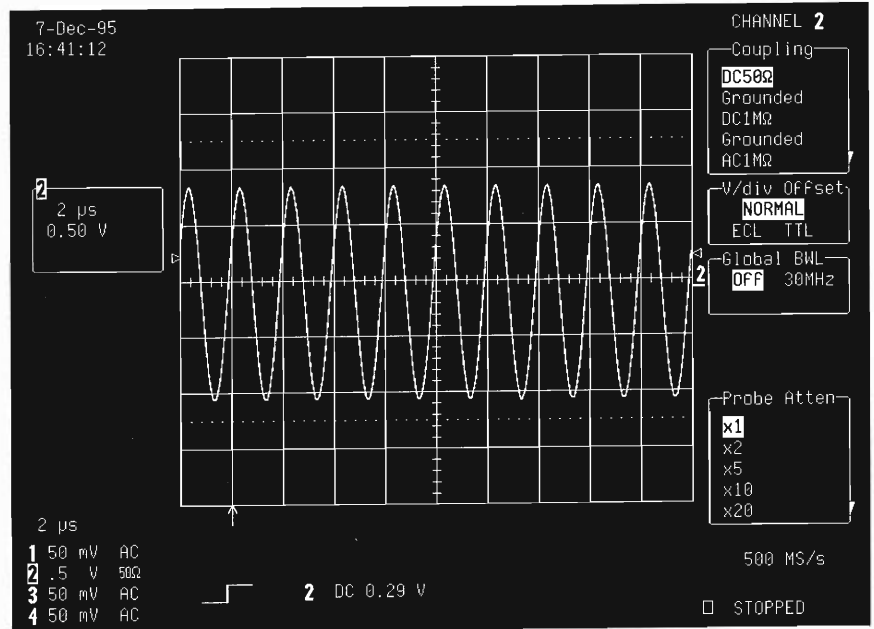
This screen shows a normal 500 kHz sinewave. Observing the signal during several acquisitions would reveal the occasional glitch. The goal of this measurement is to catch this event by setting a trigger adapted to it.



STEP 4 

TRIGGER SETUP
Press  (on the TIMEBASE + TRIGGER control panel, as illustrated above left).

The screen will then display:

*Note: 'Edge' — for Edge Trigger — is selected by default. This trigger is described by **source** and **coupling** (see following list), as well as **slope** and **level condition** — the same parameters used to build up the SMART Trigger.*

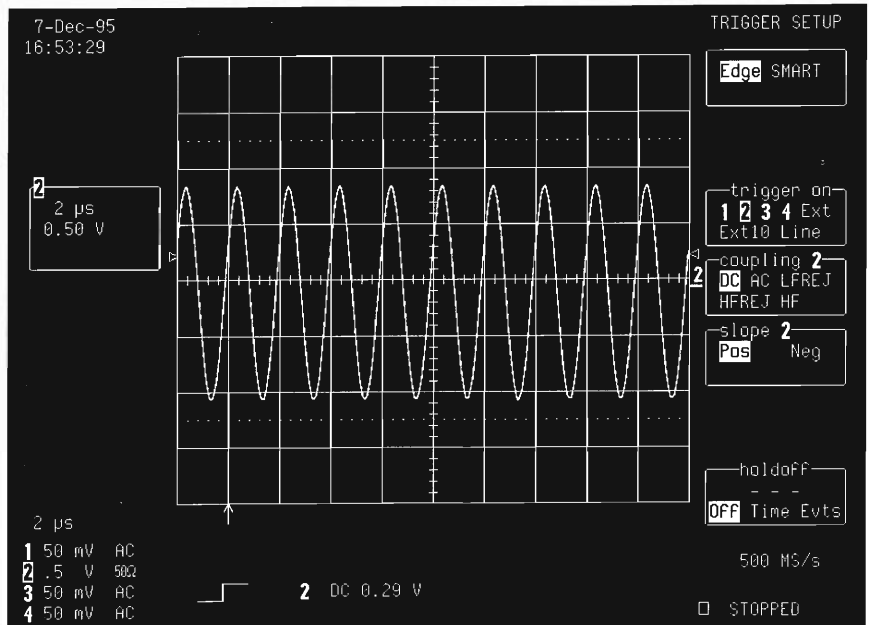

Source

The source is selected from:

CH 1 or 2, or CH 1, 2, 3 or 4 (on four-channel scopes) — the acquisition channel signal.

Line — the line voltage which powers the oscilloscope. It can be used to provide a stable display of signals synchronous with the power line. Coupling and level are not relevant for this selection.

EXT — signal applied to the EXT BNC connector. It can be used to trigger the oscilloscope within a range of ± 0.5 V.

EXT/10 — signal applied to the EXT BNC connector. It can be used to trigger the oscilloscope within a range of ± 5 V.



Coupling

Coupling refers to the type of signal coupling at the input to the trigger circuit. The trigger coupling can be selected independently from the following options:

DC: All of the signal's frequency components are coupled to the trigger circuit. This coupling mode is used in the case of high-frequency bursts, or where the use of AC coupling would shift the effective trigger level.

AC: Signals are coupled capacitively; DC levels are rejected and frequencies below 50 Hz are attenuated.

LF REJ: Signals are coupled via a capacitive high-pass filter network. DC is rejected and signal frequencies below 50 kHz are attenuated. The LF REJ trigger mode is used when stable triggering on medium- to high-frequency signals is desired.

HF REJ: Signals are DC coupled to the trigger circuit and a low-pass filter network attenuates frequencies above 50 kHz. The HF REJ trigger mode is used to trigger on low frequencies.

HF: For triggering on high-frequency repetitive signals. HF triggering should be used only when needed.

STEP 5



Press the corresponding menu  to select 'SMART'. The screen will display as shown next page:

Note: The Glitch SMART Trigger is the particular variety selected by default. It will be used here, but pressing the menu button for 'SETUP SMART TRIGGER' will show the other types of SMART Trigger available.

Source and coupling were set in the preceding steps. The slope can now be selected — 'Neg' (negative) or 'Pos' (positive). The icon displayed under the grid represents and describes the trigger setup.

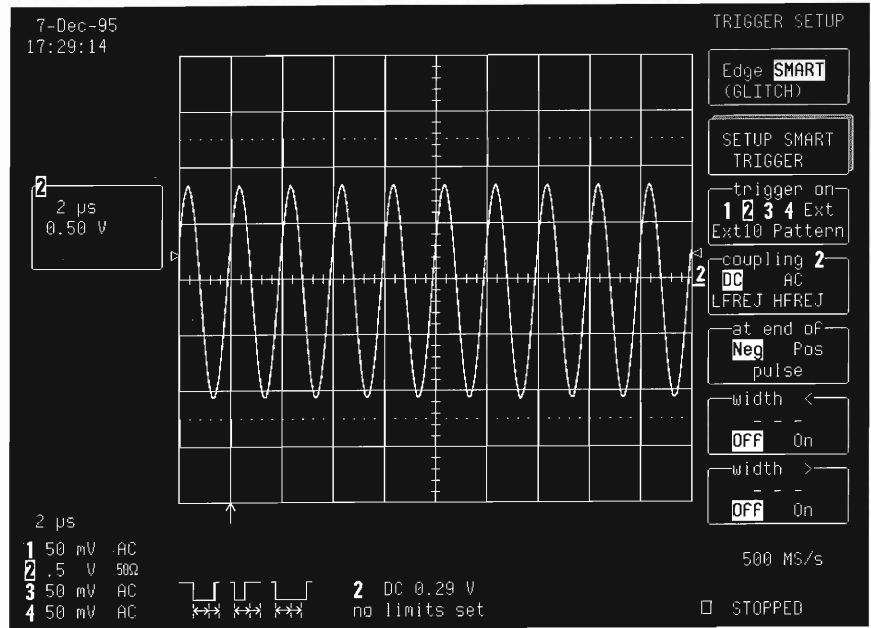

The next step is to set the trigger to capture the glitch on the current signal.

Here, the glitch's width is lower than the signal's. Thus the trigger needs to be set to a smaller width than that of the signal, whose own width depends on the DC trigger level. If that level is set at the middle of the sinewave, the width can be considered as the half period. However, if the level is higher, the signal's width has to be considered as being less than the half-period. Two microseconds is the period for our example sinewave. The DC trigger level is set, not at the middle of the sinewave, but where its width is about 800 ns.

Therefore, the glitch SMART trigger ought to be on CH 2 at end of 'Neg' pulse with a width of < 800 ns.

STEP 6



Note: 'width<' can be also used in combination with 'width>'. The two width limits are combined to select glitches within a window, low value<signal width<high values, or the two limits can be combined to trigger only on signals outside a window (see Capturing Rare Phenomena).

Press the corresponding menu  to select 'On' from the 'width<' menu.

Then turn  to adjust the value in that menu to 800 ns.

The screen will display:

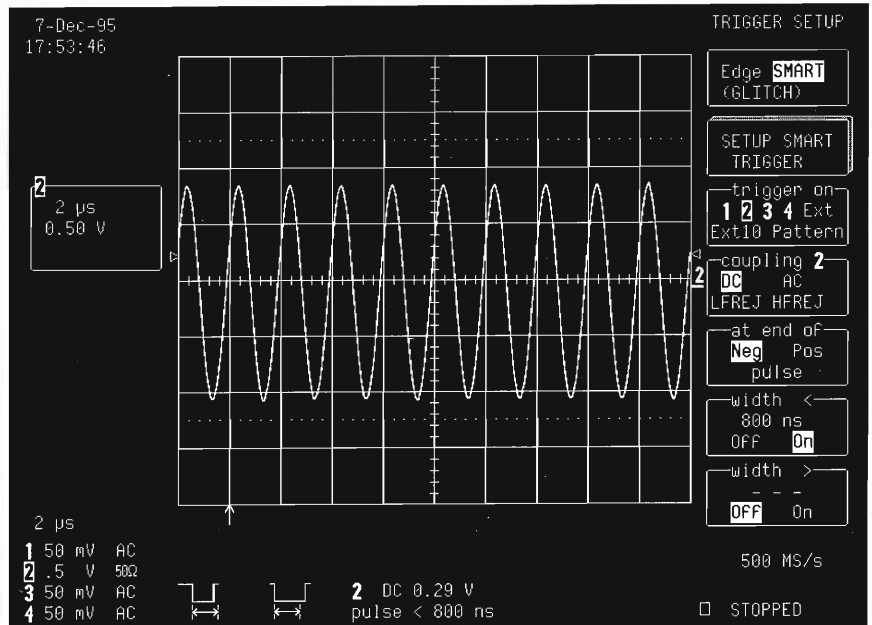

STEP 7



Press  to start the trigger.

The screen will display:

Note: As shown on the screen this page, the scope always triggers on the glitch that affects the sinewave.

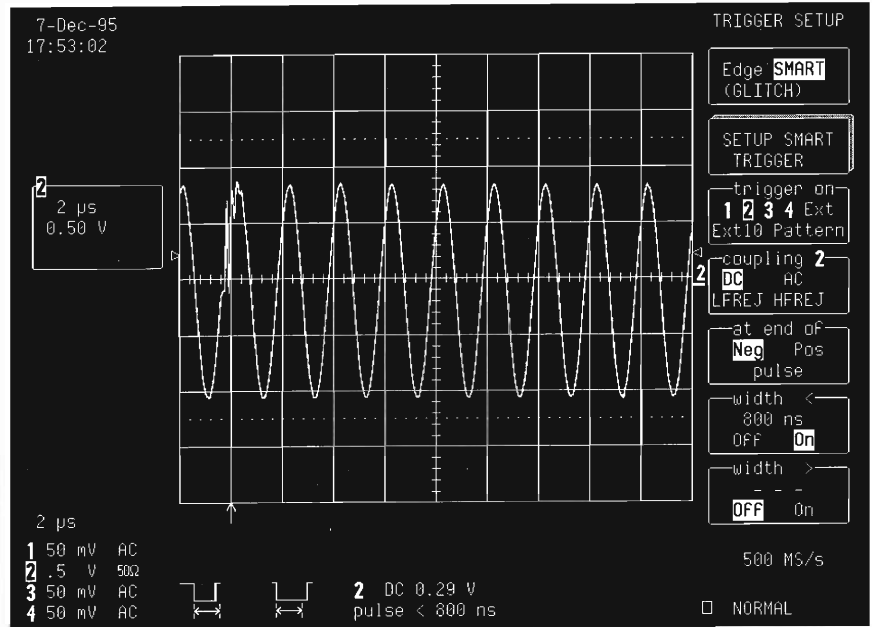

Tips: In order to be sure the scope captures the glitch, the trigger level has to be matched to the level at which the glitch appears.

In setting the glitch trigger, it is helpful to first identify the glitch shape. Use the Persistence Mode display (see Picturing Signal History), as shown in the final screen.

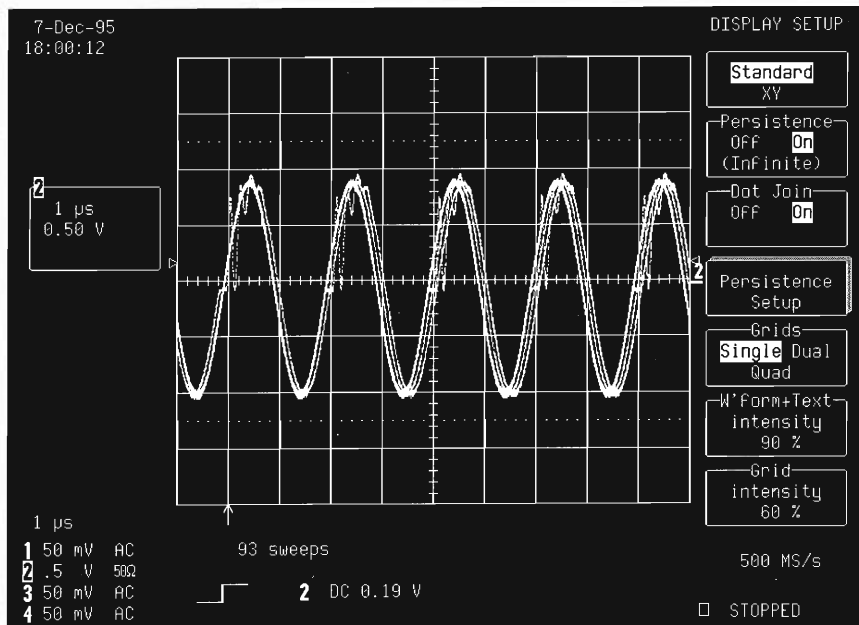

Capturing Rare Phenomena

LeCroy's SMART Trigger system captures rare phenomena. The Exclusion SMART Trigger does this by triggering on all events different from the expected waveform — such as glitches and intermittent out-of-tolerance waveforms. In this way, the oscilloscope itself contributes to increased knowledge of exceptional waveforms, leading to their complete description.

Application Setup

Connect to CH 2 a waveform whose multiple glitches — because of their low duty cycle — do not show up when the Edge Trigger or Persistence display is used.

STEP 1 

Reset: Press  , top menu  and  simultaneously.

Then press  to turn off Trace 1.

STEP 2 

Press 

Then press the corresponding menu  to select from the 'Coupling' menu the coupling matching the source's impedance — 50 Ω.



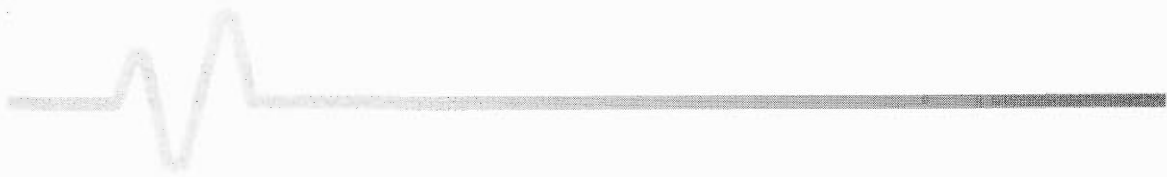

STEP 3 

Press  to display:

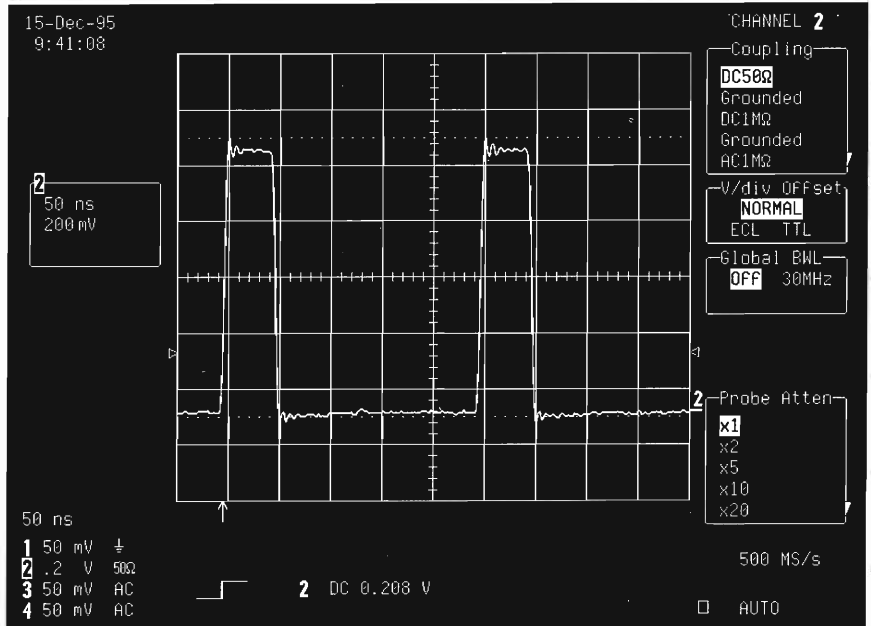

STEP 4 

Press 

Then 

The screen will now display:

Note: **'Edge'** — for Edge Trigger — is selected by default. This trigger is described by source and coupling, as well as slope, and level condition — the same parameters used to build up the SMART Trigger.

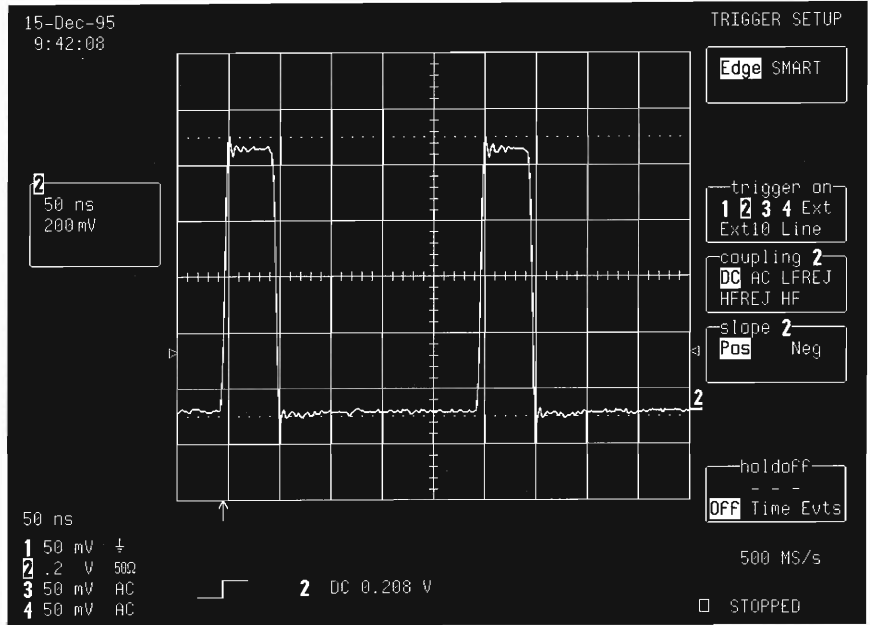

STEP 5 

Press the corresponding menu  to select **'SMART'**.

The screen will then display:

Note: The Glitch SMART Trigger is the particular variety selected by default. It will be used here, but pressing the menu button for 'SETUP SMART TRIGGER' will show the other types of SMART Trigger available. Both the Glitch and Interval Triggers include minimum and maximum timing limits, normally used to trigger on waveforms falling within those limits. Exclusion Trigger uses the maximum and minimum limits to exclude triggering on certain waveforms. This allows the scope to avoid the deadtime inherent in triggering on 'normal' signals. By using the Exclusion Trigger Mode, the scope maintains its readiness to trigger on abnormally shaped signals.

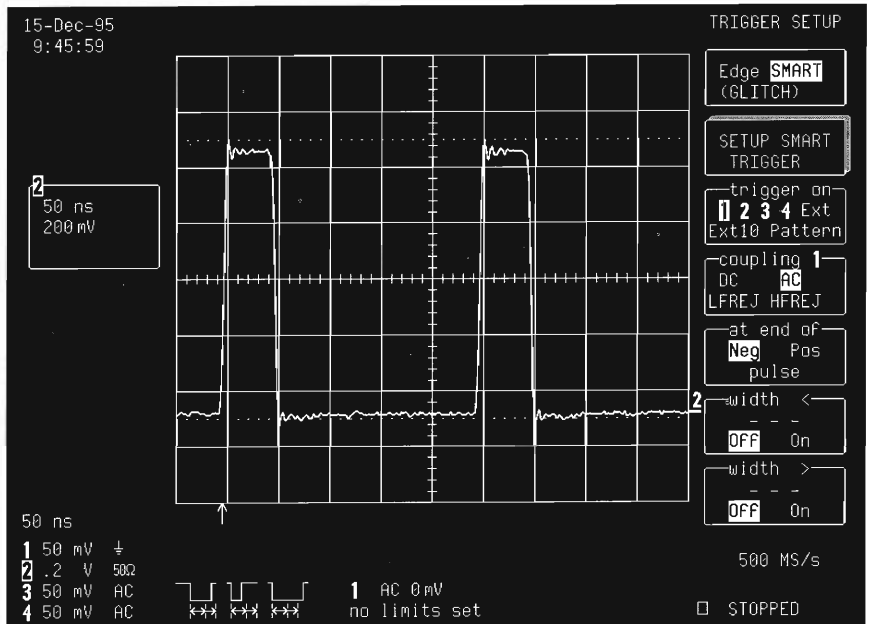

The next step and its various stages set up the Glitch SMART Trigger to eliminate nominal pulses having a width of 50 ns (one division). Thus only those waveforms that do not have pulse widths of 50 ns will trigger the oscilloscope.

STEP 6

Press the corresponding menu  to select '2' from the 'trigger on' menu, and Trace 2 as source trigger, adjusting the trigger level to one division from the top of the pulse.

Press the corresponding menu  to select 'Pos' from the 'at end of' menu (in this case the pulses are positive).

Press the corresponding menu  to select 'On' from the 'width <' menu.

Turn  to set the 'width <' value to 50 ns.

The screen will now display:

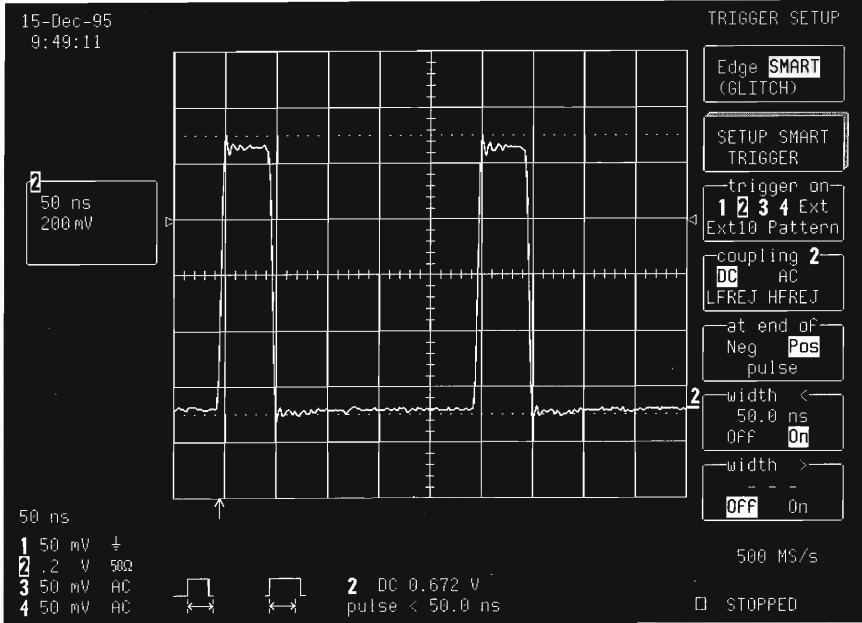

STEP 7

Next, press the corresponding menu  to select 'On' from the 'width>' menu.

And turn  to set this value to 50 ns.

Note the icon describing the trigger setup displayed under the grid.

The screen will then display:

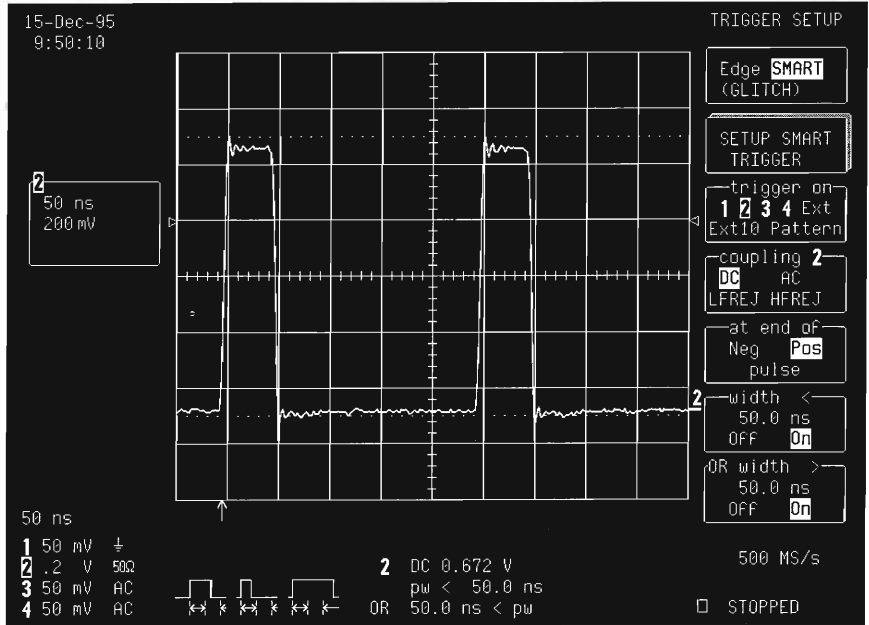

STEP 8 

Turn  to set the trigger point close to mid-screen.

Then press  to activate the trigger.

The screen will display:

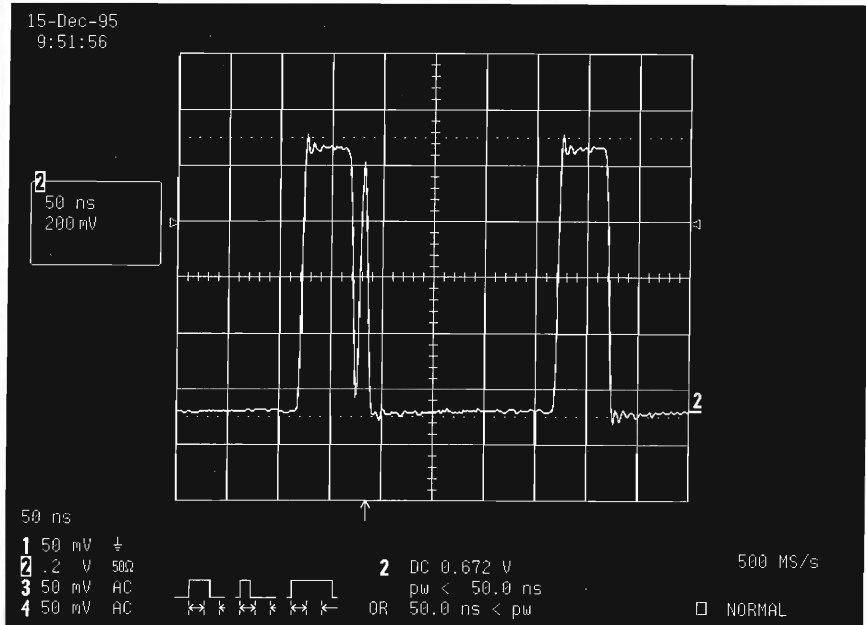

Tips: Persistence Mode can be used to show a history of the exceptional pulse acquisitions, set by pressing DISPLAY and then the menu button to select On from the Persistence menu — as shown on the next screen (see also the tutorial Picturing Signal History).

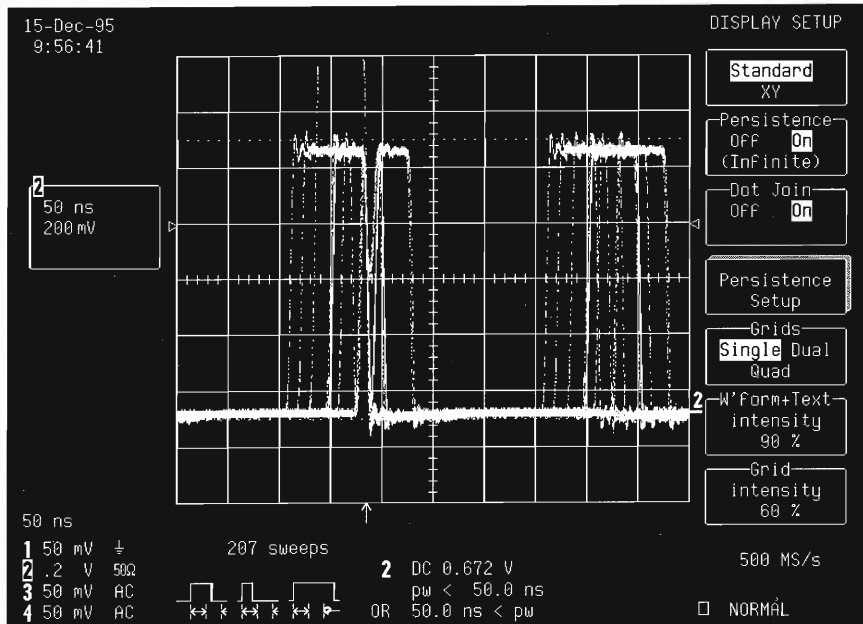

Tips: A further enhancement is obtained by combining the Exclusion Trigger with built-in Pass/Fail testing. The trigger speeds the acquisition of exceptional pulses, while the mask testing verifies the waveshape. Storing the waveform or printing the screen display can individually document each exceptional pulse.

Measuring Skills

Waveform parameter statistics provide additional information about the key waveform parameters for these exceptional pulses — as shown on the final screen, below. For instance, the parameter width shows the pulse width varying from 6.6–75 ns. Using this new information, the trigger setup can be changed to concentrate on acquiring pulses with specific characteristics.

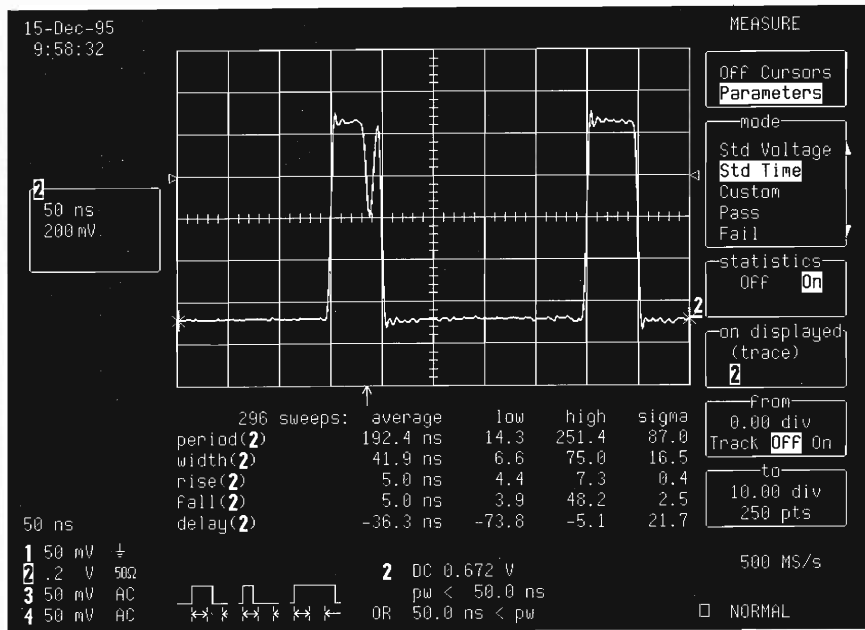



Triggering on Lost Signals

Another SMART function of the 9300 Series is the Dropout Trigger. This trigger event is generated to make an acquisition whenever a signal becomes inactive for a selected time at the end of the timeout period, following the final trigger-source transition. Ideal for detecting interruptions in data streams (network hang-ups, microprocessor crashes and others) the Dropout Trigger is typically used to look for the 'last normal' interval in a lost signal.

Application Setup

Connect the signal to be measured — a 1 kHz squarewave — to CH 1.

STEP 1 

Reset: Press , top menu  and  simultaneously.

Then press  to turn off Trace 2.

STEP 2 

Press 

Then press the corresponding menu  to select from the 'Coupling' menu the coupling matching the source's impedance — 50 Ω .

STEP 3

Note: This screen shows the 1 kHz repetitive squarewave before the signal disappears.

Press  The screen will display:

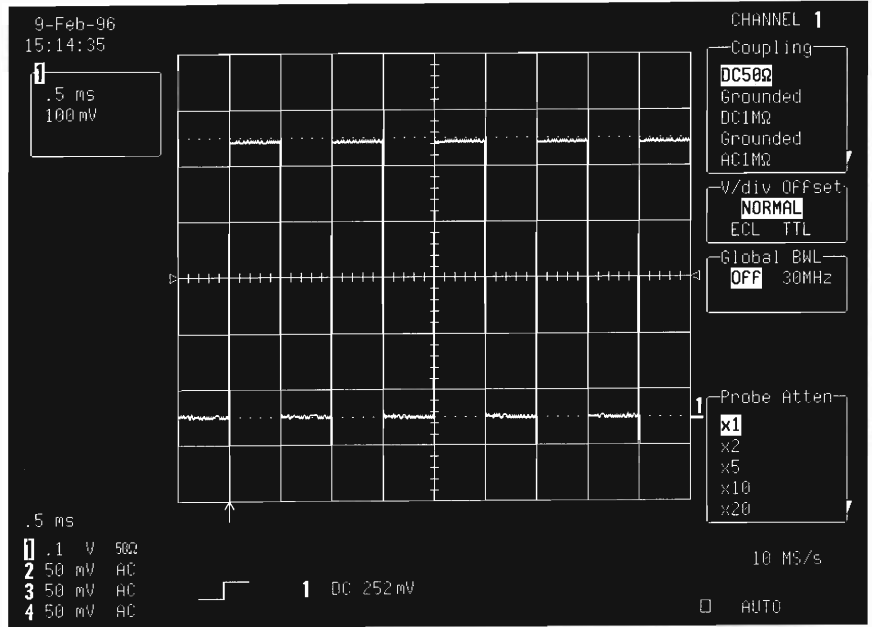

The following steps set the trigger to capture only the 'last normal' period of the signal and transient signal.

STEP 4

Press 

Note: 'Edge' — for Edge Trigger — is selected by default. This trigger is described by source and coupling, as well as slope, and level condition — the same parameters used to build up the SMART Trigger.

The screen will then display:

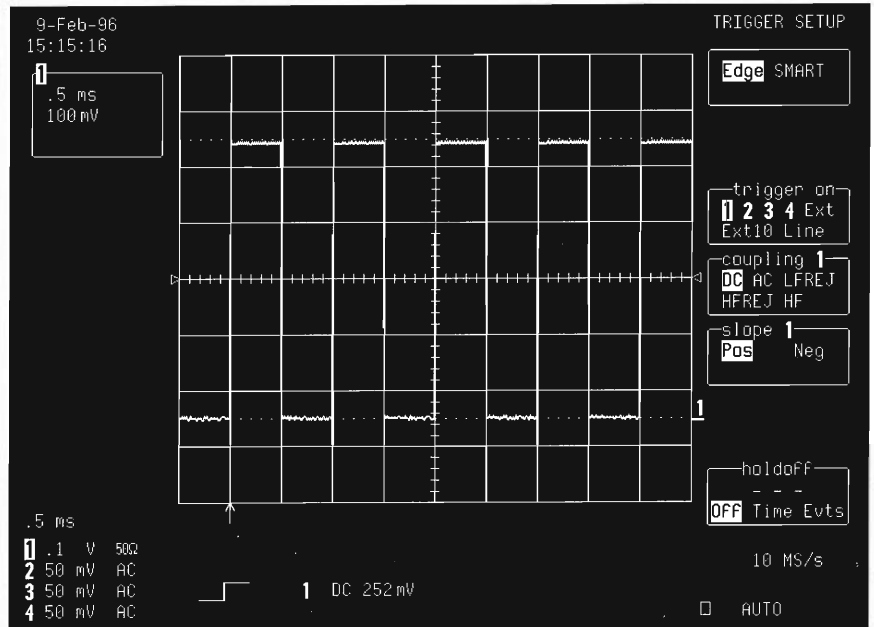

STEP 5 

Press the corresponding menu s to select 'SMART' from the top menu, then for 'SETUP SMART TRIGGER', and then 'Dropout' from the 'type' menu.

The screen will display:

Note: The Dropout Trigger is used essentially for single-shot applications — usually with a pre-trigger delay. By default, the timeout is 25 ns.

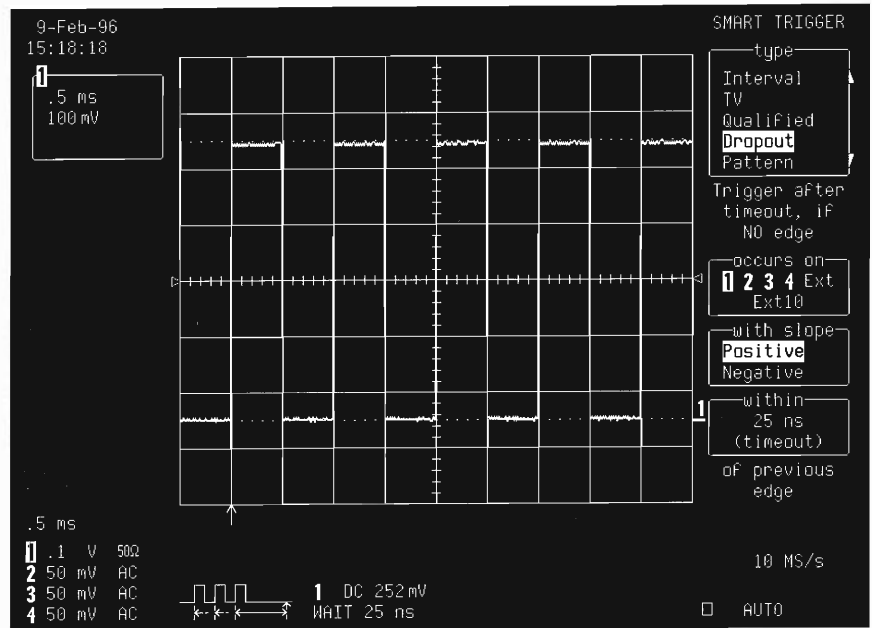

STEP 6

Press  to activate the trigger.

Tips: The Dropout Trigger must be set (in descending order) on the SMART TRIGGER menus as follows:

Trigger after timeout, if NO edge
within (timeout)
of previous edge.

In order to capture the squarewave when it disappears, the timeout must be longer than the signal period. There is no triggering when the repetitive signal is active, because two successive edges occur in a single period — 1 ms in this example.

STEP 7



Turn  to set the timeout. For this example, the timeout must be greater than 1 ms.

Now turn  to set the trigger point to just left of mid-screen and allow the display of the signal's 'last normal' period.

The screen will now display:

Note: As shown here, the scope will no longer trigger until after the signal disappears.

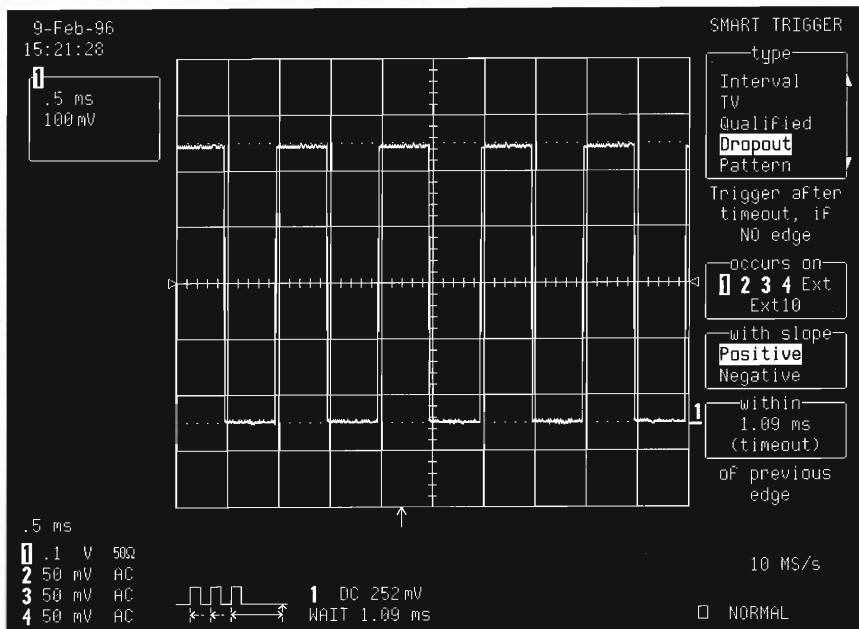

Once the signal has disappeared, the acquisition is performed. The last screen displays the 'last normal' period and the transient signal.

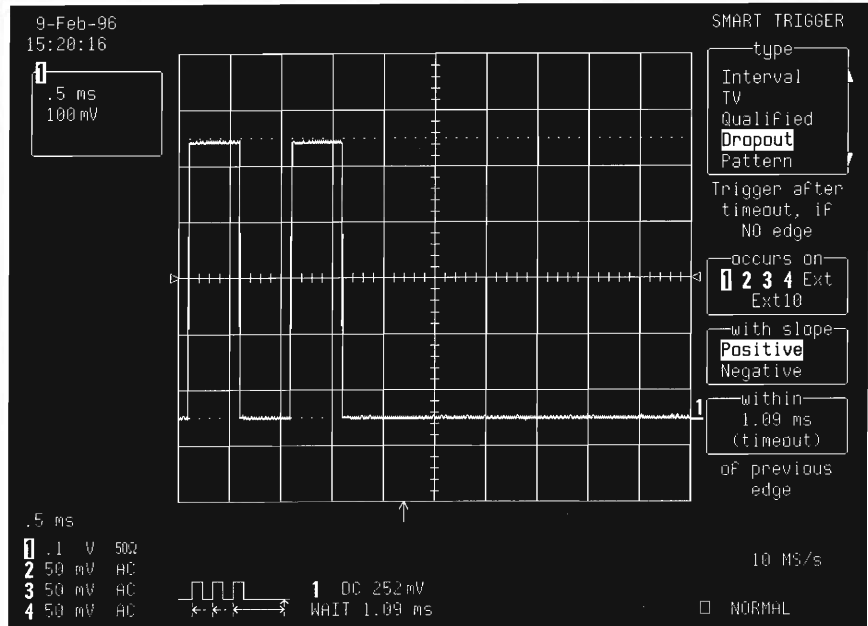



Transferring Data to PC

Transfer to PC of real acquired waveform data is obviously very practical when calculating or storing data using common spreadsheet or math software.

This tutorial shows how to do this in three ways — using GPIB, floppy or RS232 communication port.

Because common PC software runs on the ASCII format, a binary-to-ASCII conversion will need to be done following transfer — also explained below.

Transfer by GPIB

Hardware Required

PC equipped with GPIB (General Purpose Interface Bus) card.

Software Required

gtalk.exe and gt.bat software — free from LeCroy (*Contact your nearest sales office*).

Application Setup

Connect the signal to be acquired to CH 1.

UTILITIES

Press 

Then press the corresponding menu  for 'GPIB/RS232 Setup'. Press  to select 'GPIB', if not already selected (normally by default), from the 'Remote' menu.

The screen will display:

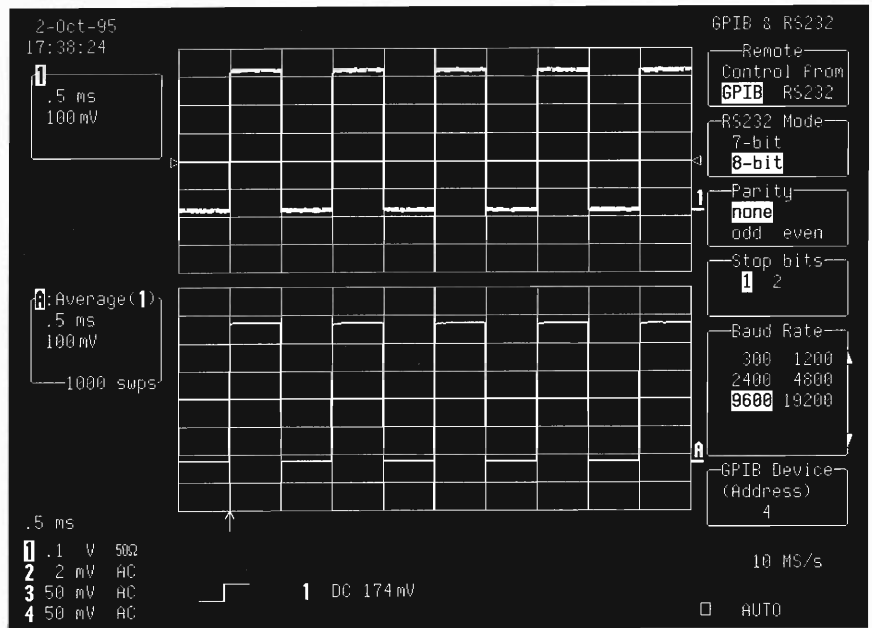
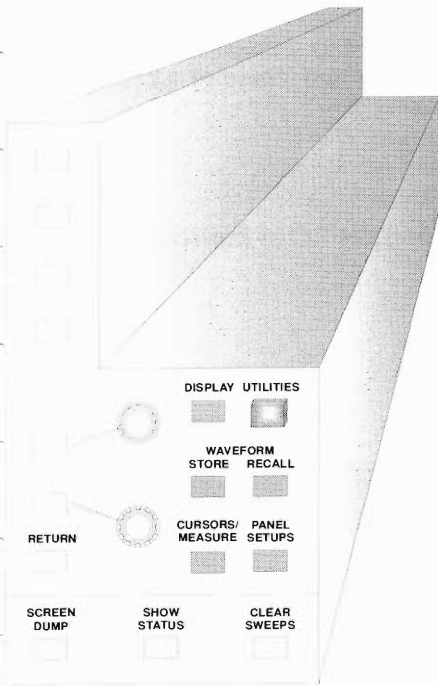

STEP 1

Note: The scope's address GPIB must be '4'. This allows remote control by GPIB commands (see Remote Control Manual). Auto-read (Alt D) must also be disabled.

With the acquisition performed:

Type in the command 'gt' at the DOS prompt

This will run the GTALK program on the PC.

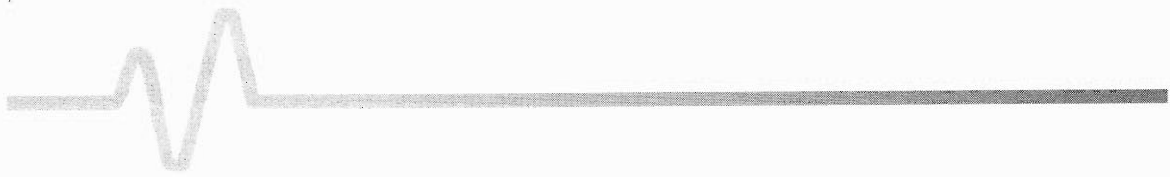

STEP 2 

Type in the command 'C1:WF?' (for the complete list of WAVEFORM command descriptions, see the *Remote Control Manual*).

STEP 3 

Press Alt F to select the output linking the PC to the scope.

STEP 4 

Give the output file a name.

Note: The PC window will display the number of bytes transferred. By default, each point is defined by a word (two bytes). Added to the total of transferred bytes are those of the descriptor, which gives all the oscilloscope setup details.

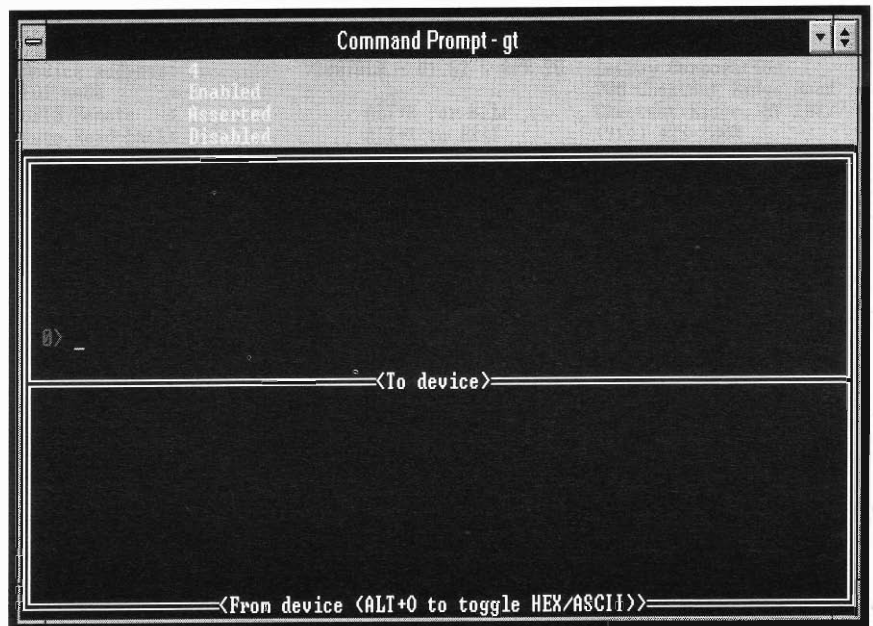

'GTALK' PC program window

STEP 5 

Press Alt X to exit.

Transfer to Floppy

Hardware Required

9300-Series scope with FD01 disk-drive option.

STEP 1

Press  to store data in a source file (format: Name.000 or .001 or .002 — given by the oscilloscope).

STEP 2

Note: A message will appear at the top of the scope screen announcing the successful storage of the data and giving the name of the file on which the data is stored on the floppy.

Press the corresponding  button to select 'Flpy' from the 'to' menu. The screen will display:

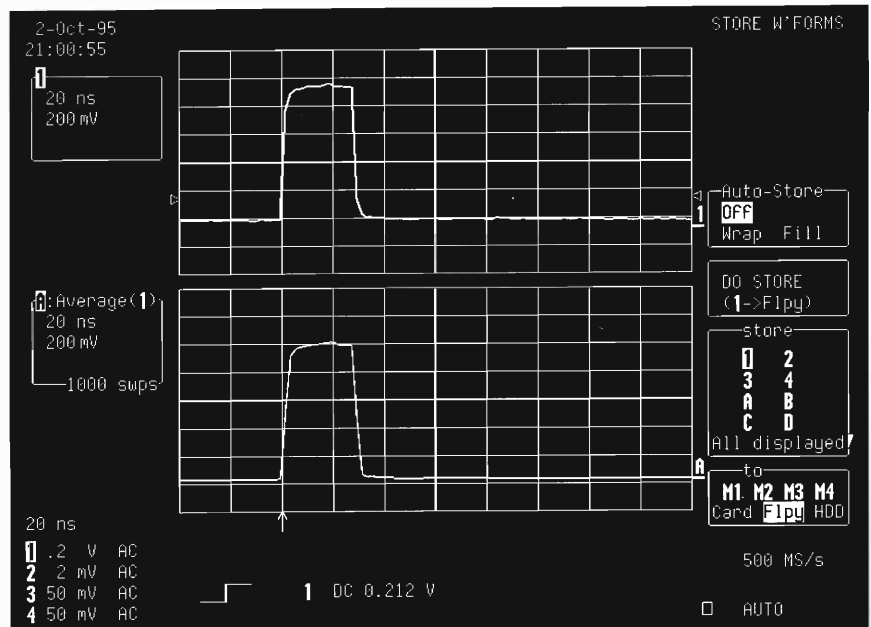

STEP 3

Press the corresponding menu  for 'DO STORE'.

STEP 4

Eject the floppy from the scope and place it in the PC, thus completing the transfer.

Transfer by RS232

Hardware Required

PC with RS232 communication port.

Software Required

LCRS232.exe — free from LeCroy.

Application Setup

Connect the signal to be acquired to CH 1.

UTILITIES
Press 

Then press the corresponding menu s for ' GPIB/RS232 Setup' and to select 'RS232' from the 'Remote' menu.

The screen will display:

Note: Check that the scope's RS232 setup and connections (see Remote Control Manual). PC default values are valid.

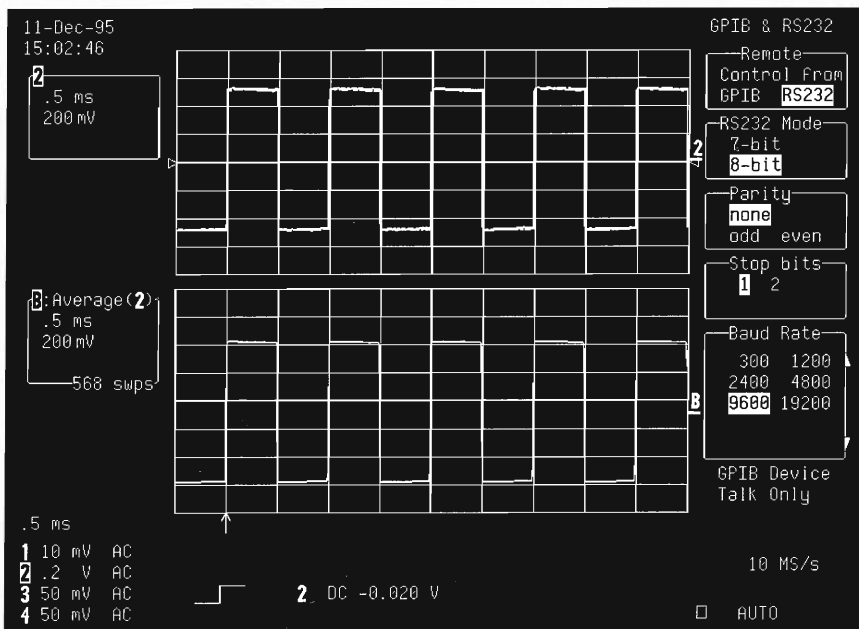

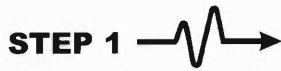

Type 'LCRS232.exe' in response to the DOS prompt to run the program **LCRS232**. This program allows remote control of the oscilloscope by typing in commands (see *Remote Control Manual* for the full command list.) in response to prompts such as 'Your Choice : '.

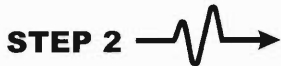

Type in 'Your Choice : S' — to store a waveform.

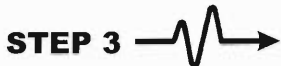

Type in 'Channel : C1' — if the waveform is on CH 1.

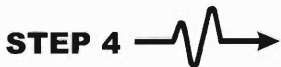

Using — for example — *isis* as a file name:

Type in 'Filename : *isis*' — to name the stored binary data file.

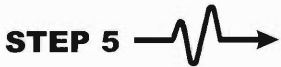

Press Alt X to exit.



Converting Binary to ASCII

Hardware required

PC

Software required

94TRAN.exe and 94xx.tpl software — free from LeCroy.

STEP 1



To run the 94TRAN program, converting binary data from an oscilloscope binary source file named *Isis* to a PC ASCII output file named — for example — *Osiris*:

Type **'94tran -oOsiris Isis'** ('94tran -oOutputfilename Sourcefilename') at the DOS prompt.

The binary-format file from the oscilloscope can now be read in ASCII by common PC software programs.

Tips: Help for 94TRAN is available by typing '94tran'.

Conversion of data from the LeCroy binary format to ASCII format creates an output file that requires 10–20 times the disk space of the original LeCroy binary file. A one-megabyte record will typically take up 13–15 MB when stored in ASCII.

Program 94TRAN may run for some minutes when executed for long waveforms of several kB.

STEP 2



Open the file converted to ASCII with the application of choice.



Transferring Images to PC

The images are TIFFs (Tagged Image File Format) and BMPs (Bitmaps) that replicate what is shown on the oscilloscope screen. It is extremely handy to transfer them to PC so that they can be incorporated into work done using common PC software — a report, for example.

The following tutorial shows how to do this with TIFF, condensed TIFF or BMP images, by means of GPIB (General Purpose Interface Bus), floppy or RS232 communication port.

Transfer by GPIB

Hardware Required

Personal computer equipped with GPIB card.

Software Required

gtalk.exe and gt.bat software — free from LeCroy.

Application Setup

(The screen to be saved will have already been set up.)





UTILITIES

Press 

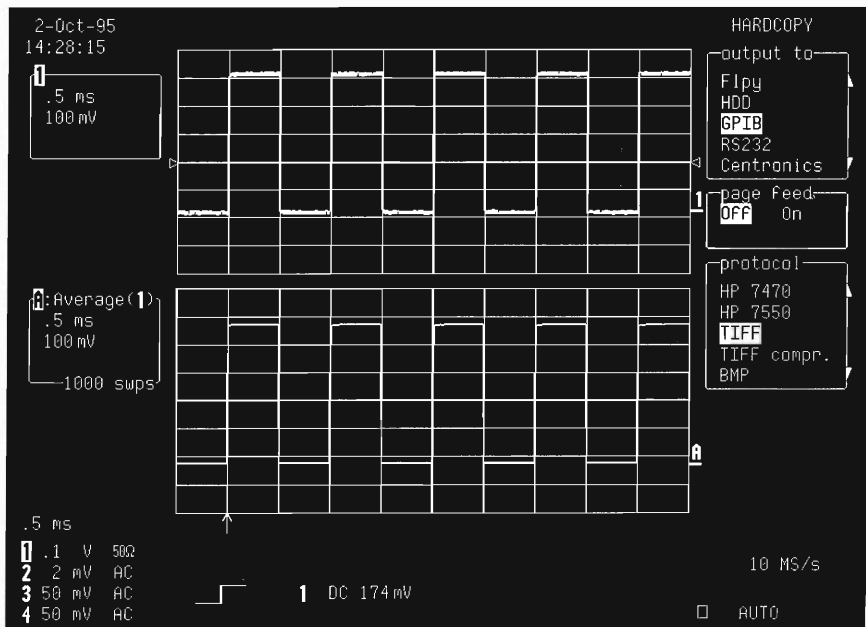

Then press the respective menu s — first, for 'Hardcopy Setup', then to select 'GPIB' from the 'output to' menu, and then to select 'TIFF', 'TIFF compr.' (compressed TIFF) or 'BMP' from the 'protocol' menu. Here, 'TIFF' is selected.

The screen will display:



UTILITIES

Again, press 

Then, (as described in the directions for data transfer in the previous chapter) **press the corresponding menu  for 'GPIB/RS232 Setup'. Then press  to select 'GPIB', if not already selected (normally by default), from the 'Remote' menu.**

The screen will display:

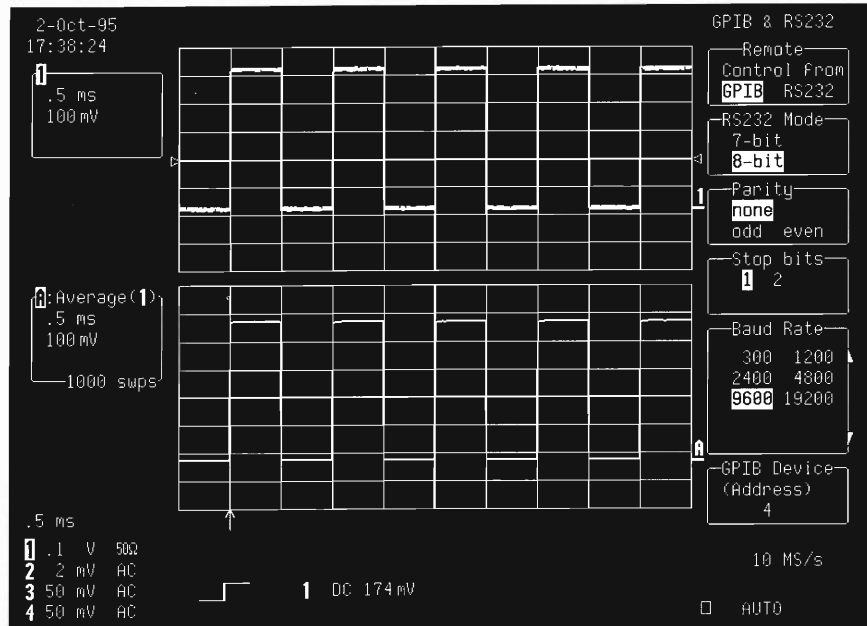

STEP 1

With the acquisition performed:

Type 'gt' at the DOS prompt.

This will run the GTALK program on the PC.

Note: The scope's address GPIB must be '4'. This allows remote control by GPIB (see Remote Control Manual). Auto-read (Alt D) must also be disabled.

STEP 2 

Press **Alt L** to control the scope in **Local Mode**, which allows a screen dump with a selected menu, but without the message 'Go to Local'.

STEP 3 

Type the command 'SCDP'

STEP 4 

Press **Alt F** to select the output linking the PC to the scope.

STEP 5 

Give a name to the screen dump file.

Note: If the size of the TIFF or other image file is not exactly 71 890 bytes, the file will be corrupted. The GPIB setup will then need to be verified and the transfer redone.

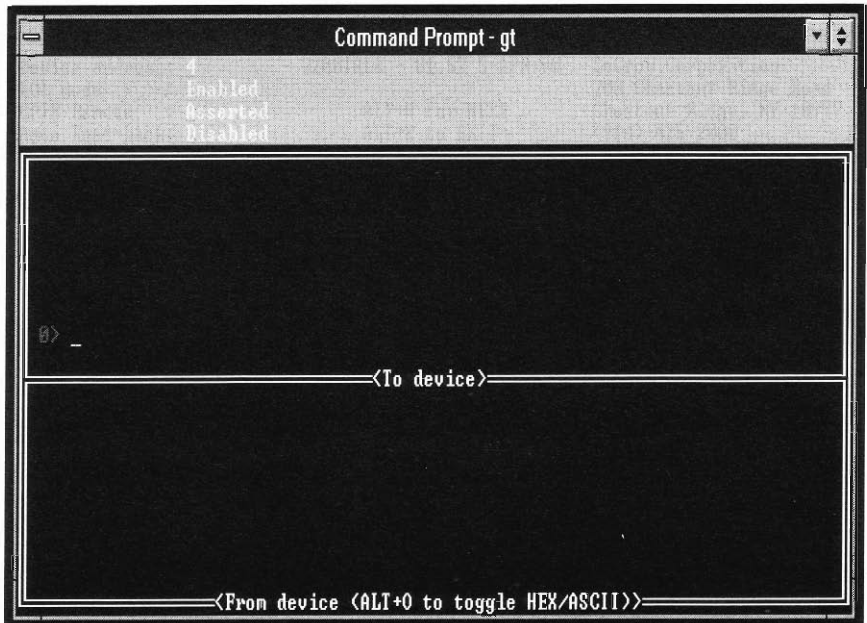

'GTALK' PC window

STEP 6 

Press **Alt X** to exit.

Transfer to Floppy

Hardware Required

9300-Series scope with FD01 disk-drive option.

Application Setup

(The screen to be saved will have already been set up.)

UTILITIES
Press 

Then press the respective menu s, first, for 'Hardcopy Setup', then to select 'Flpy' from the 'output to' menu, and then to select a file format — 'TIFF', 'TIFF compr.' or 'BMP' — from the 'protocol' menu.

The screen will display:

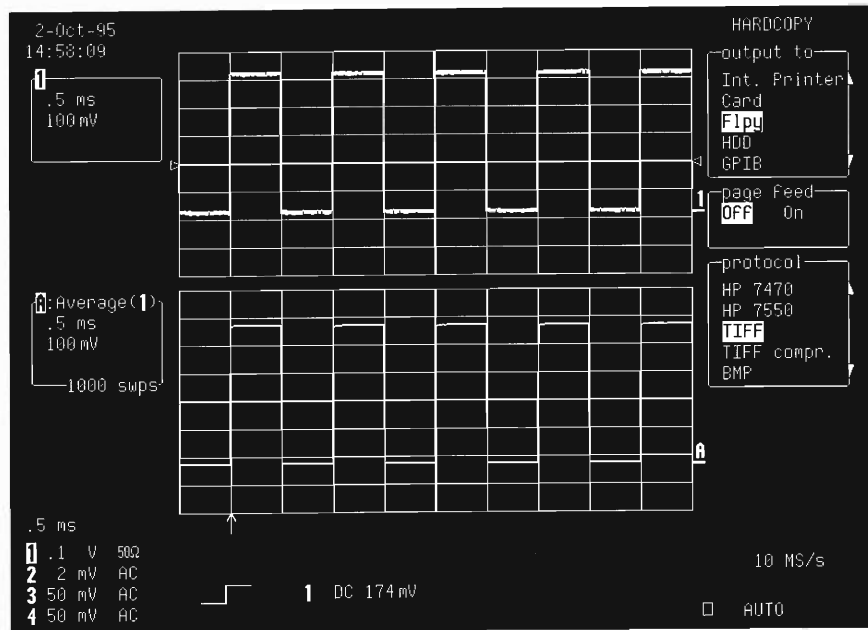

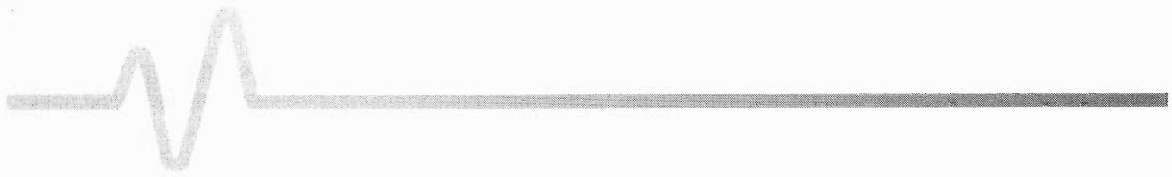



STEP 1 

Once the screen image to be transferred is ready:

SCREEN
DUMP

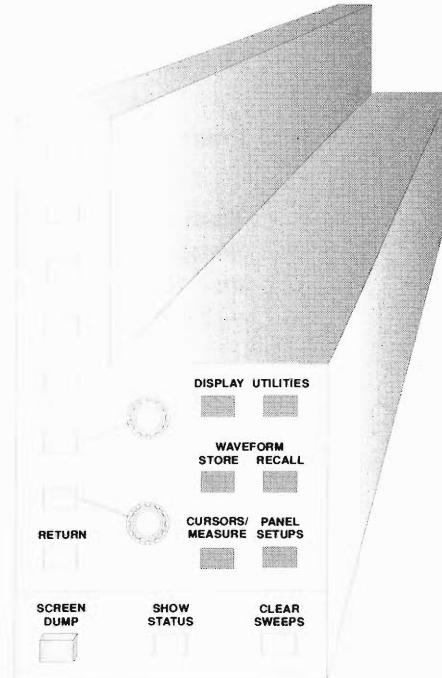
Press  to store data in a source file on the floppy (format: Name.000 or .001 or .002, given by the oscilloscope).



STEP 2 

Eject the floppy from the scope and place it in the PC. The TIFF or BMP can now be directly imported into files run on common software that recognizes its file format .

Transfer by RS232

Hardware Required

PC with RS232 communication port.



Software Required



LCRS232.exe — free from LeCroy.

Application Setup

Capture signal for transfer on CH 1.

Note: To save the image of a complete acquisition, first press STOP or SINGLE.

Press  , then the respective menu  s, first, for 'Hardcopy Setup', then to select 'RS232' from the 'output to' menu, and then to select a file format — 'TIFF', 'TIFF compr.' or 'BMP' — from the 'protocol' menu.

Again press  and then the corresponding menu  s for 'GPIB/RS232 Setup', and to select 'RS232' from the 'Remote' menu. The screen will display:

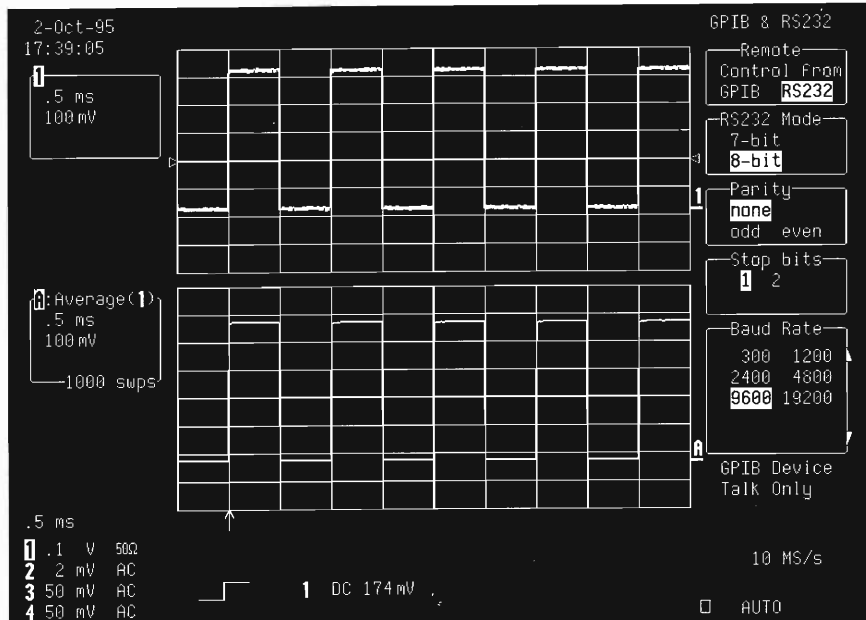

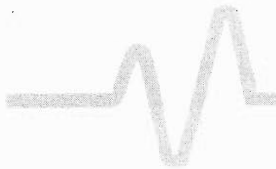

STEP 1 

Type 'LCRS232.exe' in response to the DOS prompt to run the program LCRS232. This program allows remote control of the oscilloscope by typing in commands (see *Remote Control Manual* for the full command list.) in response to prompts such as 'Comment :'.

Note: Check the scope's RS232 setup and connections (see *Remote Control Manual*), and that PC default values are valid.

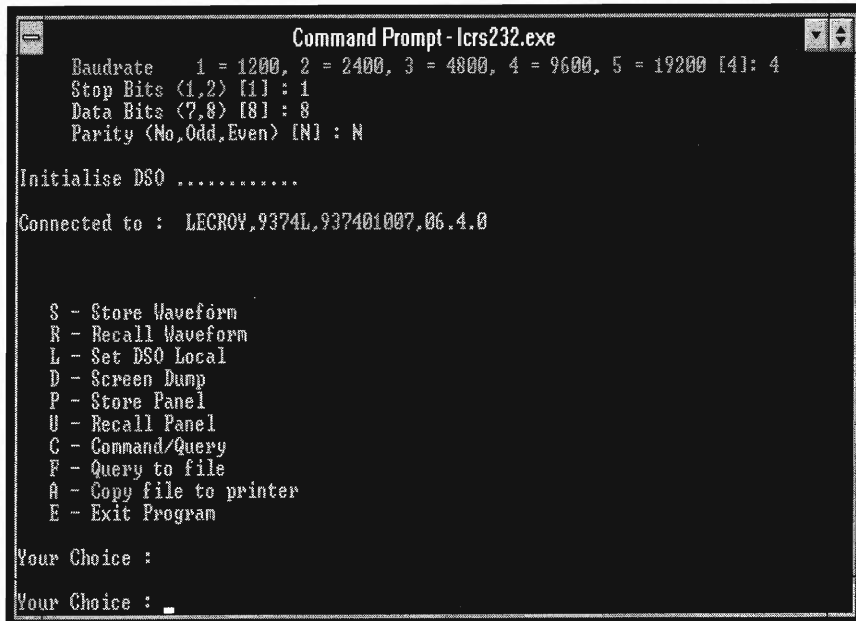

```
Command Prompt - lcrs232.exe
Baudrate 1 = 1200, 2 = 2400, 3 = 4800, 4 = 9600, 5 = 19200 [4]: 4
Stop Bits (1,2) [1] : 1
Data Bits (7,8) [8] : 8
Parity (No,Odd,Even) [N] : N

Initialise DSO .....

Connected to : LECROY,9374L,937401007.06.4.0

S - Store Waveform
R - Recall Waveform
L - Set DSO Local
D - Screen Dump
P - Store Panel
U - Recall Panel
C - Command/Query
F - Query to file
A - Copy file to printer
E - Exit Program

Your Choice :
Your Choice :
```

'LCRS232' program window

STEP 2 

Type in 'Your choice : D' — to send the image file to the PC.

STEP 3 

Type in 'Comment : text' — if a comment is desired to be placed on the TIFF image, above the grid. A name or title could be inserted, such as 'Comment : For Isis Report'.

STEP 4 

Again using *Isis* as an example name:

Type in 'Filename : Isis' — to name the stored TIFF file.

STEP 5 

Press Alt X to exit.



A Solid Base

Having completed Part 3 and the guide, you will be well-grounded in the efficient operation of LeCroy 9300-Series oscilloscopes. This solid base of experience should make all your measurements easier.

The guide should also continue to serve as a practical reference to turn to when needed. Use it in conjunction with the accompanying *Operator's Handbook*, keeping both always close at hand.

We wish you excellent measuring.

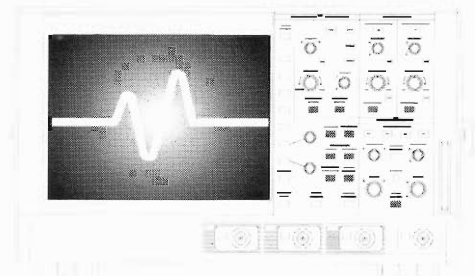

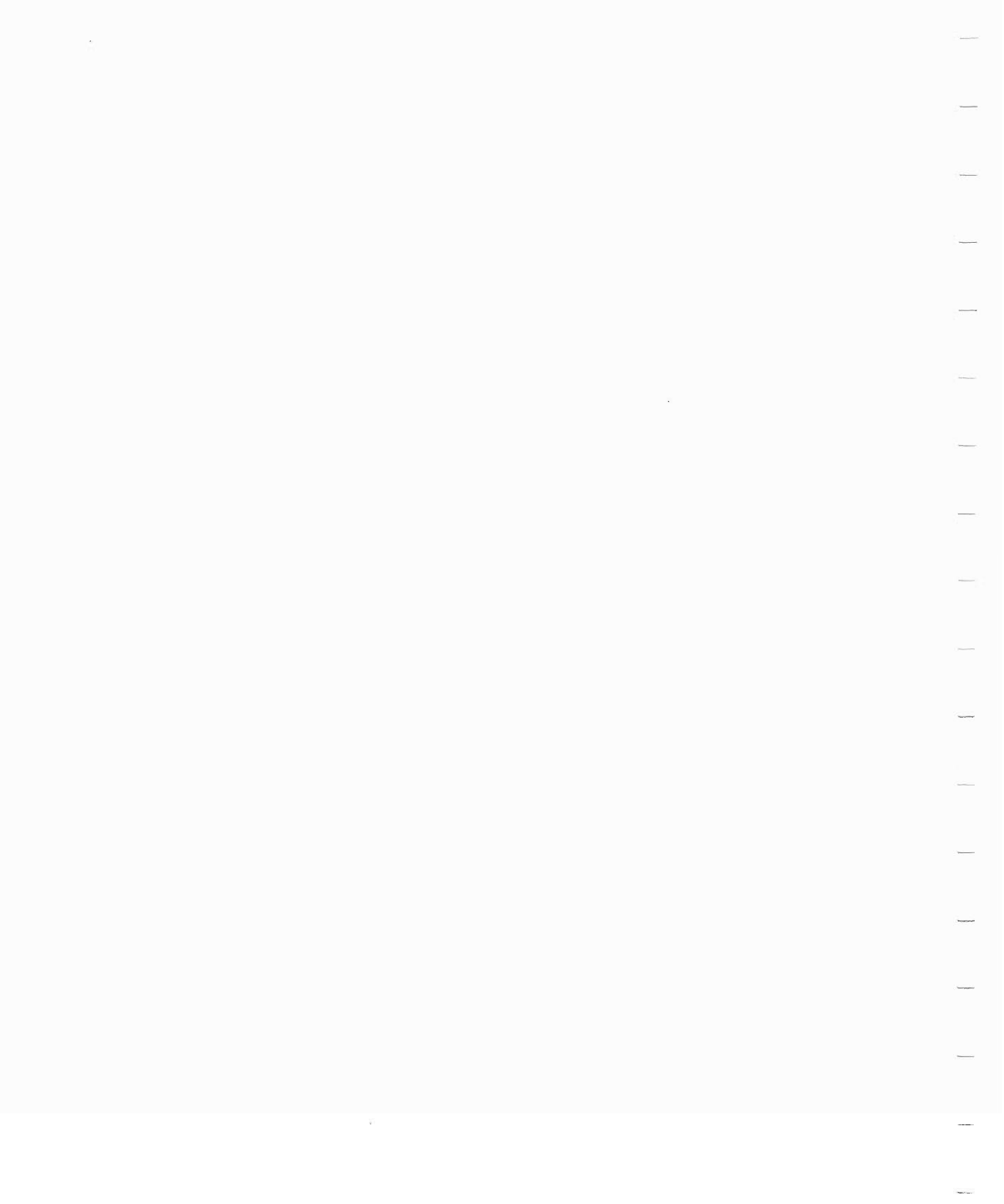

A

- absolute amplitude**
 - display, 3–24
 - mode, 3–19
- absolute time mode, 3–20;**
3–21
- acquisition memory system,**
1–2
- ADC. See analog-to-digital
converter**
- aliasing. See interpolation**
- amplifier, 1–2**
- amplitude**
 - read by cursors, 3–16
- amplitude mode. See cursors**
- analog-to-digital converter
(ADC), 1–2; 1–6; 3–6**
- analyzing, 1–4; 1–9 to 10**
- AUTO SETUP button, 2–2 to
3; 2–2 to 7**
 - in first steps common to
most measurements, 3–2;
3–4
- Auto-Store**
 - 'Fill', 3–97
 - 'Wrap', 3–97
- Average**
 - used to remove noise, 3–26
to 30
- averaging traces, 29**

B

- bandwidth, 1–3**
- binary to ASCII conversion.**
See data transfer to PC
- bitmap (BMP)**
 - transfer to PC. *See data
transfer of images*

- buttons. See under
respective function names**
 - non-use during sequence
acquisition, 3–46

C

- capturing, 1–4; 1–5 to 7**
- channel input sensitivity**
 - adjusting, 3–7
- characterizing a pulse, 3–9 to
15**
- CLEAR SWEEPS button,**
3–15; 3–29
 - for setting or clearing
persistence, 35
- communication port RS232,**
3–134; 3–141
- controls**
 - front-panel main controls.
*See front-panel controls
menus, 3–5*
- coupling, 3–3; 3–114**
 - four-channel models, 3–3
 - two-channel models, 3–3
- COUPLING button**
 - in first steps common to
most measurements, 3–3
- cursors, 2–14**
 - absolute time, 3–21; 3–22
 - accurate measuring with,
3–16 to 25
 - cursor knobs. *See moving
cursors under cursors*
 - horizontal, 3–16
 - in telecom mask testing,
3–88
 - moving cursors, 2–14; 2–15;
3–13; 3–18; 3–23
 - reference and difference,
3–23; 3–24; 3–25
 - time. *See horizontal cursor
vertical, 3–16*

Note: 1–,2– or 3– prefixing page numbers denotes the part of the guide in which the reference is found.

Index entries in bold are first, primary or general references, whilst those in roman define a particular correspondence.

Entries such as 3–6 to 12 indicate a range of pages.

CURSORS/MEASURE button,
14; 20; 3-11
in telecom mask testing,
3-87
custom mode, 3-15
custom parameter mode
parameters and histograms,
3-66; 3-67

D

data transfer, 1-4
data to PC, 3-134 to 40
images (TIFFs, BMPs) to
PC, 3-141 to 49
deadtime
reducing it using sequence
mode, 3-37 to 46
default power-up settings,
3-2
DELAY knob, 2-11
to set trigger point, 3-132
digitizing, 3-6
on all eight bits, 3-6
display, 1-4; 2-3
DISPLAY button, 2-12; 3-101
documenting, 1-4; 1-11
dropout trigger (SMART)
on lost signals, 3-128 to 33
DSO (Digital Signal
Oscilloscope), 1-1 to 12
advantages, 3-9
basic elements, 1-2
dual display mode, 3-76

E

edge trigger (SMART), 3-113;
3-121; 3-130
eight-bit digitizing, 3-6 to 8
Enhanced Resolution option,
3-107
exclusion trigger (SMART),
3-122
EYE-diagram analysis, 1-10

F

Fast Fourier Transform (FFT)
WP02 FFT option. *See*
spectrum analyzer,
frequency domain
analysis
FD01 disk-drive option. *See*
data transfer to PC using
floppy
FFT, 1-9; 2-19; 2-20. *See*
Fast Fourier Transform
first steps common to most
measurements, 3-1 to 5
four-channel models, 2-8;
2-10; 3-3
frequency domain analysis,
1-9; 3-47 to 53
frequency resolution
to increase, 3-52
front-panel controls, 2-2;
2-5
AUTO SETUP, 2-3; 2-7
CHANNELS, 2-3; 2-8
CURSORS/MEASURE, 2-3
'L'-shaped control panel
(menu controls), 2-5
TIMEBASE + TRIGGER,
2-3; 2-7
TIMEBASE controls, 2-9
TRIGGER controls, 2-11
vertical controls, 2-10
ZOOM + MATH, 2-3

G

glitches, 1-5
capture, 3-111 to 18
GPIO (General Purpose
Interface Bus), 3-134;
3-141
GTALK. *See* data transfer to
PC

H

hard disk drive
removable, 3-93 to 97
HDD. See hard disk drive
histograms, 1-10; 3-59 to 70
horizontal cursor. See
cursors
horizontal parameters, 3-12

I

initialization, 2-4
installation, 2-4
interfaces, 1-11
interpolation, 3-71 to 79
slow timebase acquisitions,
3-78
interval trigger (SMART),
3-122

K

knobs. See under respective
function names
acceleration sensitivity,
2-11
non-use during sequence
acquisition, 3-46

L

local mode
in transfer of images to PC,
3-144
long memory option. See
long waveforms
long waveforms, 3-98 to 110
lost signals. See dropout
trigger (SMART)

M

mask comparison, 1-10
MATH SETUP button, 2-17;
2-19; 3-49

for boosting Math functions,
3-50
for long-waveform
acquisition, 3-102
to display recalled telecom
masks, 3-83

measuring, 1-8
memory length, 1-4
menu box, 2-5; 2-10; 2-17;
3-5

menu button, 3-5

menus

'Action', 3-91
'at end of', 3-122
'Auto-Store', 3-97
'Avg Type', 2-18; 3-29
'Category', 3-60; 3-67
'Change Test', 3-91
'Coupling', 3-3
'Dot Join', 3-73
'for Math use', 3-84; 3-102
'FROM DEFAULT SETUP',
2-5
'from Memory', 2-21
'Grids', 2-12; 3-27; 3-48;
3-76; 3-101
'if', 3-91
knobs, 3-5
'mask', 3-89
'Math Type', 2-18; 3-29;
3-50; 3-57; 3-74; 3-107
'measure', 3-60
'mode', 2-12; 3-16; 3-18;
3-20; 3-66
moving through, 3-5
'of', 3-67; 3-89
'On line', 3-67
'output', 3-145
'output to', 3-142
'Parameters', 3-11
'Persistence', 3-33 to 35
'protocol', 3-142; 3-145
'Record up to', 3-52; 3-99
'Reference', 3-20
'Remote', 3-135; 3-142
'Sequence', 3-41



software options displayed,
3-57
'statistics', 2-16; 3-14
'Stop', 3-91
'Test on', 3-88
'testing', 3-88
'Text & Times', 3-44
'Then', 3-91
'time', 3-20
TIMEBASE, 3-99 to 100
'to', 3-14; 3-137
'trigger on', 3-122
'type', 2-20; 3-18; 3-22;
3-130
'use Math?', 3-49; 3-56;
3-74; 3-106
'using up to', 3-65
'width', 3-116; 3-122

N

noise

using Average to remove it.
See Average

NORM button, 2-20

to run telecom mask test,
3-89
to start SMART trigger,
3-116; 3-124; 3-131

Nyquist limit (aliasing). *See*
interpolation

O

OFFSET knob, 2-22

Options

WP01, WP02, WP03,
Enhanced Resolution,
3-107

P

**PANEL SETUPS button, 2-4;
2-22**

parameter statistics

in capture of rare
phenomena, 3-125

parameters, 2-16

automatic measurement of,
3-9
categories of. *See* menus,
'Category'
horizontal. *See* horizontal
parameters
in telecom mask testing,
3-87
menu. *See* menus
read by remote control, 3-15
standard. *See* standard
parameters
statistical analysis. *See*
histograms
values, 3-14
vertical. *See* vertical
parameters
with histograms, 3-59 to 70

Partial Response Maximum

Likelihood (PRML), 1-10

Pass/Fail function, 1-6; 1-10.

See telecom mask testing
with exclusion trigger, 3-125

PC

transfer of data to, 3-134
to 40

PC card. *See* hard disk drive peak detect system, 1-5

persistence

in capture of rare
phenomena, 3-125
showing edge jitter, 3-56

persistence mode, 3-31 to 36

display in glitch capture,
3-117

phenomena

analysis of difficult-to-
measure phenomena. *See*
histograms
rare. *See* SMART trigger

POSITION knob, 2-13; 2-18

in long-waveform acquisition,
3-104

processor, 1–2
pulse parameters, 1–8

Q

quantification, 3–7
quantization
 on all levels, 3–6

R

RAM (Random Access Memory), 3–98
Random Access Memory.
 See RAM
Random Interleaved Sampling (RIS), 1–5
RECALL button, 2–21
relative amplitude mode, 3–19; 3–20
relative time mode, 3–22; 3–23
removable hard disk drive.
 See hard disk drive
reset
 in first steps common to most measurements, 3–2
RESET button, 3–105
 for ZOOM + MATH, 3–2
 with histograms, 3–63
roll mode, 1–5

S

sample rate, 1–3
sequence acquisition, 3–37 to 46
sequence mode, 1–6; 3–37 to 46
 for determining acquisition duration, 3–42
 setting timebase, 3–43
Setup Save and Recall, 2–22
SHOW STATUS button, 3–108
 in long-waveform acquisition, 3–105
Sin(x)/x interpolation. *See* interpolation
single-shot acquisition, 1–5
slow timebase
 acquisition using interpolation, 3–78
SMART trigger, 1–6; 3–119 to 27. *See* edge, dropout, interval triggers
 in glitch capture, 3–114 to 15
SNGL button
 for long-waveform acquisition, 3–100
 for storing to hard disk, 3–94
 to stop acquisition, 3–99
 used to stop scope, 3–17
source
 selection, 3–113
spectrum analyzer
 using the scope as, 3–47 to 53
standard parameters
 time, 3–9
 voltage, 3–9
statistical domain, 1–10
STOP button, 2–19; 3–11; 3–120

STORE button

for storing to hard disk, 3-94
storing to removable hard disk. *See* hard disk drive
summed averaging, 2-17
sweeps, 3-29; 3-30
system memory, 1-2

T

TC1 software. *See* telecom mask testing
telecom mask testing, 3-80 to 92

test masks. *See* telecom mask testing

threshold position, 2-11

TIFFs

transfer to PC, 3-141

time cursor. *See* horizontal cursor

time domain, 1-9

time values

read by cursors, 3-16

TIME/DIV knob, 2-9

used to slow down timebase, 3-100

TIMEBASE + TRIGGER, 2-3

TIMEBASE SETUP button, 3-99

for display of no. points, time between pts., and sampling rate, 3-73

trace labels, 2-7; 2-10

TRACE ON/OFF button, 2-8; 2-10; 2-13; 2-17; 3-2

for display of multiple traces and grids, 3-77

traces, 3-2

train pulses, 3-39

trigger position, 2-11

TRIGGER SETUP button, 3-120

for glitch capture, 3-112
on lost signals, 3-129
triggering, 1-6

U

UTILITIES button, 3-142

V

VAR button, 2-3; 2-10; 3-7

vertical cursor. *See* cursors

vertical parameters, 3-12

viewing, 1-4; 1-7 to 8

VOLTS/DIV knob, 2-10; 2-22

W

waveform math, 1-8

waveform memories, 2-20

WAVEFORM STORE and RECALL buttons, 2-3

WAVEFORM STORE button, 2-21

WP01 waveform processing option, 3-107

WP02 FFT option, 3-107

WP03 waveform processing option, 3-107. *See* histograms

X

XY mode

with persistence, 3-34

Z

ZOOM, 2-12

ZOOM knobs, 2-13

in long-waveform acquisition, 3-104

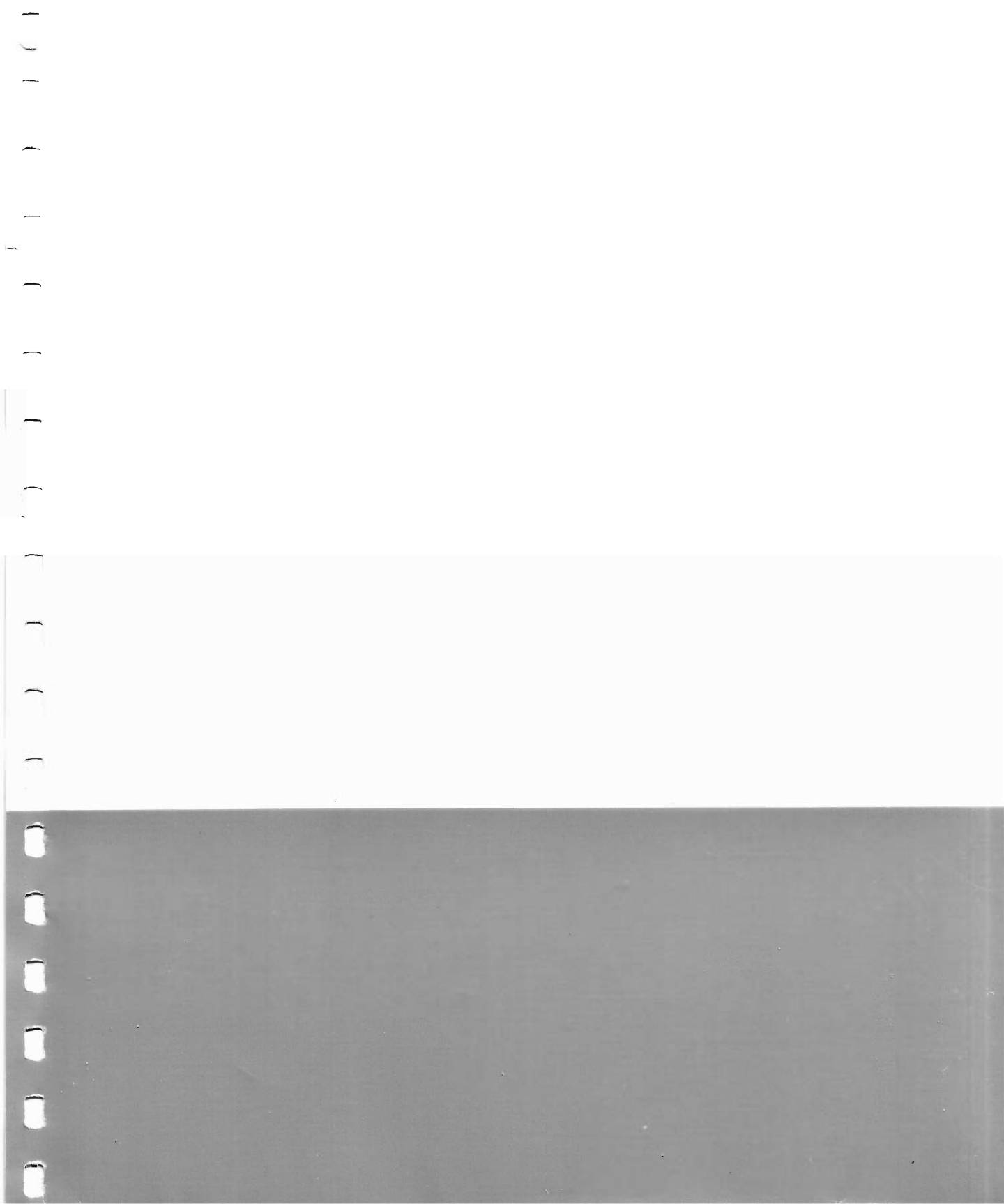

LeCroy