



AM/FM SIGNAL GENERATORS

2030 Series



Operating Manual

Document part no. 46891/976

SIGNAL GENERATORS

2030 series

2030 10 kHz to 1.35 GHz

2031 10 kHz to 2.7 GHz

2032 10 kHz to 5.4 GHz

Includes information on:

Option 001 - Second modulation oscillator

Option 002 - Pulse modulation

Option 003 - High output power

Option 005 - GMSK Bt 0.3

Option 006 - Avionics

Option 008 - RF profiles and complex sweep

Option 009 - Pulse generator

Option 010 - DME modulator

Option 012 - Electronic attenuator

Option 100 - Single fuse version

Option 105 - Modified pulse modulator

Option 112 - EXT MOD 2 input 600 Ω

This manual applies to instruments with software issues of 9.07 and higher.

© Aeroflex International Ltd. 2007

No part of this document may be reproduced or transmitted in any form or by any means, electronic or mechanical, including photocopying, or recorded by any information storage or retrieval system, without permission in writing by Aeroflex International Ltd. (hereafter referred to throughout the document as 'Aeroflex').

Printed in the UK

Manual part no. 46891/976 (PDF version)

Based on Issue 35 of the printed manual.

04 April 2007

Contents

	Tab numbers	
PREFACE		
PRECAUTIONS		
Chapter 1	GENERAL INFORMATION	1
Chapter 2	INSTALLATION	2
Chapter 3-1	OPERATION	3
Chapter 3-2	GPIB OPERATION	4
Chapter 4-1	BRIEF TECHNICAL DESCRIPTION	5
Chapter 5-1	ACCEPTANCE TESTING	6
App. 5-1-A	ACCEPTANCE TESTING SECOND MODULATION OSCILLATOR OPTION	7
App. 5-1-B	ACCEPTANCE TESTING PULSE MODULATION OPTION	8
App. 5-1-C	ACCEPTANCE TESTING HIGH OUTPUT POWER OPTION	9
App. 5-1-D	ACCEPTANCE TESTING ELECTRIC ATTENUATOR OPTION	10
ANNEX A	OPTION 005 GMSK Bt 0.3	11
ANNEX B	OPTION 006 AVIONICS	12
ANNEX C	OPTION 008 RF PROFILES AND COMPLEX SWEEP	13
ANNEX D	OPTION 009 PULSE GENERATOR	14
ANNEX E	OPTION 010 DME MODULATOR	15
INDEX		16
CONTACTS		17

PREFACE

PATENT PROTECTION

The 2030 series Signal Generators are protected by the following patents:

GB 2030391	GB 2214012	
US 4323943	US 4870384	
FR 80.26256	GB 1601822	
GB 2064892	US 4194164	
US 4400630	EP 0125790	
GB 2158999	GB 2140232	
US 4672336	US 4609881	
GB 2217542	GB 2258774	} Instruments fitted with Option 006
US 5061909	US 5375065	
EP 0322139		

Precautions

WARNING

CAUTION

Note

These terms have specific meanings in this manual:

WARNING

information to prevent personal injury.

CAUTION



information to prevent damage to the equipment.

Note

important general information.

Hazard symbols

The meaning of hazard symbols appearing on the equipment and in the documentation is as follows:

Symbol	Description
	Refer to the operating manual when this symbol is marked on the instrument. Familiarize yourself with the nature of the hazard and the actions that may have to be taken.
	Dangerous voltage
	Toxic hazard

General conditions of use

This product is designed and tested to comply with the requirements of IEC/EN61010-1 'Safety requirements for electrical equipment for measurement, control and laboratory use', for Class I, portable equipment and is for use in a pollution degree 2 environment. The equipment is designed to operate from an installation category I and II supply.

Equipment should be protected from the ingress of liquids and precipitation such as rain, snow, etc. When moving the equipment from a cold to a hot environment, it is important to allow the temperature of the equipment to stabilize before it is connected to the supply to avoid condensation forming. The equipment must only be operated within the environmental conditions specified in Chapter 1 'Performance data' in the Operating manual, otherwise the protection provided by the equipment may be impaired.

This product is not approved for use in hazardous atmospheres or medical applications. If the equipment is to be used in a safety-related application, e.g. avionics or military applications, the suitability of the product must be assessed and approved for use by a competent person.

WARNING



Electrical hazards (AC supply voltage)

This equipment conforms with IEC Safety Class I, meaning that it is provided with a protective grounding lead. To maintain this protection the supply lead must always be connected to the source of supply via a socket with a grounded contact.

Be aware that the supply filter contains capacitors that may remain charged after the equipment is disconnected from the supply. Although the stored energy is within the approved safety requirements, a slight shock may be felt if the plug pins are touched immediately after removal.

Do not remove instrument covers as this may result in personal injury. There are no user-serviceable parts inside.

Refer all servicing to qualified personnel. See list of Service Centers at rear of manual.

Fuses

Note that there are supply fuses in both the live and neutral wires of the supply lead. If only one of these fuses should rupture, certain parts of the equipment could remain at supply potential.

For Option 100, single fuse version only:

Fuses

Note that the internal supply fuse is in series with the live conductor of the supply lead. If connection is made to a 2-pin unpolarized supply socket, it is possible for the fuse to become transposed to the neutral conductor, in which case, parts of the equipment could remain at supply potential even after the fuse has ruptured.

WARNING



Fire hazard

Make sure that only fuses of the correct rating and type are used for replacement.

If an integrally fused plug is used on the supply lead, ensure that the fuse rating is commensurate with the current requirements of this equipment. See under 'Performance data' in Chapter 1 for power requirements.

WARNING



Toxic hazards

Some of the components used in this equipment may include resins and other materials which give off toxic fumes if incinerated. Take appropriate precautions, therefore, in the disposal of these items.

WARNING



Beryllia

Beryllia (beryllium oxide) is used in the construction of some of the components in this equipment.

This material, when in the form of fine dust or vapor and inhaled into the lungs, can cause a respiratory disease. In its solid form, as used here, it can be handled quite safely although it is prudent to avoid handling conditions which promote dust formation by surface abrasion.

Because of this hazard, you are advised to be very careful in removing and disposing of these components. Do not put them in the general industrial or domestic waste or dispatch them by post. They should be separately and securely packed and clearly identified to show the nature of the hazard and then disposed of in a safe manner by an authorized toxic waste contractor.

WARNING



Lithium

A Lithium battery (or a Lithium battery contained within an IC) is used in this equipment.

As Lithium is a toxic substance, the battery should in no circumstances be crushed, incinerated or disposed of in normal waste.

Do not attempt to recharge this type of battery. Do not short circuit or force discharge since this might cause the battery to vent, overheat or explode.

WARNING**Heavy equipment**

The weight of this equipment exceeds the 18 kg (40 lb) guideline for manual handling by a single person. To avoid the risk of injury, an assessment should be carried out prior to handling which takes account of the load, workplace environment and individual capability, in accordance with European Directive 90/269/EEC and associated National Regulations.

WARNING**Tilt facility**

When the instrument is in the tilt position, it is advisable, for stability reasons, not to stack other instruments on top of it.

CAUTION**Pulse input**

Before switching the instrument on, ensure that no signal voltage is present on the PULSE INPUT socket.

CAUTION**Static sensitive components**

This equipment contains static sensitive components which may be damaged by handling — refer to the Maintenance Manual for handling precautions.

CAUTION**Suitability for use**

This equipment has been designed and manufactured by Aeroflex to generate low-power RF signals for testing radio communications apparatus.

If the equipment is not used in a manner specified by Aeroflex, the protection provided by the equipment may be impaired.

Aeroflex has no control over the use of this equipment and cannot be held responsible for events arising from its use other than for its intended purpose.

Précautions

WARNING

CAUTION

Note

Les termes suivants ont, dans ce manuel, des significations particulières:

WARNING

contient des informations pour éviter toute blessure au personnel.

CAUTION



contient des informations pour éviter les dommages aux équipements.

Note

contient d'importantes informations d'ordre général.

Symboles signalant un risque

La signification des symboles de danger apparaissant sur l'équipement et dans la documentation est la suivante:

Symbole	Nature du risque
	Reportez-vous au manuel d'utilisation quand ce symbole apparaît sur l'instrument. Familiarisez-vous avec la nature du danger et la conduite à tenir.
	Tension dangereuse
	Danger produits toxiques

Conditions générales d'utilisation

Ce produit a été conçu et testé pour être conforme aux exigences des normes CEI/EN61010-1 "Règles de sécurité pour appareils électriques de mesurage, de régulation et de laboratoire", pour des équipements Classe I, portables et pour une utilisation dans un environnement de pollution de niveau 2. Cet équipement est conçu pour fonctionner à partir d'une alimentation de catégorie I et II.

Cet équipement doit être protégé de l'introduction de liquides ainsi que des précipitations d'eau, de neige, etc... Lorsqu'on transporte cet équipement d'un environnement chaud vers un environnement froid, il est important de laisser l'équipement se stabiliser en température avant de le connecter à une alimentation afin d'éviter toute formation de condensation. L'appareil doit être utilisé uniquement dans le cadre des conditions d'environnement spécifiées dans 'Performance data' dans le chapitre 1 du manuel d'utilisation, toute autre utilisation peut endommager les systèmes de protection.

Ce produit n'est pas garanti pour fonctionner dans des atmosphères dangereuses ou pour un usage médical. Si l'équipement doit être utilisé pour des applications en relation avec la sécurité, par exemple des applications militaires ou aéronautiques, la compatibilité du produit doit être établie et approuvée par une personne compétente.

WARNING



Sécurité électrique (tension d'alimentation alternative)

Cet appareil est protégé conformément à la norme CEI de sécurité Classe 1, c'est-à-dire que sa prise secteur comporte un fil de protection à la terre. Pour maintenir cette protection, le câble d'alimentation doit toujours être branché à la source d'alimentation par l'intermédiaire d'une prise comportant une borne de terre.

Notez que les filtres d'alimentation contiennent des condensateurs qui peuvent encore être chargés lorsque l'appareil est débranché. Bien que l'énergie contenue soit conforme aux exigences de sécurité, il est possible de ressentir un léger choc si l'on touche les bornes sitôt après débranchement.

Ne démontez pas le capot de l'instrument, car ceci peut provoquer des blessures. Il n'y a pas de pièces remplaçables par l'utilisateur à l'intérieur.

Faites effectuer toute réparation par du personnel qualifié. Contacter un des Centres de Maintenance Internationaux dans la liste jointe à la fin du manuel.

Fusibles

Notez qu'il y a deux fusibles, l'un pour la phase et l'autre pour le neutre du câble d'alimentation. Si un seul fusible est coupé, certaines parties de l'appareil peuvent rester au potentiel d'alimentation.

Option fusible simple

Notez que le fusible d'alimentation interne est en série avec la phase du câble d'alimentation. Si la prise d'alimentation comporte deux bornes non polarisées, il est possible de connecter le fusible au neutre. Dans ce cas, certaines parties de l'appareil peuvent rester à un certain potentiel même après coupure du fusible.

WARNING



Risque lie au feu

Lors du remplacement des fusibles vérifiez l'exactitude de leur type et de leur valeur.

Si le câble d'alimentation comporte une prise avec fusible intégré, assurez vous que sa valeur est compatible avec les besoins en courant de l'appareil. Pour la consommation, reportez vous au chapitre 1 'Performance data'.

WARNING



Danger produits toxiques

Certains composants utilisés dans cet appareil peuvent contenir des résines et d'autres matières qui dégagent des fumées toxiques lors de leur incinération. Les précautions d'usages doivent donc être prises lorsqu'on se débarrasse de ce type de composant.

WARNING



Le Beryllia

Le Béryllia (oxyde de Béryllium) entre dans la composition de certains composants de cet appareil.

Cette matière peut, lorsqu'elle est inhalée sous forme de vapeur ou de fine poussière, être la cause de maladies respiratoires. Sous sa forme solide, comme c'est le cas ici, cette matière peut être manipulée sans risque, bien qu'il soit conseillé d'éviter toute manipulation pouvant entraîner la formation de poussière par abrasion de la surface.

Il est donc conseillé, pour éviter ce risque, de prendre les précautions requises pour retirer ces composants et s'en débarrasser. Ne les jetez pas avec les déchets industriels ou domestiques ou ne les envoyez pas par la poste. Il faut les emballer séparément et solidement et bien indiquer la nature du risque avant de les céder, avec précautions, à une entreprise spécialisée dans le traitement de déchets toxiques.

WARNING



Lithium

Une pile au Lithium ou un CI contenant une pile au Lithium est utilisé dans cet équipement.

Le Lithium étant une substance toxique, il ne faut en aucun cas l'écraser, l'incinérer ou le jeter avec des déchets normaux.

N'essayez pas de recharger ce type de pile. Ne court-circuitez pas ou ne forcez pas la décharge de la pile car cela pourrait causer une fuite, une surchauffe ou une explosion.

WARNING**Equipement lourd**

Le poids de cet appareil est supérieur à la limite de 18 kg (40 lb), fixée pour le transport par une seule personne. Afin d'éviter tout risque de blessure, il est nécessaire de faire, avant le transport, une évaluation de la charge, des contraintes de l'environnement et des capacités de l'individu, en conformité avec la Directive Européenne 90/269/EEC ainsi que les recommandations Nationales concernées.

WARNING**Position inclinée**

Lorsque l'appareil est dans une position inclinée, il est recommandé, pour des raisons de stabilité, de ne pas y empiler d'autres appareils.

CAUTION**Utilisation**

Cet équipement a été conçu et fabriqué par Aeroflex pour générer des signaux RF de faible puissance pour le test d'appareils de radio communications.

La protection de l'équipement peut être altérée s'il n'est pas utilisé dans les conditions spécifiées par Aeroflex. Aeroflex n'a aucun contrôle sur l'usage de l'instrument, et ne pourra être tenu pour responsable en cas d'événement survenant suite à une utilisation différente de celle prévue.

Vorsichtsmaßnahmen

WARNING

CAUTION

Note

Diese Hinweise haben eine bestimmte Bedeutung in diesem Handbuch:

WARNING

dienen zur Vermeidung von Verletzungsrisiken.

CAUTION



dienen dem Schutz der Geräte.

Note

enthalten wichtige Informationen.

Gefahrensymbole

Die Bedeutung der Gefahrensymbole auf den Geräten und in der Dokumentation ist wie folgt:

Symbol	Gefahrenart
	Beziehen Sie sich auf die Bedienungsanleitung wenn das Messgerät mit diesem Symbol markiert ist. Machen Sie sich mit der Art der Gefahr und den Aktionen die getroffen werden müssen bekannt.
	Gefährliche Spannung
	Warnung vor giftigen Substanzen

Allgemeine Hinweise zur Verwendung

Dieses Produkt wurde entsprechend den Anforderungen von IEC/EN61010-1 "Sicherheitsanforderungen für elektrische Ausrüstung für Meßaufgaben, Steuerung und Laborbedarf", Klasse I, transportabel zur Verwendung in einer Grad 2 verunreinigten Umgebung, entwickelt und getestet. Dieses Gerät ist für Netzversorgung Klasse I und II zugelassen.

Das Gerät sollte vor dem Eindringen von Flüssigkeiten sowie vor Regen, Schnee etc. geschützt werden. Bei Standortänderung von kalter in wärmere Umgebung sollte das Gerät wegen der Kondensation erst nach Anpassung an die wärmere Umgebung mit dem Netz verbunden werden. Das Gerät darf nur in Umgebungsbedingungen wie im Kapitel 1 'Leistungsdaten (Performance data)' der Bedienungsanleitung beschrieben, betrieben werden; ansonsten wird der vom Gerät vorgesehene Schutz des Anwenders beeinträchtigt.

Dieses Produkt ist nicht für den Einsatz in gefährlicher Umgebung (z.B. Ex-Bereich) und für medizinische Anwendungen geprüft. Sollte das Gerät für den Einsatz in sicherheitsrelevanten Anwendungen wie z.B. im Flugverkehr oder bei militärischen Anwendungen vorgesehen sein, so ist dieser von einer für diesen Bereich zuständigen Person zu beurteilen und genehmigen.

WARNING



Elektrische Schläge (Wechselspannungsversorgung)

Das Gerät entspricht IEC Sicherheitsklasse 1 mit einem Schutzleiter nach Erde. Das Netzkabel muß stets an eine Steckdose mit Erdkontakt angeschlossen werden.

Filterkondensatoren in der internen Spannungsversorgung können auch nach Unterbrechung der Spannungszuführung noch geladen sein. Obwohl die darin gespeicherte Energie innerhalb der Sicherheitsmargen liegt, kann ein leichter Spannungsschlag bei Berührung kurz nach der Unterbrechung erfolgen.

Öffnen Sie niemals das Gehäuse der Geräte das dies zu ernsthaften Verletzungen führen kann. Es gibt keine vom Anwender austauschbare Teile in diesem Gerät.

Lassen Sie alle Reparaturen durch qualifiziertes Personal durchführen. Eine Liste der Servicestellen finden Sie auf der Rückseite des Handbuches.

Sicherungen

Es ist zu beachten, daß es Sicherungen in beiden (spannungsführenden und neutralen) Zuleitungen gibt. Wenn nur eine von diesen Sicherungen schmilzt, so bleiben einige Geräteteile immer noch auf Spannungspotential.

Einsicherungs-Option

Die interne Sicherung in der Spannungszuführung ist in Reihe mit der spannungsführenden Zuleitung geschaltet. Bei Verbindung mit einer zweiadrigen, nicht gepolten Steckdose kann die Sicherung in der Masseleitung liegen, so daß auch bei geschmolzener Sicherung Geräteteile immer noch auf Spannungspotential sind.

WARNING



Feuergefahr

Es dürfen nur Ersatzsicherungen vom gleichen Typ mit den korrekten Spezifikationen entsprechend der Stromaufnahme des Gerätes verwendet werden. Siehe hierzu die Leistungsdaten ('Performance data' in Kapitel 1.

WARNING



Warnung vor giftigen Substanzen

In einigen Bauelementen dieses Geräts können Epoxyharze oder andere Materialien enthalten sein, die im Brandfall giftige Gase erzeugen. Bei der Entsorgung müssen deshalb entsprechende Vorsichtsmaßnahmen getroffen werden.

WARNING



Beryllium Oxid

Beryllium Oxid wird in einigen Bauelementen verwendet.

Als Staub inhaliert kann Beryllium zu Schädigungen der Atemwege führen. In fester Form kann es ohne Gefahr gehandhabt werden, wobei Staubabrieb vermieden werden sollte.

Wegen dieser Gefahren dürfen diese Bauelemente nur mit der entsprechenden Vorsicht ausgebaut und entsorgt werden. Sie dürfen nicht mit Industrie oder Hausmüll vermengt oder per Post versandt werden. Sie müssen separat verpackt und entsprechend der Gefährdung markiert werden. Die Entsorgung muß über einen autorisierten Fachbetrieb erfolgen.

WARNING



Lithium

Eine Lithium Batterie oder eine Lithium Batterie innerhalb eines IC ist in diesem Gerät eingebaut.

Da Lithium ein giftiges Material ist, sollte es als Sondermüll entsorgt werden.

Diese Batterie darf auf keinen Fall geladen werden. Nicht kurzschließen, da sie dabei überhitzt werden und explodieren kann.

WARNING



Schweres Gerät

Das Gewicht dieses Geräts liegt über der 18 kg (40 lb) Grenze für Transport durch eine einzelne Person. Zur Vermeidung von Verletzungen sollten vor einem Transport die Arbeitsumgebung und die persönlichen Möglichkeiten im Verhältnis zur Last abgewogen werden, wie in der EU-Regelung 90/269/EEC und nationalen Normen beschrieben.

WARNING**Schrägstellung**

Bei Schrägstellung des Geräts sollten aus Stabilitätsgründen keine anderen Geräte darauf gestellt werden.

CAUTION**Eignung für Gebrauch**

Dieses Gerät wurde von Aeroflex entwickelt und hergestellt um HF Signale geringer Leistung zum Test von Kommunikationseinrichtungen zu erzeugen.

Sollte das Gerät nicht auf die von Aeroflex vorgesehene Art und Weise verwendet werden, kann die Schutzfunktion des Gerätes beeinträchtigt werden.

Aeroflex hat keinen Einfluß auf die Art der Verwendung und übernimmt keinerlei Verantwortung bei unsachgemässer Handhabung.

Precauzioni

WARNING

CAUTION

Note

Questi termini vengono utilizzati in questo manuale con significati specifici:

WARNING

riportano informazioni atte ad evitare possibili pericoli alla persona.

CAUTION



riportano informazioni per evitare possibili pericoli all'apparecchiatura.

Note

riportano importanti informazioni di carattere generale.

Simboli di pericolo

Il significato del simbolo di pericolo riportato sugli strumenti e nella documentazione è il seguente:

Simbolo	Tipo di pericolo
	Fare riferimento al manuale operativo quando questo simbolo è riportato sullo strumento. Rendervi conto della natura del pericolo e delle precauzioni che dovrete prendere.
	Tensione pericolosa
	Pericolo sostanze tossiche

Condizioni generali d'uso

Questo prodotto è stato progettato e collaudato per rispondere ai requisiti della direttiva IEC/EN61010-1 'Safety requirements for electrical equipment for measurement, control and laboratory use' per apparati di classe I, trasportabili e per l'uso in un ambiente inquinato di grado 2. L'apparato è stato progettato per essere alimentato da un alimentatore di categoria I e II.

Lo strumento deve essere protetto dal possibile ingresso di liquidi quali, ad es., acqua, pioggia, neve, ecc. Qualora lo strumento venga portato da un ambiente freddo ad uno caldo, è importante lasciare che la temperatura all'interno dello strumento si stabilizzi prima di alimentarlo per evitare formazione di condense. Lo strumento deve essere utilizzato esclusivamente nelle condizioni ambientali descritte nel capitolo 1 'Performance data' del manuale operativo, in caso contrario le protezioni previste nello strumento potrebbero risultare non sufficienti.

Questo prodotto non è stato approvato per essere usato in ambienti pericolosi o applicazioni medicali. Se lo strumento deve essere usato per applicazioni particolari collegate alla sicurezza (per esempio applicazioni militari o avioniche), occorre che una persona o un istituto competente ne certifichi l'uso.

WARNING



Pericoli da elettricità (alimentazione c.a.)

Quest'apparato è provvisto del collegamento di protezione di terra e rispetta le norme di sicurezza IEC, classe 1. Per mantenere questa protezione è necessario che il cavo, la spina e la presa d'alimentazione siano tutti provvisti di terra.

Il circuito d'alimentazione contiene dei filtri i cui condensatori possono restare carichi anche dopo aver rimosso l'alimentazione. Sebbene l'energia immagazzinata è entro i limiti di sicurezza, purtroppo una leggera scossa può essere avvertita toccando i capi della spina subito dopo averla rimossa.

Non rimuovete mai le coperture perché così potreste provocare danni a voi stessi. Non vi sono all'interno parti di interesse all'utilizzatore.

Tutte gli interventi sono di competenza del personale qualificato. Vedi elenco internazionale dei Centri di Assistenza in fondo al manuale.

Fusibili

Notare che entrambi i capi del cavo d'alimentazione sono provvisti di fusibili. In caso di rottura di uno solo dei due fusibili, alcune parti dello strumento potrebbero restare sotto tensione.

Opzione singolo fusibile

Notare che un fusibile è posto sul filo caldo del cavo di alimentazione. Qualora l'alimentazione avvenga tramite due poli non polarizzati, è possibile che il fusibile vada a protezione del neutro per cui anche in caso di una sua rottura, l'apparato potrebbe restare sotto tensione.

WARNING



Pericolo d'incendio

Assicurarsi che, in caso di sostituzione, vengano utilizzati solo fusibili della portata e del tipo prescritti.

Se viene usata una spina con fusibili, assicurarsi che questi siano di portata adeguata ai requisiti di alimentazione richiesti dallo strumento. Tali requisiti sono riportati nel capitolo 1 'Performance data'.

WARNING



Pericolo sostanze tossiche

Alcuni dei componenti usati in questo strumento possono contenere resine o altri materiali che, se bruciati, possono emettere fumi tossici. Prendere quindi le opportune precauzioni nell'uso di tali parti.

WARNING



Berillio

Berillio (ossido di berillio) è utilizzato nella costruzione di alcuni componenti di quest'apparato.

Questo materiale, se inalato sotto forma di polvere fine o vapore, può causare malattie respiratorie. Allo stato solido, come è usato qui, può essere maneggiato con sufficiente sicurezza anche se è prudente evitare condizioni che provochino la formazione di polveri tramite abrasioni superficiali.

A cause di questi pericoli occorre essere molto prudenti nella rimozione e nella locazione di questi componenti. Questi non devono essere gettati tra i rifiuti domestici o industriali né vanno spediti per posta. Essi devono essere impacchettati separatamente ed in modo sicuro e devono indicare chiaramente la natura del pericolo e quindi affidate a personale autorizzato.

WARNING



Litio

Quest'apparato incorpora una batteria al litio o un circuito integrato contenente una batteria al litio.

Poiché il litio è una sostanza tossica, la batteria non deve essere mai né rotta, né incenerita, né gettata tra i normali rifiuti.

Questo tipo di batteria non può essere sottoposto né a ricarica né a corto-circuito o scarica forzata. Queste azioni possono provocare surriscaldamento, fuoriuscita di gas o esplosione della batteria.

WARNING**Instrumento pesado**

El peso de este equipo excede de los 18 kg (40 lb), lo que debe tenerse en cuenta si va ser transportado manualmente por una sola persona. Para evitar el riesgo de lesiones, antes de mover el equipo deberá evaluar la carga, el entorno de trabajo y la propia capacidad, de acuerdo con la Directiva Europea 90/269/EEC y el Reglamento Nacional Asociado.

WARNING**Posizionamento inclinato**

Quando lo strumento è in posizione inclinata è raccomandato, per motivi di stabilità, non sovrapporre altri strumenti.

CAUTION**Caratteristiche d'uso**

Questo strumento è stato progettato e prodotto da Aeroflex generare segnali RF in bassa potenza per provare apparati di radio comunicazione.

Se lo strumento non è utilizzato nel modo specificato da Aeroflex, le protezioni previste sullo strumento potrebbero risultare inefficaci.

Aeroflex non può avere il controllo sull'uso di questo strumento e non può essere ritenuta responsabile per eventi risultanti da un uso diverso dallo scopo prefisso.

Precauciones

WARNING

CAUTION

Note

Estos términos tienen significados específicos en este manual:

WARNING

contienen información referente a prevención de daños personales.

CAUTION



contienen información referente a prevención de daños en equipos.

Note

contienen información general importante.

Símbolos de peligro

El significado de los símbolos de peligro en el equipo y en la documentación es el siguiente:

Símbolo	Naturaleza del peligro
	Vea el manual de funcionamiento cuando este símbolo aparezca en el instrumento. Familiarícese con la naturaleza del riesgo y con las acciones que deban de tomarse.
	Voltaje peligroso
	Aviso de toxicidad

Condiciones generales de uso

Este producto ha sido diseñado y probado para cumplir los requerimientos de la normativa IEC/EN61010-1 “Requerimientos de la normativa para equipos eléctricos de medida, control y uso en laboratorio”, para equipos clase I, portátiles y para uso en un ambiente con un grado de contaminación 2. El equipo ha sido diseñado para funcionar sobre una instalación de alimentación de categorías I y II.

Debe protegerse el equipo de la entrada de líquidos y precipitaciones como nieve, lluvia, etc. Cuando se traslada el equipo de entorno frío a un entorno caliente, es importante aguardar la estabilización del equipo para evitar la condensación. Solamente debe utilizarse el equipo bajo las condiciones ambientales especificadas en el Capítulo 1 ‘Especificaciones’ o ‘Performance data’ del Manual de Operación, en caso contrario la propia protección del equipo puede resultar dañada.

Este producto no ha sido aprobado para su utilización en entornos peligrosos o en aplicaciones médicas. Si se va a utilizar el equipo en una aplicación con implicaciones en cuanto a seguridad, como por ejemplo aplicaciones de aviónica o militares, es preciso que un experto competente en materia de seguridad apruebe su uso.

WARNING



Nivel peligroso de electricidad (tensión de red)

Este equipo cumple las normas IEC Seguridad Clase 1, lo que significa que va provisto de un cable de protección de masa. Para mantener esta protección, el cable de alimentación de red debe de conectarse siempre a una clavija con terminal de masa.

Tenga en cuenta que el filtro de red contiene condensadores que pueden almacenar carga una vez desconectado el equipo. Aunque la energía almacenada está dentro de los requisitos de seguridad, pudiera sentirse una ligera descarga al tocar la clavija de alimentación inmediatamente después de su desconexión de red.

No retire las cubiertas del chasis del instrumento, ya que pudiera resultar dañado personalmente. No existen partes que puedan ser reparadas en su interior.

Deje todas las tareas relativas a reparación a un servicio técnico cualificado. Vea la lista de Centros de Servicios Internacionales en la parte trasera del manual.

Fusibles

Se hace notar que el Equipo está dotado de fusibles tanto en el activo como el neutro de alimentación. Si sólo uno de estos fusibles fundiera, existen partes del equipo que pudieran permanecer a tensión de red.

Opción fusible único

Se hace notar que el fusible de alimentación interno está en serie con el activo del cable de alimentación a red. Si la clavija de alimentación de red cuenta con sólo dos terminales sin polaridad, el fusible puede pasar a estar en serie con el neutro, en cuyo caso existen partes del equipo que permanecerían a tensión de red incluso después de que el fusible haya fundido.

WARNING



Peligro de incendio

Asegúrese de utilizar sólo fusibles del tipo y valores especificados como recuento.

Si se utiliza una clavija con fusible incorporado, asegúrese de que los valores del fusible corresponden a los requeridos por el equipo. Ver sección de especificaciones del capítulo 1 del Manual de Operación para comprobar los requisitos de alimentación.

WARNING



Aviso de toxicidad

Alguno de los componentes utilizados en este equipo pudieran incluir resinas u otro tipo de materiales que al arder produjeran sustancias tóxicas, Por tanto, tome las debidas precauciones en la manipulación de esas piezas.

WARNING



Berilio

Berilio (óxido de berilio) Este material es utilizado en la fabricación de alguno de los componentes de este equipo.

La inhalación de este material, en forma de polvo fino o vapor, entrando en los pulmones, puede ser causa de enfermedades respiratorias. En forma sólida, como se utiliza en este caso, puede manipularse con bastante seguridad, aunque se recomienda no manejarlo en aquellas condiciones que pudieran favorecer la aparición de polvo por abrasión de la superficie.

Por todo lo anterior, se recomienda tener el máximo cuidado al reemplazar o deshacerse de estos componentes, no tirándolos en basuras industriales o domésticas y no utilizar el correo para su envío. Deben, ser empaquetados de forma segura y separada, y el paquete debidamente etiquetado e identificado, señalando claramente la naturaleza del riesgo y ponerlo a disposición de un destructor autorizado de productos tóxicos.

WARNING



Litio

En este equipo se utiliza una batería de litio (o contenida dentro de un CI).

Dada que el litio es una sustancia tóxica las baterías de este material no deben ser aplastadas, quemadas o arrojadas junto a basuras ordinarias.

No trate de recargar este tipo de baterías. No las cortocircuite o fuerce su descarga ya que puede dar lugar a que la esta emita gases, se recaliente o explote.

WARNING**Instrumento pesado**

El peso de este equipo excede de los 18 kg (40 lb), lo que debe tenerse en cuenta si va ser transportado manualmente por una sola persona. Para evitar el riesgo de lesiones, antes de mover el equipo deberá evaluar la carga, el entorno de trabajo y la propia capacidad, de acuerdo con la Directiva Europea 90/269/EEC y el Reglamento Nacional Asociado.

WARNING**Tener en cuenta con el equipo inclinado**

Si utiliza el equipo en posición inclinada, se recomienda, por razones de estabilidad, no apilar otros equipos encima de él.

CAUTION**Idoneidad de uso**

Este equipo ha sido diseñado y fabricado por Aeroflex para generar señales de VHF y UHF de bajo nivel de potencia para prueba de equipos de radiocomunicaciones.

Si el equipo fuese utilizado de forma diferente a la especificada por Aeroflex, la protección ofrecida por el equipo pudiera quedar reducida.

Aeroflex no tiene control sobre el uso de este equipo y no puede, por tanto, exigirsele responsabilidades derivadas de una utilización distinta de aquellas para las que ha sido diseñado.

Chapter 1

GENERAL INFORMATION

CONTENTS

	PAGE
INTRODUCTION	1-2
MAIN FEATURES.....	1-2
Operation.....	1-2
Display	1-2
Frequency selection	1-2
Output	1-3
Modulation.....	1-3
Incrementing	1-3
Sweep.....	1-3
Non-volatile memory	1-4
Programming.....	1-4
Software protection.....	1-4
Spectral purity.....	1-4
Calibration	1-4
Options.....	1-4
PERFORMANCE DATA	1-7
VERSIONS, OPTIONS AND ACCESSORIES.....	1-16

LIST OF FIGURES

Fig. 1-1 Typical phase noise performance of 2030 Series.....	1-6
--	-----

INTRODUCTION

The 2030 series Signal Generators cover the frequency ranges 10 kHz to 5.4 GHz with three models: 2030 (10 kHz to 1.35 GHz), 2031 (10 kHz to 2.7 GHz) and 2032 (10 kHz to 5.4 GHz). A dot matrix display with soft key selected screen options allow flexibility of operation and ease of use. The output may be amplitude, phase, or frequency modulated with pulse modulation available as an option. Modulation is available using a combination of up to two external signal inputs and a built-in LF source.

Available options include a second build-in modulation source; avionics modulation (ILS and VOR); pulse modulation; RF level profiling and complex sweep; electronic attenuator.

Microprocessor control ensures that the instruments are flexible and easy to use and allows programming by the General Purpose Interface Bus (GPIB). The GPIB is designed to IEEE Standard 488.2 and is a means of sending commands to an instrument, via a data bus, from a remote controller or personal computer. The instruments can therefore be used manually or as part of a fully automated test system.

MAIN FEATURES

Operation

Selection of parameters on the screen may involve one or more of the numeric, hard or soft keys or the rotary knob. Hard keys have single or dual functions which remain constant throughout, whereas soft keys have functions dependent on the present mode of operation. Parameters may be set to specific values by numeric key entry, while values may be varied in steps of any size using the \uparrow/\downarrow keys or altered by moving the knob, set to a particular sensitivity.

The SIG GEN, LF, SWEEP, MEM (memory), Δ (delta) and UTIL (utility) menus are selectable, at any point of operation, via the keys below the display panel. Within the display, the soft key functions are indicated by labels which appear alongside the keys situated at either side of the display panel.

Display

The display is a dot matrix liquid crystal panel, with backlighting. Carrier frequency, modulation and RF level are shown in horizontal regions on the principal screen. The display features 11-digit resolution for carrier frequency, 4-digit for RF level and 3-digit for modulation, with unit annunciators.

Contrast may be varied, using the control knob, to optimize the viewing angle. Differing lighting conditions may be accommodated using the backlight intensity function, variable from no backlight to full intensity. A full graphical display test is available, refer to the Service Manual.

Frequency selection

Carrier frequency is selected via the soft key option on the SIG GEN display and direct entry via the keyboard. Alternatively, selection may be made via the General Purpose Interface Bus (GPIB). Frequency resolution is 0.1 Hz across the band. Carrier frequencies can be stored in a non-volatile memory with complete recall when required. An ON-OFF key is provided to completely disable the output.

Output

RF output up to +13 dBm can be set by direct keyboard entry with a resolution of 0.1 dB or better over the entire range. A high output option is available to extend the maximum calibrated level to +19 dBm on the 2030 instrument.

An extended hysteresis facility allows for extended electronic control of RF output level without introducing mechanical attenuator transients when testing squelch systems.

A low intermodulation mode can be selected which disables the RF levelling system and improves the intermodulation performance when combining the outputs of two signal generators.

A choice of calibration units is available to the operator and provision is made for the simple conversion of units (for example, dBm to μ V). Calibration data for the output level is held in memory and may be altered from the front panel or over the interface bus.

The output level can be offset by up to ± 2 dB by keyboard entry. Offsets from the calibrated value may be used to compensate for cable or switching losses external to the generator. This facility can be used as a means of deliberately offsetting the output level to ensure that all generators in an area give identical measurements. While using the offsetting facility, the principal calibration of the generator is not lost and may be returned to at any time.

An electronic trip protects the generator output against reverse power of up to 50 W, preventing damage to output circuits when RF or DC power is accidentally applied.

Modulation

Comprehensive amplitude, frequency (plus wide bandwidth FM), phase and optional pulse modulation are provided for testing a wide range of receivers. An internal modulation oscillator is provided, having a frequency range of 0.1 Hz to 500 kHz, with a resolution of 0.1 Hz. A second modulation oscillator can be included as an option. Two independent BNC inputs on the front panel allow external modulation signals to be mixed with the internal signal(s). Therefore, a maximum of four modulation sources may be available at one time. These sources may be combined to give the single, dual, composite and dual composite modes.

The signalling facility allows testing of radio equipment with sequential and sub-audible tone capability. The sequential calling tone system is accessible from the utility menu for all four modulation modes. Sub-audible calling tones are specified within the modulation source select display.

Incrementing

All major parameters can be incremented or decremented in step sizes entered via keyboard entry or the GPIB. If no step size is entered for a parameter, the steps are preset to 1 kHz for carrier frequency, 1 kHz for modulation oscillator and LF frequency, 1 kHz for FM deviation, 1% for AM depth and 1 dB for output level.

In addition the rotary control can be used to vary the parameter with the sensitivity of the knob being changed by means of the $\times 10$ and $\div 10$ keys.

Sweep

The sweep capability of the 2030 Series allows comprehensive testing of systems. Four parameters are used to specify sweep; start, stop, number of steps and time per step. These are specified by the user, with upper and lower limits for the parameter values being dependent on the function. The sweep markers menu is available by soft key selection on the sweep display, allowing the placement of up to five user defined markers.

Non-volatile memory

The non-volatile memory allows 50 complete instrument settings, 50 partial settings, 100 carrier frequency settings, 20 sweep settings and 20 signalling tone sequences to be stored for later use at any time.

Programming

A GPIB interface is fitted so that all functions are controllable via the interface bus which is designed to the IEEE Standard 488.2. The instrument can function both as a talker and a listener.

Software protection

To prevent accidental interference with the contents of internal memories, internal data is protected by a secure key sequence.

Two levels of protection are offered, appropriate to the function being accessed. The most secure is reserved for features which alter the calibration data of the instrument.

Spectral purity

With an SSB phase noise performance of typically -122 dBc/Hz at 470 MHz (20 kHz offset), the 2030 Series can be used for both in-channel and adjacent channel receiver measurements. Harmonically related signals and non-harmonics are better than -30 dBc and -70 dBc respectively.

Calibration

The 2030 Series has a recommended two year calibration interval and is calibrated entirely by electronically controlled adjustment. There are no internal mechanically adjustable components to affect the calibration. The calibration display is available via soft key selection at the utilities menu.

Date stamping

After readjustment the instrument updates the calibration data and records the date of adjustment. The calibration due date can be set and when this date is reached a message advises the operator to return the unit for calibration.

Options

The following factory-fitted options are available:

Option 001 - Second modulation oscillator

An additional modulation oscillator is available to enable greater flexibility. This second oscillator has the same specification as the first and allows full use of complex modulation modes.

Option 002 - Pulse modulation

The pulse modulation facility allows radar RF and IF stages to be tested and features rise and fall times of less than 15 ns with an on/off ratio of better than 70 dB.

Option 003 - High output power

This option extends the output level to +19 dBm on the 2030 model.

Option 005 - GMSK Bt 0.3

Provides GMSK Bt 0.3 modulation at a clock rate of 270.833 kHz in accordance with the GSM and DCS 1800 specifications. The option includes a comprehensive internal data generator.

Option 006 - Avionics

Provides internally generated modulation waveforms suitable for the testing of Instrument Landing Systems (ILS) and VHF Omni Range (VOR) beacons.

Option 008 - RF profiles and complex sweep

The RF profile facility provides compensation for frequency dependent level errors introduced by cables, amplifiers and signal combiners. The complex sweep facility generates sweeps whose step size, step time and RF level change while the sweep is in progress. These features are particularly useful for EMC, Tempest and ATE applications.

Option 009 - Pulse generator

Provides an internal generator with the ability to produce single and double pulses. Panel connectors provide external trigger input and synchronisation and video outputs. Option 009 does not require the fitting of any other option, but it is designed to drive and be fully compatible with Option 002 (Pulse Modulation).

Option 010 - DME modulator

DME (Distance Measuring Equipment) provides aircraft with accurate and continuous information of slant range distance from a reference ground point. This option provides an internal generator with the ability to produce gaussian shaped double pulses, and a linear RF modulator which produces a similar gaussian shaped RF spectrum. Panel connectors provide an external trigger input and synchronisation and video outputs. Option 010 requires Option 001 (Second Modulation Oscillator) and Option 006 (Avionics) to be fitted.

Option 012 - Electronic attenuator

Designed to meet demanding extended life requirements for repetitive switching, such as are found in high volume production applications.

Option 100 - Single fuse

A single fuse is used in place of the standard double fuse.

Option 105 - Modified pulse modulator

Modifies the pulse modulator (Option 002) to provide a slower rise and fall time for testing time domain duplex and time domain multiple access receivers.

Option 112 - EXT MOD 2 input 600 Ω

The EXT MOD 2 INPUT socket has a 600 Ω input impedance in place of 100 k Ω .

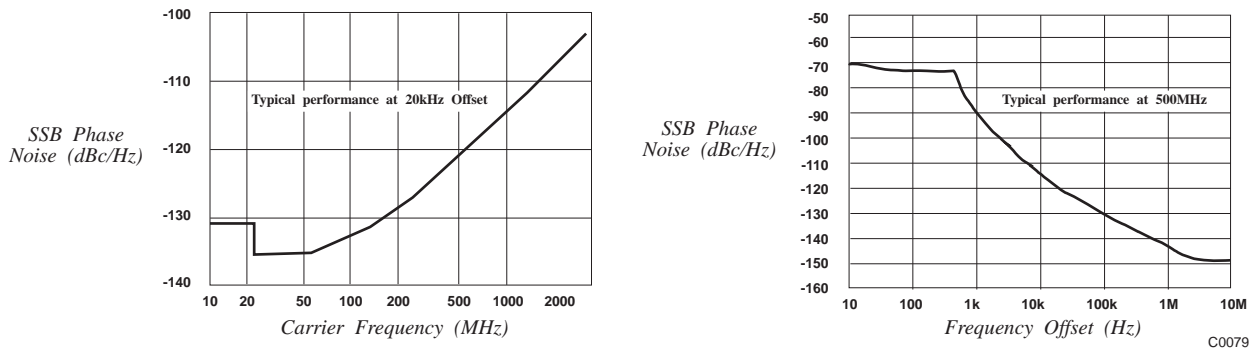

Fig. 1-1 Typical phase noise performance of 2030 Series

PERFORMANCE DATA

CARRIER FREQUENCY

Range	10 kHz to 1.35 GHz (2030); 10 kHz to 2.7 GHz (2031); 10 kHz to 5.4 GHz (2032).
Selection	By keyboard entry of data. Variation by \uparrow/\downarrow keys and by rotary control.
Indication	11 digits with annunciators.
Resolution	0.1 Hz.
Accuracy	As frequency standard.
Phase incrementing	The carrier phase can be advanced or retarded in steps of 1.5° using the rotary control.

RF OUTPUT

Range	-144 dBm to +13 dBm (2030, 2031); -144 dBm to +19 dBm (2030 with Option 003); -144 dBm to +13 dBm (2032), derated over 4 GHz by 0.1 dB/ $^\circ$ C above 40 $^\circ$ C. When AM is selected the maximum output level reduces linearly with AM depth to +7 dBm (+13 dBm for 2030 with Option 003) at maximum AM depth.
Overrange	Adjustable up to typically +19 dBm (typically +25 dBm for 2030 with Option 003).
Selection	By keyboard entry of data. Variation by \uparrow/\downarrow keys and by rotary control. Units may be μ V, mV, V EMF or PD; dB relative to 1 μ V, 1 mV EMF or PD; dBm. Conversion between dB and voltage units may be achieved by pressing the appropriate units key (dB, or V, mV, μ V).
Indication	4 digits with unit annunciators.
Resolution	0.1 dB.

GENERAL INFORMATION

Accuracy

At 22 ±5 °C ambient:

Output level	Carrier frequency range		
	10 kHz to 1.35 GHz	1.35 GHz to 2.7 GHz	2.7 GHz to 5.4 GHz
> -127 dBm	±0.85 dB	±1.0 dB	-
> -100 dBm	±0.85 dB	±1.0 dB	±1.5 dB
> 0 dBm	±0.50 dB	±0.7 dB	±1.0 dB
Temperature stability (dB/°C)	±0.005	±0.01	±0.02

2030 with Option 003: ±1.2 dB for output levels greater than -127 dBm.

VSWR

For output levels less than 0 dBm:
 Less than 1.25:1 to 2.2 GHz (return loss greater than 19.1 dB);
 Less than 1.4:1 to 2.7 GHz (return loss greater than 15.6 dB);
 Less than 1.5: 1 to 5.4 GHz (return loss greater than 14 dB).

Output protection

An electronic trip protects the generator output against reverse power of up to 50 W from a source VSWR of up to 5:1.

Output connector

50 Ω nominal, N-type female socket.

SPECTRAL PURITY

At RF levels up to +7 dBm :

Harmonics	2030, 2031: Better than -30 dBc for carrier frequencies to 1 GHz; Better than -27 dBc for carrier frequencies above 1 GHz. 2032: Better than -30 dBc for carrier frequencies to 1 GHz. Better than -27 dBc for carrier frequencies to 1.35 GHz. Better than -25 dBc for carrier frequencies above 1.35 GHz.
Sub-harmonics	Better than -90 dBc to 1.35 GHz. Better than -40 dBc to 2.3 GHz. Better than -30 dBc to 5.4 GHz.
Non-harmonics	Better than -70 dBc at offsets from the carrier frequency of 3 kHz or greater.
Residual FM (FM off)	Less than 7 Hz RMS deviation in a 300 Hz to 3.4 kHz unweighted bandwidth at 470 MHz.
SSB phase noise	Less than -116 dBc/Hz (typically -122 dBc/Hz) at an offset of 20 kHz from a carrier frequency of 470 MHz.
RF leakage	Less than 0.5 μ V PD generated at the carrier frequency across a 50 Ω load by a two turn 25 mm loop, 25 mm or more from any part of the case.
FM on AM	Typically less than 100 Hz for 30% AM depth at a modulation frequency of 1 kHz and a carrier frequency of 500 MHz.
Φ M on AM	Typically less than 0.1 radian at a carrier frequency of 500 MHz for 30% AM depth for modulation rates up to 10 kHz.

MODULATION MODES

	Four modulation modes are available:
Single	FM, Wideband FM, Φ M, AM or pulse (optional).
Dual	Two independent channels of differing modulation type (e.g. AM with FM).
Composite	Two independent channels of the same modulation type. (e.g. FM1 with FM2).
Dual composite	A combination of Dual and Composite modes providing four independent channels (e.g. AM1 with AM2 and FM1 with FM2). Phase modulation can be used instead of FM (but not simultaneously).

FREQUENCY MODULATION

Deviation	Peak deviation from 0 to 1 MHz for carrier frequencies up to 21.09375 MHz; Peak deviation from 0 to 1% of carrier frequency above 21.09375 MHz.
Selection	By keyboard entry of data. Variation by \uparrow/\downarrow keys and by rotary control.
Indication	3 digits with annunciators.
Displayed resolution	1 Hz or 1 least significant digit, whichever is greater.
Accuracy at 1 kHz	$\pm 5\%$ of indication ± 10 Hz excluding residual FM.
1 dB bandwidth	DC to 300 kHz (DC coupled). 10 Hz to 300 kHz (AC coupled).
Carrier frequency offset	In DC FM mode less than $\pm(1 \text{ Hz} + 0.1\%$ of set deviation) after using DC FM nulling facility.
Distortion	Using external modulation without ALC: Less than 3% at maximum deviation for modulation frequencies up to 20 kHz; Less than 0.3% at 10% of maximum deviation for modulation frequencies up to 20 kHz.
Modulation source	Internal LF generator or external via front panel sockets.
Group delay	Less than 1 μs , 3 kHz to 500 kHz.

WIDEBAND FM

Deviation	As FM.
Indication	3 digits with annunciators.
Selection	By keyboard entry of data. The sensitivity is controlled in 3 dB steps and the display will indicate the value of deviation nearest to the requested value.
Input level	1.414 V peak (1 V RMS sine wave) to achieve indicated deviation.
Accuracy	As FM.
3 dB bandwidth	Typically 10 MHz (DC or AC coupled).
Modulation source	External via rear panel socket (50 Ω impedance).
Group delay	Less than 0.5 μs , 3 kHz to 10 MHz.

PHASE MODULATION

Deviation	0 to 10 radians.
Selection	By keyboard entry of data. Variation by \uparrow/\downarrow keys and by rotary control.
Indication	3 digits with annunciators.
Accuracy at 1 kHz	Better than $\pm 5\%$ of indicated deviation excluding residual phase modulation.
3 dB bandwidth	100 Hz to 10 kHz.
Distortion	Less than 3% at maximum deviation at 1 kHz modulation rate.
Modulation source	Internal LF generator or external via front panel sockets.

AMPLITUDE MODULATION

For carrier frequencies up to 1 GHz (and for output levels less than +13 dBm with Option 003):

Range	0 to 99.9%.
Selection	By keyboard entry of data. Variation by \uparrow/\downarrow keys and by rotary control.
Indication	3 digits with annunciator.
Resolution	0.1%.
Depth accuracy at 1 kHz	$\pm 4\%$ of setting $\pm 1\%$.
Distortion	For a modulation rate of 1 kHz: Less than 1% total harmonic distortion for AM depths up to 30% Less than 3% total harmonic distortion for AM depths up to 80%.
Modulation source	Internal LF generator or external via front panel sockets.

MODULATION OSCILLATOR

Frequency range	0.1 Hz to 500 kHz.
Selection	By keyboard entry of data. Variation by \uparrow/\downarrow keys and by rotary control.
Indication	7 digits with annunciators.
Resolution	0.1 Hz.
Frequency accuracy	As frequency standard.
Distortion	Less than 0.1% THD in sine wave mode at frequencies up to 20 kHz.
Alternative waveforms	A triangular wave is available for frequencies up to 100 kHz. A square wave is available for frequencies up to 2 kHz.
Signalling tones	The modulation oscillator can be used to generate sequential (up to 16 tones) or sub-audible signalling tones in accordance with EIA, ZVEI, DZVEI, CCIR, EURO1, EEA, NATEL and DTMF* standards. Facilities are also available for creating and storing user defined tone systems. *Requires second modulation oscillator (Option 001) to be fitted.

EXTERNAL MODULATION

Two independent inputs on the front panel with BNC connectors, EXT MOD 1 and EXT MOD 2. The modulation is calibrated with 1.4.4 V peak (1 V RMS) sine wave applied. Input impedance 100 k Ω nominal (600 Ω at EXT MOD 2 with Option 112).

MODULATION ALC

The EXT MOD 1 and EXT MOD 2 modulation inputs can be levelled by an ALC system.

Level range	1 V to 2 V peak (0.7 V RMS to 1.4 V RMS) sine wave.
Distortion	Less than 0.1% additional distortion for frequencies up to 20 kHz (typically less than 0.1% up to 50 kHz).
1 dB bandwidth	Typically 10 Hz to 500 kHz.

LF OUTPUT

	Front panel BNC connector. The output may be configured in either LF Generator Mode to give an output from the internal modulation oscillator or in LF Monitor Mode to give an output from the internal modulation signal paths.
Selection	By keyboard entry of data. Variation by \uparrow/\downarrow keys and by rotary control.
Indication	7 digits with unit annunciators for frequency and 4 digits with unit annunciators for level.
Level	100 μ V to 5 V RMS with a load impedance of greater than 600 Ω . 100 μ V to 1.4 V RMS with a load impedance of greater than 50 Ω .
Common mode voltage	± 0.5 V maximum.
Source impedance	5.6 Ω nominal.
Level accuracy at 1 kHz	With a load impedance of greater than 10 k Ω : $\pm 5\%$ for levels above 50 mV and $\pm 10\%$ for levels from 500 μ V to 50 mV.
Frequency response	Typically better than ± 1 dB from 0.1 Hz to 300 kHz.

SWEEP

Control modes	Start/stop values of selected parameter; Number of steps; Time per step.
Step time	1 ms to 10 s per step.
Sweep ramp	Synchronized analogue ramp with an amplitude of nominally 0 V to 10 V peak on rear panel BNC connector.
Markers	5 user selectable markers for frequency or level provide an indication when specified parameter values have been reached. Output 0 V to +5 V nominal from 600 Ω on rear panel BNC socket.
Trigger	Rear panel BNC connector. Applying 0 V or a switch closure starts the sweep or steps the sweep from point to point. Socket is internally connected via 10 k Ω pull-up resistor to +5 V.

FREQUENCY STANDARD

Frequency	10 MHz.
Temperature stability	Better than ± 5 in 10^8 over the operating range of 0 to 50°C.
Warm-up time	Within 2 in 10^7 of final frequency within 10 minutes from switch on at 20°C .
Aging rate	Better than 2 in 10^7 per year.
Output	Rear panel BNC socket provides an output at frequencies of 1, 5 or 10 MHz with a nominal 2 V pk-pk level into 50 Ω . This output can be disabled.
External input	Rear panel BNC socket accepts an input of 220 mV to 1.8 V RMS into 1 k Ω at a frequency of 1, 5 or 10 MHz.

SECOND MODULATION OSCILLATOR OPTION Specification as Modulation Oscillator.

EXT MOD 2 INPUT 600 Ω OPTION The EXT MOD 2 INPUT socket has a 600 Ω input impedance in place of 100 kΩ.

PULSE MODULATION (OPTION 002 and 105)

Modulation modes	Pulse modulation may be used alone or in conjunction with FM, ΦM or Wideband FM.
Rise time	25 ns (typically 5 ns). Typically 2 μs with Option 105 (DECT).
Control	0 V for carrier off, +5 V for carrier on. Threshold level typically +2.5 V.
ON/OFF ratio	Better than 70 dB.
Input impedance	50 Ω nominal.

+19 dBm RF OUTPUT LEVEL OPTION

For 2030 model only.

RF OUTPUT

Range	-138 dBm to +19 dBm. When AM is selected the maximum output level reduces linearly with AM depth to +13 dBm at maximum AM depth.
-------	---

SPECTRAL PURITY
At RF levels up to +7 dBm:

Harmonics	Better than -27 dBc.
-----------	----------------------

ELECTRONIC ATTENUATOR OPTION

Carrier frequency range	250 kHz* to 1.35 GHz (2030), 250 kHz* to 2.7 GHz (2031). *Usable to 10 kHz.
RF output range	-144 dBm to +10 dBm. When AM is selected the maximum output level reduces linearly with AM depth to +4 dBm at maximum AM depth.
Accuracy	±1.2 dB for output levels >-127 dBm at 22°C ±5°C.
Temperature stability	±0.01 dB/°C.
VSWR	<1.5:1 for output levels less than 0 dBm.
Reverse power handling	1 W from a source VSWR of up to 5:1.
Amplitude modulation	Standard specification applies for carrier frequencies above 50 MHz (above 100 MHz for Option 6).

GMSK OPTION See Annex A.

AVIONICS OPTION See Annex B.

**RF PROFILES AND
COMPLEX SWEEP
OPTION** See Annex C.

PULSE GENERATOR See Annex D.

DME MODULATOR See Annex E.

VERSIONS, OPTIONS AND ACCESSORIES

When ordering please quote the full ordering number information.

Ordering numbers

2030	10 kHz to 1.35 GHz Signal Generator.
2031	10 kHz to 2.7 GHz Signal Generator.
2032	10 kHz to 5.4 GHz Signal Generator.

Versions

Options

Options are factory fitted only and must be specified at the time of ordering.

Option 001	Second internal modulation oscillator.
Option 002	Pulse modulation.
Option 003	+19 dBm output level (2030 only).
Option 005	GSM/PCN/PCS (GMSK Bt 0.3 modulation).
Option 006	Avionics (requires Option 001, cannot be used with Option 003).
Option 008	RF profiles and complex sweep.
Option 009	Internal pulse generator (needs Option 002).
Option 010	DME (requires Options 001 and 006; cannot be used with Options 003 or 005).
Option 012	Electronic attenuator (2030 and 2031 only). Not available with Options 003 or 010.
Option 105	Modifies the pulse modulation option for slower rise and fall time (order with Option 002).
Option 112	External modulation inputs (2) 600 Ω impedance.

Supplied accessories

-	AC supply lead (see 'Power cords', Chap. 2).
46881/976	Operating manual (this manual) for 2030 series.

Optional accessories

46880/047	Service manual for 2030 series (consists of operating manual plus maintenance manual).
43126/012	RF connector cable, 50 Ω , 1.5 m, BNC.
54311/092	Coaxial adapter N-type male to BNC female.
59999/163	Precision coaxial adapter, N-type male to SMA female.
54311/095	RF connector cable, 1 m, N-type connectors.
43129/189	GPIB lead assembly.
46883/408	IEEE/IEC adapter block for GPIB socket.
46884/291	Rack mounting kit (with slides) for rack cabinets with depths from 480 mm to 680 mm.
46884/292	Rack mounting kit (with slides) for rack cabinets with depths from 680 mm to 840 mm.
46884/541	Rack mounting kit containing front mounting brackets only.
46884/444	Maintenance kit for 2030 series.
46662/525	Transit case.
54112/164	Soft carrying case.
54499/044	DECT filter.

EC Declaration of Conformity

Certificate Ref. No.: DC218

The undersigned, representing:

Manufacturer:	Aeroflex International Ltd.
Address:	Longacres House, Six Hills Way, Stevenage, Hertfordshire, UK SG1 2AN

Herewith declares that the product:

Equipment Description:	Signal Generators
Model No.	2030, 2031, 2032, 2040, 2041 and 2042
Options:	1, 2, 3, 5, 6, 7, 8, 9, 10, 12, 100, 101, 102, 105, 110 and 112

is in conformity with the following EC directive(s)
(including all applicable amendments)

Reference No.	Title:
2006/95/EC	Low Voltage Directive
2004/108/EC	EMC Directive

and that the standards and/or technical specifications referenced below have been applied:

<p>Safety: IEC/EN61010-1 : 2001 + C1 : 2002 + C2 : 2003</p>
<p>EMC: IEC/EN 61326-1:1997 + A1 : 1998 + A2 : 2001 + A3 : 2003 RF Emission Class B, Immunity Table 1 and Performance Criterion B</p>
<p>Qualifying Notes:</p>

Aeroflex Stevenage (Place)

3 April 2007 (Date)



(Signature)

Richard Dickens — Quality Manager

Chapter 2 INSTALLATION

CONTENTS

	PAGE
INITIAL VISUAL INSPECTION	2-2
MOUNTING ARRANGEMENTS	2-2
INSTALLATION REQUIREMENTS.....	2-2
Ventilation	2-2
Class I power cords (3-core).....	2-2
GOODS-IN CHECKS	2-5
CONNECTING TO SUPPLY	2-5
Voltage selector	2-6
Fuses	2-6
GENERAL PURPOSE INTERFACE BUS (GPIB).....	2-6
GPIB cable connection	2-6
GPIB connector contact assignments	2-7
IEEE to IEC conversion.....	2-7
Interface bus connection	2-8
RACK MOUNTING.....	2-8
BATTERY REPLACEMENT	2-8
ROUTINE MAINTENANCE.....	2-8
Safety testing and inspection	2-8
CLEANING	2-10
Cleaning the LCD window	2-10
PUTTING INTO STORAGE.....	2-10

LIST OF FIGURES

Fig. 2-1 AC connector showing voltage selector and fuse holders	2-6
Fig. 2-2 GPIB connector contact assignments (viewed from rear of instrument) ...	2-7
Fig. 2-3 IEEE to IEC conversion	2-7

WARNING - INITIAL VISUAL INSPECTION

After unpacking the instrument, inspect the shipping container and its cushioning material for signs of stress or damage. If damage is identified, retain the packing material for examination by the carrier in the event that a claim is made. Examine the instrument for signs of damage; do not connect the instrument to a supply when damage is present, internal electrical damage could result in shock if the instrument is turned on.

MOUNTING ARRANGEMENTS

Excessive temperatures may affect the performance of the instrument. Completely remove the plastic cover, if one is supplied over the case, and avoid standing the instrument on or close to other equipment which is hot.

CAUTION - INSTALLATION REQUIREMENTS

Ventilation

This instrument is forced air cooled by a fan mounted on the rear panel. Air must be allowed to circulate freely through the ventilator grills located on the side and underside of the instrument. Before switching on the instrument, ensure that the air outlet on the rear panel is not restricted (i.e. clearance of at least 75 mm at the rear, 25 mm at each side, 15 mm on the underside). Failure to provide adequate clearances will increase internal temperatures and reduce the instrument reliability, so its performance may not meet specification.

Class I power cords (3-core)

General

When the equipment has to be plugged into a Class II (ungrounded) 2-terminal socket outlet, the cable should either be fitted with a 3-pin Class I plug and used in conjunction with an adapter incorporating a ground wire, or be fitted with a Class II plug with an integral ground wire. The ground wire must be securely fastened to ground. Grounding one terminal on a 2-terminal socket will not provide adequate protection.

In the event that a moulded plug has to be removed from a lead, it must be disposed of immediately. A plug with bare flexible cords is hazardous if engaged in a live socket outlet.

Power cords with the following terminations are available from Aeroflex. Please check with your local sales office for availability.

This equipment is provided with a 3-wire (grounded) cordset which includes a moulded IEC 320 connector for connection to the equipment. The cable must be fitted with an approved plug which, when plugged into an appropriate 3-terminal socket outlet, grounds the case of the equipment. Failure to ground the equipment may expose the operator to hazardous voltage levels. Depending upon the destination country, the colour coding of the wires will differ:

	North America	Harmonised
Line (Live)	Black	Brown
Neutral	White	Blue
Ground (Earth)	Green	Green/Yellow

British

The UK lead is fitted with an ASTA approved moulded plug to BS 1363.

Country	IEC 320 plug type	Part number
United Kingdom	Straight through	23422/001
United Kingdom	Right angled	23422/002

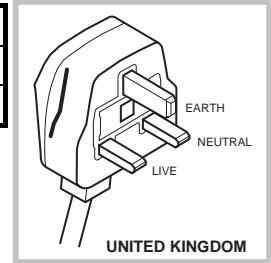

C3510

A replaceable 13 A fuse to BS 1362 is contained within the plug. This fuse is only designed to protect the lead assembly. Never use the plug with the detachable fuse cover omitted or if the cover is damaged.

The fuse(s) or circuit breaker to protect the equipment is fitted at the back of the equipment.

North American

Country	IEC 320 plug type	Part number
North American	Straight through	23422/004
North American	Right angled	23422/005

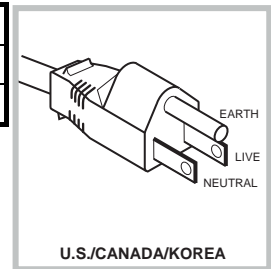

C3511

The North American lead is fitted with a NEMA 5-15P (Canadian CS22.2 No 42) plug and carries approvals from UL and CSA for use in the USA and Canada.

Continental Europe

Country	IEC 320 plug type	Part number
Europe	Straight through	23422/006
Europe	Right angled	23422/007

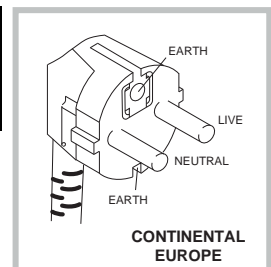

C3512

The Continental European lead is fitted with a right angle IEC83 standard C4 plug (CEE 7/7) which allows it to be used in sockets with either a male earth pin (standard C 3b) or side earth clips (standard C 2b) the latter is commonly called the German 'Schuko' plug. In common with other Schuko style plugs, the plug is not polarized when fitted into a Schuko socket. The lead carries approvals for use in Austria, Belgium, Finland, France, Germany, Holland, Italy, Norway and Sweden. Note that this plug will not fit Italian standard CEI 23-16 outlets. The lead should not be used in Denmark given that the earth connection will not be made.

Français

Le câble d'alimentation d'Europe Continentale est muni d'un connecteur mâle à angle droit type CEI83, standard C4 (CEE 7/7), qui peut être utilisé dans une prise femelle à ergot de terre (standard C 3b) ou à clips latéraux (standard C 2b), cette dernière étant communément appelée prise "Schuko" allemande. De la même façon que les autres connecteurs de type Schuko, celui-ci n'est pas polarisé lorsqu'il s'adapte à une prise femelle Schuko. Ce câble d'alimentation est homologué en Allemagne, Autriche, Belgique, Finlande, France, Hollande, Italie, Norvège et Suède. A noter que ce connecteur n'est pas compatible avec les prises de courant italiennes au standard CEI 23-16. Ce câble ne doit pas être utilisé au Danemark à cause du défaut de connexion de masse.

Deutsch

Das kontinentaleuropäische Netzkabel ist mit einem rechtwinkligen Stecker nach IEC83 C4 (CEE7/7) Standard versehen, welcher sowohl in Steckdosen mit Erde-Stift (Standard C 3b) oder seitlichen Erdeklemmen, im allgemeinen "Schukosteckdose" genannt, paßt. Üblicherweise ist der Schukostecker bei Verwendung in Schukosteckdosen nicht gepolt. Dieses Netzkabel besitzt Zulassung für Österreich, Belgien, Finnland, Frankreich, Deutschland, Holland, Italien, Norwegen und Schweden.

Hinweis: Dieser Schukostecker paßt nicht in die italienischen Standardsteckdosen nach CEI 23-16 Norm. Dieses Netzkabel sollte nicht in Dänemark verwendet werden, da hier keine Erdeverbindung hergestellt wird.

Español

El cable de alimentación tipo Europeo Continental dispone de una clavija C4 normalizada IEC83 (CEE 7/7) que permite su utilización tanto en bases de enchufe con toma de tierra macho (tipo C 3b) o con toma de tierra mediante contactos laterales (tipo C 2b) que, en este último caso, suele denominarse "Schuko". Al igual que cualquier otra clavija tipo Schuko, las conexiones a red no están polarizadas cuando se conectan a una base tipo Schuko. El cable lleva autorización para su uso en Austria, Bélgica, Finlandia, Francia, Alemania, Holanda, Italia, Noruega y Suecia. Observe que este cable no se adapta a la norma italiana CEI 23-16. El cable no debe utilizarse en Dinamarca en el caso de no efectuarse conexión a tierra.

Italiano

I cavi d'alimentazione per l'Europa continentale vengono forniti terminati con una spina ad angolo retto del tipo C4 secondo lo standard IEC83 (CEE 7/7) che può essere usato in prese in cui la terra può essere fornita o tramite connettore maschio (C 3b) o tramite clips laterali (C 2b), quest'ultima comunemente detta di tipo tedesca "Schuko". Questa spina, quando collegata ad una presa Schuko, non è polarizzata.

Il cavo può essere usato in Austria, Belgio, Finlandia, Francia, Germania, Olanda, Norvegia, Svezia ed Italia. E' da notare che per l'Italia questo non risponde allo standard CEI 23-16.

Questa spina non dovrebbe invece essere usata in Danimarca in quanto non realizza il collegamento di terra.

GOODS-IN CHECKS

The following goods-in checks verify that the instrument is functioning correctly, but does not verify conformance to the listed specification. To verify that the instrument conforms to the specification given in Chapter 1, refer to Chapter 5-1, 'Acceptance testing'.

- 1 Inspect the shipping container and instrument for any signs of damage. If damage is evident, do not plug in, turn on or attempt to operate the instrument. Repackage it and return it to Aeroflex.
- 2 Verify that your order is complete, including any accessories and options that you may have ordered.
- 3 Check that the setting of the voltage selector switch matches the supply voltage available at the installation site. The voltage selector is an integral part of the supply connector, located on the rear panel of the instrument. If different, refer to **Voltage selector** section and Fig. 2-1 for information on settings.
- 4 Check that the correct fuse(s) are fitted and correspond to your supply voltage. If different, replace with the same type and rating as marked adjacent to the supply connector (fuse(s) integral to supply connector: see **Fuses** section and Fig. 2-1 for guidance).
- 5 Switch on the instrument and check that a display is present.
- 6 If the instrument appears to be completely dead, carry out the following:
 - Check that the mains power supply line is providing power to the instrument.
 - Check that the mains fuse(s) have not blown.

CONNECTING TO SUPPLY

The instrument is a Safety Class 1 product and therefore must be earthed. Use the supplied power cord or an appropriate replacement. Make sure that the instrument is plugged into an outlet socket with a protective earth contact.

Disconnecting device

The detachable power cord is the instrument's disconnecting device, but if the instrument is integrated into a rack or system, an external power switch or circuit breaker may be required. Whatever the disconnecting device, make sure that you can reach it easily and that it is accessible at all times.

Before connecting the instrument to the AC supply, check the setting of the voltage selector switch which is an integral part of the supply connector at the rear of the instrument.

Voltage selector

The selected voltage is displayed in a window at the top of the connector. The instrument is normally despatched with the selector set to 240 V. To select another voltage, insert a screwdriver into the slot at the top of the moulding and twist slightly so that the cover is free to hinge downwards. Rotate the barrel so that the correct setting is displayed, see Fig. 2-1.

Setting	Voltage range limit
100 V	90 - 115 V
120 V	105 - 132 V
220 V	188 - 242 V
240 V	216 - 265 V

Fuses

The correct fuse rating for each voltage setting is as follows:

100 V to 120 V, TT1.6AL250V (1.6 amp double time lag)

220 V to 240 V, TT1AL250V (1 amp double time lag)

Fuses are cartridge type measuring 20 mm x 5 mm.

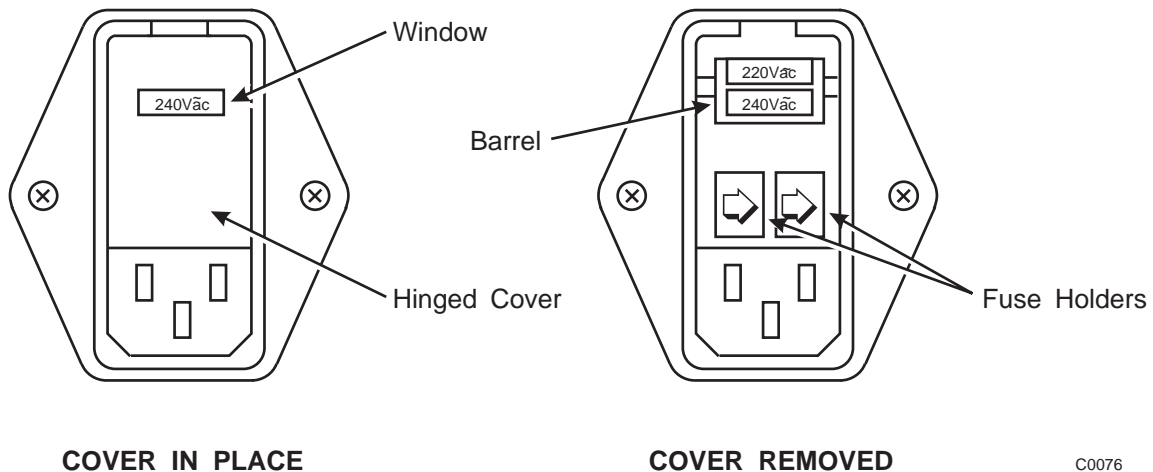

Fig. 2-1 AC connector showing voltage selector and fuse holders

GENERAL PURPOSE INTERFACE BUS (GPIB)

The GPIB interface built into the 2030 series enables the signal generators to be remotely controlled to form part of an automatic measuring system.

GPIB cable connection

Connection to other equipment which has a 24-way connector to IEEE Standard 488 is made using the rear panel GPIB socket. For this purpose, the GPIB cable assembly, available as an optional accessory, (see Chap. 1 'Accessories') may be used.

GPIB connector contact assignments

The contact assignments of the GPIB cable connector and the device connector are as shown in Fig. 2-2.

Contact	Function	Contact	Function
1	Data I/O 1	13	Data I/O 5
2	Data I/O 2	14	Data I/O 6
3	Data I/O 3	15	Data I/O 7
4	Data I/O 4	16	Data I/O 8
5	EOI	17	REN
6	DAV	18	Pair with 6
7	NRFD	19	Pair with 7
8	NDAC	20	Pair with 8
9	IFC	21	Pair with 9
10	SRQ	22	Pair with 10
11	ATN	23	Pair with 11
12	Ground shield	24	Logic ground

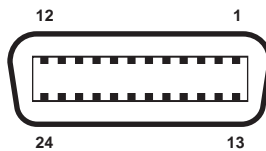
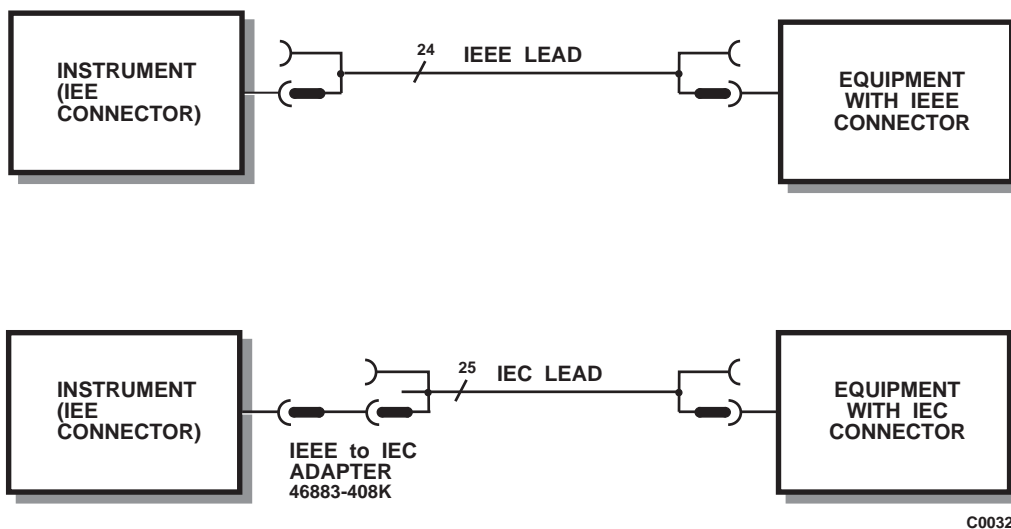

Fig. 2-2 GPIB connector contact assignments (viewed from rear of instrument)

IEEE to IEC conversion

An optional IEEE to IEC adapter is also available (see Chap. 1 'Optional Accessories') for interfacing with systems using a 25-way bus connector to IEC Recommendation 625. The method of use is shown in Fig. 2-3.



C0032

Fig. 2-3 IEEE to IEC conversion

Interface bus connection

The cables for the interface bus use special male-female connectors at both ends. This allows several connectors to be stacked one on top of another permitting several cables to be connected to the same source and secured by a lock screw mechanism. Too large a stack, however, may form a cantilevered structure which might cause damage and should be avoided. The piggyback arrangement permits star or linear interconnection between the devices with the restriction that the total cable length for the system must be:

- (1) No greater than 20 m (65 ft).
- (2) No greater than 2 m (6 ft) times the total number of devices (including the controller) connected to the bus.

RACK MOUNTING

The instrument, which is normally supplied for bench mounting, may be mounted in a standard 19 inch rack (see Chap. 1 'Optional Accessories'). There are two slide rack mounting kits to accommodate different depths of cabinet. These kits include full fitting instructions. A rack mounting kit without slides is also available which contains front panel mounting brackets only.

BATTERY REPLACEMENT

The instrument contains a real-time clock which is powered by a lithium battery when the normal power is removed. Although battery life can extend to five years, this will depend on conditions of use, e.g. battery life is reduced as the temperature is increased. To avoid loss of data it is recommended that the battery is replaced every two years.

Replace the battery as follows:

- (1) Ensure that the instrument is switched on; this will provide power for the non-volatile memory while the battery is replaced. If this is not possible, the clock will continue to run for approximately 30 seconds, whilst the replacement is made.
- (2) Using a coin or suitable tool, unscrew the battery compartment cover at the rear of the instrument.
- (3) Remove the battery, noting its orientation. Insert the replacement, then replace the battery compartment cover.

The replacement battery should be SAFT L56 or equivalent. This is a lithium 3.5 V type, rated at 1800 mA_H, size AA. If a lithium battery is unobtainable an alkaline battery can be used but it will have a shorter life. A suitable battery can be obtained from Aeroflex (part number 23711/106).

CAUTION - ROUTINE MAINTENANCE

Safety testing and inspection

In the UK, the 'Electricity at Work Regulations' (1989) section 4(2) places a requirement on the users of equipment to maintain it in a safe condition. The explanatory notes call for regular inspections and tests together with a need to keep records.

The following electrical tests and inspection information is provided for guidance purposes and involves the use of voltages and currents that can cause injury. It is important that these tests are only performed by competent personnel.

Prior to carrying out any inspection and tests, the instruments must be disconnected from the mains supply and all external signal connections removed. All tests should include the instrument's own supply lead, all covers must be fitted and the equipment supply switch must be in the 'ON' position.

The recommended inspection and tests fall into three categories and should be carried out in the following sequence:

1. Visual inspection
2. Earth bonding tests
3. Insulation resistance test

1. Visual inspection

A visual inspection should be carried out on a periodic basis. This interval is dependent on the operating environment, maintenance and use, and should be assessed in accordance with guidelines issued by the Health and Safety Executive (HSE). As a guide, this instrument when used indoors in a relatively clean environment would be classified as 'low risk' equipment and hence should be subject to safety inspections on an annual basis. If the use of the equipment is contrary to the conditions specified, you should review the safety re-test interval.

As a guide, the visual inspection should include the following where appropriate:

Check that the equipment has been installed in accordance with the instructions provided (e.g. that ventilation is adequate, supply isolators are accessible, supply wiring is adequate and properly routed).

The condition of the mains supply lead and supply connector(s).

Check that the mains supply switch isolates the instrument from the supply.

The correct rating and type of supply fuses.

Security and condition of covers and handles.

Check the supply indicator functions (if fitted).

Check the presence and condition of all warning labels and markings and supplied safety information.

Check the wiring in re-wireable plugs and appliance connectors.

If any defect is noted this should be rectified before proceeding with the following electrical tests.

2. Earth bonding tests

Earth bonding tests should be carried out using a 25 A (12 V maximum open circuit voltage) DC source. Tests should be limited to a maximum duration of 5 seconds and have a pass limit of 0.1 Ω after allowing for the resistance of the supply lead. Exceeding the test duration can cause damage to the equipment. The tests should be carried out between the supply earth and exposed case metalwork, no attempt should be made to perform the tests on functional earths (e.g. signal carrying connector shells or screen connections) as this will result in damage to the equipment.

3. Insulation tests

A 500 V DC test should be applied between the protective earth connection and combined live and neutral supply connections with the equipment supply switch in the 'on' position. It is advisable to make the live/neutral link on the appliance tester or its connector to avoid the possibility of returning the equipment to the user with the live and neutral poles linked with an ad-hoc strap. The test voltage should be applied for 5 seconds before taking the measurement.

Aeroflex employs reinforced insulation in the construction of its products and hence a minimum pass limit of 7 MΩ should be achieved during this test.

Where a DC power adapter is provided with the equipment, the adapter must pass the 7 MΩ test limit.

We do not recommend dielectric flash testing during routine safety tests. Most portable appliance testers use AC for the dielectric strength test which can cause damage to the supply input filter capacitors.

4. Rectification

It is recommended that the results of the above tests are recorded and checked during each repeat test. Significant differences between the previous readings and measured values should be investigated.

If any failure is detected during the above visual inspection or tests, the equipment should be disabled and the fault should be rectified by an experienced Service Engineer who is familiar with the hazards involved in carrying out such repairs.

Safety critical components should only be replaced with equivalent parts, using techniques and procedures recommended by Aeroflex.

The above information is provided for guidance only. Aeroflex designs and constructs its products in accordance with International Safety Standards such that in normal use they represent no hazard to the operator. Aeroflex reserves the right to amend the above information in the course of its continuing commitment to product safety.

CLEANING

Before commencing any cleaning, switch off the instrument and disconnect it from the supply. The exterior surface of the case may be cleaned using a soft cloth moistened in water. Do not use aerosol or liquid solvent cleaners.

Cleaning the LCD window

To prevent damage to the LCD window, care should be taken not to scratch the surface during use and also when cleaning. The LCD window should be cleaned by wiping a slightly damp, soft, lint-free cloth gently over the surface.

PUTTING INTO STORAGE

If the instrument is to be put into storage, ensure that the following conditions are maintained:

Temperature range: -40 to +70°C
Humidity: Less than 93% at 40°C

Chapter 3-1 OPERATION

CONTENTS

	PAGE
INTRODUCTION	3-1-4
CONVENTIONS	3-1-4
FRONT PANEL.....	3-1-4
REAR PANEL.....	3-1-6
THE MENUS.....	3-1-7
FIRST TIME USE	3-1-9
Switching on	3-1-9
Changing the value of the selected parameter	3-1-10
Enabling or disabling the modulation.....	3-1-11
Using the [$\uparrow \times 10$] and [$\downarrow \div 10$] keys	3-1-11
Using the control knob.....	3-1-11
DETAILED OPERATION	3-1-12
CARRIER FREQUENCY	3-1-12
Carrier ON/OFF.....	3-1-12
OUTPUT LEVEL	3-1-12
Choice of units	3-1-12
Reverse power protection	3-1-13
MODULATION	3-1-13
MODULATION MODES	3-1-14
Modulation mode selection.....	3-1-15
Selecting the modulation	3-1-16
Modulation ON/OFF.....	3-1-16
Selecting amplitude modulation	3-1-17
Selecting frequency modulation	3-1-17
Selecting phase modulation	3-1-17
Selecting wideband frequency modulation.....	3-1-18
Modulation source frequency	3-1-18
Source selection - internal	3-1-19
Source selection - external.....	3-1-21
MODULATION ALC	3-1-22
PULSE MODULATION	3-1-23
Selecting the pulse modulation mode	3-1-23
Selecting pulse modulation.....	3-1-24
Low intermodulation mode.....	3-1-25
SIGNALLING	3-1-26
CTCSS	3-1-26
Sequential calling tones	3-1-27
INCREMENTING (using Δ)	3-1-32
Displaying shifts	3-1-32
Setting increment values	3-1-32
SWEEP	3-1-33
Sweep type.....	3-1-33
Sweep mode.....	3-1-35
Sweep parameter entry.....	3-1-35
Sweep control.....	3-1-37
UTILITIES.....	3-1-39
Adjusting the display	3-1-40
Hardware information.....	3-1-40
Software information	3-1-40
External trigger	3-1-41
Setting the modulation mode	3-1-41

Setting the GPIB address	3-1-41
Sequential calling tones	3-1-41
Carrier phase adjustment	3-1-41
Selection of frequency standard.....	3-1-42
Selection menu 2.....	3-1-42
Calibration	3-1-43
Latch data.....	3-1-43
Elapsed time.....	3-1-43
Locking and unlocking	3-1-44
Setting time and date.....	3-1-45
Keyboard locking.....	3-1-45
Display blanking	3-1-45
Power up options.....	3-1-45
RF level units	3-1-46
LF level units	3-1-47
RF level utility	3-1-48
LOW FREQUENCY OPERATION	3-1-52
LF monitor	3-1-52
Modulation source monitoring.....	3-1-52
Modulation drive monitoring.....	3-1-52
Use as an independent LF generator.....	3-1-53
MEMORY.....	3-1-54
Memory recall.....	3-1-54
Memory stepping facility.....	3-1-55
Memory store.....	3-1-57
Frequency hopping.....	3-1-60
ERROR HANDLING	3-1-63
Background errors.....	3-1-63
Foreground errors	3-1-63
GPIB errors	3-1-63
Error display	3-1-63

LIST OF TABLES

Table 3-1-1 List of available soft keys for different modulation modes	3-1-52
Table 3-1-2 Background errors.....	3-1-64
Table 3-1-3 Foreground errors.....	3-1-64
Table 3-1-4 GPIB errors	3-1-65
Table 3-1-5 Fatal errors	3-1-66

LIST OF FIGURES

Fig. 3-1-1 2031 front panel	3-1-4
Fig. 3-1-2 2031 rear panel.....	3-1-6
Fig. 3-1-3 Sig Gen menu - default display for 2030.....	3-1-7
Fig. 3-1-4 Sig Gen menu - default display for 2031	3-1-7
Fig. 3-1-5 Sig Gen menu - default display for 2032.....	3-1-8
Fig. 3-1-6 Amplitude modulation - menu configuration	3-1-11
Fig. 3-1-7 RPP tripped	3-1-13
Fig. 3-1-8 Modulation mode selection menu	3-1-15
Fig. 3-1-9 Sig Gen menu with two modulation channels (Composite mode)	3-1-16
Fig. 3-1-10 Internal source selection menu	3-1-19
Fig. 3-1-11 LF phase control	3-1-20
Fig. 3-1-12 External source selection menu	3-1-21
Fig. 3-1-13 Sig Gen menu with pulse modulation selected.....	3-1-24
Fig. 3-1-14 Continuous tone selection menu	3-1-26
Fig. 3-1-15 Sequential calling tones utility menu.....	3-1-27

Fig. 3-1-16	Sequential calling tones utility menu (DTMF mode).....	3-1-28
Fig. 3-1-17	Calling tones mode control menu (with [FM] selected).....	3-1-29
Fig. 3-1-18	Tone standard selection menu.....	3-1-30
Fig. 3-1-19	Edit sequential tones standard menu.....	3-1-31
Fig. 3-1-20	Total shift menu	3-1-32
Fig. 3-1-21	Sweep parameters display.....	3-1-33
Fig. 3-1-22	Sweep type menu	3-1-34
Fig. 3-1-23	Sweep trigger mode menu	3-1-35
Fig. 3-1-24	Sweep markers menu	3-1-36
Fig. 3-1-25	Sweep in progress	3-1-37
Fig. 3-1-26	Sweep stopped	3-1-38
Fig. 3-1-27	RF level transferred	3-1-38
Fig. 3-1-28	Utilities selection menu 1	3-1-39
Fig. 3-1-29	Display adjust menu.....	3-1-40
Fig. 3-1-30	Utilities selection menu 2	3-1-42
Fig. 3-1-31	Calibration utilities menu.....	3-1-43
Fig. 3-1-32	RF level units selection menu (shown unlocked to level 1).....	3-1-46
Fig. 3-1-33	LF level units selection menu (shown unlocked to level 1)	3-1-47
Fig. 3-1-34	RF level utility menu	3-1-48
Fig. 3-1-35	Normal signal generator level control operation	3-1-49
Fig. 3-1-36	Extended hysteresis operation with RF level -9 dBm as starting level	3-1-49
Fig. 3-1-37	RF offset adjustment menu	3-1-50
Fig. 3-1-38	RF level limit menu	3-1-51
Fig. 3-1-39	LF generator menu.....	3-1-53
Fig. 3-1-40	Memory recall menu	3-1-54
Fig. 3-1-41	Memory stepping menu	3-1-56
Fig. 3-1-42	Memory store menu	3-1-57
Fig. 3-1-43	Frequency hopping menu.....	3-1-60

INTRODUCTION

This chapter explains how to:

- Set up the signal generator to produce a typical basic signal.
- Select the main operating parameters; carrier frequency, output level and type of modulation.
- Use the full range of supporting facilities.

Note...

When connecting the PULSE INPUT connector to external equipment, a double screened coaxial cable should be used in order for the instrument to conform to EMC requirements.

CONVENTIONS

The following conventions are used in this chapter:

RF OUTPUT	Capitals refer to titles marked on the panel.
[MEM]	Text in square brackets indicates hard key titles.
<i>Int. F4</i>	Italics refer to data or messages on the display.
<i>[Pulse]</i>	Italics in square brackets indicate soft key titles, e.g. <i>[Pulse]</i> means the soft key adjacent to the <i>Pulse</i> title box at the side of the menu.

FRONT PANEL

Parameters are selected by means of hard keys, which have their function printed on them, soft keys, which do not have any notation, a numerical key pad and a rotary control knob, see Fig. 3-1-1. The hard keys have functions which do not change, whereas the soft key functions are determined by the menu which is being displayed. The numerical keys are used to set parameters to specific values which can also be varied in steps of any size by using the \uparrow/\downarrow keys or the rotary control knob.

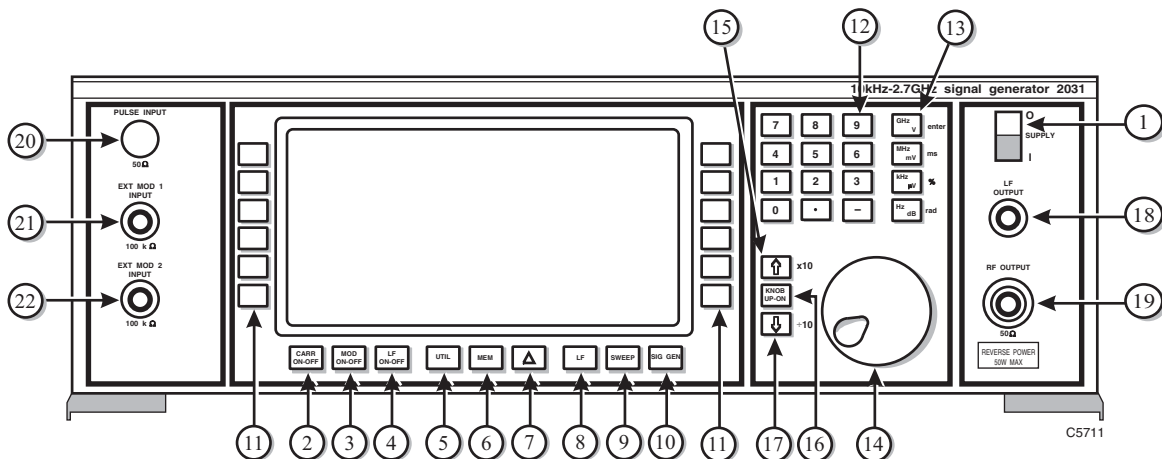

Fig. 3-1-1 2031 front panel

OPERATION

- | | | |
|------|----------------------|---|
| (1) | SUPPLY | Switches the AC supply voltage on and off. |
| (2) | CARR ON-OFF | Enables or disables the carrier frequency. |
| (3) | MOD ON-OFF | Enables or disables the modulation. |
| (4) | LF ON-OFF | Switches the low frequency output on and off. |
| (5) | UTIL | Displays the utilities menu. |
| (6) | MEM | Displays the memory store/recall menu. |
| (7) | Δ | Displays the total shift menu. |
| (8) | LF | Displays the LF and monitor menus. |
| (9) | SWEEP | Displays the sweep status menu. |
| (10) | SIG GEN | Displays the main menu. |
| (11) | SOFT KEYS; | Twelve function keys change notation as the menu changes. |
| (12) | NUMERICAL
KEY PAD | For changing the value of a selected parameter. Minus sign and decimal point are included. |
| (13) | UNITS KEYS | Determine the units of set parameters and terminate the numerical entry. |
| (14) | CONTROL KNOB | When enabled, adjusts the value of the selected parameter. |
| (15) | $\uparrow \times 10$ | When knob disabled, increments a selected parameter. When knob enabled, increases knob sensitivity by factor of ten. |
| (16) | KNOB UP-DN | Switches between control knob and $\uparrow\downarrow$ keys. |
| (17) | $\downarrow \div 10$ | When knob disabled, decrements a selected parameter. When knob enabled, decreases knob sensitivity by factor of ten. |
| (18) | LF OUTPUT | BNC socket provides a low impedance output at the frequency selected at the <i>LF GENERATOR MENU</i> or monitors the modulating signal. |
| (19) | RF OUTPUT | 50 Ω N type socket with reverse power protection. |
| (20) | PULSE
INPUT | 50 Ω BNC socket (if fitted) accepts a pulsed signal. |
| (21) | EXT MOD 1
INPUT | 100 k Ω BNC socket. An independent input which allows an external modulation signal to be applied. |
| (22) | EXT MOD 2
INPUT | 100 k Ω BNC socket, similar to (21). |

REAR PANEL

The following facilities are available on the rear panel, see Fig. 3-1-2.

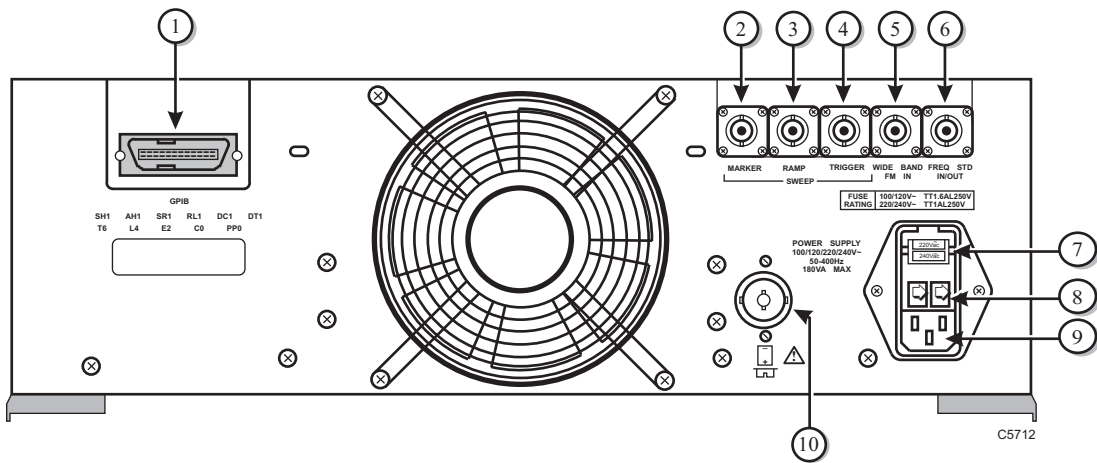
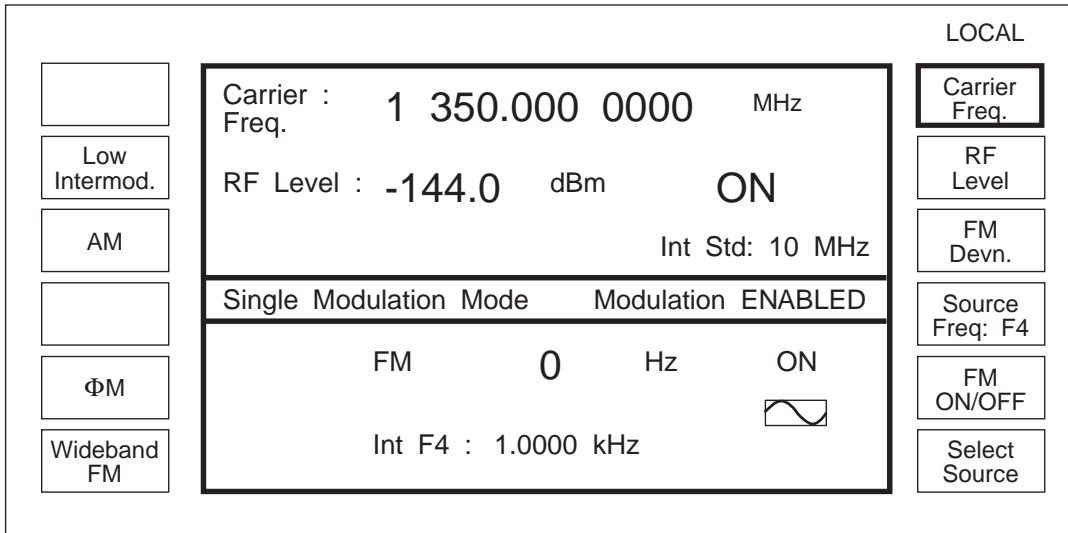

Fig. 3-1-2 2031 rear panel

- | | | |
|------|-------------------------|---|
| (1) | GPIB | 24 pin socket accepts standard IEEE connector to allow remote control of the instrument. |
| (2) | SWEEP MARKER | BNC socket supplies sweep marker. |
| (3) | SWEEP RAMP | BNC socket provides a ramp output at 0 to 10 V peak to peak. |
| (4) | SWEEP TRIGGER | BNC socket provides access for a trigger input. |
| (5) | WIDE BAND FM IN | BNC socket accepts a wide bandwidth FM signal into 50 Ω with a typical bandwidth of 10 MHz. |
| (6) | FREQ STD IN/OUT | BNC socket for standard frequencies at 1, 5 or 10 MHz with a nominal 2 V pk-pk level into 50 Ω . |
| (7) | VOLTAGE SELECTOR | Removable cover reveals barrel which can be rotated to select the required voltage range. |
| (8) | FUSES | AC fuses rated at TT1.6AL250V for the 100 to 120 V range and TT1AL250V for the 220 to 240 V range. |
| (9) | AC SUPPLY INPUT | 3 pin plug integral with voltage selector and fuse holders. Mates with supply lead socket. |
| (10) | BATTERY HOLDER | Houses battery for real time clock. |

THE MENUS

The 2030 Series instruments are operated by calling up various displays or menus on the screen. Menus are accessed via both hard and soft keys. Pressing a hard key normally causes the appropriate primary menu to appear on the screen regardless of the current working position within the menu hierarchy. As the display changes from one menu to another, so the 12 soft keys assume those functions necessary to drive the instrument from that menu. Secondary menus are displayed by pressing a soft key while in a primary menu. Some sub-menus are nested e.g. UTILITIES. Clearance from these is obtained by pressing the [EXIT] or [UTIL] key.



C1885

Fig. 3-1-3 Sig Gen menu - default display for 2030

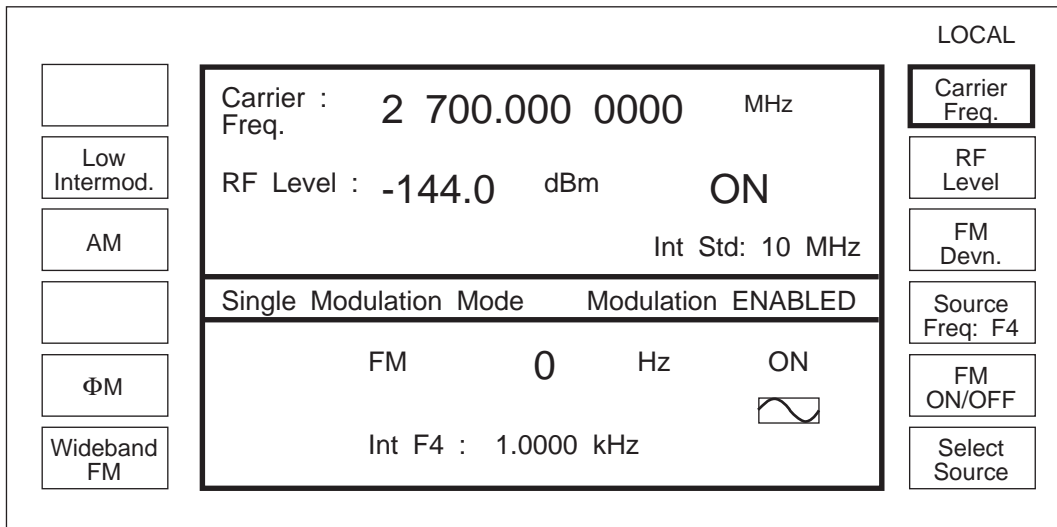

C0482

Fig. 3-1-4 Sig Gen menu - default display for 2031

	Carrier : 5 400.000 0000 MHz	LOCAL
Low Intermod.	Freq.	Carrier Freq.
AM	RF Level : -144.0 dBm ON	RF Level
	Int Std: 10 MHz	FM Devn.
ΦM	Single Modulation Mode Modulation ENABLED	Source Freq: F4
Wideband FM	FM 0 Hz ON	FM ON/OFF
	Int F4 : 1.0000 kHz	Select Source

C0483

Fig. 3-1-5 Sig Gen menu - default display for 2032

FIRST TIME USE

First time users can quickly become familiar with the principles of control and display by carrying out the following exercise, which demonstrates how to set up a typical basic signal having the following parameters:

Carrier frequency: 100 MHz.
Output level: 10 dBm.
Amplitude modulation: 30% depth at 1 kHz.

Switching on

- (1) Before switching the instrument on, check that the voltage selector has been set to the value of the power supply as described in Chap. 2, and that no signal voltage is present on the PULSE INPUT socket.
- (2) If the default display shown in Fig. 3-1-3 or Fig. 3-1-4 or Fig. 3-1-5 is not obtained, a previous user may have set the instrument to switch on with one of the user memories recalled rather than using the default factory settings. Before proceeding any further you should reset this selection, see 'Power up options'. Switch off and on again. Alternatively use the [MEM] key followed by entering 50 and terminating by pressing the [enter] key. This will reset the instrument to the factory default setting.

If the RF level units and the internal/external standard are not as shown, they can be changed as described on Page 3-1-46, 'RF level units' and Page 3-1-42 'Selection of frequency standard'.

- (3) Observe that the main menu appears on the display showing default parameters for FM. The soft key label marked [*Carrier Freq.*] is highlighted (i.e. the line bordering the label is increased in thickness to about 1 mm), which means that anything entered at this stage will change the carrier frequency.
- (4) If necessary, adjust the display for brightness and contrast, see 'UTILITIES' Page 3-1-39.

Changing the value of the selected parameter

If an error is made when keying in, press the soft key again and key in the correct value. If an error message is displayed, it can be cancelled by entering a value which is within limits.

- (1) Using the numerical key pad, enter 100 MHz by pressing keys [1], [0], [0] and the key marked [MHz/mV/ms]. Observe that the Carrier Freq. display changes to *100.000 0000* MHz.
- (2) Press [*RF level*]. The *RF Level* soft key label is now highlighted.
- (3) Using the numerical key pad, enter 10 dBm by pressing keys [1], [0] and the key marked [Hz/dB/rad]. Observe that the RF Level display changes to *10.0 dBm*.
- (4) Press [*AM*] on the left-hand side of the display. The menu will now change to display AM modulation parameters in the lower panel. The [*FM Devn.*] soft key on the right hand side of the menu changes to [*AM Depth*] and this label is now highlighted. *AM* disappears from the left-hand side.
- (5) Using the numerical key pad, enter 30% AM depth by pressing [3], [0] and [kHz/ μ V/%]. Observe that the *AM* depth display changes to *30%*. The display will now be as in Fig. 3-1-6 and the selected signal will now be present at the RF OUTPUT socket.

Enabling or disabling the modulation

The modulation is ON by default, but the AM can be turned ON and OFF by pressing [AM ON/OFF] at the right hand side of the display and the modulation can be enabled or disabled by pressing [MOD ON-OFF]. These are both toggle actions, i.e. press ON, press OFF. The soft key acts only on the selected modulation whereas the [MOD ON-OFF] acts on all modulations.

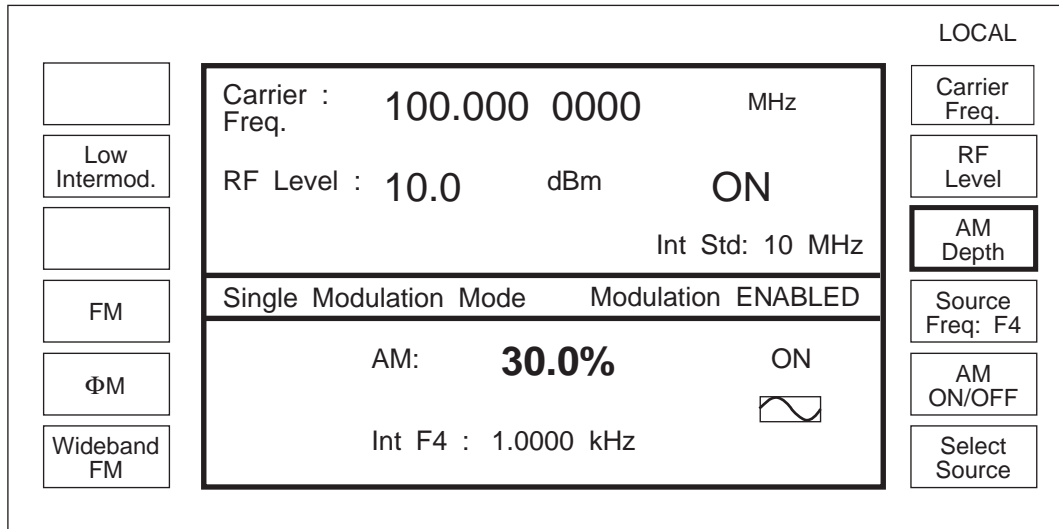

C1886

Fig. 3-1-6 Amplitude modulation - menu configuration

Using the [↑ ×10] and [↓ ÷10] keys

When a parameter has been selected via the numerical key pad, its value can be incremented or decremented either in steps using the [↑] key and the [↓] key, or continuously with the control knob. Select [Carrier Freq.] and observe that the effect of pressing the [↑] and [↓] keys is to change the carrier frequency in steps of 1 kHz. Default step sizes are assigned to all parameters but these can be changed, see 'INCREMENTING (using Δ)'.

Using the control knob

- (1) Press [KNOB UP-DN] to enable the control knob.
- (2) On the display, brackets will appear above and below the selected parameter. These brackets embrace the part of the value which the control knob can change. Pressing the [×10] key shortens the bracket length by one decimal place. Pressing the [÷10] key increases the bracket length by one decimal place. In this way the sensitivity of the control knob can be increased or decreased by a factor of ten.
- (3) Rotate the control knob and observe the change in the selected parameter. Press [KNOB UP-DN] to disable the knob.
- (4) For other parameters, press the relevant soft key and use the [↑] and [↓] keys or the control knob.

Note...

For *RF Level* the knob resolution is fixed at 0.1 dB.

DETAILED OPERATION

CARRIER FREQUENCY

The carrier frequency is selected from the *Sig Gen* menu by pressing [*Carrier Freq.*], unless it is already highlighted as in the default display.

Enter the required value via the numerical key pad. The value can then be incremented or decremented using the control knob and its associated keys, [KNOB UP-DN], [$\times 10$] and [$\div 10$].

If a value outside the specified range is requested, the message:

ERROR 51: Carrier Outside Limits

is displayed on the screen when the terminator key is pressed, and the instrument is automatically set to the end of the range.

Carrier ON/OFF

The carrier may be switched *ON* or *OFF* at any time via the [CARR ON-OFF] key. This effectively switches the output ON and OFF, retaining the 50 Ω output impedance.

OUTPUT LEVEL

The output level is selected at the *Sig Gen* menu by pressing [*RF Level*] and entering the required value on the numerical key pad. The value can then be incremented or decremented using the control knob and its associated keys, [KNOB UP-DN], [$\times 10$] and [$\div 10$]. If a value outside the specified range is requested the message:

ERROR 52: RF Level Outside Limits

or

ERROR 17: RF Level limited by AM

is displayed and the instrument is automatically set to the end of the range.

Note...

The knob resolution is fixed at 0.1 dB.

Choice of units

Units may be μV , mV, V or dB. Conversion between dB and the voltage units is carried out by pressing the appropriate units key, i.e. to change dBm to a voltage unit, press any voltage key for the correct conversion. The choice of Volts EMF, Volts PD, and the dB reference is made by using the [*RF Level Units*] utility, see Page 3-1-46, 'RF level units'.

Reverse power protection

Accidental application of power to the RF OUTPUT socket trips the reverse power protection circuit (RPP) and a flashing message appears on the display, see Fig. 3-1-7.

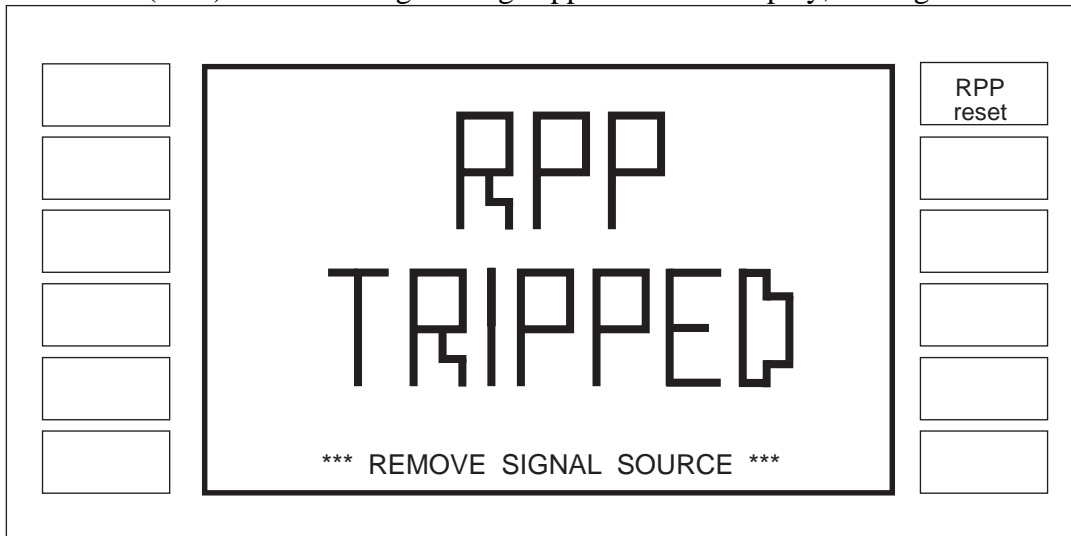

C0004

Fig. 3-1-7 RPP tripped

Pressing *[RPP Reset]* resets the RPP and returns the display to the menu in use when the reverse power protection was tripped. If *[RPP Reset]* is pressed with the signal still applied, the RPP will trip again.

MODULATION

The carrier can be frequency, amplitude, or phase modulated, with pulse modulation as an option. The internal modulation oscillator has a frequency range of 0.1 Hz to 500 kHz, with a resolution of 0.1 Hz.

MODULATION MODES

Two independent inputs on the front panel EXT MOD 1 INPUT, EXT MOD 2 INPUT allow external modulation signals to be summed with signals from the internal oscillator and a second optional internal oscillator (if fitted). Thus up to four modulations may be available at one time. These can be combined to give single, dual, composite and dual composite modes of operation.

Single

In the single mode, only one modulation can be active at any one time, and selecting another modulation cancels the first.

Dual

In the dual mode, a common carrier wave is modulated by two different types of modulation, e.g. one AM and one FM. Each type of modulation can carry separate information.

Composite

This mode consists of two modulating channels of the same type of modulation (e.g. FM1 + FM2) with the effective modulation being the sum of the two waveforms.

Dual composite

This mode is similar to the composite mode of operation but with the two modulating channels being the sum of two sources, e.g. FM1 + FM2 and AM1 + AM2.

Modulation mode selection

In order to select a different modulation mode;

- (1) Press [UTIL]. *Utilities Selection Menu 1* will appear on the display.
- (2) Press the [Mod'n Mode] key. This calls up the *Modulation Mode Selection Menu* shown in Fig. 3-1-8. The four possible modulation modes are shown. Press the required soft key.

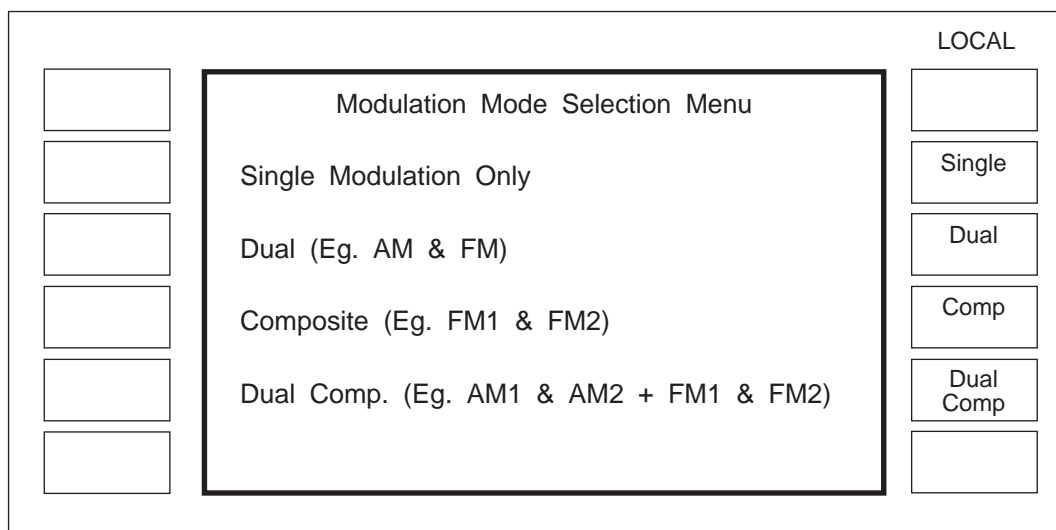

C1710

Fig. 3-1-8 Modulation mode selection menu

Notes...

If the Avionics option (Option 006) is fitted an additional soft key [*Avionics Modes*] will be displayed. See Annex B for avionics modes selection.

If the GMSK option (Option 005) is fitted an additional soft key [*GMSK*] will be displayed. See Annex A for GMSK mode selection.

- (3) Press [SIG GEN] to return to the *Sig Gen* menu where the modulation mode and individual source parameters (where applicable) will be shown. For composite mode selection a menu similar to Fig. 3-1-9 will be displayed.

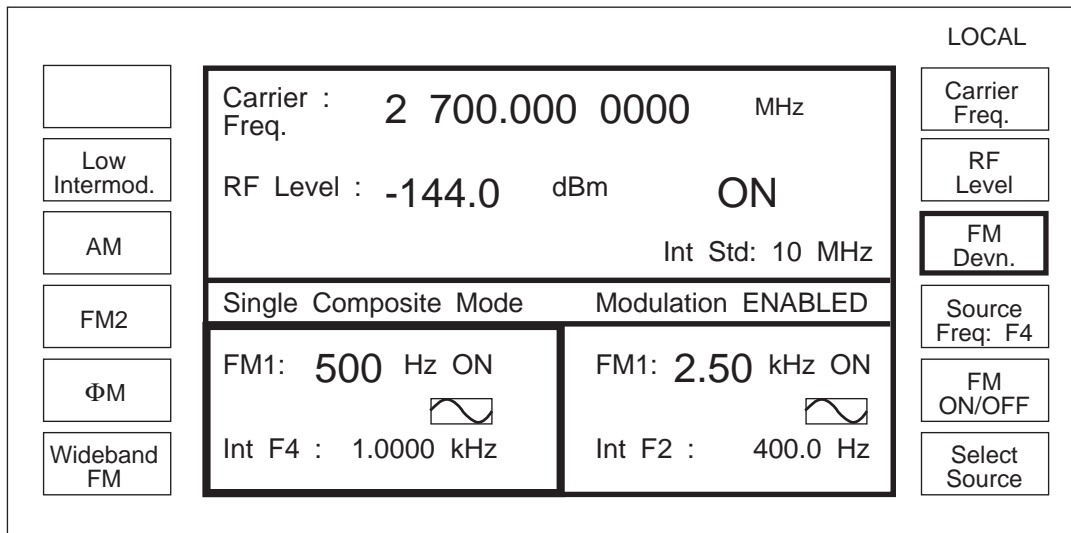

C0485

Fig. 3-1-9 Sig Gen menu with two modulation channels
(Composite mode)

Note...

Full information on the range of utilities can be found under 'UTILITIES'.

Selecting the modulation

The type of modulation required, AM, FM, ΦM, wideband and optional pulse modulation can be selected by soft keys at the Sig Gen menu. Four modulation modes are available, see 'Modulation mode selection' above.

Modulation ON/OFF

[MOD ON-OFF] switches all modulation ON or OFF and the condition is indicated in the centre of the main display, e.g:

Modulation DISABLED

Modulation is also controlled by a soft key which turns the selected modulation on and off. For modulation to appear on the carrier, modulation must be both enabled with the [MOD ON-OFF] hard key and turned on via the soft key. In single modulation modes the [MOD ON-OFF] key and the [FM ON/OFF], [AM ON/OFF], [ΦM ON/OFF] keys appear to carry out the same function, but the action is different, particularly in the FM mode. The [FM ON/OFF] etc. soft keys only reduce the modulation to zero whereas the [MOD ON-OFF] key completely disables the modulation system such that the instrument reverts to a carrier frequency generator.

Selecting amplitude modulation

- (1) At the *Sig Gen* menu, press *[AM]*, the *[AM Depth]* box is now highlighted.
- (2) Enter the required modulation depth via the numerical key pad and terminate with the *[%]* key. If the modulation depth requested exceeds 99.9%, the depth is reset to the maximum value available and the message:

ERROR 56: AM Outside Limits

is displayed at the top of the screen.

- (3) Switch the AM ON or OFF by pressing *[AM ON/OFF]*. The AM information is displayed in the lower half of the screen.

Selecting frequency modulation

- (1) At the *Sig Gen* menu, press *[FM]*, the *[FM Devn.]* box will be highlighted.
- (2) Enter the FM deviation value via the numerical key pad and terminate it with *[Hz]*, *[kHz]* or *[MHz]*.
- (3) Switch the FM ON or OFF via *[FM ON/OFF]*. The FM information is displayed in the lower half of the screen.

Selecting phase modulation

- (1) At the *Sig Gen* menu, press *[ΦM]*. The *[ΦM Devn.]* box will be highlighted.
- (2) Enter the phase modulation deviation value via the numeric key pad and terminate it with the *[rad]* key.
- (3) Switch the ΦM ON or OFF via the *[ΦM ON/OFF]* key. The ΦM information is displayed in the lower half of the screen.

Selecting wideband frequency modulation

- (1) At the *Sig Gen* menu, press [*Wideband FM*]. The [*Wideband FM*] box will be highlighted.
- (2) The value can be changed via the key pad and frequency terminator key. To preserve the widest bandwidth, the control of the wideband FM is carried out in a series of fixed steps and the signal generator automatically displays the calculated fixed step which is closest to the keyed in value. Applying a 1 V RMS sine wave to the rear panel WIDE BAND FM IN socket will produce the indicated deviation.
- (3) Pressing [*AC/DC Coupling*] changes the coupling from AC to DC and vice versa. When the input is DC coupled, small frequency offsets can be reduced by using the nulling facility. Nulling can be effected by pressing [*DCFM Nulling*]. The legend:

*** *DCFM NULLING* ***

appears briefly on the display.

Note...

The [↑] and [↓] keys and the control knob do not operate for wideband FM.

CAUTION

The WBFM socket input impedance is 50 Ω. The DC component of any applied voltage must not exceed 5 V.

Modulation source frequency

- (1) At the *Sig Gen* menu press [*Source Freq.*].
- (2) Enter the required source frequency and terminate the entry with [Hz], [kHz] or [MHz].

Note...

When the modulation source is operating as a continuous signalling tone the [*Source Freq.*] legend is replaced with the [*Tone Number*]. Pressing the key allows a new tone number to be entered.

Source selection - internal

The modulation source may be selected by pressing *[Select Source]*. Sources may be internal or external. If the currently selected source is internal, the *Internal Source Selection Menu* is displayed, giving a choice of six frequencies, F1-F6, see Fig. 3-1-10. The frequency assigned to the highlighted F number may be changed by the numerical key pad and terminated with [Hz], [kHz], [MHz] or [GHz]. Soft keys allow the selection of either a sine or triangular waveform. The selection of sub-audible continuous tones can be achieved by pressing *[CTCSS]*, see 'SIGNALLING'. Pressing *[Mod. Src Phase]* displays the *LF Source Phase Control* menu, see Fig. 3-1-11. The LF source phase angle can be varied from -180° to +180°. The pictograms at the end of each line show a symbolic sine wave when a source is selected. This changes to a triangular wave if *[Triangle Wave]* is selected or a square wave if *[Square Wave]* is selected. These symbols also appear on the main menu. A horizontal bar is shown when a source is not selected or is not available.

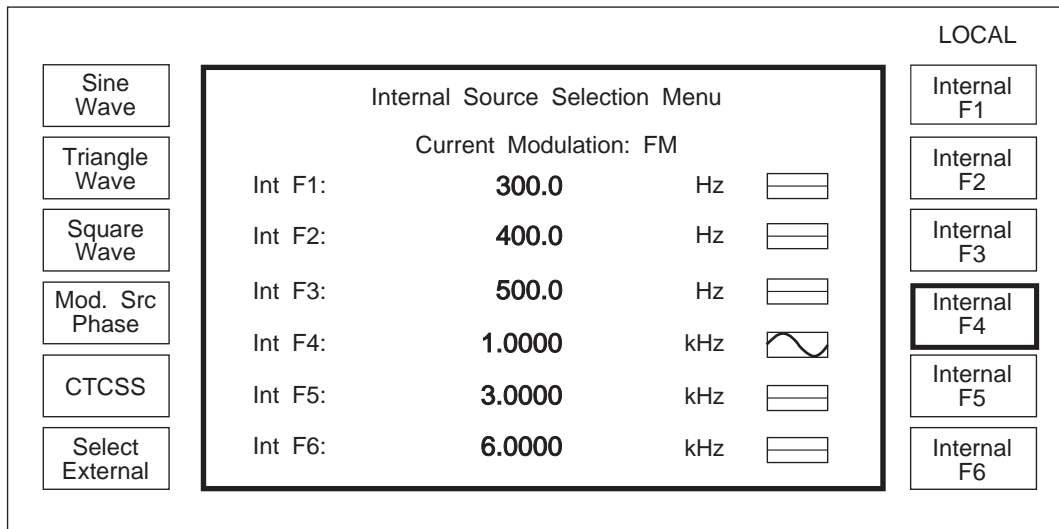
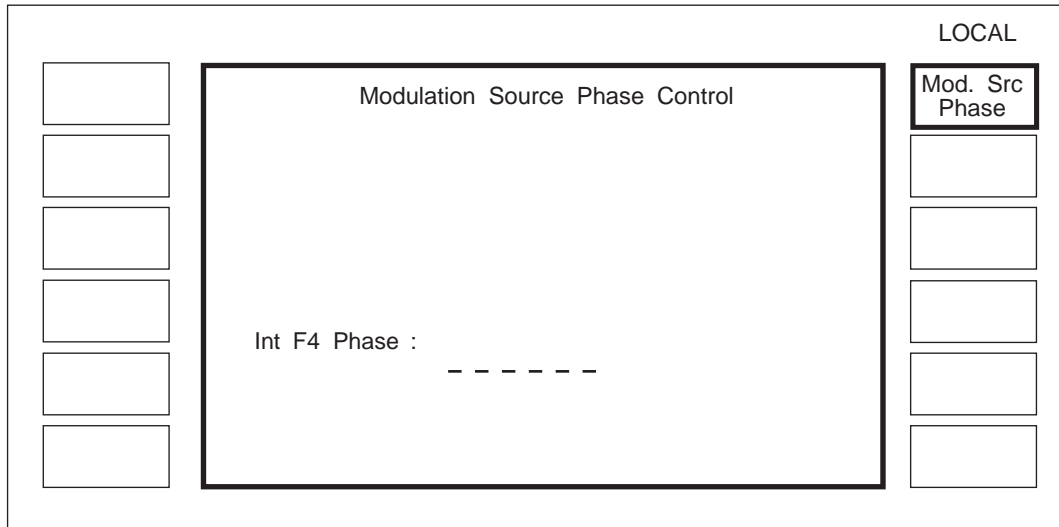

Fig. 3-1-10 Internal source selection menu

C1887

LF phase

When an internal source has been selected, its phase relative to the second modulation oscillator (if fitted) can be changed by pressing [*Mod. Src Phase*] and entering the required value. Where two internal modulation frequencies are active, the starting phase difference between the two signals can be set up and the phase angle is referred to the currently selected oscillator.



C1888

Fig. 3-1-11 LF phase control

Source selection - external

An external source may be selected by pressing *[Select External]*. The *External Source Selection Menu* is then displayed on the screen (This menu is displayed immediately when pressing *[Select Source]* if the currently selected source is external). This menu allows the choice of two input sockets EXT MOD 1 INPUT and EXT MOD 2 INPUT and AC, ALC, or DC coupling by pressing the appropriate soft key. The pictograms at the end of each line show a symbolic arbitrary waveform when an external source is selected. This symbol also appears on the main menu. A horizontal bar is shown when a source is not selected or is not available. When the input is DC coupled, small frequency offsets can be reduced by using the nulling facility. Nulling can be effected by pressing *[DCFM Nulling]*.

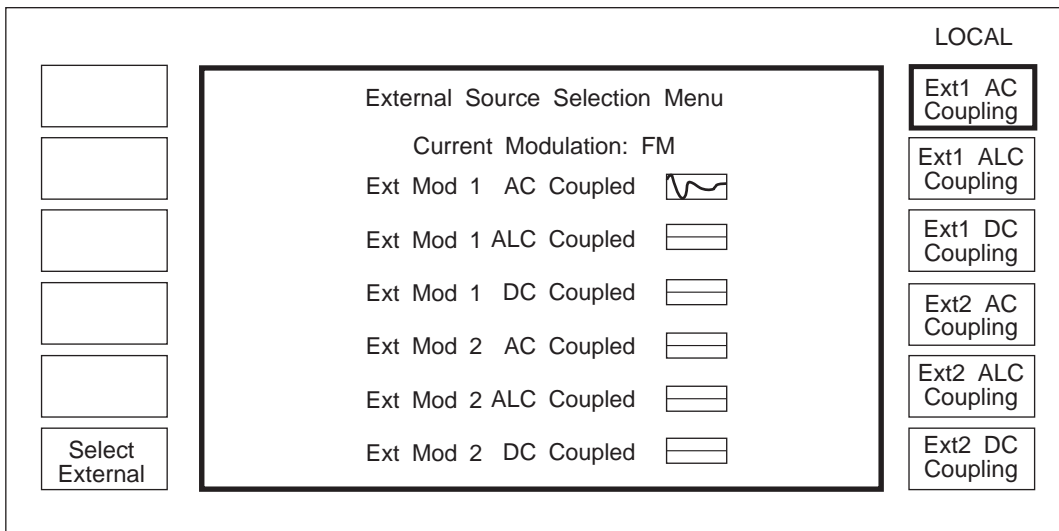

C0007

Fig. 3-1-12 External source selection menu

MODULATION ALC

The automatic levelling control (ALC) is used in conjunction with an external source and can be disabled when not required. To enable the ALC, proceed as follows:

- (1) At the *Sig Gen* menu, press [*Select Source*]. The display will show the *Internal* or *External Source Selection Menu* (Fig. 3-1-10 or Fig. 3-1-13).
- (2) If necessary press [*Select External*] to obtain the *External Source Selection Menu* (Fig. 3-1-13).
- (3) Select the required external source from the options shown, e.g. [*Ext 1 ALC Coupling*] or [*Ext 2 ALC Coupling*]. The pictogram at the end of each line will change from a horizontal line to an arbitrary waveform symbol when the source is selected.
- (4) Return to the *Sig Gen* menu by pressing [SIG GEN]. The legend *Ext Mod 1* (or 2) *ALC coupled* appears at the bottom of the display.
- (5) Apply a signal to the EXT MOD 1 or EXT MOD 2 input socket and vary the level. If the input applied to the external modulation socket is outside the ALC range (at least 0.7 to 1.4 V RMS) *HI LO* will be indicated and an error message will be displayed at the top of the screen. If the level is within the required range, the arbitrary waveform symbol will appear alongside the modulation value.

PULSE MODULATION (applies if Option 002 is fitted)

Enabling the pulse modulation disables the RF ALC system which is used to control the output level from the generator. The signal generator sets the requested RF output level using a digitally derived control signal whose level is equivalent to that which would be generated by the RF ALC system.

The calibration of the RF level can be set up to work in two possible ways. The normal method is that when a new carrier frequency or RF level is entered the RF ALC system is enabled and a CW signal is generated. The generator then sets up the digitally derived control signal so that it is at the same level as the RF ALC control signal and the instrument disables the RF ALC and substitutes the digitally derived signal. The user of the signal generator will observe that when the level or frequency of the generator is changed a CW output burst (at the requested output level) is generated for up to 100 ms.

In some applications, such as live radar testing, the CW burst can cause problems. The alternative mode of operation is to enable a CW Burst Suppression facility. In this mode when pulse modulation is first enabled, a calibration of the digitally derived control signal is performed automatically which generates a tabulation of the RF level against the control signal level. During calibration the RF output is suppressed by the output attenuator. After calibration changes in level or frequency do not generate CW bursts. An RF level recalibration can be performed on demand. When the carrier frequency is changed by more than 15 MHz from the frequency at which the level was calibrated, or the new requested frequency results in a major change of characteristic (such as a VCO change), the RF level display is blanked and an UNCAL annunciator is displayed. Initiating an RF level calibration will restore the RF level display.

Selecting the pulse modulation mode

- (1) Press the *[RF Level Utility]* on the *Utilities Selection Menu 2*. The display will show the *RF Level Utility Menu* shown in Fig. 3-1-34.
- (2) Use the *[CW Burst Control]* key to disable the Burst Suppression mode for normal operation or enable it for Burst Suppression mode.
- (3) Selecting the *[Sig Gen]* key will return the display to the *Sig Gen* menu.

Selecting pulse modulation

From the *Sig Gen* menu press [*Pulse Mod*] to obtain the Pulse Mod display shown in Fig. 3-1-13.

Notes...

The [*RF Level Autocal*] key will only appear if the CW burst suppression mode has been enabled in which case a temporary calibration display will appear for approximately 1.5 s while calibration is undertaken.

Modulation can be enabled with FM but not with AM.

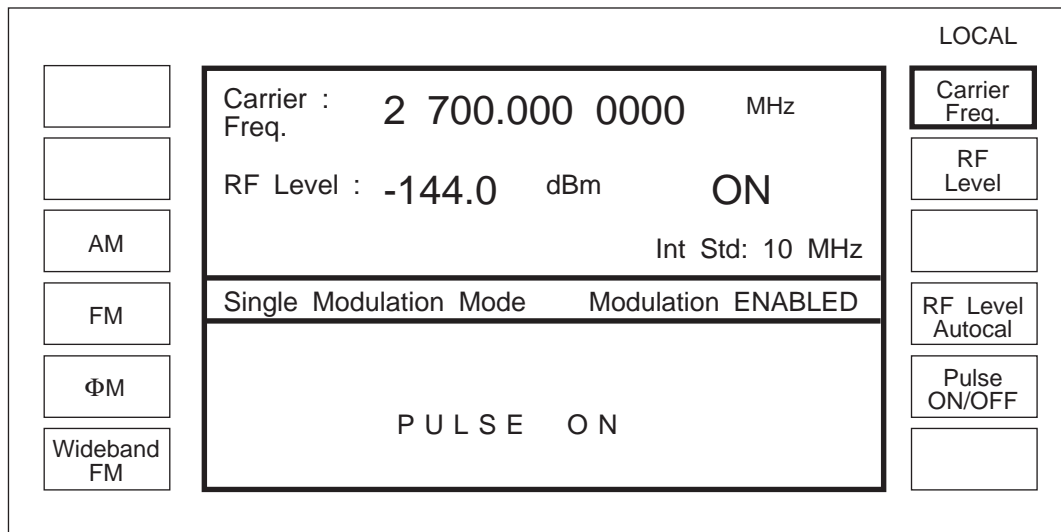

C1626

Fig. 3-1-13 *Sig Gen* menu with pulse modulation selected

The [*Pulse ON/OFF*] key can be used to disable or enable the pulse modulator without enabling the RF ALC system.

The [MOD ON-OFF] key will also disable or enable the modulator; the status being shown on the display.

With the modulation disabled using this key the RF ALC system is operating.

If the CW Burst Suppression mode has been enabled the [*RF Level Autocal*] key can be used to recalibrate the RF output level on demand.

Pulse modulation input level

Switch pulse mod on or off with the [*Pulse ON/OFF*] key. When 'On', the carrier is controlled by the logic level applied to the PULSE INPUT socket mounted on the front panel. A logical '1' (a voltage between 3.5 and 5 V) allows carrier output, a logical '0' (a voltage between 0 and 1.0 V) suppresses it. Turning pulse mod off effectively applies a logical '1' allowing carrier output. Note that the input impedance is 50 Ω.

Low intermodulation mode

When carrying out intermodulation tests the output signal from two signal generators is combined using a resistive or hybrid combiner. If the carrier frequencies are relatively close together each generator will receive an interfering signal from the other source. The RF ALC system will detect a beat frequency equal to the difference in carrier frequencies and attempt to apply AM in order to cancel the signal. In so doing the RF ALC system will generate AM sidebands which are indistinguishable from intermodulation products. By using the low intermodulation mode the RF ALC system can be disabled to prevent the injection of AM sidebands.

If pulse modulation is not fitted proceed as follows:

- (1) At the *Sig Gen* menu press [*Low Intermod*].
- (2) This causes either *Low Intermodulation Disabled* or *Low Intermodulation Enabled* to be displayed in the lower panel.
- (3) Press the [MOD ON-OFF] key to toggle between the enabled and disabled states.
- (4) If an attempt is made to [*Set Steps*] from the Δ menu, the message *Low Intermod: No Steps Allowed* will be displayed.

If pulse modulation (Option 002) is fitted proceed as follows:

- (1) Press the [*Pulse Mod*] key.
- (2) This causes the message *PULSE ON* to be displayed.
- (3) Press the [*Pulse ON/OFF*] key.
- (4) This causes *PULSE OFF* to be displayed together with *Low Intermodulation Disabled* or *Low Intermodulation Enabled* shown in the lower panel.
- (5) Press the [MOD ON-OFF] key to toggle between the enabled and disabled states.
- (6) If an attempt is made to [*Set Steps*] from the Δ menu, the message *PULSE : No Steps Allowed* will be displayed.

Note...

AM is not available in the Pulse Modulation or Low Intermodulation modes of operation.

SIGNALLING

CTCSS

A CTCSS tone is any one of 32 standard sub-audible tones ranging from 67 Hz to 250.3 Hz and would generally be used in conjunction with an audible modulation signal in a composite modulation mode. The procedure for initiating these tones is as follows:

Tone selection

- (1) At the *Sig Gen* menu, press [*Select Source*].
- (2) At the *Internal Source Selection Menu*, press [*CTCSS*]. The *Continuous Tone Selection Menu* is now displayed, see Fig. 3-1-14.
- (3) Key in the required tone number (0 to 15) and press [enter].

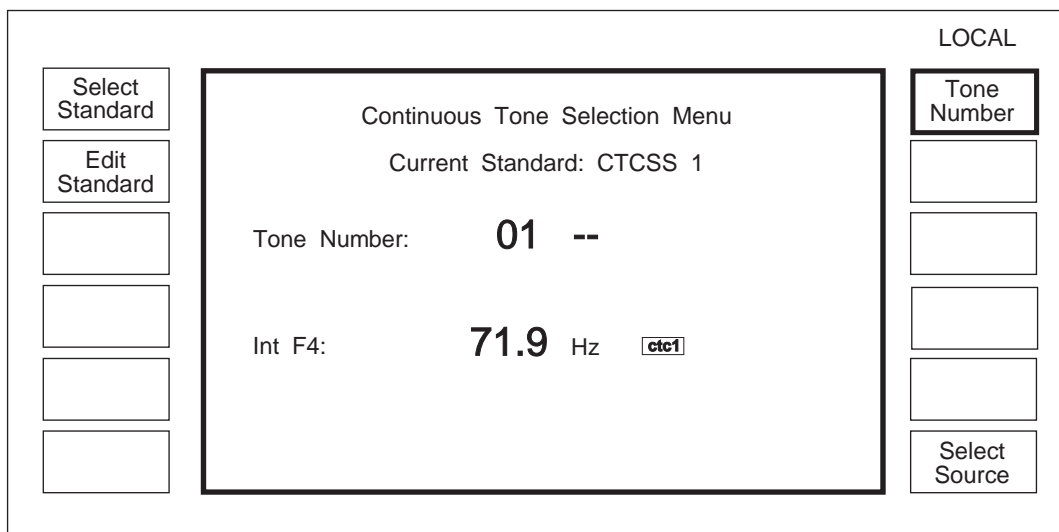

C1889

Fig. 3-1-14 Continuous tone selection menu

Selecting alternative tone standards

A list of the 16 tones of the current standard is available by pressing [*Select Standard*]. This action displays the *Tone Standard Selection Menu* with the current standard highlighted. To select from further lists of 16 tones, press [*CTCSS2*] or [*USER*]. The *Tone Standard Selection Menu* changes to show the new list.

Editing a tone standard

Pressing [*TEMP*] displays a further list of 16 tones set to the default value of 10 Hz. The standard can be edited by selecting [*Edit Standard*] from the menu in Fig. 3-1-14. This gives you the *Continuous Tone Edit Utility* menu.

CTCSS 1, CTCSS 2 or USER can be loaded to TEMP, which is a volatile store of 16 tones set at a default value of 10 Hz at switch on. Tones can then be changed by using [*Tone No*], [*Tone Freq*], [*Next Tone*] or [*Previous Tone*]. When the required changes have been made, the new standard can be saved by pressing [*Store to User*]. USER then becomes a user defined standard.

Note...

Selecting [CTCSS1], [CTCSS2], [USER] or [TEMP] from the *Tone Standard Selection Menu* causes the pictogram in the *Continuous Tone Selection Menu* and the *Internal Source Selection Menu* to change e.g. *ctc1*. The pictogram is repeated in the modulation section of the *Sig Gen* menu.

Sequential calling tones

There are eight sequential calling tone standards available, each having 16 set tones, see *Tone Standard Selection Menu*, Fig. 3-1-18. They are, CCIR, EURO, DZVEI, ZVEI1, ZVEI2, EEA, EIA and NATEL. There is also provision for the user to define sets of user tones in USER1 and USER2. DTMF signalling tones can also be generated if the second modulation oscillator (Option 001) is fitted.

Sequential calling tones are set up from a utility menu, Fig. 3-1-28, and are activated by pressing [Send Tones] which appears on the main menu after the tones have been set up. [Send Tones] also appears on the calling tones menu.

Tone selection

Pressing the [Calling Tones] soft key at *Utilities Selection Menu 1* calls up the *Sequential Calling Tones Utility* menu, see Fig. 3-1-15.

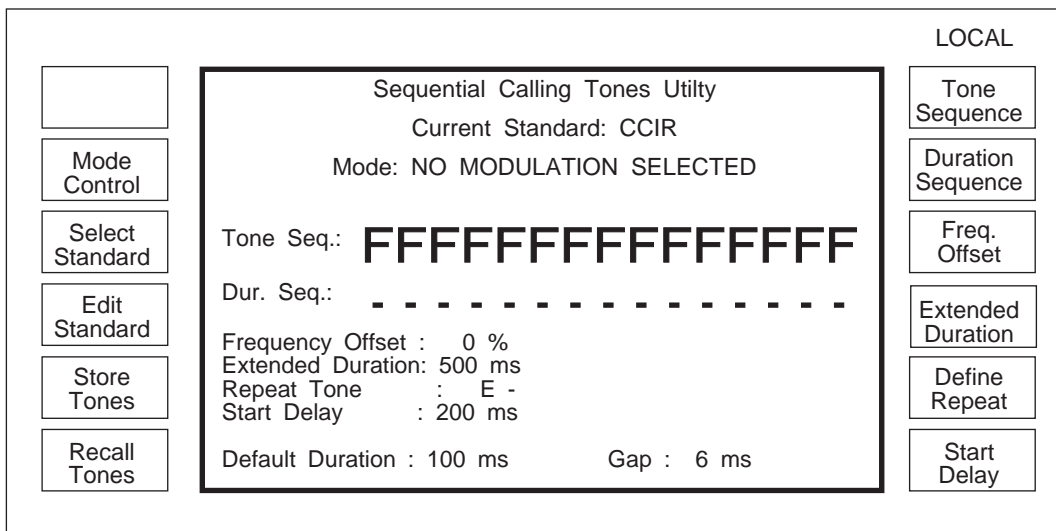

C0010

Fig. 3-1-15 Sequential calling tones utility menu

[Tone Sequence] Pressing this key causes hexadecimal data entry keys to appear at the left-hand side of the menu. To change the sequence, enter the tone numbers via the digits 0-9 on the numerical key pad and the soft keys [A] to [F] and press [enter].

[Duration Sequence] Pressing this key causes [Default Duration] and [Extended Duration] to appear at the left hand side of the menu. Press either key in turn to set the duration of tones in the sequence. A dash (-) indicates the default duration and E indicates an extended duration. These two keys disappear when [enter] is pressed.

[Define Repeat] allows a repeat tone to be defined, by using the [A] to [F] keys and the key pad and pressing enter. For example, if the repeat tone is defined as tone C, the sequence 11111 will be sent as 1C1C1 so that the receiver decoders will sense a change in frequency at the start of each digit sent.

[Freq. Offset] This facility alters the nominal tone frequency by a set percentage (up to $\pm 10\%$) for use in tolerance testing. To change the frequency offset value, select [Freq. Offset] and enter the new value on the key pad. Terminate with the [%] key.

[Store Tones] Up to 20 sequence set-ups can be stored. Use the key pad to enter the store location number and press [enter].

[Recall Tones] To recall a tone sequence, use the key pad to select the required store location and press [enter].

[Start Delay] The delay before the tone sequence starts and the gap between sequences can be adjusted by pressing this soft key, entering the required delay time on the key pad and pressing [ms].

[Mode Control] Pressing this enables the user to assign the calling tones to a selected type of modulation, see Fig. 3-1-17. Modulation, on the selected channel, is turned off when the tones are triggered and restored after the tones have been sent. Modulation on other channels is not affected by the calling tones and this allows sequential signalling tones to be combined with sub-audible tones. [NO Mod.] This option effectively inhibits sequential tones. The tone sequence can be sent between 1 and 9 times, set by [No. of Repeats], every time the [Send Tones] key is pressed. Setting the number of repeats to 10 allows the tones to be sent continually under control of the [Send Tones]/[Stop Tones] key at the main menu.

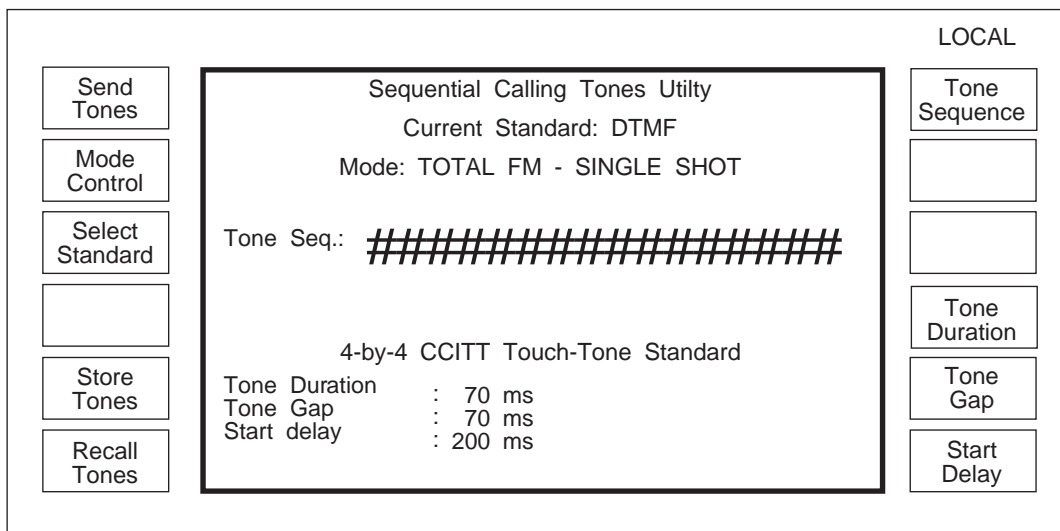

C1890

Fig. 3-1-16 Sequential calling tones utility menu (DTMF mode)

On 2030 series fitted with the second modulation oscillator (Option 001) the DTMF signalling capability is also provided. If this standard is selected then the main menu accessed after pressing the [Calling Tones] soft key at Utilities Selection Menu 1 will be as shown in Fig. 3-1-16. The functions of the soft keys are as follows:

[Tone Sequence] Pressing this key allows a tone sequence to be set up using the digits 0-9 on the numerical key pad and the soft keys [A], [B], [C], [D], [*] and [#]. The sequence entry is terminated by pressing [enter].

[Tone Duration] The default duration of 70 ms for each tone in the sequence can be changed by pressing this key, entering the required duration value and pressing [ms].

[Tone Gap] The default gap duration of 70 ms between each tone in the sequence can be changed by pressing this key, entering the required gap length and pressing [ms].

[Start Delay] The delay before the tone sequence starts and the gap between sequences can be adjusted by pressing this soft key, entering the required delay time on the key pad and pressing [ms].

[Mode Control] Pressing this enables the user to assign the calling tones to a selected type of modulation, see Fig. 3-1-17. Modulation, on the selected channel, is turned off when the tones are triggered and restored after the tones have been sent. Modulation on other channels is not affected by the calling tones and this allows sequential signalling tones to be combined with sub-audible tones. [NO mod] This option effectively inhibits sequential tones. The tone sequence can be sent between 1 and 9 times, set by [No. of Repeats], every time the [Send Tones] key is pressed. Setting the number of repeats to 10 allows the tones to be sent continually under control of the [Send Tones]/[Stop Tones] key at the main menu.

[Select Standard] Selection of alternative signalling standards is achieved by pressing this key to access the *Select Standard Menu*.

[Store Tones] Up to 20 sequence set-ups can be stored. Use the key pad to enter the store location number and press [enter].

[Recall Tones] To recall a tone sequence, use the key pad to select the required store location and press [enter].

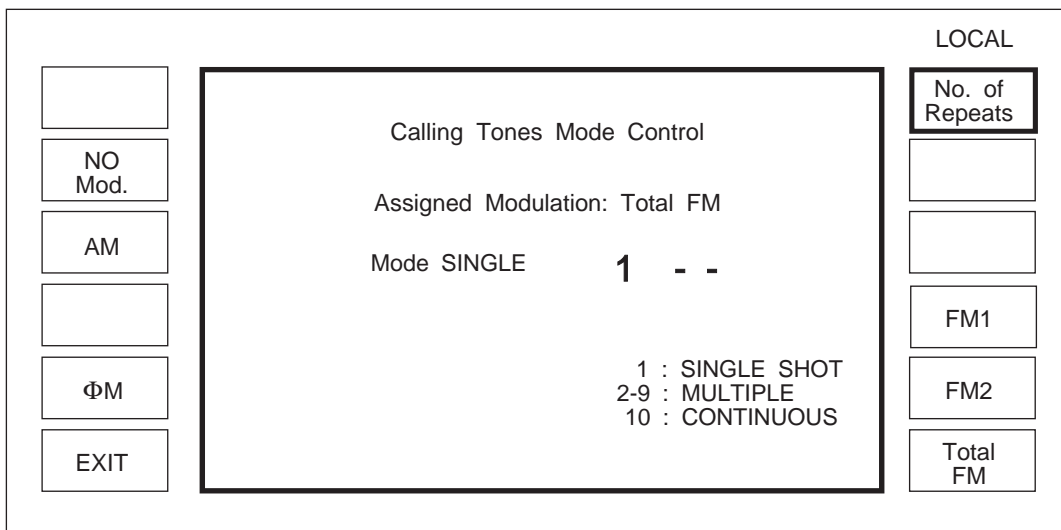

C0011

Fig. 3-1-17 Calling tones mode control menu (with [FM] selected)

Selecting alternative tone standards

The [*Select Standard*] key causes the *Tone Standard Selection Menu* to be displayed, see Fig. 3-1-18.

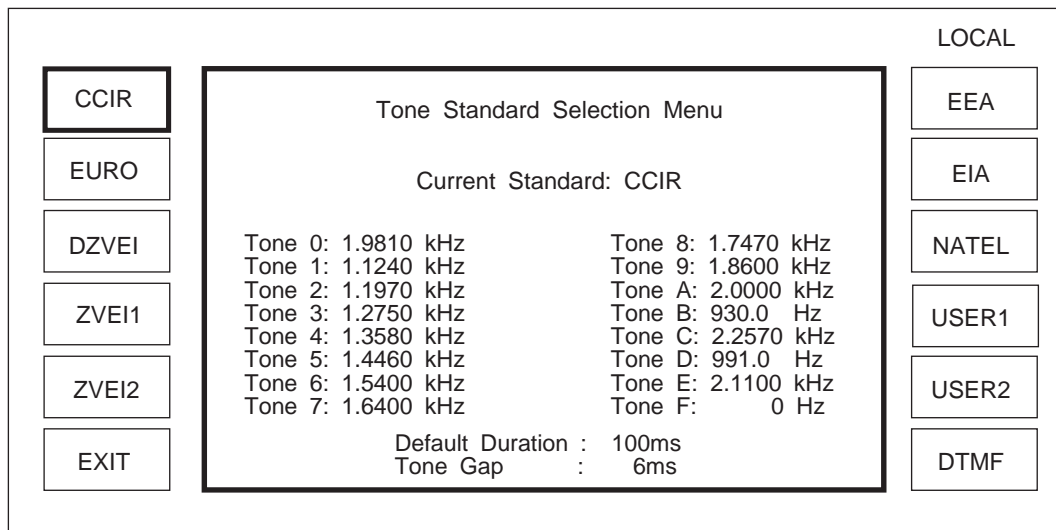

C0012

Fig. 3-1-18 Tone standard selection menu

The tone sequential standard to be used is selected by pressing the appropriate soft key. This menu also shows the frequency and timing characteristics for each tone in the standard. User 1 and User 2 are user defined tone standards stored in non-volatile memory. The [*DTMF*] soft key only appears on the display if the instrument is fitted with a second modulation oscillator (Option 001 fitted). If only a single oscillator is fitted the [*DTMF*] key is left blank

Editing a tone standard

Pressing the [*Edit Standard*] key when in the *Sequential Calling Tones Utility* menu (Fig. 3-1-15) will produce the *Edit Sequential Tones* Utility, see Fig. 3-1-19, which allows a user defined tone system to be set up.

All editing is carried out in a tone standard called TEMP which is not stored beyond switch off. To ensure that the alterations are available for future use the newly defined tone standard must be saved to non-volatile storage in either USER1 or USER2.

The editing facility allows the user to define the frequency of each of the 16 tones in the system and to set the default duration of each tone in the sequence and the gap between tones (if any). All other settings are handled in the normal *Sequential Tones Utility* menu.

The currently selected tone standard may be copied into the TEMP working space using the top left soft key (shown [*CCIR to TEMP*] in Fig. 3-1-19) and often this is a convenient way to start, particularly when the user defined system is similar to one of the standard systems.

To edit the system in TEMP use [*Tone Number*] to select the number of the tone to be edited (0 to 15) and after pressing [*Tone Freq.*] enter the new frequency to be assigned to this tone number. Select other tones in the system by means to the [*Tone Number*] key or use the [*Next Tone*] and [*Previous Tone*] keys to step through the list. Enter the frequencies of the tones and then use [*Default Duration*] and [*Tone Gap*] to set the times in milliseconds for the default duration of each tone and the gap between each tone.

Finally store the user defined tone system parameters in USER1 or USER2 by pressing [Store to USER1] or [Store to USER2].

Note that when using the DTMF tone signalling capability no editing facility is provided. Changes to the default settings are made directly on the *Calling Tones Utility Menu*.

CCIR to TEMP	Edit Sequential Tones Standard	LOCAL
[]	Tone Number: 0 - -	Tone Number
Store to USER1	Tone Frequency : 10.0 Hz	Tone Freq.
Store to USER2	Default Duration : 100 ms	Default Duration
[]	Tone Gap : 0 ms	Tone Gap
EXIT		Next Tone
		Previous Tone

C3319

Fig. 3-1-19 Edit sequential tones standard menu

INCREMENTING (using Δ)

Displaying shifts

Press the [Δ] hard key. The total shift menu is displayed as shown in Fig. 3-1-20. This menu displays the difference between the current value and the keyed-in value. Parameters can be incremented or decremented by using the [↑] or [↓] key or the control knob, see 'Using the control knob' on Page 3-1-11. To cancel any changes made by the rotary control or the ↑/↓ keys, press [Return Value]. This will restore the setting of the selected parameter to the keyed-in value, i.e. the indicated shift will return to zero. Pressing [Transfer Value] transfers the current value to the *Sig Gen* menu as the keyed-in value.

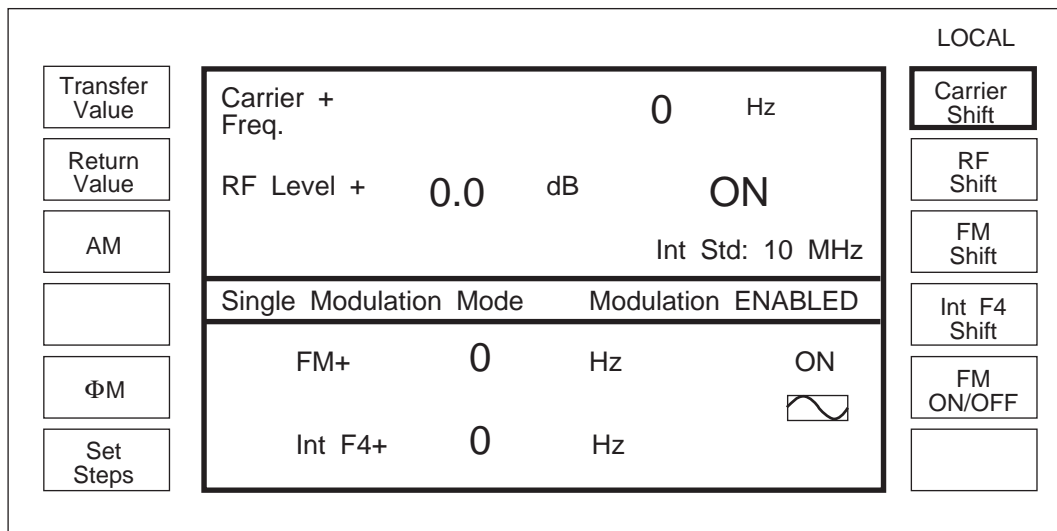

Fig. 3-1-20 Total shift menu

Setting increment values

- (1) From the total shift menu select [Set Steps]. The screen shows the currently set step sizes.
- (2) Select [Carrier Step], enter the value on the key pad and press a terminator key. The step value will appear on the screen.
- (3) Return to the *Sig Gen* menu by pressing [SIG GEN].
- (4) Using the ↑/↓ keys respectively will now increment or decrement the carrier frequency by the set value.
- (5) [RF Level Step], [AM Step] and [Source Step] values can be entered in the same way.

Note...

Wideband FM and Pulse modulation parameters cannot be incremented in this manner.

SWEEP

The sweep capability allows the comprehensive testing of systems, as measurements at single points will not necessarily give an overall indication of the performance. The sweep function is specified by the following parameters:

- Start value
- Stop value
- Number of steps
- Time per step

Up to five individually adjustable markers may be set. Each marker can be turned on and off separately. Sweep functions available are:

- Carrier frequency with or without modulation
- RF level
- Internal modulation rate
- LF frequency (if in LF generator mode)
- LF level (if in LF generator mode).

The sweep can be operated in single shot or continuous modes with the start command triggered by a key press, an external pulse or GPIB control. Once started, the sweep can be stopped at any time when the display will indicate the current parameter value. The sweep can be used with oscilloscopes, X-Y display units and X-Y plotters by connecting the display unit X input to the SWEEP RAMP output on the rear panel.

A sweep routine is set up as described in the following paragraphs:

Sweep type

(1) Press the [SWEEP] hard key. The sweep parameters display, with soft key options, appears on the screen, see Fig. 3-1-21.

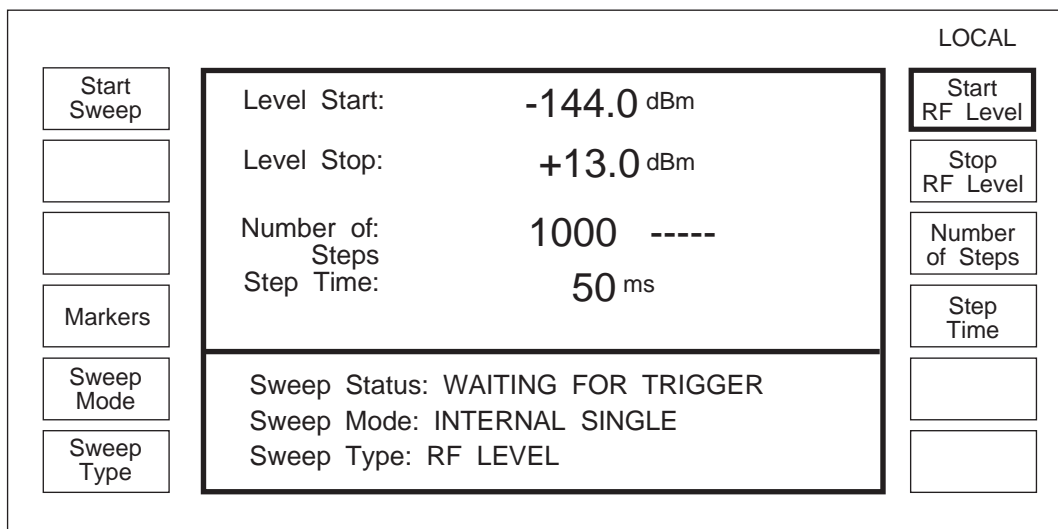

C1899

Fig. 3-1-21 Sweep parameters display

(2) Press [Sweep Type]. The Sweep Type Menu is displayed, see Fig. 3-1-22.

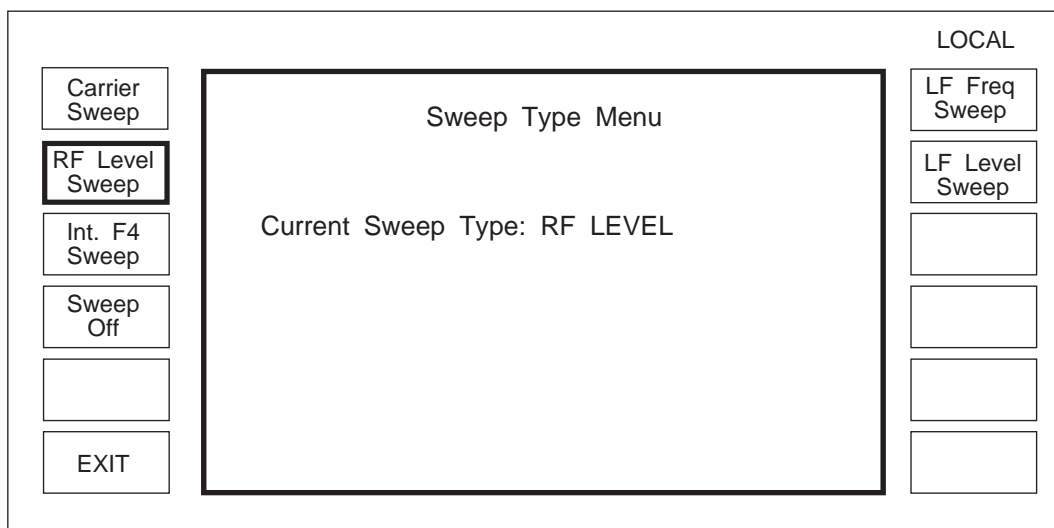

C0052

Fig. 3-1-22 Sweep type menu

The instrument must be in the LF generator mode before an LF frequency sweep and LF level sweep can be initiated.

Modulation required during sweep should be entered before putting the instrument in the sweep mode.

- (3) Select the required sweep type by pressing the appropriate soft key, e.g. [*Carrier Sweep*]. The Sweep Type screen changes to confirm the selection.
- (4) Press [*EXIT*] or [*SWEEP*] to return to the sweep parameters display.

Sweep mode

- (1) At the sweep parameters menu, press [*Sweep Mode*]. The *Sweep Trigger Mode Menu* is displayed, see Fig. 3-1-23.

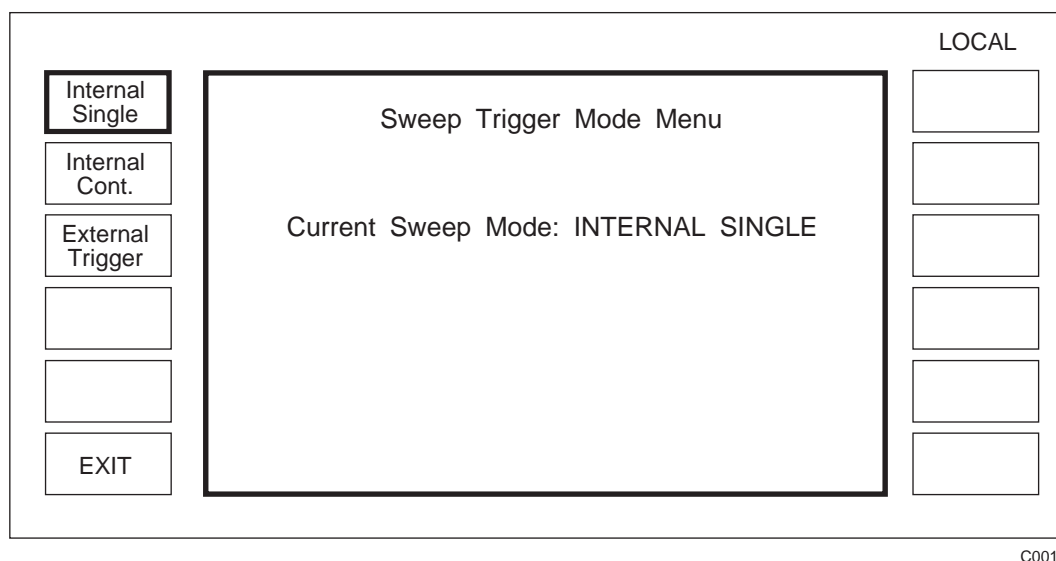

C0017

Fig. 3-1-23 Sweep trigger mode menu

- (2) Select the sweep mode, [*Internal Single*], [*Internal Cont.*], or [*External Trigger*].
- (3) Press [*EXIT*] to return to the sweep parameters display menu.
- (4) If [*External trigger*] is selected, press [*UTIL*], select [*Utils. Menu 1*] and from this menu press [*External Trigger*]. The *External Trigger Selection Menu* will be displayed. Then press [*SWEEP*] to return to the Sweep Parameters display.

Sweep parameter entry

Start value

- (1) Select the appropriate soft key to enter the start value, e.g. [*Start Freq*].
- (2) Enter the required start value via the numerical key pad and the appropriate terminator key.

Stop value

- (1) Select the appropriate soft key to enter the stop value, e.g. [*Stop Freq*].
- (2) Enter the required stop value via the numerical key pad and the appropriate terminator key.

When carrier frequency parameters are entered, the instrument calculates all the individual step values together with any level and modulation correction factors. While this process is taking place, the sweep status line changes to indicate 'CALCULATING SWEEP'.

Number of steps

- (1) Select *[Number of Steps]*.
- (2) Enter the number of steps via the numerical key pad and the [GHz/V/enter] terminator key.

Note...

If an inappropriate number of steps is selected, the instrument will automatically choose a more reasonable value. The number of steps available depends on the operating mode and the maximum values are:

- 250 for carrier frequency with FM, ΦM or Wideband FM enabled
- 1,000 for carrier frequency without FM, ΦM or Wideband FM enabled.
- 10,000 for RF level, RF modulation frequency, LF frequency and LF level.

Step time

- (1) Select *[Step Time]*.
- (2) Enter the step time via the numerical key pad and the [MHz/mV/ms] terminator key.

Markers

A facility exists for producing markers, controlled by the *Sweep Markers Menu*, see Fig. 3-1-24.

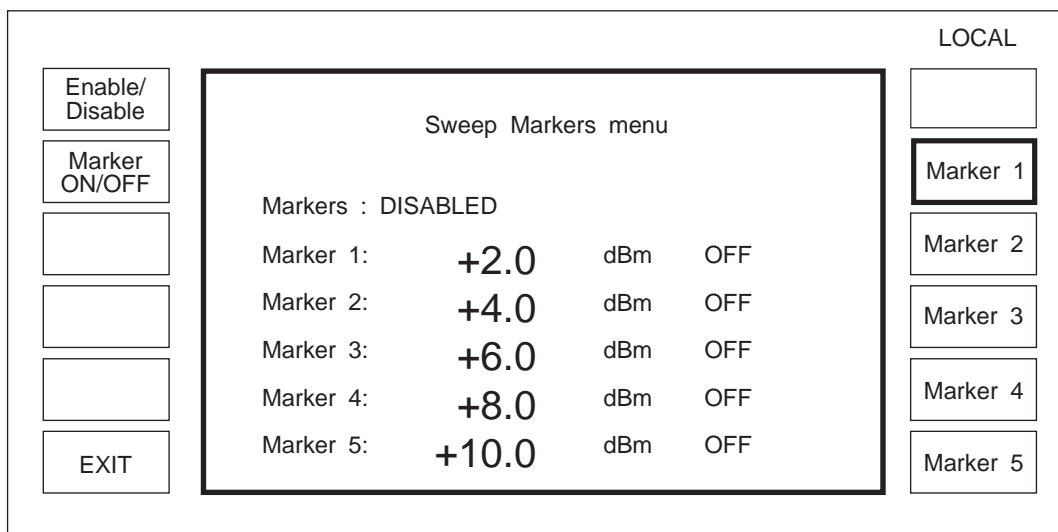

C1891

Fig. 3-1-24 Sweep markers menu

To set a marker, press one of the marker soft keys e.g. *[Marker 3]*, enter the required value on the key pad and terminate with the appropriate units hard key. Turn the marker ON using the *[Marker ON/OFF]* key. When all markers have been entered use the *[Enable/Disable]* key to activate the marker output on the rear panel. The marker output produces a positive going pulse with a duration of one sweep step when the sweep passes a marker value.

Sweep control

Starting the sweep

From the sweep parameters menu, press *[Start Sweep]*. The single sweep status line display changes from *WAITING FOR TRIGGER* to *SWEEPING* and a solid bar increments to show the sweep progression, see Fig. 3-1-25.

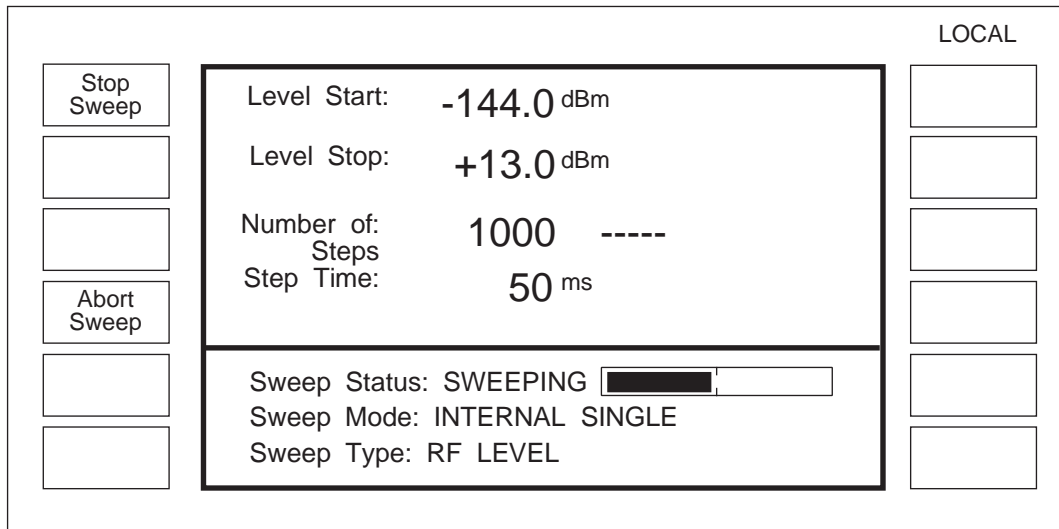

C1900

Fig. 3-1-25 Sweep in progress

Note...

When the sweep is in progress, all the hard keys are disabled and *[Stop Sweep]* and *[Abort Sweep]* soft keys are active.

Stopping the sweep

Press *[Stop Sweep]*. The sweep stops and the menu presents the opportunity to press: *[Reset Sweep]* to change the sweep parameters, or *[Continue Sweep]* to continue the sweep, or

[Transfer] to transfer the current value of the swept parameter as the last keyed in value in the [SIG GEN] or [LF]([LF Gen]) mode, see Figs. 3-1-26 and 3-1-27. When the sweep is in the paused state, the [↑] and [↓] keys can be used to step the parameter up or down. The sweep can then be continued by pressing *[Continue Sweep]*.

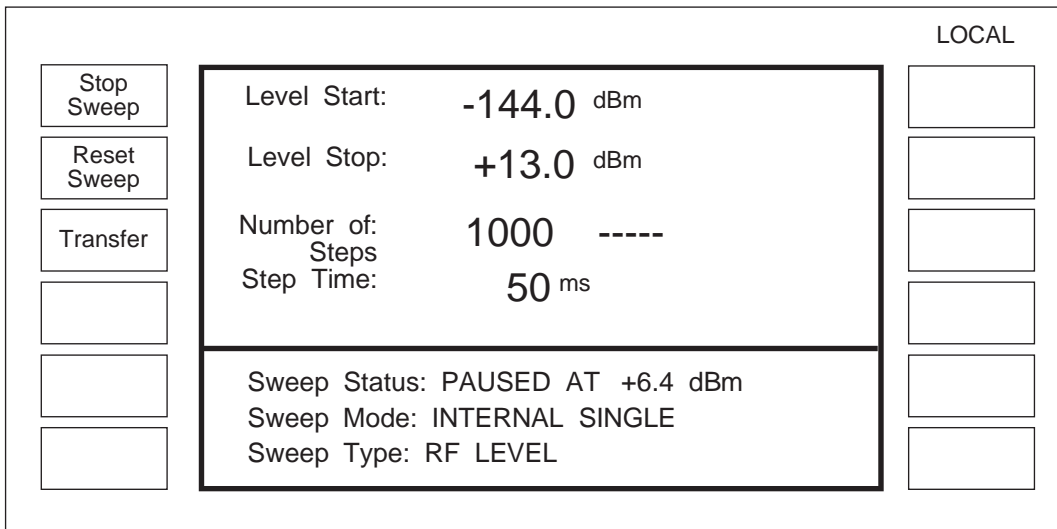

C1901

Fig. 3-1-26 Sweep stopped

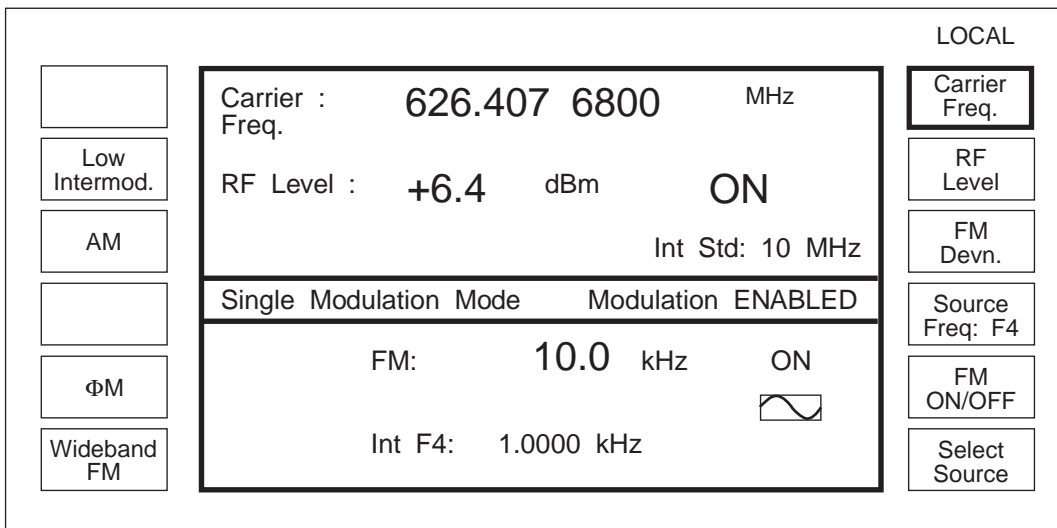

C1902

Fig. 3-1-27 RF level transferred

Aborting the sweep

Press *[Abort Sweep]*. The sweep is reset and the RF (or LF) signal is removed from the appropriate output socket. The *Sweep Parameters Menu* as shown in Fig. 3-1-21 is displayed. If the sweep is restarted with the signal disabled, the *[Abort Sweep]* key is not displayed thus giving the user an indirect indication that no signal is being output from the instrument.

UTILITIES

The utilities options are accessible from two primary menus, *Utilities Selection Menu 1* and *Utilities Selection Menu 2*. When a selection is made from either of these menus and [UTIL] is subsequently pressed, the primary menu is re-displayed. However, if instead a selection is made and then one of the other hard keys e.g. [SWEEP] is pressed, pressing [UTIL] subsequently once returns to the sub-menu, pressing it again returns to the primary menu. This provides an operating short-cut in that it allows a sub-menu to be re-accessed without first having to go again through the primary menu. This scheme does not apply to the [Time & Date] or to the [Set Time & Date] soft keys. The display for *Utilities Selection Menu 1* is shown in Fig. 3-1-28. To obtain *Utilities Selection Menu 2* from the menu, press [Utils. Menu 2].

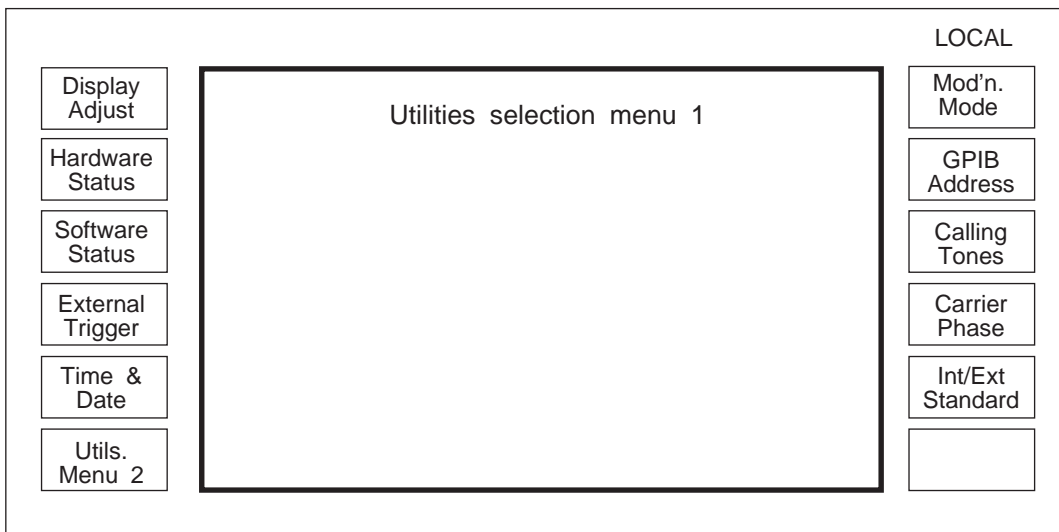

C0022

Fig. 3-1-28 Utilities selection menu 1

Adjusting the display

To adjust the display, press *[Display Adjust]*. The *Display Adjust* menu is displayed on the screen, see Fig. 3-1-29. The backlight, which is on when the instrument is switched ON, can be toggled ON or OFF using the *[Display ON/OFF]* key, and when ON can be varied in brightness by *[Dim]*, *[Medium 1]*, *[Medium 2]* and *[Bright]*. Contrast is adjusted with the control knob. Once adjusted, the LCD setting can be stored in the non-volatile memory by pressing *[Save LCD Setting]*. The instrument always activates the backlighting whenever it is switched on.

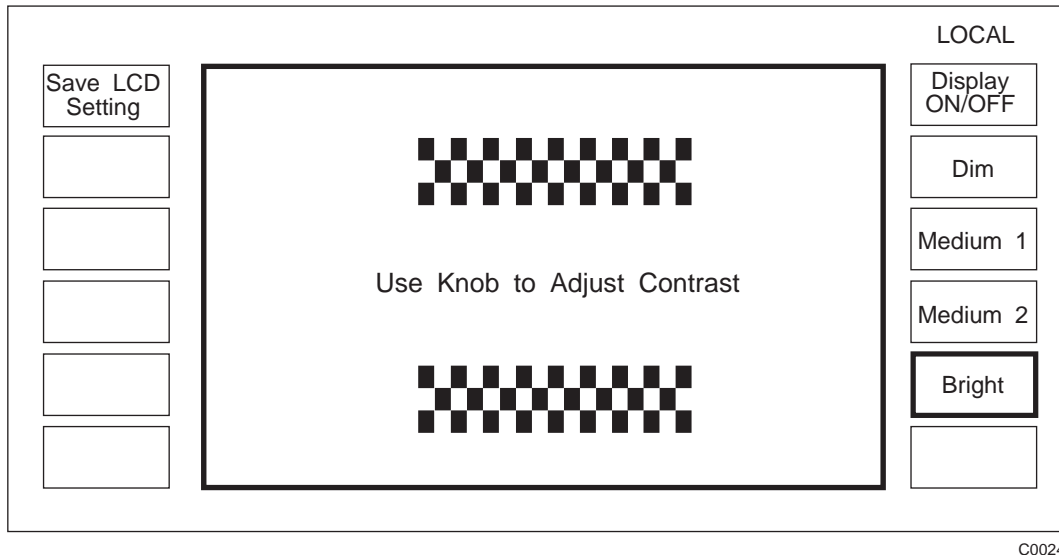

Fig. 3-1-29 Display adjust menu

Hardware information

To obtain a description of the instrument hardware, press *[Hardware Status]* and the following information is displayed:

Instrument type (e.g. 2031)
 Serial no. (e.g. 1543256/045)
 Options fitted (e.g. SECOND LF OSC.)
 Attenuator type and serial number.

For attenuator calibration information, refer to the Service Manual.

Software information

To obtain a description of the instrument software, press *[Software Status]* and the following information is displayed:

Software Version Number e.g. 2.001
 Part number e.g. 44533/366
 GPIB address e.g. 07

External trigger

The external trigger facility allows the rear panel TRIGGER input to be set up so as to initiate a defined change in the generator setting. To define the function press [*External Trigger*]. The display changes to show the *External Trigger Selection Menu* which has the following options:

[<i>Sweep Start</i>]	Starts the external sweep.
[<i>Sweep Step</i>]	Goes to next step of external sweep.
[<i>Send Seq Tones</i>]	Equivalent to [<i>Send Tones</i>] on main menu.
[<i>Recall Up</i>]	Recall next store.
[<i>Recall Down</i>]	Recall previous store.
[<i>No Ext. Trigger</i>]	Trigger ignored (default)

The external TRIGGER input requires a TTL type input and includes an internal pull-up resistor to +5 V. A switch closure to ground or an applied voltage transition from +5 V to 0 V on the rear panel socket initiates the defined trigger action.

Setting the modulation mode

Modulation mode selection allows the generator to be configured to provide carriers modulated by one, two or four (2 internal and 2 external) modulation sources.

Press [*Mod'n Mode*] to display the *Modulation Mode Selection Menu*, choose the type of modulation required by pressing [*Single*], [*Dual*], [*Comp*] or [*Dual Comp*], see 'Modulation mode selection' above.

Setting the GPIB address

Press [*GPIB Address*] to display the *GPIB Address Change Menu*. To change the address, enter the address, in the range 0-30, via the numerical key pad and press [enter]. The data is then saved automatically in the non-volatile memory. For information on operating the instrument via the GPIB, refer to Chapter 3-2.

Sequential calling tones

Sequential calling tones are set up from a utility menu, Fig. 3-1-28, and are activated by pressing [*Send Tones*] which appears on the main menu after the tones have been set up. [*Send Tones*] also appears on the calling tones menu. Pressing the [*Calling Tones*] soft key at *Utilities Selection Menu 1* calls up the *Sequential Calling Tones Utility* menu, see 'SIGNALLING'.

Carrier phase adjustment

Pressing [*Carrier Phase*] displays the *Carrier Phase Control Menu*. To advance or retard the carrier phase (with respect to its current phase) in steps of $\pi/128$ radians, approximately 1.4° , rotate the control knob clockwise to advance the phase and counter-clockwise to retard the phase.

Selection of frequency standard

Pressing *[Int/Ext Standard]* changes the menu to display the *Frequency Standard Selection Menu* which controls the internal/external frequency standard facilities. The signal generator can be set to operate from an external standard or from the internal standard with or without the standard being provided on the rear panel *FREQ STD IN/OUT* connector.

The menu has the following options:

<i>Output DISABLED</i>	Internal standard disabled at the <i>FREQ STD IN/OUT</i> connector.
<i>1 MHz Int. Std.</i>	Internal standard with an output at the selected frequency on the <i>FREQ STD IN/OUT</i> connector.
<i>5 MHz Int. Std.</i>	
<i>10 MHz Int. Std.</i>	
<i>1 MHz Ext. Std.</i>	Accepts an external frequency standard at the selected frequency on the <i>FREQ STD IN/OUT</i> connector.
<i>5 MHz Ext. Std.</i>	
<i>10 MHz Ext. Std.</i>	

These settings are saved in non-volatile memory to ensure that the settings are recalled when power to the instrument is restored.

Selection menu 2

Press *[Utils. Menu 2]* from *Utilities Selection Menu 1*. The display now changes to show *Utilities Selection Menu 2*, see Fig. 3-1-30. This menu allows access to the protected data. Utilities on this menu have either 1st or 2nd level protection.

If the instrument is locked, the appropriate level must be unlocked otherwise the utility will only be usable in a read only mode. To change parameters, the function must be unlocked. The procedure is:

[UTIL] ⇒ [Utils. Menu 2] ⇒ [Lock & Unlock] ⇒ Function Unlocking Utility menu ⇒ [Unlock Level 1] or, for servicing, [Unlock Level 2].

The correct password must be entered. Many of these activities are intended for use in servicing and are described in the Service Manual.

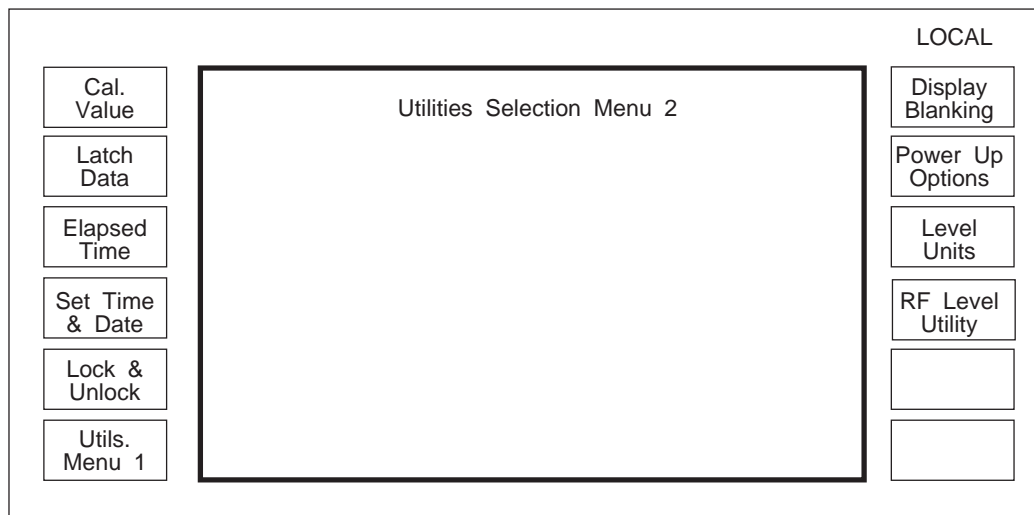

C0939

Fig. 3-1-30 Utilities selection menu 2

Calibration

Pressing [*Cal. Value*] brings the *Calibration Utilities Menu* to the display, see Fig. 3-1-31. This menu shows when the last complete check was made and when the next calibration check is due. It also shows the date on which the individual items were adjusted. It is possible to inspect the calibration value of these items but calibration cannot be carried out unless the protection facility is unlocked at Level 2. Full details regarding calibration can be found in the Service Manual.

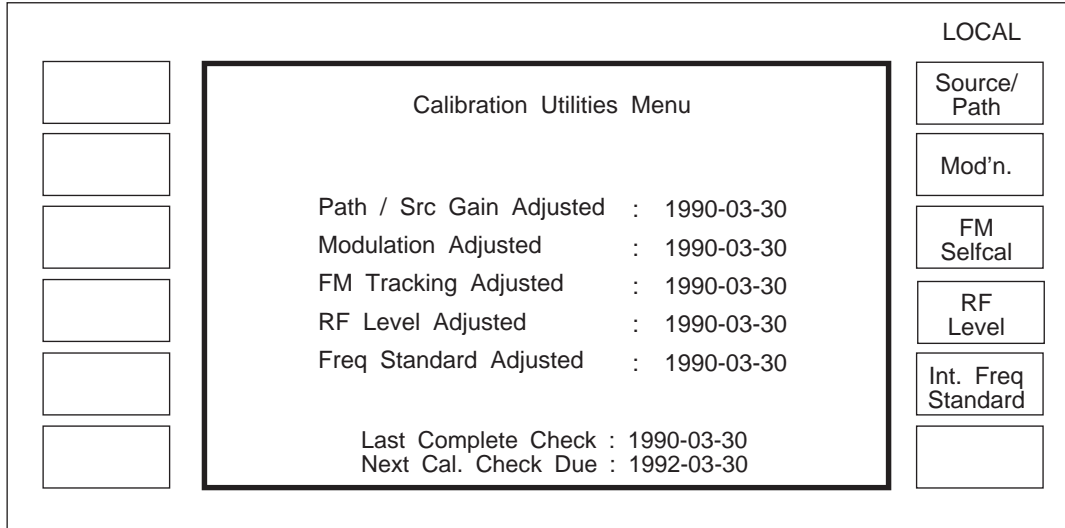

C0026

Fig. 3-1-31 Calibration utilities menu

Latch data

The latch data menu is intended for use as a diagnostic aid by allowing data to be sent to latches within the instrument. For further information consult the Service Manual.

Elapsed time

The elapsed time facility displays the number of operating hours since the function was last reset. Pressing [*Elapsed Time*] displays the number of operating hours and the date on which the function was last set to zero. This facility can be used to assess the instrument's operational reliability and utilisation.

Locking and unlocking

Press [*Lock & Unlock*]. When Level 1 and Level 2 are both locked, the menu displays three soft keys:

Unlock Level 1
Unlock Level 2
Serial No. Set

Press [*Unlock Level 1*] and the message *Enter 4 Digit Password:* will appear on the display. Level 1 is unlocked by entering the 4 digits on the key pad and pressing [enter]. The menu will change and two soft keys, [*Lock level 1*] and [*Lock Keyboard*], will appear on the left-hand side. The default password is 1234. If this password is not recognised by the instrument, the password has been changed by your calibration/repair department personnel who should be consulted for further information. [*Unlock Level 2*] is only used during servicing. Refer to the Service Manual for details.

Setting time and date

Unlock to Level 1 (see 'Selection menu 2' and 'Locking and unlocking' above). Set the time and date by pressing *[Set Time & Date]* at *Utilities Selection Menu 2*. The screen shows the current time, date and day of the week. The time shown does not change during display. The clock is powered by a rear panel battery, see Chap. 2, 'BATTERY REPLACEMENT'.

[Set Time] Press this key to set the time. Using the key pad enter the hour and minutes (24 hour clock). Separate the hour and minutes fields by a hyphen, e.g. 21-30. Terminate the entry by [enter] which starts the clock.

[Set Date] Press this key to set the date (in ISO format). Using the key pad enter the year, month and day. Separate the year, month and day fields by a hyphen e.g. 1992-04-23. Terminate the entry by [enter]. The day of the week is automatically determined when the date is set.

Keyboard locking

Unlock to Level 1, see 'Selection menu 2' and 'Locking and unlocking' above. Keyboard operation is disabled by pressing *[Lock Keyboard]*. The instrument automatically returns to the main menu which indicates the locked status by displaying a key-shaped icon in the top left-hand corner of the display. The keyboard can be re-enabled by entering the 4 digit password for Level 1 using the key pad and pressing [enter]. The keyboard status is saved in the non-volatile memory.

Display blanking

To prevent sensitive data from being displayed, the 2030 Series Signal Generators include a display blanking facility. This allows various parts of the display to be replaced by a series of dashes so that values entered by the user or recalled from the memory will not be visible. The instrument must be unlocked to Level 2 to enable or disable this facility. Consult the Service Manual for further information.

Power up options

Unlock to Level 1, see 'Selection menu 2' and 'Locking and unlocking' above. Two options are available by pressing *[Power Up Options]* at *Utilities Selection Menu 2*. These options are *[Factory]* and *[Memory]*. When *[Factory]* is pressed, the factory set power up state is recalled. Pressing *[Memory]* causes *[Memory Number]* to appear at the right-hand side of the menu. To change the power up state of the instrument to a particular setting, enter the memory number of the full store on the key pad and press [enter].

RF level units

RF output level units can be altered using the *[Level Units]* key. The level units may be entered as an EMF or PD, and the logarithmic units can be referred to volts (dBV), millivolts (dBmV), microvolts (dB μ V) or to 1 milliwatt into 50 Ω (dBm). Select the units by pressing *[Level Units]* which displays the *RF Level Units Selection Menu* shown in Fig. 3-1-32.

To change the default RF level units shown at switch on, first unlock the instrument to Level 1. This causes an additional soft key to be displayed in the top left box (see Fig. 3-1-32). Select the required RF level units and press the additional *[Save RF Units]* key to save these as the default units.

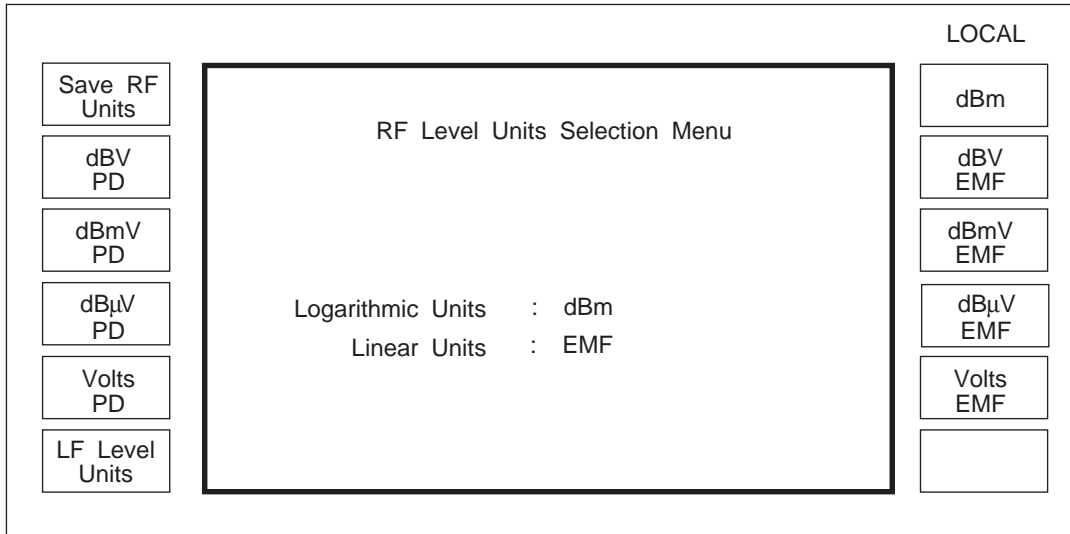

C0488

Fig. 3-1-32 RF level units selection menu (shown unlocked to level 1)

LF level units

LF level logarithmic units may be referenced to 1 volt EMF (dBV EMF), 1 millivolt EMF (dBmV EMF) or 1 milliwatt into 600 Ω (dBm). Linear units are always set EMF values.

Select the units by pressing the *[LF Level Units]* soft key on the *RF Level Units Selection Menu* which calls up the *LF Level Units Selection Menu* shown in Fig. 3-1-33.

To change the default LF level units shown at switch on, first unlock the instrument to Level 1. This causes an additional soft key to be displayed in the top left box (see Fig. 3-1-33). Select the required LF level units and press the additional *[Save LF Units]* key to save these as the default units.

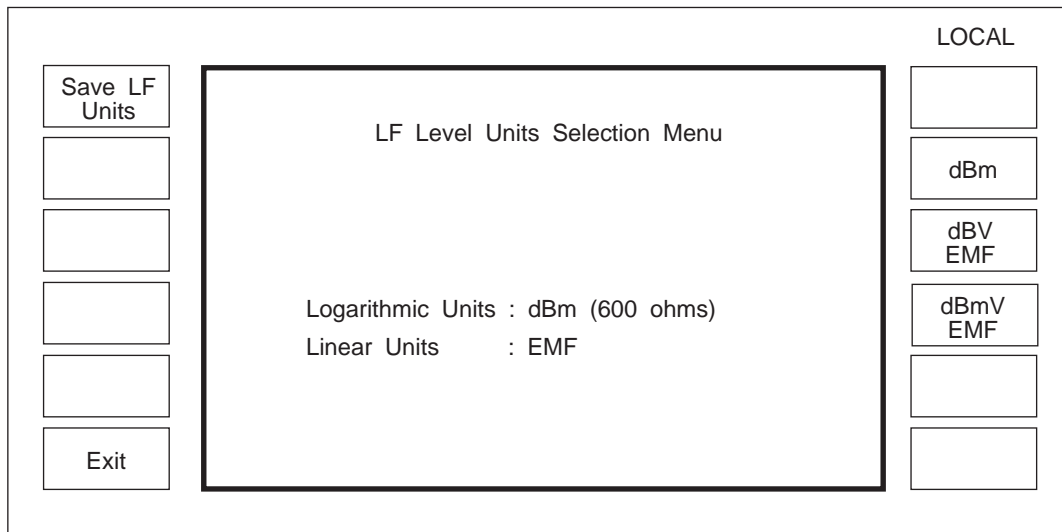

C0328

Fig. 3-1-33 LF level units selection menu (shown unlocked to level 1)

RF level utility

Selecting [*RF Level Utility*] from the *Utilities Selection Menu 2* displays the *RF Level Utility Menu* shown in Fig. 3-1-34.

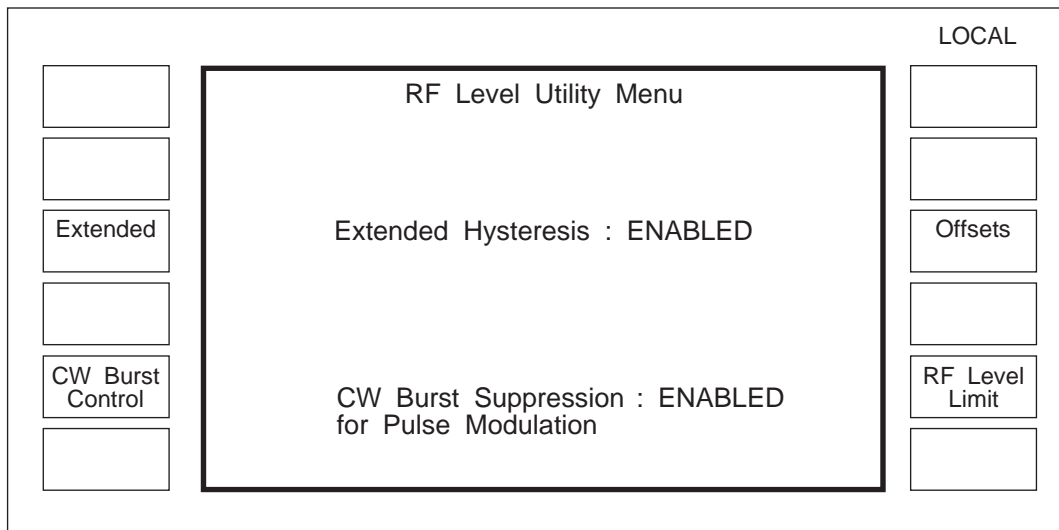

C1892

Fig. 3-1-34 RF level utility menu
 ([*CW Burst Control*] and associated text only appears when Option 002 is fitted)

Extended hysteresis

Pressing the [*Extended*] soft key toggles the status (Enable/Disable) of extended hysteresis. When enabled, this provides an electronic level function which uses the internal D/A converter, rather than the attenuators, to provide an uninterrupted (glitch-free) level control. This increases the electronic level control range to +12 to -18 dB. A *+HYST* or *-HYST* message is displayed on the *Sig Gen* menu to indicate when in hysteresis and in which direction.

During normal operation the RF output is controlled as shown in Fig. 3-1-35 by electronically controlling the output level over a limited range (normally approximately 0 to +6 dBm) and switching in 6 dB attenuator pads to provide lower RF levels.

When the hysteresis function is enabled and a keyboard entry of the RF level is made, the signal generator sets the level in the normal way. However, when the rotary control is enabled and used to adjust the RF level, the normal attenuator changes are suppressed. When the level is increased, the attenuator change is suppressed for 6 dB above the normal range and *+HYST* is displayed. Similarly, when the level is reduced attenuator changes are suppressed for 12 dB below the normal range and *-HYST* is displayed. When the extended hysteresis range is exceeded the attenuator and the electronic control are reset to values corresponding to the normal operation of the generator. An example of extended hysteresis operation is shown in Fig. 3-1-36.

With the rotary control in use in the hysteresis range of operation, the generator can be instructed to set the RF level to the same value, but set using the [V], [mV], [μ V] or [dB] keys. This is a useful facility if the user is investigating squelch systems and wants to ensure that varying the level around the current value will not result in an attenuator change.

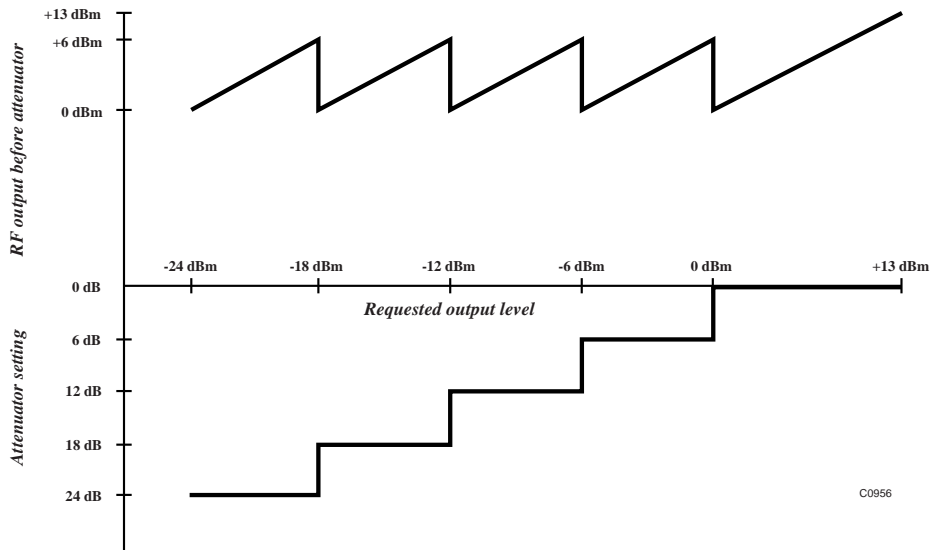

Fig. 3-1-35 Normal signal generator level control operation

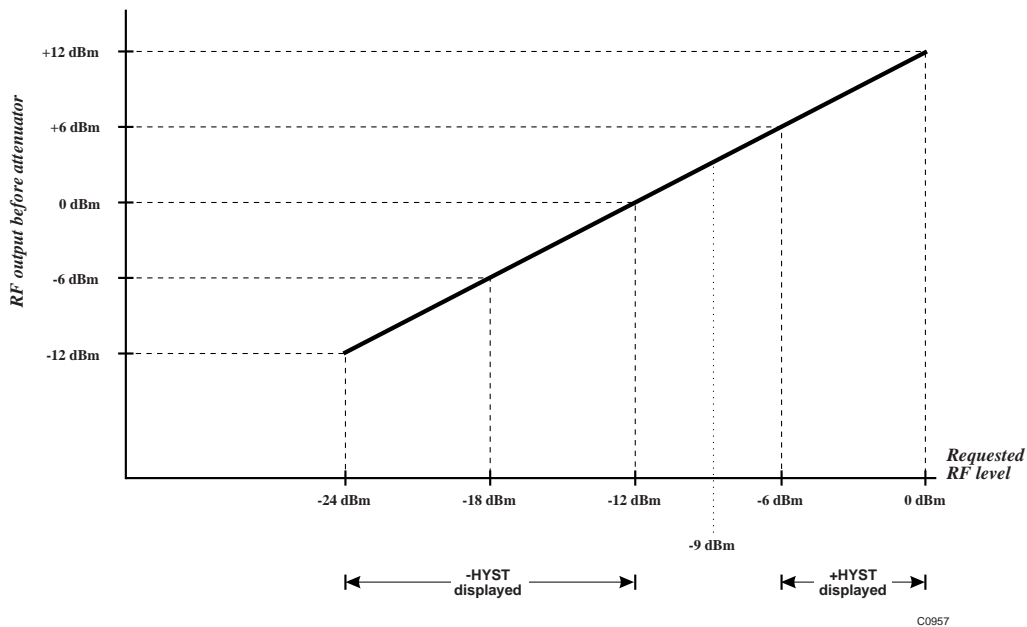

Fig. 3-1-36 Extended hysteresis operation with RF level -9 dBm as starting level

Note...

In the hysteresis range the RF level is set in a different way to the normal operation and this will affect some performance aspects. AM distortion and accuracy will be affected. With no AM selected, the effect on RF accuracy in the +HYST region will be relatively minor. But the effect in the -HYST region on RF level accuracy will be more significant.

Burst control

Applies only if Option 002, Pulse Modulation is fitted. Pressing the [CW Burst Control] key toggles between normal operation and Burst Suppression operation. For details refer to 'Pulse modulation' above.

RF offset

With the instrument unlocked to Level 1, see 'Locking and unlocking' above, pressing [Offsets] produces the layout for the soft keys shown in Fig. 3-1-37.

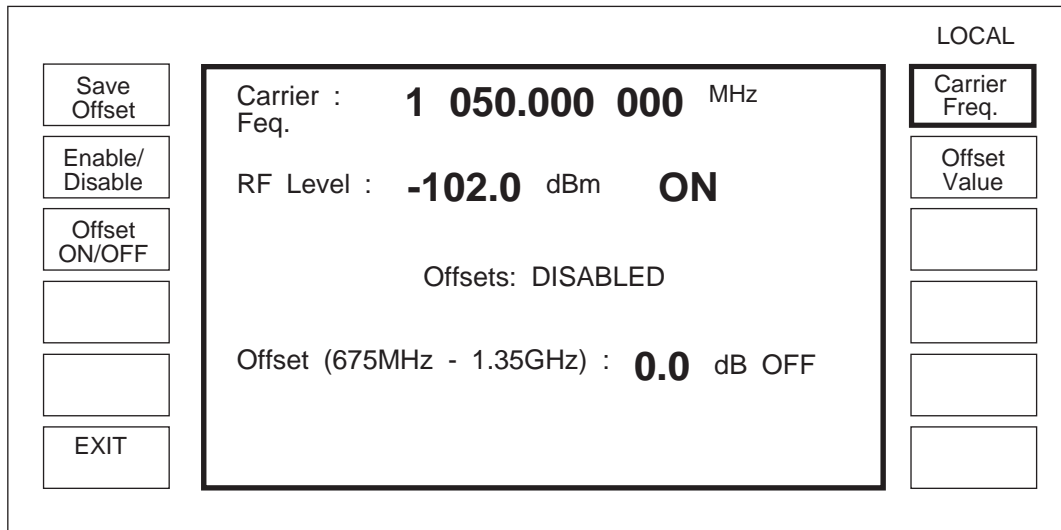

C1484

Fig. 3-1-37 RF offset adjustment menu

To compensate for cable or switching losses or to standardize a group of instruments so that they give identical measurements, the RF output level can be offset by up to ± 2 dB. This is done by selecting [Offset Value] and either keying in the value or making the adjustment with the control knob. A separate offset can be set for the carrier frequency range 10 kHz to 337.5 MHz and each octave above this. Offsets can be turned on or off individually using the [Offset ON/OFF] key or all offsets can be turned on or off via the [Enable/Disable] key.

Note...

This facility is replaced by a more versatile system on generators supplied with Option 008, RF profiles and complex sweep (see Annex C).

RF level limit

With the instrument unlocked to level 1, see 'Locking and unlocking' above, pressing the [RF Level Limit] key causes the RF Level Limit Menu shown in Fig. 3-1-38 to be displayed.

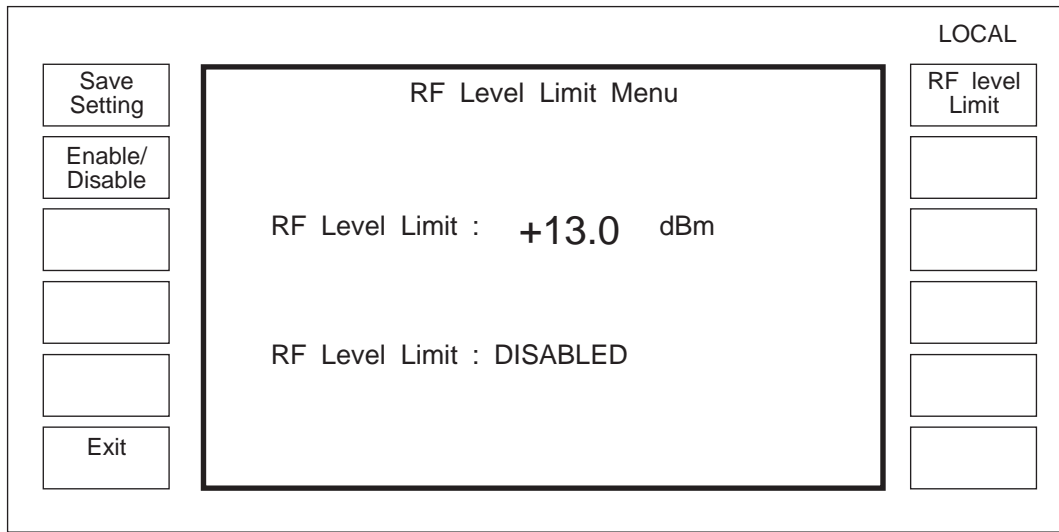

Fig. 3-1-38 RF level limit menu

The maximum peak RF level output can be specified in the range -138 to +19 dBm for the standard instrument or in the range -138 to +25 dBm for an instrument fitted with the high output power Option 003. As a result the keyed-in RF output value can be limited as a means of protecting sensitive devices connected to the RF output of the signal generator. Alternatively, the RF output power can be extended by an additional 6 dB for overrange testing. If the requested output level is in the overrange region the *uncal* message is displayed on the *Sig Gen* menu.

The RF level limit is set by selecting [RF Level Limit] and entering the value required. Units may be μ V, mV or dB. The choice of volts EMF, volts PD and the dB reference is made by using the RF Level Units utility (see 'RF level units' above). The RF level limit can be turned on or off by means of the [Enable/Disable] key.

By pressing the [Save Setting] key, the RF level limit value and status is stored to non-volatile memory which is recalled at switch-on and during an instrument reset.

Note...

When in the overrange region, the signal generator is capable of generating much higher signal levels. If the frequency is set below 21.09375 MHz and the RF output is not terminated in 50 Ω , the RPP may be tripped by the internal RF signal. If this happens the RPP can only be reset if a 50 Ω termination is connected to the RF OUTPUT socket.

LOW FREQUENCY OPERATION

The instrument has two modes of LF operation. The LF output can be used either as a modulation signal monitor or as an independent low frequency generator. Pressing [LF] displays either the *LF Monitor Menu* or the *LF Generator Menu*, depending on which mode was last selected.

LF monitor

The left-hand side of the *LF Monitor Menu*, varies according to the modulation mode; single, composite, dual or dual composite. In each case the right-hand side is occupied by a single soft key, [*LF Gen.*].

Table 3-1-1
List of available soft keys for different modulation modes

Single	Composite	Dual	Dual Composite
Mod. Drive	Mod. Drive	AM Drive	AM Drive
Mod. Source	Mod. 1 Source	AM Source	AM 1 Source
-	Mod. 2 Source	-	AM 2 Source
-	-	FM/ΦM Drive	FM/ΦM Drive
-	-	FM/ΦM Source	FM/ΦM 1 Source
-	-		FM/ΦM 2 Source

Modulation source monitoring

Internal sources only may be monitored. To monitor a modulating signal source, press the appropriate key. The source monitor level and the source information appear on the display. The modulating signal output is fed to the LF OUTPUT socket at a fixed level of 1 V.

Modulation drive monitoring

Modulation drive monitoring is intended for the user to monitor complex modulating signals from both internal and external sources. To monitor a modulation drive, press the appropriate key. The LF Monitor Level and the selected drive are displayed.

When the summed AM drive signal is selected, a signal which is the sum of both AM channels is fed to the LF OUTPUT socket, if in a composite or dual composite mode. The LF level function controls the output level at 100% depth, therefore the actual output voltage depends on the modulation depth. If AM is turned off, the associated LF output is removed.

The summed FM/ΦM drive signal is also fed to the LF OUTPUT socket. The signal is the sum of both FM/ΦM channels. The FM drive signal at the monitored point is nominally 1 V but varies over a range of approximately 3 dB (except at deviation values below about 1 kHz) depending on the set modulation and the carrier frequency selected. If FM/ΦM is turned off, the LF signal is removed. If one component of a composite modulation setting is turned off, the component which is left on remains at its original level.

Note...

Wideband FM and pulse modulating signals are not accessible via the monitor mode.

Use as an independent LF generator

To use the instrument as an independent LF generator, select [*LF Gen.*] at the *LF Monitor Menu*. The *LF Generator Menu* appears on the display as shown in Fig. 3-1-39.

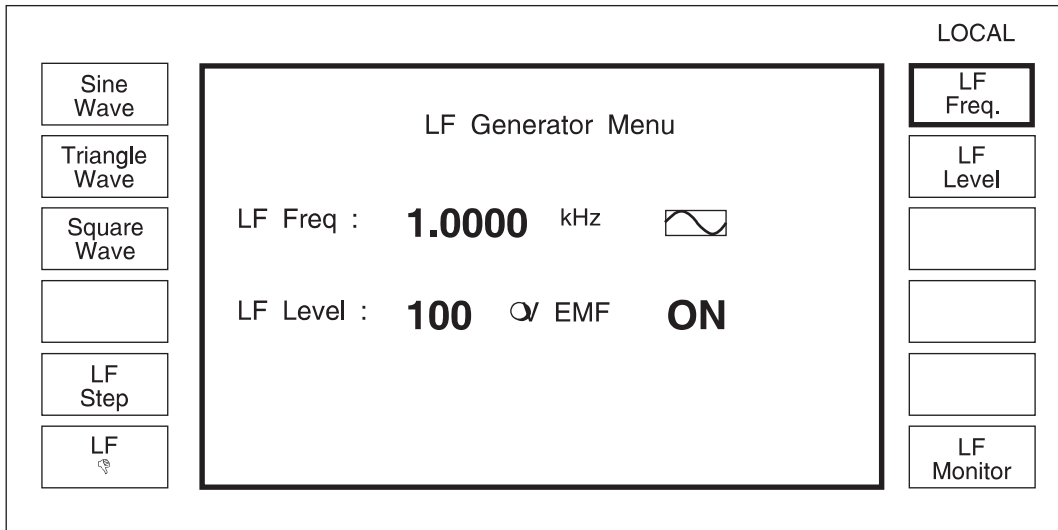

C3487

Fig. 3-1-39 LF generator menu

In this mode, one internal oscillator must be used exclusively for this task. Consequently if only one oscillator is fitted, no internal modulation is available to the signal generator while the LF generator is in use. If a second oscillator is fitted, only one is available to the signal generator.

LF frequency and LF level are adjusted by pressing the appropriate key and entering the value via the numerical key pad and pressing [enter]. To set step values, press [*LF Step*] for the *LF Step Menu*. [*Freq. Step*] or [*Level Step*] can be selected and the values entered as before. To display the *LF Total Shift Menu*, press [*LF Δ*].

To regain the oscillator as a modulation source, select the monitor mode.

Note...

The LF output is entered as V/mV/μV or dBm/dBV/dBmV representing the open circuit voltage fed to a high impedance, but the steps are entered in dB and the control knob has a fixed resolution of 0.1 dB.

MEMORY

Memory recall

Pressing the [MEM] hard key after switch on, causes the *Memory Recall Menu*, Fig. 3-1-40, to be displayed. There are four types of recall, full, partial, carrier frequency and sweep. Provision is made for an option not to recall the carrier frequency for full and partial stores. This allows one carrier frequency to be used with a series of stored settings. Pressing [*Inhibit ON/OFF*] turns the option ON and OFF. The state of the option is indicated on the display.

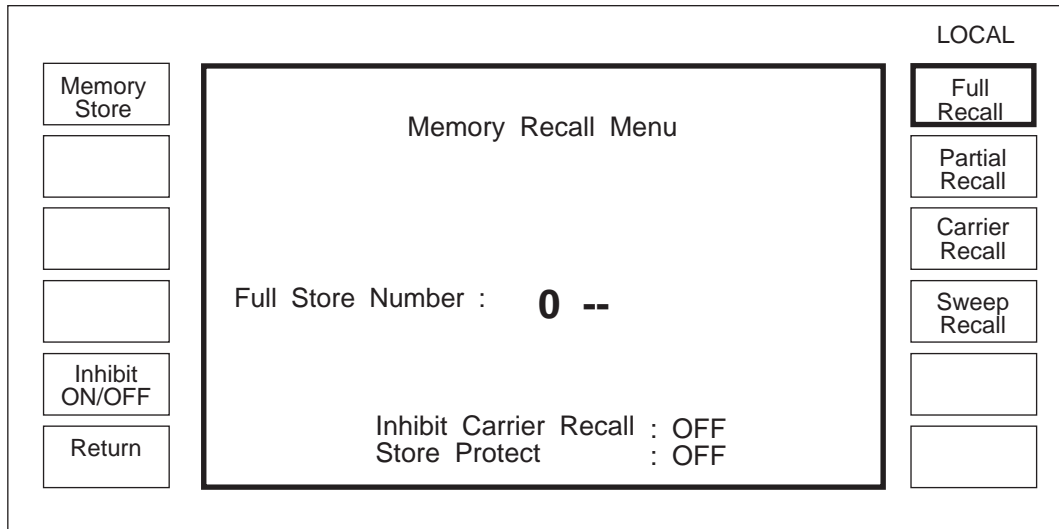

C0940

Fig. 3-1-40 Memory recall menu

Full recall

Selecting [*Full Recall*] enables the recall of a complete instrument setting, i.e. carrier frequency, RF level, modulations and their increments, ON/OFF and source information. Also recalled are all 6 modulation oscillator frequencies, plus one increment, and the LF Generator/Monitor setting. [*Inhibit ON/OFF*] provides the option not to recall the carrier frequency setting. The state of the option is indicated on the display. There are 50 locations (numbered 0 to 49) for full recall. A further location (50) allows the factory default settings to be recalled. The factory default settings are listed in Table 3-2-1.

Partial recall

This is a less comprehensive recall of only those parameters which currently affect the RF output; carrier frequency, RF level, modulations in use (without increments), ON/OFF and source information and the two modulation oscillator frequencies in use. As with full store, the option not to recall the carrier frequency is provided. There are 50 locations (numbered 0 to 49) for partial storage.

Carrier recall

The carrier frequency store has 100 locations (numbered 0 to 99) which may be recalled when required.

Sweep recall

The sweep store has 20 locations (numbered 0 to 19) containing complete sets of sweep parameters which may be recalled when required.

Note...

Sweep parameters can be recalled whether the instrument is in sweep mode or not. They are only used when sweep is selected.

Recalling data

To recall data, press the soft key for the type of recall required, e.g. [*Carrier Recall*] and select the location by means of the key pad. The [↑] and [↓] keys can be used to recall the next locations. Pressing [*Return*] recalls the location last specified on the numerical key pad.

Stores can be incremented or decremented externally by means of the SWEEP TRIGGER socket (see 'External trigger' above).

Note...

The settings for the sequential calling tones are recalled via the calling tones menu in UTILITIES, see Fig. 3-1-28. These stores can be erased from the *Store Erase Menu*.

Inhibit ON/OFF

When recalling full or partial stores it is sometimes useful for the existing carrier frequency setting to remain and not be replaced by the stored setting. The Inhibit Carrier Recall facility offers this capability. To prevent the current carrier frequency from being replaced use the [*Inhibit ON/OFF*] key to set the *Inhibit Carrier Recall* annunciator to *ON*.

To allow the carrier frequency setting to be overwritten use the [*Inhibit ON/OFF*] key to set the *Inhibit Carrier Recall* annunciator to *OFF*.

Memory stepping facility

The [Sig Gen] key has a toggle action in that pressing the key a second time displays the *Memory Stepping* menu shown in Fig. 3-1-41. This facility enables the memory to be stepped up and down from a start location (selected using the *Memory Recall Menu*), whilst displaying the settings for that memory.

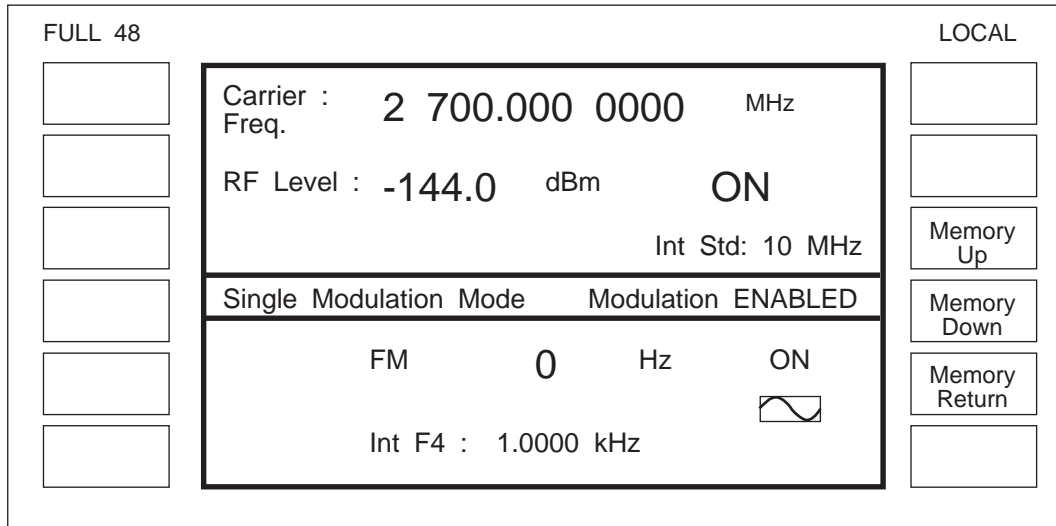

C0955

Fig. 3-1-41 Memory stepping menu

Pressing [*Memory Up*] or [*Memory Down*] respectively increments or decrements the memory location. With each step the settings stored in the location are displayed together with, at the top left of screen, the memory type and location e.g. *Full 48*. Incrementing and decrementing can also be done externally by means of the SWEEP TRIGGER socket (see 'External trigger' above). Pressing [*Memory Return*] at any time returns to the start location.

When a limit is reached, e.g. for Full Recall locations 0 and 49, a further step will reset to the start location. But note that if the start location coincides with a limit, trying to step past that limit will cause the limit and start locations (in this case the same numbered locations) to be alternately displayed. To make the user aware of this situation, the message *At Top Limit* or *At Bottom Limit* is displayed at the top centre of screen.

Memory store

Pressing the *[Memory Store]* soft key on the *Memory Recall Menu* causes the *Memory Store Menu*, Fig. 3-1-42, to be displayed. There are four types of store, full, partial, carrier frequency and sweep.

To prevent the accidental overwriting of memory contents, a store protection facility is provided. If this feature is enabled, the screen legend will indicate *Store Protect: ON* and the store key legends at the right of the screen will not appear.

Note...

Sequential calling tone sequences can be stored from the *Sequential Calling Tones Utility* menu. There is provision for storing up to 20 tone sequences.

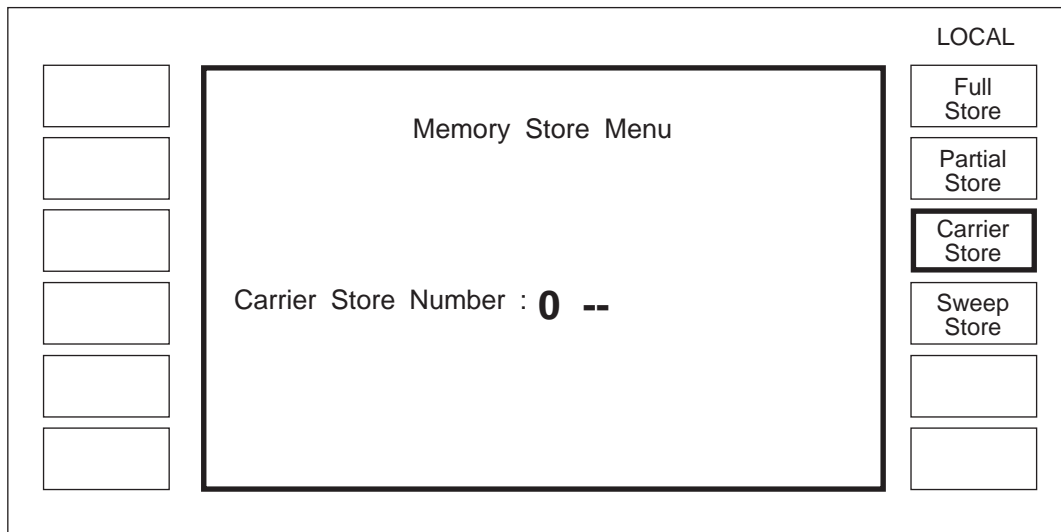

C0941

Fig. 3-1-42 Memory store menu

Full store

Selecting [*Full Store*] enables the storage of a complete instrument setting, i.e. carrier frequency, RF level, modulations and their increments, ON/OFF and source information. Also stored are all 6 modulation oscillator frequencies, plus one increment, and the LF Generator Monitor setting. There are 50 locations (numbered 0 to 49) for full storage. A further location (50) holds the factory default settings. This memory cannot be written to by the user. The factory default settings are listed in Table 3-2-1.

A Full Store contains the following information:

- Carrier frequency setting
- Carrier frequency step size
- RF level setting
- RF level step size
- All modulation settings
- All modulation step sizes
- Modulation mode and status
- All six internal oscillator frequency settings
- The modulation frequency step size
- LF generator frequency setting
- LF generator frequency step size
- LF generator level setting
- LF generator level step size
- LF monitor settings
- Display blanking settings

Partial store

This is a less comprehensive store of only those parameters which currently affect the RF output; carrier frequency, RF level, modulations in use (without increments), ON/OFF and source information and the two modulation oscillator frequencies in use. There are 50 locations (numbered 0 to 49) for partial storage.

A Partial Store contains the following information:

- Carrier frequency setting
- RF level setting
- The active modulation settings
- Modulation mode and status
- The frequency of the active modulation frequencies
- Either the LF generator frequency and level setting or the LF monitor setting (depending on which mode is selected)

Carrier store

The carrier frequency store has 100 locations (numbered 0 to 99) for the storage of carrier frequency only. This store can be used in conjunction with the full and partial stores to apply a set of test conditions to a range of frequencies.

Sweep store

The sweep store has 20 locations (numbered 0 to 19) for the storage of complete sets of sweep parameters.

Storing data

To store data, press the soft key for the type of store required, e.g. *[Partial Store]* and define a store location via the numerical key pad, then press *[enter]*.

Note...

The settings for the sequential calling tones are stored via the calling tones menu in UTILITIES, see Fig. 3-1-28. These stores can be erased from the *Store Erase Menu*.

Store erase

Unlock to Level 1. Pressing *[Store Erase]* causes the *Store Erase Menu* to appear on the screen. The opportunity to erase all the stores of a given type is available by pressing the relevant key and then pressing *[Erase]*.

Frequency hopping

Carrier frequency hopping is a GPIB operation where the instrument can be instructed to hop between any of the frequencies contained in the carrier frequency stores and a sequence of up to 1024 hops may be entered. The time interval between hops can also be entered .

Before executing a carrier hopping sequence, the frequencies must be loaded into the carrier frequency stores (0 - 99). This can be achieved via the GPIB using the following commands -

CFRQ < frequency value >
STO:CFRQ < store number >

To enter the frequency hopping mode, enter the following GPIB commands -

IMODE SWEEPER
SWEEP:TYPE HOP

This will cause the screen as shown in Fig. 3-1-43 to appear on the signal generator -

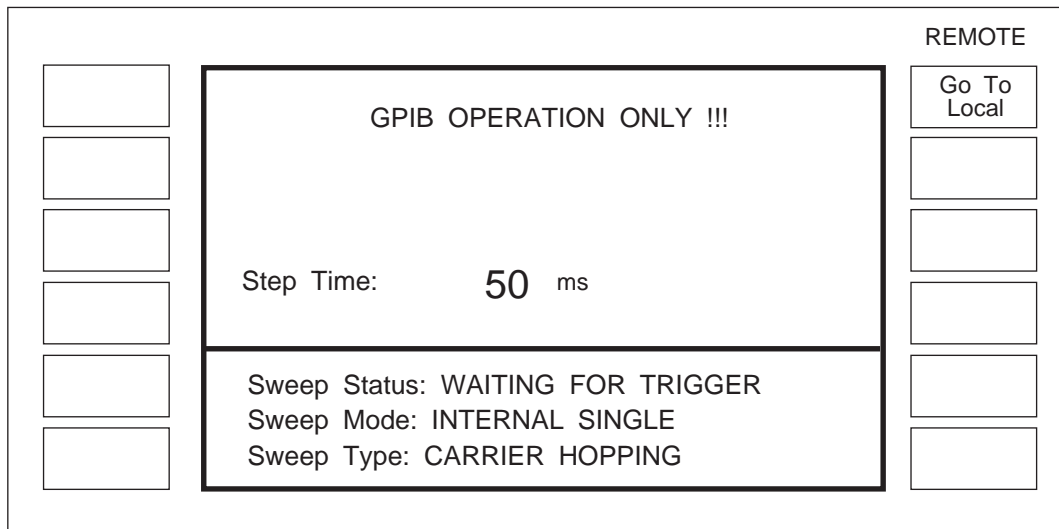

C0067

Fig. 3-1-43 Frequency hopping menu

To load in a sequence, the following command is used -

HOPSEQ<n0>,<n1>,<n2>,<n3>,<n4>.....

where <n0> - <n> are numeric values in the range 0-99 corresponding to the carrier frequency store at which the necessary frequency is stored. The hopping sequence length is determined by the amount of numbers entered.

The other parameter that can be set to control the hopping sequence is the time between steps. This is done using the command -

SWEEP:HOP:TIME < t >

where t represents the number of milliseconds.

The 100 frequencies are precalculated and loaded into a software sweep table using the GPIB command -

SWEEP:CALC

Note:...

If any of the carrier frequency stores have become corrupt and so result in a checksum error, the following message will appear in the centre of the screen:

*CARRIER STORE < x > CORRUPTED.
RE - ENTER FREQUENCY.*

where *x* is the corrupted store number.

With the frequencies, sequence and step time loaded, the hopping operation is controlled in the same manner as the ordinary sweeps by using the following commands:

SWEEP:GO	starts the hopping sequence (and will do any precalculation if required).
SWEEP:HALT	pause the hopping sequence.
SWEEP:UP	go up to the next step while paused.
SWEEP:DN	go down to previous step while paused.
SWEEP:CONT	continue hopping sequence.
SWEEP:RESET	reset sequence to start value.

When paused the carrier store number is displayed on the screen.

Note...

There are no markers available and the operation of transferring the paused value to the main parameter is not permitted.

To enter a new sequence use the HOPSEQ command but the number 255 is inserted at the beginning of the string.

e.g. existing sequence - 0, 6, 53, 72, 43, 96
 sequence required - 22, 16, 7, 41, 59, 66
 send GPIB command -
 HOPSEQ 255, 22, 16, 7, 41, 59, 66

To add to an existing sequence use the HOPSEQ command without 255 at the beginning of the string.

e.g. existing sequence - 12, 24, 36, 48
 sequence required - 12, 24, 36, 48, 60, 72, 84
 send GPIB command -
 HOPSEQ 60, 72, 84

To determine the length of the hopping sequence the following GPIB command is used -

HOPSEQ?

This returns a value 1 - 1024.

Like other sweep settings the frequency hopping mode can be set to:

single sweep (internal trigger),
continuous sweep (internal trigger) or
external sweep (external trigger)

by using the following commands:

SWEEP:MODE SNGL
SWEEP:MODE CONT
SWEEP:MODE EXT

For externally triggered operation the trigger facility can be used in the same manner as another sweep function.

ERROR HANDLING

Errors may be divided into three groups - foreground errors generally caused by a user, background errors which represent a condition of the instrument and GPIB errors which occur only when the unit is being controlled by a GPIB controller.

Background errors

An incorrect operating condition within the instrument automatically generates an error message to warn the operator. For example, if the internal frequency standard should fail the message *Int. Standard Failure* will be displayed at the top of the screen. Background errors are listed in Table 3-1-2.

Foreground errors

Attempts to set the instrument to a parameter value outside its known range result in the generation of an error message. For example, trying to select a carrier frequency above or below the specified range results in the message *Carrier Outside Limits* being displayed at the top of the screen. Foreground errors are cleared automatically when a correct entry is made by the user. Foreground errors are listed in Table 3-1-3.

GPIB errors

Errors caused by incorrect programming are displayed at the top of the screen and may also generate a Service Request if the relevant status registers are set. GPIB errors are listed in Table 3-1-4.

Error display

Front panel

Errors are displayed as a single line of text at the top of the screen. If more than one error is present an internal priority ordering algorithm determines which error is displayed.

GPIB

When an error occurs, its number is entered into the Error Queue. Errors are not removed from the queue when they are cleared, but only by the ERROR? query, which returns the error at the head of the queue, or by the *CLS command which clears the whole queue. When the queue contains an error entry, a bit (<erb>) on the status byte is set.

The error queue has a capacity of 100 error numbers. If an error occurs while the queue is full the last error number is replaced with 255 so that the ERROR? query returns a value of 255 to indicate a full queue. An empty queue returns a value of 0 following an ERROR? query.

In addition to the error queue entry, the appropriate bit in the Standard Event Register will also be set (one of <cmd>, <exe>, <dde> or <qye>). Many background errors are also reported in the Hardware and Coupling Status Registers. For the above registers see Chap. 3-2.

Table 3-1-2 Background errors

Error		Descriptive text	Error		Descriptive text
No.	Type		No.	Type	
1	dde	RPP Tripped	6	dde	VCXO Out of Lock
2	dde	Fractional N Out of Lock	7	dde	Ext1 Too Low
3	dde	Int. Standard Failure	8	dde	Ext1 Too High
4	dde	Ext. Standard Failure	9	dde	Ext2 Too Low
5	dde	Incorrect Ext. Standard	10	dde	Ext2 Too High
11	dde	IF Loop Out of Lock	16	-	-
12	dde	IQ Mod. Freq. Std. Failure	17	exe	RF Level limited by AM
13	dde	16/26 Reference Too High	18	exe	FM limited by Carrier
14	dde	16/26 Reference Too Low	19	exe	WBFM limited by Carrier
15	dde	IQ MOD. AUTOCAL REQUIRED	20	exe	AM2 limited by AM1
21	exe	FM2 limited by FM1	26	dde	Real Time Clock Problem
22	exe	PM2 limited by PM1	27	dde	Calibration Date Expired
23	exe	Steps limited by Span	28	dde	Pad Calibration Checksum
24	exe	FM Selfcal Error	29	dde	RF Calibration Checksum
25	dde	Internal Osc.1 Missing	30	dde	FM Calibration Checksum
31	dde	Path/Source Calibration	36	-	-
32	dde	Absolute Mod. Calibration	37	-	-
33	dde	Freq. Std. Calibration	38	-	-
34	dde	IQ MOD. RF Calibration	39	-	-
35	dde	IQ Modulator Calibration	40	exe	Profile Outside RF Limits
41	dde	Incorect Software Fitted			
42	exe	RF Lvl. Limited by IQ Mode			
43	exe	S'band Sel. Not Possible			
44	exe	IF Selection Not Possible			
45	exe	Carr. Limited by IQ Mode			

Table 3-1-3 Foreground errors

Error		Descriptive text	Error		Descriptive text
No.	Type		No.	Type	
46	exe	Recall Checksum	51	exe	Carrier Outside Limits
47	exe	Incorrect Setup	52	exe	RF Level Outside Limits
48	exe	Invalid Memory Number	53	exe	Mod Rate Outside Limits
49	exe	MODULATION NOT ENABLED	54	exe	LF Freq. Outside Limits
50	exe	Out of Range	55	exe	LF Level Outside Limits
56	exe	AM Outside Limits	61	exe	RF Level Step Too Big
57	exe	FM Outside Limits	62	exe	Mod Rate Step Too Big
58	exe	PM Outside Limits	63	exe	LF Freq. Step Too Big
59	exe	WBFM Outside Limits	64	exe	LF Level Step Too Big
60	exe	Carrier Step Too Big	65	exe	AM Step Too Big
66	exe	FM Step Too Big	71	exe	Sweep Stop Out of Range
67	exe	PM Step Too Big	72	exe	Sweep Steps Out of Range
68	exe	Invalid Latch Number	73	exe	Sweep Time Out of Range
69	exe	Invalid Latch Data	74	exe	Sweep Marker Out of Range
70	exe	Sweep Start Out of Range	75	exe	Attenuator EAROM Read

Table 3-1-3 Foreground errors (continued)

76	exe	Attenuator EAROM Write	81	exe	EAROM Wrap Around Error
77	exe	RF Option Box EAROM Read	82	exe	Continuous Tone Checksum
78	exe	RF Option Box EAROM Write	83	exe	Sequential Tone Checksum
79	exe	EAROM Write Error	84	exe	Tone data Out of Range
80	exe	EAROM Read Error	85	exe	Tone Offset Out of Range
86	exe	Clock Data Entry Error	91	exe	RF levelling fault
87	exe	At Top Limit	92	exe	REPEAT THIS CALIBRATION
88	exe	At Bottom Limit	93	exe	DSP Not Responding
89	exe	Ext. Trigger Disabled	94	exe	A/D Conversion Failure
90	dde	Int. Std. Not Selected	95	exe	Tone Sequence Incorrect
96	exe	Mod, Autocal Failure			
97	-	-			
98	exe	Direct Doppler Limited			
99	exe	Insufficient Points			
100	exe	Carrier Outside Profile			

Table 3-1-4 GPIB errors

Error		Descriptive text	Error		Descriptive text
No.	Type		No.	Type	
101	-	-	106	cmd	Data Expected
102	cmd	Mnemonic Fault	107	cmd	Illegal Data
103	cmd	Block Definition	108	cmd	Terminator Expected
104	cmd	Block Size	109	cmd	GET Error
105	cmd	Numeric Syntax	110	cmd	EOM Error
111	exe	Illegal Modulation Mode	116	qye	Unterminated
112	exe	No Such Monitor Mode	117	qye	Interrupted
113	exe	Cannot Monitor	118	qye	Deadlock
114	exe	Instrument Mode Wrong	119	cmd	Missing Quote
115	cmd	Lost Data After Comma	120	cmd	Terminator Expected
121	exe	String Length	126	exe	Illegal Seq Tones Mode
122	exe	Illegal Tone Character	127	exe	Overflow
123	exe	Illegal Duration Char	128	cmd	Data Too Long
124	exe	Illegal Standard	129	exe	Voltage Type Error
125	exe	Illegal Save Destination	130	exe	Sweep Not Possible
131	exe	Unknown Cal Point	136	exe	Unknown Freq. Standard.
132	exe	Unknown RF Band	137	exe	User Data Locked
133	exe	Unknown Instrument Mode	138	exe	Trigger Unknown
134	exe	User Data Checksum	139	exe	Illegal Tones Operation
135	qye	Query Lost after arb. char	140	cmd	Error in Char Data
141	exe	Wrong RF units	146	exe	Wrong Family For Command
142	cmd	Data Unknown	147	exe	Not Suitable For Hopping
143	exe	Negative Value Illegal	148	exe	Hopping Sequence Full
144	exe	Illegal Modulation Mode	149	-	-
145	exe	Unavailable Mod Source	150	exe	Wrong LF Units
151	-	-	156	exe	Text Tone Util. Selected
152	-	-	157	exe	Illegal Sequence Char.
153	-	-	158	exe	Point not in Profile
154	exe	Unknown Waveform ROM Type	159	exe	Unkown External Box Type
155	exe	IQ Mode Parameter Unkown	160	-	-

Table 3-1-5 Fatal errors

Error		Descriptive text	Error		Descriptive text
No.	Type		No.	Type	
171	exe	Main RAM Faulty	176	-	-
172	exe	Main PROM Faulty	177	-	-
173	exe	Microwave Board Error	178	-	-
174	exe	Attenuator Type Unknown	179	-	-
175	exe	Wrong Attenuator fitted	180	-	-

Chapter 3-2 GPIB OPERATION

CONTENTS	PAGE
INTRODUCTION	3-2-2
INTRODUCTION	3-2-2
GPIB FUNCTIONS	3-2-2
DEVICE LISTENING ELEMENTS	3-2-3
DEVICE TALKING ELEMENTS	3-2-3
PROGRAMMING	3-2-4
Program messages	3-2-4
Compound headers	3-2-4
Program data	3-2-5
Message exchange protocol	3-2-5
Remote/local operation	3-2-5
Common commands and queries (IEEE 488.2)	3-2-6
DEVICE DEPENDENT COMMANDS	3-2-8
DEFAULT SETTINGS	3-2-8
INSTRUMENT MODE	3-2-10
CARRIER FREQUENCY	3-2-10
RF LEVEL	3-2-11
MODULATION MODE	3-2-14
MODULATION CONTROL	3-2-15
FREQUENCY MODULATION	3-2-16
PHASE MODULATION	3-2-17
AMPLITUDE MODULATION	3-2-18
WIDEBAND FM	3-2-19
PULSE MODULATION	3-2-20
MODULATION FREQUENCY	3-2-21
CTCSS TONES EDIT	3-2-22
SEQUENTIAL TONES	3-2-23
LF CONTROL	3-2-26
LF GENERATOR FREQUENCY	3-2-27
LF GENERATOR LEVEL	3-2-28
MEMORY - STORE	3-2-29
MEMORY - RECALL	3-2-29
MEMORY - ERASE	3-2-29
SWEEP OPERATION	3-2-30
SWEEP MODE/TYPE	3-2-34
SWEEP CONTROL	3-2-35
MISCELLANEOUS COMMANDS	3-2-37
THE STATUS BYTE	3-2-40
STATUS DATA STRUCTURE - REGISTER MODEL	3-2-41
STANDARD EVENT REGISTERS	3-2-43
HARDWARE EVENT REGISTERS	3-2-44
COUPLING EVENT REGISTERS	3-2-45
INSTRUMENT EVENT REGISTERS	3-2-46
QUEUE FLAG DETAILS	3-2-47
STATUS BYTE WHEN READ BY *STB?	3-2-48
STATUS BYTE WHEN READ BY SERIAL POLL	3-2-49
SUMMARY OF STATUS REPORTING COMMANDS AND QUERIES	3-2-50

LIST OF TABLES

Table 3-2-1 Instrument default settings	3-2-8
---	-------

INTRODUCTION

The 2030 Series signal generators can be operated remotely from a personal computer fitted with a GPIB interface card or a dedicated GPIB controller. All functions can be controlled by coded messages sent over the interface bus via the 24-way socket on the rear panel of the instrument. IEEE Standard 488.2 (1987) is implemented, which defines the protocols and syntax of commands.

The instrument can function either as a talker or a listener. In the listen mode, it will respond to IEEE 488.2 common commands and queries and device-specific commands and queries. These allow various device functions to be controlled and operating parameters to be set. In the talk mode, device status information and parameter settings can be read from the instrument.

For full information on the IEEE protocols and syntax the IEEE 488.2 Standard should be consulted.

GPIB FUNCTIONS

The IEEE 488.1 interface functions offered by 2030 Series are as follows:

Source handshake (SH1)	complete capability.
Acceptor handshake (AH1)	complete capability.
Talker (T6)	basic talker, serial poll, unaddress if MLA.
Listener (L4)	basic listener, unaddress if MTA.
Service Request (SR1)	complete capability.
Remote/Local (RL1)	complete capability.
Device clear (DC1)	complete capability.
Device trigger (DT1)	complete capability.
Parallel Poll (PP0)	no capability.
Controller (C0)	no capability.
Tri-state drivers (E2)	as opposed to open collector drivers.

DEVICE LISTENING ELEMENTS

The following is a list of the device listening elements (as defined in the IEEE 488.2 standard) which are used in the 2030 Series of signal generators:

- <PROGRAM MESSAGE>
- <PROGRAM MESSAGE TERMINATOR>
- <PROGRAM MESSAGE UNIT>
- <PROGRAM MESSAGE UNIT SEPARATOR>
- <COMMAND MESSAGE UNIT>
- <QUERY MESSAGE UNIT>
- <COMPOUND COMMAND PROGRAM HEADER>
- <COMPOUND QUERY PROGRAM HEADER>
- <PROGRAM HEADER SEPARATOR>
- <PROGRAM DATA>
- <PROGRAM DATA SEPARATOR>
- <DECIMAL NUMERIC PROGRAM DATA>
- <CHARACTER PROGRAM DATA>
- <SUFFIX PROGRAM DATA>
- <STRING PROGRAM DATA>
- <ARBITRARY BLOCK PROGRAM DATA>

DEVICE TALKING ELEMENTS

The following is a list of the device talking elements (as defined in the IEEE 488.2 standard) which are used in the 2030 Series of signal generators:

- <RESPONSE MESSAGE>
- <RESPONSE MESSAGE TERMINATOR>
- <RESPONSE MESSAGE UNIT>
- <RESPONSE MESSAGE UNIT SEPARATOR>
- <COMPOUND RESPONSE HEADER>
- <RESPONSE HEADER SEPARATOR>
- <RESPONSE DATA>
- <RESPONSE DATA SEPARATOR>
- <NR1 NUMERIC RESPONSE DATA>
- <NR2 NUMERIC RESPONSE DATA>
- <ARBITRARY ASCII RESPONSE DATA>
- <CHARACTER RESPONSE DATA>
- <STRING RESPONSE DATA>
- <DEFINITE LENGTH ARBITRARY BLOCK RESPONSE DATA>

PROGRAMMING

Program messages

A message consists of one or more message units. Message units are separated by a semi-colon (;). The whole message is ended by the Program Message Terminator (or End Of Message) defined as one of the following:

- (1) <newline> (ASCII 10 - often known as 'line feed') or
- (2) <newline> + END (the EOI line is asserted as well) or
- (3) + END (EOI is asserted in the last data byte of the message)

Note...

A response message is always terminated by <EOM> consisting of <newline> + END.

A message unit consists of a mnemonic header which may be followed by data. If data follows, then it must be separated from its header by at least one space

<header><SPACE><data>
e.g. RFLV:INC 6.0 dB

Spaces may be freely inserted in a message to improve readability, except within a header or within data.

A header may be a command or a query. A query has a '?' as its final character and causes the generation of a response message which will be read by the controller. Common commands and queries (defined in IEEE 488.2) begin with a '*'.

Upper and lower case characters are considered equivalent (i.e. FM fm Fm fM are all interpreted by the 2030 Series in the same way).

Compound headers

The 2030 Series implements compound headers which allow a complex set of commands to be built up from a small set of basic elements in a 'tree and branch' structure. The elements of a compound header are separated by a colon (:). Spaces are not allowed within a header.

Special rules apply when more than one compound header is used in one message. When the separator ';' is encountered, all headers except the trailing element of the previous header in the message are assumed to precede the following header, for example:

AM:DEPTH 30PCT;ON

is equivalent to the two commands:

AM:DEPTH 30PCT
and AM:ON

This does not apply to common commands (*RST etc.). The rule may be overridden by preceding a header with a colon, for example:

AM:ON;:FM:ON

Most main functions have a short form of header which may be used for clarity and brevity in simple messages, for example:

CFRQ 1.25GHZ is the same as CFRQ:VALUE 1.25GHZ

Program data

Data can take many forms, as follows:

Decimal Numeric Data is a flexible numeric format which encompasses integer, fixed point and floating point (mantissa and exponent) representations. Data is rounded to a resolution appropriate to the function. Decimal data can, in most cases, be followed by the appropriate units. If no units are present, the specified default units are assumed.

Character Data is an alphanumeric word.

String Data consists of a number of 7-bit ASCII characters enclosed in quotes, either a pair of single ('ASCII 39') or double ("ASCII 34") quotes may be used.

Block Data is used by *PUD and allows a number of 8-bit bytes to be transferred. For further information see the Service Manual.

Some commands can accept Multiple Data items which are separated by commas, for example MODE FM,AM.

Message exchange protocol

The controller should not attempt to read a response until it has sent the entire query message (terminated by EOM). Also, it should not start to send a new message until it has read the entire response (terminated by EOM). The query message may contain more than one query message unit, but only one response message (containing several response message units) is generated.

Failure to follow the protocol will generate a query error:

UNTERMINATED (error 116) occurs when the controller attempts to read a response without having sent a query.

INTERRUPTED (error 117) occurs when the controller starts to send a new message before having read the response to a preceding query.

DEADLOCK (error 118) can only occur if the input and output buffers are both filled by the controller having sent an extra long Message containing several query message units.

The 2030 Series have input buffer stores of 256 characters and an output buffer of two response message units.

Remote/local operation

When the 2030 Series Signal Generator is addressed by the controller it will enter its remote mode and the screen will have only one key legend, *[LOCAL]*. Pressing this key returns the unit to normal manual operation, unless Local Lockout has been asserted by the controller.

Common commands and queries (IEEE 488.2)

The IEEE 488.2 standard defines a set of common commands and queries which implement common system functions.

Common command and query mnemonics are preceded by an asterisk (*) to distinguish them from device dependent data such as instrument programming strings. The following common commands and queries are implemented in the 2030 Series:

Mnemonic	Name and Description
*IDN?	<p>Identification Query. Returns an arbitrary ASCII response comprising four data fields in the format:</p> <p style="margin-left: 20px;"><Manufacturer>,<type number>,<serial number>,<firmware version number><EOM>.</p> <p>Example: IFR,2031,123456789,2.001<EOM></p>
*OPT?	<p>Option Identification Query. Returns an arbitrary ASCII response containing a data field for each fitted option in the format:</p> <p style="margin-left: 20px;"><option a>,<option d>, ... ,<option n><EOM></p> <p>Example: SECOND OSCILLATOR,PULSE MODULATION,+19 dBm OUTPUT<EOM></p> <p>If no options are fitted, ASCII '0' is returned.</p>
Note...	
<p>Because an Arbitrary ASCII Response ends with the Response Message Terminator (<EOM>) either *IDN? or *OPT? must be the last Query Message Unit in a Program Message.</p>	
*RST	Reset Command. Sets the instrument functions to the factory default power up state. The default settings appear in Table 3-2-1.
*TST?	Self Test Query. Returns a '0' when the GPIB interface and processor are operating.
*OPC	Operation Complete Command. Sets the Operation Complete bit in the Standard Event Status Register when execution of the preceding operation is complete.
*OPC?	Operation Complete Query. Returns a '1' when the preceding operation has been completed.
*WAI	Wait to Continue Command. Inhibits execution of an overlapped command until the execution of the preceding operation has been completed.
*TRG	Trigger Command. Equivalent to Group Execute Trigger.
*PUD <block>	Protected User Data Command. Sets the Protected User Data, accepts Definite Block Data when enabled. This command is covered in further detail in the Service Manual.
*PUD?	Protected User Data Query. Returns the User Data as a Definite Block Response.
Example:	#221Inventory Number 1234
*STB?	Read Status Byte Query. Returns the value of the Status Byte as an nr1 number (0-255).

- *SRE <nrf> Service Request Enable Command. Sets the Service Request Enable Register.
- *SRE? Service Request Enable Query. Returns the value of the Service Request Enable Register as nr1.
- *ESR? Standard Event Status Register Query. Returns the value of the Status Event Status Register as nr1.
- *ESE <nrf> Standard Event Status Enable Command. Sets the Standard Event Enable Register.
- *ESE? Standard Event Status Enable Query. Returns the value of the Standard Event Status Enable Register as nr1.
- *CLS Clear Status Command. Clears all the Status Event registers and clears the Error Queue. Does not affect the Enable Registers.

Note...

The IEEE 488.2 Device Clear function only affects the GPIB functions. The input and output buffers are cleared and the instrument put into a state to accept new Messages. It no longer puts the instrument functions into a defined state, this is now performed by the *RST common command.

DEVICE DEPENDENT COMMANDS

The following list describes the features of the device dependent mnemonics for the 2030 Series signal generators together with simple examples of their use within each major section (Carrier frequency, RF level, etc.) the root mnemonic is listed first followed by the lower level mnemonics. Each group is followed by a list of requirements for data type and suffix.

In addition to the normal listen commands the 2030 Series accept query commands which cause the instrument to prepare a message which will be sent to the controller when the instrument is next addressed to talk. For each query an example of a response is given. Where responses are similar for a group of queries not all are listed. Some queries can produce more than one type of response - an example of each is usually given.

In the list which follows, the abbreviations <char>, <nrf> and <str> have the following meanings:

- <char> = Character Program Data
- <nrf> = Decimal Numeric Program Data
- <str> = String Program Data

Where the data format is Decimal Numeric Program Data, the value may be expressed as a signed or unsigned number in any of the following formats:

- nr1: Decimal integer, e.g. 1234 or -567
- nr2: Floating point number, e.g. 1.234 or -56.789
- nr3: Floating point number with exponent, e.g. 1.2345E5 or -12.47E-8

DEFAULT SETTINGS

These are the settings assigned to instrument functions in the following cases:

- (i) Power-up to factory default settings.
- (ii) Execution of *RST command.
- (iii) Recall Full Store 50.

The instrument functions set to the factory default power-up state by the reset command (*RST) are as shown in Table 3-2-1.

Table 3-2-1 Instrument default settings

Instrument mode	:	Normal
Carrier frequency	:	(Maximum available) 1.35 GHz/2.7 GHz/5.4 GHz
	Step :	1 kHz
RF level	:	-144 dBm
	Step :	1 dB
	Status :	ON
Modulation mode	:	Single FM , modulation enabled

TABLE 3-2-1 INSTRUMENT DEFAULT SETTINGS (continued)

<p>Modulations :</p> <p style="margin-left: 20px;">FM1 : 0 Hz, Int F4, ON</p> <p style="margin-left: 20px;">FM2 : 0 Hz, Ext 1 ALC, ON</p> <p style="margin-left: 20px;">ΦM1 : 0 rad, Int F4, ON</p> <p style="margin-left: 20px;">ΦM2 : 0 rad, Ext 1 ALC, ON</p> <p style="margin-left: 20px;">AM1 : 0%, Int F4, ON</p> <p style="margin-left: 20px;">AM2 : 0%, Ext 2 ALC, ON</p> <p style="margin-left: 20px;">WBFM : (Minimum setting), AC coupled, ON</p> <p style="margin-left: 40px;">Steps : ΔFM 1 kHz, $\Delta\Phi$M 0.1 rad, ΔAM 1%</p> <p>Modulation source :</p> <p style="margin-left: 20px;">IntF1 : 300 Hz sine</p> <p style="margin-left: 20px;">IntF2 : 400 Hz sine</p> <p style="margin-left: 20px;">IntF3 : 500 Hz sine</p> <p style="margin-left: 20px;">IntF4 : 1 kHz sine</p> <p style="margin-left: 20px;">IntF5 : 3 kHz sine</p> <p style="margin-left: 20px;">IntF6 : 6 kHz sine</p> <p style="margin-left: 20px;">Step : 1 kHz</p> <p>LF Mode : Monitor, mod source</p> <p>LF generator Frequency : 1 kHz sine, step 1 kHz</p> <p style="margin-left: 20px;">Level : 100 μV</p> <p style="margin-left: 20px;">Step : 1 dB</p> <p style="margin-left: 20px;">Status : ON</p>
<p>Sweep:</p> <p style="margin-left: 20px;">Type : RF level</p> <p style="margin-left: 20px;">Mode : Single internal</p> <p>RF level sweep :</p> <p style="margin-left: 40px;">Start : -144 dBm</p> <p style="margin-left: 40px;">Stop : 10 dBm</p> <p style="margin-left: 40px;">Steps : 100</p> <p style="margin-left: 40px;">Time : 50 ms</p> <p style="margin-left: 40px;">Markers : 2, 4, 6, 8, 10 dBm, disabled</p> <p>Carrier freq. sweep :</p> <p style="margin-left: 40px;">Start : 100 MHz</p> <p style="margin-left: 40px;">Stop : (Maximum available)</p> <p style="margin-left: 40px;">Steps : 250</p> <p style="margin-left: 40px;">Time : 50 ms</p> <p style="margin-left: 40px;">Markers : 200, 400, 600, 800, 1000 dBm, disabled</p> <p>Mod. source freq. :</p> <p style="margin-left: 40px;">Start : 0.1 Hz</p> <p style="margin-left: 40px;">Stop : 500 kHz</p> <p style="margin-left: 40px;">Steps : 10,000</p> <p style="margin-left: 40px;">Time : 500 ms</p> <p style="margin-left: 40px;">Markers : 100, 20, 30, 400, 500 kHz</p>
<p>Sequential tones :</p> <p style="margin-left: 20px;">Mode : No modulation selected</p> <p style="margin-left: 20px;">Standard : CCIR</p> <p style="margin-left: 20px;">Sequence : 16 tone Fs</p> <p style="margin-left: 20px;">Duration : All normal</p> <p style="margin-left: 20px;">Frequency offset : 0</p> <p style="margin-left: 20px;">Extended duration : 500 ms</p> <p style="margin-left: 20px;">Repeat tone : E</p> <p style="margin-left: 20px;">Start delay : 200 ms</p>

INSTRUMENT MODE

IMODE Select instrument mode

Data type : Character Program Data (either NORMAL for signal generator operation or SWEEPER for swept operation)

Allowed suffices : None

Default suffix : None

Example: IMODE NORMAL

CARRIER FREQUENCY

CFRQ Set Carrier Frequency (short form)

:VALUE Set Carrier Frequency

:INC Set Carrier Frequency step

Data type : Decimal Numeric Program Data

Allowed suffices : Any one of: GHZ, MHZ, KHZ or HZ

Default suffix : HZ

:UP Go UP one step

:DN Go DOWN one step

:RET Return to original setting

:XFER Transfer current value to be the new setting

Data type : None

Allowed suffices : None

Default suffix : None

:PHASE Adjust Phase of Carrier in steps of $\pi/128$ radians (approximately 1.4°) over a range of ± 255 steps

Data type : Decimal Numeric Program Data

Allowed suffices : None

Default suffix : None

Examples: CFRQ:VALUE 1.23MHZ;INC 10KHZ
CFRQ:UP;XFER

CFRQ? Prepares message containing information on Carrier Frequency setting in the following format:

:CFRQ:VALUE <nr2>; INC <nr2>

Example: :CFRQ:VALUE 1000000000.0;INC 25000.0

RF LEVEL

RFLV Set RF output level (short form)
:VALUE Set RF output level

Data type : Decimal Numeric Program Data
 Allowed suffices : Any one of: DBM, DBV, DBMV, DBUV, V, MV or UV
 Default suffix : dBm unless changed by UNITS command

:INC Set RF level step (dB)

Data type : Decimal Numeric Program Data
 Allowed suffices : DB only
 Default suffix : DB

:UP Go UP one step
:DN Go DOWN one step
:RETN Return to original setting
:XFER Transfer current value to be the new setting
:ON Turn RF output ON
:OFF Turn RF output OFF

Data type : None
 Allowed suffices : None
 Default suffix : None

:TYPE Selects EMF or PD for voltage related units

Data type : Character Program Data (EMF or PD)
 Allowed suffices : None
 Default suffix : None

:UNITS Select default RF level units.

Data type : Character Program Data (DBM, DBV, DBMV, DBUV, V, MV or UV)
 Allowed suffices : None
 Default suffix : None

Examples: RFLV:VALUE -27.3DBM;ON
 RFLV:TYPE PD;VALUE 1.23UV

:OFFS [not used alone]
:VALUE Set Offset of current band

Data type : Decimal Numeric Program Data
 Allowed suffices : DB only
 Default suffix : DB

:ON Turn ON offset of current band
:OFF Turn OFF offset of current band
:ENABLE Enable Offsets
:DISABLE Disable Offsets
:SAVE Store Offsets in memory

Data type : None
 Allowed suffices : None
 Default suffix : None

Example: RFLV:OFFS:VALUE -0.2DB;ON;ENABLE

RFLV? Prepares message containing information on RF Level setting in the following format:
:RFLV:UNITS <unit>;TYPE <type>;VALUE <nr2>;INC <nr2>;<status>
where: <unit> is character program data defining the default RF level units (DBM, DBV, DBMV, DBUV, V, MV or UV), <type> is character program data indicating EMF or PD and <status> is a program mnemonic indicating whether the RF output is ON or OFF.

Examples: :RFLV:UNITS DBM;VALUE -103.5;INC 2.0;ON
:RFLV:UNITS DBV;TYPE EMF;VALUE -83.2;INC 0.5;ON

RFLV:OFFS? Prepares message containing information on RF Level offsets in the following format:
:CFRQ:VALUE <nr2>;:RFLV:OFFS:VALUE <nr2>;<status>;<activity>
where: <status> is a program mnemonic indicating whether the RF offset is ON or OFF and <activity> is a program mnemonic indicating whether the offset mode is enabled or disabled.

Example: :CFRQ:VALUE 500000000.0;:RFLV:OFFS:VALUE -0.4;ON;ENABLE

RFLV
:HYST [not used alone]
:ENABLE Enable Extended Hysteresis mode
:DISABLE Disable Extended Hysteresis mode
Data type : None
Allowed suffices : None
Default suffix : None

:RFLV:HYST? Responds with status as follows:
:RFLV:HYST:ENABLE
or :RFLV:HYST:DISABLE

RFLV
:LIMIT Set RF output level limit (short form)
:VALUE Set RF output level limit
Data type : Decimal Numeric Program Data
Allowed suffices : Any one of DBM, DBV, DBMV, DBUV, V, MV or UV
Default suffix : dBm unless changed by UNITS command (see above).
:ENABLE Enable RF output level limit
:DISABLE Disable RF output level limit
:SAVE Save RF output level limit to memory
Data type : None
Allowed suffices : None
Default suffix : None

RFLV:LIMIT?

Prepares message containing information on RF level setting in the following format:

:RFLV:UNITS <unit>;TYPE <type>;LIMIT:VALUE<nr2>;<status>

where: <unit> is character program data defining the default RF level units (DBM, DBV, DBMV, DBUV, V, MV or UV), <type> is character program data indicating EMF or PD and <status> is a program mnemonic indicating whether the RF level limit is enabled or disabled.

Examples: :RFLV:UNITS DBM;LIMIT:VALUE -10.2;ENABLE
:RFLV:UNITS V;TYPE PD;LIMIT:VALUE 0.224;DISABLE

MODULATION MODE

MODE

Set modulation mode

Data type : Character Program Data (valid combinations of AM, AM1, AM2, FM, FM1, FM2, PM, PM1, PM2, WBFM or PULSE, see Table below)

Allowed suffices : None

Default suffix : None

Examples: `MODE AM, FM`
`MODE FM1, FM2`

VALID MODE COMBINATIONS TABLE

Single	Composite	Dual	Dual Composite
AM1	AM1,AM2	AM1,FM1	AM1,AM2,FM1,FM2
FM1	FM1,FM2	AM1,PM1	AM1,AM2,PM1,PM2
PM1	PM1,PM2	AM1,WBFM	AM1,AM2,WBFM
WBFM		PULSE,FM1	PULSE,FM1,FM2
PULSE		PULSE,PM1	PULSE,PM1,PM2
		PULSE,WBFM	

Note...

At any time the '1' may be omitted, for example FM is equivalent to FM1. Order is not important, for example AM,FM is equivalent to FM,AM.

For instruments without pulse modulation (Option 002) fitted, select Low Intermodulation mode by using character data type PULSE.

MODE?

Prepares message containing information on Modulation Mode in the following format:

`:MODE:<mode>`

where: `<mode>` is character program data indicating the modulation mode settings.

Example: `:MODE FM1, FM2`

MODULATION CONTROL

MOD [not used alone]
:ON Turn modulation globally ON
:OFF Turn modulation globally OFF

Examples: MOD:ON
MOD:OFF

MOD? Prepares message containing information on Modulation Control in the following format:
:MOD:<status>
where: <status> is a program mnemonic indicating whether the Modulation is globally ON or OFF.

Example: :MOD:ON

FREQUENCY MODULATION

FM or FM1 or FM2 Set FM deviation (short form)
:DEVN Set FM deviation
:INC Set FM step size

 Data type : Decimal Numeric Program Data
Allowed suffices : Any one of: GHZ, MHZ, KHZ or HZ
Default suffix : HZ

:<src> Select modulation source where <src> is any one of: INTF1, INTF2, INTF3, INTF4, INTF5, INTF6, EXT1DC, EXT1AC, EXT1ALC, EXT2DC, EXT2AC or EXT2ALC

:ON Turn FM ON (locally)
:OFF Turn FM OFF (locally)
:UP Go UP one step
:DN Go DOWN one step
:RETN Return to original setting
:XFER Transfer current value to be the new setting

DCFMNL Perform DC FM/WBFM null operation

 Data type : None
Allowed suffices : None
Default suffix : None

Examples: FM:DEVN 25KHZ;INTF4;ON
 FM1:DEVN 15KHZ;INC 1KHZ;EXT1DC
 DCFMNL

FM? or FM1? or FM2? Prepares message containing information on FM setting in one of the following formats:

:FM:DEVN <nr2>;<src>;<status>;INC <nr2>
:FM1:DEVN <nr2>;<src>;<status>;INC <nr2>
:FM2:DEVN <nr2>;<src>;<status>;INC <nr2>

where: <src> is a program mnemonic representing the source of the modulation signal and <status> is a program mnemonic indicating whether the modulation is locally ON or OFF

Example: :FM1:DEVN 25000.0;INTF1;ON;INC 1000.0

PHASE MODULATION

PM or PM1 or PM2 Set Phase deviation (short form)
:DEVN Set Phase deviation
:INC Set Phase Modulation step size

 Data type : Decimal Numeric Program Data
Allowed suffices : RAD or RADS
Default suffix : RAD

:<src> Select modulation source where <src> is any one of: INTF1, INTF2, INTF3, INTF4, INTF5, INTF6, EXT1DC, EXT1AC, EXT1ALC, EXT2DC, EXT2AC or EXT2ALC

:ON Turn PM ON (local)
:OFF Turn PM OFF (local)
:UP Go UP one step
:DN Go DOWN one step
:RETN Return to original setting
:XFER Transfer current value to be the new setting

 Data type : None
Allowed suffices : None
Default suffix : None

 Examples: PM:DEVN 2.5RAD;INTF4;ON
 PM1:DEVN 1.5RAD;INC 0.1RAD;EXT1AC

PM? or PM1? or PM2? Prepares message containing information on Phase Modulation setting in one of the following formats:

:PM:DEVN <nr2>;<src>;<status>;INC <nr2>
:PM1:DEVN <nr2>;<src>;<status>;INC <nr2>
:PM2:DEVN <nr2>;<src>;<status>;INC <nr2>

where <src> is a program mnemonic representing the source of the modulation signal and <status> is a program mnemonic indicating whether the modulation is locally ON or OFF

Example: :PM2:DEVN 2.30;INTF4;OFF;INC 0.05

AMPLITUDE MODULATION

AM or AM1 or AM2 Set AM Depth (short form)
:DEPTH Set AM Depth
:INC Set AM step size

Data type : Decimal Numeric Program Data
 Allowed suffices : PCT
 Default suffix : PCT

:<src> Select modulation source where <src> is any one of: INTF1, INTF2, INTF3, INTF4, INTF5, INTF6, EXT1DC, EXT1AC, EXT1ALC, EXT2DC, EXT2AC or EXT2ALC

:ON Turn AM ON (local)
:OFF Turn AM OFF (local)
:UP Go UP one step
:DN Go DOWN one step
:RETN Return to original setting
:XFER Transfer current value to be the new setting

Data type : None
 Allowed suffices : None
 Default suffix : None

Examples: AM:DEPTH 30PCT;INTF4;ON
 AM1:DEPTH 40PCT;EXT1DC;ON

AM? or AM1? or AM2? Prepares message containing information on Amplitude Modulation setting in one of the following formats:

:AM:DEPTH <nr2>;<src>;<status>;INC <nr2>
 :AM1:DEPTH <nr2>;<src>;<status>;INC <nr2>
 :AM2:DEPTH <nr2>;<src>;<status>;INC <nr2>

where <src> is a program mnemonic representing the source of the modulation signal and <status> is a program mnemonic indicating whether the modulation is locally ON or OFF

Example: :AM1:DEPTH 56.6;INTF3;ON;INC 5.0

WIDEBAND FM

WBFM Set WBFM deviation (short form)
:DEVN Set WBFM deviation

Data type : Decimal Numeric Program Data
 Allowed suffices : Any one of: GHZ, MHZ, KHZ or HZ
 Default suffix : HZ

:ON Turn WBFM ON (local)
:OFF Turn WBFM OFF (local)
:AC Select AC coupling
:DC Select DC coupling

Data type : None
 Allowed suffices : None
 Default suffix : None

DCFMNL Perform DC FM/WBFM null operation

Examples: WBFM:DEVN 10MHZ;ON;AC
 WBFM:DEVN 13MHZ;ON;DC; :DCFMNL

WBFM? Prepares message containing information on Wideband Frequency Modulation setting in the following format:

:WBFM:DEVN <nr2>;<coupling>;<status>

where <coupling> is a program mnemonic indicating AC or DC coupling of the modulation signal and <status> is a program mnemonic indicating whether the modulation is locally ON or OFF

Example: :WBFM:DEVN 50000.0;AC;ON

PULSE MODULATION

PULSE

[not used alone]
:ON Turn Pulse modulation ON
:OFF Turn Pulse modulation OFF and select Low Intermodulation
:CAL:ENABLE Enable CW burst suppression mode
:DISABLE Disable CW burst suppression mode

Data type : None
Allowed suffices : None
Default suffix : None

Examples: PULSE:ON
PULSE:OFF
PULSE:CAL:DISABLE

PULSE?

Prepares message containing information on Pulse Modulation setting in the following format:

:PULSE:<status>

where: <status> is a program mnemonic indicating whether the modulation is ON or OFF

Examples: :PULSE:ON
:PULSE:OFF

PULSE:CAL?

Prepares message containing information on CW Burst Suppression mode in the following format:

:PULSE:CAL:<status>

where: <status> is a program mnemonic indicating whether CW burst suppression mode is ENABLED or DISABLED

Example: :PULSE:CAL:ENABLE

MODULATION FREQUENCY

INTF1 or INTF2 or INTF3 or INTF4 or INTF5 or INTF6 Set modulation oscillator frequency (short form)

:FREQ Set modulation oscillator frequency
:INC Set modulation oscillator frequency step size

Data type : Decimal Numeric Program Data
 Allowed suffices : Any one of: GHZ, MHZ, KHZ or HZ
 Default suffix : HZ

:SIN Select sinusoidal waveform
:TRI Select triangle waveform
:SQU Select square waveform
:UP Go UP one step
:DN Go DOWN one step
:RETN Return to original setting
:XFER Transfer current value to be the new setting

Data type : None
 Allowed suffices : None
 Default suffix : None

:PHASE Adjust phase of modulation oscillator

Data type : Decimal Numeric Program Data
 Allowed suffices : DEG
 Default suffix : DEG

:CTC1 Select tone number (0 to 15) from Continuous Tone Group 1
:CTC2 Select tone number (0 to 15) from Continuous Tone Group 2
:USER Select tone number (0 to 15) from Continuous Tone USER group
:TEMP Select tone number (0 to 15) from Continuous Tone TEMP group

Data type : Decimal Numeric Program Data
 Allowed suffices : None
 Default suffix : None

Examples: INTF1:FREQ 1.5KHZ;SIN
 INTF1:CTC1 3

INTF1? or INTF2? or INTF3? or INTF4? or INTF5? or INTF6? Prepares message containing information on modulation oscillator setting in one of the following formats:

:INTF1:FREQ <nr2>;INC <nr2>;<waveform>
 :INTF6:<standard> <nr1>

where: <waveform> is a program mnemonic (SIN or TRI) indicating the waveform shape and <standard> is a program mnemonic (CTC1, CTC2, USER or TEMP) indicating the continuous tone signalling standard selected.

Examples: :INTF2:FREQ 440.0;INC 100.0;SIN
 :INTF3:CTC1 5

CTCSS TONES EDIT

CTONES [not used alone]
:EDIT [not used alone]
:TNUM Select tone number 0-15
 Data type : Decimal Numeric Program Data
 Allowed suffices : None
 Default suffix : None
:TFRQ Set tone frequency
 Data type : Decimal Numeric Program Data
 Allowed suffices : Any one of: GHZ, MHZ, KHZ or HZ
 Default suffix : HZ
:LOAD Copy Standard to TEMP for editing
 Data type : Character Program Data (any one of: CTC1, CTC2 or USER)
 Allowed suffices : None
 Default suffix : None
:SAVE Save TEMP to USER after editing for non-volatile storage (if required)
 Data type : None
 Allowed suffices : None
 Default suffix : None

CTONES? [not used alone]

CTONES:EDIT? Prepares message containing information on the current tone number being edited and its frequency in the following format:
 :CTONES:EDIT:TNUM <nr1>;TFRQ <nr2>

Example: :CTONES:EDIT:TNUM 5;TFRQ 202.8

SEQUENTIAL TONES

SEQT	[not used alone]
:SEQ	Set Tone sequence
	Data type : String Program Data consisting of up to 16 characters from 0 to 9 and A to F between string delimiters (eg. "123C5" or '123C5'). For DTMF E and F are not allowed and are replaced by * and #.
	Allowed suffices : None
	Default suffix : None
:DUR	Set Duration Mask
	Data type : String Program Data consisting of up to 15 characters "-" or "E" between string delimiters (eg. "---E-" or '-E-')
	Allowed suffices : None
	Default suffix : None
:SEND	Send Sequence <i>n</i> times where <i>n</i> has the value 1 to 9 indicating the number of tone sequences to be sent, or 10 for continuous sending.
	Data type : Decimal Numeric Program Data
	Allowed suffices : None
	Default suffix : None
:STOP	Stop sending sequence.
	Data type : None
	Allowed suffices : None
	Default suffix : None
:MODE	[not used alone]
:STD	Select Tones standard
	Data type : Character Program Data (any one of: CCIR, EURO, DZVEI, ZVEI1, ZVEI2, EEA, EIA, NATEL, TEMP, USER1, USER2 or DTMF).
	Allowed suffices : None
	Default suffix : None
:MOD	Select Modulation Channel
	Data type : Character Program Data (any one of: AM1, AM2, FM1, FM2, PM1, PM2, TOTAL_AM, TOTAL_FM, TOTAL_PM or NO_TONES)
	Allowed suffices : None
	Default suffix : None
:PARAM	[not used alone]
:EXTD	Set the duration of the Extended tone.
:SDLY	Set Starting Delay
	Data type : Decimal Numeric Program Data
	Allowed suffices : MS
	Default suffix : MS
:SHFT	Set Frequency Shift (up to $\pm 10.0\%$)
	Data type : Decimal Numeric Program Data
	Allowed suffices : PCT
	Default suffix : PCT

SEQT:PARAM (continued)

:RPTT Select Repeat Tone
 Data type : String Program Data (any one of 0 to 9 or A to F between strings delimiters (eg. "E" or 'E')).
 Allowed suffices : None
 Default suffix : None

:TDUR Set DTMF Tone duration
:TGAP Set DTMF inter-element gap
 Data type : Decimal Numeric Program Data
 Allowed suffices : MS
 Default suffix : MS

:EDIT [not used alone]

:TNUM Select Number of Tone to Edit
 Data type : Decimal Numeric Program Data
 Allowed suffices : None
 Default suffix : None

:TFRQ Set Tone Frequency of tone selected by TNUM
 Data type : Decimal Numeric Program Data
 Allowed suffices : Any one of: GHZ, MHZ, KHZ or HZ
 Default suffix : HZ

:TDUR Set Normal Tone Duration
:TGAP Set Inter-element Gap
 Data type : Decimal Numeric Program Data
 Allowed suffices : MS
 Default suffix : MS

:LOAD Load a Standard to TEMP for editing
 Data type : Character Program Data (any one of: CCIR, EURO, DZVEI, ZVEI1, ZVEI2, EEA, EIA, NATEL, USER1 or USER2)
 Allowed suffices : None
 Default suffix : None

:SAVE Copy TEMP to USER1 or USER2
 Data type : Character Program Data (either USER1 or USER2)
 Allowed suffices : None
 Default suffix : None

Examples: SEQT:SEQ "12245B7";DUR "----E--"
 SEQT:MODE STD CCIR;MOD TOTAL FM
 SEQT:PARAM:EXTD 200MS;SHFT 0.5PCT
 SEQT:EDIT:TNUM 3;TFRQ 1342.7HZ;SAVE USER1

SEQT?

Prepares message containing information on the signalling sequence and duration settings in the following format:

:SEQT:SEQ <toneseq>;DUR <durseq>

where: <toneseq> is string program data defining the tone sequence and <durseq> is string program data defining the duration sequence.

Examples: :SEQT:SEQ "12245B7";DUR "----E--"
:SEQT:SEQ "12345*#9" (DTMF ONLY)

SEQT:MODE?

Prepares message containing information on the signalling standard and the modulation channel selected in the following format:

:SEQT:MODE:STD <standard>;MOD <modchannel>

where: <standard> is a program mnemonic defining the tone standard and <modchannel> is character program data defining the modulation channel allocated to tone signalling.

Example: :SEQT:MODE:STD ZVEI;MOD TOTAL_FM

SEQT:PARAM?

Prepares message containing information on signalling parameter settings in the following format:

:SEQT:PARAM:EXTD <nr1>;SHFT <nr2>;RPTT <rpt>;SDLY <nr1>

where: <rpt> is string program data defining the tone number used to represent the repeat tone.

Examples: :SEQT:PARAM:EXTD 200;SHFT -1.6;RPTT "E";SDLY 300
:SEQT:PARAM:SDLY 30;TDUR 100;TGAP 75 (DTMF ONLY)

SEQT:EDIT?

Prepares message containing information on signalling editing in the following format:

:SEQT:EDIT:TNUM <nr1>;TFREQ <nr2>;TDUR <nr1>;TGAP <nr1>

Example: :SEQT:EDIT:TNUM 3;TFREQ 1342.7;TDUR 40;TGAP 0

LF CONTROL

LF

[not used alone]
:ON Turn LF output ON
:OFF Turn LF output OFF
:GEN Select LF Generator

Data type : None
 Allowed suffices : None
 Default suffix : None

:MON

Select source monitor mode

Data type : Character Program Data (any one of: AM1S, AM2S, AMD, ANG1S, ANG2S, ANGD or OFF, where AM represents Amplitude Modulation, ANG represents Angular Modulation, the suffix 'S' indicates Source and 'D' indicates Drive)
 Allowed suffices : None
 Default suffix : None

Examples: LF:MON FM;ON
 LF:MON ANGD
 LF:GEN

LF?

Prepares message containing information on the LF operation in one of the following formats depending on which LF mode is currently in use:

:LF:GEN;<status>
 :LF:MON <source>;<status>

where: <source> is character program data representing the source being monitored and <status> is a program mnemonic indicating whether the output is ON or OFF.

Examples: :LF:GEN;ON
 :LF:MON AM1S;OFF

LF GENERATOR LEVEL

LFGL	Set LF Generator level (short form)
:VALUE	Set LF Generator level
	Data type : Decimal Numeric Program Data
	Allowed suffices : V, MV, UV, DBMV
	Default suffix : V
:INC	Set LF Generator level step
	Data type : Decimal Numeric Program Data
	Allowed suffices : DB
	Default suffix : DB
:UP	Go UP one step
:DN	Go DOWN one step
:RETN	Return to original setting
:XFER	Transfer current value to be the new setting
	Data type : None
	Allowed suffices : None
	Default suffix : None
:UNITS	Select default LF level units
	Data type : Character Program Data (DBM, DBV, DBMV, V, MV, or UV)
	Allowed suffices : None
	Default suffix : None
	Examples: LFGL:VALUE 75.6MV;INC 20DB
	LFGL:UP
LFGL?	Prepares the message containing information on LF Generator Level setting in the following format: :LFGL:UNITS<unit>;VALUE<nr2>;INC<nr2> where: <unit> is character programmed data defining the default LF level units (DBM, DBV, DBMV, V, MV or UV).
	Example: :LFGL:UNITS MV;VALUE 125.8;INC 1.0

MEMORY - STORE

STO [not used alone]

:FULL Full Store 0-49

:PART Partial Store 0-49

:CFRQ Carrier Freq Store 0-99

:SEQT Sequential Tones Store 0-19

:SWEEP Sweep Store 0-19

Data type : Decimal Numeric Program Data

Allowed suffices : None

Default suffix : None

Examples: :STO:FULL 17
:STO:CFRQ 83

MEMORY - RECALL

RCL [not used alone]

:FULL Recall Full 0-49

:FXCF Recall Full 0-49 (without carrier frequency)

:PART Recall Partial 0-49

:PXCF Recall Partial 0-49 (without carrier frequency)

:CFRQ Recall Carrier Freq 0-99

:SEQT Recall Sequential Tones Sequence 0-19

:SWEEP Recall Sweep 0-19

Data type : Decimal Numeric Program Data

Allowed suffices : None

Default suffix : None

Examples: :RCL:FULL 15
:RCL:CFRQ 75

MEMORY - ERASE

ERASE [not used alone]

:FULL Erase all Full Stores

:PART Erase all Partial Stores

:CFRQ Erase all Carrier Freq Stores

:SEQT Erase all Sequential Tones Stores

:SWEEP Erase all Sweep Stores

:ALL Erase all Stores

Data type : None

Allowed suffices : None

Default suffix : None

Examples: :ERASE:FULL 12
:ERASE:ALL

SWEEP OPERATION

IMODE	Select Instrument Mode
	Data type : Character Program Data (either NORMAL for signal generator operation or SWEEPER for swept operation)
	Allowed suffices : None
	Default suffix : None
	Example: IMODE SWEEPER
SWEEP	[not used alone]
:MKRON	Enable Sweep Markers
:MKROFF	Disable sweep Markers
	Data type : None
	Allowed suffices : None
	Default suffix : None
	Examples: SWEEP:CFRQ:START 75MHZ;STOP 150MHZ;STEP 100;TIME 10MS SWEEP:RFLV:START -56DBM;STOP -12DBM;STEP 440;TIME 25MS SWEEP:CFRQ:MKRNUM 1;VALUE 83MHZ;MKRON
:CFRQ	[not used alone]
:<cmd>	Select Carrier Frequency sweep parameter entry where <cmd> is replaced by one of the commands (START, STOP, STEP, TIME, MKRNUM, MKRON, MKROFF or VALUE)
:RFLV	[not used alone]
:<cmd>	Select RF Level sweep parameter entry where <cmd> is replaced by one of the commands (START, STOP, STEP, TIME, MKRNUM, MKRON, MKROFF or VALUE)
:LFGF	[not used alone]
:<cmd>	Select LF Generator Frequency sweep parameter entry where <cmd> is replaced by one of the commands (START, STOP, STEP, TIME, MKRNUM, MKRON, MKROFF or VALUE)
:LFGL	[not used alone]
:<cmd>	Select LF Generator Level sweep parameter entry where <cmd> is replaced by one of the commands (START, STOP, STEP, TIME, MKRNUM, MKRON, MKROFF or VALUE)
:INTF	[not used alone]
:<cmd>	Select Internal Modulation Oscillator Frequency sweep parameter entry where <cmd> is replaced by one of the commands (START, STOP, STEP, TIME, MKRNUM, MKRON, MKROFF or VALUE)
HOP	[not used alone]
:<cmd>	Select Frequency Hopping sweep parameter entry where <cmd> is replaced by TIME.

SWEEP (continued)

- :START** Select start value of the parameter to be swept.
- :STOP** Select stop value of the parameter to be swept.
 - Data type : As used for the parameter
 - Allowed suffices : As used for the parameter
 - Default suffix : As used for the parameter
- :STEP** Select number of steps in the sweep.
 - Data type : Decimal Numeric Program Data
 - Allowed suffices : None
 - Default suffix : None
- :TIME** Select time per sweep step
 - Data type : Decimal Numeric Program Data
 - Allowed suffices : MS
 - Default suffix : MS
- :MKRNUM** Select marker
 - Data type : Decimal Numeric Program Data
 - Allowed suffices : None
 - Default suffix : None
- :MKROFF** Turn Current Marker OFF
- :MKRON** Turn Current Marker ON
 - Data type : None
 - Allowed suffices : None
 - Default suffix : None
- :VALUE** Set Value of Current Marker
 - Data type : Decimal Numeric Program Data
 - Allowed suffices : As used for the parameter
 - Default suffix : As used for the parameter

SWEEP?

Prepares message containing information on Sweep Mode, Type and Marker status in the following format:

`:SWEEP:MODE <mode>;TYPE <type>;<status>`

where: <mode> is a program mnemonic representing the sweep mode selected, <type> is a program mnemonic representing the sweep type selected and <status> is a program mnemonic indicating whether the Marker output is ON or OFF.

Sample responses: `:SWEEP:MODE CONT;TYPE CFRQ;MKROFF`
 `:SWEEP:TYPE HOP:MODE SNGL`

SWEEP? (continued)

:CFRQ? Prepares message containing information on Carrier Frequency Sweep settings in the following format:

:SWEEP:CFRQ:START <nr2>;STOP <nr2>;STEP <nr1>;TIME <nr1>

Sample response: :SWEEP:CFRQ:START 1230000.0;STOP 1330000.0;STEP 100;TIME 20

:VALUE? Prepares message containing information on the current carrier frequency marker settings in the following format:

:SWEEP:CFRQ:MKRNUM <nr1>;VALUE <nr2>;<status>

where: <status> is a program mnemonic indicating whether the selected Marker is ON or OFF.

Sample response: :SWEEP:CFRQ:MKRNUM 2;VALUE 1240000.0;MKRON

:RFLV? Prepares message containing information on RF Level Sweep settings in the following format:

:SWEEP:RFLV:START <nr2>;STOP <nr2>;STEP <nr1>;TIME <nr1>

Sample response: :SWEEP:RFLV:START -107.0;STOP -27.0;STEP 80;TIME 50;

:VALUE? Prepares message containing information on the current RF level marker settings in the following format:

:SWEEP:RFLV:MKRNUM <nr1>;VALUE <nr2>;<status>

where: <status> is a program mnemonic indicating whether the selected Marker is ON or OFF.

Sample response: :SWEEP:RFLV:MKRNUM 2;VALUE -97.0;MKRON

:LFGF? Prepares message containing information on LF Generator Frequency Sweep settings in the following format:

:SWEEP:LFGF:START <nr2>;STOP <nr2>;STEP <nr1>;TIME <nr1>

Sample response: :SWEEP:LFGF:START 300.0;STOP 3000.0;STEP 2700;TIME 1

:VALUE? Prepares message containing information on the current LF generator frequency marker settings in the following format:

:SWEEP:LFGF:MKRNUM <nr1>;VALUE <nr2>;<status>

where: <status> is a program mnemonic indicating whether the selected Marker is ON or OFF.

Sample response: :SWEEP:LFGF:MKRNUM 2;VALUE 400.0;MKRON

:LFGL? Prepares message containing information on LF Generator Level Sweep settings in the following format:

:SWEEP:LFGL:START <nr2>;STOP <nr2>;STEP <nr1>;TIME <nr1>

Sample response: :SWEEP:LFGL:START 1.0;STOP 120.0;STEP 120;TIME 10

:VALUE? Prepares message containing information on the current LF generator level marker settings in the following format:

:SWEEP:LFGL:MKRNUM <nr1>;VALUE <nr2>;<status>

where: <status> is a program mnemonic indicating whether the selected Marker is ON or OFF.

Sample response: :SWEEP:LFGL:MKRNUM 2;VALUE 5.0;MKRON

:INTF? Prepares message containing information on Modulation Oscillator Frequency Sweep settings in the following format:

:SWEEP:INTF:START <nr2>;STOP <nr2>;STEP <nr1>;TIME <nr1>

Sample response: :SWEEP:INTF:START 270.0;STOP 3300.0;STEP 500;TIME 1

:VALUE? Prepares message containing information on the current modulation oscillator frequency marker settings in the following format:

:SWEEP:INTF:MKRNUM <nr1>;VALUE <nr2>;<status>

where: <status> is a program mnemonic indicating whether the selected Marker is ON or OFF.

Sample response: :SWEEP:INTF:MKRNUM 2;VALUE 2900.0;MKRON

:HOP? Prepares message containing information on Frequency Hopping Sweep in the following format:

:SWEEP:HOP:TIME<nr1>

SWEEP MODE/TYPE

SWEEP [not used alone]

:MODE Select Mode of operation for Sweep generator (single shot, continuous or externally triggered)

Data type : Character Program Data (any one of SNGL, CONT or EXT)

Allowed suffices : None

Default suffix : None

:TYPE Select Type of Sweep (Carrier Frequency, RF Level, LF Generator Frequency, LF Generator Level, Internal Modulation Oscillator Frequency or Off)

Data type : Character Program Data (any one of: OFF, CFRQ, RFLV, LFGF, LFGL, INTF1, INTF2, INTF3, INTF4, INTF5, INTF6, HOP or OFF)

Allowed suffices : None

Default suffix : None

Examples: :SWEEP:MODE SNGL;TYPE CFRQ
:SWEEP:MODE CONT;TYPE INTF4

SWEEP? Prepares message containing information on Sweep Mode, Type and Marker status in the following format:

:SWEEP:MODE <mode>;TYPE <type>;<status>

where: <mode> is a program mnemonic representing the sweep mode selected, <Type> is a program mnemonic representing the sweep type selected and <status> is a program mnemonic indicating whether the Marker output is ON or OFF.

Examples: :SWEEP:MODE CONT;TYPE CFRQ;MKROFF
:SWEEP:TYPE HOP:MODE SNGL

SWEEP CONTROL

SWEEP	[not used alone]
:GO	Commence Sweep
:CALC	Initiate Pre-calculation
:HALT	Pause Sweep
:CONT	Continue Sweep
:RESET	Reset sweep to Start Value
:XFER	Transfer Paused Value to Main Parameter
:UP	Go UP one sweep step while paused
:DN	Go DOWN one sweep step while paused

Data type : None
Allowed suffices : None
Default suffix : None

Examples: SWEEP:GO
SWEEP:RESET

FREQUENCY HOPPING

HOPSEQ

Enter frequency hopping sequence

Data type : Decimal Numeric Program data (can be multiple)
Allowed suffices : None
Default suffix : None

Examples: HOPSEQ 56, 72, 0, 4, 99, 72
HOPSEQ 255, 0, 4, 17, 23, 64, 72

HOPSEQ?

Returns a value 0-1024 indicating the number of steps in the Frequency Hopping Sequence.

MISCELLANEOUS COMMANDS

IMODE	Select Instrument Mode
	Data type : Character Program Data (either NORMAL for signal generator operation or SWEEPER for swept operation)
	Allowed suffices : None
	Default suffix : None
RPPR	Reset reverse power protection trip
	Data type : None
	Allowed suffices : None
	Default suffix : None
FSTD	Select internal or external frequency standard
	Data type : Character program data (any one of INT0, INT1, INT5, INT10, EXT1, EXT5 or EXT10)
	Allowed suffices : None
	Default suffix : None
	Examples: :FSTD INT10 :FSTD EXT5
FSTD?	Prepares message containing information on frequency standard selection in the format: :FSTD <char>
	Example: :FSTD EXT10
BLANK	Blank or unblank various parts of the display. The number sent after the command determines the action to be taken as follows: 0 blank or unblank the Carrier Frequency display 1 blank or unblank the RF Level display 2 blank or unblank the Modulation Frequency display 3 blank or unblank the Modulation display 4 blank all displays
	Data type : Decimal Numeric Program Data (any one of 0, 1, 2, 3 or 4)
	Allowed suffices : None
	Default suffix : None
	Examples: BLANK 0 BLANK 4

BACKL [not used alone]
:ON Backlighting On
:OFF Backlighting Off

Data type : None
Allowed suffices : None
Default suffix : None

Examples: BACKL:ON
BACKL:OFF

TIME? Prepares message containing information on current real time clock time setting in the format:

<HH:MM>

where: <HH:MM> is string program data representing the time in hours and minutes using the 24 hour clock notation.

Example: "17:55"

DATE? Prepares message containing information on current real time clock date setting in the format:

<YYYY-MM-DD>

where: <YYYY-MM-DD> is string program data representing the date in ISO notation (year number, month number, day number).

Example: "1990-04-01"

OPER? Prepares message containing information on total operating hours in the following format:

<nr2>

Example: 1453.0

ELAPSED? Prepares message containing information on elapsed operating hours since last reset in the following format:

<nr2>

Example: 454.5

- ERROR?** Prepares message containing the number of the next error in the error queue in the following format:
<nr1>
The numeric value returned is either that of the next error number or 0 if the queue is empty or 255 if the queue is full
Example: 37
- DEVTRG** Set Device Trigger Function (action on receipt of *TRG)
Data type : Character Program Data (any one of: SEQT, FLSWP, SSSWP or VOID)
Allowed suffices : None
Default suffix : None
- EXTTRG** Set External Trigger Function (action on Low signal being applied to External Trigger Socket).
Data type : Character Program Data (any one of: SEQT, FLSWP, SSSWP, MEMUP, MEMDN or VOID)
Allowed suffices : None
Default suffix : None
Examples: DEVTRG SEQT
EXTTRG MEMUP
- KLOCK** Disables keyboard entry except RPP Reset and Go to Local
Data type : None
Allowed suffices : None
Default suffix : None
- KUNLOCK** Enables keyboard entry
Data type : None
Allowed suffices : None
Default suffix : None

THE STATUS BYTE

The Status Byte provides information about events and conditions within the instrument. It may be read by a conventional Serial Poll or its value obtained as a response to the *STB? query. Bits 0 to 5 and bit 7 are each single bit Summary Messages which may be of two types (or not used at all).

- (i) Query Status - a '1' indicates that an associated Queue is non-empty and has data available to be read.
- (ii) Status Register Summary - reports the occurrence of an enabled event monitored by a Status Register Structure.

The Service Request Enable Register determines which of the bits can generate an SRQ, this register may be set by *SRE or read by *SRE?. If the bitwise -AND of the Status Byte and the Enable Register is non-zero the Flag Master Summary Status (<mss>) is True. Bit 6 of the Status byte value read by *STB? holds <mss>. However bit 6 of the Status Byte when Serial Polled is the Request For Service bit used to determine which device on the Bus has asserted SRQ, and is cleared by a Serial Poll.

The IEEE 488.2 Standard defines bit 4 as Message Available (<mav>), the Queue Summary for the Output Buffer, indicating whether any part of a Response Messages is available to be read. Bit 5 is the Event Summary Bit (<esb>), the Summary Message from the Standard Event Status Register.

In 2030 series, bit 7 is a Queue Summary for the Error Queue. Bits 1, 2, and 3 are Status summaries for the Instrument Status, Coupling Status and Hardware Status Registers. Bit 0 is unused.

STATUS DATA STRUCTURE - REGISTER MODEL

Below is a generalised model of the Register Set which funnels the monitored data into a single summary bit to set the appropriate bit in the Status Byte.

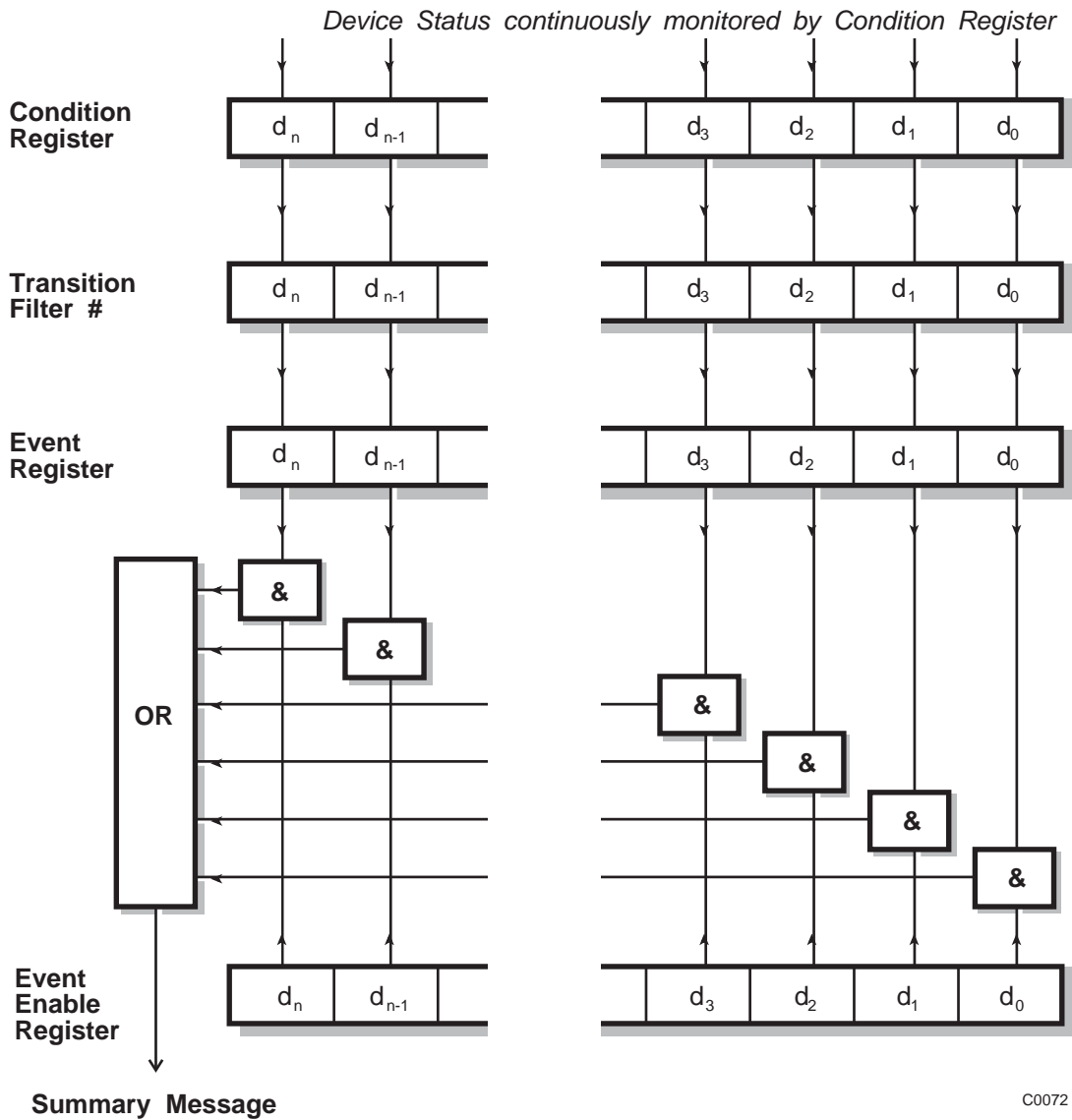

Notes...

The Device Status is continuously monitored by the Condition Register. If a Query to read a Condition Register is provided, the Response represents the Status of the instrument at the moment the Response is generated. A Condition Register cannot be written to.

The Transition Filter determines which transition of the Condition Register data bits will set the corresponding bit in the Event Register. Either positive-going, negative-going or both transitions can set bits in an Event Register. But in the 2030 series the Transition Filters are pre-set as either Positive or Negative, as described in the following pages.

The bits in an Event Register are "latched". Once set they remain set, regardless of subsequent changes in the associated condition bit until the Event Register is cleared by being read or by the *CLS common command. Once cleared, an Event Register bit will only be set again if the appropriate change in the Condition bit occurs.

The Event Enable Register may be both written to and read from. It is bitwise AND-ed with the Event Register and if the result is non-zero the Summary Message is true, otherwise the Summary Message is false. Enable Registers are not affected by *CLS but are however clear at power-on.

STANDARD EVENT REGISTERS

This Register is defined by IEEE 488.2 and each bit has the meaning shown below:

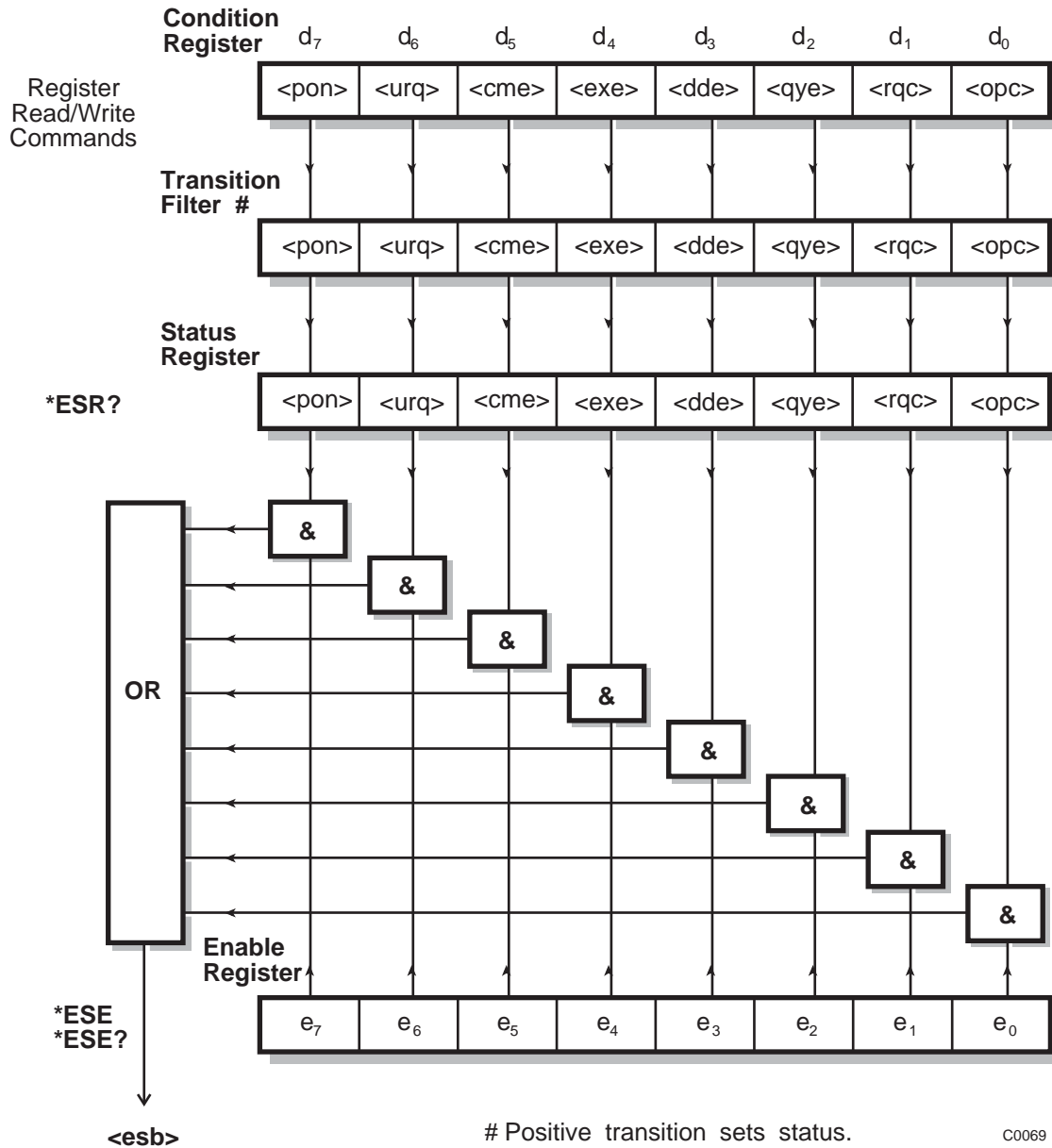

- <pon> power on
- <urq> user request - used by screen edit facility
- <cme> command error
- <exe> execution error
- <dde> device dependent error
- <qye> query error
- <rqc> request control - not implemented in this product
- <opc> operation complete - set in response to the *OPC command for synchronisation.
- <esb> standard event register summary bit

HARDWARE EVENT REGISTERS

This is a device dependant Register and the bits have meanings as shown in the list at the bottom of the page.

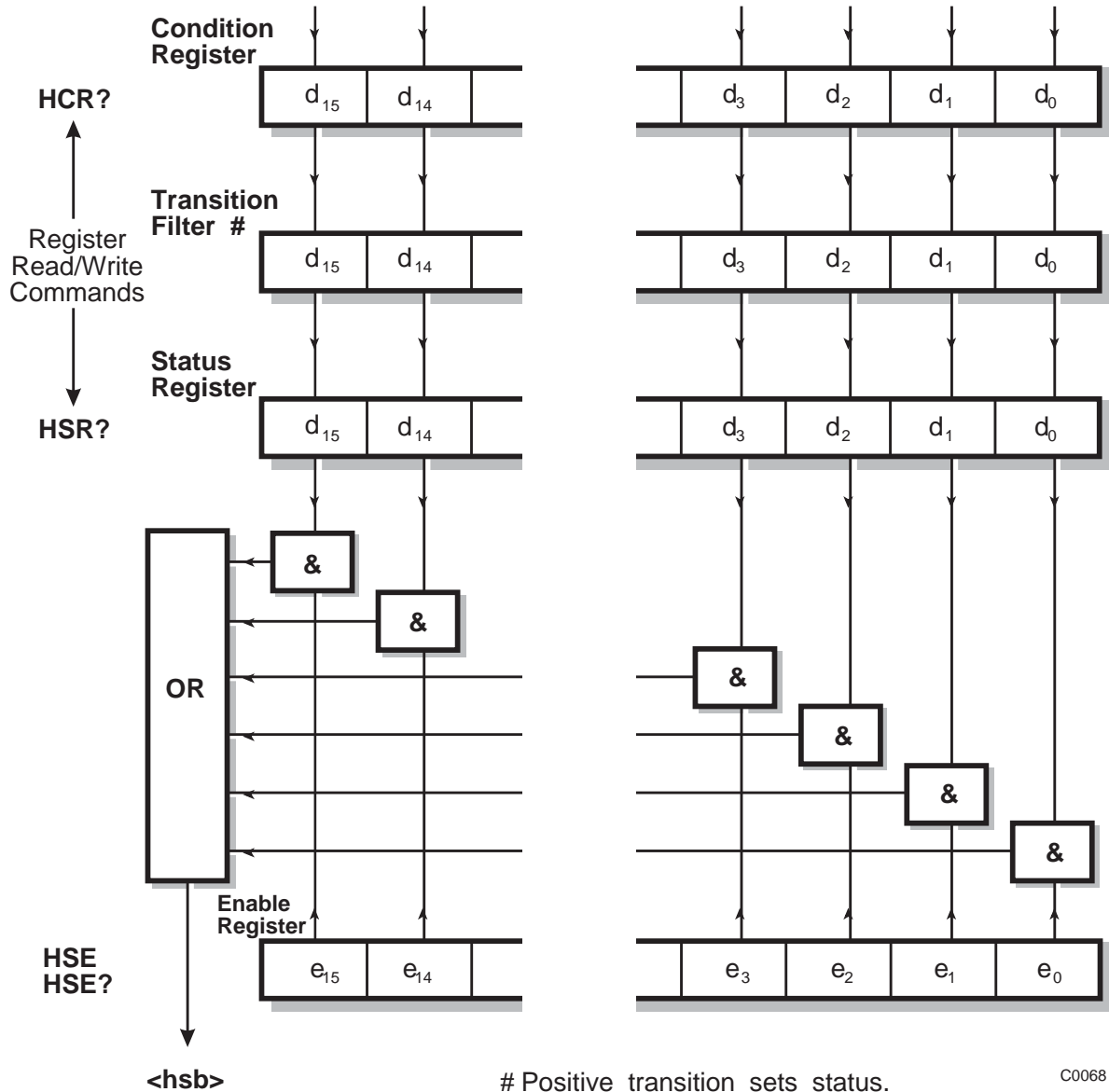

- | | | | |
|----------------|---|-----------------|-----------------------|
| d ₀ | reverse power protection tripped | d ₈ | not used |
| d ₁ | fractional-n system out-of-lock | d ₉ | not used |
| d ₂ | vcxo out-of-lock | d ₁₀ | not used |
| d ₃ | frequency standard missing | d ₁₁ | not used |
| d ₄ | external mod 1 alc loop signal too low | d ₁₂ | not used |
| d ₅ | external mod 1 alc loop signal too high | d ₁₃ | not used |
| d ₆ | external mod 2 alc loop signal too low | d ₁₄ | rf level uncalibrated |
| d ₇ | external mod 2 alc loop signal too high | d ₁₅ | extended hysteresis |
- <hsb> hardware event register summary bit

COUPLING EVENT REGISTERS

This is a device dependant Register and the bits have meanings as shown in the list at the bottom of the page.

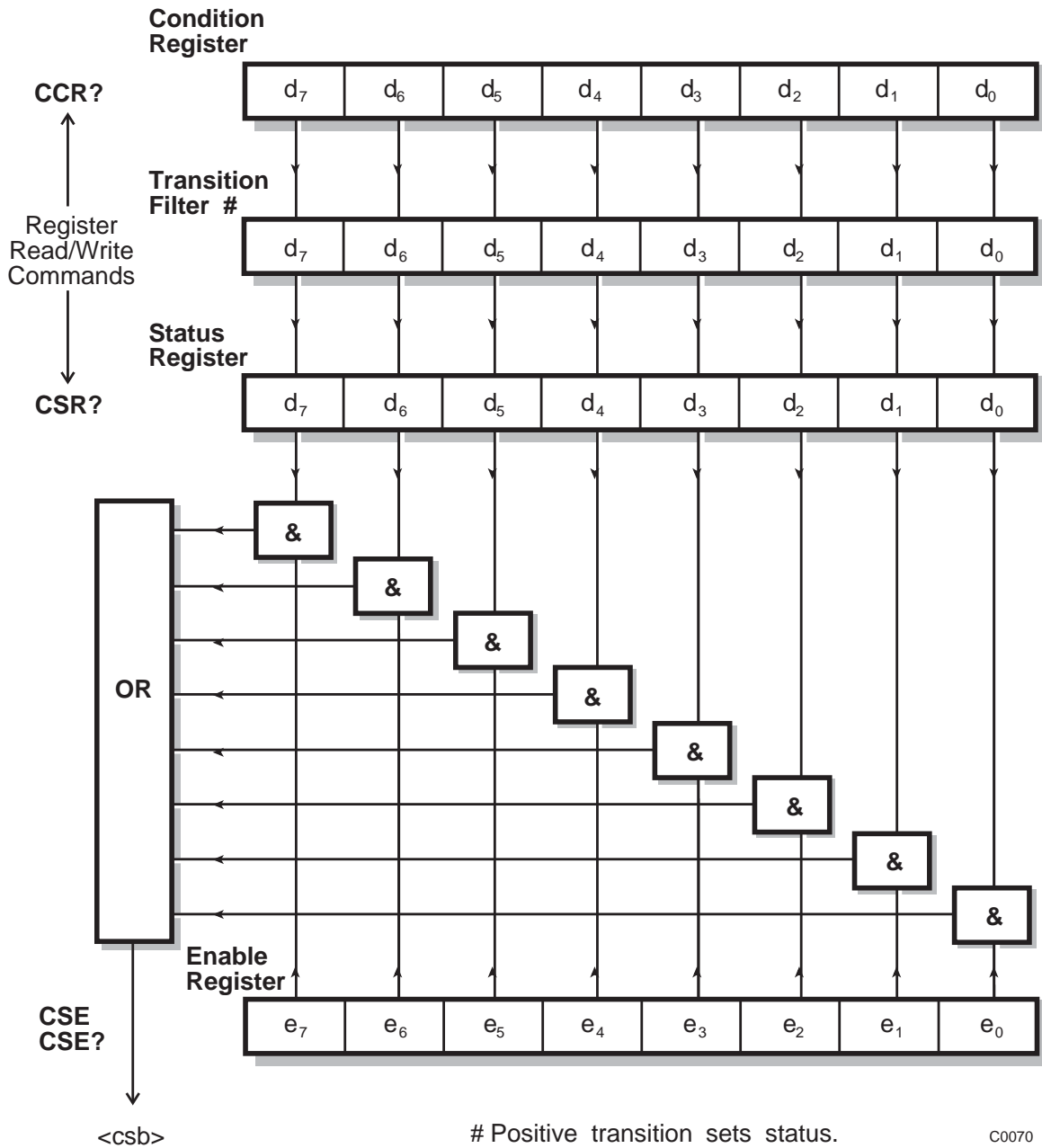

- d₀ rf level restricted by requested am
- d₁ fm restricted by requested carrier frequency
- d₂ widebandfm restricted by requested carrier frequency
- d₃ am2 depth restricted by requested am1 depth
- d₄ fm2 deviation restricted by requested fm1 deviation
- d₅ pm2 deviation restricted by requested pm1 deviation
- d₆ number of sweep steps restricted by other parameters
- d₇ not used
- <csb> coupling event register summary bit

INSTRUMENT EVENT REGISTERS

This is a device dependant Register and the bits have meanings as shown in the list at the bottom of the page.

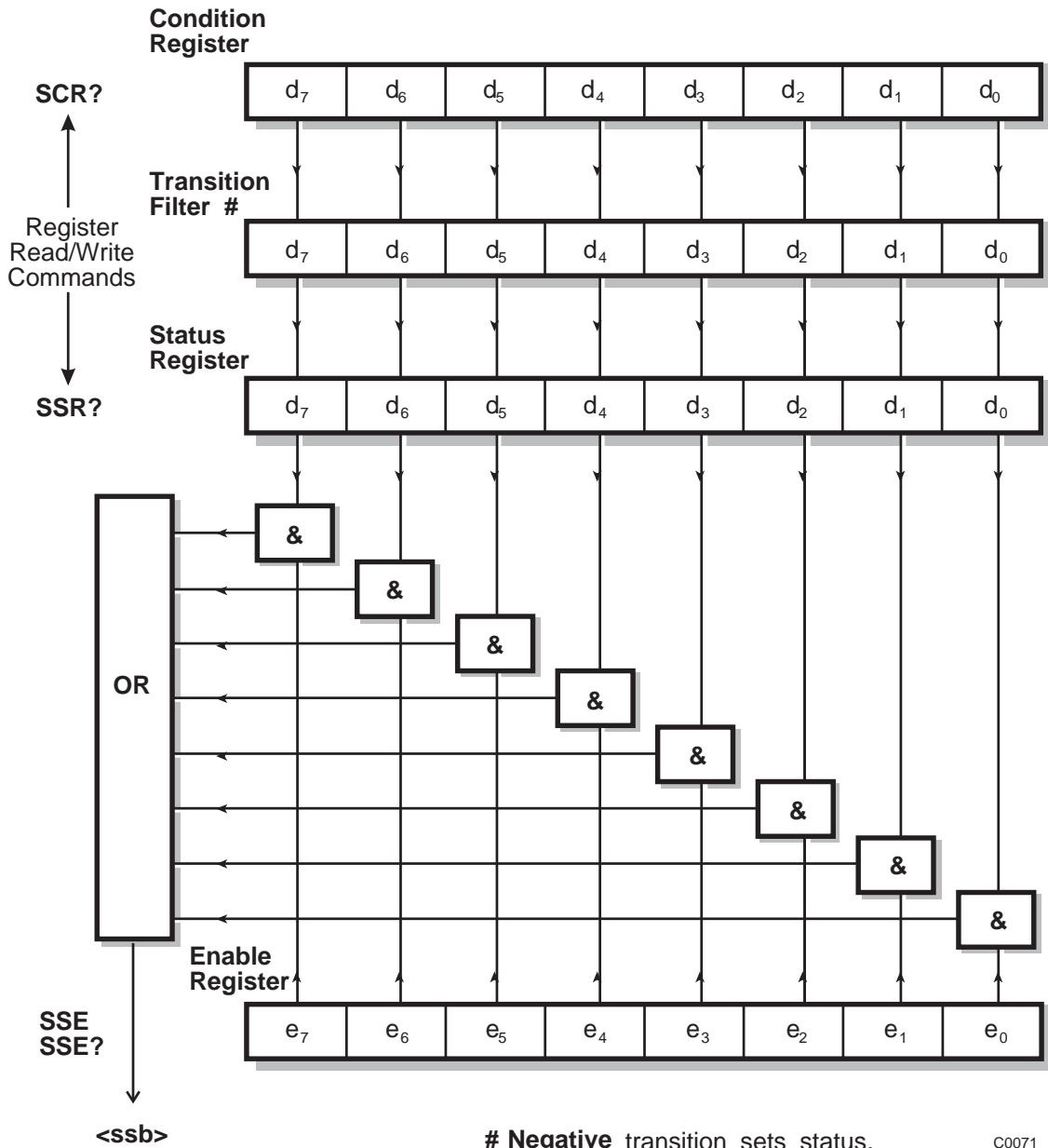

Negative transition sets status.

C0071

	<u>Condition (*SCR?)</u>	<u>Event Status (*SSR?)</u>
d ₀	sweep in progress	end of sweep
d ₁	sending tones	tones sent
d ₂	selfcal in progress	selfcal completed
d ₃	dc fm null in progress	dc fm null completed
d ₄	not used	not used
d ₅	not used	not used
d ₆	not used	not used
d ₇	not used	not used
<ssb>	instrument event register summary bit	

QUEUE FLAG DETAILS

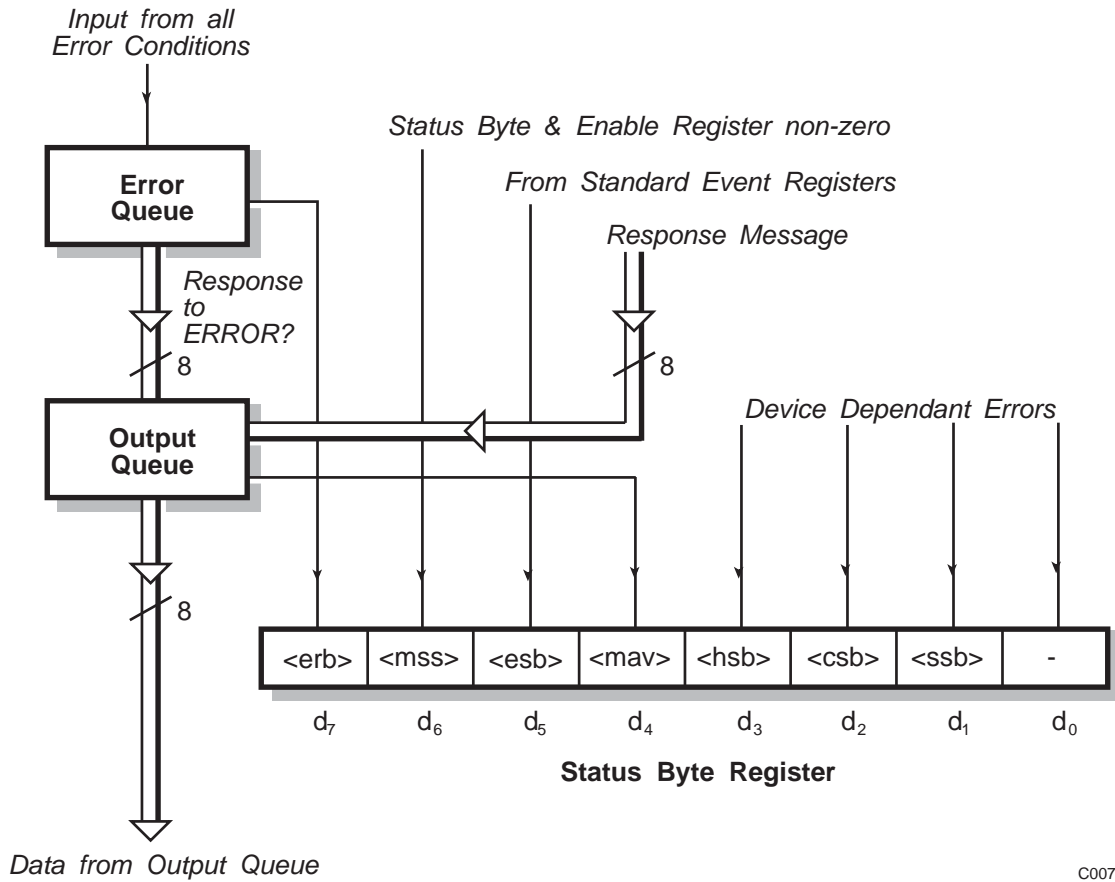

C0075

The **<mav>** status bit is set when one or more bytes are available to be read from the Output Queue.

The **<erb>** status bit is set when one or more errors are present in the Error Queue. The **ERROR?** query will place a **nr1** response message in the Output Queue representing the Error at the head of the queue, if the queue is empty then this message will be 0.

STATUS BYTE WHEN READ BY *STB?

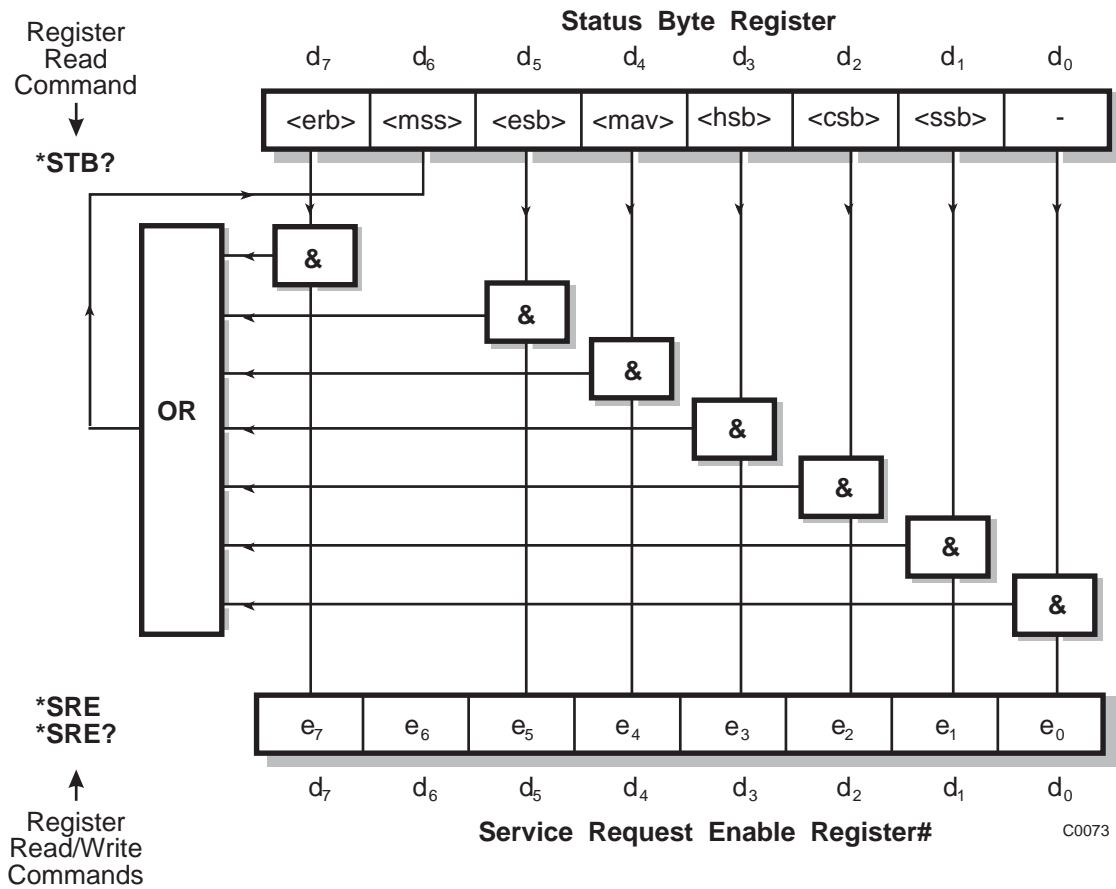

C0073

Bit 6 in this register ignores data sent by *SRE and always returns 0 in response to *SRE?

<rq>, <esb> and <mav> are defined in IEEE 488.2

<erb> is a device defined queue summary bit indicating that the error queue is non-empty.

<mss> is true when (Status Byte) AND (Enable register) > 0.

<esb> is the standard event register summary bit.

<mav> is 'message available' indicating that the output queue is non-empty.

<hsb> is 'hardware status' summary bit

<csb> is 'coupling status' summary bit

<ssb> is 'instrument status' summary bit

Note...

The Status Byte Register is Not cleared by the *STB? query.

STATUS BYTE WHEN READ BY SERIAL POLL

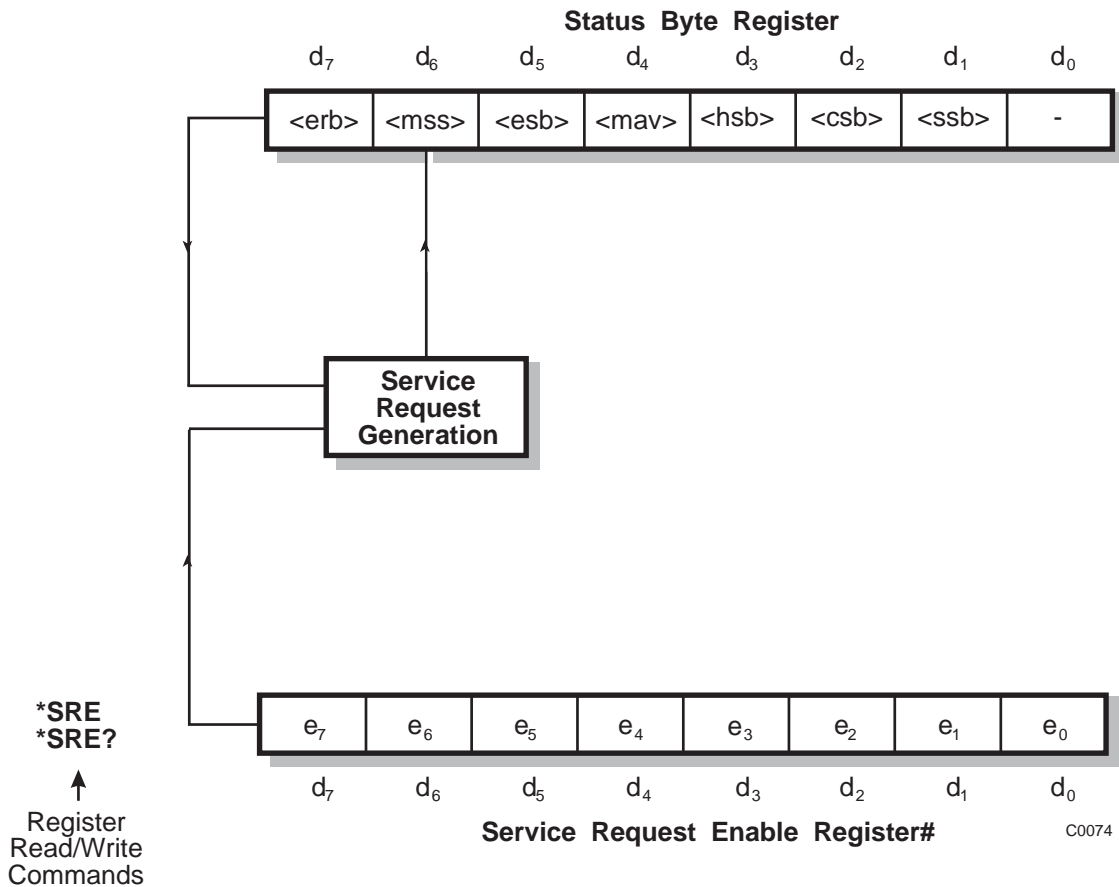

C0074

Bit 6 in this register ignores data sent by *SRE and always returns 0 in response to *SRE?

<erb> is a device defined queue summary bit indicating that the error queue is non-empty.

<rqs> is set by a request for service and is cleared by the poll.

<esb> is the standard event register summary bit.

<mav> is 'message available' indicating that the output queue is non-empty.

<hsb> is 'hardware status' summary bit

<csb> is 'coupling status' summary bit

<ssb> is 'instrument status' summary bit

<rqs>, <esb> and <mav> are defined in IEEE 488.2

<rqs> (request for service) will produce an SRQ at the controller. It is set by a change to either the Status Byte or the Service Enable Register that results in a New Reason for Service. It is cleared when <mss> goes FALSE (i.e. no reason for service) or by Serial Poll.

SUMMARY OF STATUS REPORTING COMMANDS AND QUERIES

*CLS	Clears Status Registers and the Error Queue
*ESE<nrf>	Writes to Standard Event Enable Register
*ESE?	Reads from Standard Event Enable Register
*ESR?	Reads from Standard Event Status Register
*SRE<nrf>	Writes to Service Request Enable Register
*SRE?	Reads from Service Request Enable Register
*STB?	Reads from Status Byte Register
CCR?	Reads from Coupling Condition Register
CSE<nrf>	Writes to Coupling Status Enable Register
CSE?	Reads from Coupling Status Enable Register
CSR?	Reads from Coupling Status Register
HCR?	Reads from Hardware Condition Register
HSE<nrf>	Writes to Hardware Status Enable Register
HSE?	Reads from Hardware Status Enable Register
HSR?	Reads from Hardware Status Register
SCR?	Reads from Instrument Condition Register
SSE<nrf>	Writes to Instrument State Enable Register
SSE?	Reads from Instrument State Enable Register
SSR?	Reads from Instrument State Status Register
<nrf>	Decimal Numeric Program Data

All of the above queries respond with a nr1 numeric format.

Chapter 4-1

BRIEF TECHNICAL DESCRIPTION

INTRODUCTION

The 2030 series signal generators cover a wide range of frequencies from 10 kHz to 1.35 GHz (2030), 10 kHz to 2.7 GHz (2031) and 10 kHz to 5.4 GHz (2032). Output levels from -144 or -138 dBm to +13 dBm (+19 dBm on 2030 with Option 003 fitted) are available. The simplified block schematic diagram for the instrument is shown in Fig. 4-1.

MODULATION

The carrier frequency can be frequency, phase or amplitude modulated from internal or external modulation sources. A maximum of four modulation channels can be made available by the use of the internal oscillator and a second optional internal oscillator together with two external modulation signals applied to the EXT MOD 1 INPUT and EXT MOD 2 INPUT connectors on the front panel.

FREQUENCY GENERATION

Four voltage controlled oscillators (VCOs) covering the frequency range 675 to 1350 MHz are phase locked to a 10 MHz oven controlled crystal oscillator using a fractional-N synthesizer system. Additional frequency coverage is achieved by means of frequency division or multiplication. Low frequencies are generated by a beat frequency oscillator (BFO) system.

DISPLAY

The display is a high definition dot matrix liquid crystal panel with backlighting to cater for variations in ambient light conditions. The display can be adjusted for both contrast and brightness.

CONTROL

The 2030 series are menu driven instruments. Main menus are displayed by the use of hard keys, and parameters are changed by means of soft keys which change as the menu changes. Internal control of the instruments is achieved by a microprocessor which receives data from the various controls and sends instructions via an internal 8-bit data bus to the signal processing circuits.

The instruments can also be controlled by the built in general purpose interface bus (GPIB). This facility enables the instruments to be used both as manually operated bench mounted instruments or as part of a fully automated test system.

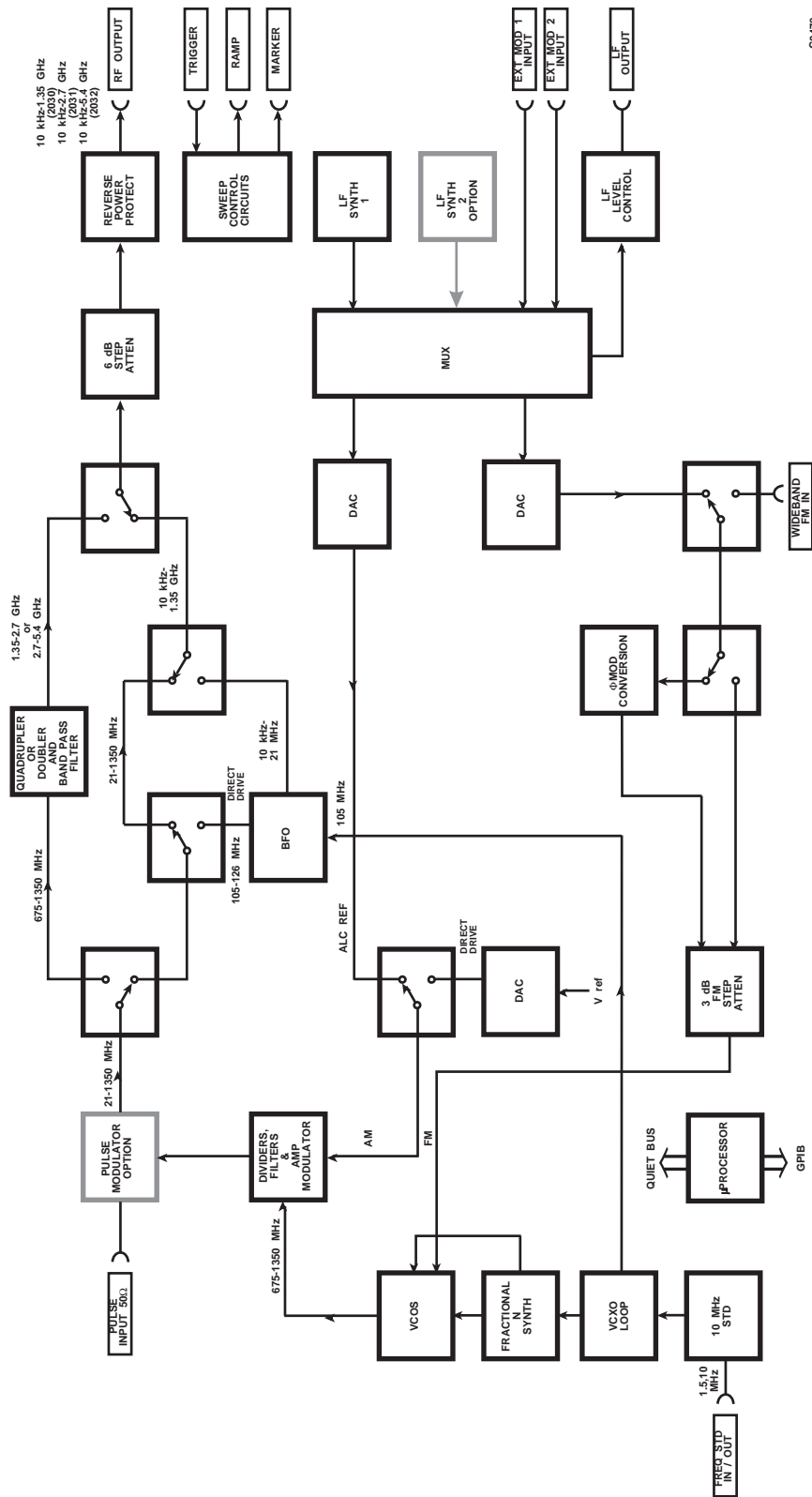

C0478

Fig. 4-1-1 Block schematic diagram

Chapter 5-1 ACCEPTANCE TESTING

CONTENTS

	PAGE
INTRODUCTION	5-1-3
RECOMMENDED TEST EQUIPMENT.....	5-1-3
TEST PROCEDURES	5-1-4
RF OUTPUT	5-1-4
ALC linearity	5-1-5
Attenuator accuracy	5-1-6
Alternative attenuator functional check.....	5-1-7
CARRIER FREQUENCY ACCURACY	5-1-8
MODULATION OSCILLATOR.....	5-1-9
Modulation oscillator frequencies	5-1-9
Modulation oscillator distortion.....	5-1-10
LF OUTPUT	5-1-11
Level accuracy	5-1-11
Frequency response.....	5-1-12
EXTERNAL MODULATION	5-1-13
Mod ALC on flatness.....	5-1-13
Modulation ALC distortion	5-1-14
INTERNAL AM DEPTH AND DISTORTION.....	5-1-15
AM scale shape	5-1-16
Phase modulation on AM.....	5-1-16
EXTERNAL AM.....	5-1-17
INTERNAL FM DEVIATION.....	5-1-18
FM attenuator.....	5-1-18
FM scale shape.....	5-1-19
EXTERNAL FM.....	5-1-20
CARRIER FREQUENCY OFFSET	5-1-22
INTERNAL PHASE MODULATION.....	5-1-23
Internal phase modulation flatness	5-1-23
SPECTRAL PURITY	5-1-25
Residual FM.....	5-1-25
Carrier harmonics.....	5-1-26
Carrier sub-harmonics (2031 and 2032 only).....	5-1-26
Non-harmonics.....	5-1-27
SSB phase noise.....	5-1-28
LAST COMPLETE CHECK DATE	5-1-28
CALIBRATION DUE DATE.....	5-1-29
REAL TIME CLOCK BATTERY	5-1-29

LIST OF TABLES

Table 5-1-1 Recommended test equipment	5-1-3
Table 5-1-2 Frequency settings for output levels	5-1-5
Table 5-1-3 Attenuator frequency settings	5-1-7
Table 5-1-4 Carrier frequencies	5-1-8
Table 5-1-5 Modulation oscillator frequencies.....	5-1-9
Table 5-1-6 Distortion frequency settings	5-1-10
Table 5-1-7 Level accuracy output levels.....	5-1-11
Table 5-1-8 Frequency response test frequencies.....	5-1-12
Table 5-1-9 External modulation frequencies	5-1-14

Table 5-1-10	AM depth and distortion frequencies.....	5-1-15
Table 5-1-11	AM depths	5-1-16
Table 5-1-12	External AM test frequencies.....	5-1-17
Table 5-1-13	FM attenuator deviations	5-1-18
Table 5-1-14	FM scale shape deviations	5-1-19
Table 5-1-15	External FM response frequencies.....	5-1-21
Table 5-1-16	Modulation source frequencies	5-1-24
Table 5-1-17	Carrier harmonic frequencies.....	5-1-26
Table 5-1-18	Carrier sub-harmonic frequencies.....	5-1-27
Table 5-1-19	Carrier non-harmonic frequencies	5-1-27

LIST OF FIGURES

Fig. 5-1-1	RF output test set-up.....	5-1-5
Fig. 5-1-2	Attenuator accuracy test set-up.....	5-1-6
Fig. 5-1-3	Carrier frequency accuracy test set-up.....	5-1-8
Fig. 5-1-4	Modulation oscillator frequencies test set-up.....	5-1-9
Fig. 5-1-5	Modulation oscillator distortion test set-up.....	5-1-10
Fig. 5-1-6	Level accuracy test set-up.....	5-1-11
Fig. 5-1-7	External modulation test set-up	5-1-13
Fig. 5-1-8	Modulation ALC distortion test set-up.....	5-1-14
Fig. 5-1-9	Internal AM depth and distortion test set-up	5-1-15
Fig. 5-1-10	External AM test set-up	5-1-17
Fig. 5-1-11	External FM test set-up.....	5-1-20
Fig. 5-1-12	Residual FM test set-up	5-1-25
Fig. 5-1-13	Carrier harmonics test set-up	5-1-26
Fig. 5-1-14	SSB phase noise test set-up	5-1-28

INTRODUCTION

Test procedures described in this chapter may be simplified and of restricted range compared with those that relate to the generally more comprehensive factory test facilities which are necessary to demonstrate complete compliance with the specifications.

Performance limits quoted are for guidance and should not be taken as guaranteed performance specifications unless they are also quoted under 'Performance Data' in Chapter 1.

When making tests to verify that the instrument meets the stated performance limits, always allow for the uncertainty of the test equipment.

For those signal generators with options fitted, the appendixes at the end of this Chapter and the Annexes at the end of this manual must be referred to.

RECOMMENDED TEST EQUIPMENT

The test equipment recommended for acceptance testing is shown in Table 5-1-1. Alternative equipment may be used provided it complies with the stated minimum specification.

Table 5-1-1 Recommended test equipment

Description	Minimum specification	Example
Power meter	±0.1 dB from 10 kHz to 5.4 GHz	IFR 6960B and 6910 or 6912 sensor
Measuring receiver	0 dBm to -127 dBm; 2.5 to 1300 MHz	HP8902A and 11722A sensor and 11793A down converter#
Signal generator	8 dBm from 32.5 MHz to 5.4 GHz	IFR 2032
Frequency counter	10 Hz to 5.4 GHz	ETP 535B or IFR† 2440
Audio analyzer	Capable of measuring THD below 0.03% from 50 Hz to 20 kHz. Capable of measuring 0.5 mV ±3% and levels at 10 Hz	Rohde & Schwarz UPA3
Digital multimeter	DC to 500 kHz, 1 mV to 5 V	Datron 1061A
Modulation meter	AM, FM and ΦM. 1.5 MHz to 1 GHz. Accuracy better than 1.1%. Modulation freqs from 30 Hz to 50 kHz. Capable of measuring Residual FM less than 7 Hz.	IFR 2305 plus distortion option*
Spectrum analyzer	10 kHz to 16.2 GHz Capable of measuring less than -70 dBm.	IFR 2386
Function generator	DC to 500 kHz sine ±0.6 dB flatness	HP3325B

* The distortion option of the 2305 Modulation Meter allows modulation distortion tests to be carried out with greater ease. If a 2305 with a distortion option is not available, the Audio Analyzer may be connected to the Modulation Meter LF output and set to measure distortion.

If receiver and down converter are not available, an alternative procedure to ensure attenuator pad accuracy using a power meter is given.

TEST PROCEDURES

Before each test, it is recommended that the UUT is reset to its switch-on conditions which are as follows:

Carrier freq	1.35 GHz (2030), 2.7 GHz (2031), 5.4 GHz (2032)
RF level	-144 dBm
FM	0 Hz ON
Single modulation mode	
Modulation	ENABLED

RF OUTPUT

SPECIFICATION	
Level range:	-127 dBm to +13 dBm (usable to -144 dBm)
Accuracy:	<p>(2030, 2031 and 2032) ± 0.85 dB from 10 kHz to 1.35 GHz at levels > -127 dBm ± 0.50 dB from 10 kHz to 1.35 GHz at levels > 0 dBm</p> <p>(2031 and 2032) ± 1.0 dB from 1.35 GHz to 2.7 GHz at levels > -127 dBm ± 0.7 dB from 1.35 GHz to 2.7 GHz at levels > 0 dBm</p> <p>(2032 only) ± 1.5 dB from 2.7 GHz to 5.4 GHz at levels > -100 dBm ± 1.5 dB from 2.7 GHz to 5.4 GHz at levels > -50 dBm ± 1.0 dB from 2.7 GHz to 5.4 GHz at levels > 0 dBm</p>

TEST EQUIPMENT		
Description	Minimum specification	Example
RF power meter	± 0.1 dB from 30 kHz to 2.7 GHz	IFR 6960B and 6910 or 6912 sensor
Measuring receiver	0 dBm to -127 dBm; 2.5 MHz to 1300 MHz	HP 8902A and 11722A sensor and 11793A down converter
Signal generator	8 dBm from 32.5 MHz to 5.4 GHz	IFR 2032

TEST PROCEDURES

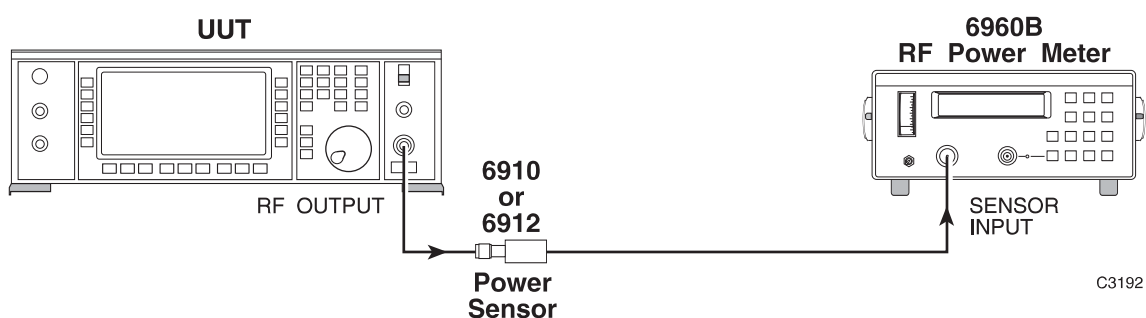

Fig. 5-1-1 RF output test set-up

- (1) Connect the test equipment as shown in Fig. 5-1-1.
- (2) Set the UUT to [RF Level] 0 dBm [Carrier Freq.] 30 kHz.
- (3) Check that the output level is within specification at the frequencies shown in Table 5-1-2.

When checking a 2032 signal generator, the 6912 sensor must be replaced with 6910 sensor for frequencies above 2700 MHz.

- (4) Set the UUT RF output to 7 dBm and repeat (3) above.
- (5) Set the UUT RF output to 13 dBm and repeat (3) above.

Table 5-1-2 Frequency settings for output levels

	FREQUENCY (MHz)			
(2030/1/2)	1125	2025	2925	4425
0.03	1275	2175	3075	4575
0.1	1350	2325	3225	4725
75		2475	3375	4875
225	(2031/2)	2625	3525	5025
375	1351	2700	3675	5175
525	1425		3825	5325
675	1575	(2032)	3975	5400
825	1725	2701	4125	
975	1875	2775	4275	

ALC linearity

- (1) Connect the test equipment as shown in Fig. 5-1-1.
- (2) Set the UUT to [RF Level] 0 dBm [Carrier Freq.] 2.5 MHz.
- (3) Increment the RF output of the UUT in 1 dB steps up to 12 dBm and in 0.1 dB steps up to 13 dBm, measuring the RF level at each step. Check that the RF output level variation is within ± 0.1 dB.
- (4) Set the UUT carrier frequency to 500 MHz and repeat (3) above.
- (5) Set the UUT carrier frequency to 2.7 GHz and repeat (3) above.
- (6) Replace the 6912 sensor with the 6910 sensor, set the UUT carrier frequency to 5.4 GHz and repeat (3) above.

Attenuator accuracy

The following test will confirm that the attenuator performs to the published performance specification. In the event of the receiver/down converter not being available, an alternative method to functionally test the attenuator is also suggested (see 'Alternative attenuator functional check' below).

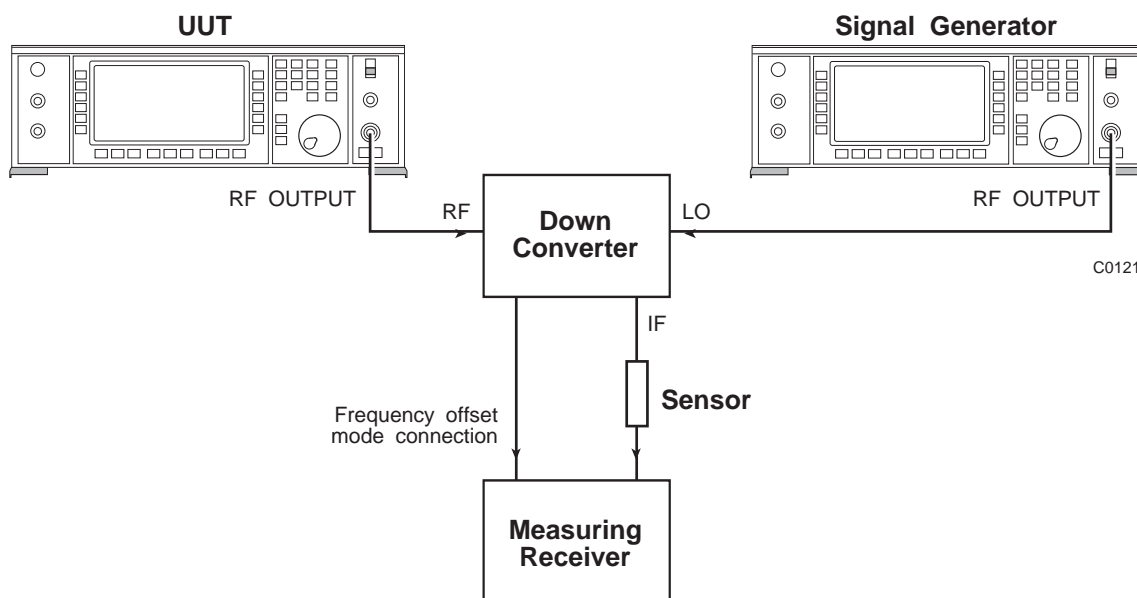

Fig. 5-1-2 Attenuator accuracy test set-up

- (1) Connect the test equipment as shown in Fig. 5-1-2.
- (2) Set the UUT to [RF Level] 0 dBm [Carrier Freq.] 2.5 MHz.
- (3) Tune the receiver to 2.5 MHz and measure the RF level.
- (4) Set the UUT to [RF Level] -6.1 dBm and measure the RF level.
- (5) Decrement the output of the UUT in 6 dB steps down to an RF level of -120.1 dBm measuring the RF level at each step. Check that the measured level is within specification.
- (6) Repeat (2) to (5) at the frequencies given in Table 5-1-3.
- (7) Set the local oscillator to +8 dBm at the frequencies indicated in brackets in Table 5-1-3.

Table 5-1-3 Attenuator frequency settings

Frequency (MHz)		
2030/1/2	*2031/2	**2032
2.5	1725 (1662)	2775 (2712)
31	2700 (2637)	4125 (4062)
325		5400 (5337)
1125		
1275		

*At frequencies above 1300 MHz the down converter will automatically be enabled.

**At frequencies above 2700 MHz it is only necessary to test down to -96.1 dBm (determined by 8902 accuracy).

The frequency of the local oscillator will have to be entered on the receiver followed by the test frequency. This will automatically set the receiver to the required IF frequency.

Alternative attenuator functional check

- (1) Connect the test equipment as shown in Fig. 5-1-1.
- (2) Set the UUT to [*Carrier Freq.*] 1.35 GHz [*RF Level*] 13 dBm.
- (3) Set a reference on the power meter.
- (4) Using the latch poke facility on the UUT, select each attenuator pad individually as follows:

[UTIL] [*Utils. Menu 2*] [*Latch Data*] 95 [enter]
 [*Decimal/Binary*]

The binary latch data will now appear in the bottom right-hand side of the display.

- (5) By using the [*Toggle Bit*] and the [*Cursor Left*] [*Cursor Right*] soft keys, select each attenuator pad in turn which should give the nominal readings on the power meter in the following sequence:

-24 dB -36 dB -6 dB -12 dB -24 dB -36 dB

Note that no software correction is applied to the attenuator when performing this test.

CARRIER FREQUENCY ACCURACY

SPECIFICATION	
Frequency range:	10 kHz to 1.35 GHz (2030) 10 kHz to 2.7 GHz (2031) 10 kHz to 5.4 GHz (2032)
Accuracy:	Determined by the frequency standard accuracy
Resolution:	0.1 Hz

TEST EQUIPMENT		
Description	Minimum specification	Example
Frequency counter	10 kHz to 5.4 GHz	ETP 535B or IFR 2440

TEST PROCEDURES

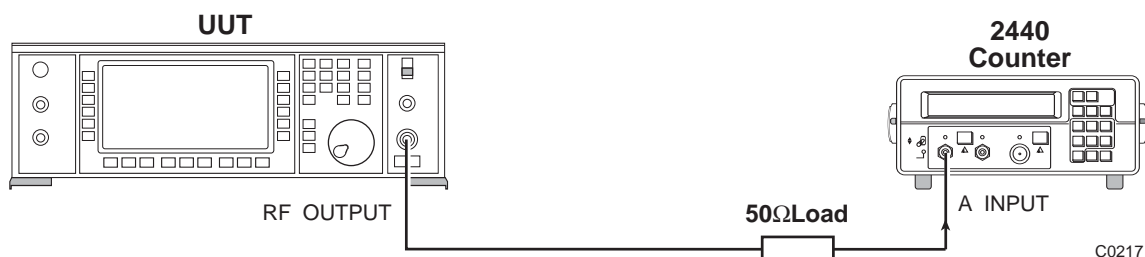

Fig. 5-1-3 Carrier frequency accuracy test set-up

- (1) Connect the test equipment as shown in Fig. 5-1-3.
- (2) Set the UUT to [RF Level] 0 dBm [Carrier Freq.] 10 kHz.
- (3) Referring to Table 5-1-4, check that the carrier frequencies can be selected correctly and are within specification. It will be necessary to disconnect the 50 ohm load and reconnect the UUT RF OUTPUT to the B input and C input where indicated.

Table 5-1-4 Carrier frequencies

Carrier frequencies (Hz)			
(2030/1/2)			(2032)
A Input	B Input	805,306,368.0	2,700,001,000.0
		952,945,868.8	5,400,000,000.0
10,000.0	168,749,999.9	959,656,755.2	
4,226,750.0	337,499,999.9	1,134,139,801.6	
8,443,500.0	572,662,306.1	1,140,850,688.0	
12,660,250.0		1,145,324,612.2	
16,887,000.0	C Input	1,348,888,166.4	
21,093,749.9			
21,039,750.0	674,999,999.9	(2031/2)	
42,187,499.9	677,799,526.4	1,350,001,000.0	
84,374,999.9	798,595,481.6	2,700,000,000.0	

MODULATION OSCILLATOR

SPECIFICATION	
Frequency range:	0.1 Hz to 500 kHz
Accuracy:	Equal to the frequency standard accuracy
Resolution:	0.1 Hz
Distortion:	Less than 0.1% THD at frequencies up to 20 kHz sine wave mode

TEST EQUIPMENT		
Description	Minimum specification	Example
Frequency counter	10 Hz to 500 kHz	ETP 535B or IFR 2440
Audio analyzer	Capable of measuring down to 0.03% THD from 100 Hz to 20 kHz	Rhode & Schwarz UPA 3

TEST PROCEDURES

Modulation oscillator frequencies

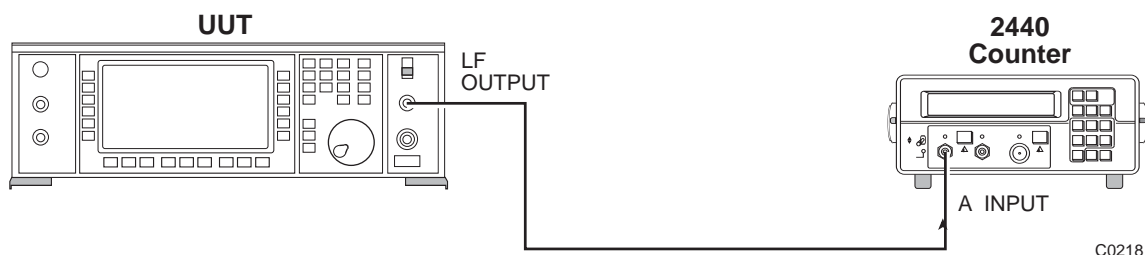

Fig. 5-1-4 Modulation oscillator frequencies test set-up

- (1) Connect the test equipment as shown in Fig. 5-1-4.
- (2) Set the UUT to [Source Freq: F4] 10 Hz.
- (3) Referring to Table 5-1-5, check that the oscillator frequencies can be selected correctly and are within specification.

Table 5-1-5 Modulation oscillator frequencies

Modulation oscillator frequencies (Hz)	
10.00	279,620.20
139,810.10	500,000.00

Modulation oscillator distortion

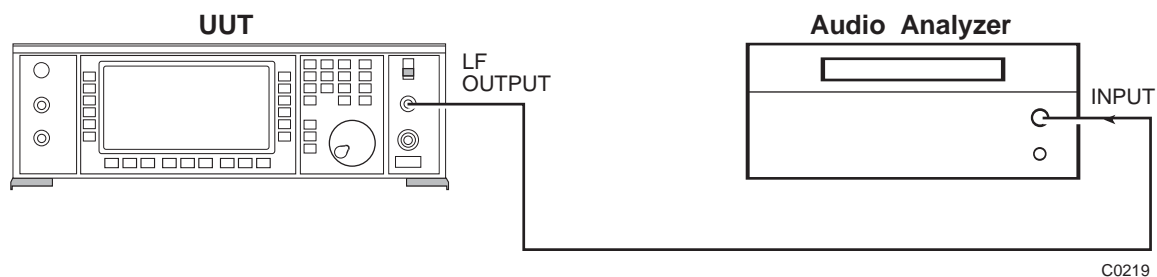

Fig. 5-1-5 Modulation oscillator distortion test set-up

- (1) Connect the test equipment as shown in Fig. 5-1-5.
- (2) Set the UUT to [Source Freq: F4] 100 Hz.
- (3) Check that the distortion measured on the audio analyzer at the frequencies indicated in Table 5-1-6 is less than 0.1%.

Table 5-1-6 Distortion frequency settings

Modulation oscillator frequencies

100 Hz	10 kHz
1 kHz	20 kHz

LF OUTPUT

SPECIFICATION	
Level accuracy:	±5% for levels above 50 mV ±10% for levels from 500 μV to 50 mV (With a load impedance >10 kΩ)
Frequency response:	Typically better than 1 dB from 0.1 Hz to 300 kHz

TEST EQUIPMENT		
Description	Minimum specification	Example
Digital multimeter	DC to 300 kHz, 1 mV to 5 V	Datron 1061A
Audio analyzer	Capable of measuring 0.5 mV ±3% and levels at 10 Hz	HP 8903B Rhode & Schwarz UPA3

TEST PROCEDURES

Level accuracy

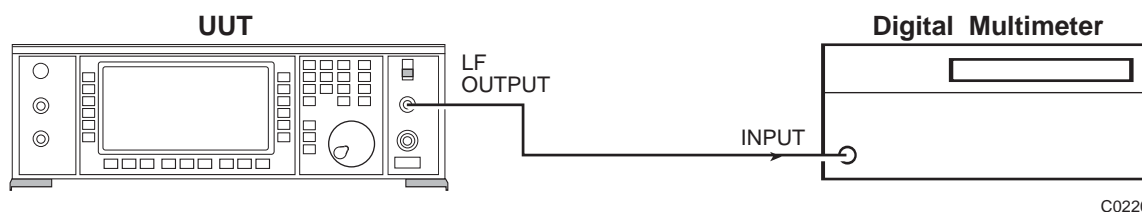

C0220

Fig. 5-1-6 Level accuracy test set-up

- (1) Connect the test equipment as shown in Fig. 5-1-6.
- (2) Set the UUT to give an LF output of 5 V at 1 kHz as follows:
[LF] [LF Gen] [LF Freq] 1 kHz [LF Level] 5 V
- (3) The level measured on the digital multimeter should read 5 V ±0.25 V.
- (4) Check the LF output of the UUT at the levels indicated in Table 5-1-7. Check that the measured levels are within specification.

Table 5-1-7 Level accuracy output levels

LF output levels (V)		
5.0000	0.1000	0.0050
2.0000	0.0500	0.0020
1.0000	0.0200	0.0010
0.5000	0.0100	*0.0005
0.2000		

*For the last measurement it will be necessary to use the audio analyzer. Connect the test equipment as shown in Fig. 5-1-5.

Frequency response

- (1) Connect the test equipment as shown in Fig. 5-1-6.
- (2) Set the UUT to give an LF output of 1 V at 1 kHz on the first modulation oscillator (see 'Level accuracy' (2) above).
- (3) Reference this level on the digital voltmeter using the dB relative function.
- (4) Set the modulation oscillator to the frequencies given in Table 5-1-8 measuring the difference from the reference in (3) above which should be less than 1 dB.

Table 5-1-8 Frequency response test frequencies

Test frequencies		
*10 Hz	1 kHz ref	70 kHz
*30 Hz	10 kHz	100 kHz
*100 Hz	30 kHz	300 kHz

* For these measurements it will be necessary to use the audio analyzer. Connect the test equipment as shown in Fig. 5-1-5, referencing the audio analyzer at 1 kHz.

EXTERNAL MODULATION

SPECIFICATION	
	With ALC off, the modulation is calibrated for an input level of 1.0 V PD RMS
	With ALC on, the modulation is calibrated for input levels between 0.7 V and 1.4 V PD RMS
Distortion:	Additional 0.1% from 50 Hz to 20 kHz at 1 V RMS with ALC on
Flatness:	Typical 1 dB bandwidth, 10 Hz to 500 kHz

TEST EQUIPMENT		
Description	Minimum specification	Example
Function generator	10 Hz to 500 kHz sine wave ± 0.6 dB flatness	HP 3325B
Digital multimeter	10 Hz to 500 kHz	Datron 1061A
Audio analyzer	Capable of measuring THD down to 0.03% from 50 Hz to 20 kHz	HP 8903B Rhode & Schwarz UPA3

TEST PROCEDURES

Mod ALC on flatness

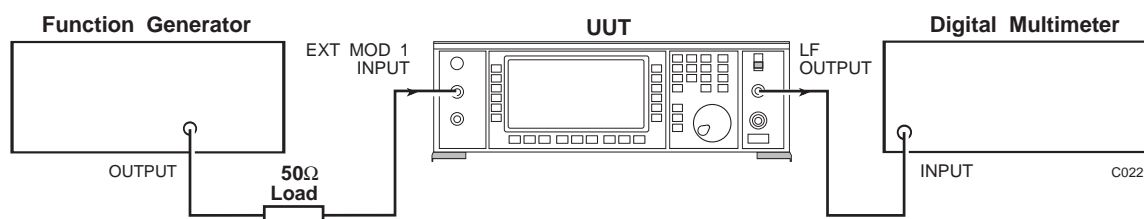

Fig. 5-1-7 External modulation test set-up

Mod input 1

- (1) Connect the test equipment as shown in Fig. 5-1-7.
- (2) Set the function generator to 1 V RMS sine wave output at a frequency of 1 kHz.
- (3) Set the UUT to EXT MOD 1 INPUT with ALC ON as follows:

[LF] [Mod Drive]
[SIG GEN] [FM] 90 kHz [Select Source]
[Select External] [Ext1 ALC Coupling] [SIG GEN]
- (4) Set the digital multimeter to read dB and measure and record this value.
- (5) Set the function generator to the frequencies given in Table 5-1-9 and measure the LF output relative to that reading taken in (4) above. The difference should be less than 1 dB.
- (6) Set the function generator to give 0.7 V output and repeat (4) and (5) above.
- (7) Set the function generator to give 1.4 V output and repeat (4) and (5) above.

Mod input 2

- (8) Connect the test equipment as in Fig. 5-1-7 except with the function generator output connected to EXT MOD 2 INPUT on the UUT.
- (9) Set the UUT to EXT MOD 2 INPUT with ALC ON as follows:
[Select Source] [Ext2 ALC Coupling] [SIG GEN]
- (10) Reset the function generator as in (2) above and repeat (4) to (7) above.

Table 5-1-9 External modulation frequencies

External modulation frequencies			
10 Hz	50 Hz	20 kHz	200 kHz
20 Hz	1 kHz ref	100 kHz	300 kHz

Modulation ALC distortion

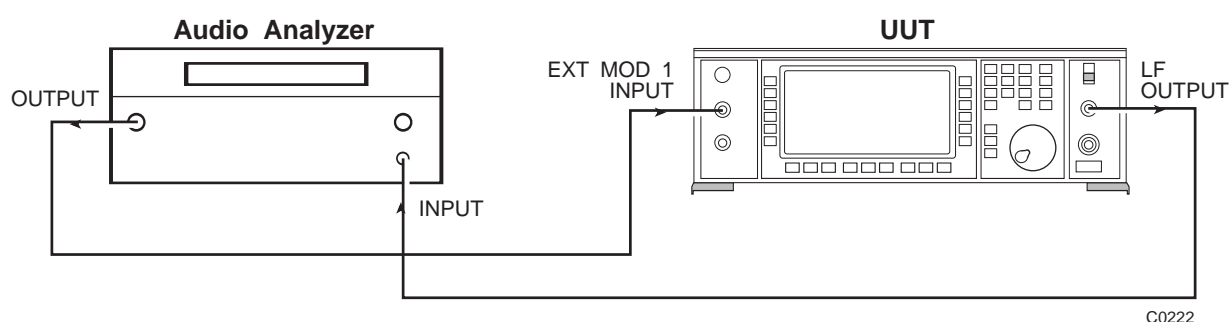

C0222

Fig. 5-1-8 Modulation ALC distortion test set-up

- (1) Connect the test equipment as shown in Fig. 5-1-8.
- (2) Set the UUT as in 'Mod input 1' (3) above.
- (3) Set the audio analyzer to give 1 V RMS output and monitor distortion.
- (4) Set the audio analyzer to 50 Hz, 1 kHz and 20 kHz measuring the distortion at each frequency which must be less than 0.4%.
- (5) Connect the test equipment as in Fig. 5-1-8 except with the output from the audio analyzer connected to EXT MOD 2 INPUT on the UUT and set the UUT as in 'Mod input 2' (9) above.
- (6) Repeat (4) above.

INTERNAL AM DEPTH AND DISTORTION

SPECIFICATION	
Range:	0 to 99% in 0.1% steps.
Accuracy:	For carrier frequencies up to 1 GHz, $\pm 4\%$ of setting $\pm 1\%$ depth. Usable to 1.35 GHz (2030), 2.7 GHz (2031), 5.4 GHz (2032).
Envelope distortion:	Less than 3% THD for AM depths up to 80% at 1 kHz modulation frequency. Less than 1% THD for AM depths up to 30% at 1 kHz modulation frequency.
Phase mod on AM:	Typically less than 0.1 rad at 30% depth on a 500 MHz carrier.

TEST EQUIPMENT		
Description	Minimum specification	Example
Modulation meter	1.5 MHz to 1 GHz. Accuracy: Better than 1.1%.	IFR 2305 + distortion option

TEST PROCEDURES

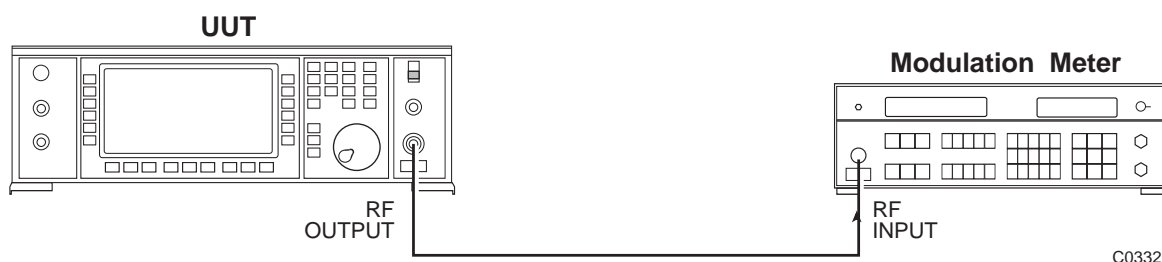

Fig. 5-1-9 Internal AM depth and distortion test set-up

- (1) Connect the test equipment as shown in Fig. 5-1-9.
- (2) Set the UUT to [RF Level] 0 dBm [Carrier Freq.] 1.5 MHz [AM] 30%.
- (3) Measure the AM depth and the envelope distortion on the modulation meter using the 50 Hz to 15 kHz filter setting at the frequencies shown in Table 5-1-10. Check that the measured AM depth and distortion are within specification.
- (4) Set the UUT to an AM depth of 80% and repeat (3) above.
- (5) Set the UUT to [RF Level] +7 dBm (+4 dBm for instruments fitted with Option 012) and repeat (3) and (4) above.

Table 5-1-10 AM depth and distortion frequencies

Carrier frequencies (MHz)	
1.5	400
31.0	500
43.0	850
200.0	1000

AM scale shape

- (1) Connect the test equipment as shown in Fig. 5-1-9.
- (2) Set the UUT to *[RF Level] 0 dBm [Carrier Freq.] 100 MHz [AM] 1%*.
- (3) Measure the AM on the modulation meter at the depths shown in Table 5-1-11. Check that the measured depths are within specification.

Table 5-1-11 AM depths

AM depth (%)									
1	10	31	34	37	39.1	39.4	39.7	40	70
2	20	32	35	38	39.2	39.5	39.8	50	80
5	30	33	36	39	39.3	39.6	39.9	60	85

Phase modulation on AM

- (1) With the test equipment set up as in Fig. 5-1-9, set the UUT to *[Carrier Freq.] 500 MHz [RF Level] 0 dBm [AM] 30%*.
- (2) Measure the incidental phase modulation which should be typically less than 0.1 radian.

EXTERNAL AM

SPECIFICATION

Accuracy:	With ALC OFF the modulation is calibrated for an input level of 1.0 V PD RMS sine wave.
Bandwidth:	± 1 dB, DC to 30 kHz relative to 1 kHz Typically ± 1 dB DC to 50 kHz, relative to 1 kHz.

TEST EQUIPMENT

Description	Minimum specification	Example
Modulation meter	Modulation frequencies from 30 Hz to 50 kHz.	IFR 2305
Function generator	DC to 50 kHz.	HP3325B
Power meter	Capable of measuring levels at 400 MHz.	IFR 6960B and 6912 sensor

TEST PROCEDURES

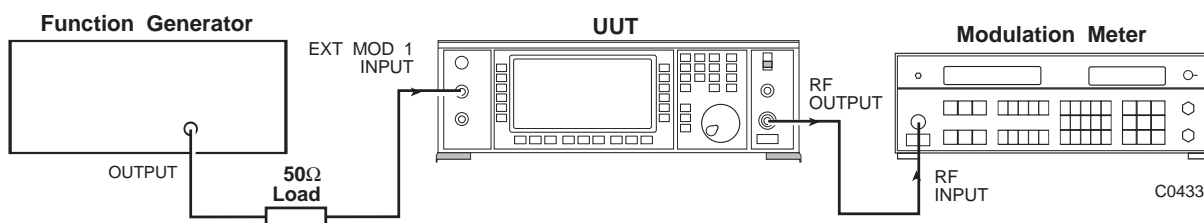

Fig. 5-1-10 External AM test set-up

- (1) Connect the test equipment as shown in Fig. 5-1-10.
- (2) Set the UUT to $[RF\ Level] + 7$ dBm (+4 dBm for instruments fitted with Option 012) $[Carrier\ Freq.]$ 400 MHz $[AM]$ 80%. Then select EXT MOD 1 INPUT, DC coupled as follows:

[Select Source] [Select External] [Ext1 DC Coupling]
[SIG GEN]
- (3) Set the function generator to give 1 V RMS at 1 kHz sine wave.
- (4) With the modulation meter set to measure AM, set a reference using the relative function.
- (5) Set the function generator to the frequencies shown in Table 5-1-12 and measure the change in external AM response which should be less than 1 dB with respect to 1 kHz.

Table 5-1-12 External AM test frequencies

Modulation frequency		
100 Hz	1 kHz	30 kHz
300 Hz	10 kHz	50 kHz

INTERNAL FM DEVIATION

SPECIFICATION	
Range:	1 MHz max for frequencies up to 21.09375 MHz. Up to 1% of carrier frequency for carrier frequencies above 21.09375 MHz.
Resolution:	3 digits.
Accuracy:	±5% of indication ±10 Hz at 1 kHz rate internal modulation source.
Distortion:	Less than 3% at maximum deviation for modulation frequencies up to 20 kHz.

TEST EQUIPMENT		
Description	Minimum specification	Example
Modulation meter	Minimum frequency 20 MHz	IFR 2305 + distortion option

TEST PROCEDURES

- (1) Connect the test equipment as shown in Fig. 5-1-9.
- (2) Set the UUT to [*Carrier Freq.*] 21 MHz [*RF Level*] 0 dBm [*FM Devn.*] 210 kHz. Measure the FM deviation on the modulation meter.
- (3) Set up a carrier frequency step on the UUT of 1 MHz as follows:
[Δ] [*Set Steps*] [*Carrier Step*] 1 MHz [SIG GEN]
- (4) Set up an FM deviation of 500 kHz and increment the carrier frequency up to 42 MHz using the ↑ key, measuring the deviation and distortion on the modulation meter at each step. (Note that the deviation will automatically be limited to 1% of the carrier frequency for each step.) Check that the measured deviations are within specification.

FM attenuator

- (1) With the test equipment connected as in Fig. 5-1-9, set the UUT to [*Carrier Freq.*] 31.64 MHz [*RF Level*] 0 dBm [*FM Devn.*] 1,260 Hz.
- (2) Measure the FM on the modulation meter at the deviations indicated in Table 5-1-13. Check that the measured deviations are within specification.

Table 5-1-13 FM attenuator deviations

Deviation (kHz)		
1.26	79	224
20	159	316

FM scale shape

- (1) With the test equipment connected as in Fig. 5-1-9, set the UUT to [Carrier Freq.] 31.64 MHz [RF Level] 0 dBm [FM Devn.] 224 kHz.
- (2) Referring to Table 5-1-14, measure the FM on the modulation meter at the deviations indicated.

Table 5-1-14 FM scale shape deviations

Deviation (kHz)		
224	256	289
228	261	293
233	265	298
238	270	302
242	275	307
247	279	312
252	284	316

EXTERNAL FM

SPECIFICATION

Accuracy:	With ALC OFF the modulation is calibrated for an input level of 1.0 V PD RMS sine wave.
±1 dB bandwidth:	DC to 300 kHz. Typically 500 kHz.

TEST EQUIPMENT

Description	Minimum specification	Example
Modulation meter	Modulation frequencies from 30 Hz to 50 kHz.	IFR 2305
Function generator	DC to 300 kHz sine wave.	HP3325B
Frequency counter	Up to 40 MHz.	ETP 535B or IFR 2440

TEST PROCEDURES

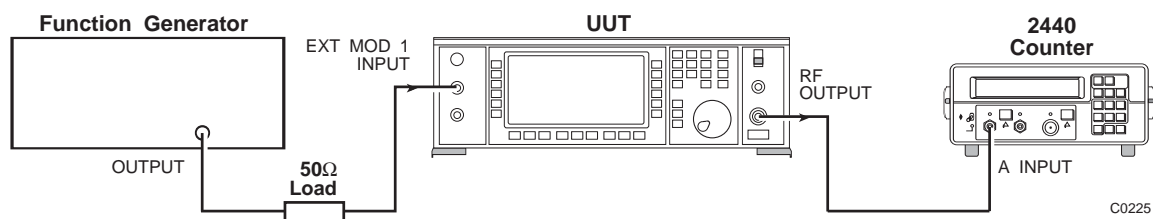

Fig. 5-1-11 External FM test set-up

- (1) Connect the test equipment as shown in Fig. 5-1-10.
- (2) Set the UUT to [Carrier Freq.] 35,468,750.1 Hz [RF Level] 0 dBm [FM Devn.] 40 kHz.

[UTIL] [Mod'n Mode] [Comp]
 [SIG GEN] [Select Source] [Select External]
 [Ext1 AC Coupling]
 [SIG GEN] [FM2] [Select Source] [Ext2 AC Coupling]
 [SIG GEN] 40 kHz [FM1] 40 kHz

The UUT will now produce FM when the external modulating source is applied to either modulation input.

- (3) Set the function generator to give 1 V RMS at 1 kHz sine wave.
- (4) With the modulation meter set to measure FM, set a reference using the relative function.
- (5) Set the function generator to the frequencies shown in Table 5-1-15 and measure the change in external FM response which should be less than 1 dB with respect to 1 kHz.

- (6) To measure the FM deviation at DC, it will be necessary to connect the test equipment as shown in Fig. 5-1-11 and DC couple the EXT MOD 1 INPUT as follows:

[Select Source] [Ext1 DC Coupling] [SIG GEN]

- (7) Using the DC offset facility on the function generator, set up a voltage of +1.4142 V (i.e. $\sqrt{2}$).
- (8) Measure and record the frequency indicated on the counter (F1).
- (9) Set the function generator to give a DC voltage of -1.4142 V.
- (10) Measure and record the frequency indicated on the counter (F2).
- (11) Calculate the FM deviation using the following formula:

$$\frac{F1-F2}{2} = \text{Measured dev} = \text{FM1}$$

- (12) It will now be necessary to reconnect the test equipment as shown in Fig. 5-1-10, reset the function generator to 1 kHz and measure the FM deviation on the modulation meter (FM2).
- (13) Using the following formula, calculate the change in response which should be less than 1 dB:

$$20 \log_{10} \frac{\text{FM2}}{\text{FM1}}$$

- (14) Transfer the function generator output to EXT MOD 2 INPUT on the UUT, select *[FM2]* and repeat (3) to (13) above.

Table 5-1-15 External FM response frequencies

Modulating frequency (Hz)				
0	100	1,000	50,000	200,000
30	300	10,000	100,000	300,000

CARRIER FREQUENCY OFFSET

SPECIFICATION

In DC FM mode; less than $\pm(1 \text{ Hz} + 0.1\% \text{ of the set deviation})$

TEST EQUIPMENT

Description	Minimum specification	Example
Frequency counter	Up to 40 MHz.	ETP 535B or IFR 2440

TEST PROCEDURES

- (1) Connect the test equipment as shown in Fig. 5-1-3.
- (2) Short circuit the EXT MOD 1 INPUT.
- (3) Set the UUT to *[Carrier Freq.] 1.35 GHz [RF Level] 0 dBm [FM Devn.] 13.5 MHz*, then proceed as follows:
[Select Source] [Select External] [Ext1 AC Coupling] [SIG GEN]
- (4) Measure and record the carrier frequency on the counter.
- (5) Set the UUT to DC coupled EXT MOD 1 INPUT as follows:
[Select Source] [Ext1 DC Coupling] [DCFM Nulling] [SIG GEN]
- (6) Measure the change in carrier frequency (offset) which must be less than 13,501 Hz.
- (7) Change the settings of the UUT as follows:
[Select Source] [Ext2 AC Coupling] [SIG GEN]
- (8) Short circuit the EXT MOD 2 INPUT.
- (9) After a 10 second settling period, measure and record the carrier frequency on the counter.
- (10) Set the UUT to DC coupled EXT MOD 2 INPUT as follows:
[Select Source] [Ext2 DC Coupling] [DCFM Nulling] [SIG GEN]
- (11) Measure the change in carrier frequency (offset) which must be less than 13,501 Hz.

INTERNAL PHASE MODULATION

SPECIFICATION	
Range:	Up to 10 radians in 0.01 radian steps
Accuracy:	Better than $\pm 5\%$ at 1 kHz
Distortion:	Less than 3% at 1 kHz modulation rate
Bandwidth:	± 3 dB, 100 Hz to 10 kHz

TEST EQUIPMENT		
Description	Minimum specification	Example
Modulation meter	Minimum frequency 20 MHz	IFR 2305 + distortion option

TEST PROCEDURES

- (1) Connect the test equipment as shown in Fig. 5-1-9.
- (2) Set the UUT to [*Carrier Freq.*] 21,093,750.1 Hz [*RF Level*] 0 dBm [*ΦM*] 10 rad.
- (3) Measure the phase modulation on the modulation meter which should read 10 rad ± 0.5 rad.

Internal phase modulation flatness

- (1) Connect the test equipment as shown in Fig. 5-1-9.
- (2) Set the UUT to [*Carrier Freq.*] 21,093,750.1 Hz [*RF Level*] 0 dBm [*ΦM*] 10 rad [*Select Source: F4*] 1 kHz.
- (3) Set the modulation meter to measure FM with the 50 Hz - 15 kHz LF filter selected.
- (4) Measure the deviation on the modulation meter and calculate the phase modulation using the formula:

$$\Phi M = \frac{\text{FM dev (Hz)}}{\text{mod freq}^* \text{ (Hz)}}$$

- (5) Select the modulation source frequencies as shown in Table 5-1-16 using [*Select Source: F4*] on the UUT, then enter the frequency.
- (6) Measure the deviation on the modulation meter for each modulation frequency and calculate the phase modulation for each step using the formula in (4) above.
- (7) Using the figure recorded in (4) as a reference, calculate the change in response at each modulation frequency using the formula:

$$20 \log_{10} \frac{\text{Figure recorded in (6)}}{\text{Figure recorded in (4)}}$$

* No allowances need be made for the modulation frequency accuracy since it is derived from the crystal reference oscillator in the UUT.

The change in response should be less than 1 dB with respect to 1 kHz.

- (8) Reset the modulation frequency on the UUT to 1 kHz.
- (9) Using the modulation meter set to Φ M, select DIST and measure the distortion which must be less than 3%.

Table 5-1-16 Modulation source frequencies

Modulating frequency (Hz)		
100	1,000	10,000
300	3,000	

SPECTRAL PURITY

SPECIFICATION	
Harmonically related signals for RF levels up to +7 dBm:	Less than -30 dBc for carrier frequencies up to 1 GHz. Less than -27 dBc for carrier frequencies up to 2.7 GHz (2031 and 2032). Less than -27 dBc for carrier frequencies up to 5.4 GHz (2032 only).
Sub-harmonics:	Less than -90 dBc for carrier frequencies up to 1.35 GHz. Less than -40 dBc for carrier frequencies up to 2.3 GHz (2031 and 2032). Less than -30 dBc for carrier frequencies up to 2.7 GHz (2031 and 2032). Less than -30 dBc for carrier frequencies up to 5.4 GHz (2032 only).
Non-harmonics:	Less than -70 dBc for carrier frequencies up to 2.7 GHz at offsets of 3 kHz or greater. Less than -64 dBc for carrier frequencies up to 5.4 GHz (2032 only).
Residual FM:	Less than 7 Hz RMS in a 0.3 to 3.4 kHz unweighted bandwidth at a 470 MHz carrier.

TEST EQUIPMENT

Description	Minimum specification	Example
Modulation meter	Capable of measuring Residual FM less than 7 Hz	IFR 2305
Spectrum analyzer	10 kHz to 16.2 GHz frequency coverage	IFR 2386

TEST PROCEDURES

Residual FM

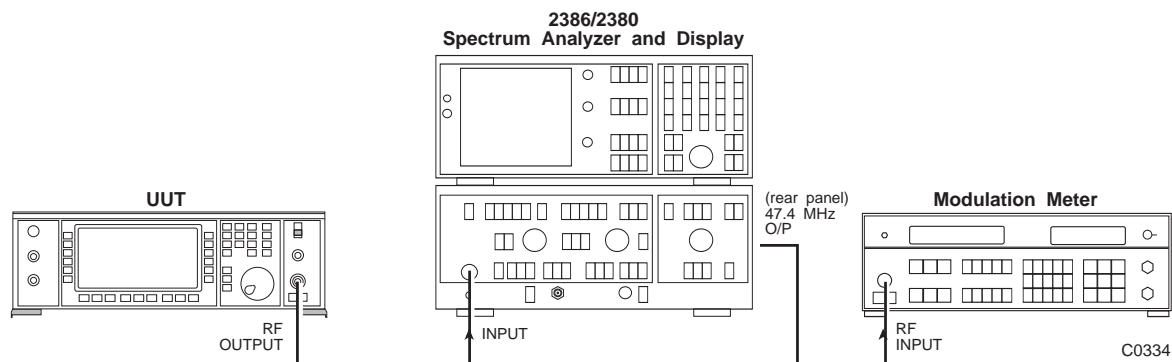

Fig. 5-1-12 Residual FM test set-up

- (1) Connect the test equipment as shown in Fig. 5-1-12.
- (2) Set the UUT to [Carrier Freq.] 470 MHz [RF Level] 0 dBm, modulation OFF.
- (3) Set the spectrum analyzer to 470 MHz zero span.
- (4) Measure the residual FM on the modulation meter in a 300 Hz to 3.4 kHz bandwidth, which must be less than 7 Hz.

Carrier harmonics

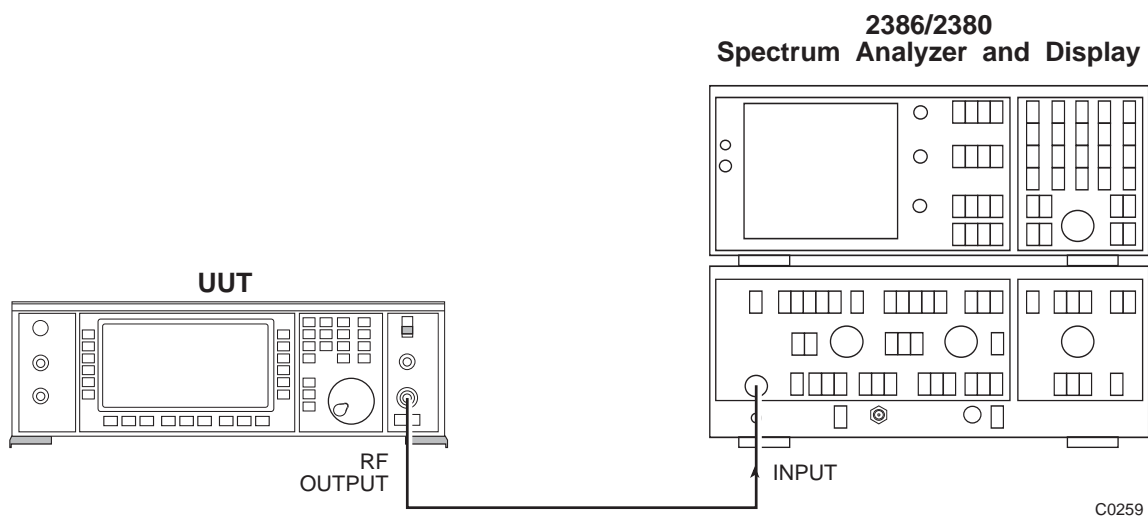

Fig. 5-1-13 Carrier harmonics test set-up

- (1) Connect the test equipment as shown in Fig. 5-1-13.
- (2) Set the UUT to [Carrier Freq.] 10 kHz [RF Level] 7 dBm.
- (3) On the spectrum analyzer measure the 2nd and 3rd harmonics of the carrier frequency which must be less than -30 dBc for carrier frequencies up to 1 GHz and less than -27 dBc for carrier frequencies above 1 GHz.
- (4) Set the UUT to the frequencies indicated in Table 5-1-17 and repeat (3) above.

Table 5-1-17 Carrier harmonic frequencies

Carrier frequencies (Hz)			
(2030/1/2)			
10,000.0	42,187,500.1		
100,000.0	84,375,000.3	(2031/2)	(2032 only)
10,000,000.0	168,750,000.5	1,350,000,001.0	2,700,000,001.0
20,000,000.0	337,500,001.1	1,920,000,000.0	4,050,000,000.0
21,093,750.1	675,000,002.1	2,699,999,999.0	5,400,000,000.0

Carrier sub-harmonics (2031 and 2032 only)

- (1) Connect the test equipment as shown in Fig. 5-1-13.
- (2) Set the UUT to [RF Level] +13 dBm (+10 dBm for instruments fitted with Option 012) [Carrier Freq.] 1,350,100,000.0 Hz.
- (3) Referring to Table 5-1-18, measure the level of the sub-harmonics on the spectrum analyzer at the frequencies indicated. Check that the levels are within specification.

Table 5-1-18 Carrier sub-harmonic frequencies

UUT carrier	Spectrum analyzer frequency (Hz)	
(2031/2)		
1,350,100,000.0	675,050,000.0	2,025,150,000.0
1,500,000,000.0	750,000,000.0	2,250,000,000.0
2,000,000,000.0	1,000,000,000.0	3,000,000,000.0
2,299,999,990.0	1,149,999,995.0	3,449,999,985.0
2,300,000,010.0	1,150,000,005.0	3,450,000,015.0
2,649,000,000.0	1,324,500,000.0	3,973,500,000.0
2,700,000,000.0	1,350,000,000.0	4,050,000,000.0
	$\frac{fc}{4}$ and $\frac{3fc}{4}$	$\frac{fc}{2}$ and $\frac{5fc}{4}$
(2032)		
2,701,000,000.0	675,250,000.0	1,350,500,000.0
	2,025,750,000.0	3,376,250,000.0
3,375,000,000.0	843,750,000.0	1,687,500,000.0
	2,531,250,000.0	4,218,750,000.0
4,050,000,000.0	1,012,500,000.0	2,025,000,000.0
	3,037,500,000.0	5,062,500,000.0
4,725,000,000.0	1,181,250,000.0	2,362,500,000.0
	3,543,750,000.0	5,906,250,000.0
5,400,000,000.0	1,350,000,000.0	2,700,000,000.0
	4,050,000,000.0	6,750,000,000.0

Non-harmonics

- (1) Connect the test equipment as shown in Fig. 5-1-13.
- (2) Set the UUT to *[RF Level]* 0 dBm *[Carrier Freq.]* 10 kHz.
- (3) Set the spectrum analyzer to a span of 100 Hz, 10 Hz filter, and referring to Table 5-1-19, measure the level of the non-harmonics at the frequencies indicated ensuring that the levels measured are less than -70 dBc.

Table 5-1-19 Carrier non-harmonic frequencies

UUT carrier frequency (Hz)	Spectrum analyzer frequency (Hz)
(2030/1/2)	
10,000.0	104,867,600.0
1,000,000.0	105,857,600.0
20,000,000.0	124,857,600.0
21,093,749.0	125,951,349.0
200,000,000.0	104,867,600.0
1,350,000,000.0	1,348,322,280.0 & 1,351,677,720.0
(2031/2)	
2,700,000,000.0	2,500,000,000.0
(2032)	
5,400,000,000.0	5,200,000,000.0

CALIBRATION DUE DATE

The date of the next calibration check can be entered from the calibration utilities menu by pressing the *[Set Next Cal Date]* key. On reaching the calibration date, the instrument will display an error message indicating that it should be returned for a calibration check. The recommended calibration interval is 2 years.

REAL TIME CLOCK BATTERY

The real time clock uses a lithium battery to provide uninterrupted power regardless of whether the instrument is switched on or off. Although the estimated life of this battery is 5 years, customers may wish to replace it every 2 years.

Chapter 5-1
Appendix A

ACCEPTANCE TESTING
SECOND MODULATION OSCILLATOR OPTION

CONTENTS

	PAGE
MODULATION OSCILLATORS	5-1-A-2
Modulation oscillator frequencies	5-1-A-2
Modulation oscillator distortion.....	5-1-A-3
LF OUTPUT	5-1-A-4
Level accuracy	5-1-A-4
Frequency response.....	5-1-A-5
AM SCALE SHAPE.....	5-1-A-6
FM SCALE SHAPE	5-1-A-7

LIST OF TABLES

Table 5-1-A-1 Modulation oscillator frequencies	5-1-A-3
Table 5-1-A-2 Distortion frequencies.....	5-1-A-3
Table 5-1-A-3 LF output levels	5-1-A-4
Table 5-1-A-4 Test frequencies	5-1-A-5
Table 5-1-A-5 AM depths.....	5-1-A-6
Table 5-1-A-6 Deviation frequencies	5-1-A-7

LIST OF FIGURES

Fig. 5-1-A-1 Modulation oscillator frequencies test set-up.....	5-1-A-2
Fig. 5-1-A-2 Modulation oscillator distortion test set-up.....	5-1-A-3
Fig. 5-1-A-3 Level accuracy test set-up.....	5-1-A-4
Fig. 5-1-A-4 LF output levels test set-up for 0.0005 V	5-1-A-5
Fig. 5-1-A-5 AM scale shape test set-up	5-1-A-6

MODULATION OSCILLATORS

The following tests are for a 2030, 2031 or 2032 with the 2nd modulation oscillator fitted.

SPECIFICATION	
Frequency range:	0.1 Hz to 500 kHz
Accuracy:	Equal to the frequency standard accuracy
Resolution:	0.1 Hz
Distortion:	Less than 0.1% THD at frequencies up to 20 kHz sine wave mode

TEST EQUIPMENT		
Description	Minimum specification	Example
Frequency counter	10 Hz to 500 kHz	ETP 535B or IFR 2440
Audio analyzer	Capable of measuring down to 0.03% THD from 100 Hz to 20 kHz	HP 8903B Rhode & Schwarz UPA 3

TEST PROCEDURES

Modulation oscillator frequencies

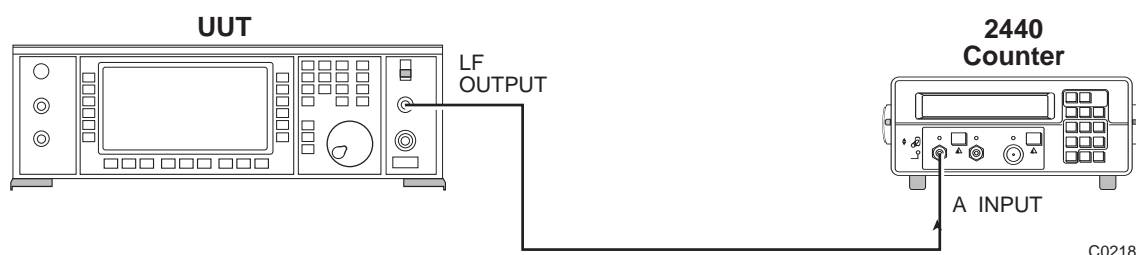

Fig. 5-1-A-1 Modulation oscillator frequencies test set-up

- (1) Connect the test equipment as shown in Fig. 5-1-A-1.
- (2) To enable both the modulation oscillators on the UUT, it will be necessary to carry out the following procedure:

Press the following sequence of keys:

[UTIL] [Mod'n Mode] [Comp] [SIG GEN] [Source Freq:]

The frequencies of the first modulation oscillator may now be entered.

- (3) Referring to Table 5-1-A-1, check that the oscillator frequencies can be selected correctly and are within specification.
- (4) To monitor the second modulation oscillator, enter the following:
*[FM2] [Select Source] [Select Internal] [Internal F1]
 [LF] [Mod2 Source] [SIG GEN] [Source Freq:]*
 The frequencies of the second modulation may now be entered.
- (5) Repeat (3) above.

Table 5-1-A-1 Modulation oscillator frequencies

Modulation oscillator frequencies (Hz)	
10.00	279,620.20
139,810.10	500,000.00

Modulation oscillator distortion

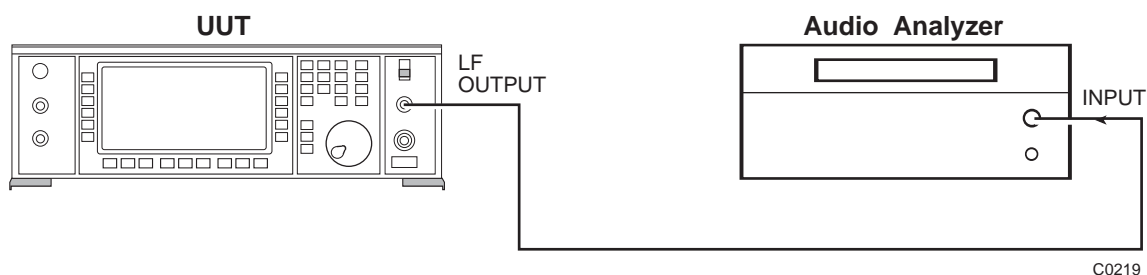

Fig. 5-1-A-2 Modulation oscillator distortion test set-up

- (1) Connect the test equipment as shown in Fig. 5-1-A-2.
- (2) Set the UUT such that the first modulation oscillator may be tested (refer to 'Modulation oscillator frequencies' step (2) above).
- (3) Check that the distortion measured on the audio analyzer at the frequencies indicated in Table 5-1-A-2 is less than 0.1%.
- (4) Set the UUT such that the second modulation oscillator may be tested (refer to 'Modulation oscillator frequencies' step (4) above).
- (5) Repeat (3) above.

Table 5-1-A-2 Distortion frequencies

Modulation oscillator frequencies	
100 Hz	10 kHz
1 kHz	20 kHz

LF OUTPUT

SPECIFICATION	
Level accuracy:	$\pm 5\%$ for levels above 50 mV, $\pm 10\%$ for levels from 500 μV to 50 mV (with a load impedance $>10\text{ k}\Omega$)
Frequency response:	Typically better than 1 dB from 0.1 Hz to 300 kHz

TEST EQUIPMENT		
Description	Minimum specification	Example
Digital multimeter	DC to 300 kHz, 1 mV to 5 V	Datron 1061A
Audio analyzer	Capable of measuring 0.5 mV $\pm 3\%$ and levels at 10 Hz	HP8903B Rhode & Schwarz UPA3

TEST PROCEDURES

Level accuracy

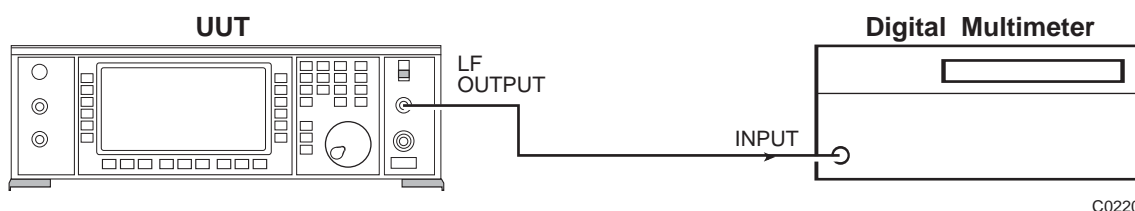

C0220

Fig. 5-1-A-3 Level accuracy test set-up

- (1) Connect the test equipment as shown in Fig. 5-1-A-3.
- (2) Set the UUT to give an LF output of 5 V at 1 kHz by entering the following:
 $[LF] [LF\ Gen] [LF\ Freq] 1\text{ kHz} [LF\ Level] 5\text{ V}$
- (3) The level measured on the digital multimeter should read 5 V $\pm 0.25\text{ V}$.
- (4) Check the LF output of the UUT at the levels indicated in Table 5-1-A-3. Check that the measured levels are within specification.

Table 5-1-A-3 LF output levels

LF output levels (V)		
5.0000	0.1000	0.0050
2.0000	0.0500	0.0020
1.0000	0.0200	0.0010
0.5000	0.0100	*0.0005
0.2000		

*For the last measurement it will be necessary to use the audio analyzer. Connect the test equipment as shown in Fig. 5-1-A-4.

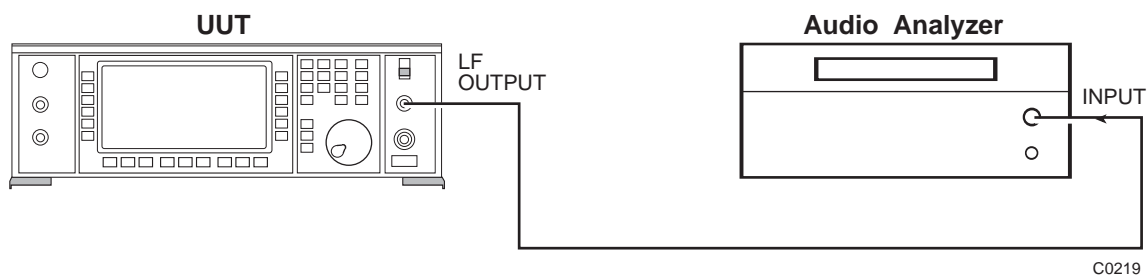

Fig. 5-1-A-4 LF output levels test set-up for 0.0005 V

Frequency response

- (1) Connect the test equipment as shown in Fig. 5-1-A-2.
- (2) Set the UUT to give an LF output of 1 V at 1 kHz on the first modulation oscillator (refer to 'Level accuracy' above).
- (3) Reference this level on the audio analyzer using the dB relative function.
- (4) Set the modulation oscillator to the frequencies given in Table 5-1-A-4 measuring the difference from the reference in (3) above which should be less than 1 dB.
- (5) Set the UUT to give an LF output of 1 V at 1 kHz on the second modulation oscillator (refer to 'Level accuracy' above).
- (6) Repeat (3) and (4) above.

Table 5-1-A-4 Test frequencies

Test frequencies		
10 Hz	1 kHz ref	70 kHz
30 Hz	10 kHz	100 kHz
100 Hz	30 kHz	300 kHz

AM SCALE SHAPE

SPECIFICATION	
Range:	0 to 99% in 0.1% steps
Accuracy:	For carrier frequencies up to 1 GHz, $\pm 4\%$ of setting, $\pm 1\%$ depth. Usable to 2.7 GHz (2031) . Usable to 5.4 GHz (2032) .

TEST EQUIPMENT		
Description	Minimum specification	Example
Modulation meter	1.5 MHz to 1 GHz Accuracy: better than 1.1%	IFR 2305 + distortion option

TEST PROCEDURES

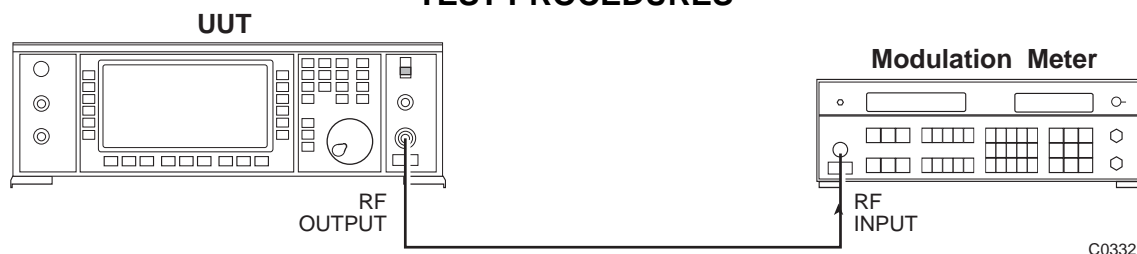

Fig. 5-1-A-5 AM scale shape test set-up

- (1) Connect the test equipment as shown in Fig. 5-1-A-5.
- (2) Set the UUT to *[RF level]* 0 dBm, *[Carrier freq.]* 100 MHz, then enter the following:

**[UTIL] [Mod'n mode] [Comp]
[SIG GEN] [AM] 1%**

- (3) Measure the AM on the modulation meter at the depths shown in Table 5-1-A-5. Check that the measured AM depth is within specification.
- (4) Set the UUT by entering the following:

**[AM1 ON/OFF] [AM2] [Select Source] [Select internal]
[Internal F4] [SIG GEN] 1%**

- (5) Repeat (3) above.

Table 5-1-A-5 AM depths

AM depth (%)									
1	10	31	34	37	39.1	39.4	39.7	40	70
2	20	32	35	38	39.2	39.5	39.8	50	80
5	30	33	36	39	39.3	39.6	39.9	60	85

FM SCALE SHAPE

SPECIFICATION	
Range:	1 MHz max for frequencies up to 21.09375 MHz. Up to 1% of carrier frequency for carrier frequencies above 21.09375 MHz
Resolution:	3 digits
Accuracy:	±5% of indication ±10 Hz at 1 kHz rate internal modulation source

TEST EQUIPMENT		
Description	Minimum specification	Example
Modulation meter	Minimum frequency 20 MHz	IFR 2305 + distortion option

TEST PROCEDURES

- (1) With the test equipment connected as in Fig. 5-1-A-5, set the UUT to [*Carrier freq.*] 31.64 MHz, [*RF level*] 0 dBm then enter the following:

[UTIL] [*Mod'n Mode*] [*Comp*]
 [SIG GEN] [*FM2*] [*Select Source*] [*Select Internal*]
 [*Internal F4*]
 [SIG GEN] [*FM1*]
- (2) The deviation for FM1 can now be entered. Referring to Table 5-1-A-6, measure the FM on the modulation meter at the deviations indicated. Check that the measured deviation is within specification.
- (3) Set FM1 to 0 Hz deviation and select [*FM2*].
- (4) The deviation for FM2 can now be entered. Repeat (2) above.

Table 5-1-A-6 Deviation frequencies

Deviation (kHz)		
224	256	289
228	261	293
233	265	298
238	270	302
242	275	307
247	279	312
252	284	316

**Chapter 5-1
Appendix B**

**ACCEPTANCE TESTING
PULSE MODULATION OPTION**

CONTENTS

	PAGE
PULSE MODULATION	5-1-B-2
Minimum 'ON' level.....	5-1-B-2
Maximum 'OFF' level	5-1-B-2
Additional level error.....	5-1-B-3
ON/OFF ratio	5-1-B-3

LIST OF TABLES

Table 5-1-B-1 On/off ratio carrier frequencies.....	5-1-B-3
---	---------

LIST OF FIGURES

Fig. 5-1-B-1 Levels test set-up	5-1-B-2
Fig. 5-1-B-2 ON/OFF ratio test set-up.....	5-1-B-3

PULSE MODULATION

The following tests are for a 2030, 2031 or 2032 with the pulse modulation option fitted.

SPECIFICATION	
Maximum input level:	+5 V.
Minimum ON Level:	+3.5 V.
Maximum OFF level:	+1.0 V.
OFF/ON ratio :	Greater than 70 dB at the carrier frequency. Typically greater than 80 dB.
Additional output level error :	Less than 0.5 dB.

TEST EQUIPMENT		
Description	Minimum specification	Example
Power meter	± 0.1 dB from 30 kHz to 2.7 GHz.	IFR 6960B and 6912 sensor
Spectrum analyzer	Frequencies up to 1.4 GHz. Capable of measuring < -70 dBm.	IFR 2386
Function generator	DC capability.	HP3325B

TEST PROCEDURES

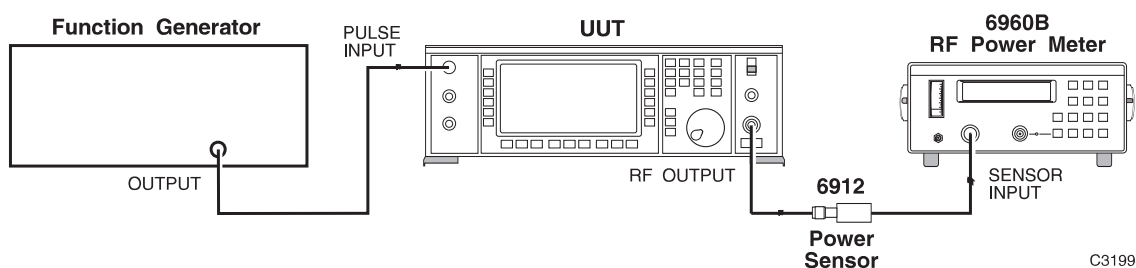

Fig. 5-1-B-1 Levels test set-up

Minimum 'ON' level

- (1) Connect the test equipment as shown in Fig. 5-1-B-1.
- (2) Set the UUT to [RF level] 0 dBm [Carrier freq.] 10 MHz and [Pulse Mod.].
- (3) Set the function generator to give +3.5 V DC. The 0 dBm level should now appear on the power meter.

Maximum 'OFF' level

- (4) Set the function generator to give 1.0 V DC. The 0 dBm level should now disappear from the power meter.

Additional level error

- (1) Set the UUT to [*Carrier Freq.*] 1 MHz, [*RF level*] 0 dBm.
- (2) Measure and record the RF level indicated on the power meter (P1).
- (3) Set the UUT to [*Pulse Mod.*]
- (4) Set the function generator to give +5 V DC.
- (5) Measure and record the RF level indicated on the power meter (P2).
- (6) The difference between P1 and P2 must be less than 0.5 dBm.

ON/OFF ratio

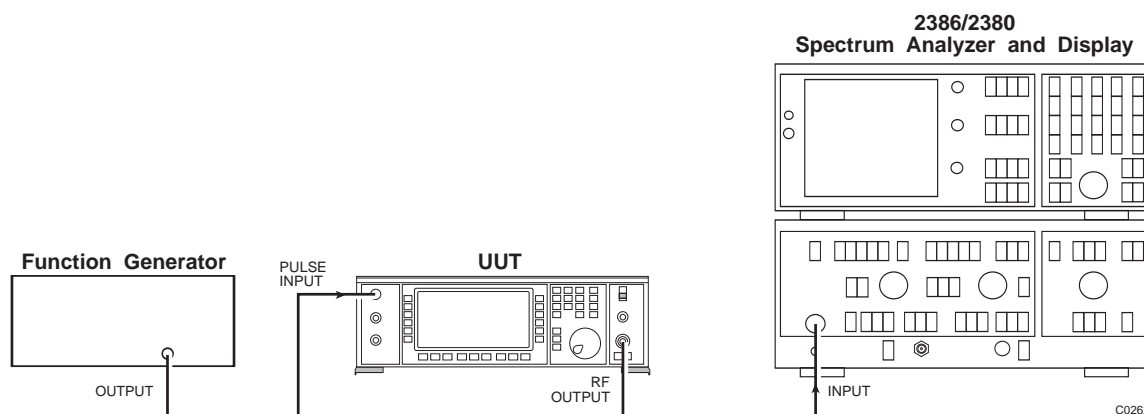

Fig. 5-1-B-2 ON/OFF ratio test set-up

- (1) Connect the test equipment as shown in Fig. 5-1-B-2.
- (2) Set the UUT to [*Carrier Freq.*] 11 MHz, (RF level) 0 dBm, and [*Pulse Mod.*].
- (3) Set the function generator to give +5 VDC.
- (4) Set the spectrum analyzer to 11 MHz, span/div 10 kHz, and, using the 'Peak Find' facility, measure the amplitude of the carrier signal and record as (P1).
- (5) Set the function generator to give 0 V DC.
- (6) Measure the amplitude of the carrier signal and record as (P2). The difference between P1 and P2 must be greater than 70 dB.
- (7) Repeat (3) to (6) above for the UUT and spectrum analyzer frequencies shown in Table 5-1-B-1.

Table 5-1-B-1 On/off ratio carrier frequencies

Carrier frequencies		
11 MHz	675 MHz	1.349,999 GHz
111 MHz	1 GHz	

Chapter 5-1
Appendix C

ACCEPTANCE TESTING
HIGH OUTPUT POWER OPTION

CONTENTS

	PAGE
RF OUTPUT LEVEL	5-1-C-2
ALC LINEARITY	5-1-C-3
CARRIER HARMONICS	5-1-C-3

LIST OF TABLES

Table 5-1-C-1 RF output test frequencies.....	5-1-C-2
Table 5-1-C-2 Carrier harmonic frequencies.....	5-1-C-4

LIST OF FIGURES

Fig. 5-1-C-1 RF output and ALC linearity test set-up.....	5-1-C-2
Fig. 5-1-C-2 Carrier harmonics test set-up	5-1-C-3

The following tests are for a 2030 fitted with the +19 dBm option (high output power).

RF OUTPUT LEVEL

SPECIFICATION	
Level range:	-138 dBm to +19 dBm.
Accuracy :	± 1.2 dB from 10 kHz to 1.35 GHz.

TEST EQUIPMENT		
Description	Minimum specification	Example
RF power meter	± 0.1 dB from 30 kHz to 2.7 GHz.	IFR 6960B and 6912 sensor

TEST PROCEDURES

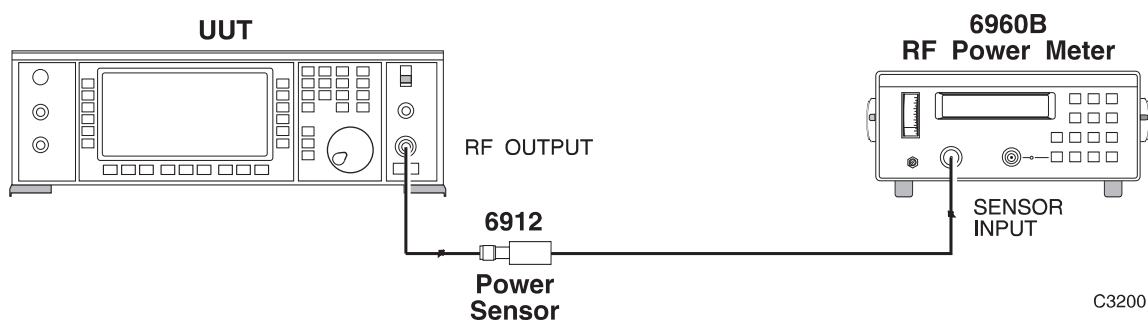

Fig. 5-1-C-1 RF output and ALC linearity test set-up

- (1) Connect the test equipment as shown in Fig. 5-1-C-1.
- (2) Set the UUT to [RF level] 6.1 dBm, [Carrier freq.] 30 kHz.
- (3) Check that the output level is within ± 1.2 dBm at the frequencies shown in Table 5-1-C-1.
- (4) Set the UUT RF output to 13 dBm and repeat (3) above.
- (5) Set the UUT RF output to 19 dBm and repeat (3) above.

TABLE 5-1-C-1 RF OUTPUT TEST FREQUENCIES

Frequency (MHz)	
0.03	675
0.1	825
75	975
225	1125
375	1275
525	1350

ALC LINEARITY

- (1) Connect the test equipment as shown in Fig. 5-1-C-1.
- (2) Set the UUT to [Carrier freq.] 2.5 MHz, [RF level] 6 dBm.
- (3) Increment the RF output of the UUT in 1 dB steps up to 18 dBm and in 0.1 dBm steps up to 19 dBm, measuring the RF level at each step.
- (4) Set the UUT carrier frequency to 500 MHz and repeat (3) above.
- (5) Set the UUT carrier frequency to 1.35 GHz and repeat (3) above.

CARRIER HARMONICS

SPECIFICATION	
Harmonically related signals:	Less than -27 dBc for carrier frequencies up to 1.35 GHz.

TEST EQUIPMENT		
Description	Minimum specification	Example
Spectrum analyzer	10 kHz to 4.1 GHz frequency coverage.	IFR 2386

TEST PROCEDURES

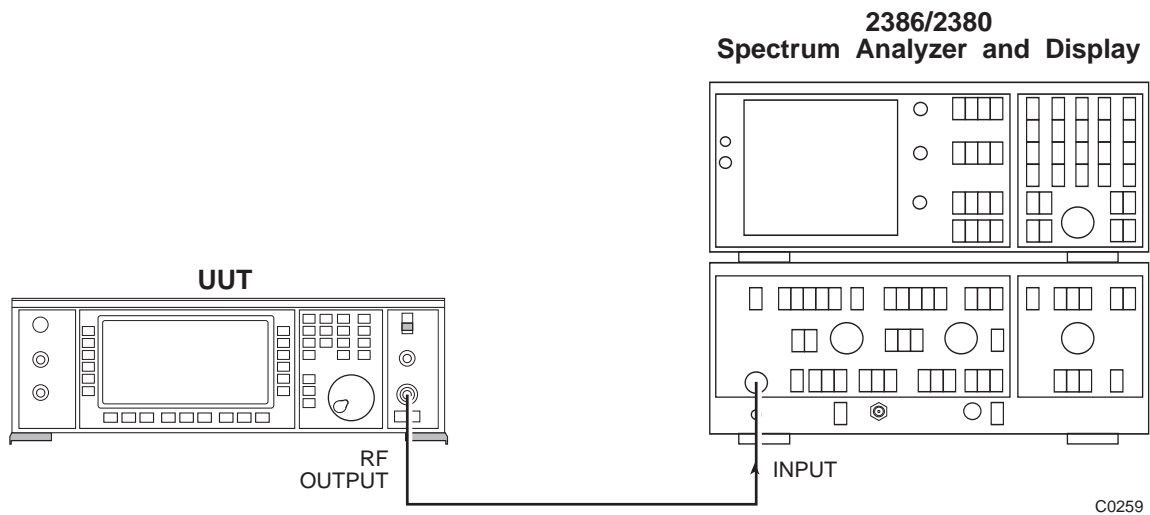

Fig. 5-1-C-2 Carrier harmonics test set-up

- (1) Connect the test equipment as shown in Fig. 5-1-C-2.
- (2) Set the UUT to [Carrier freq.] 10 kHz, [RF level] 0 dBm.
- (3) On the spectrum analyzer measure the 2nd and 3rd harmonics of the carrier frequency which must be less than -27 dBc.
- (4) Set the UUT to the frequencies indicated in Table 5-1-C-2 and repeat (3) above.

TABLE 5-1-C-2 CARRIER HARMONIC FREQUENCIES

Carrier frequencies (Hz)	
10,000.0	42,187,500.1
100,000.0	84,375,000.3
10,000,000.0	168,750,000.5
20,000,000.0	337,500,001.1
21,093,750.1	675,000,002.1

**Chapter 5-1
Appendix D**

**ACCEPTANCE TESTING
ELECTRONIC ATTENUATOR OPTION**

CONTENTS

	PAGE
TEST PROCEDURES	5-1-D-2
RF OUTPUT	5-1-D-2
ALC linearity	5-1-D-3
Attenuator accuracy	5-1-D-3
Alternative attenuator functional check.....	5-1-D-4

LIST OF TABLES

Table 5-1-D-1 Frequency settings for output levels	5-1-D-3
Table 5-1-D-2 Attenuator frequency settings	5-1-D-4

LIST OF FIGURES

Fig. 5-1-D-1 RF output flatness test set-up.....	5-1-D-2
Fig. 5-1-D-2 Attenuator accuracy test set-up.....	5-1-D-3

TEST PROCEDURES

Before each test, it is recommended that the UUT is reset to its switch-on conditions which are as follows:

Carrier freq	1.35 GHz (2030), 2.7 GHz (2031)
RF level	-138 dBm
FM	0 Hz ON
Single modulation mode	
Modulation	ENABLED

RF OUTPUT

SPECIFICATION	
Level range:	-127 dBm to +10 dBm (usable to -138 dBm)
Accuracy:	(2030 and 2031) ±1.2 dB from 10 kHz to 1.35 GHz at levels >-127 dBm
	(2031) ±1.2 dB from 1.35 GHz to 2.7 GHz at levels >-127 dBm

TEST EQUIPMENT		
Description	Minimum specification	Example
RF power meter	±0.1 dB from 30 kHz to 2.7 GHz	IFR 6960B and 6910 or 6912 sensor
Measuring receiver	0 dBm to -127 dBm; 2.5 MHz to 1300 MHz	HP 8902A and 11722A sensor and 11793A down converter
Signal generator	8 dBm from 32.5 MHz to 5.4 GHz	IFR 2032

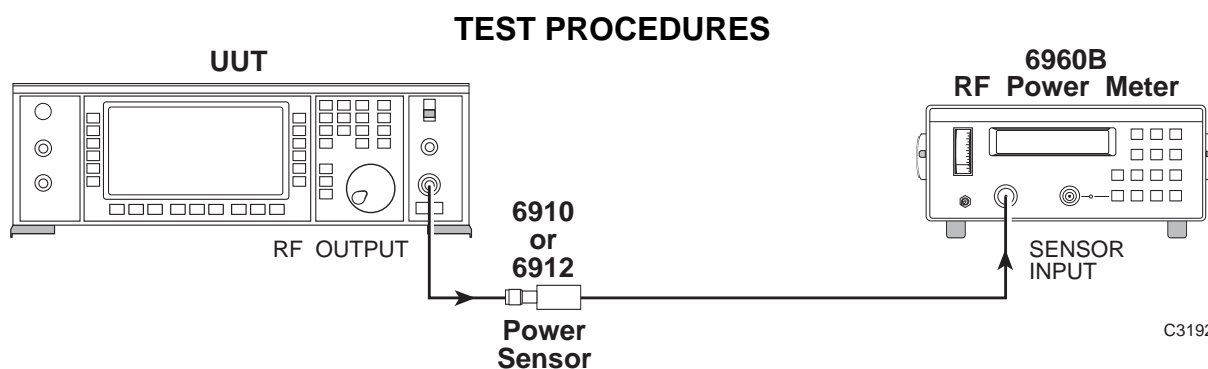

Fig. 5-1-D-1 RF output flatness test set-up

- (1) Connect the test equipment as shown in Fig. 5-1-D-1.
- (2) Set the UUT to [RF level] 0 dBm, [Carrier freq.] 250 kHz.
- (3) Check that the output level is within specification at the frequencies shown in Table 5-1-D-1.
- (4) Set the UUT RF output to 10 dBm and repeat (3) above.

Table 5-1-D-1 Frequency settings for output levels

FREQUENCY (MHz)		
(2030/1)	1275	2175
0.25	1350	2325
75		2475
225	(2031)	2625
375	1351	2700
525	1425	
675	1575	
825	1725	
975	1875	
1125	2025	

ALC linearity

- (1) Connect the test equipment as shown in Fig. 5-1-D-1.
- (2) Set the UUT to [RF level] -3 dBm, [Carrier freq.] 2.5 MHz.
- (3) Increment the RF output of the UUT in 1 dB steps up to 9 dBm and in 0.1 dBm steps up to 10 dBm, measuring the RF level at each step. Check that the RF output level variation is within ± 0.1 dB.
- (4) Set the UUT carrier frequency to 500 MHz and repeat (3) above.
- (5) Set the UUT carrier frequency to 2.7 GHz and repeat (3) above.

Attenuator accuracy

The following test will confirm that the attenuator performs to the published performance specification. In the event of the receiver/down converter not being available, an alternative method to functionally test the attenuator is also suggested (see 'Alternative attenuator functional check' below).

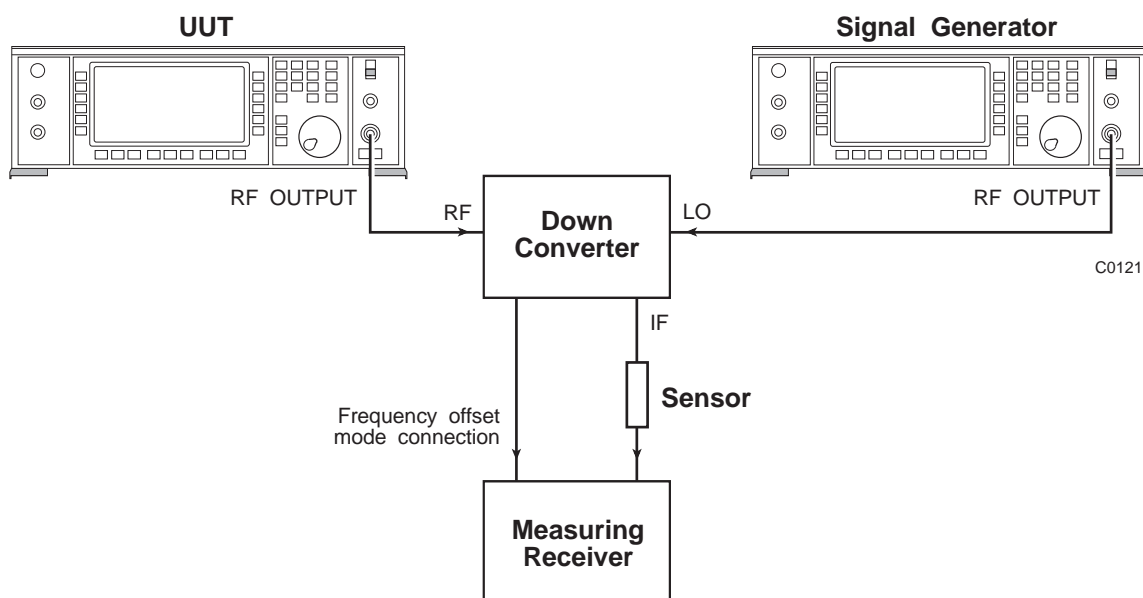

Fig. 5-1-D-2 Attenuator accuracy test set-up

- (1) Connect the test equipment as shown in Fig. 5-1-D-2.

- (2) Set the UUT to *[RF level]* 0 dBm, *[Carrier freq.]* 2.5 MHz.
- (3) Tune the receiver to 2.5 MHz and measure the RF level.
- (4) Set the UUT to *[RF level]* -6.1 dBm and measure the RF level.
- (5) Decrement the output of the UUT in 6 dB steps down to an RF level of -120.1 dBm measuring the RF level at each step. Check that the measured level is within specification.
- (6) Repeat (2) to (5) at the frequencies given in Table 5-1-D-2.
- (7) Set the local oscillator to +8 dBm at the frequencies indicated in brackets in Table 5-1-D-2.

Table 5-1-D-2 Attenuator frequency settings

Frequency (MHz)	
2030/1	2031
2.5	1725 (1662) *
31	2700 (2637) *
325	
1125	
1275	

* At frequencies above 1300 MHz the down converter will automatically be enabled.

The frequency of the local oscillator will have to be entered on the receiver followed by the test frequency. This will automatically set the receiver to the required IF frequency.

Alternative attenuator functional check

- (1) Connect the test equipment as shown in Fig. 5-1-D-1.
- (2) Set the UUT to *[Carrier freq.]* 1.35 GHz, *[RF level]* 10 dBm.
- (3) Set a reference on the power meter.
- (4) Using the latch poke facility on the UUT, select each attenuator pad individually as follows:

[UTIL] *[Utils. Menu 2]* *[Latch Data]* 95 [enter]
[Decimal/Binary]

The binary latch data will now appear in the bottom right-hand side of the display.

- (5) By using the *[Toggle Bit]* and the *[Cursor Left]* *[Cursor Right]* soft keys, select each attenuator pad in turn which should give the nominal readings on the power meter in the following sequence:

-6 dB -30 dB -12 dB -30 dB -24 dB -30 dB

Note that no software correction is applied to the attenuator when performing this test. Therefore errors in the nominal values are not necessarily reflected in the RF level accuracy.

Annex A
OPTION 005 GMSK Bt 0.3

CONTENTS

GENERAL DESCRIPTION	A-3
PERFORMANCE DATA	A-3
GMSK MODULATION	A-4
Modulation type	A-4
Modulation accuracy	A-4
Data coding	A-4
INTERNAL MODULATION	A-4
Data storage	A-4
Internal modulation outputs	A-4
EXTERNAL MODULATION	A-5
ENVELOPE CONTROL	A-5
MODULATION SENSE	A-5
SYNCHRONIZATION	A-5
GMSK OPERATION	A-6
INTRODUCTION	A-6
FRONT PANEL	A-6
REAR PANEL	A-8
GSM MODE	A-9
GMSK CONTROL	A-10
Configuration select	A-11
Trigger control	A-11
Configuration control	A-11
Doppler	A-11
Sideband	A-12
Modulation polarity	A-12
GMSK fidelity	A-12
Differential encoding	A-12
Envelope select	A-12
Exit	A-12
STORE/RECALL GMSK	A-13
EXTERNAL DATA/CLOCK OPERATION	A-13
Setting the output carrier	A-13
INTERNAL DATA GENERATION MODE	A-14
Internal data selection	A-14
Modulation ON/OFF	A-18
External clock/internal data	A-18
DATA EDITOR	A-18
Frame editor	A-19
Multiframe/superframe editor	A-20
FREQUENCY STANDARD	A-20
POWER UP OPTIONS	A-21
ERROR HANDLING	A-22
GPIB OPERATION	A-23
ADDITIONAL COMMANDS	A-23
MODULATION MODE	A-28
MEMORY – STORE	A-29
MEMORY – RECALL	A-29
MEMORY – ERASE	A-29
MISCELLANEOUS COMMANDS	A-30
INSTRUMENT EVENT REGISTERS	A-31
COUPLING EVENT REGISTERS	A-32

ACCEPTANCE TESTING	A-33
INTRODUCTION	A-33
RF LEVEL ACCURACY	A-33
GMSK MODULATION ACCURACY	A-36
GMSK Bt 0.3 MODULATION FIDELITY – method 1	A-37
GMSK Bt 0.3 MODULATION FIDELITY – method 2	A-38
OFF-SLOT SUPPRESSION	A-42
FREQUENCY STANDARD	A-43
Output frequency check	A-44
Frequency standard locking test	A-44

LIST OF TABLES

Table A-1 Frequency locking	A-20
Table A-2 Foreground errors	A-22
Table A-3 Background errors	A-22
Table A-4 Recommended test equipment	A-33
Table A-5 RF level test frequencies	A-35
Table A-6 GMSK modulation accuracy test	A-37
Table A-7 Suppressed levels for waveform 2	A-40

LIST OF FIGURES

Fig. A-1 2031 series front panel with Option 005	A-6
Fig. A-2 2031 rear panel with Option 005	A-8
Fig. A-3 Utilities selection menu 1	A-9
Fig. A-4 Modulation mode selection with GMSK	A-9
Fig. A-5 GMSK control menu with external data selected	A-10
Fig. A-6 Sig. Gen. menu with internal data selected	A-10
Fig. A-7 GMSK configuration selection menu	A-11
Fig. A-8 Sig. Gen. menu in GSM mode with external data/clock	A-14
Fig. A-9 GMSK control menu	A-15
Fig. A-10 GMSK internal data selection menu with slot selected	A-15
Fig. A-11 GMSK internal data select menu with frame selected	A-16
Fig. A-12 GMSK internal data select menu with multiframe selected	A-16
Fig. A-13 GMSK internal data selection menu with superframe selected	A-17
Fig. A-14 Sig. Gen. menu with internal data selected	A-17
Fig. A-15 Data editor with slot editing selected	A-18
Fig. A-16 Editing slot data	A-19
Fig. A-17 GMSK frame editor menu	A-20
Fig. A-18 Power up options menu with memory power up selected	A-21
Fig. A-19 RF level test set-up	A-34
Fig. A-20 GMSK modulation accuracy test set-up	A-37
Fig. A-21 Spectrum of built-in test waveform 1	A-39
Fig. A-22 Spectrum of built-in test waveform 2	A-40
Fig. A-23 Off-slot suppression test set-up	A-42
Fig. A-24 Frequency standard output test set-up	A-44
Fig. A-25 Frequency standard locking test set-up	A-44

GENERAL DESCRIPTION

This option adds GMSK (Gaussian Minimum Shift Keying) modulation at a bit rate of 270.833 kHz to the 2030 series. This modulation is used by the GSM (Global System for Mobile communications) and UK PCN (Personal Communication Network) system

Front-panel connectors provide external modulation inputs for clock, data and envelope control. The wideband FM input is available for Doppler simulation.

Facilities are provided for modulation by an internal data source and for editing the data. The front-panel connectors provide outputs for clock and data in this mode.

Instruments may be locked together via the SYNC connectors to allow multi-carrier signals to be generated.

A 2030 or 2031 Signal Generator, fitted with the GMSK option, conforms to the 2030 series specification when in GSM mode (performance is not affected in other modes) except as follows:

PERFORMANCE DATA

CARRIER FREQUENCY

Range	2030: 10 MHz to 1.34675 GHz. 2031: 10 MHz to 2.69675 GHz.
-------	--

RF OUTPUT

Range:	0 dBm to -144 dBm.
Accuracy:	Less than ± 2 dB for carrier frequencies 10 MHz to 2 GHz.
Output VSWR:	As for 2030 series for levels below -6 dBm.

SPECTRAL PURITY

Non-harmonic output

GMSK signals are generated by mixing a local oscillator with a 3.25 MHz IF signal carrying the GMSK signal. Additional signals are present at the local oscillator frequency, image frequency and frequencies equivalent to the harmonics of the IF mixed with the local oscillator.

FREQUENCY STANDARD

In GSM mode an input or output at 1, 5, 10 or 13 MHz is available. On external standard input, sensitivity is 0 dBm.

OUTPUT VSWR

Specification applies to output levels less than -6 dBm.

RF LEAKAGE

Specification applies for carrier frequencies up to 2 GHz.

GMSK MODULATION

Modulation type

GMSK Bt 0.3 to GSM recommendation 05.04.

Modulation accuracy

Phase accuracy as defined by GSM 05.05 – 4.6 is 1° RMS, 3° peak.

Data coding

SelecTable as uncoded, or differentially coded to GSM recommendation 05.04 – 2.3 for internal or external modulation.

INTERNAL MODULATION

An internal data source provides a Traffic Channel format superframe hierarchy. Individual slots may be null data, fixed data, or contain (2^9-1) Pseudo Random Binary Sequence (PRBS) data as defined in CCITT rec. V.52. Successive slots contain 156, 156, 156, 157 bits when on internal clock or external 'integer' clock. An internal data source provides data output on the DATA and clock on the CLOCK connectors. Internal data can either be edited from the front panel and stored or entered using the GPIB.

The RF envelope may be ramped up and down to GSM 05.05 annex 2 and GSM 05.05 – 4.2.2.

The internal data generator can be used with an external clock as in 'External Modulation'.

Data storage

Data in the data generator can be stored and edited from the front panel or via the GPIB. Data store sizes are:

- 100 slots of which 2 are defined as null (SLOT 0) and PRBS (SLOT 99)
- 100 frames containing any of the stored slots in any order
- 100 multiframes containing any of the stored frames in any order
- 40 superframes containing any of the stored multiframes in any order.

Internal modulation outputs

Data output:	TTL compatible.
Clock output:	TTL compatible.

EXTERNAL MODULATION

Clock and data input at TTL compatible levels. Data must be valid on the falling edge of the clock input.

Data input level:	TTL compatible.
Clock input level:	TTL compatible.
Clock input frequency:	270.833 kHz \pm 25 parts/10 ⁶ or a clock of the same bit rate but including one clock period of 1 1/4 bits per slot.
Envelope input impedance:	15 k Ω nominal.
Doppler FM input impedance:	50 Ω .

ENVELOPE CONTROL

Controlled by selectable constant internal level, or from the external ENVELOPE input. External envelope levels are 0 V for off, +1 V for specified RF level. The RF output voltage varies linearly with applied voltage.

Input rise time:	Less than 4 μ s.
Off slot suppression:	Better than -70 dBc at 0 V.

MODULATION SENSE

Output frequency can be set to upper or lower sideband. Modulation sense can be inverted.

SYNCHRONIZATION

Instruments may be synchronized by use of the SYNC input/output. One instrument in Master mode sources a bit clock and the SYNC signal. The SYNC signal goes active low for one bit during the transition of the internal data from slot 7, bit 156 to slot 0, bit 0. Instruments in Slave mode use Clock and Sync signals to remain in synchronism.

Synchronization input/output:	Open collector TTL 2 mA pull-up, active low, bidirectional.
-------------------------------	---

DIMENSIONS AND WEIGHT

Height	Width	Depth	Weight
152 mm	425 mm	525 mm	19.0 kg
6 in	16.6 in	20.5 in	42 lb

GMSK OPERATION

INTRODUCTION

This chapter explains how to use Option 005 GMSK Bt 0.3 when fitted to a 2030 or 2031 Signal Generator. Familiarity with the normal operation of the instrument is assumed.

FRONT PANEL

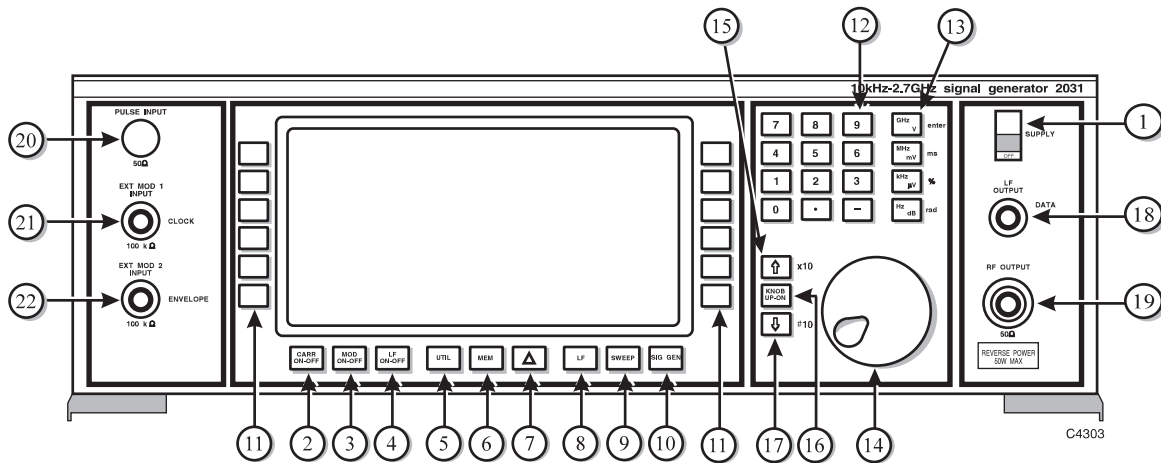

Fig. A-1 2031 series front panel with Option 005

- | | | |
|------|-------------------|--|
| (1) | SUPPLY | Switches the AC supply voltage on and off. |
| (2) | CARR ON-OFF | Enables or disables the carrier frequency. |
| (3) | MOD ON-OFF | Enables or disables the modulation. |
| (4) | LF ON-OFF | Switches the low frequency output on and off. |
| (5) | UTIL | Displays the utilities menu. |
| (6) | MEM | Displays the memory store/recall menu. |
| (7) | Δ | Displays the total shift menu. |
| (8) | LF | Displays the LF and monitor menus. |
| (9) | SWEEP | Displays the sweep status menu. |
| (10) | SIG GEN | Displays the main menu. |
| (11) | SOFT KEYS | Twelve function keys change notation as the menu changes. |
| (12) | NUMERICAL KEY PAD | For changing the value of a selected parameter. Minus sign and decimal point are included. |
| (13) | UNITS KEYS | Determine the units of set parameters and terminate the numerical entry. |
| (14) | CONTROL KNOB | When enabled, adjusts the value of the selected parameter. |

- | | | |
|------|-----------------------------------|---|
| (15) | $\uparrow \times 10$ | When knob disabled, increments a selected parameter. When knob enabled, increases knob sensitivity by value of ten. |
| (16) | KNOB UP-DN | Switches between control knob and $\uparrow\downarrow$ keys. |
| (17) | $\downarrow \div 10$ | When knob disabled, decrements a selected parameter. When knob enabled, decreases knob sensitivity by value of ten. |
| (18) | LF OUTPUT or
DATA | BNC socket provides a low impedance output at the frequency selected at the <i>LF GENERATOR MENU</i> or monitors the modulating signal. In GSM mode the connector is used for data input or output. |
| (19) | RF OUTPUT | 50 Ω N type socket with reverse power protection. |
| (20) | PULSE | 50 Ω BNC socket (if fitted) accepts a pulsed signal. |
| (21) | EXT MOD 1 or
INPUT CLOCK | 100 k Ω BNC socket. An independent input which allows an external modulation signal to be applied. In GSM mode it is used for clock input/output. |
| (22) | EXT MOD 2 or
INPUT
ENVELOPE | 100 k Ω BNC socket, similar to (21). In GSM mode the connector is used for external envelope control. |

REAR PANEL

The following facilities are available on the rear panel, see Fig. A-2.

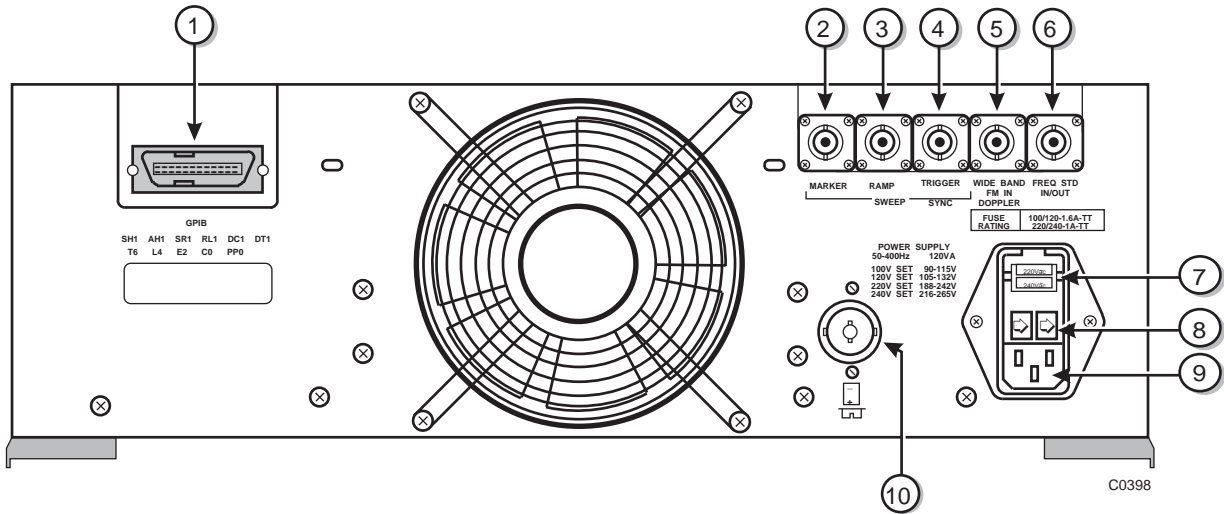
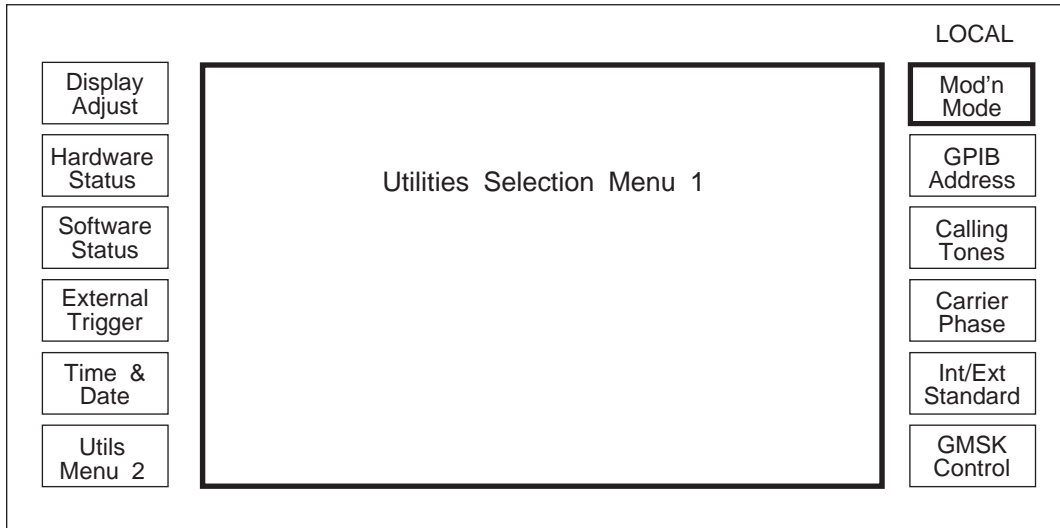

Fig. A-2 2031 rear panel with Option 005

- | | | |
|------|----------------------------|---|
| (1) | GPIB | 24 pin socket accepts standard IEEE connector to allow remote control of the instrument. |
| (2) | SWEEP MARKER | BNC socket supplies sweep marker. |
| (3) | SWEEP RAMP | BNC socket provides a ramp output at 0 to 10 V peak-to-peak. |
| (4) | SWEEP TRIGGER or SYNC | BNC socket provides access for a trigger input or SYNC input/output in GSM Mode. |
| (5) | WIDE BAND FM IN or DOPPLER | BNC socket accepts a wide bandwidth FM signal into 50 Ω with a typical bandwidth of 10 MHz. In GSM mode the connector may be used for Doppler simulation. |
| (6) | FREQ STD IN/OUT | BNC socket for standard frequencies at 1, 5 or 10 MHz with a nominal 2 V pk-pk level into 50 Ω . In GSM mode an additional standard of 13 MHz can be accepted and generated. |
| (7) | VOLTAGE SELECTOR | Removable cover reveals barrel which can be rotated to select the required voltage range. |
| (8) | FUSES | AC fuses rated at 1.6 A TT (double time lag) for the 100 to 120 V range and 1 A TT (double time lag) for the 220 to 240 V range. |
| (9) | AC SUPPLY INPUT | 3 pin plug integral with voltage selector and fuse holders. Mates with supply lead socket. |
| (10) | BATTERY HOLDER | Houses battery for real time clock. |

GSM MODE

The GSM mode of operation is an additional modulation mode. To enter this mode press the [UTIL] key and select the [Mod'n Mode] from the Utilities Selection Menu (see Fig. A-3).



C0340

Fig. A-3 Utilities selection menu 1

Use the [GMSK] key shown in Fig. A-4 to select the GSM mode of operation.

Note...

If the GSM modulation mode is not selected, the GSM data and controls can be edited and modified but GSM signals cannot be generated.

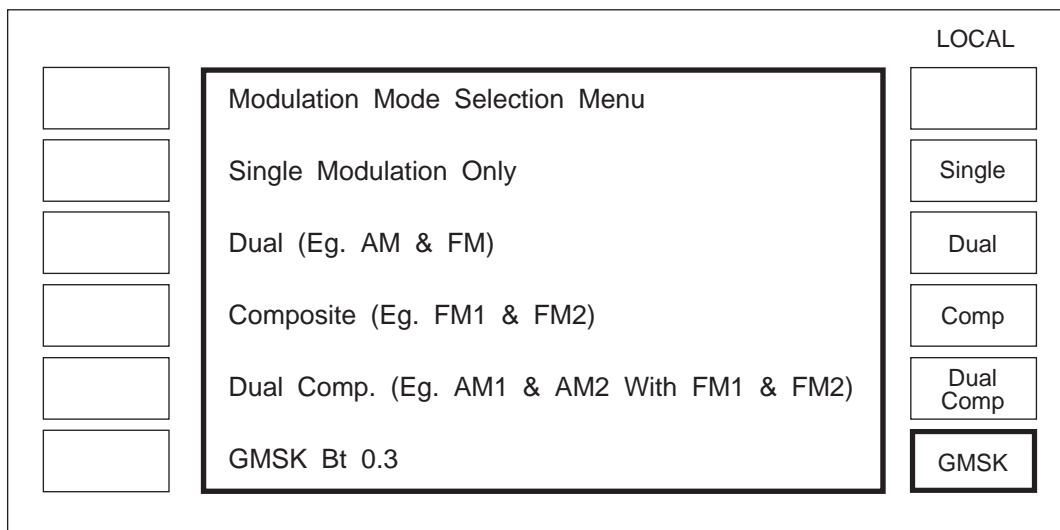

C0341

Fig. A-4 Modulation mode selection with GMSK

GMSK CONTROL

To set the GMSK control function, return to the Utilities Selection Menu 1 shown in Fig. A-3 and press the *[GMSK Control]* key to obtain the display shown in Fig. A-5.

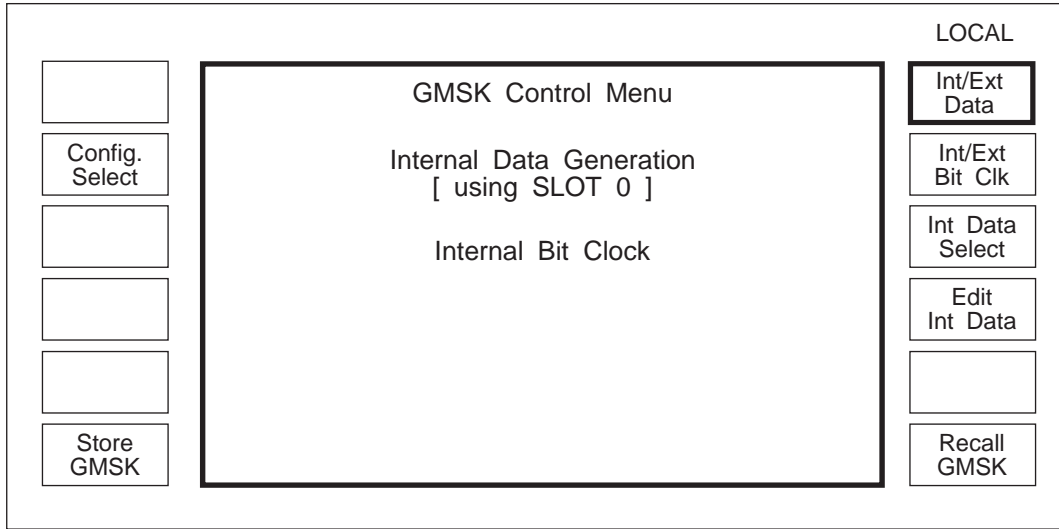

C0656

Fig. A-5 GMSK control menu with external data selected

Alternatively the *[GMSK Control]* key can be accessed by pressing the *[SIG GEN]* key to obtain the menu shown in Fig. A-6 (provided the GMSK modulation mode has been enabled).

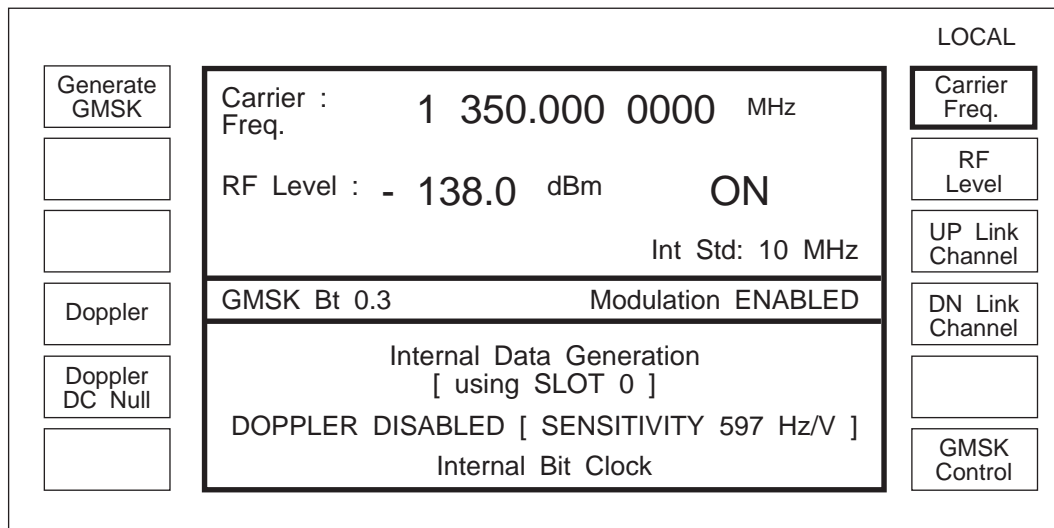

C0657

Fig. A-6 Sig. Gen. menu with internal data selected

Configuration select

Configuration select is used to set the way in which the GSM generator interacts with internal and external control signals. To set up the GSM configuration, press the [ConFig. Select] key shown in Fig. A-5 to obtain the menu shown in Fig. A-7.

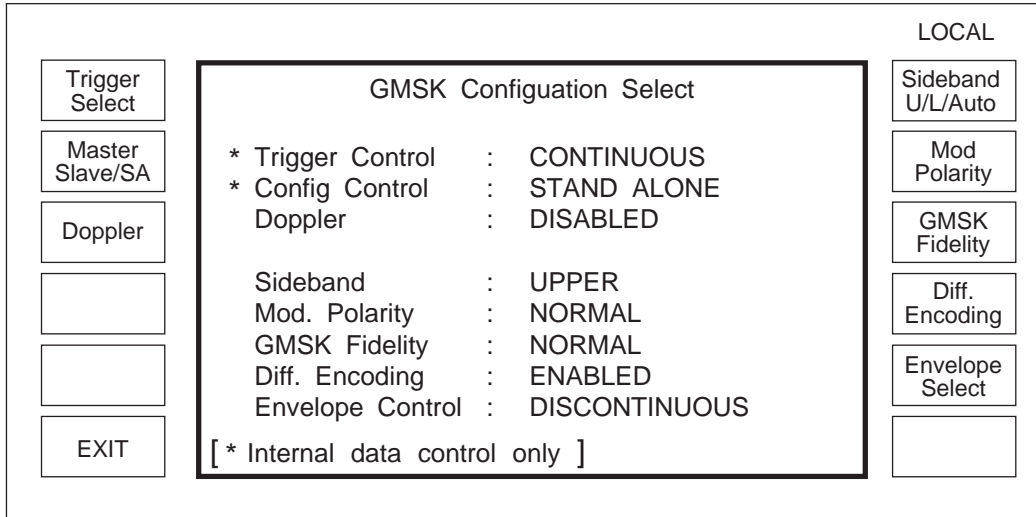

C0343

Fig. A-7 GMSK configuration selection menu

Trigger control

The [Trigger Select] key can be set to continuous or single trigger operation. In continuous mode the data from the internal data generator is repeated continuously while in the single mode the data is only generated once.

Configuration control

When using the internal data generator the instrument may be set to stand alone, master or slave mode using the [Master/Slave/SA] key. When *STAND ALONE* is selected the instrument responds in the normal way to GPIB or keyboard commands. When *MASTER* is selected the instrument generates a clock output from the CLOCK connector and a synchronizing signal from the SYNC connector on the rear panel. By connecting the clock and sync signals to a generator set to the slave mode the master will control the timing of the data generator in the slave instrument such that if the two RF signals are compared their slot structures are in synchronism. This allows the generator to be used in applications requiring two or more sources of GMSK signal.

Doppler

With Doppler set to *ENABLED* the DOPPLER input on the rear panel of the instrument may be used to frequency modulate the carrier using an external source to simulate the effect of Doppler frequency shifts. The DOPPLER input can also be used to add FM signals to simulate the effect of receiving signals with a GMSK phase error .

The sensitivity, in Hz/V, of the DOPPLER input is displayed on the Sig. Gen. Menu (Fig. A-6). The sensitivity is carrier frequency dependent since it uses the same input as Wideband FM and the instrument sets the sensitivity to be close to 500 Hz/V or the minimum sensitivity available (at 2 GHz the minimum sensitivity is typically 1200 Hz/V).

Sideband

The GMSK signals are generated by frequency converting a 3.25 MHz IF signal up to the required output frequency. Local oscillator frequencies at 3.25 MHz offset and an image frequency at 6.5 MHz offset of equal amplitude to the wanted signal are generated. The *[Sideband U/L/Auto]* key can be used to select the wanted GMSK signal and where the image frequency occurs. If *UPPER* sideband is selected the image and local oscillator frequencies are below the GMSK frequency. If *LOWER* sideband is selected the image and local oscillator frequencies are above the GMSK frequency. If *AUTO* is selected the generator automatically selects upper or lower sideband generation so as to generate the unwanted signals towards the center of the GSM or PCN band.

Modulation polarity

The *[Mod. Polarity]* key can be used to select either *NORMAL* modulation sense or *INVERSE* modulation sense. *INVERSE* can be used to simulate IF signals where the modulation sense has been reversed in frequency converting the input RF signal.

GMSK fidelity

The *[GMSK Fidelity]* key can be used to select either *NORMAL* which provides accurate GMSK Bt 0.3 modulation or *CORRUPT* which results in the generation of a signal with a RMS phase trajectory error of typically 5° RMS ($\pm 10^\circ$ peak). *CORRUPT* can be used to test the tolerance of a receiver to GMSK errors.

Differential encoding

The GSM specification requires that the data is differentially encoded. This is accomplished by setting the Differential Encoding to *ENABLED*. The differential encoder can be *DISABLED* when it is more convenient to work with uncoded data (e.g. when working with a basic demodulator).

Envelope select

The Envelope Control can be set to *CONTINUOUS* or *DISCONTINUOUS* using the *[Envelope Select]* key.

With *CONTINUOUS* envelope selected the RF signal is maintained at a constant level with no amplitude shaping being present.

When *DISCONTINUOUS* envelope is selected and an external data/clock source is being used, the RF Envelope is controlled using the *ENVELOPE* input on the front panel. The level is linearly controlled with 0 Volts producing no output and +1 V producing the nominal RF output. When using the internal data generator on *DISCONTINUOUS* envelope control, the RF output is suppressed at the start and end of each slot and remains suppressed on null slots.

Exit

Using the *[EXIT]* key on the GMSK Configuration Menu will return the operator to the GMSK Control Menu.

STORE/RECALL GMSK

The GMSK control settings can be stored or recalled using the *[Store GMSK]* and *[Recall GMSK]* keys on the GMSK Control Menu (Fig. A-5). The stores contain the settings of all the information on the GMSK Control Menu, including those set by the GMSK *[Configuration Select]*, but do not include other parameters displayed on the Sig Gen menu (e.g. carrier frequency, level). The facility provides a simple means of storing and recalling modulation settings without changing the carrier frequency and level. Valid store numbers are 0 to 19.

Note...

If a full store and recall facility is required, including carrier frequency and level, then the Full Store and Full Recall facilities accessed by the [MEM] key should be used. When a setting is Recalled the Full store includes the Modulation Mode setting (i.e. whether it is in GSM mode) but not those parameters stored by the *[Store GMSK]* key.

EXTERNAL DATA/CLOCK OPERATION

To generate GMSK Bt 0.3 modulation from an external source a data and clock source are required. The RF envelope can be set to continuous or external control via the ENVELOPE input using the Configuration Selection menu. External data mode is selected from the GMSK Control Menu using the *[Int/Ext Data]* key. In external data mode the clock input is used to phase lock the 13 MHz data generator clock and the RF output frequency is phase locked to this standard. If the clock is not applied *Error 06: VCXO Out of Lock* or *Error 43: No External Bit Clock* will appear at the top of the display.

Data must be valid on the falling (negative) edge of the clock input.

The clock frequency must either be 270.833 kHz, the GSM bit rate, or have a clock sequence with 155 successive periods corresponding to the GSM bit rate followed by 1 period corresponding to 1 1/4 bits of the GSM bit rate. The instrument will automatically lock on to either signal.

The presence of a 1 1/4 bit period will introduce a phase discontinuity on the RF signal at a time corresponding to approximately 3 bits in advance of the 1 1/4 bit period. The position of this phase discontinuity can be retarded in time using hardware links. Assuming the factory set condition is used and the 1 1/4 bit period is on bit 156, the phase discontinuity is in the guard bits and has no effect on a receiver.

Note...

In GSM mode the DATA input is used as the LF OUTPUT. This output is a low impedance source and care should be taken in connecting it to sensitive external loads. The LF OUTPUT is internally protected.

Setting the output carrier

The carrier output frequency and level are set by pressing the [SIG GEN] key to obtain the display shown in Fig. A-8. Carrier frequency and RF level can be selected and entered in the normal way.

Note...

In GSM mode the RF level extended hysteresis function is not available.

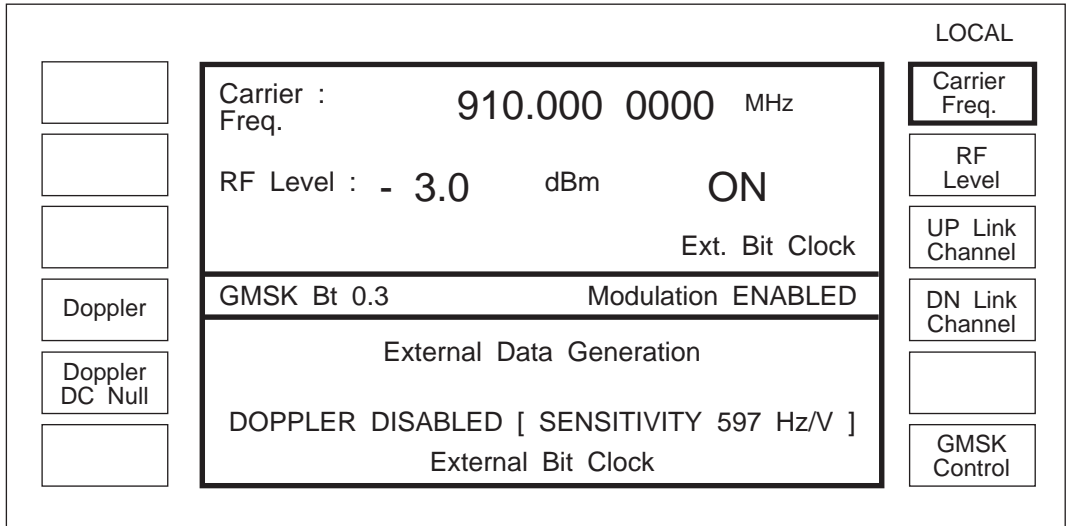

C0658

Fig. A-8 Sig. Gen. menu in GSM mode with external data/clock

In addition the carrier frequency can be edited directly by entering the channel number specified in the GSM and PCN standards. For GSM the usable channels are numbered 1 to 124 and for PCN are numbered 512 to 885. The channel frequencies are entered using [UP Link Channel] or [DN Link Channel] keys followed by the channel number and the [enter] key to set the mobile to base station and base station to mobile frequencies respectively.

INTERNAL DATA GENERATION MODE

The 2030 series GMSK option includes an internal data generator which obtains data from any of 100 slots. The slot information can be stored in a non-volatile store. The slots can be assembled into a frame structure and up to 100 of these frames may be stored. A 26 frame multiframe can in turn be assembled from any of the stored frames and up to 100 multiframe stored. The multiframe can be assembled into a 51 multiframe structure and up to 40 superframes can be stored. Any of slots/frames/multiframe/superframes may be used as the data source. The data can be generated once only or continuously repeated.

Data can be edited and stored from the front panel or from the GPIB.

The internal data generator can also be used with an external clock source as described under 'External Data/Clock Operation'.

Internal data selection

From the GMSK Control Menu, Fig. A-9, select [Int Data Select] to obtain the GMSK Internal Data Select menu shown in Fig. A-10. The [SLOT], [FRAME], [MULTIFRAME], [SUPERFRAME] keys may be used to select the data as slot, frame multiframe or superframe.

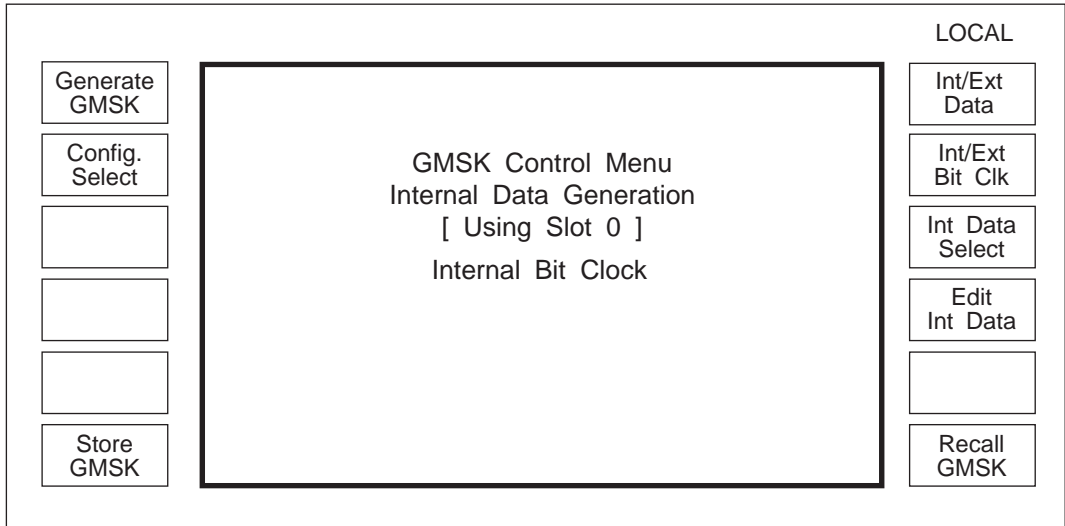

C0659

Fig. A-9 GMSK control menu

If slot data is selected the display shows the slot information as shown in Fig. A-10. The data is displayed as logical '1's and '0's. The first line of data shows the 3 tail bits, the second and third lines show 57 bits of data, the fourth line is a control bit, the fifth line is the midamble training sequence, the sixth line a control bit, the seventh and eighth lines the second block of 57 data bits and the ninth line consists of 3 tail bits.

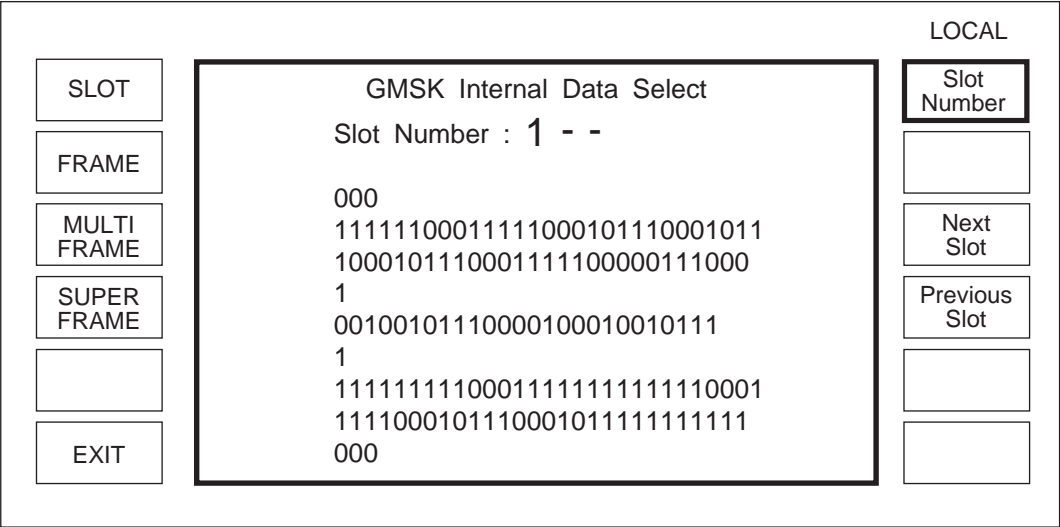

C0346

Fig. A-10 GMSK internal data selection menu with slot selected

Any slot number can be selected using [Slot Number] followed by a one or two digit number and terminated with the [enter] key. The [Next Slot] and [Previous Slot] keys provide a means of looking at slot information in the adjacent slot stores.

If frame data is required, selecting [FRAME] from the GMSK Internal Data Selection menu will result in the frame display shown in Fig. A-11. The stored slot number (S0 to S99) contained in the 8 slots (0 to 7) making up a frame is displayed. Any frame number can be selected and displayed using the [Frame Number] key followed by a one or two digit number and terminated with the [enter] key.

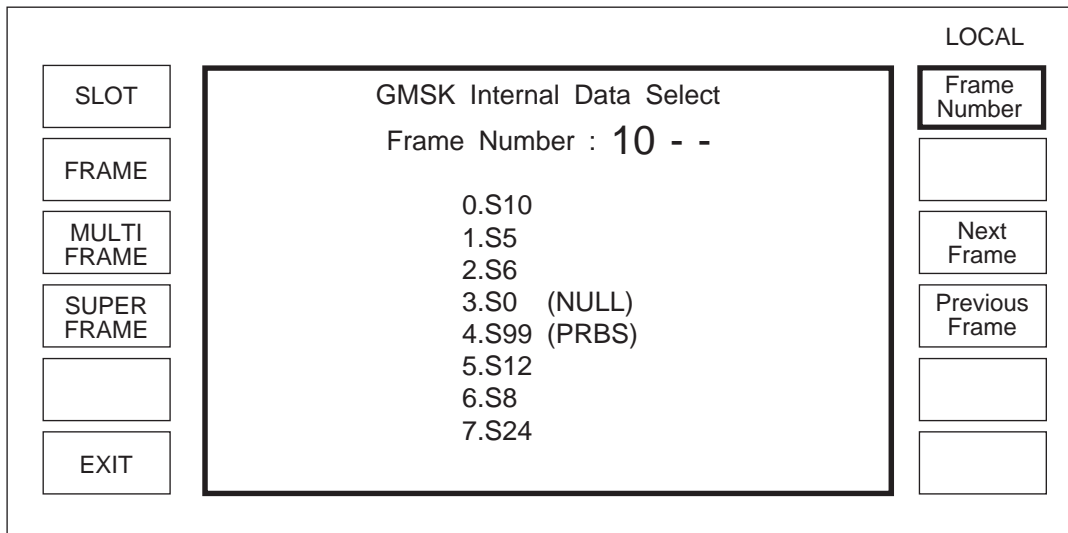

C0347

Fig. A-11 GMSK internal data select menu with frame selected

If [MULTI FRAME] is selected the data is displayed as shown in Fig. A-12. The multiframe data is shown as 26 frames (0 to 25) and the frame selected in each location is displayed (F0 to F99). Different multiframe can be selected using the [Frame Number] key.

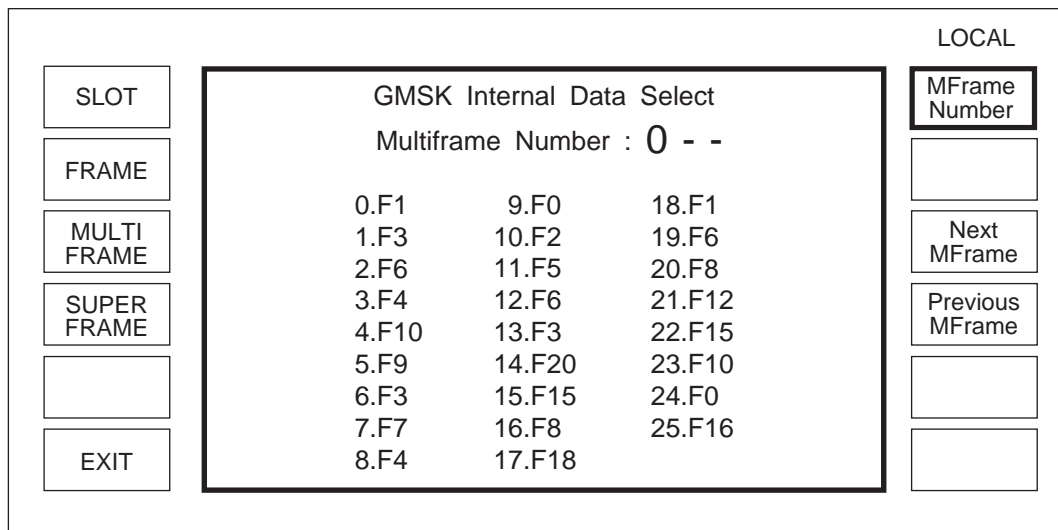

C0348

Fig. A-12 GMSK internal data select menu with multiframe selected

If [SUPER FRAME] is selected the data is displayed as shown in Fig. A-13. A superframe of 51 multiframe (0 to 40) is displayed with the multiframe data (MF0 to MF99) in each location.

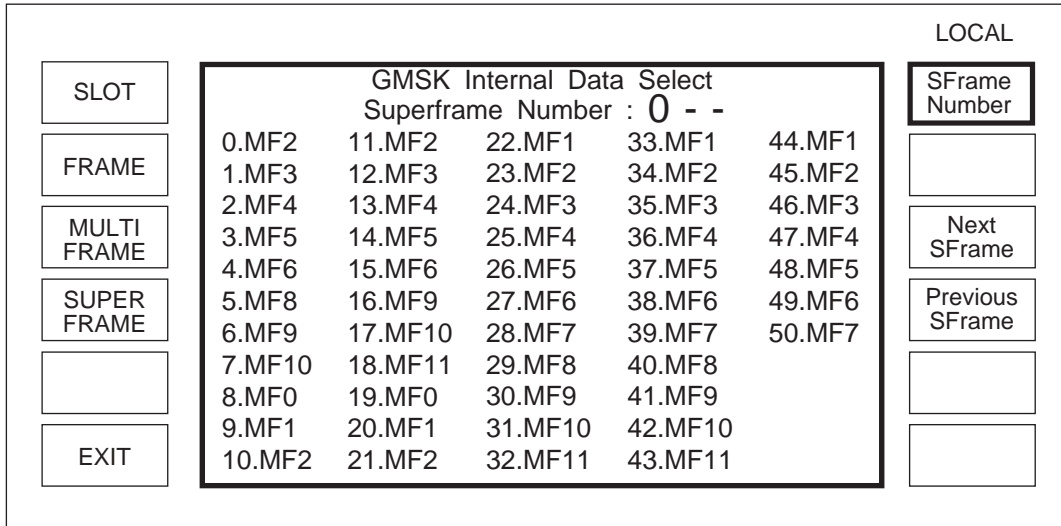

C0349

Fig. A-13 GMSK internal data selection menu with superframe selected

When the required data has been selected, selecting the [EXIT] key will return to the GMSK Control Menu and selecting [Generate GMSK] will result in the instrument generating the selected GMSK data. On selecting [Generate GMSK] the key will be replaced by a [Halt GMSK] key and selecting this key will stop GMSK generation.

Alternatively to display the carrier frequency and RF level when the data has been selected, press [SIG GEN]. The instrument display will be as shown in Fig. A-14. Selecting [Generate GMSK] will result in the instrument generating the selected GMSK data.

The carrier frequency and level can be entered from the Sig Gen Menu with internal data selected in the same way as with an external data source (see page A-13).

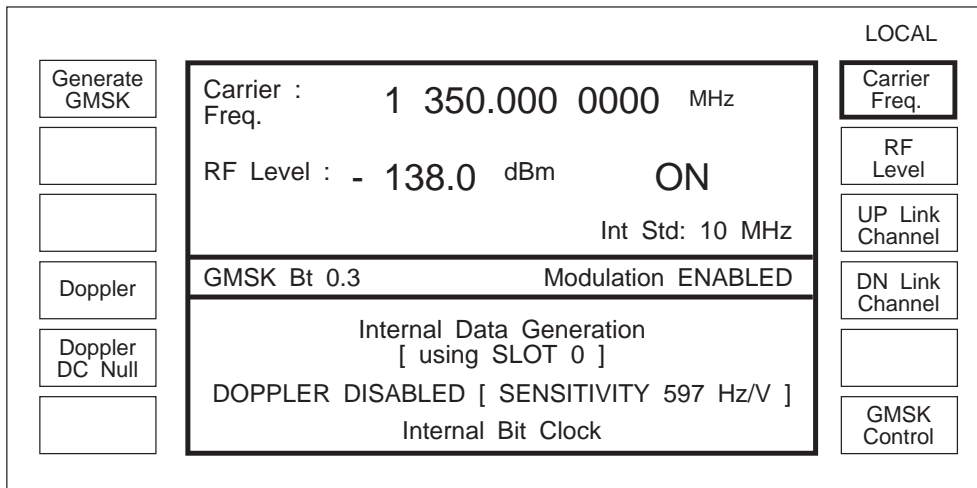

C0660

Fig. A-14 Sig. Gen. menu with internal data selected

Modulation ON/OFF

Pressing of the [MOD ON-OFF] key underneath the display will enable or disable the GMSK modulation. When modulation is disabled the generator reverts to normal mode and the GMSK module is bypassed.

External clock/internal data

The internal data generator can be used with an external clock with the same format clock as described under 'External data/clock operation'. To select an external clock press [Int/Ext Bit Clk] on the GMSK Control Menu (see Fig. A-9).

Notes...

In order to operate from an external bit clock, the configuration control (see 'Configuration control' above) must be set to either stand alone or slave mode. In master mode a bit clock output is generated on the CLOCK connector.

If external clock is selected but not applied, no error message is displayed.

DATA EDITOR

The data in a slot, frame, multiframe or superframe can be edited with the editor. To edit data select [Edit Int Data] on the GMSK Control Menu in Fig. A-9. The operating principle of the editor is similar whichever data (slot, frame, multiframe or superframe) is being edited. The data is displayed in the same format as shown under 'Internal Data Selection'. If a slot is being edited the data is displayed as shown in Fig. A-15. Having selected the data to be edited pressing the [EDIT] key will result in the display shown in Fig. A-16. A cursor box will appear in the position which is to be edited. Selecting [Set Bit to 0] or [Set Bit to 1] will enter a 0 or 1 at that point and the cursor will then automatically increment to the next bit. The cursor position can be moved by selecting [Bit Number] followed by a one to three digit number then pressing the [enter] key. [Next Bit], [Previous Bit] can be used to increment or decrement the cursor position.

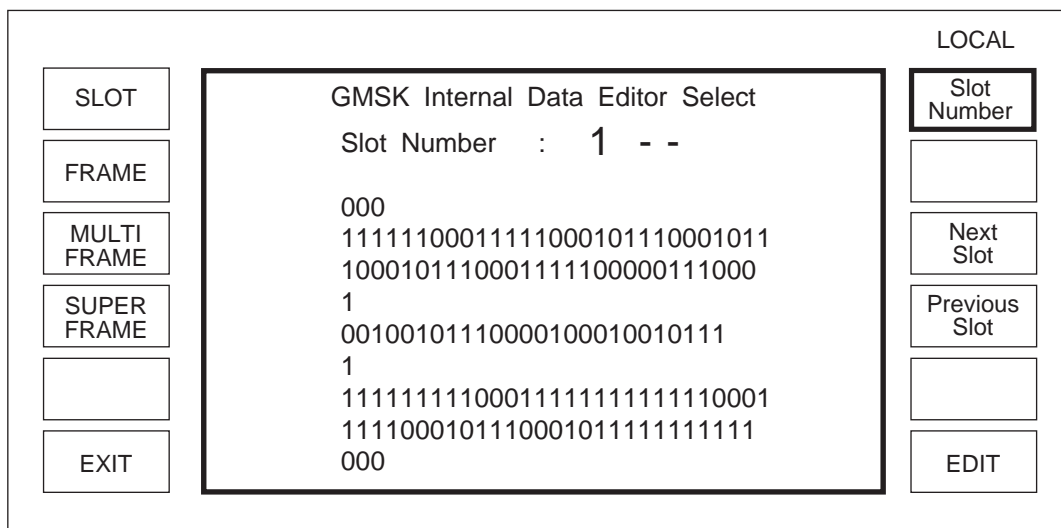

C0351

Fig. A-15 Data editor with slot editing selected

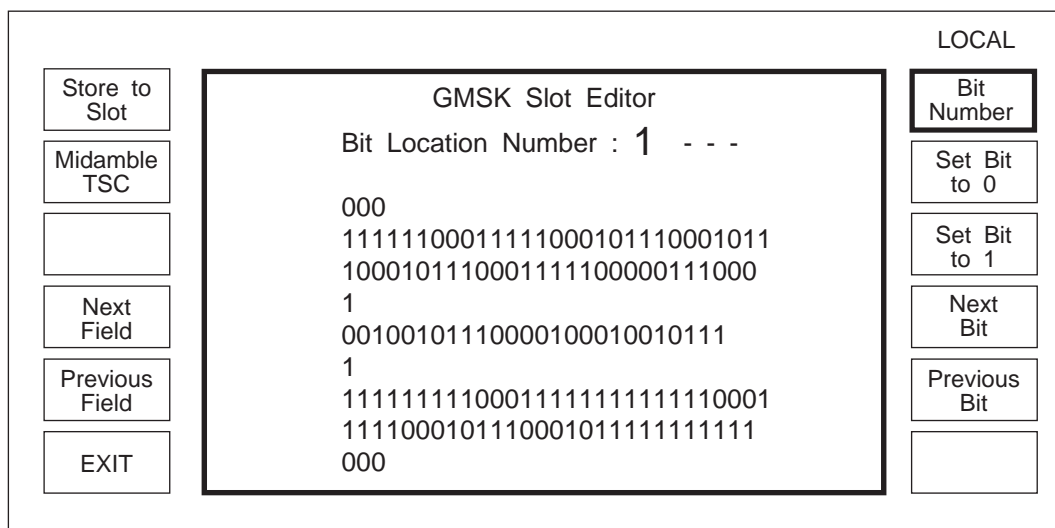

C0352

Fig. A-16 Editing slot data

The midamble training sequence (Midamble TSC) can be directly entered by selecting *[Midamble TSC]* followed by a number (0 to 7 as defined in the GSM standard) then pressing the *[enter]* key.

The cursor position can also be changed to the start of a field by using the *[Next Field]*, *[Previous Field]* keys. The fields are defined as the first tail bits, first data field, first control bit, midamble, second control bit, second data field, and final tail bits. The guard bits are not programmable and are set to 1.

When the data has been edited selecting *[Store to Slot]* followed by a one or two digit number and then pressing the *[enter]* key will result in the data being stored to the appropriate slot number (S1 to S98).

It should be noted that slots S0 and S99 are pre-defined slots and cannot be edited. S0 is defined as a NULL slot and S99 as a pseudo random bit sequence (PRBS) corresponding to that required of the GSM standard.

To return to the GMSK Internal Data Editor Select menu select the *[EXIT]* key.

Frame editor

Selecting *[FRAME]* on the GMSK Internal Data Editor will result in the display shown in Fig. A-17. The slot position being edited is displayed as S- and the location and data are displayed at the top of the page. The location to be edited can be entered using *[Location Number]* and the data at that point can be entered after selecting *[Location Data]*.

The edited data can be stored to any frame number by selecting the *[Store to Frame]* key followed by a one or two digit number then pressing the *[enter]* key.

To return to GMSK Internal Data Editor Menu select *[EXIT]*.

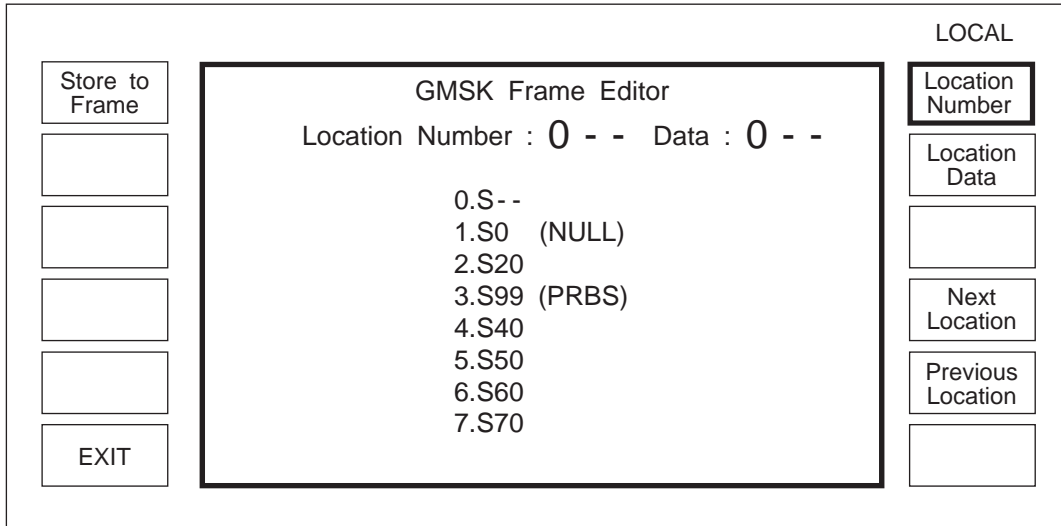

C0353

Fig. A-17 GMSK frame editor menu

Multiframe/superframe editor

Editing multiframe and superframe is accomplished in the same way as editing frames. The data is displayed in a similar format to that shown in Fig. A-12 and Fig. A-13. Information is stored in the same way as for frames. Multiframe can be stored as Multi Frame (MF) 0 to 99 and superframe as Super Frame (SF) 0 to 39.

FREQUENCY STANDARD

Instruments with the GSM option fitted can either accept a frequency standard of 13 MHz from an external source or generate a 13 MHz standard via the **FREQ STD INT/EXT** connector on the rear panel in addition to those available on other versions of the 2030 series. Selection is via the Utilities page 1 using the *[Int/Ext Standard]* key

The output frequency of the GSM signal is the sum of the local oscillator frequency and the 3.25 MHz IF carrying the modulation. The local oscillator and 3.25 MHz IF are locked in accordance with Table A-1 below

Table A-1 Frequency locking

INT/EXT STD set to:	Bit clock set to:	2030 local oscillator locked to:	3.25 MHz IF locked to:	INT STD O/P locked to:
INT	INT	Internal OCXO	Internal OCXO	Internal OCXO
INT 1, 5 or 10 MHz	EXT	Internal OCXO	Bit clock	Internal OCXO
INT 13 MHz	EXT	Internal OCXO	Bit clock	Bit clock
EXT	INT	External std	External std	N/A
EXT	EXT	External std	Bit clock	N/A

POWER UP OPTIONS

In some circumstances it may be desirable for the instrument to switch on with a GMSK signal being generated. To set an instrument to recall to GMSK setting on power up select the Utilities 2 Menu. Unlock the instrument using *[Lock & Unlock]* key to Level 1. The default password for Level 1 is 1234 (see page 3-1-38). Return to the Utilities 2 Menu and select the *[Power Up Option]* key to obtain the menu shown in Fig. A-18 when *[Memory Power Up]* is selected.

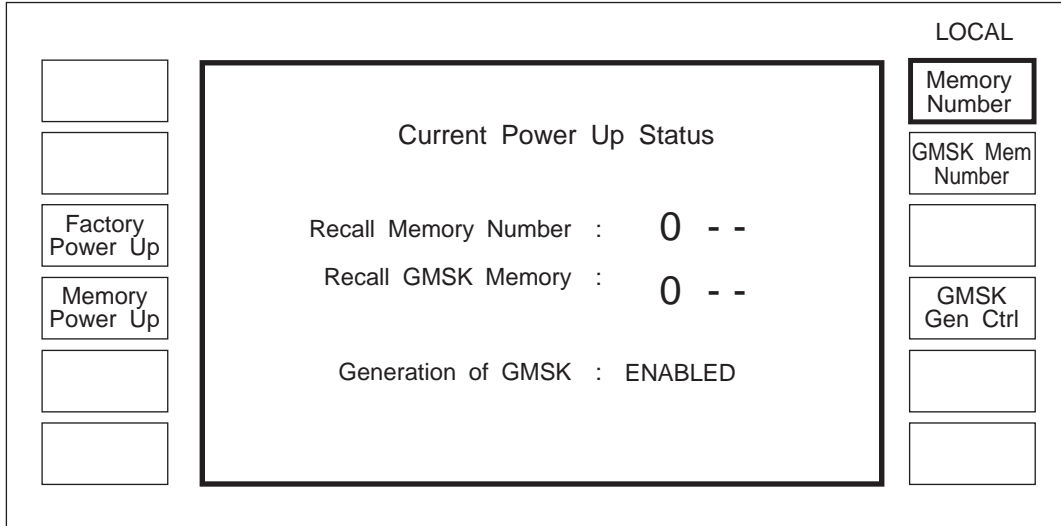

C0403

Fig. A-18 Power up options menu with memory power up selected

The default (maximum frequency, minimum level) *Factory Power Up* or a *Memory Power Up* can be selected. If a *Memory Power Up* is selected the signal generator setting is selected by defining the *Memory Number* (which sets carrier frequency, level, modulation mode etc.) and the GMSK memory to be recalled (see page A-13). The *[GMSK Gen Ctrl]* key can be used to set the generator to generate GMSK at power up if it is ENABLED and the modulation mode is GMSK.

ERROR HANDLING

Errors may be divided into three groups – foreground errors generally caused by a user, background errors which represent a condition of the instrument and GPIB errors which occur only when the unit is being controlled by a GPIB controller. Foreground and background errors specific to GMSK operation are shown in Tables A-2 and A-3 respectively.

Table A-2 Foreground errors

Error		Descriptive text	Error		Descriptive text
No.	Type		No.	Type	
93	exe	DSP Not Responding	151	exe	Illegal Slot Data
94	dde	GMSK Data Checksum	152	exe	Incorrect GMSK Data Type
149	exe	GMSK Parameter Unknown	153	exe	Incorrect Data Length
150	exe	Wrong LF units			

Table A-3 Background errors

Error		Descriptive text	Error		Descriptive text
No.	Type		No.	Type	
39	dde	GMSK Calibration Checksum	44	dde	No 13 MHz Standard
42	exe	RF Level limited by GMSK	45	exe	Carr., limited by GMSK
43	dde	No external bit clock			

GPIB OPERATION

The following GPIB Mnemonics are used to control the GMSK Bt 0.3 option in addition to those described in Chapter 3-2. But note that the external hysteresis commands HYST and HYST? have no effect.

ADDITIONAL COMMANDS

GMSK	[not used alone]
:DSOURCE	[not used alone]
:SLOT	Select the data source to be internal slot 0–99
Data type:	Decimal Numeric Program Data
Allowed suffices:	None
Default suffix:	None
:FRAME	Select the data source to be internal slot 0–99
Data type:	Decimal Numeric Program Data
Allowed suffices:	None
Default suffix:	None
:MFRAME	Select the data source to be internal multiframe 0–99
Data type:	Decimal Numeric Program Data
Allowed suffices:	None
Default suffix:	None
:SFRAME	Select the data source to be internal superframe 0–39
Data type:	Decimal Numeric Program Data
Allowed suffices:	None
Default suffix:	None
:EXTERNAL	Select the data source to be external
Data type:	None
Allowed suffices:	None
Default suffix:	None
:CLOCK	Select bit clock control for internal data (master/stand alone configurations)
Data type:	Character program data (either INTERNAL or EXTERNAL)
Allowed suffices:	None
Default suffix:	None
:MODOPT	[not used alone]
:SBAND	Select sideband control
Data type:	Character program data (any one of: UPPER, LOWER or AUTO)
Allowed suffices:	None
Default suffix:	None
:MODPOL	Select modulation polarity control
Data type:	Character program data (either NORMAL or INVERSE)
Allowed suffices:	None
Default suffix:	None

:FIDELITY	Bt selection control
Data type:	Character program data (either NORMAL or CORRUPT)
Allowed suffices:	None
Default suffix:	None
:ENCODING	Select differential data encoding control
Data type:	Character program data (either DISABLED or ENABLED)
Allowed suffices:	None
Default suffix:	None
:ENVELOPE	Select envelope control
Data type:	Character program data (either CONT or DISCONT)
Allowed suffices:	None
Default suffix:	None
:CTRL	[not used alone]
:TRIGGER	Select whether the internal data is generated in single shot or continuous operation
Data type:	Character program data (either SNGL or CONT)
Allowed suffices:	None
Default suffix:	None
:CONFIG	Select system configuration
Data type:	Character program data (any one of: MASTER, SLAVE or S_ALONE)
Allowed suffices:	None
Default suffix:	None
:DOPPLER	Select Doppler control
Data type:	Character program data (either DISABLED or ENABLED)
Allowed suffices:	None
Default suffix:	None
:START	Start GMSK internal data generation
Data type:	None
Allowed suffices:	None
Default suffix:	None
:STOP	Stop GMSK internal data generation
Data type:	None
Allowed suffices:	None
Default suffix:	None
:TEST	[not used alone]
:WFORM	GMSK test utility. Select test waveform 0–7 for generation (must set IMODE CAL first)
Data type:	Decimal Numeric Program Data
Allowed suffices:	None
Default suffix:	None

:ABORT	Exit the test suite
	Data type: None
	Allowed suffices: None
	Default suffix: None
GMSK:DSOURCE?	Prepares message containing information on the data source selected
	Examples: :GMSK:DSOURCE:EXTERNAL :GMSK:DSOURCE:FRAME 6
GMSK:CLOCK?	Prepares message containing information on the bit clock currently in use.
	Example: :GMSK:CLOCK INTERNAL
GMSK:MODOPT?	Prepares message containing information on GMSK modulation control settings in the following format: :GMSK:MODOPT:SBAND<status>;MODPOL<status>;FIDELITY<status>;ENCODING<status>;ENVELOPE<status> where: <status> is character program data for the specified mnemonic.
	Example: :GMSK:MODOPT:SBAND AUTO;MODPOL INVERSE;FIDELITY NORMAL;ENCODING DISABLED;ENVELOPE CONT
GMSK:CTRL?	Prepares message containing information on the GMSK main control settings in the following format: :GMSK:CTRL:TRIGGER<status>;CONFIG<status>;DOPPLER<status>; where: <status> is character program data for the specified mnemonic.
	Example: :GMSK:MODOPT:SBAND AUTO;MODPOL INVERSE;FIDELITY NORMAL;ENCODING DISABLED;ENVELOPE CONT
SLOT	[not used alone]
:LOAD	Load slot data into the GMSK editor. All 148 bits must be entered
	Data type: String program data consisting of 148 characters from 0 to 1 between string delimiters
	Allowed suffices: None
	Default suffix: None
:SAVE	Save slot data to the requested slot number (1–98)
	Data type: Decimal numeric program data
	Allowed suffices: None
	Default suffix: None
SLOT?	Prepares message containing information on the contents of the slot requested in the following format: :SLOT:LOAD<slot data>; where: <slot data> is string program data defining the controls of the slot requested.
	Data type: Decimal numeric program data
	Allowed suffices: None
	Default suffix: None
	Example: :SLOT:LOAD "100010001000....111110"

FRAME	[not used alone]
:LOAD	Load frame data into the GMSK editor. All 8 slot values must be entered
	Data type: Multiple decimal numeric program data
	Allowed suffices: None
	Default suffix: None
:SAVE	Save frame data to the requested frame number (0–99)
	Data type: Decimal numeric program data
	Allowed suffices: None
	Default suffix: None
FRAME?	Prepares message containing information on the contents of the frame requested in the following format
	:FRAME:LOAD:<frame data>
	where: <frame data> is multiple decimal numeric program data defining the contents of the frame requested.
	Data type: Decimal numeric program data
	Allowed suffices: None
	Default suffix: None
	Example: :FRAME:LOAD 34,6,15,99,0,22,44,76
MFRAME	[not used alone]
:LOAD	Load multiframe data into the GMSK editor. All 26 frame values must be entered
	Data type: Multiple decimal numeric program data
	Allowed suffices: None
	Default suffix: None
:SAVE	Save multiframe data to the requested multiframe value (0–99)
	Data type: Decimal numeric program data
	Allowed suffices: None
	Default suffix: None
MFRAME?	Prepares message containing information on the contents of the multiframe requested in the following format
	:MFRAME:LOAD:<mframe data>
	where: <mframe data> is multiple decimal numeric program data defining the contents of the multiframe requested.
	Data type: Decimal numeric program data
	Allowed suffices: None
	Default suffix: None
	Example: :MFRAME:LOAD 56,78,92,22,...12,0,5
SFRAME	[not used alone]
:LOAD	Load superframe data into the GMSK editor. All 51 multiframe values must be entered
	Data type: Multiple decimal numeric program data
	Allowed suffices: None
	Default suffix: None

:SAVE Save superframe data to the requested multiframe value (0–39)
Data type: Multiple decimal numeric program data
Allowed suffices: None
Default suffix: None

SFRAME? Prepares message containing information on the contents of the superframe requested in the following format
:SFRAME:LOAD:<sframe data>
where: <sframe data> is multiple decimal numeric program data defining the contents of the superframe requested.
Data type: Decimal numeric program data
Allowed suffices: None
Default suffix: None
Example: :SFRAME:LOAD 44,87,29,7,...77,65,1

MODULATION MODE

MODE

Set modulation mode
 Data type: Character Program Data (valid combinations of AM, AM1, AM2, FM, FM1, FM2, GMSK, PM, PM1, PM2, WBFM or PULSE, see Table below)
 Allowed suffices: None
 Default suffix: None
 Examples: `MODE AM, FM`
 `MODE FM1, FM2`

Single	Composite	Dual	Dual Composite	GMSK
AM1	AM1,AM2	AM1,FM1	AM1,AM2,FM1,FM2	GMSK
FM1	FM1,FM2	AM1,PM1	AM1,AM2,PM1,PM2	
PM1	PM1,PM2	AM1,WBFM	AM1,AM2,WBFM	
WBFM		PULSE,FM1	PULSE,FM1,FM2	
PULSE		PULSE,PM1	PULSE,PM1,PM2	
		PULSE,WBFM		

Note...

At any time the '1' may be omitted, for example FM is equivalent to FM1. Order is not important, for example AM,FM is equivalent to FM,AM.

MODE?

Prepares message containing information on Modulation Mode in the following format:

`:MODE:<mode>`

where: <mode> is character program data indicating the modulation mode settings.

Example: `:MODE FM1, FM2`

MEMORY – STORE

STO	[not used alone]
:FULL	Full Store 0–49
:PART	Partial Store 0–49
:CFRQ	Carrier Freq Store 0–99
:SEQT	Sequential Tones Store 0–19
:SWEEP	Sweep Store 0–19
:GMSK	GMSK store 0–19
	Data type: Decimal Numeric Program Data
	Allowed suffices: None
	Default suffix: None
Examples:	:STO:FULL 17 :STO:CFRQ 83

MEMORY – RECALL

RCL	[not used alone]
:FULL	Recall Full 0–49
:FXCF	Recall Full 0–49 (without carrier frequency)
:PART	Recall Partial 0–49
:RXCF	Recall Partial 0–49 (without carrier frequency)
:CFRQ	Recall Carrier Freq 0–99
:SEQT	Recall Sequential Tones Sequence 0–19
:SWEEP	Recall Sweep 0–19
:GMSK	Recall GMSK Store 0–19
	Data type: Decimal Numeric Program Data
	Allowed suffices: None
	Default suffix: None
Examples:	:RCL:FULL 15 :RCL:CFRQ 75

MEMORY – ERASE

ERASE	[not used alone]
:FULL	Erase all Full Stores
:PART	Erase all Partial Stores
:CFRQ	Erase all Carrier Freq Stores
:SEQT	Erase all Sequential Tones Stores
:SWEEP	Erase all Sweep Stores
:GMSK	Erase all GMSK Stores
:ALL	Erase <u>all</u> Stores
	Data type: None
	Allowed suffices: None
	Default suffix: None
Examples:	:ERASE:FULL 12 :ERASE:ALL

MISCELLANEOUS COMMANDS

- FSTD** Select internal or external frequency standard
- Data type : Character program data (any one of INT1, INT5, INT10, EXT1, EXT5 or EXT10, INT13, EXT13 (Option 005 fitted))
- Allowed suffices: None
- Default suffix: None
- Examples: INT10
EXT5
- FSTD?** Prepares message containing information on frequency standard selection in the format:
- :FSTD <char>
- Example: :FSTD EXT10

INSTRUMENT EVENT REGISTERS

This is a device dependant Register and the bits have meanings as shown in the list at the bottom of the page.

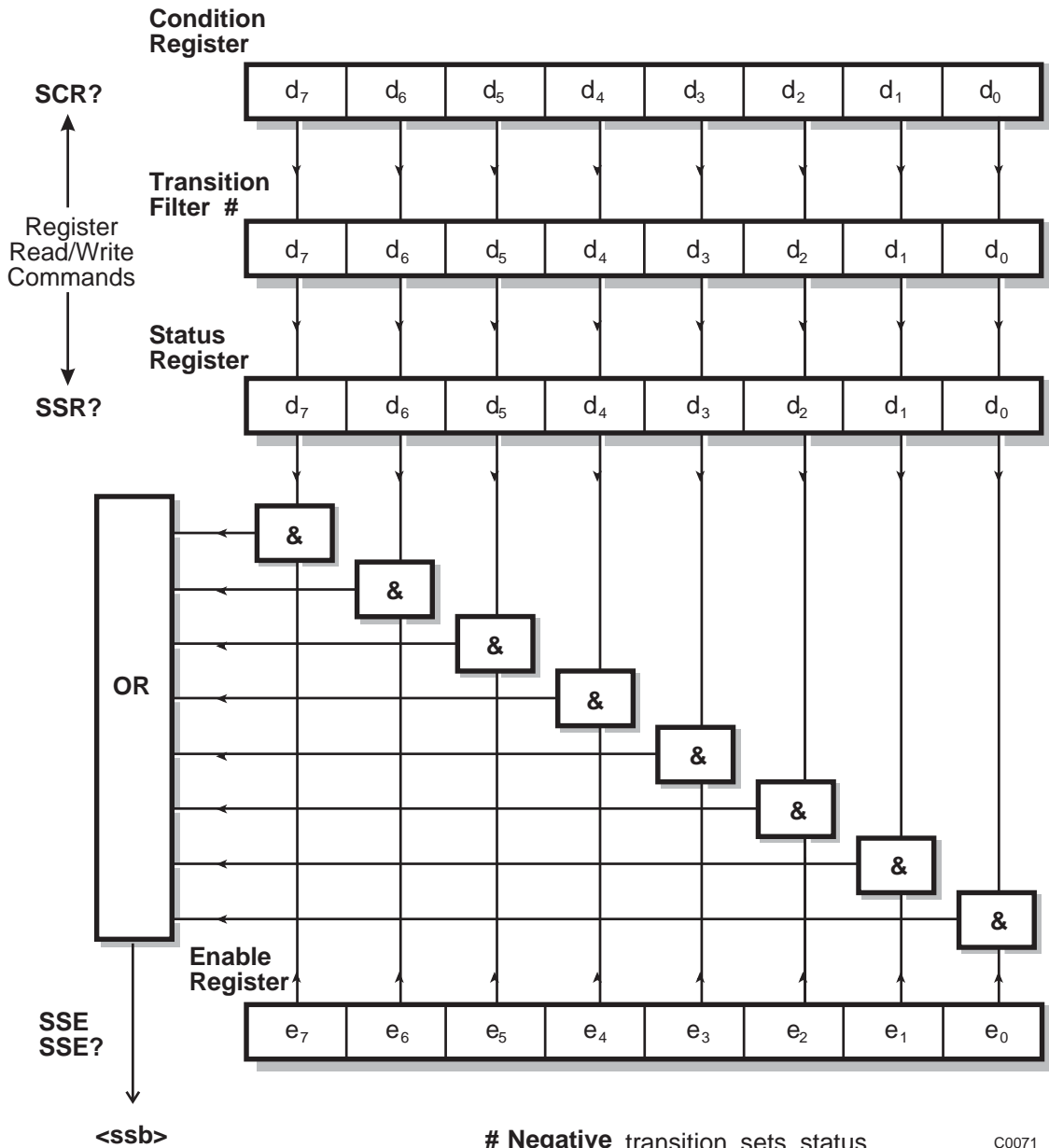

Condition (*SCR?)

- d₀ sweep in progress
- d₁ sending tones
- d₂ selfcal in progress
- d₃ dc fm null in progress
- d₄ generating GMSK
- d₅ not used
- d₆ not used
- d₇ not used

Event Status (*SSR?)

- end of sweep
- tones sent
- selfcal completed
- dc fm null completed
- GMSK generation suspended
- not used
- not used
- not used

<ssb> instrument event register summary bit

COUPLING EVENT REGISTERS

This is a device dependant Register and the bits have meanings as shown in the list at the bottom of the page.

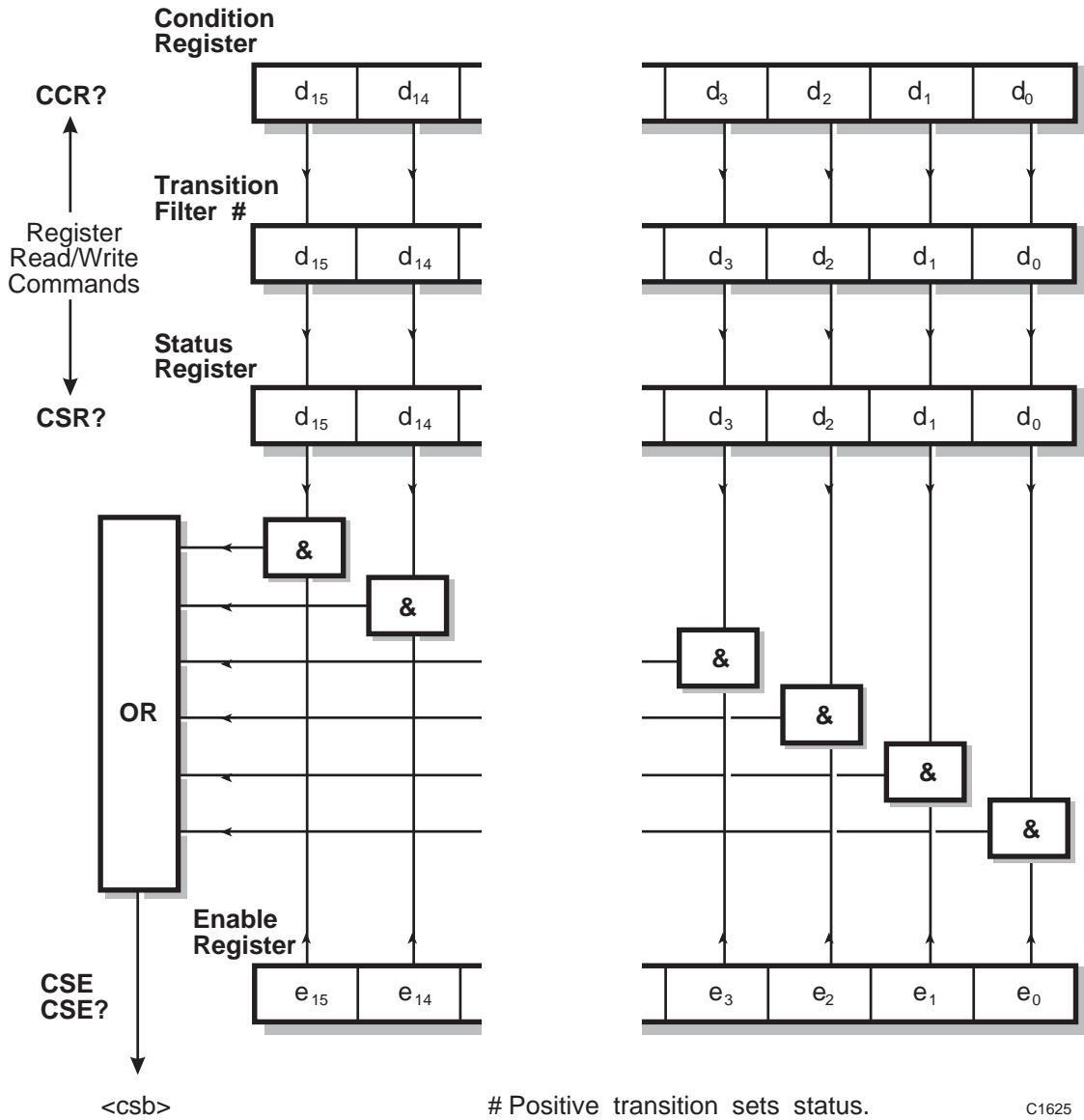

- d_0 rf level restricted by requested am
- d_1 fm restricted by requested carrier frequency
- d_2 widebandfm restricted by requested carrier frequency
- d_3 am2 depth restricted by requested am1 depth
- d_4 fm2 deviation restricted by requested fm1 deviation
- d_5 pm2 deviation restricted by requested pm1 deviation
- d_6 number of sweep steps restricted by other parameters
- d_7 carrier restricted by modulation mode
- d_8 rf level restricted by modulation mode
- <csb> coupling event register summary bit

ACCEPTANCE TESTING

INTRODUCTION

The test procedures in this section enable you to verify that the electrical performance of the signal generator complies with the Performance Data given earlier. The test equipment recommended for this purpose is listed in Table A-4. All tests may be performed with the covers in place and are intended to be carried out in the order given. For convenience, the test equipment and specification for each test are summarized before the test procedure.

Table A-4 Recommended test equipment

Description	Minimum specification	Example
Spectrum analyzer	10 MHz to 2 GHz Level accuracy ± 1 dB	IFR 2383
DVM	DC accuracy ± 0.01 V	Solatron 7150 +
DC power supply	0 V to 5 V	Weir 413D
GMSK analyzer	Measurement of GMSK Bt 0.3 modulation	Rohde & Schwarz FSEB with Option B7
Signal generator	Frequency range up to 15 MHz. Output level +13 dBm.	IFR 2030
Counter	Measurement range up to 15 MHz	IFR 2435

RF LEVEL ACCURACY

SPECIFICATION
RF level accuracy ± 2 dB

TEST EQUIPMENT		
Description	Minimum specification	Example
Spectrum analyzer	10 MHz to 2 GHz Level accuracy ± 1.5 dB	IFR 2383

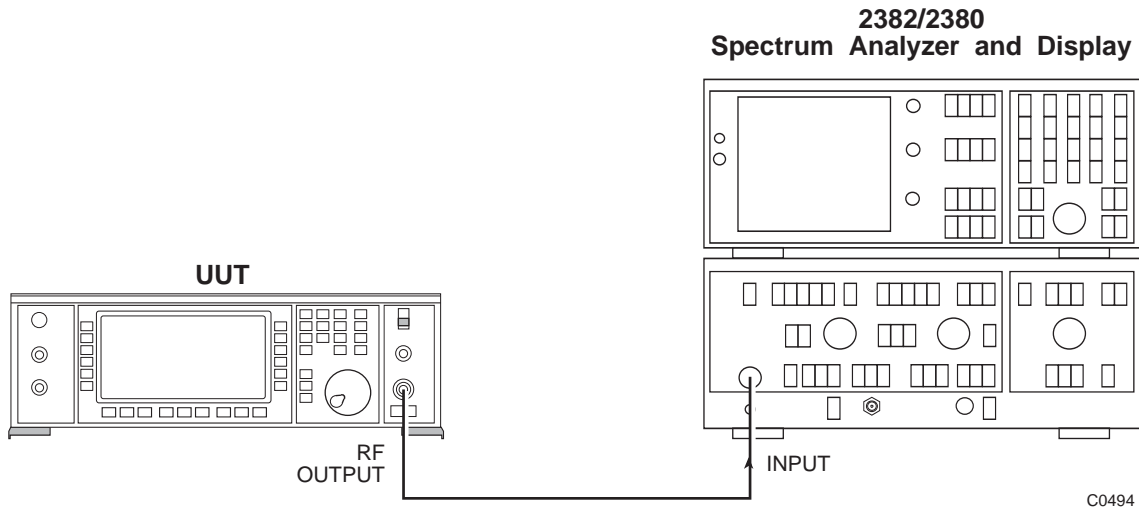

Fig. A-19 RF level test set-up

- (1) Connect the test equipment as shown in Fig. A-19.
- (2) Obtain a set of calibrated levels for the spectrum analyzer using the following procedure:

Preset and calibrate

Reference level 0 dBm

Span/div 50 kHz

Single sweep

Set the UUT as follows:

[Carrier Freq] as detailed in Table A-5

[RF Level] -10 dBm

[MOD] off

Tune the spectrum analyzer to the same frequency as the UUT. Take a sweep on the spectrum analyzer and use the marker peak find to measure the signal amplitude. Note this as the **calibrated level**. Repeat for all the frequencies in Table A-5.

- (3) Set the UUT to:

[Carrier Freq] 10 MHz

[RF Level] -10.0 dBm

[UTIL] [Mod'n Mode] [GMSK]

[UTIL] [Menu 2] [Latch Data] [Latch Number] 103 [enter] [Latch Data] 152 [enter]

This selects test waveform 0 which is a single tone at the selected frequency and level.

- (4) Check that the output level error with respect to the calibrated level is within specification.

(5) Repeat (3) and (4) above for the frequencies shown in Table A-5.

Table A-5 RF level test frequencies

Reference Frequency	Measured cal level	Measured level	Calculated error
10.00	_____	_____	_____
56.25	_____	_____	_____
131.25	_____	_____	_____
206.25	_____	_____	_____
356.25	_____	_____	_____
431.25	_____	_____	_____
506.25	_____	_____	_____
581.25	_____	_____	_____
656.25	_____	_____	_____
731.25	_____	_____	_____
806.25	_____	_____	_____
881.25	_____	_____	_____
956.25	_____	_____	_____
1031.25	_____	_____	_____
1106.25	_____	_____	_____
1181.25	_____	_____	_____
1256.25	_____	_____	_____
1331.25	_____	_____	_____
2031 Only			
1406.25	_____	_____	_____
1481.25	_____	_____	_____
1556.25	_____	_____	_____
1631.25	_____	_____	_____
1706.25	_____	_____	_____
1781.25	_____	_____	_____
1856.25	_____	_____	_____
1931.25	_____	_____	_____
2000.00	_____	_____	_____

GMSK MODULATION ACCURACY

Two methods of measuring the modulation accuracy are described, each with their own merits.

Method 1: Uses a GMSK analyzer to perform direct measurements at the frequencies of interest. This provides a quick and convenient analysis of the modulation errors but it should be noted that the phase accuracy specification of the recommended test equipment does not have sufficient stand-off to verify faithfully the performance of the UUT. This stresses the need to take into account the uncertainty of the test equipment, especially if borderline measurements are experienced.

Method 2: Uses a series of indirect measurements of the parameters that contribute to errors in the phase performance of the modulation process:

LO phase stability

Accuracy of the data in the DDS (Direct Digital Synthesizer) ROM

Quantization error in that data

DDS DAC errors

IF filter shape change from ideal due to component tolerances

The remainder of the IF gain changes.

Taking each contribution in turn:

(1) The most significant contribution to LO phase stability is the presence of line related sidebands. If the 50 Hz does not exceed -60 dBc and the 150 Hz does not exceed -62 dBc, (allowing for carrier frequencies up to 2 GHz) the phase error will not exceed 0.2° .

(2) & (3) Proven by design to be insignificant contributors.

(4) A first built-in test waveform is employed to stimulate the modulator. The RF spectrum is then analyzed. A second test waveform, with certain tones suppressed, is then applied to the modulator. The degree of tone suppression gives an indication of the phase errors present due to intermodulation and non-linearities within the DAC and subsequent circuitry. A measured level of -40 dBc would represent a worst-case phase error of 0.15° .

(5) & (6) Again, the first built-in test tone is used to stimulate the modulator. The RF spectrum is analyzed to check the symmetry of the channel filters. Components used typically have a tolerance of $\pm 5\%$, which would give a worst-case phase error of 0.1° . With a more likely spread of component tolerances, the error will be much less than this.

Method 2 therefore requires three measurements:

IF filter shape

DDS DAC errors

Line-related sidebands

SPECIFICATION
Phase accuracy as defined by GSM 05.05 – 4.6 is 1 degree RMS, 3 degrees peak.

GMSK Bt 0.3 MODULATION FIDELITY – method 1

TEST EQUIPMENT		
Description	Minimum specification	Example
GMSK Modulation Analyzer	Measurement of GMSK Bt 0.3 modulation	Rohde & Schwarz FSEB with Option B7 HP89441A

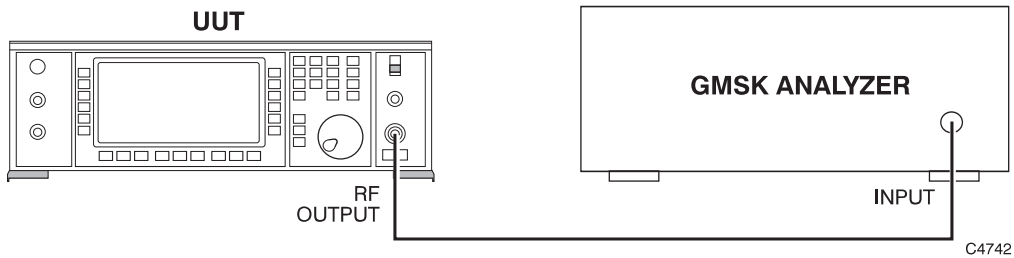

Fig. A-20 GMSK modulation accuracy test set-up

- (1) Connect the test equipment as shown in Fig. A-20.
- (2) Set the UUT as follows:
 - [Carrier Freq.] 900 MHz
 - [RF Level] -20 dBm
 - [UTIL] [Mod'n Mode] [GMSK] [SIG GEN]
 - [GMSK Control] [Int Data Select]
 - [Slot Number] 99 ENTER (to select PRBS)
 - [EXIT] [SIG GEN]
- (3) Set the GMSK analyzer to measure the GSM Digital Standard. Set it to the same carrier frequency and corresponding RF input level as the UUT. Ensure that no overload warning messages are being displayed. View the Table and Errors.
- (4) Set the UUT as follows:
 - [Generate GMSK]
- (5) On the GMSK analyzer, the PRBS pattern should be rolling through the symbol table. Read the RMS and peak phase errors, ensuring that they do not exceed the limits in Table A-6.
- (6) Repeat (4) at a carrier frequency of 1900 MHz.

Table A-6 GMSK modulation accuracy test

Carrier Frequency	Result		Limits	
	RMS	Peak	RMS	Peak
900 MHz	_____	_____	1°	3°
1900 MHz	_____	_____	1°	3°

GMSK Bt 0.3 MODULATION FIDELITY – method 2

IF filter shape

TEST EQUIPMENT		
Description	Minimum specification	Example
Spectrum analyzer	10 MHz to 2 GHz level accuracy ± 2 dB	IFR 2383

(1) Connect the test equipment as shown in Fig. A-19.

(2) Set the UUT as follows:

```
[Carrier Freq]      100 MHz
[RF Level]          -20 dBm
[UTIL] [Mod'n Mode] [GMSK]
[MOD]              On
```

(3) On the UUT built-in test waveform 1 can be selected by either:

```
[UTIL] [Menu 2] [Latch Data] [Latch Number] 103 [enter] [Latch Data]
153 [enter]
```

or:

Unlock the UUT to Level 2. Then select:

```
[UTIL] [Cal Vals][GMSK] [Test W'forms] [Waveform Number] 1 [enter]
```

Test waveform 1 is a carrier modulated with 15 tones each spaced about 102 kHz apart.

(4) Set the spectrum analyzer up as follows:

```
Preset and calibrate
Reference frequency      100 MHz
Span/div                 200 kHz
Reference level          -20 dB
Single sweep.
```

Take a sweep on the spectrum analyzer. The display should be similar to Fig. A-21.

On the trace check that:

- (a) All fifteen of the test tones are visible.
- (b) There are no noticeable spurious signals.
- (c) The shape of the complete spectrum is symmetrical.

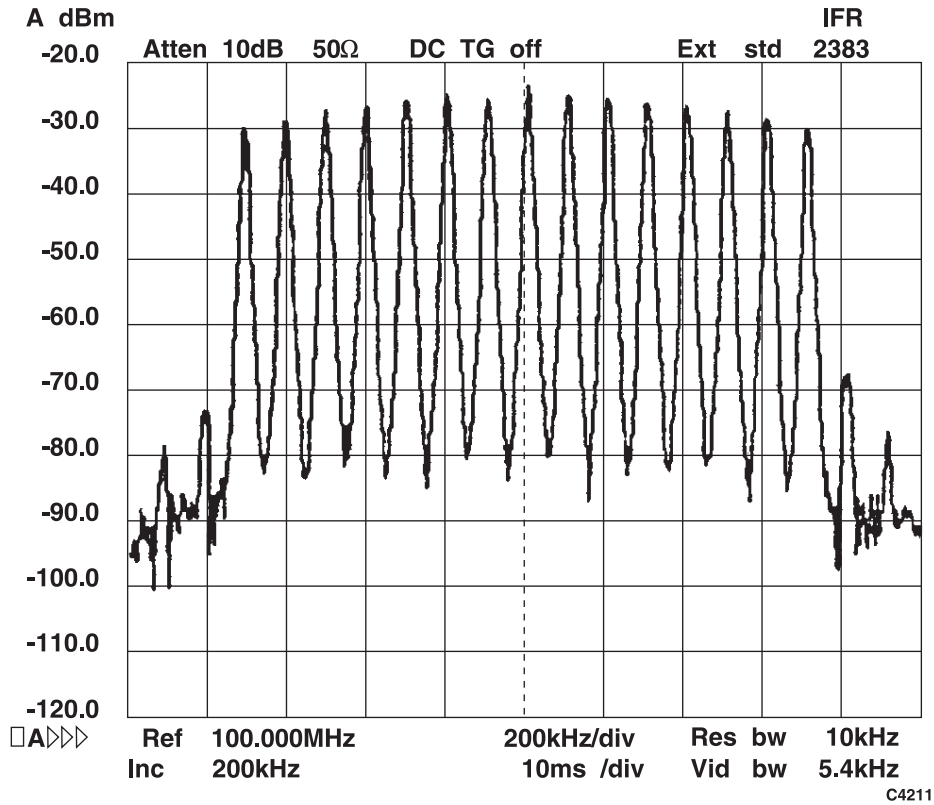

Fig. A-21 Spectrum of built-in test waveform 1

DDS DAC errors

- (1) Using the marker, note the frequency and level of the third, sixth, tenth and thirteenth tones (counting from the left). See Table A-7.
- (2) Select waveform 2 as follows:

[UTIL] [Menu 2] [Latch Data] [Latch Number] 103 [enter] [Latch Data] 154 [enter]

or:

Unlock the UUT to Level 2. Then select:

[UTIL] [Cal Vals] [GMSK] [Test W'forms] [Waveform Number] 2 [enter]

Test waveform 2 is similar to test waveform 1, but four of the tones have been suppressed. The suppressed tones are the third, sixth, tenth and thirteenth tones (counting from the left).

Line-related sidebands

- (1) Connect the test equipment as shown in Fig. A-19.
- (2) Connect the EXT STD on the rear of the spectrum analyzer to the FREQ STD IN/OUT of the UUT.
- (3) Set the UUT as follows:
 - [UTIL] [*Int/Ext Standard*] [*10MHz Int O/P*] [SIG GEN]
 - [*Carrier Freq.*] 1 GHz
 - [*RF Output*] 0 dBm
 - [MOD ON-OFF] (to disable modulation)
- (4) Set the spectrum analyzer as follows:
 - Reference frequency 1.000000050 GHz (same as the UUT + 50Hz)
 - Reference level -10 dBm
 - Span/Div 10 Hz
 - Resolution bandwidth 3 Hz
 - Video AVG option 2
- (5) Measure the level of the sideband: ensure it is <-60 dBc.
- (6) Increase the spectrum analyzer's reference frequency:
 - Reference frequency 1.000000150 GHz (same as the UUT + 150Hz)
 - Resolution bandwidth 10 Hz
- (7) Measure the level of the sideband: ensure it is <-62 dBc.

OFF-SLOT SUPPRESSION

SPECIFICATION

Better than - 70 dBc at 0 V

TEST EQUIPMENT

Description	Minimum specification	Example
Spectrum analyzer	10 MHz to 2 GHz level accuracy ± 2 dB	IFR 2383
DVM	DC accuracy ± 0.01 V	Solatron 7150 +
DC power supply	Range 0 V to 5 V	Weir 413D

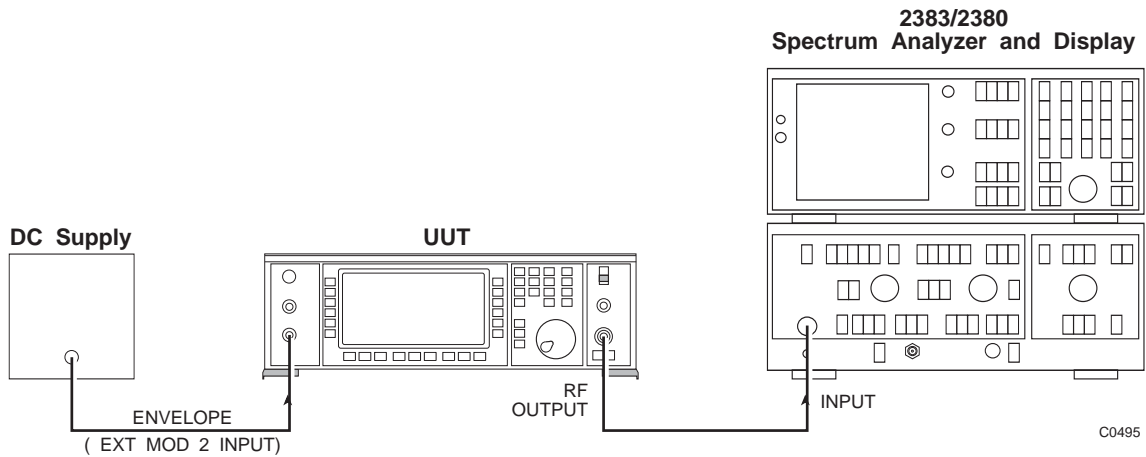

Fig. A-23 Off-slot suppression test set-up

- (1) Set the UUT as follows:

[Carrier Freq] 100 MHz
 [RF Level] 0 dBm
 [UTIL] [Mod'n Mode] [GMSK]
 [SIG GEN]

[GMSK Control] [Int/Ext Data] select ext data

Ignore the internal standard error which is displayed.

[GMSK Control] [ConFig Select]

Ensure that the control page is set up as follows:

<i>Trigger Control</i>	<i>Continuous</i>
<i>Configure Control</i>	<i>Stand Alone</i>
<i>Doppler</i>	<i>Disabled</i>
<i>Sideband</i>	<i>Upper</i>
<i>Mod polarity</i>	<i>Normal</i>
<i>GMSK Fidelity</i>	<i>Normal</i>
<i>Diff Encoding</i>	<i>Enabled</i>
<i>Envelope Control</i>	<i>Discontinuous</i>

- (2) Connect the DC source to the DVM and adjust the voltage until the DVM reads 1 ± 0.02 V. (Note that the carrier frequency is shifted by +67.7 kHz from 100 MHz.)
- (3) Connect the DC source to the ENVELOPE socket (EXT MOD 2 INPUT) as shown in Fig. A-23.
- (4) Set the spectrum analyzer as follows:

Ref frequency	100 MHz
RF level	0 dBm
Span/div	200 kHz
Sweep time/div	200 ms
Sweep mode	single sweep

Take a sweep on the spectrum analyzer and use the marker to measure the peak amplitude. Note this as a reference level.

- (5) Set the DC power supply to 0 V.
- (6) Take a sweep on the spectrum analyzer. Use the marker to measure peak level. Ensure that the measured level is -70 dBc with respect to the reference level.

FREQUENCY STANDARD

SPECIFICATION
In GMSK mode an input or output at 13 MHz is available.

TEST EQUIPMENT		
Description	Minimum specification	Example
Signal generator	Freq range up to 15 MHz. Output level +13 dBm	IFR 2030
Counter	Frequency range up to 15 MHz	IFR 2435

Output frequency check

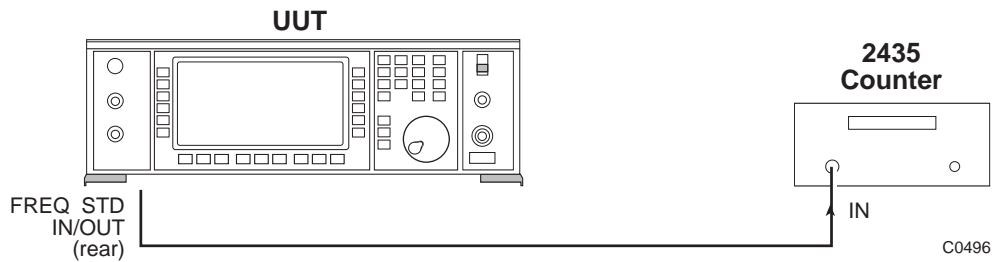

Fig. A-24 Frequency standard output test set-up

- (1) Connect the test equipment as shown in Fig. A-24.
- (2) Set the UUT as follows:

```
[UTIL] [Mod'n Mode] [GMSK]
[UTIL] [Freq Std] [Int 13 MHz]
```
- (3) Ensure that the frequency measured on the counter is 13 MHz \pm 3 Hz.

Frequency standard locking test



Fig. A-25 Frequency standard locking test set-up

- (1) Set the UUT as follows:

```
[UTIL] [Mod'n Mode] [GMSK]
[UTIL] [Freq Std] [Ext 13 MHz]
```
- (2) Ensure that UUT displays No 13 MHz Standard or VCXO Out of Lock.
- (3) Connect the test equipment as shown in Fig. A-25.
- (4) Set the signal generator as follows:

Carrier freq	13 MHz
RF level	13 dBm
- (5) Ensure that the external standard error is removed.

Annex B

OPTION 006 AVIONICS

CONTENTS

GENERAL DESCRIPTION	B-3
ILS mode.....	B-3
Marker beacon mode.....	B-3
VOR mode	B-3
ADF mode.....	B-3
SEL-CAL mode	B-3
PERFORMANCE DATA	B-4
AVIONICS OPERATION	B-6
ILS mode.....	B-7
DDM control.....	B-8
Localiser/glideslope frequency conversion	B-9
Tone suppression	B-10
Communication channel testing.....	B-10
Tone phase variability.....	B-11
Marker beacon mode.....	B-11
VOR mode	B-12
Sub-carrier peak deviation	B-12
Identity channel.....	B-15
ADF mode.....	B-15
SEL-CAL mode	B-16
Rotary control	B-18
GPIB OPERATION	B-19
ILS (Instrument Landing System) mode.....	B-20
Marker beacon mode.....	B-23
VOR (VHF Omnidirectional Radio Range) mode.....	B-24
ADF (Automatic Direction Finder) mode.....	B-27
Sel-cal mode.....	B-27
ACCEPTANCE TESTING.....	B-28
Introduction.....	B-28
Test equipment.....	B-28
Functional testing of ILS waveform generation	B-29
Accuracy of SDM (Sum Depth of Modulation) signal path.....	B-33
Accuracy of DDM (Difference Depth of Modulation) waveform.....	B-34
VOR waveform depth accuracy.....	B-36
VOR waveform test	B-37
Waveform phase control	B-38

LIST OF FIGURES

Fig. B-1 Utilities selection menu 1	B-6
Fig. B-2 Modulation mode selection menu.....	B-6
Fig. B-3 Avionics mode selection menu.....	B-7
Fig. B-4 SDM selection menu	B-7
Fig. B-5 DDM selection menu.....	B-8
Fig. B-6 DDM selection menu with presets	B-9
Fig. B-7 Tone suppression menu	B-10
Fig. B-8 Ident/Comms selected.....	B-10
Fig. B-9 ILS variable phase sub-menu	B-11

Fig. B-10	Marker beacon mode selection menu	B-12
Fig. B-11	VOR mode operation.....	B-12
Fig. B-12	VOR mode operation with peak deviation selection (screen 1).....	B-13
Fig. B-13	VOR mode operation with peak deviation selection (screen 2).....	B-13
Fig. B-14	REF selected.....	B-14
Fig. B-15	VOR mode operation with "Coupling" enabled	B-14
Fig. B-16	Ident/Comms selected.....	B-15
Fig. B-17	ADF mode selection menu	B-16
Fig. B-18	SEL-CAL mode selection menu.....	B-16
Fig. B-19	SEL-CAL tones utility.....	B-17
Fig. B-20	SEL-CAL tone entry.....	B-17
Fig. B-21	ILS functional test set-up.....	B-29
Fig. B-22	Oscilloscope trace for a 0% DDM waveform.	B-30
Fig. B-23	Spectrum analyzer trace for a 0% DDM waveform.	B-30
Fig. B-24	Oscilloscope trace for a 40% DDM waveform.	B-31
Fig. B-25	Spectrum analyzer trace for a 40% DDM waveform.	B-31
Fig. B-26	Oscilloscope trace for a 150 Hz dominant waveform.	B-32
Fig. B-27	Spectrum analyzer trace for a 150 Hz dominant waveform.	B-32
Fig. B-28	Accuracy of SDM signal path test set-up.....	B-33
Fig. B-29	Equipment configuration for DDM waveform accuracy.....	B-35
Fig. B-30	9.96 kHz sub-carrier with frequency modulation.....	B-37
Fig. B-31	Waveform phase control test set-up	B-38

GENERAL DESCRIPTION

This option provides internal generation of waveforms suitable for testing Instrument Landing Systems (ILS) and VHF Omnidirectional Radio Range (VOR) systems. Option 006 requires Option 001 (Second Modulation Oscillator) to be fitted.

ILS mode

In ILS mode the SDM (Sum of Depth of Modulation) of the 90 Hz and 150 Hz tones is entered to a resolution of 0.1% AM depth. The DDM (Difference in Depth of Modulation) is entered to a resolution of 0.01% depth for a DDM up to 20% and 0.1% for higher DDM settings. A choice of which tone is dominant is available to the user. DDM is also displayed in μA , to a resolution of 0.01 μA .

The 30 Hz repetition frequency of the ILS waveform can be adjusted in 0.1 Hz steps. For 0% DDM additional modulation signals can be added to the ILS waveform.

Marker beacon mode

In marker beacon mode the outer, middle and inner beacons can be tested by simple key selection.

VOR mode

In VOR mode the AM depth of the sub-carrier and 30 Hz tone can be independently set and the relative phase of the 30 Hz tone and the modulation tone on the sub-carrier is set by directly entering the bearing information in degrees. The VOR rate repetition rate of 30 Hz can be adjusted in 0.1 Hz steps. For a fixed bearing additional modulation can be applied to simulate voice/identity signal. A *[To/From]* beacon key provides a rapid means of reversing a bearing entry and accounting for different bearing conventions.

ADF mode

The ADF mode provides a simple method of testing automatic direction finding receivers operating on carriers with amplitude modulation.

SEL-CAL mode

In SEL-CAL mode the signal generator enables selective calling tones to be generated as amplitude modulation. This facility can be used to test the aircraft operator's communication system on commercial aircraft.

PERFORMANCE DATA

The following specification is in addition to that included in the 2030 series specification.

ILS MODE

Sum of Depth of Modulation (SDM)

Range:	0 to 99.9% in 0.1% steps representing the arithmetic sum of the individual tone depths.
Selection:	By keyboard entry of data and variation by \uparrow/\downarrow keys and rotary control.
Accuracy of SDM:	$\pm 2\%$ of setting for carrier frequencies up to 400 MHz (from 100 MHz to 400 MHz with Option 12). At 40% SDM, accuracy is $\pm 0.8\%$ depth. At 80% SDM, accuracy is $\pm 1.6\%$ depth.

Difference in Depth of Modulation (DDM)

	DDM can be entered in % or as a modulation index.
Range:	0 to 20% in 0.01% steps. 20 to 99.9% in 0.1% steps.
Selection:	By keyboard entry of depth in %, mA or index and variation by \uparrow/\downarrow keys and rotary control.
Accuracy of DDM:	± 0.0003 DDM ± 0.02 of setting. At 0 DDM (on course) accuracy is ± 0.0003 DDM (0.03% depth); At 0.155 DDM accuracy is ± 0.0034 DDM (0.34% depth).
Tone frequencies:	90 Hz, 150 Hz nominal. Tone frequency may be adjusted by varying the ILS repetition rate of 30 Hz in 0.1 Hz steps. Tone frequencies maintain 3:1 and 5:1 relationships with the ILS rate.
Tone suppression:	Either tone can be suppressed.
Additional modulation:	Available for 0% DDM from an internal or external modulation source.
Frequency accuracy:	As frequency standard.
LF output:	Available from the LF OUTPUT connector.
Accuracy of DDM:	Equivalent to $\pm 0.0003\%$ DDM ± 0.005 of setting. At 0 DDM (on course), accuracy is ± 0.0003 DDM.

MARKER BEACON MODE

Provides default modulation of 95% AM depth on a 75 MHz carrier at the modulation rate of 400 Hz (outer beacon), 1.3 kHz (middle beacon) or 3 kHz (inner beacon). AM depth, carrier frequency and modulation frequency can be changed from the default values.

VOR MODE

Selection:	By keyboard entry of depth and variable by \uparrow/\downarrow keys and rotary control.
Bearing control:	Relative phase of 30 Hz tone and sub-carrier modulation adjustable from 0° to 359.9° in 0.01° steps by entering VOR bearing. Bearing can be entered as TO or FROM the beacon.
Bearing accuracy	$\pm 0.05^\circ$.
Additional modulation:	Available on 0° bearing from an internal or external modulation source.
AM depth accuracy:	$\pm 3\%$ of setting $\pm 0.5\%$ for carrier frequencies up to 400 MHz (from 100 MHz to 400 MHz with Option 12).
Frequency:	The VOR repetition frequency of 30 Hz may be varied in 0.1 Hz steps. The sub-carrier frequency and deviation maintain a fixed relationship with the VOR repetition rate
Frequency accuracy:	As frequency standard. 9.96 kHz subcarrier.
AM range:	0 to 49.9% depth in 0.1% steps.
Modulation:	Frequency modulated by a 30 Hz tone with settable deviations of 240, 300, 360, 420, 450, 480, 510 and 540 Hz.

30 Hz tone

AM range: 0 to 49.9% depth in 0.1% steps.

Arithmetic sum of 30 Hz tone and sub-carrier AM depth limited to 99.8%.

ADF MODE:

Does not apply with Option 12 fitted.

Provides default modulation of 30% AM depth on a 190 kHz carrier at 1 kHz modulation rate. AM depth, carrier frequency and modulation frequency can be changed from the default values.

SEL-CAL MODE

Provides amplitude modulation with SEL-CAL (SElective CALling) tones.

Data entry: By soft keys labelled A to S, of up to 2 pairs of characters.

Timing: Default 1 s tone duration, 250 ms tone gap. Tone gap, duration and start delay can be changed from the default values.

AVIONICS OPERATION

This section explains how to use Option 006 when fitted to a 2030 series Signal Generator. Familiarity with the normal operation of the instrument is assumed.

The Avionics option offers modes of operation suitable for testing ILS and VOR systems. It also provides efficient testing of ADF (Automatic Direction Finders) and SEL-CAL receivers. It is assumed that the operator has some knowledge of the operation of these avionics systems.

The Avionics mode is selected by pressing the [UTIL] key and selecting the [Mod'n Mode] key on the Utilities 1 page shown in Fig. B-1 to obtain the menu shown in Fig. B-2. Selecting [Avionics Mode] from this menu will result in the *Avionics Mode Selection menu* shown in Fig. B-3 being displayed. Pressing the appropriate soft key will result in the instrument entering the required mode of operation; pressing [Other Modes] returns the display to the *Modulation Mode Selection menu*.

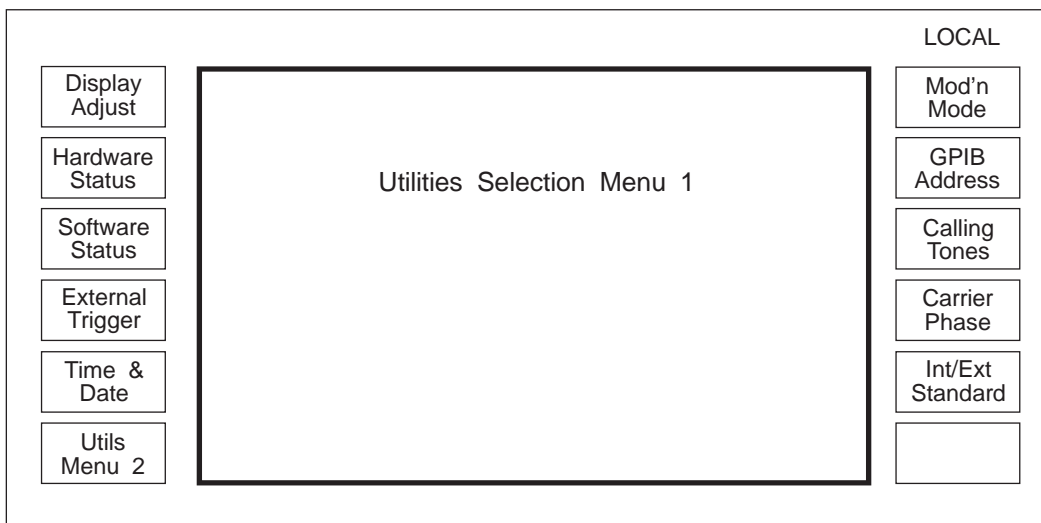

C0404

Fig. B-1 Utilities selection menu 1

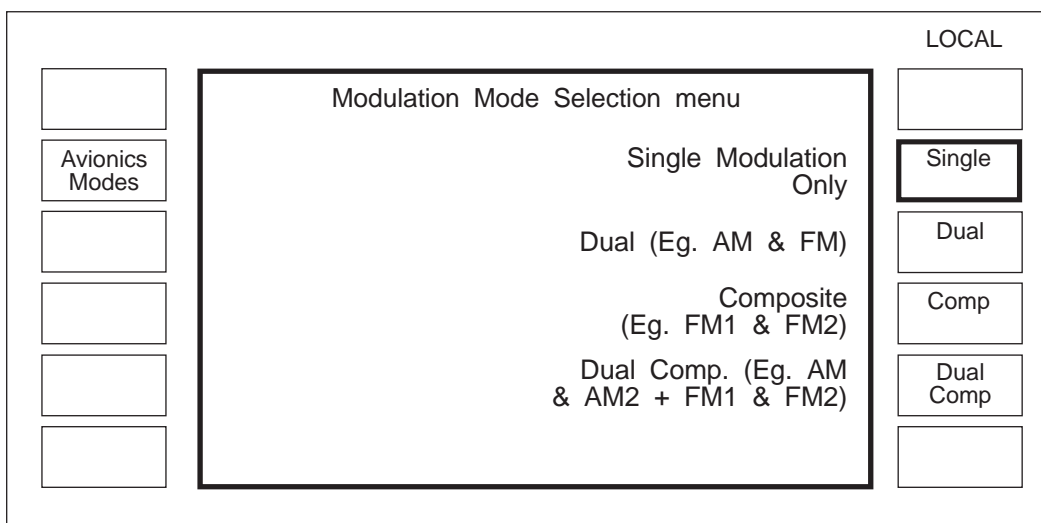

C0361

Fig. B-2 Modulation mode selection menu

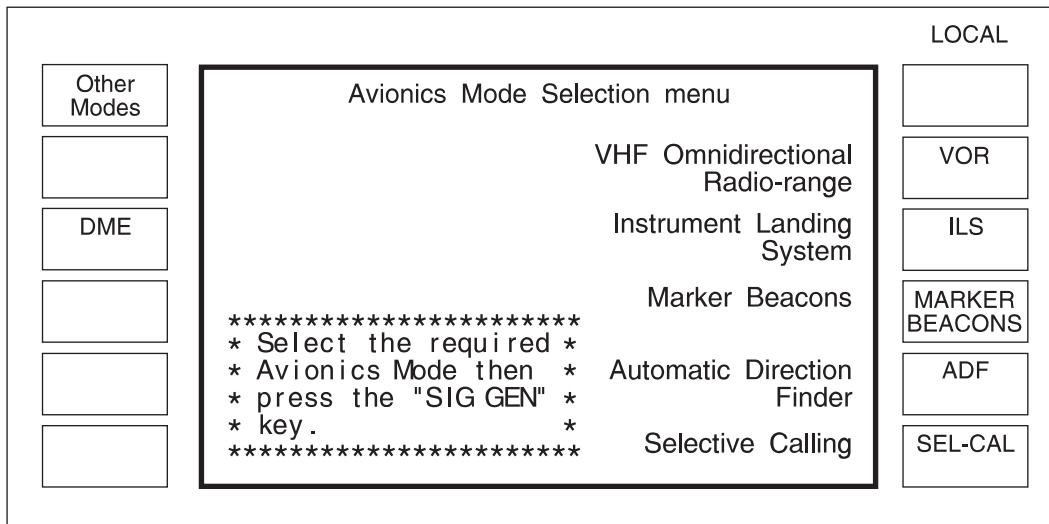

C2913

Fig. B-3 Avionics mode selection menu
 ([DME] is only available if Option 010 is fitted)

ILS mode

Pressing [ILS] and then pressing the [SIG GEN] key will result in the display shown in Fig. B-4. The default carrier frequency for ILS mode is 108.1 MHz.

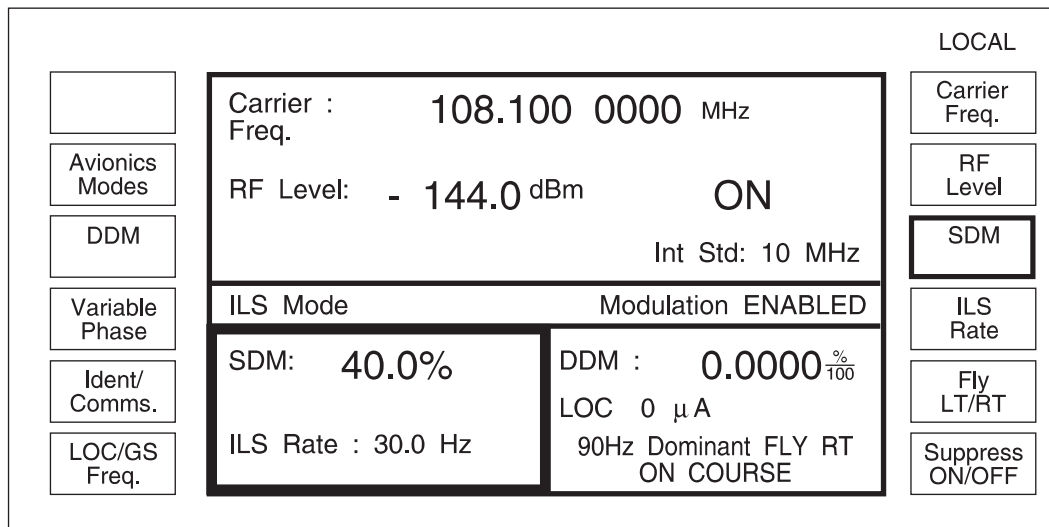

C2914

Fig. B-4 SDM selection menu

The sum of depth of modulation (SDM) is the arithmetic sum of depth of the modulating 90 Hz and 150 Hz tones. Using the [SDM] key the depth can be entered in %. The ILS rate is normally set to 30 Hz and is the ILS waveform repetition rate. Its frequency can be modified using the [ILS Rate] key. If the ILS rate is adjusted the frequency of the 90 Hz and 150 Hz alter on a pro-rata basis (e.g. If ILS Rate = 29 Hz the tone frequencies are 87 Hz and 145 Hz).

DDM control

From the SDM Selection Menu (Fig. B-4) DDM may be entered by pressing the *[DDM]* key to obtain the display shown in Fig. B-5.

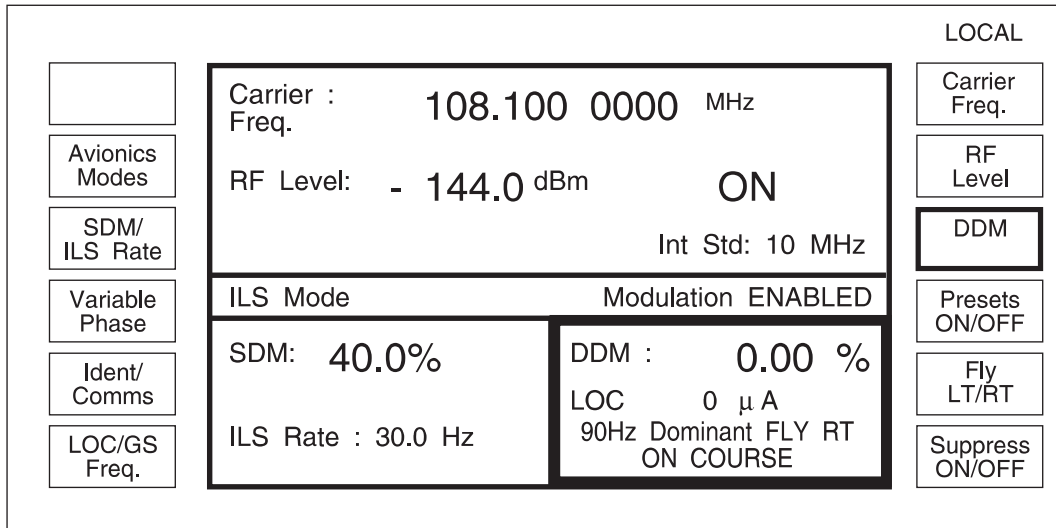

C2915

Fig. B-5 DDM selection menu

The DDM can be entered in %, as a modulation index (%/100) or in microamps (μA) and displayed on the *Sig Gen* menu in %, as a modulation index, microamps or as the attenuation ratio between the 90 Hz and 150 Hz tones in dB, according to the formula:

$$R_{\text{dB}} = 20 \log_{10} \left\{ \frac{(\text{SDM} + \text{DDM})}{(\text{SDM} - \text{DDM})} \right\} \mu\text{A}$$

If the setting to be entered is a modulation index terminate the entry with the *[enter]* key. Alternatively, if the setting to be entered is in microamps terminate the entry with the *[ms]* key. The microamp entry is converted to the nearest 0.01%. If the carrier frequency is below 200 MHz the signal is assumed to be for a localiser and if it is above 200 MHz the signal is assumed to be for a glideslope. The following conversion factors are used:

150 μA \equiv 15.5% DDM on the localiser

150 μA \equiv 17.5% DDM on the glideslope

The units displayed can be changed without entering any data. Press the *[enter]* and *[%]* keys to toggle between modulation index and percentage. Press the *[ms]* and *[dB]* keys to toggle between microamps and attenuation ratio.

The *[Fly/LT/RT]* key can be used to set which tone has the greater depth of modulation and the dominant tone is displayed under the DDM set. When 90 Hz is dominant the aircraft is either to the left (localiser) or too high (glideslope). The corresponding action to be taken is displayed as *FLY RT* and *FLY DN*. Similarly when 150 Hz is dominant the aircraft is either to the right (localiser) or too low (glideslope). The corresponding action to be taken is displayed as *FL LT* and *FLY UP*. If 0% DDM is set the additional text *ON COURSE* is displayed.

DDM values can be entered using the DDM presets which provide a fast method of selecting commonly used DDM values. The DDM presets are selected using the *[Presets ON/OFF]* key and Fig. B-6 is produced.

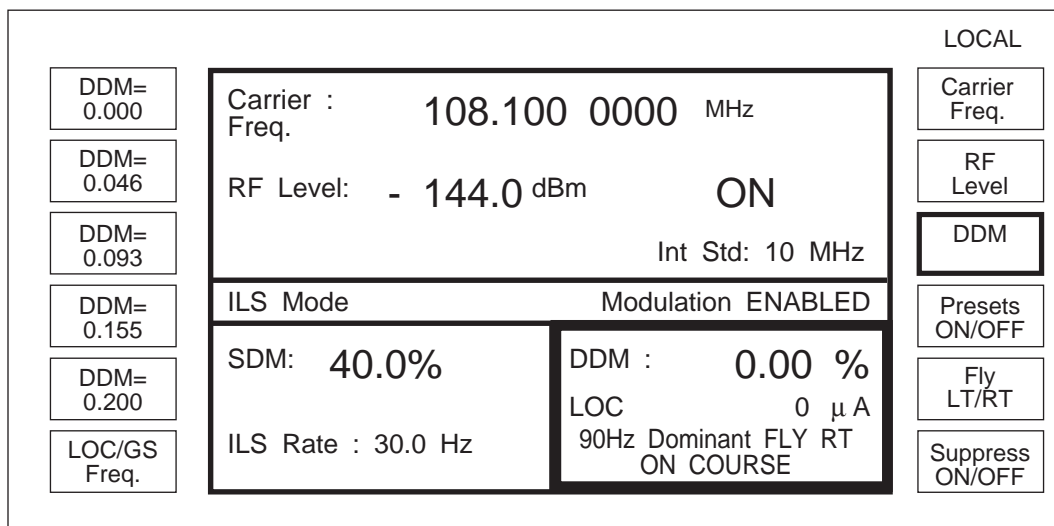

C1124

Fig. B-6 DDM selection menu with presets

Five DDM preset values can be selected for either localiser or glideslope frequencies. The DDM value can still be modified by the normal numeric entry, increment or rotary controls as well as the preset mechanism. The DDM value is displayed in modulation index format when a preset value is chosen. The equivalent glideslope DDM preset keys (0.000, 0.045, 0.092, 0.175, 0.400) are displayed when a glideslope frequency is entered. The normal DDM selection menu is selected by pressing the *[Presets ON/OFF]* key.

Localiser/glideslope frequency conversion

International agreements specify that localiser and glideslope frequencies are paired on any ILS installation. The *[LOC/GS Freq.]* provides a convenient means of switching between the localiser and glideslope frequencies. Provided the carrier frequency is set near to a recognised ILS frequency, pressing *[LOC/GS Freq.]* will result in the carrier being changed to appropriate paired frequencies.

Note...

If the carrier frequency is not set precisely to the glideslope or localiser channel frequency and the *[LOC/GS Freq.]* is operated twice, the frequency will be reset to the nominal localiser/glideslope frequency.

The default SDM is 40% for localiser and 80% for glideslope, and pressing *[LOC/GS Freq.]* will automatically reset the SDM to the default value.

When changing from localiser to glideslope the *[Ident/Comms]* key will disappear and then reappear when changing back to localiser.

Tone suppression

The 90 Hz or 150 Hz tone can be suppressed when either the SDM or DDM display box is selected for data entry, using the *[Suppress ON/OFF]* key. This will result in the non-dominant tone being suppressed without altering the SDM or DDM (% or index) as shown in Fig. B-7. Selecting *[Suppress 90/150]* will change the tone to be suppressed. The modulation depth value of the active tone is displayed under the SDM setting.

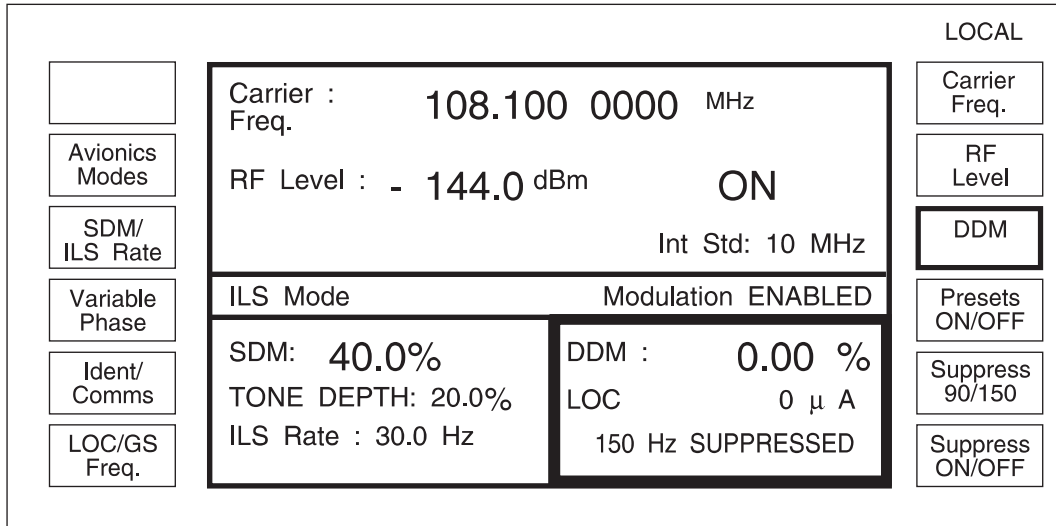

C2916

Fig. B-7 Tone suppression menu

Communication channel testing

ILS systems allow the provision of an emergency voice channel on localiser frequencies. This channel can be tested by selecting the *[Ident/Comms]* key to produce a display similar to the one shown in Fig. B-8.

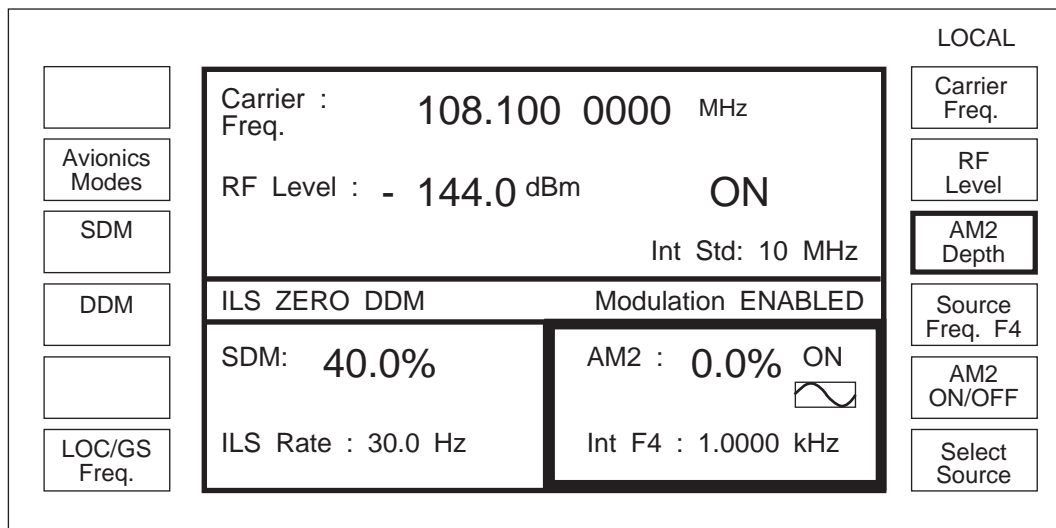

C1126

Fig. B-8 Ident/Comms selected

In this mode a fixed 0% DDM signal is provided and an additional modulation signal can be added using the *[AM2 Depth]* key. The source of this additional modulation can be set using the *[Select Source]* key. If internal modulation is selected the source frequency can be modified using the *[Source Freq.]* key. Selecting *[DDM]* will return the instrument to normal ILS mode.

Communication channel testing is normally only required on localiser frequencies and consequently changing from localiser to glideslope using the *[LOC/GS Freq.]* key will result in the *[Ident/Comms]* key disappearing. Additional modulation can be obtained on a glideslope frequency by directly entering the glideslope frequency instead using the numeric keys.

Tone phase variability

For normal ILS operation the phase setting between the 90 Hz and 150 Hz tones is automatically set to 0°. The *[90/150 Phase]* key can be used to adjust the phase relationship of the two tones. Selecting the *[90/150 Phase]* key produces the display shown in Fig. B-9.

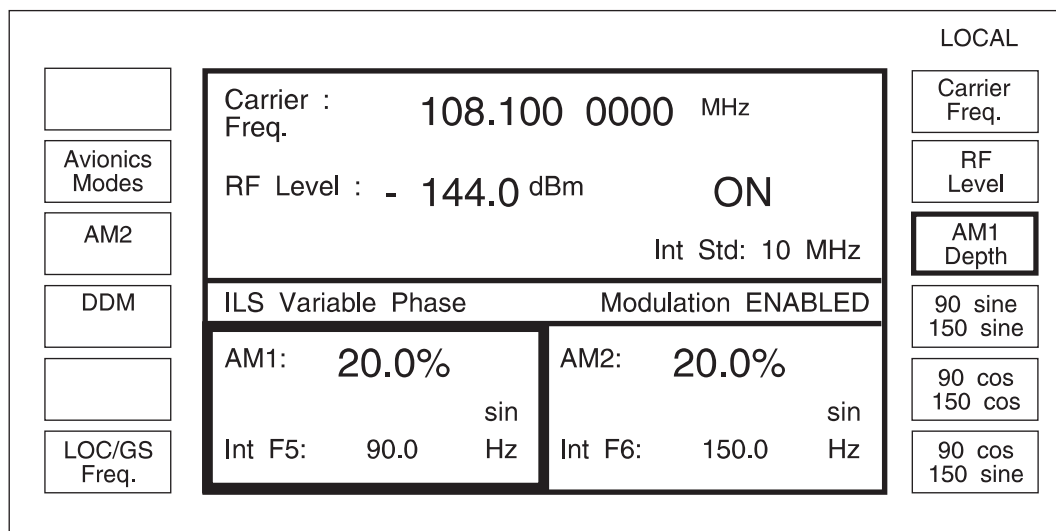

C2921

Fig. B-9 ILS variable phase sub-menu

Three phase relationships can be selected:

- 90 Hz sine/150 Hz sine
- 90 Hz cosine/150 Hz cosine
- 90 Hz sine/150 Hz cosine (\equiv 90 Hz cosine/150 Hz sine)

Selecting *[DDM]* will return the instrument to normal ILS mode.

Marker beacon mode

The marker beacon mode is selected using the *[MARKER BEACONS]* key on the *Avionics Mode Selection menu* shown in Fig. B-3. Selecting marker beacon mode and pressing the *[SIG GEN]* key produces the display shown in Fig. B-10. Initially the outer beacon is selected by default. The *[Middle Beacon]* and *[Inner Beacon]* keys change the modulation frequency to 1.3 kHz and 3 kHz respectively. Carrier frequency and AM depth can be altered, but always default to 75 MHz and 95% respectively. Modulation frequency can be changed using the *[Source Freq: F1]* key. Modulation source can be changed using the *[Select Source]* key. Pressing the *[Avionics Modes]* key returns the display to the *Avionics Mode Selection menu*.

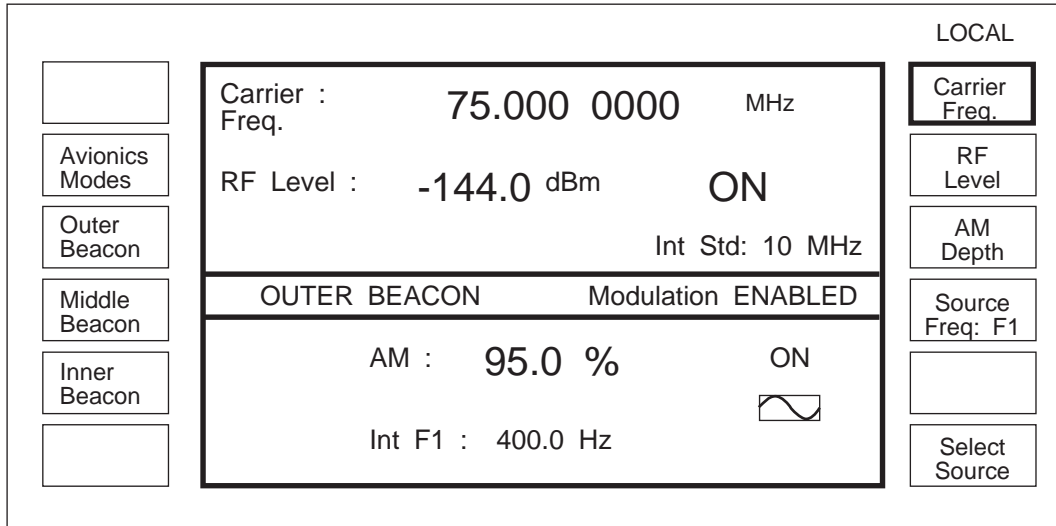

C1127

Fig. B-10 Marker beacon mode selection menu

VOR mode

VOR operation can be obtained from the *Avionics Mode Selection menu* (Fig. B-3) or if other avionics modes have been selected, by first pressing the *[Avionics Modes]* key. Selecting *[VOR Mode]* will produce the display shown in Fig. B-11. The default carrier frequency for the VOR mode is 108 MHz.

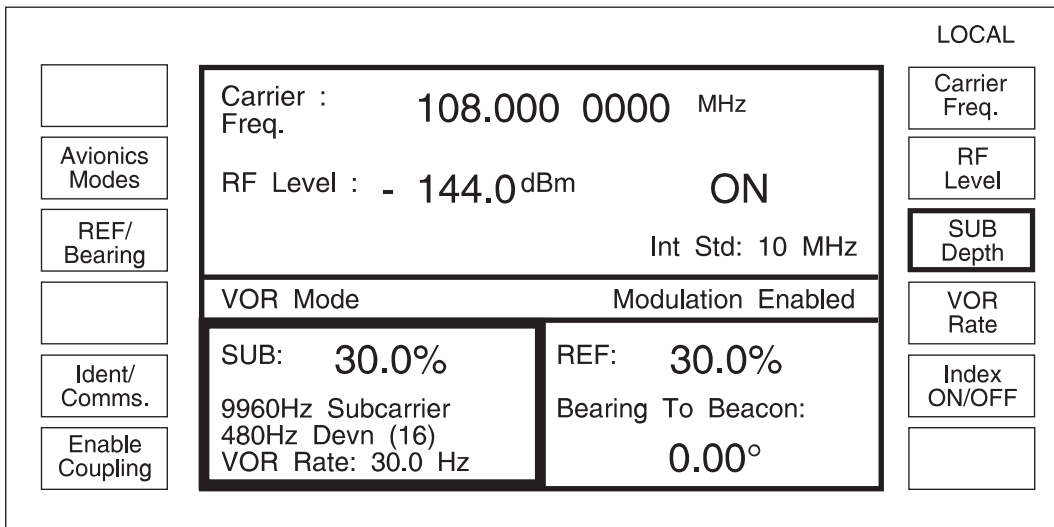

C2917

Fig. B-11 VOR mode operation

Sub-carrier peak deviation

For normal VOR operation the 30 Hz reference signal, which FM modulates the 9960 Hz sub-carrier, has a peak deviation of 480 Hz (Index=16). The *[Index ON/OFF]* key can be used to adjust the amount of peak deviation applied. Selection the *[Index ON/OFF]* key produces the display shown in Fig. B-12.

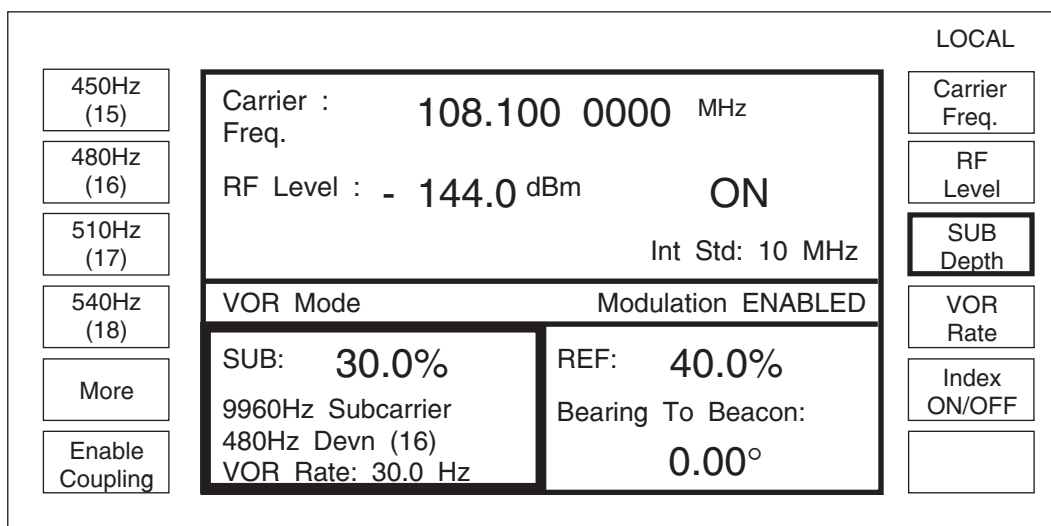

Fig. B-12 VOR mode operation with peak deviation selection (screen 1)

Four modulation index values (15-18) can be selected, with the current selection displayed under the SUB setting.

Press [More] to display a choice of a further four modulation index values (8-14) as shown in Fig. B-13. Press [More] again to return to the previous modulation index screen.

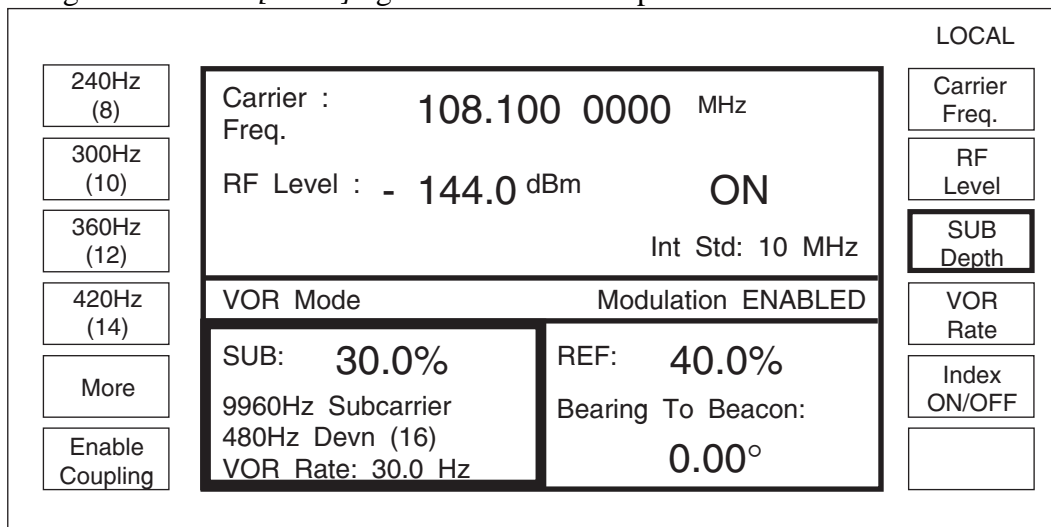

Fig. B-13 VOR mode operation with peak deviation selection (screen 2)

Normal VOR mode is returned by pressing the [Index ON/OFF] KEY.

Note...

The 9960 Hz sub-carrier and the peak deviation value will change in relation to the VOR rate setting.

Example: For a VOR rate of 25 Hz, the sub-carrier will be 8300 Hz and the peak deviation (for an index = 6) will be 400 Hz.

The display always reflects the sub-carrier and peak deviation settings for a VOR rate of 30 Hz.

Using the *[SUB Depth]* key the AM depth of the 9960 Hz sub-carrier can be entered in % and the *[VOR Rate]* key can be used to vary the VOR repetition rate from its normal setting of 30 Hz.

To vary the 30 Hz tone AM depth or the VOR bearing select the *[REF]* key to produce the display shown in Fig. B-14. The 30 Hz tone AM depth can be entered using the *[REF Depth]* key and bearing information can be entered in degrees using the *[Bearing]* key followed by the bearing data and the *[enter]* key. Conventions for bearing are not internationally consistent so a *[To/From]* key is provided to allow toggling between these two conventions. Operating this key does change the bearing but not the value displayed. It also provides a convenient way of providing a 180° bearing reversal.

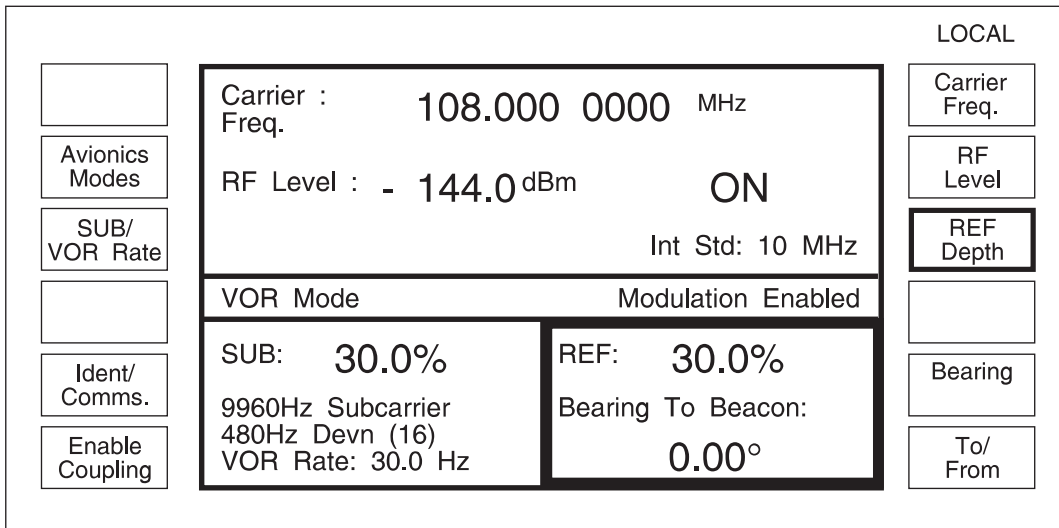

C2918

Fig. B-14 REF selected

The AM depth of the 9960 Hz sub-carrier and the 30 Hz tone can be varied simultaneously by pressing the *[Enable Coupling]* key which produces the display shown in Fig. B-15.

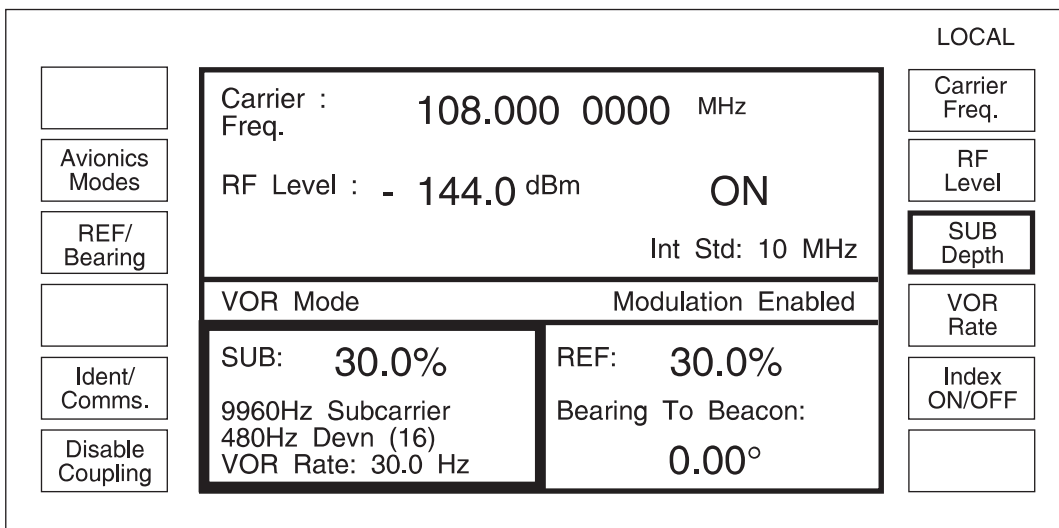

C2919

Fig. B-15 VOR made operation with "Coupling" enabled

When "coupling" is enabled, the 30 Hz AM depth is set to be equal to the 9960 Hz sub-carrier AM depth setting as the sub-carrier depth is varied. Similarly, the sub-carrier depth is set to the 30 Hz tone depth when the 30 Hz tone depth is varied. This mode of operation is disabled by pressing the *[Disable Coupling]* key.

Identity channel

VOR signals often carry a morse coded tone to identify the transmitter. This signal can be simulated by selecting the *[Ident/Comms]* key to produce a display similar to the one shown in Fig. B-16.

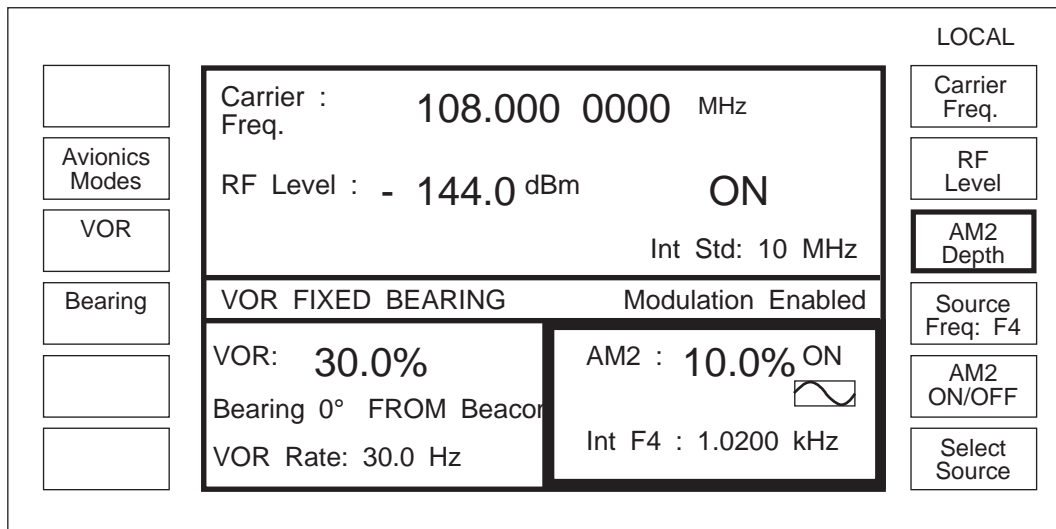

Fig. B-16 Ident/Comms selected

C1131

The instrument will generate a VOR signal having equal sub-carrier and 30 Hz tone depths with a 0° bearing. The AM depth displayed is the depth of each tone and can be changed using the *[VOR]* key.

An additional AM signal, AM2, can be added to this waveform. The source of this modulation can be selected using the *[Select Source]* key and if internal modulation has been selected the modulation frequency can be set using the *[Source Freq.]* key. The depth of this additional signal can be set by the *[AM2 Depth]* key.

ADF mode

The ADF mode is selected using the *[ADF]* key on the *Avionics Mode Selection menu* shown in Fig. B-3. This menu can be selected from other aviation modes (VOR, ILS, MARKER BEACON, SEL-CAL) using the *[Avionics Modes]* key. Selecting the ADF mode and pressing the *[SIG GEN]* key produces the display shown in Fig. B-17.

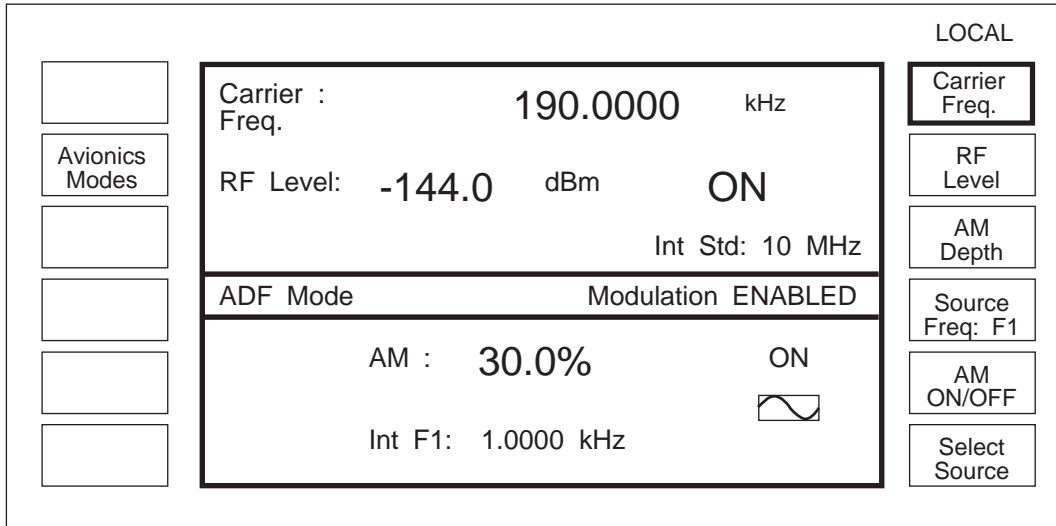

C1132

Fig. B-17 ADF mode selection menu

The carrier frequency will default to 190 kHz and the modulation depth to 30% from a 1 kHz source. This setting is used to simulate a long wave transmitter for direction finding purposes. The instrument operation is very similar to non-avionics modes with a single modulation selected (except that FM cannot be selected).

Pressing the [Avionics Modes] key returns the display to the Avionics Mode Selection menu shown in Fig. B-3.

SEL-CAL mode

The SEL-CAL mode can be used to test receivers using AM Selective Calling Tones to the selective calling format. The mode can be selected from the Avionics Mode Selection menu shown in in Fig B-3. Selecting [SEL-CAL] mode and pressing the [SIG GEN] key produces the display shown in Fig. B-18.

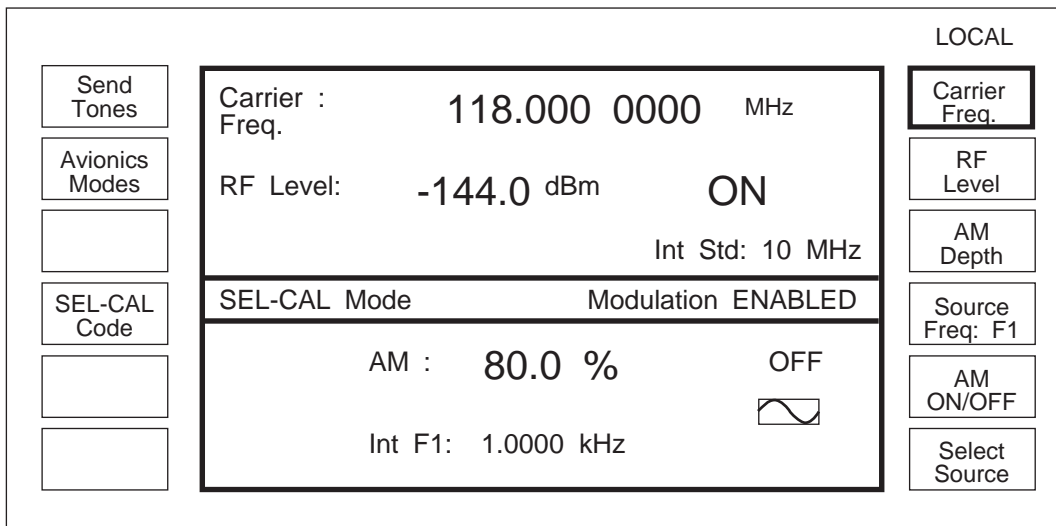

C1133

Fig. B-18 SEL-CAL mode selection menu

The instrument operation is similar to that in non-avionics modes with a single modulation selected (except that FM cannot be selected). Carrier frequency and AM depth can be altered, but always default to 118 MHz and 80% respectively.

The SEL-CAL tones can be sent by pressing the [Send Tones] key. While the tones are being sent *Modulation ENABLED* is replaced by the message ***** SENDING TONES ***** and the normal modulation tone is suppressed.

The SEL-CAL code can be modified by pressing the [SEL-CAL Code] key to produce a display similar to the one shown in Fig. B-19. Operation of this facility is identical to that of the *Sequential Calling Tones Utility* in non-avionics mode. The tone duration and gap can be set but the default values are those usually used for SEL-CAL. Alternative standards can be selected using the [Select Standard] key. The [Mode Control] key can be used to change the mode from single shot but the default setting is always single shot.

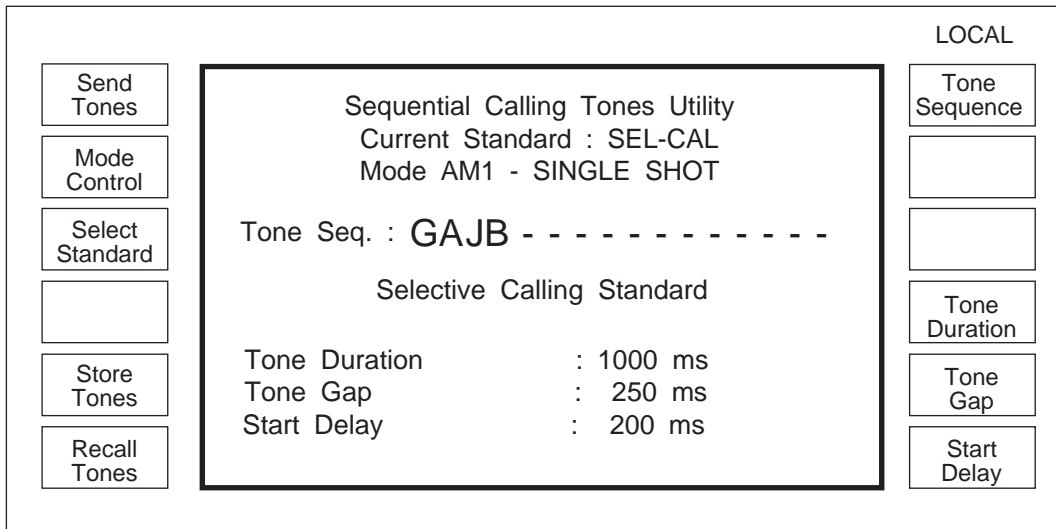

Fig. B-19 SEL-CAL tones utility

C0537

Tone sequences are entered using the [Tone Sequence] key to produce the display shown in Fig. B-20.

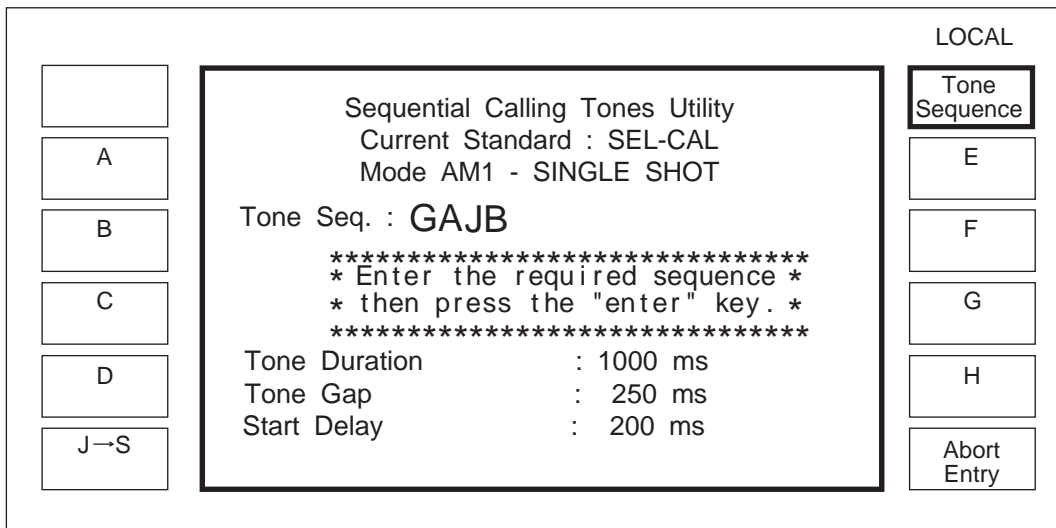

Fig. B-20 SEL-CAL tone entry

C0538

Characters A to H may be directly entered. To enter characters J to S first select the key [J→S]. An even number of characters is required to be entered up to a maximum of 4 (2 pairs). When the entry is complete terminate the code using the [enter] key. The display will return to that shown in Fig. B-19.

Note...

The SEL-CAL calling tones can also be selected from the *Sequential Calling Tones Utility* used for other calling tone standards. In this mode FM is also allowed.

Rotary control

The rotary control can be used to vary major parameters in all Avionics modes by pressing the [KNOB UP-DN] key. The sensitivity of the rotary control can be changed using the [↑] and [↓] keys.

GPIB OPERATION

MODE

Set avionics mode
(in addition to existing modulation mode commands)

Data type : Character Program Data (valid combinations of SDM, DDM, VOR, BEAR or AM2, see Table below)

Allowed suffices : None

Default suffix : None

Examples: MODE SDM,DDM (select ILS mode with DDM)
MODE SDM,AM2 (select ILS mode with AM2)
MODE SDM (select ILS variable phase mode)

VALID MODE COMBINATION TABLE

ILS	VOR
SDM, DDM	VOR, BEAR
SDM, AM2	VOR, AM2

NOTE...

Order is not important, for example SDM,DDM is equivalent to DDM,SDM.

MODE?

Prepares message containing information on Modulation Mode in the following format:

:MODE<mode>

where: <mode> is character program data indicating the modulation mode settings.

Examples: :MODE VOR, BEAR
:MODE SDM, DDM
:MODE SDM

ILS (Instrument Landing System) mode

SDM		Set Sum of Depth of Modulation (short form)
	:DEPTH	Set SDM Depth
	:INC	Set SDM step size
	Data type :	Decimal Numeric Program Data
	Allowed suffices :	PCT
	Default suffix :	PCT
	:UP	Go UP one step
	:DN	Go DOWN one step
	:RETN	Return to original setting
	:XFER	Transfer current value to be the new setting
	Data type :	None
	Allowed suffices :	None
	Default suffix :	None
	Example:	SDM:DEPTH 40PCT;INC 2;UP;UP;UP
	:PHASE	Specify the phase relationship between the 90 Hz and 150 Hz tones.
	Data type :	Character Program Data (any one of SIN_SIN, COS_COS or SIN_COS).
	Allowed suffices :	None
	Default suffix :	None
	Example:	SDM:PHASE SIN_COS
SDM?		Prepares messages containing information on SDM in the following format: :SDM:DEPTH <nr2>;INC <nr2>
	Example:	:SDM:DEPTH 40.0;INC 0.5
SDM:PHASE?		Prepares messages containing information on the phase relationship between the 90 Hz and 150 Hz tones in the format: :SDM:PHASE <char>
	Example:	:SDM:PHASE SIN_COS
DDM90		Set Difference in Depth of Modulation with 90 Hz tone predominant (short form)
	:DEPTH	Set DDM90 Depth
DDM150		Set Difference in Depth of Modulation with 150 Hz tone predominant (short form)
	:DEPTH	Set DDM150 Depth
DDM90 or DDM150		
	:INC	
	Data type :	Decimal Numeric Program Data
	Allowed suffices :	PCT
	Default suffix :	None
	Note...	
		When there is no suffix it is assumed that the entry is in DDM index (%/100).

:UP Go UP one step
:DN Go DOWN one step
:RETN Return to original setting
:XFER Transfer current value to be the new setting

Data type : None
 Allowed suffices : None
 Default suffix : None

Examples: DDM90:DEPTH 40PCT;INC 0.1;DN;DN
 DDM150:DEPTH 0.1554;INC 0.0002;UP;UP;UP

DDM? Prepares messages containing information on DDM in the following format:

:<ddm>:DEPTH <nr2>;INC <nr2>

where <ddm> is a program mnemonic indicating the predominant tone (DDM90 or DDM150).

Examples: :DDM90:DEPTH 0.2000;INC 0.01
 :DDM150:DEPTH 0.4000;INC 0.01

SUPPRESS [not used alone]
:TONE90 Suppress the 90 Hz tone
:TONE150 Suppress the 150 Hz tone
:NONE Remove tone suppression

Data type : None
 Allowed suffices : None
 Default suffix : None

Examples: :SUPPRESS;TONE150
 :SUPPRESS:NONE

SUPPRESS? Prepares messages containing information on tone suppression control in the following format:

:SUPPRESS:<status>

where: <status> is a program mnemonic indicating the tone suppression state.

ILSF Set ILS Frequency (short form)
:VALUE Set ILS Frequency
:INC

Data type : Decimal Numeric Program Data
 Allowed suffices : **GHz, MHz, KHz, Hz**
 Default suffix : **Hz**

:UP Go UP one step
:DN Go DOWN one step
:RETN Return to original setting
:XFER Transfer current value to be the new setting

Data type : None
 Allowed suffices : None
 Default suffix : None

Example: ILSF:VALUE 30 Hz;INC 0.1;DN;DN;DN

ILSF?

Prepares messages containing information on ILS Frequency in the following format:

:ILSF:VALUE <nr2>;INC <nr2>

Example: :ILSF:VALUE 30.0;INC 0.5

Marker beacon mode

There are no additional commands for marker beacon testing, the required setting is obtained by using the appropriate standard commands.

Example for setting up and sending 400 Hz outer marker beacon:

```
Example: :CFRQ 75 MHZ;RFLV:VALUE 0 DBM;ON;:AM1:DEPTH  
95 PCT;INTF1;ON;:INTF1 400 HZ;:MOD:ON;:MODE AM
```

Example for setting up and sending 1300 Hz middle marker beacon:

```
Example: :CFRQ 75 MHZ;RFLV:VALUE 0 DBM;ON;:AM1:DEPTH  
95 PCT;INTF1;ON;:INTF1 1300 HZ;:MOD:ON;:MODE AM
```

Example for setting up and sending 3000 Hz inner marker beacon:

```
Example: :CFRQ 75 MHZ;RFLV:VALUE 0 DBM;ON;:AM1:DEPTH  
95 PCT;INTF1;ON;:INTF1 3000 HZ;:MOD:ON;:MODE AM
```

VOR (VHF Omnidirectional Radio Range) mode

VOR or SUB		Set SUB Subcarrier Signal (9960 Hz) Depth (short form)
	:DEPTH	Set SUB Depth
	:INC	Set SUB step size
	Data type :	Decimal Numeric Program Data
	Allowed suffices :	PCT
	Default suffix :	PCT
	:UP	Go UP one step
	:DN	Go DOWN one step
	:RETN	Return to original setting
	:XFER	Transfer current value to be the new setting
	:ENABLE	Enable Subcarrier and variable signal depth coupling
	:DISABLE	Disable Subcarrier and variable signal depth coupling
	Data type :	None
	Allowed suffices :	None
	Default suffix :	None
	Example:	SUB:DEPTH 30PCT;INC 2;UP;UP;UP
	:DEVN	Specify Subcarrier deviation
	Data type :	Character Program Data (any one of Hz_240, Hz_300, Hz_360, Hz_420, Hz_450, Hz_480, Hz_510 or Hz_540)
	Allowed suffices :	None
	Default suffix :	None
	Example:	:VOR:DEVN HZ_450
VOR? or SUB?		Prepares messages containing information on SUB in the following format:
		:SUB:DEPTH<nr2>;INC<nr2>
	Example:	:SUB:DEPTH 30.0;INC 0.5;DISABLE
VOR:DEVN?		Prepares messages containing information on VOR Subcarrier deviation selection in the format:
		:VOR:DEVN<char>
	Example:	:VOR:DEVN HZ_480
REF		Set REF Variable Signal (30 Hz) Depth (short form)
	:DEPTH	Set REF Depth
	:INC	Set REF Step Size
	Data type :	Decimal Numeric Program Data
	Allowed suffices :	PCT
	Default suffix :	PCT
	:UP	Go UP one step
	:DN	Go DOWN one step
	:RETN	Return to original setting
	:XFER	Transfer current value to be the new setting
	Data type :	None
	Allowed suffices :	None
	Default suffix :	None
	Example:	REF:DEPTH 30PCT;INC 2;DN;DN;DN

REF? Prepares messages containing information on REF in the following format:

:REF:DEPTH <nr2>;INC <nr2>

Example : :REF:DEPTH 30.0;INC 0.5

BEARTO Set VOR Bearing To Beacon (short form)

:VALUE Set VOR Bearing To Beacon

BEARFR Set VOR Bearing From Beacon (short form)

:VALUE Set VOR Bearing From Beacon

BEARTO or BEARFR

:INC

Data type: Decimal Numeric Program Data
 Allowed suffices : **DEG**
 Default suffix : **DEG**

:UP Go UP one step
 :DN Go DOWN one step
 :RETN Return to original setting
 :XFER Transfer current value to be the new setting

Data type : None
 Allowed suffices : None
 Default suffix : None

Examples: BEARTO:VALUE 90DEG;INC 0.1;UP;UP;UP
 BEARFR:VALUE 270DEG;INC 0.1;DN;DN;DN

BEAR? Prepares messages containing information on VOR BEARING in the following format:

:<bear>:VALUE <nr2>;INC <nr2>

where <bear> is a program mnemonic indicating the Bearing convention (BEARTO or BEARFR).

Examples: :BEARFR:VALUE 60.0;INC 0.5
 :BEARTO:VALUE 300.0;INC 0.5

VORF Set VOR Frequency (short form)

:VALUE Set VOR Frequency

:INC

Data type: Decimal Numeric Program Data
 Allowed suffices : **GHz, MHz, KHz, Hz**
 Default suffix : **Hz**

:UP Go UP one step
 :DN Go DOWN one step
 :RETN Return to original setting
 :XFER Transfer current value to be the new setting

Data type : None
 Allowed suffices : None
 Default suffix : None

Example: VORF:VALUE 30Hz;INC 0.1;DN;DN;DN

VORF?

Prepares messages containing information on VOR Frequency in the following format:

:VORF:VALUE <nr2>;INC <nr2>

Example : :VORF:VALUE 30.0;INC 0.5

ADF (Automatic Direction Finder) mode

There are no additional commands for ADF testing, the required setting is obtained by using the appropriate standard commands.

Example: :CFRQ 190 KHZ;RFLV:VALUE +10 DBM;ON;:AM1:
DEPTH 30 PCT;INTF1;ON;:INTF1 1 KHZ;:MOD:ON;:MODE AM

Sel-cal mode

SEL-CAL adds the following to the Sequential Calling Tones. SEL-CAL is an additional valid type. The data string representing the Tone Sequence is an even number of characters selected from the set {ABCDEFGHIJKLMQRS}.

Example for setting operating conditions:

Example: :CFRQ 118 MHZ;RFLV:VALUE 0 DBM;ON;:AM1:DEPTH
80 PCT;INTF1;OFF;:INTF1 1 KHZ;:MOD:ON;:MODE AM

Example for setting up SEL-CAL and sending tones:

Example: :SEQT:MODE:STD SELCAL;MOD AM1;:SEQT:SEQ
"GABD";SEND 1

ACCEPTANCE TESTING

Introduction

The test procedures in this section enable you to verify that the electrical performance of the avionics signal generator complies with the Performance Data given earlier. The test equipment recommended for this purpose is listed in Table B-1. All tests may be performed with the covers in place and are intended to be carried out in the order given. For convenience, the test equipment and specification for each test are summarized before the test procedure. These tests are in addition to those for non-avionics versions of the instrument.

These acceptance tests give a high degree of confidence that the instrument meets its specification, without the use of specialised test equipment.

The avionics option uses a method of Direct Digital Synthesis (DDS) to generate the required avionics waveforms. The accuracy of the generated waveform is therefore determined by stored digital data and the AM performance of the signal generator. These tests check the waveform generation and analogue and RF signal paths in the signal generator. Additional tests can be undertaken using specialised ILS and VOR receivers if they are available.

Test equipment

The test equipment recommended for acceptance testing is shown in Table B-1. Alternative equipment may be used provided it complies with the stated minimum specification.

Table B-1 Recommended test equipment

TEST EQUIPMENT		
Description	Minimum specification	Example
Spectrum analyzer	DC to 400 MHz Level accuracy ± 1 dB	IFR 2382
Modulation meter	500 kHz to 1 GHz AM accuracy $\pm 1\%$ of reading Selectable ILS filter	IFR 2305
Oscilloscope	100 MHz bandwidth	Tektronix 2235

Functional testing of ILS waveform generation

TEST EQUIPMENT		
Description	Minimum specification	Example
Spectrum analyzer	100 Hz to 400 MHz	IFR 2382
Oscilloscope	100 MHz bandwidth	Tektronix 2235

IFR uses a method of Direct Digital Synthesis (DDS) to generate the ILS waveforms. One DDS generated waveform contains both the 90 Hz tone and the 150 Hz tone with 0% DDM (Difference Depth of Modulation).

A second waveform is generated with 0% DDM but with the relative phase of the 150 Hz tone reversed compared to that of the 90 Hz tone.

When small levels of the second waveform are added to the first, the resultant waveform has a constant SDM and adding a proportion of the second waveform will result in the DDM of the resultant signal changing.

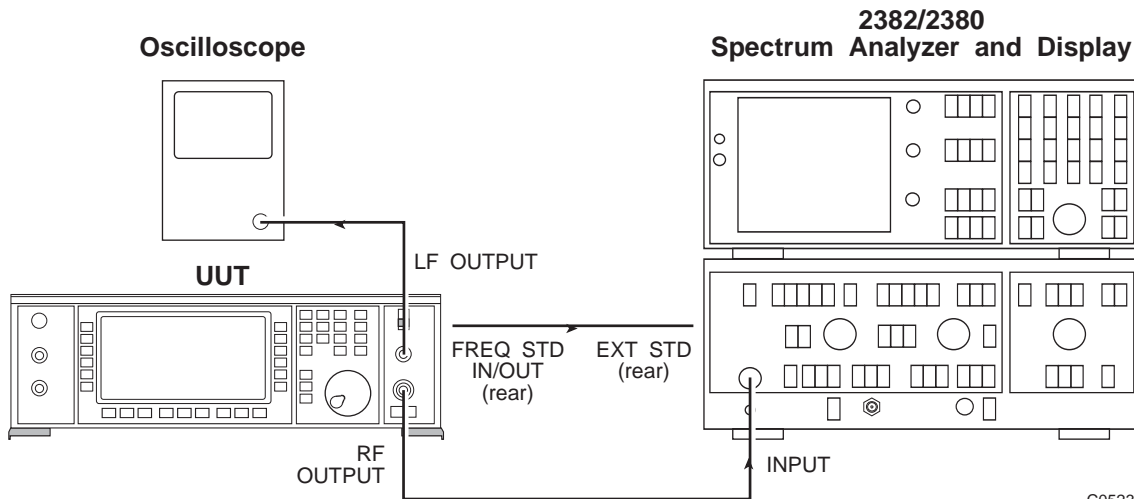

Fig. B-21 ILS functional test set-up

- (1) Connect the test equipment as shown in Fig. B-21.
- (2) Set up the test equipment as follows:

Unit under test

ILS mode	
Carrier freq	108.1 MHz
RF level	7 dBm
SDM	40 %
ILS rate	30 Hz
DDM	0 %
90 Hz dominant	Fly RT

Oscilloscope

Volts/div	0.2 V
Time base	5 ms/div

Spectrum analyzer

Preset and calibrate
 Reference frequency 108.1 MHz
 Reference level 10 dBm
 Span/div 50 Hz
 Resolution bandwidth 10 Hz

- (3) The typical traces on the oscilloscope and the spectrum analyzer are shown in Figs. B-22 and B-23. These traces are for the 90 Hz and the 150 Hz tones' having equal amplitudes (i.e. 0% DDM).

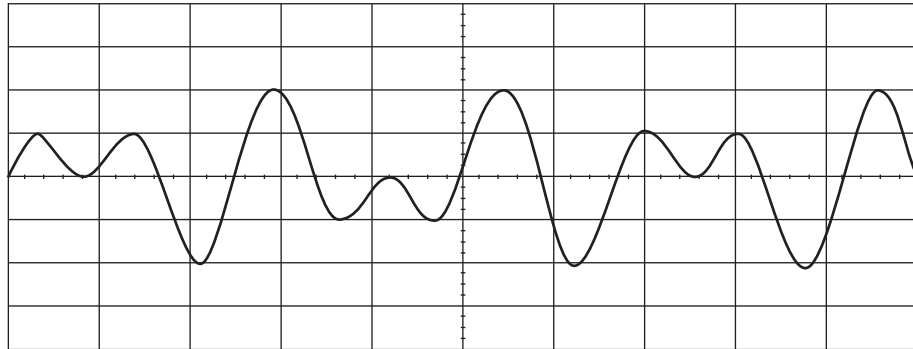

Ch. 1 = 200.0 mVolts/div
 Timebase = 5.00 ms/div

C0526

Fig. B-22 Oscilloscope trace for a 0% DDM waveform.

- (4) On the UUT reduce the SDM depth using the rotary control. This will cause a reduction in the amplitude of the oscilloscope trace and the sidebands on the spectrum analyzer trace. Reset the SDM to 40%.

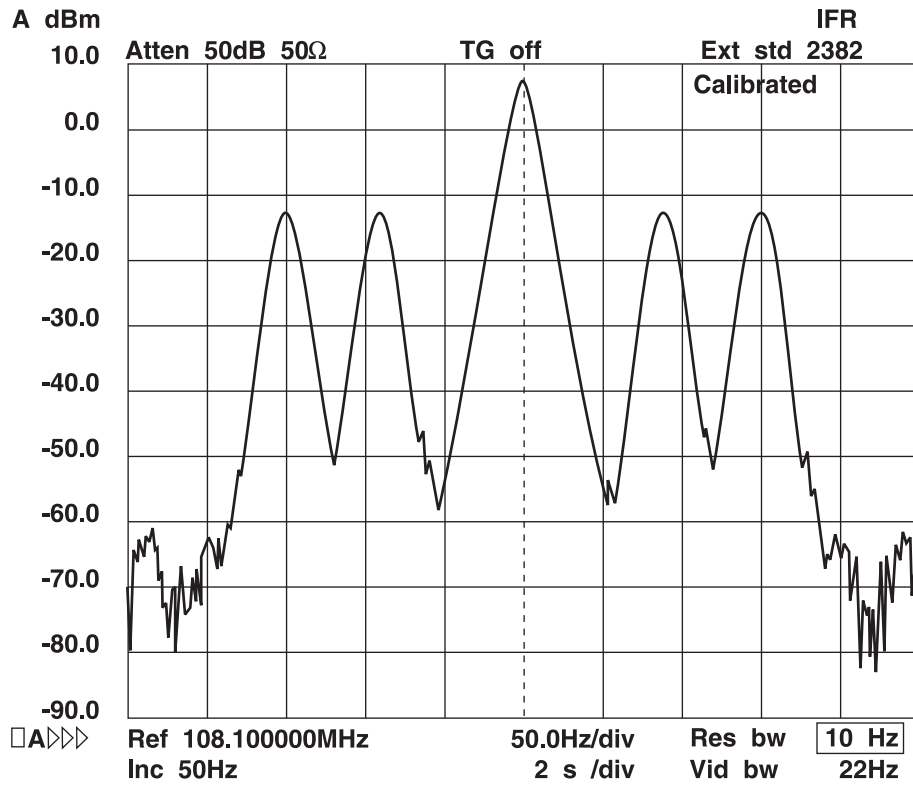

C4213

Fig. B-23 Spectrum analyzer trace for a 0% DDM waveform.

- (5) On the UUT select DDM. Increase the DDM from 0% to 40% using the knob control. As the change occurs, the 90 Hz sideband should increase and the 150 Hz sideband should decrease. For a signal with a DDM of 40% the 150 Hz sideband will be suppressed as shown in Figs. B-24 (the trace is 2 ms/div) and B-25.

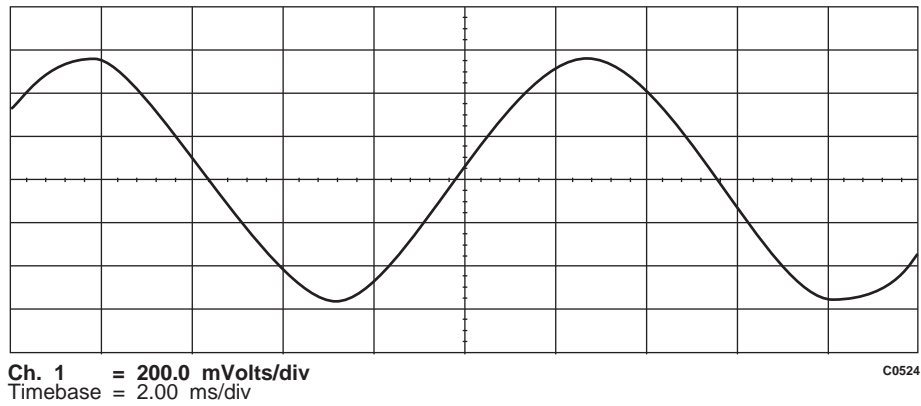

Fig. B-24 Oscilloscope trace for a 40% DDM waveform.

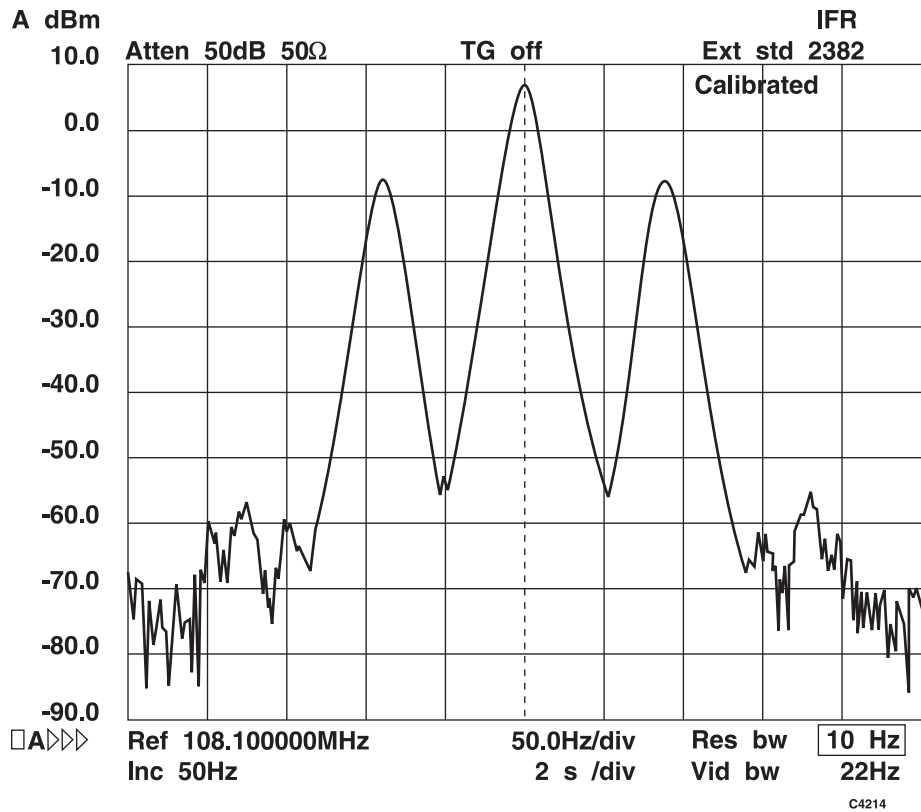
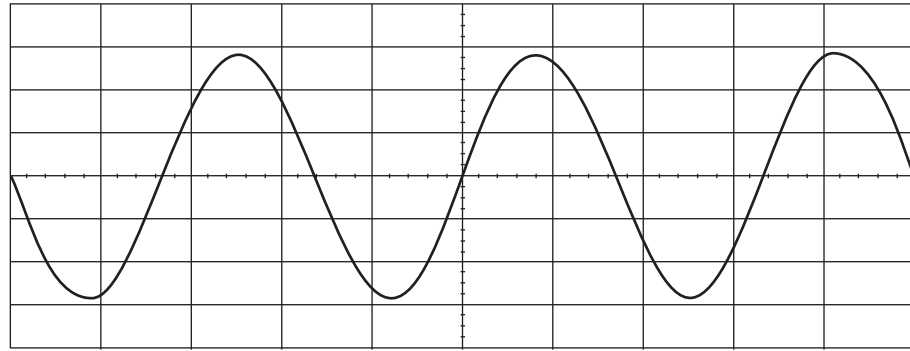

Fig. B-25 Spectrum analyzer trace for a 40% DDM waveform.



Ch. 1 = 200.0 mVolts/div
Timebase = 2.00 ms/div

C0525

Fig. B-26 Oscilloscope trace for a 150 Hz dominant waveform.

- (6) On the UUT select the 150 Hz tone to be dominant. The 90 Hz sideband should be suppressed and the 150 Hz sideband should be present as shown in Figs. B-26 (the trace is 2 ms/div) and B-27.

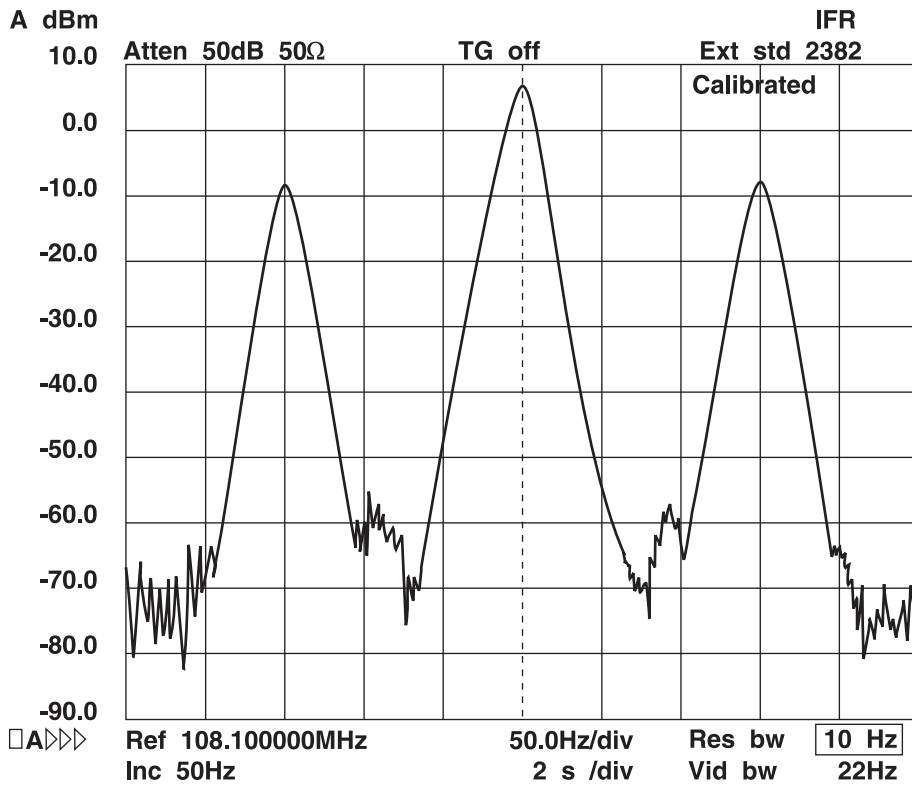

C4215

Fig. B-27 Spectrum analyzer trace for a 150 Hz dominant waveform.

Accuracy of SDM (Sum Depth of Modulation) signal path

SPECIFICATION
$\pm 2\%$ of setting for carrier frequencies up to 400 MHz

The signal generator has a 1 dB AM bandwidth from DC to at least 30 kHz and consequently the difference in AM response between 90 Hz and 150 Hz will be small and can be neglected. Because of this, it is possible to test the SDM and the DDM accuracy of the instrument by the use of a single tone modulation at 124 Hz rate (the geometric mean of 90 Hz and 150 Hz).

The 0% DDM signal is generated using the AM 1 channel. The phase shifted signal is generated on the AM 2 channel. The design of the instrument ensures that the AM accuracy of each channel at a fixed frequency is equal to the accuracy of the ILS waveform generated by the instrument.

TEST EQUIPMENT		
Description	Minimum specification	Recommended
Modulation meter*	50 kHz to 1 GHz AM accuracy $\pm 0.5\%$ of reading at 40% depth $\pm 0.7\%$ of reading at 80% depth Selectable ILS filter	IFR 2305

*The SDM and DDM accuracy of the Avionics Option can not be verified with a modulation meter calibrated to its published performance specification. A specially calibrated modulation meter is necessary. If more than an approximate verification is required, consult your local agent or the Service Division for further details.



Fig. B-28 Accuracy of SDM signal path test set-up

- (1) Connect the test equipment as shown in Fig. B-28.
- (2) Set up the test equipment as follows:

Unit under test

```

[UTIL] [Mod'n Mode] [Composite]
[SIG GEN]
Carrier freq           108.1 MHz
RF level               7 dBm

[AM]
AM 1 depth            40 %
[Select Source] [Internal F1] 120 Hz sinewave
[SIG GEN]
AM 1                  Off
    
```

AM 2 depth 0 %
 [Select Source] [Select Internal] [Internal F2] 124 Hz sinewave
 [SIG GEN]
 AM 2 Off

Modulation meter

tune Autotune
 Function AM
 Second function 28 On (see note)

Note...

In order to select second function 28 it is first necessary to unlock the 2305 to its 1st level of protection (this is detailed in the operating manual).

Second function 28 selects an ILS filter. This is a 15 kHz low-pass filter selected separately from, and without any accompanying high-pass section. This provides sufficient high frequency bandwidth for the AM ILS signal without admitting an excessive amount of noise. In the left-hand window a 1 selects the filter and a 0 deselected it.

- (3) With AM channels 1 and 2 turned off, allow the modulation meter reading to settle, then measure the residual AM noise and note the reading.

Residual AM noise depth _____%

- (4) On the UUT turn the AM 1 channel on. Allow the reading on the modulation meter to settle and note it. (This is equivalent to an SDM of 40 %.)

Measured AM depth _____%

Actual AM depth = Measured AM depth - Residual AM noise

Set AM	Minimum	Actual	Maximum
40%	39.2%	_____%	40.8%

- (5) Repeat (4) for an AM 1 depth of 80% (this is equivalent to an SDM of 80%) with the carrier frequency set to 330 MHz.

Set AM	Minimum	Actual	Maximum
80%	78.4%	_____%	81.6%

Accuracy of DDM (Difference Depth of Modulation) waveform

SPECIFICATION
±0.03% of depth ±0.02 of setting

This specification is checked by measuring the modulation channel balance at 19.9% and 40% SDM (with and without final divide-by-5 internal attenuator).

TEST EQUIPMENT		
Description	Minimum specification	Example
Spectrum analyzer or FFT analyzer	DC to 25 kHz 3 Hz filter	IFR 2382

- (1) Connect the test equipment as shown in Fig. B-29.

- (2) Set up the test equipment as follows:

Unit under test

ILS mode

Carrier freq	108.1 MHz
LF output	Monitor AM drive
SDM	40%
DDM	0%
Dominant tone	90 Hz

Spectrum analyzer

Span/div	20 Hz
Frequency	0 to 200 Hz
Ref level	20 dBm
Resolution bandwidth	3 Hz
Input	DC coupled

The spectrum analyzer should display equal amplitude tones of 90 Hz and 150 Hz.

- (3) Reset the test equipment as follows:

Unit under test

DDM	40%
-----	-----

The 150 Hz tone should now be suppressed. Check that the residual level is at least 52 dB lower than the 90 Hz tone.

- (4) Reset the test equipment as follows:

Unit under test

SDM	19.9%
DDM	19.9%

The 150 Hz tone should still be suppressed. Check that the residual level is at least 52 dB lower than the 90 Hz tone.

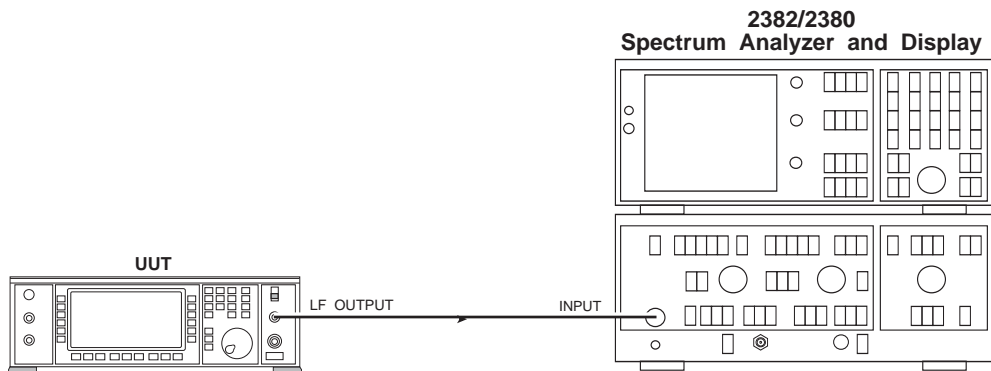

C0552

Fig. B-29 Equipment configuration for DDM waveform accuracy

VOR waveform depth accuracy

SPECIFICATION
$\pm 3\%$ of setting $\pm 0.5\%$ for carrier frequencies up to 400 MHz

TEST EQUIPMENT		
Description	Minimum specification	Example
Modulation meter	Freq range to 400 MHz AM accuracy $\pm 1\%$ of reading Selectable ILS filter	IFR 2305

(1) Connect the test equipment as shown in Fig. B-28.

(2) Set up the test equipment as follows:

Unit under test

VOR mode

Carrier freq 108 MHz

RF level 7 dBm

SUB depth 0 %

REF depth 0 %

Modulation meter

Freq tune 108 MHz

Function AM

Second function 28 On

(3) With SUB and REF set to 0% measure the residual AM noise. Note the reading.

Residual AM noise depth _____ %

(4) On the UUT select a SUB depth of 30% and a REF depth of 0%. Allow the reading on the modulation meter to settle and note it.

Measured AM depth _____ %

Actual SDM = Measured AM depth - Residual AM noise

Minimum	Actual	Maximum
28.60%	_____ %	31.40%

Ensure that the measured depth is in specification.

(5) Repeat (4) for a SUB depth of 0% and a REF depth of 30%.

Minimum	Actual	Maximum
28.60%	_____ %	31.40%

(6) Repeat (4) for a SUB depth of 30% and a REF depth of 30%.

Minimum	Actual	Maximum
57.70	_____ %	62.30%

Waveform phase control

This test is a functional test of the phase control system used on the DDS sources. The two sources are set to the same frequency and their outputs are summed together. As the relative phase of the source is changed the resulting signal amplitude will change.

TEST EQUIPMENT		
Description	Minimum specification	Example
Oscilloscope	100 MHz bandwidth	Textronix 2235

- (1) Connect the test equipment as shown in Fig. B-31.

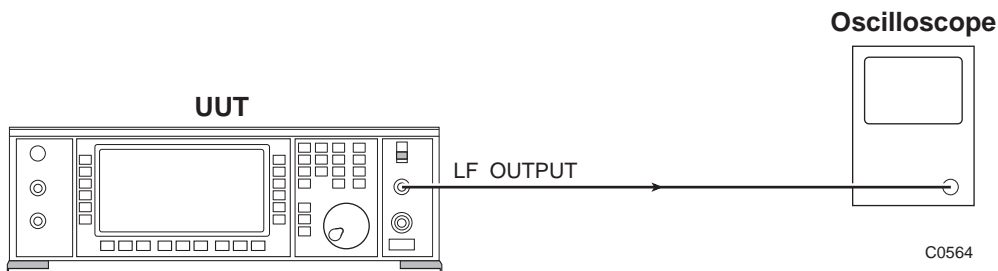

Fig. B-31 Waveform phase control test set-up

- (2) Set up the test equipment as follows:

Unit under test

[UTIL] [Mod'n Mode] [Composite]
[SIG GEN]

LF output	Modulation monitor
Modulation drive	
AM1	30% ON
AM2	30 % ON
INT F1	30 Hz
INT F2	30 Hz

Set AM1 source to INT F1
Set AM2 source to INT F2

Oscilloscope

Set to monitor LF OUTPUT waveform .

- (3) On the UUT select the *Internal Source Selection menu* and press the [Mod. Src Phase] key. Enter a phase of 0° (to beacon).
Check that the LF OUTPUT is approximately 1.69 V pk-pk.
- (4) Enter a phase of 180°. Check that the output tone is substantially suppressed to a level less than 80 mV pk-pk.
- (5) Enter a phase of 90° and check that the output tone is approximately 1.2 V pk-pk.
- (6) Enter a phase of 270° and check that the output tone has the same amplitude as in (5) above.

Annex C

OPTION 008 RF PROFILES AND COMPLEX SWEEP

CONTENTS

	PAGE
PERFORMANCE DATA	C-2
PERFORMANCE DATA	C-2
INTRODUCTION TO OPTION 008	C-4
RF OFFSET AND PROFILES	C-4
Access to RF offset and profile.....	C-4
RF OFFSET	C-6
RF PROFILES	C-7
Creating a profile	C-8
Enabling a profile.....	C-9
Tutorial examples for RF offset and profiles.....	C-10
SEQUENCE SWEEP.....	C-12
Selecting a sequence sweep	C-13
Modifying segments.....	C-14
Entering a sweep sequence	C-14
Sweep mode	C-14
Starting to sweep.....	C-15
Tutorial examples for sequence sweep	C-16
COMPLEX SWEEPS	C-17
RF profiles, offset and sequence sweep.....	C-17
Suppressing attenuator changes	C-17
Tutorial example for immunity testing	C-17
SQUARE WAVE MODULATION.....	C-18
GPIB OPERATION.....	C-19
Segmented sweeps	C-19
RF profiles	C-21
RF offsets	C-23

LIST OF FIGURES

Fig. C-1 Utilities selection menu 2	C-5
Fig. C-2 RF level utility menu	C-5
Fig. C-3 RF offset selection (shown unlocked to Level 1).....	C-6
Fig. C-4 Main signal generator screen with RF offset enabled	C-7
Fig. C-5 RF profile menu (shown unlocked to Level 1).....	C-7
Fig. C-6 RF profile editor menu	C-8
Fig. C-7 Main signal generator screen with RF offset and profiles enabled	C-10
Fig. C-8 Two signal generator testing with a resistive combiner	C-10
Fig. C-9 Using a signal generator with an external amplifier.....	C-11
Fig. C-10 Example for a segmented sweep	C-12
Fig. C-11 Sweep type menu.....	C-13
Fig. C-12 Sweep sequence selection menu.....	C-13
Fig. C-13 Sweep segment editor.....	C-14
Fig. C-14 Sweep menu display with the sweep halted	C-15

PERFORMANCE DATA

General description

Option 008 software provides additional sweep, RF offset and RF level profiling facilities to support the use of 2030 series Signal Generators with external amplifiers and attenuators. The RF output from the external device can be calibrated and displayed on the front panel of the signal generator using the RF offset and RF profile facilities.

The following specification is in addition to the specification for the 2030 series Signal Generators.

RF OFFSETS

The displayed signal generator output level can be offset by +80 dB to -40 dB (in 0.1 dB steps) from the actual RF output level. Up to 5 offsets values may be defined and selected in turn.

RF offsets can be enabled and disabled and their value and status stored in non-volatile memory. RF offsets may be used in normal signal generator modes or combined with the segmented sweep facility.

RF PROFILE

The actual RF output level can be adjusted by ± 40 dB from its nominal value without changing the displayed level. Up to 10 profiles may be defined and selected in turn. RF profiles can be enabled and disabled and all RF profile information can be stored in non-volatile memory.

Profile values can be entered at up to 100 carrier frequencies.

The RF output level is linearly interpolated between profile points.

RF profiles may be used in normal signal generator modes or combined with the segmented sweep facility to produce complex sweeps.

SEGMENTED SWEEP

Carrier frequency sweeps can be generated which contain defined segments each of which can have a different step size, start and stop frequency, step time and RF level.

Start and stop

Start and stop frequency for each segment can be freely defined within the frequency capability of the signal generator.

Step size

Minimum step size is 0.1 Hz.

Maximum step size is determined by the frequency capability of the signal generator.

Number of steps for a particular segment is implied by the step size and the start and stop frequencies.

Step time	20 ms to 20 s per step.
RF level	The RF level for each segment can be freely defined within the output level capability of the signal generator.
Segments	Up to 10 segments may be defined and freely combined in any order to produce a segmented sweep. Segmented sweeps can be stored in non-volatile memory by using the sweep stores (0 to 19).

MODULATION WAVEFORMS

Sine, triangle or square wave modulation is available to provide amplitude, phase or frequency modulation.

INTRODUCTION TO OPTION 008

This section describes how to use the additional software features provided when Option 008 RF profile and complex sweep is fitted to a 2030 series Signal Generator. Familiarity with normal operation of the signal generator is assumed.

Option 008 provides two principle facilities. The RF offset facility enables the user to effectively display the RF output level when the signal generator is connected to an external device, such as an attenuator or an amplifier. If the external device gain or loss is frequency dependent then the signal generator can substantially eliminate the frequency dependence using RF profiles.

The segmented sweep facility allows for the generation of sweeps where the sweep is split into segments which can have independent start, stop, step size, step time and RF levels. The complex sweeps are generated using the segmented sweep mode and can be used in combination with the RF profile and RF offset facility. This is particularly useful for electromagnetic immunity and Tempest testing.

Complex sweeps can be generated by combining the RF offset, RF profile and segmented sweep facilities.

RF OFFSET AND PROFILES

These facilities provide the capability for setting the signal generator to display the RF power at the output of a device connected to the signal generator. The RF offset facility is used to compensate for the nominal gain (or loss) of the external device. Adding an offset value does not change the RF output level of the signal generator but does change the displayed RF output level. If, for example, the signal generator is connected to a 20 dB amplifier the offset value can be set to +20 dB. If the signal generator output level is set to +20 dBm then +20 dBm is displayed but the actual signal generator output level will be 0 dBm.

The RF profile facility allows the output level to be corrected to allow for frequency dependent gain (or loss) errors. If, for example, the gain of the amplifier at 100 MHz is 20 dB, at 150 MHz it is 19 dB and at 200 MHz it is 19.5 dB the RF profile facility can introduce 0 dB, 1 dB and 0.5 dB level compensation at 100 MHz, 150 MHz and 200 MHz respectively to compensate for the frequency/gain errors. The RF level profile is linearly interpolated between these frequencies to minimise level errors at intermediate frequencies.

The profile values do not change the displayed RF level but do change the RF output level of the signal generator.

Access to RF offset and profile

The RF offsets and profiles are initially accessed via the *Utilities Selection Menu 2*. To obtain this menu, press [UTIL]. If the *Utilities Selection Menu 1* is displayed, press the [*Utils. Menu 2*] key. The required display is shown in Figure C-1.

Note...

If the utility facility has already been previously accessed it may be necessary to press the [UTIL] key a second time and then select [*Utils Menu 2*].

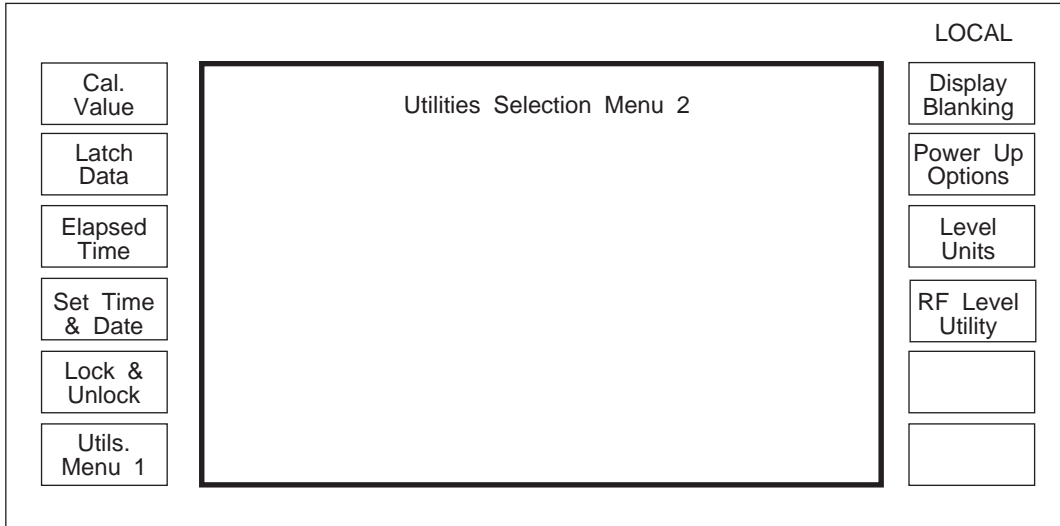

C0939

Fig. C-1 Utilities selection menu 2

Press [RF Level Utility] to obtain the display shown in Fig. C-2. The [Offsets] or [Profiles] key can now be selected as required.

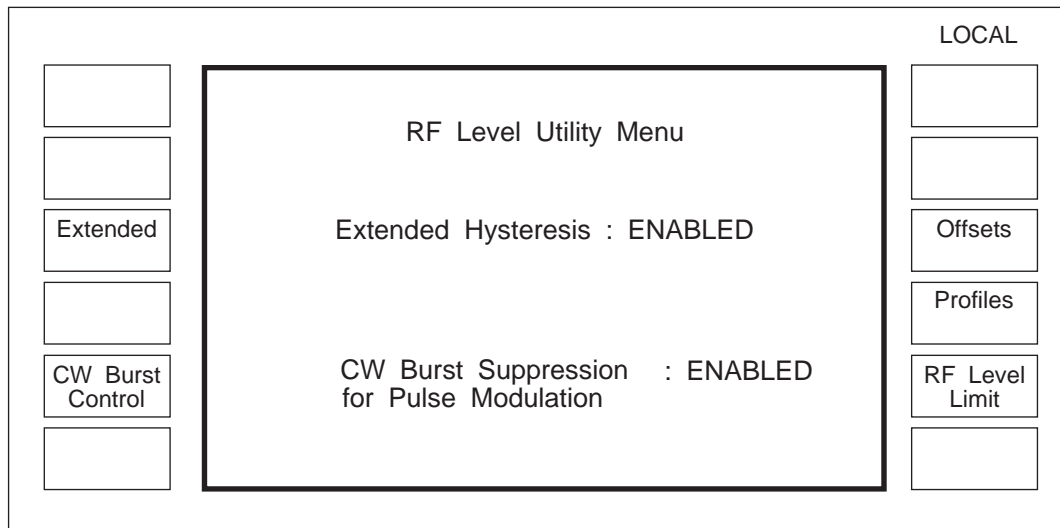

C1895

Fig. C-2 RF level utility menu ([CW burst control] and associated text only appears when the relevant option is fitted)

RF OFFSET

Selecting the *[Offsets]* key will result in a display similar to that shown in Fig. C-3. But note that the *[Save Setting]* key will only appear if the instrument has been unlocked to Level 1.



C0862

Fig. C-3 RF offset selection (shown unlocked to Level 1)

Selecting one of the *[Offset]* keys will allow an offset of up to +80 dB to -40 dB to be entered using the numerical key pad and the [dB] terminator key. Any of the five offset values may be selected by pressing the appropriate soft key.

The offset values can be changed at any time. The set of values displayed when the instrument is first switched on can also be changed by the user. The generator should be unlocked to Level 1 so that the *[Save Setting]* key is displayed. If the offset values are then changed to the required power up settings and the *[Save Setting]* key is pressed the values are stored in non-volatile memory. If the instrument is switched off then when power is restored the saved values of offsets will be automatically recalled and displayed. If the offset values are edited but not saved the edited values will be lost when the instrument is switched off.

The offset facility can be enabled or disabled using the *[Enable/Disable]* key. The state of the Enable/Disable function is stored in non-volatile memory if the *[Save Setting]* key is pressed. If the instrument power is turned off and then on, the stored condition of the Enable/Disable function is recalled.

The RF offset facility can be left by pressing *[EXIT]* to obtain the *RF Level Utility Menu* of Fig. C-2, or by pressing any of the keys underneath the display. If the offset facility is enabled and *[SIG GEN]* is pressed the main signal generator screen shown in Fig. C-4 is displayed. The display shows that in this example the RF offset facility is enabled and the value of the offset in use is +20 dB. For the set RF level of 0 dBm the signal generator output will be -20 dBm.

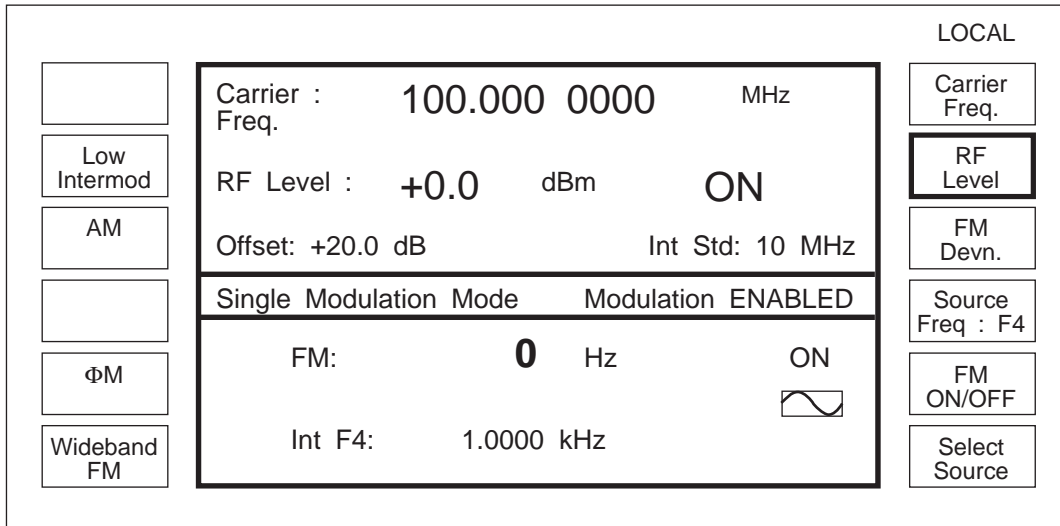

C0863

Fig. C-4 Main signal generator screen with RF offset enabled

RF PROFILES

If the [Profiles] key is selected from the menu shown in Fig. C-2 the display shown in Fig. C-5 is displayed. But note that the [Save Setting] and [Edit Profile] keys will only appear if the instrument is unlocked to Level 1.

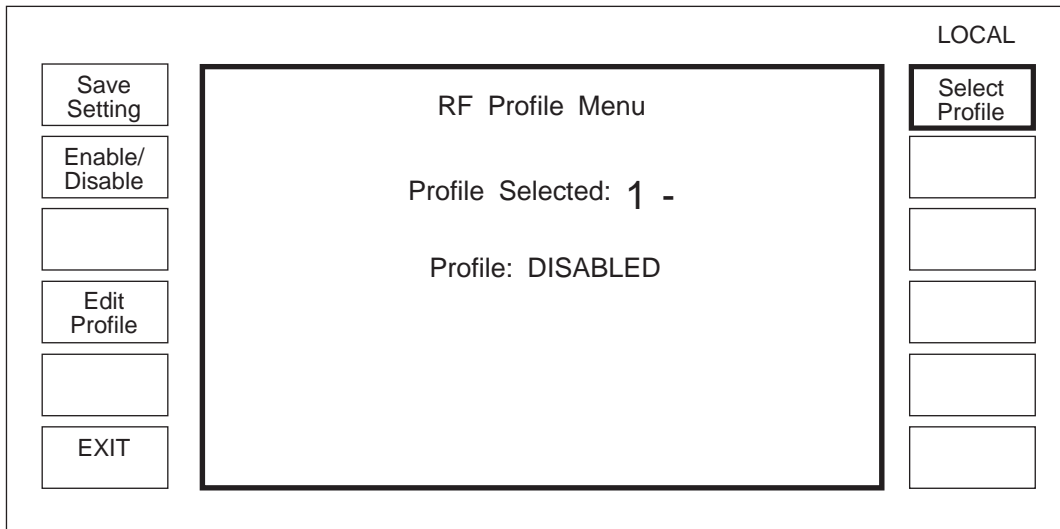

C0865

Fig. C-5 RF profile menu (shown unlocked to Level 1)

Up to 10 profiles may be generated and stored using this facility. The profiles are identified as Profile 0 to Profile 9. Each profile can have up to 100 frequencies at which the output level of the signal generator can be adjusted by up to ± 40 dB to compensate for the frequency response of an external device without altering the displayed RF level of the signal generator.

Creating a profile

An RF profile editor is provided to create or edit profiles. The instrument must be unlocked to Level 1 in order to use the editor. To use the profile editor press the *[Edit Profile]* key to give the display shown in Fig. C-6.

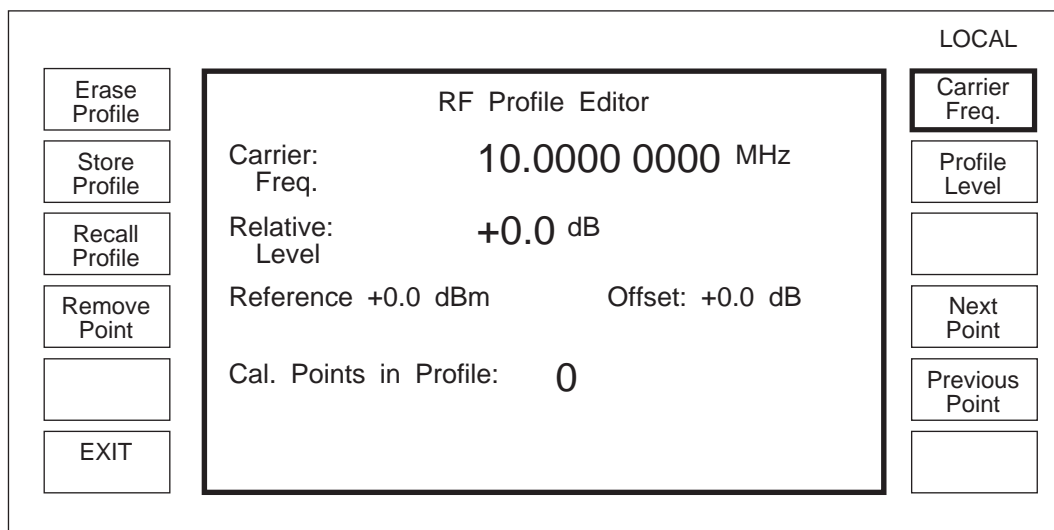

C0866

Fig. C-6 RF profile editor menu

The RF offset will only be displayed if an offset value has been selected and enabled. The signal generator's RF level setting is displayed as the reference level.

If the user wishes to edit an existing profile, pressing *[Recall Profile]* followed by the profile number (0 to 9) and the *[enter]* key will recall a profile into the editor. A profile can be erased by pressing *[Erase Profile]* followed by the profile number (0 to 9) and the *[enter]* key.

Profiles are constructed by entering the carrier frequency at which a correction is to be applied and then adjusting the RF output level until the required setting is obtained. The relative level shows how much the RF level has been adjusted from its nominal value. A positive value of relative level increases the RF output level.

To construct a profile first select the required carrier frequency using the *[Carrier Freq.]* key. The relative level at that frequency can then be adjusted by pressing *[Profile Level]*. The carrier frequency or profile level can be entered using the keyboard or the rotary control.

When the required value of level has been set up the point is saved using the *[Save Point]* key which appears in place of the *[Remove Point]* key. The *Cal Points in Profile* display shows how many points form the profile (a profile can have up to 100 points).

When a profile has been constructed (or is being entered) the points can be inspected by using the *[Next Point]* or *[Previous Point]* keys. To make the user aware that a limit has been reached i.e. the first or last point in a profile, the message *At Top Limit* or *At Bottom Limit* is displayed at the top of the screen. Points can be deleted using the *[Remove Point]* key. When *[Remove Point]* has been pressed, an additional key *[Restore Point]* appears. This allows a point which has been accidentally removed to be reinserted.

Points can be added to the profile in any frequency order so that if, for instance, it is found necessary to add a point between two existing points, then when the point is saved the software automatically re-orders the points into an ascending frequency order, and provides interpolation between these points.

Hint:

The rotary control provides a very useful means of editing or creating a profile. If the control is used to adjust carrier frequency while the power at a remote point is monitored, the control gives a good feel for where points should be inserted. The interpolation of the correction data between frequencies results in the most useful location for correction points to be either at or at either side of maximum or minimum values of power.

Note...

If a profile point is added at the same frequency as an existing point in that profile, the old profile level will be automatically overwritten by the new value.

Once two or more points have been entered in a profile the profile can be stored by pressing the *[Store Profile]* key followed by the profile number (0 to 9) and the *[enter]* key.

Enabling a profile

To enable or disable a profile first use the *[Select Profile]* key shown in Fig. C-5 and enter the profile number (0 to 9) to be used and terminate the entry using the *[enter]* key.

The *[Enable/Disable]* key can then be used to enable or disable the profile.

The profile facility can be set to be on or off when an instrument is switched on using the save setting facility. If the generator is unlocked to Level 1 pressing the *[Save Setting]* key on the *RF Profile Menu* of Fig. C-5 will result in the state of profile enable/disable flag and the selected profile number being stored in non-volatile memory. If the profile is enabled then at power on the generator will recall the profile and apply it to the RF output.

The RF Profile Menu can be left by using the *[EXIT]* key to obtain the RF Level Utility Menu of Fig. C-2 or by using the keys underneath the display. If the *[SIG GEN]* key is pressed to obtain the main signal generator screen, and the profile facility is enabled, the profile selected is displayed as shown in Fig. C-7. The correction value corresponding to the selected carrier frequency will be applied to the RF level.

Note...

Where the carrier frequency is set to a value less than the lowest profile frequency the value at the lowest profile will be used. Similarly if the set carrier frequency is higher than the highest profile frequency the value of the highest profile value will be used.

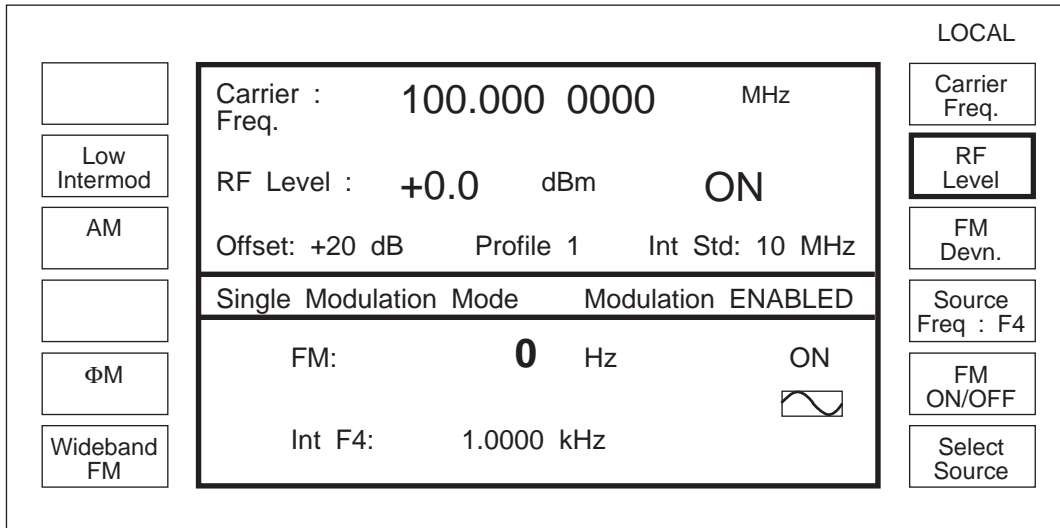

C0867

Fig. C-7 Main signal generator screen with RF offset and profiles enabled

Tutorial examples for RF offset and profiles

Example 1: RF offset - compensating for a combiner

Problem:

An application requires the addition of two RF signals with a combiner as shown in Fig. C-8. The combiner has 6 dB insertion loss and it is desirable for the signal generators to display the signal level after the combiner.

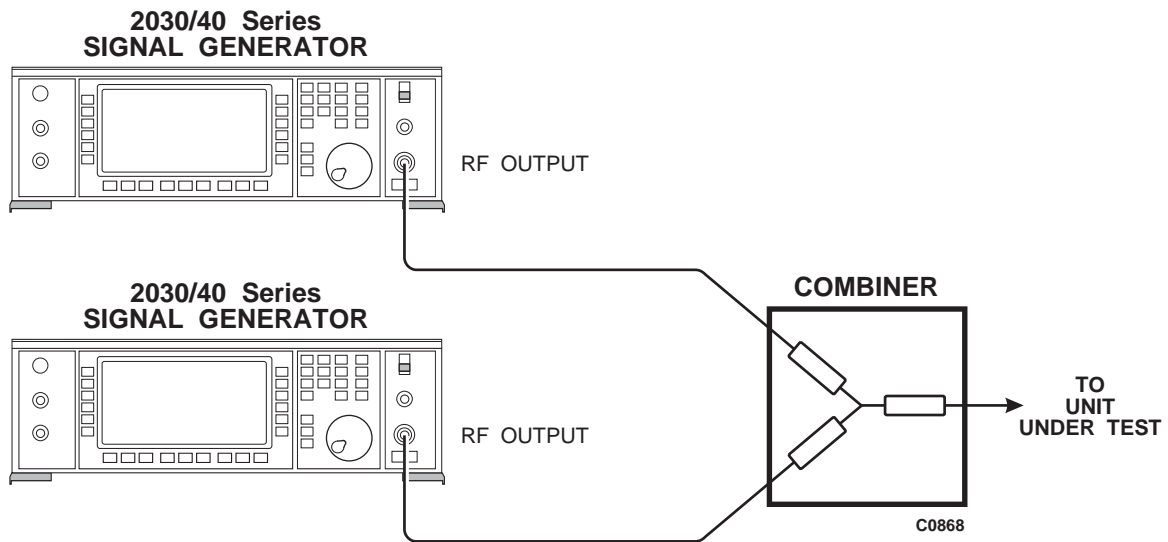

Fig. C-8 Two signal generator testing with a resistive combiner

Solution:

Use the RF offset facility. Set the RF output level (for example to +6 dBm). Then set *Offset 1* (see Fig. C-3) to -6 dB and enable the offset. The signal generators provide outputs of +6 dBm to compensate for the signal loss of the combiner whilst now displaying the signal level after the combiner (in the example 0 dBm) as required.

Note that the maximum displayed RF level will now be limited to +7 dBm since this represents +13 dBm at the RF output connector (unless the overrange facility is enabled).

If the save setting facility is used (Fig. C-3) the generator can be set so that every time it is switched on a -6 dB offset is applied.

Example 2: RF offset and profiles - compensating for an amplifier

Problem:

The signal generator is being used with an external amplifier having a nominal gain of 28 dB. The generator is being used over the frequency range 100 MHz to 500 MHz. Amplifier frequency response and cable losses result in the overall gain of the amplifier system varying between 25 dB and 31 dB. The signal generator is required to display the power at the output of the amplifier.

Solution:

Use both RF offset and RF profile. First use the RF offset facility to enter an offset value of 28 dB (i.e. the mid-point of 25 and 31 dB). Connect a power meter to the amplifier as shown in Fig. C-9 after making sure that the amplifier output is at a level which will not damage the power meter.

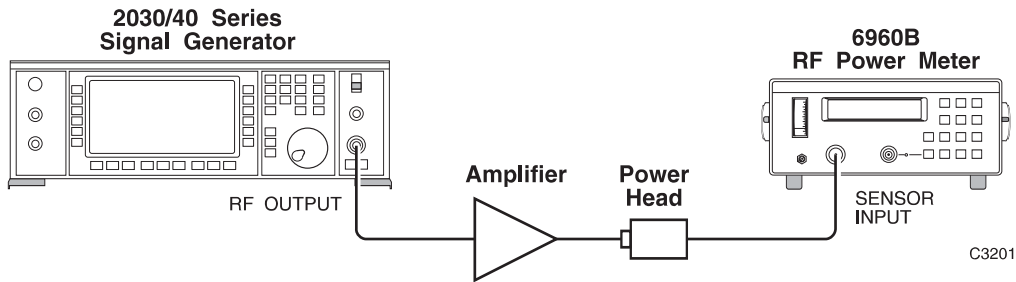

Fig. C-9 Using a signal generator with an external amplifier

A profile can now be added to reduce the frequency dependent RF level errors. With the signal generator level set at (for example) 0 dBm and unlocked to Level 1, select the *RF Profile Editor* shown in Fig. C-6.

Enter a carrier frequency of 100 MHz. Adjust the Profile Level until the power meter reads 0 dBm and then save the point. Repeat for carrier frequencies of 150 MHz, 200 MHz, 250 MHz, 300 MHz, 350 MHz, 400 MHz, 450 MHz and 500 MHz. The profile will now have 9 calibration points entered.

Use the *[Store Profile]* key to store as Profile 0. Exit to the *RF Profile Menu* and select and enable Profile 0.

Press the *[SIG GEN]* key to obtain the main *Sig Gen* menu. Use the rotary control to vary the carrier frequency between 100 MHz and 500 MHz and check that the power meter reading is acceptably close to 0 dBm. Extra points can be added to the profile if required to reduce errors at intermediate frequencies.

Note...

If the carrier frequency is set (in this example) below 100 MHz or above 500 MHz the error message *Carrier Outside Profile* will be displayed. The profile value at 100 MHz will be applied to the RF output level for frequencies below 100 MHz. Similarly the profile value at 500 MHz will be applied to the RF output level for frequencies above 500 MHz.

SEQUENCE SWEEP

The sequence sweep facility allows sweeps to be defined and generated containing up to 10 segments with independent parameters.

The sweep segments differ from the normal sweep facility on 2030 Series Signal Generators in that the step size is defined rather than the number of steps in a sweep. Each sweep segment can have a different RF level, step size and step time as well as independent start and stop frequencies. A sweep similar to that shown in Fig. C-10 can therefore be generated.

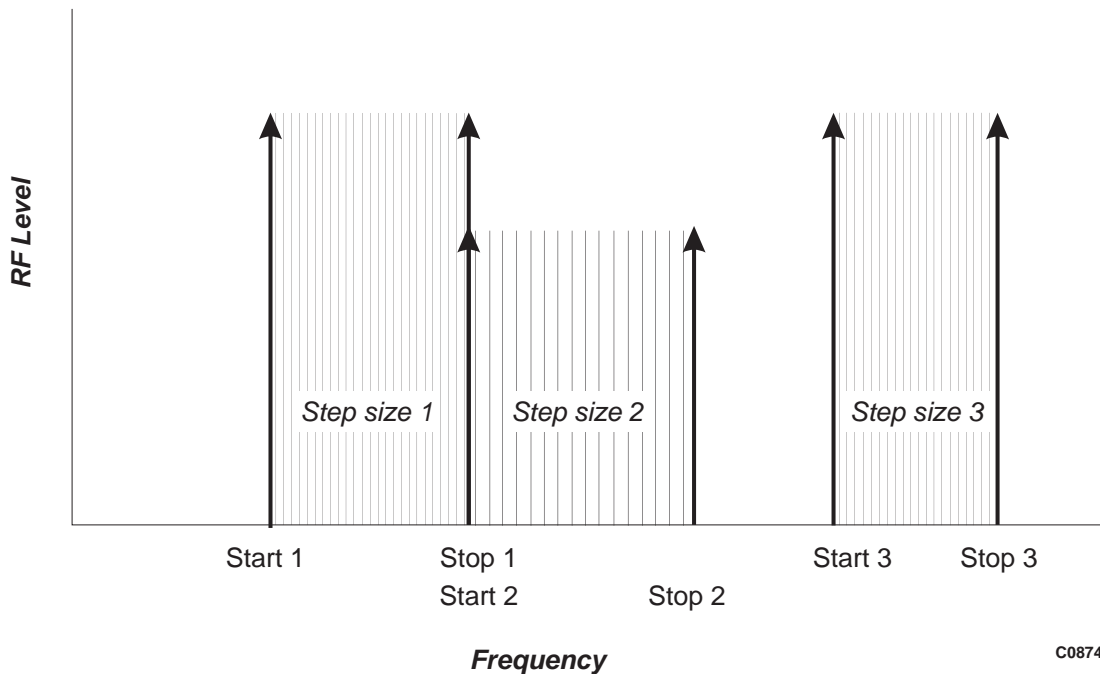

C0874

Fig. C-10 Example for a segmented sweep

The segments can be executed in any order. The RF Profile and RF Offset facility can be enabled to correct for the use of external amplifiers and cables.

Selecting a sequence sweep

To enter the Sequence Sweep mode press the [SWEEP] key to obtain the main sweep generator menu. If the last used sweep is not a sequenced sweep press [Sweep Type] to obtain the display shown in Fig. C-11, press [Sweep Sequence] and use the [EXIT] or [SWEEP] key to return to the Sweep Sequence selection menu shown in Fig. C-12.

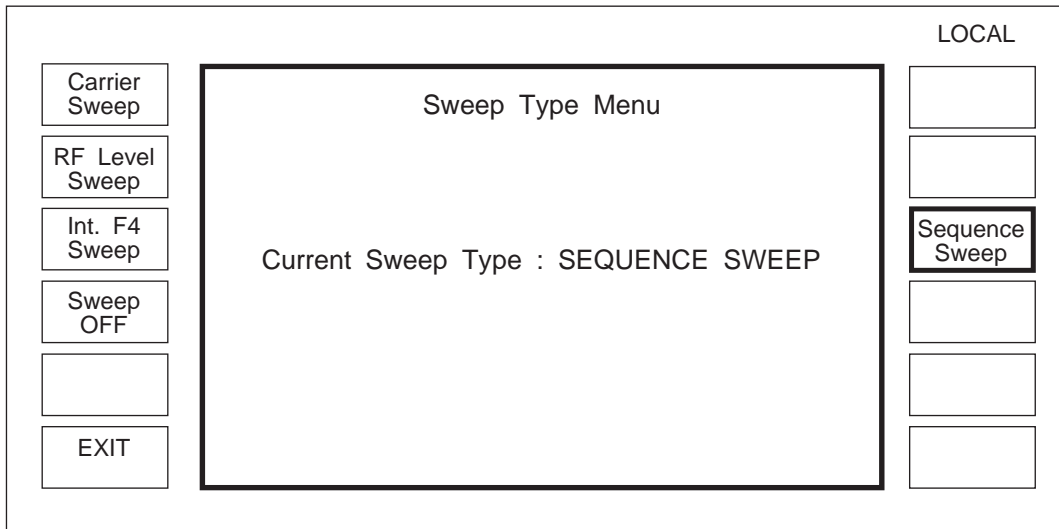

C0858

Fig. C-11 Sweep type menu

Note...

RF profiles cannot be applied to the normal carrier sweep provided on the generator. If RF profiles are enabled the [Carrier Sweep] key in Fig. C-11 will not be displayed.

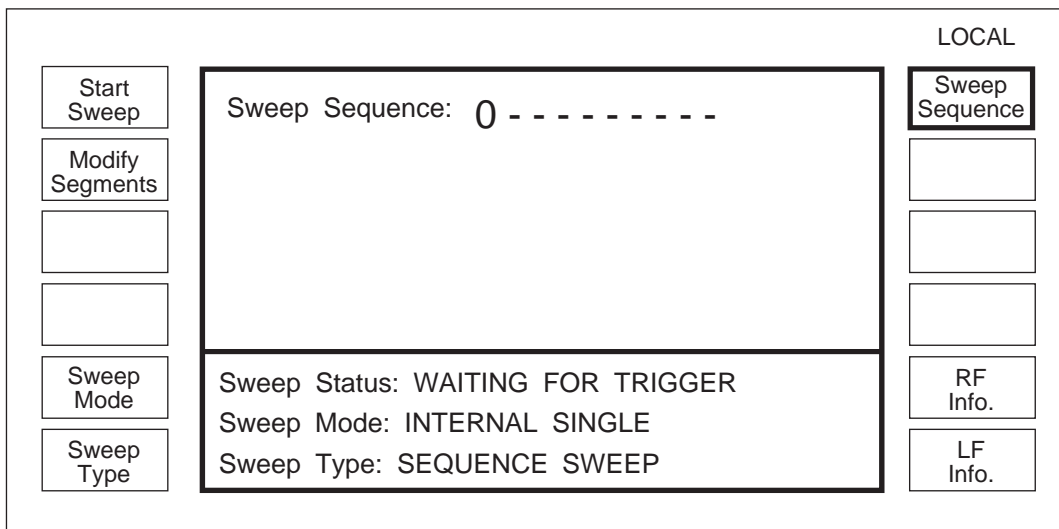

C0859

Fig. C-12 Sweep sequence selection menu

Modifying segments

Sequenced sweeps are defined by a series of segments each of which has independent settings. The segments can be constructed from the menu shown in Fig. C-13 called up by pressing the *[Modify Segments]* key.

	Segment Number: 0 -	LOCAL
Next Segment	Start Freq: 10.0000 kHz	Segment Number
Previous Segment	Stop Freq: 100.0000 kHz	Start Freq.
	RF Level: +0.0 dBm	Stop Freq.
	Step Size: 100.0 Hz	RF Level
EXIT	Step Time: 20 ms	Step Size
	Offset: +20.0 dB	Step Time
	Profile 1	

C0856

Fig. C-13 Sweep segment editor

Up to 10 segments can be defined as Segments 0 to 9. If an existing segment is to be inspected (or a segment similar to an existing one is required) the segment can be recalled by pressing *[Segment Number]* followed by the segment number (0 to 9) and the *[enter]* key. Pressing *[Next Segment]* or *[Previous Segment]* will increment or decrement through the segments. For each segment the *[Start Freq.]*, *[Stop Freq.]*, *[RF Level]*, *[Step Size]* and *[Step Time]* keys can be used to define the segment parameters.

Once the user has defined the required segments in a sweep pressing the *[EXIT]* key returns the user to the *Sweep Sequence Selection Menu* shown in Fig. C-12.

Note...

The segment settings are not automatically stored in the non-volatile memory. To store the settings press the *[MEM]* key. If the memory recall menu is displayed press *[Memory Store]*. Press *[Sweep Store]* followed by the sweep store number (0 to 19) and the *[enter]* key.

Entering a sweep sequence

From the sweep menu in Fig. C-12 a sweep sequence can be defined by pressing *[Sweep Sequence]* followed by the segment numbers (0 to 9) in the order that they are required to be generated. A minimum of one and a maximum of 10 segments is allowed.

Sweep mode

The *[Sweep Mode]* key can be used to set the sweep to be externally or internally triggered and to be in continuous or single shot mode.

Note...

This is identical to the trigger system used in the other sweep modes.

Starting to sweep

To start a sweep press the *[Start Sweep]* key on the Sweep Sequence selection menu (Fig. C-12). The signal generator will start sweeping and display the current frequency, RF level, step time and the segment number it is currently in. If the sweep has been set to go through a number of segments at different levels the display is updated to show the change of setting.

Before the start of a sweep the RF or LF settings of the generator can be inspected by pressing the *[RF Info.]* or *[LF Info.]* keys.

When a sweep is in progress the sweep can be stopped at any point using the *[Stop Sweep]* key and a display similar to Fig. C-14 will be shown. The carrier frequency and RF level can be varied by using the rotary control.

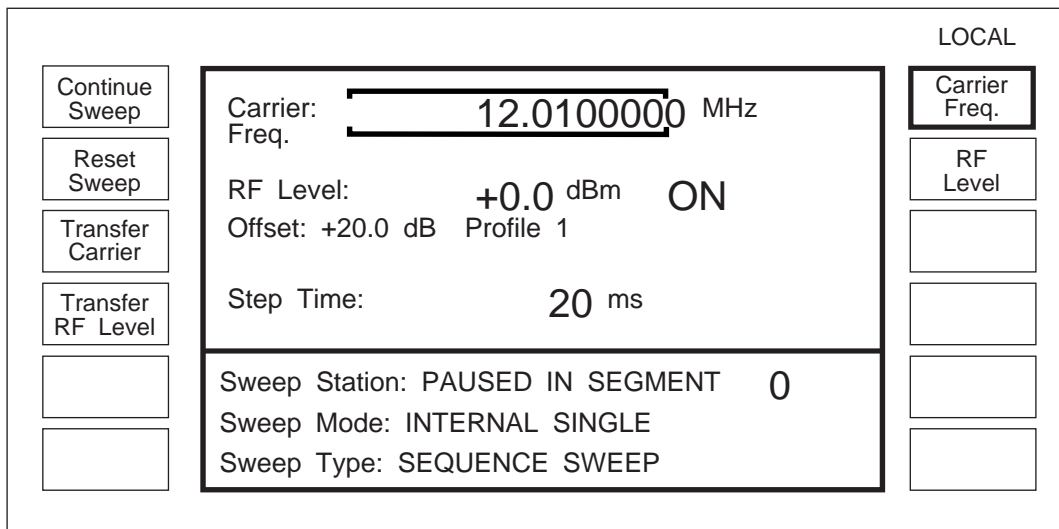

C0857

Fig. C-14 Sweep menu display with the sweep halted

Pressing *[Continue Sweep]* will result in the sweep restarting from the same frequency and level as it was stopped at.

Pressing *[Reset Sweep]* will return the sweep to the starting point.

Pressing *[Transfer Carrier]* and/or *[Transfer RF Level]* will transfer the current setting to the main signal generator carrier and RF level settings (obtained by pressing *[SIG GEN]*).

Tutorial examples for sequence sweep

Example 1: System immunity test

Problem:

A digitally stepped signal is required to test the immunity of a system to RF signals applied at harmonics of the internal clock frequencies of a unit under test. The test requires that the first 20 harmonics are checked and that the signal is swept 10 kHz either side of the nominal clock frequency. The unit under test contains clock frequencies of 8 MHz (for the microprocessor) and 10 MHz.

Solution:

Set the signal generator to provide a frequency modulated signal from the internal triangle source at a rate of 20 Hz and a deviation of 10 kHz.

Use the segmented sweep facility to set up Segment Number 0 to start at 8 MHz with a step size of 8 MHz, a step time of 100 ms and a stop frequency of 160 MHz.

Set up Segment Number 1 to start at 10 MHz with a step size of 10 MHz, a step time of 100 ms and a stop frequency of 200 MHz.

Create a sequence sweep using Segment Number 0 and Segment Number 1. Set the sweep trigger to continuous.

If the sweep is now started it will generate a stepped sweep alternating between harmonics of the 8 MHz and 10 MHz clock and the FM signal will sweep the frequency over a range of ± 10 kHz. The FM signal will nominally sweep linearly over the 10 kHz range twice in each direction on each step since the modulation rate is 20 Hz and the step time is 100 ms.

Example 2: Blocking performance test

A radio is being tested for blocking performance. The radio is tuned to 356.55 MHz and uses 12.5 kHz channel spacing. A sweep is required which extends from 10 MHz below the wanted channel to 10 MHz above the wanted channel but excludes the adjacent and next adjacent channels. The RF level is required to be set to -37 dBm during the sweep.

Solution:

Set Segment Number 0 to start at 346.55 MHz, stop at 356.5125 MHz with a step size of 12.5 kHz and a step time to 100 ms to allow enough time for the radio to respond. The RF level should be set to -37 dBm.

Set Segment Number 1 to start at 356.5875 MHz, stop at 366.55 MHz with a step size of 12.5 kHz, a step time of 100 ms and an RF level of -37 dBm.

Set up Segment Number 2 with a start frequency of 356.5125 MHz, a stop frequency of 356.5875 MHz at step size of 100 kHz and a step time of 100 ms. Set the RF level to -144 dBm.

Set up a sequence sweep using Segment Numbers 0, 2 and 1. The signal generator will now sweep from 346.55 MHz to 356.5125 MHz at -37 dBm, then turn the carrier off, step to 356.5875 MHz, turn the carrier on and then sweep to 366.55 MHz as required.

COMPLEX SWEEPS

RF profiles, offset and sequence sweep

The sequence sweep can be combined with the RF profile and RF offset facility to provide a swept signal source where the signal generator displays the RF level at the output of an external frequency dependent amplifier or attenuator.

To set up a sweep of this type use the required sequence sweep, and RF profile and RF offset can be set up as previously described. If the required RF offset and RF profile are then enabled and the sequence sweep selected a complex sweep incorporating all these facilities can be generated.

Suppressing attenuator changes

In addition to being used with RF profiles and RF offsets, sequence sweeps can also be used in conjunction with Extended Hysteresis. Sweeps generated with the Extended Hysteresis mode enabled, will use the modified electronic control facility to apply the RF profiles and to vary the RF output level. Provided the required level does not exceed the Extended Hysteresis electronic control range the mechanically actuated attenuator will not be operated.

Note...

When the -HYST flag is displayed the RF level of the generator is not as accurate as normal modes of operation.

Tutorial example for immunity testing

Example: Immunity testing in a GTEM cell

Problem:

A device is to be tested to check its immunity to electro-magnetic fields using a GTEM cell. The test requires that the device is tested for field strengths of 10 V/m at frequencies from 1 MHz to 100 MHz and 3 V/m from 100 MHz to 400 MHz. The tests call for checks to be made at 10 kHz intervals from 1 MHz to 30 MHz, 12.5 kHz from 30 MHz to 100 MHz and 100 kHz intervals from 100 MHz to 400 MHz. The GTEM system requires a nominal signal of -10 dBm to drive an amplifier that provides a 10 V/m field strength in the cell.

Solution:

The test requires a combination of the sequence sweep, RF offset and RF profile facilities. In this case the "RF Levels" required at the remote point are field strengths of 10 V/m and 3 V/m. The RF offset facility can be used to convert a nominal signal of -10 dBm to a displayed 10 V PD by using an offset of +43 dB (10 V PD is approximately +33 dBm).

Use a field probe to check the field strength in the GTEM cell. With the generator set to 10 V PD use the RF profile facility to obtain a 10 V/m reading on the field probe for frequencies between 1 MHz and 400 MHz. While creating the RF profile remember that the signal generator software interpolates between profile points so points need to be entered only when the profile slope changes. Store the RF profile produced and check that the field strength is substantially constant as the frequency is changed.

Note...

In this example it is assumed that the RF amplifier is capable of generating a field of 10 V/m at all frequencies and that the amplifier is working in the linear region.

Set up a sequence sweep using segments providing the following characteristics:

	START	STOP	STEP SIZE	RF LEVEL	STEP TIME
Segment Number 0	1 MHz	30 MHz	10 kHz	10 V PD	100 ms
Segment Number 1	30 MHz	100 MHz	12.5 kHz	10 V PD	100 ms
Segment Number 2	100 MHz	400 MHz	100 kHz	3 V PD	100 ms

Select a sequence sweep using Segment Numbers 0, 1 and 2. With the RF profile and RF offset enabled and the device under test inserted in the GTEM in place of the field probe a swept test can now be undertaken.

The test can be repeated at higher or lower field strength by simply redefining the RF level in the sweep segments.

SQUARE WAVE MODULATION

Generators supplied with Option 008 fitted can generate square wave modulation in addition to the standard sine and triangle waveforms. Square wave modulation can be selected from the main signal generator menu with the modulation set to internal by pressing [*Select Source*] to obtain the *Internal Source Selection Menu* and then pressing [*Square Wave*] to select the square wave modulation source.

The rise and fall times of the square wave are shaped to ensure that minimal overshoot is obtained for AM with frequencies up to at least 2 kHz.

GPIB OPERATION

The following GPIB mnemonics are used to control the RF profile and complex sweep option in addition to those described in Chapter 3-2.

Segmented sweeps

Segmented sweep is a new sweep type which enables the user to set up segments of carrier sweep and store these away in non-volatile memory for future use. Each segment will consist of a START and STOP frequency, RF LEVEL, STEP SIZE and STEP TIME.

A complex sweep can be set up by specifying a sequence of these segments; on completion of sweeping one segment the sweep will jump to the start of the next segment and continue sweeping.

The following GPIB commands are used to provide GPIB control of the segmented sweep.

SWEEP [not used alone]
:TYPE <character program data>
 Select type of sweep

Data type: SEQ (Segmented Sweep)
 Allowed Suffices: None
 Default Suffix: None

SWEEP? Responds with information on Sweep Type and Sweep Mode status as follows:
 :SWEEP:TYPE <type>;MODE <mode>

Example: :SWEEP:TYPE SEQ;MODE SNGL

SWEEP [not used alone]
:SEQUENCE <string program data>
 Select Segmented Sweep Sequence

Data type: String of Segment numbers (0-9) with up to 10 characters between string delimiters (e.g. "1238976" or '987665')
 Allowed Suffices: None
 Default Suffix: None

SWEEP:SEQUENCE? Responds with currently selected Sequence as follows:
 :SWEEP:SEQUENCE <string program data>

Example: :SWEEP:SEQUENCE "5675676543"

SWEEP	[not used alone]
:SEG0	
↓	
:SEG9	[not used alone]
:<cmd>	Select a Segment to edit where <cmd> is replaced by one of the following:
:START	Select start frequency
:STOP	Select stop frequency
:SIZE	Select step size
Data type:	Decimal Numeric Program Data
Allowed Suffices:	GHZ, MHZ, KHZ, HZ
Default Suffix:	HZ
:RFLV	Select RF Level
Data type:	Decimal Numeric Program Data
Allowed Suffices:	DBM, DBV, DBMV, DBUV, V, MV, UV
Default Suffix:	DBM unless changed by UNITS command
:TIME	Select step time
Data type:	Decimal Numeric Program Data
Allowed Suffices:	MS
Default Suffix:	MS
 SWEEP:SEG0?	
↓	
:SEG9?	Responds with parameter settings for segment number specified (0-9) as follows:
	<code>:SWEEP:SEG<nr1>:START <nrf>;STOP <nrf>;</code> <code> RFLV <nrf>;SIZE <nrf>;TIME <nrf></code>
Example:	<code>:SWEEP:SEG2:START 125000000.0; STOP 1750000000.0;</code> <code> RFLV -32.4; SIZE 50000000.0; TIME 20</code>
:XFER:CW	Transfer Paused Carrier value to main parameter
Data type:	None
Allowed Suffices:	None
Default Suffix:	None
:XFER:RFLV	Transfer Paused RF Level value to main parameter
Data type:	None
Allowed Suffices:	None
Default Suffix:	None

RF profiles

Used for specifying a level profile over a frequency range. Consists of relative offsets, from a predefined reference level, at user defined frequencies. Linear interpolation is used to calculate the level between frequency points. Up to 10 profiles can be stored away in non-volatile memory for future use.

These profiles can be used in conjunction with segmented sweeps as well as in NORMAL instrument mode, but not with ordinary frequency carrier sweeps.

The following GPIB commands are used to provide GPIB control of the RF profiles.

PROFILE [not used alone]
:STATUS [not used alone]
:NUM Select Profile (0-9)
 Data type: Decimal Numeric Program Data
 Allowed Suffices: None
 Default Suffix: None
:ENABLE Enable Selected Profile
:DISABLE Disable Selected Profile
:SAVE Store profile setting and status in memory
 Data type: None
 Allowed Suffices: None
 Default Suffix: None

PROFILE:STATUS? Responds with Selected Profile number (0-9) and Status as follows:

:PROFILE:STATUS:NUM <nr1>;<status>

Example: :PROFILE:STATUS:NUM 4;ENABLE

To edit a profile, first set the instrument mode to PROFILE

IMODE Select instrument mode
 Data type: Character program data (NORMAL, SWEEPER or PROFILE)
 Allowed Suffices: None
 Default Suffix: None
 Example: IMODE PROFILE

PROFILE [not used alone]
:EDIT [not used alone]
:CFRQ Set Carrier Frequency
 Data type: Decimal Numeric Program Data
 Allowed Suffices: GHZ, MHZ, KHZ, HZ
 Default Suffix: HZ

:OFFS Set Relative Offset

 Data type: Decimal Numeric Program Data

Allowed Suffices: dB

 Default Suffix: dB

:SAVE Save profile point

 Data type: None

Allowed Suffices: None

 Default Suffix: None

:REMOVE Remove a profile point (1 - Number of Points in profile)

 Data type: Decimal Numeric Program Data

Allowed Suffices: None

 Default Suffix: None

:POINT Select a profile point (1 - Number of Points in profile)

 Data type: Decimal Numeric Program Data

Allowed Suffices: None

 Default Suffix: None

:ERASE Clear profile in memory (0-9)

:STO Store profile in memory (0-9)

:RCL Recall profile from memory (0-9)

 Data type: Decimal Numeric Program Data

Allowed Suffices: None

 Default Suffix: None

PROFILE:EDIT:POINT? Responds with Carrier Frequency and Relative Offset for the point requested as follows:

:PROFILE:EDIT:CFRQ <nrf>;**OFFS** <nrf>

 Data type: Decimal Numeric Program Data

Allowed Suffices: None

 Default Suffix: None

Example: **:PROFILE:EDIT:CFRQ** 10000000.0;**OFFS** -9.9

PROFILE:EDIT? Responds with the Number of Points in Profile Editor as follows:

<number of points>

Example: 20

RF offsets

The GPIB commands for RF LEVEL OFFSETS are as follows:

RFLV

:OFFS [not used alone]
:NUM Select RF Offset (1-5)
Data type: Decimal Numeric Program Data
Allowed Suffices: None
Default Suffix: None
:VALUE Set current RF Offset value
Data type: Decimal Numeric Program Data
Allowed Suffices: dB
Default Suffix: dB
:ENABLE Enable Selected RF Offset
:DISABLE Disable Selected RF Offset
:SAVE Store RF Offsets and status in non-volatile memory
Data type: None
Allowed Suffices: None
Default Suffix: None

RFLV:OFFS? Responds with RF Offset Selected, its Value and its Status as follows:

:RFLV:OFFS:NUM <nr1>;VALUE <nrf>;<status>

Example: :RFLV:OFFS:NUM 3;VALUE -40.0;ENABLE

Annex D

OPTION 009 PULSE GENERATOR

CONTENTS

	PAGE
GENERAL DESCRIPTION	D-2
Pulse definitions	D-2
PERFORMANCE DATA	D-4
PULSE GENERATOR OPERATION.....	D-5
Introduction.....	D-5
Front panel	D-5
Rear panel	D-5
Operation.....	D-6
GPIB OPERATION.....	D-9
ACCEPTANCE TESTING.....	D-11
Introduction.....	D-11
Test equipment.....	D-11
METHOD	D-11

LIST OF FIGURES

Fig. D-1	Signal generator block diagram.....	D-2
Fig. D-2	Pulse definitions - single pulse, internal mode.....	D-3
Fig. D-3	Pulse definitions - single pulse, external mode	D-3
Fig. D-4	Pulse definitions - double pulse, internal mode	D-3
Fig. D-5	Pulse definitions - double pulse, external mode.....	D-4
Fig. D-6	2031 front panel with Option 009	D-5
Fig. D-7	2031 rear panel with Option 009	D-5
Fig. D-8	Utilities selection menu 1	D-6
Fig. D-9	Pulse configuration menu	D-7
Fig. D-10	Pulse configuration menu - pulse modulator fitted	D-7
Fig. D-11	Pulse configuration menu - double pulse	D-8
Fig. D-12	Pulse configuration menu - external trigger	D-8
Fig. D-13	Pulse generator functional test set-up; continuous mode	D-11
Fig. D-14	Oscilloscope trace for SYNC and VIDEO outputs	D-12
Fig. D-15	Pulse generator functional test set-up; external trigger.....	D-13

LIST OF TABLES

Table D-1	Recommended test equipment.....	D-11
-----------	---------------------------------	------

GENERAL DESCRIPTION

This option provides an internal generator with the ability to produce single and double pulses. Panel connectors provide external trigger input and synchronisation and video outputs. Option 009 does not require the fitting of any other option, but it is designed to drive and be fully compatible with Option 002 (Pulse Modulation). A block diagram of the system is shown in Fig. D-1.

Note: The pulse generator is internal to the main 2030 instrument, but has been shown as external for simplicity.

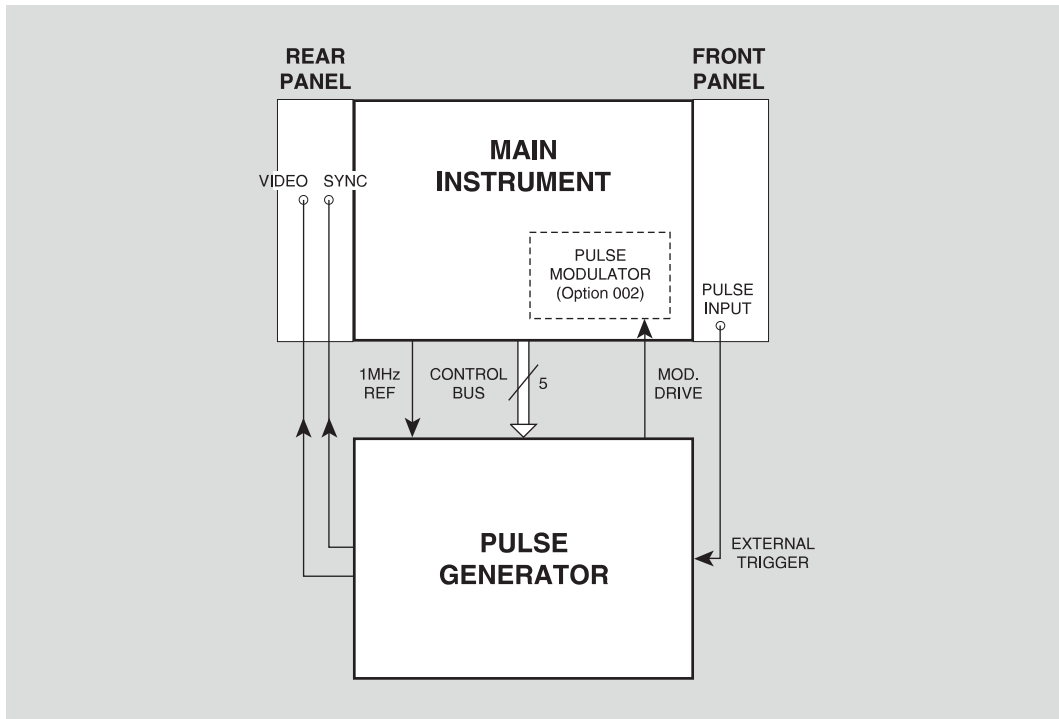

C2800

Fig. D-1 Signal generator block diagram

Pulse definitions

The 2030 Pulse Generator has four modes of operation; single or double pulse and internal or external trigger in each.

Figures D-2 to D-5 show the various pulse characteristics, and how SYNC, VIDEO and PULSE IN (external trigger) are related. They also show the limits which can be set on each.

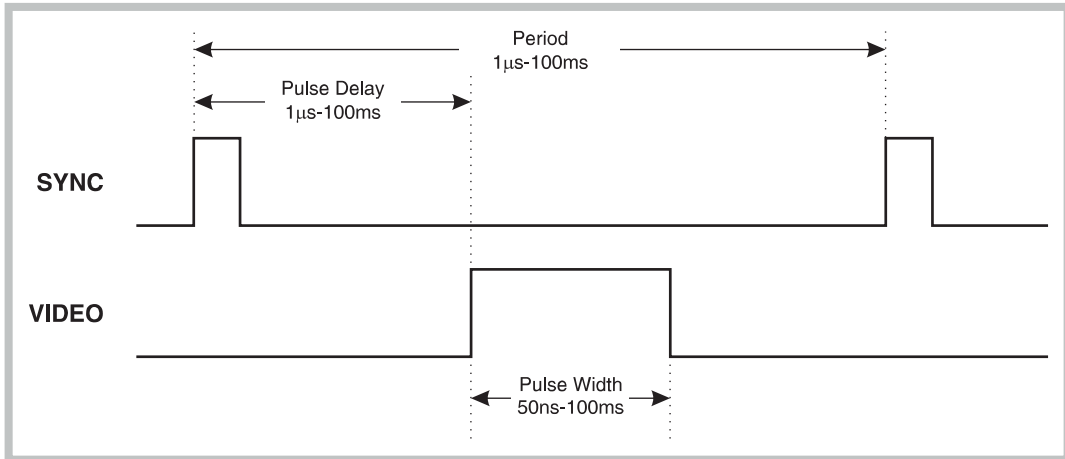

C2801

Fig. D-2 Pulse definitions - single pulse, internal mode

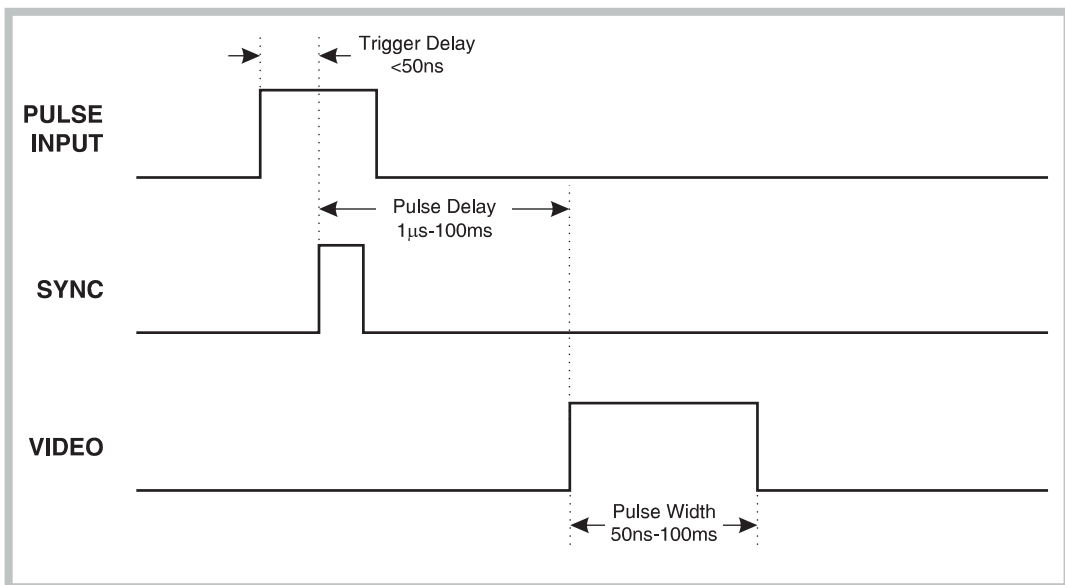

C2802

Fig. D-3 Pulse definitions - single pulse, external mode

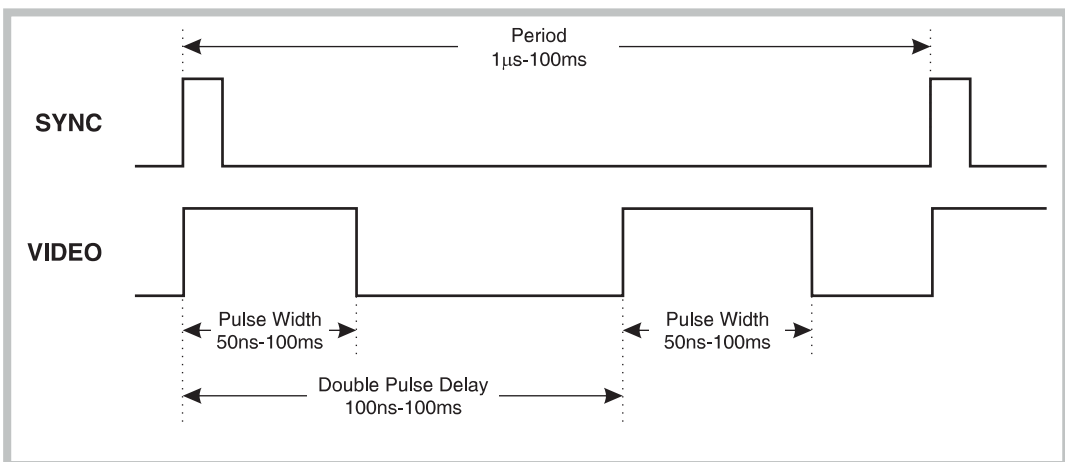

C2803

Fig. D-4 Pulse definitions - double pulse, internal mode

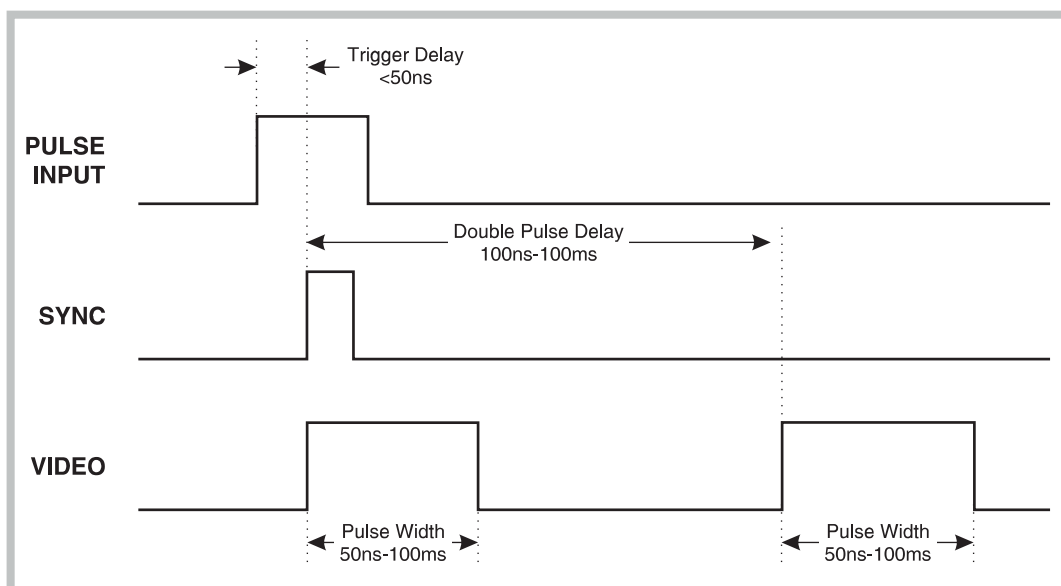

C2804

Fig. D-5 Pulse definitions - double pulse, external mode

PERFORMANCE DATA

A 2030 fitted with Option 009 conforms to the 2030 specification when in pulse generator mode, with the following additions:

Pulse state	Single or double pulse
Trigger mode	Internal or external
Repetition rate (period)	1 μs to 100 ms (1 MHz to 10 Hz)
Pulse width range	50 ns to 100 ms
Pulse delay	500 ns to 100 ms
Double pulse delay	100 ns to 100 ms
External trigger	5 V/50 Ω
Pulse rise/fall times	<5 ns typical
Resolution (all above ranges)	50 ns
Selection method	Keyboard

PULSE GENERATOR OPERATION

Introduction

This section explains how to use Option 009 when fitted to a 2030 Signal Generator. Familiarity with the normal operation of the instrument is assumed.

Note...

When connecting the VIDEO and/or PULSE INPUT connectors to external equipment, a double-screened coaxial cable should be used in order for the instrument to conform to EMC requirements.

Front panel

The front panel of the instrument fitted with Option 009 differs from the basic instrument as follows:

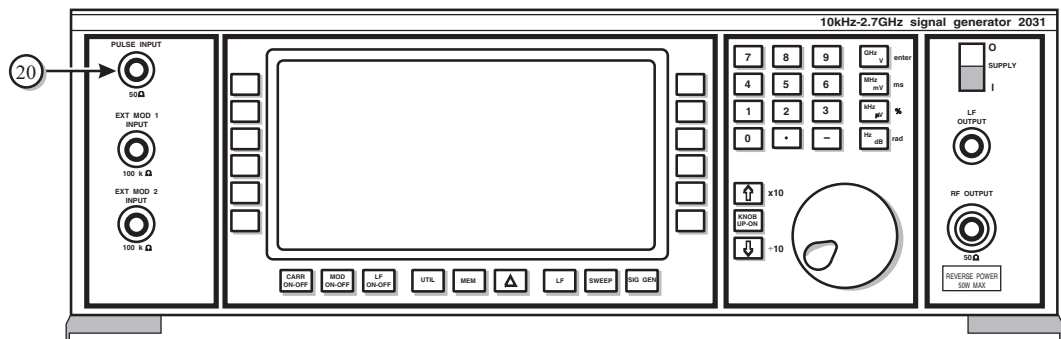

C5713

Fig. D-6 2031 front panel with Option 009

- (20) PULSE INPUT 50 Ω BNC socket accepts a pulsed signal to trigger the pulse generator or to directly control the pulse modulator (Option 002):TTL.

Rear panel

The rear panel of the instrument fitted with Option 009 differs from the basic instrument as follows:

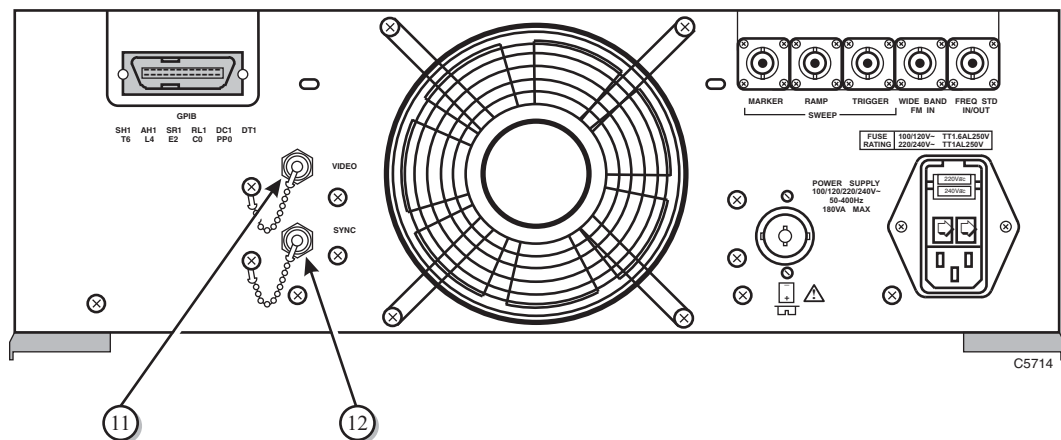

C5714

Fig. D-7 2031 rear panel with Option 009

- (20) VIDEO 50 Ω BNC socket provides the video output signal of the internal pulse generator. When used for pulse modulation, this signal is synchronous with the RF pulse:TTL.
- (12) SYNC 50 Ω BNC socket supplies the sync signal which indicates the start of the video signal:TTL, 400 ns wide.

Operation

Connections are made to the instrument via three BNC sockets. External trigger or external pulse sources are applied to PULSE INPUT on the front panel, a 400 ns synchronisation pulse is available at SYNC on the back panel and a video signal is available at VIDEO on the back panel. It is recommended that double-screened cables are used to/from these connectors.

The usual method of accessing the pulse generator configuration menu is by pressing the [UTIL] key and pressing the [*Pulse Gen.*] key on the Utilities Selection Menu 1, as shown in Fig. D-8.

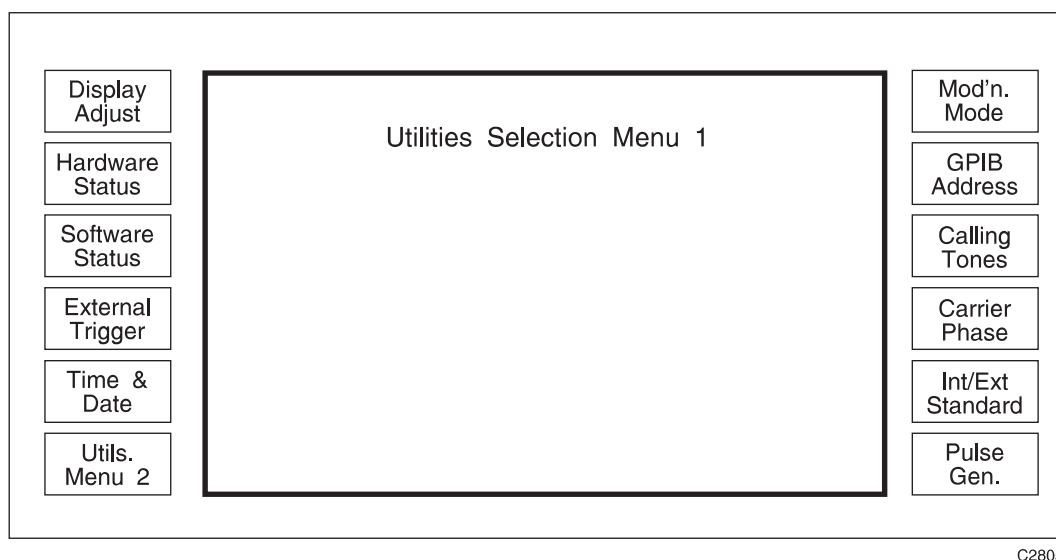
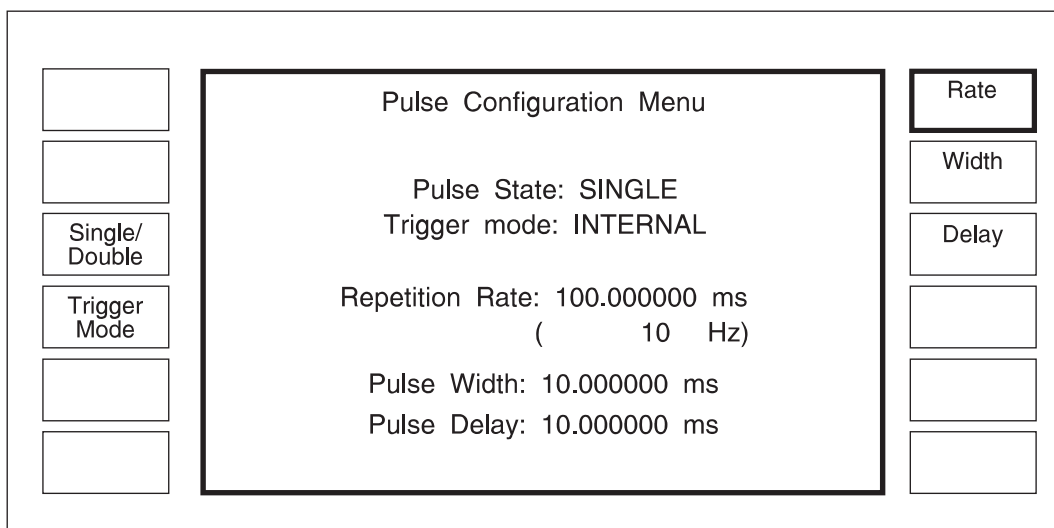

Fig. D-8 Utilities selection menu 1

If the pulse modulator Option 002 is fitted, a [*Pulse Mod.*] soft key becomes available on the main [SIG GEN] screen. Pressing this soft key followed by [*Pulse Config.*] brings up the same pulse generator configuration menu.

Figure D-9 shows the menu with no pulse modulator fitted (or pulse modulator fitted, but with the 2030 in a different modulation mode, e.g. AM).



C2806

Fig. D-9 Pulse configuration menu

Figure D-10 shows the menu with the pulse modulator fitted and with the 2030 in pulse modulation mode. This menu differs from Fig. D-9 in that the [Source] soft key is now available and source type is displayed. The user can now drive the pulse modulator with an external 50 Ω source, as opposed to using the internal generator with an external trigger.

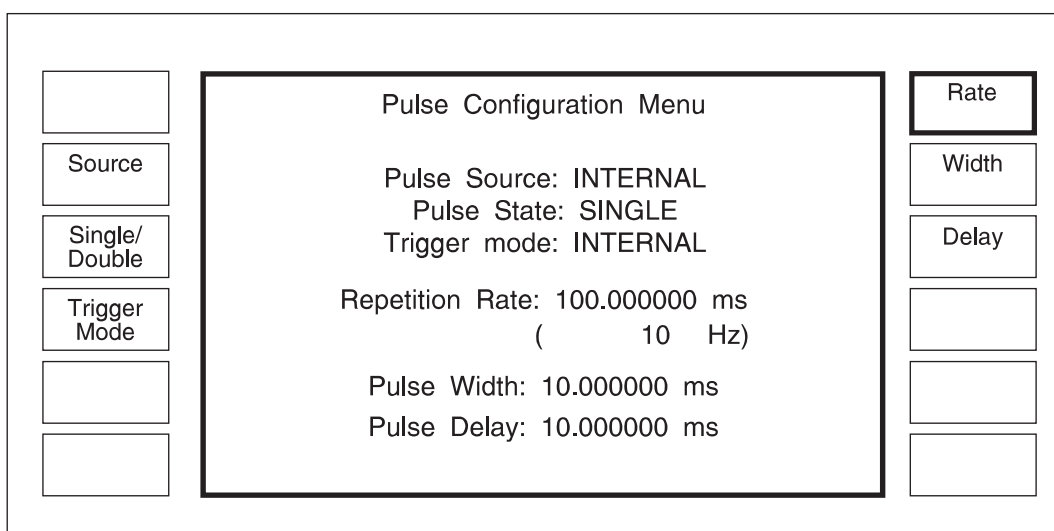

C2807

Fig. D-10 Pulse configuration menu - pulse modulator fitted

In both menus, the default settings of internally triggered single pulse are shown, along with *Repetition Rate*, *Pulse Width* and *Pulse Delay*. Parameters are adjusted by pressing the appropriate soft key (if not already highlighted), entering the appropriate value on the numeric key pad, and pressing the [ms], [us] or [ns] key.

The [Single/Double] and [Trigger Mode] soft keys toggle the pulse state and mode, and alter the menu appropriately.

Figure D-11 shows the menu in double pulse state and Fig. D-12 shows it in external trigger mode.

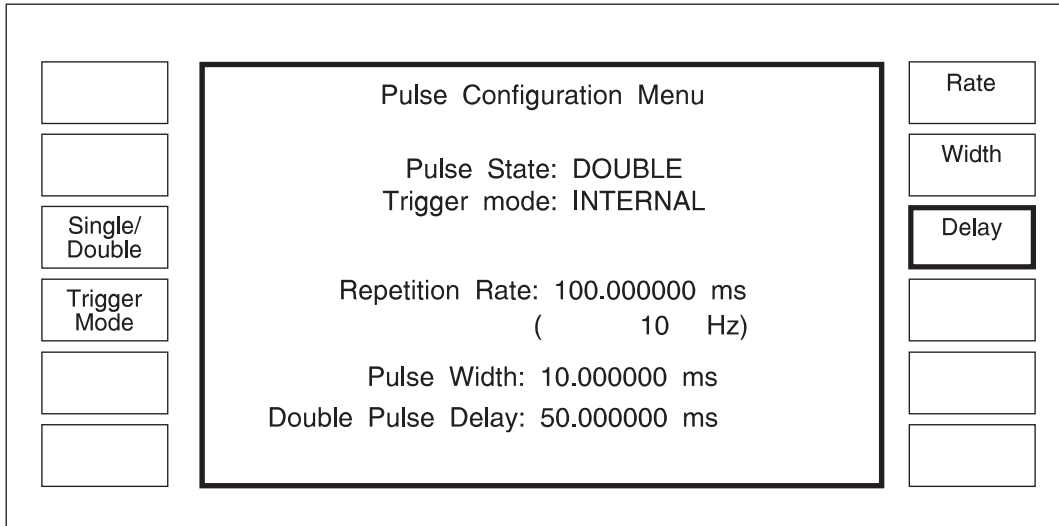

C2808

Fig. D-11 Pulse configuration menu - double pulse

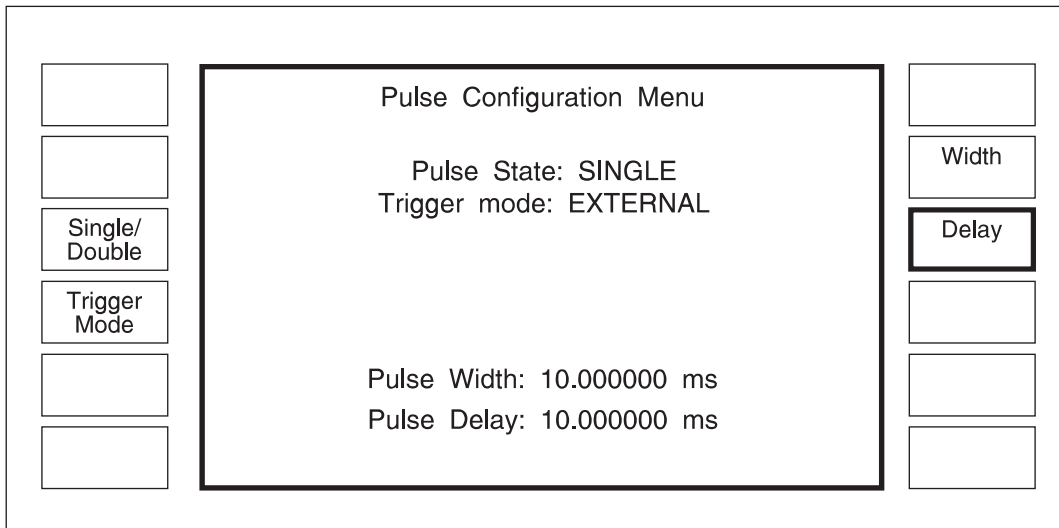

C2809

Fig. D-12 Pulse configuration menu - external trigger

There are a number of conditions under which it is not possible to generate a valid waveform. For example, if the repetition rate is less than the sum of the pulse delay and pulse width or the double pulse delay is less than the pulse width. Under such conditions *ERROR 14: Pulse Profile Not Valid* is displayed and the VIDEO output disabled until a valid profile is entered.

GPIB OPERATION

PGEN	[not used alone]
:SOURCE	Select pulse modulation source
Data type:	Character Program Data (INTERNAL or EXTERNAL)
Allowed suffices:	None
Default suffix:	None
Examples:	PGEN:SOURCE INTERNAL PGEN:SOURCE EXTERNAL
:STATE	Select pulse state
Data type:	Character Program Data (SINGLE or DOUBLE)
Allowed suffices:	None
Default suffix:	None
Examples:	PGEN:STATE SINGLE PGEN:STATE DOUBLE
:TRIGGER	Select trigger mode
Data type:	Character Program Data (INTERNAL or EXTERNAL)
Allowed suffices:	None
Default suffix:	None
Examples:	PGEN:TRIGGER INTERNAL PGEN:TRIGGER EXTERNAL
:RATE	Set pulse generator repetition rate
Data type:	Decimal Numeric Program Data
Allowed suffices:	Any one of: ms, us, ns
Default suffix:	ns
Example:	PGEN:RATE 100MS
:WIDTH	Set pulse width
Data type:	Decimal Numeric Program Data
Allowed suffices:	Any one of: ms, us, ns
Default suffix:	ns
Example:	PGEN:WIDTH 50.001000MS
:DELAY	Set single pulse delay
Data type:	Decimal Numeric Program Data
Allowed suffices:	Any one of: ms, us, ns
Default suffix:	ns
Example:	PGEN:DELAY 4.0US

:D_DELAY Set double pulse delay

 Data type: Decimal Numeric Program Data

 Allowed suffices: Any one of: ms, us, ns

 Default suffix: ns

 Example: PGEN:D_DELAY 10US

PGEN? Prepares message containing information on the pulse generator configuration in the following format:

`:PGEN:SOURCE<status>;STATE<state>;TRIGGER<status>;
RATE<nr1>;WIDTH<nr1>;DELAY<nr1>;D_DELAY<nr1>`

where:<status> is a program mnemonic indicating whether the source or trigger is INTERNAL or EXTERNAL and <state> is a program mnemonic indicating whether the state is SINGLE or DOUBLE.

Examples: `:PGEN:SOURCE INTERNAL;STATE SINGLE;TRIGGER INTERNAL;RATE
100000000;WIDTH 50001000;DELAY 4000`

`:PGEN:SOURCE EXTERNAL`

`:PGEN:SOURCE INTERNAL;STATE DOUBLE;TRIGGER INTERNAL;RATE
100000000;WIDTH 100;D_DELAY 10000`

`:PGEN:SOURCE:INTERNAL:STATE SINGLE;TRIGGER EXTERNAL;WIDTH
10000;DELAY 3000`

ACCEPTANCE TESTING

Introduction

The test procedures in this section enable you to verify that the electrical performance of the signal generator complies with the performance data given earlier. All tests may be performed with the instrument covers in place and should be carried out in the order given. For convenience the test equipment and specification for each test are summarized before the test procedure. These tests are in addition to those specified in Chapter 5 of the manual.

Before starting each test, use the [MEM] function to recall memory number 50. This will restore the instrument to factory default settings, and ensure that the following tests are carried out with the correct settings.

Test equipment

The test equipment recommended for acceptance testing is shown in Table D-1. Alternative equipment may be used providing it complies with the stated minimum performance.

Table D-1 Recommended test equipment

TEST EQUIPMENT		
Description	Minimum specification	Example
Oscilloscope	60 MHz 50 Ω inputs or 50 Ω feed-throughs	Philips PM3055
Pulse generator	1 MHz square Capable of driving 5 V into 50 Ω load	Hewlett Packard 8012B

METHOD

- (1) Connect the test equipment as shown in Fig. D-13.

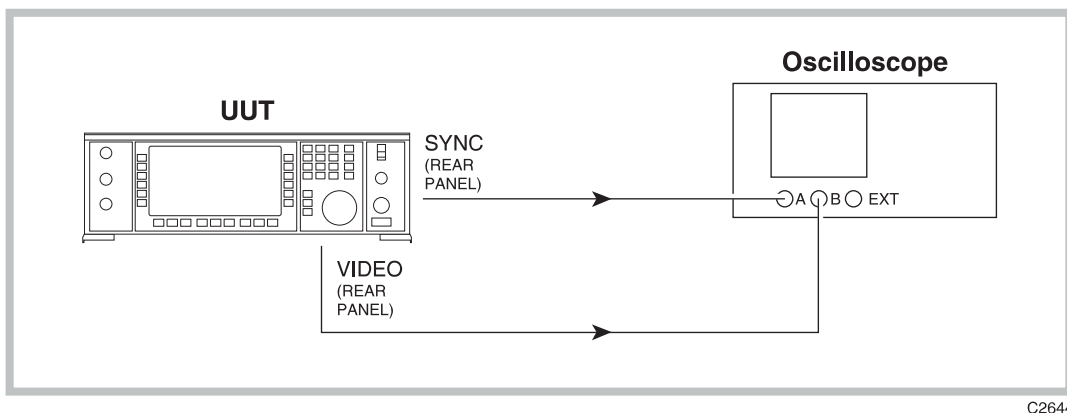

Fig. D-13 Pulse generator functional test set-up; continuous mode

(2) Reset, then set up the equipment as follows:

Unit under test (in Pulse Configuration Menu) :

Repetition rate	2.5 μ s
Pulse width	1 μ s
Pulse delay	1 μ s

Oscilloscope:

A & B volts/div	1 V DC
Timebase	0.5 μ s/div
Trigger	A

(3) The oscilloscope will display the traces shown in Fig. D-14a. The VIDEO pulse should be straight-edged with no noticeable overshoot on rising or falling edges. The pulse width should be 1 μ s and the pulse delay should be 1 μ s. The SYNC pulse width should be 400 ns. Amplitudes should be +2.5 V for both SYNC and VIDEO, providing the oscilloscope has 50 Ω inputs or 50 Ω feed-throughs are used. High impedance inputs will produce nominal amplitudes of +5 V.

Reducing the timebase to minimum will show the rise time of the sync pulse. This should be <5 ns.

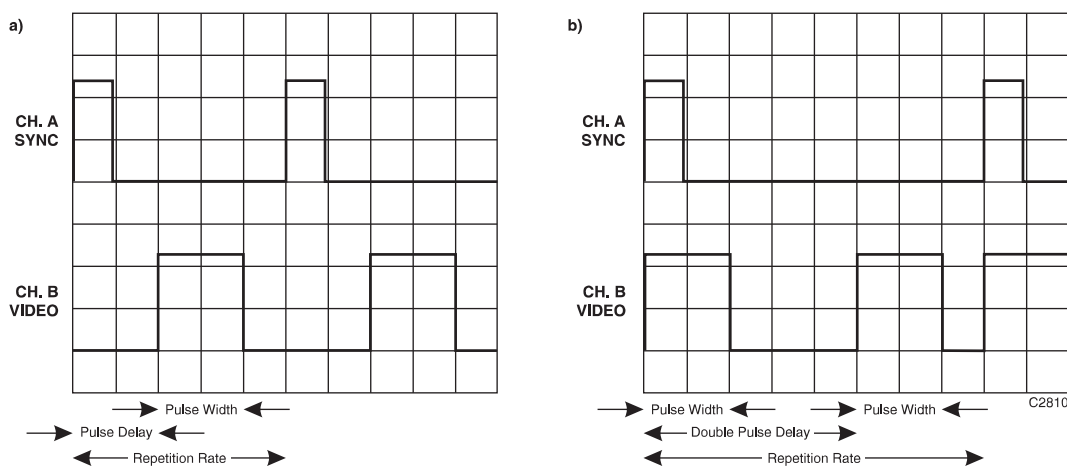

Fig. D-14 Oscilloscope trace for SYNC and VIDEO outputs

(4) Press [Rate] and change the repetition rate to 1 μ s. A message *ERROR 14: Pulse Profile Not Valid* will be displayed, and the outputs should be disabled. Change the repetition rate to 2.5 μ s and the display in Fig. D-14a should be redisplayed.

(5) Press [Single/Double] and change the settings as follows :

Repetition rate	4 μ s
Pulse width	1 μ s
Double pulse delay	2.5 μ s

The oscilloscope display should now be as shown in Fig. D-14b.

(6) Connect the test equipment as shown in Fig. D-15.

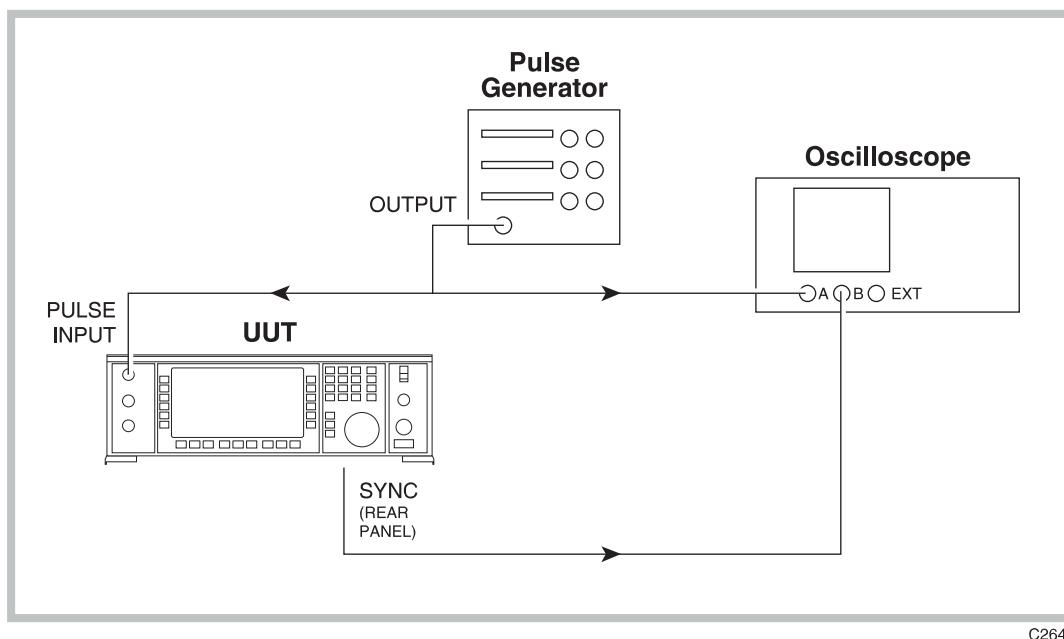

Fig. D-15 Pulse generator functional test set-up; external trigger

(7) Reset, then set up the equipment as follows:

Unit under test (in Pulse Configuration Menu) :

Trigger mode	External
Pulse width	1 μ s
Pulse delay	1 μ s

Oscilloscope :

A & B volts/div	1 V DC
Timebase	0.5 μ s/div
Trigger	A

Pulse generator :

Mode	Continuous square wave
Period	2.5 μ s (400 kHz)
Level OFF/ON	0 V / 5 V into 50 Ω

The oscilloscope will now display the same trace as in Fig. D-14a. Varying the external pulse period should produce a corresponding change in repetition rate (the second SYNC and VIDEO pulse in the train will move left and right).

Annex E

OPTION 010 DME MODULATOR

CONTENTS

	PAGE
GENERAL DESCRIPTION	E-2
DME pulse generator	E-2
DME pulse modulator	E-4
PERFORMANCE DATA	E-4
DME OPERATION	E-5
Introduction	E-5
Front panel	E-5
Rear panel	E-6
Operation	E-6
GPIB OPERATION	E-10
ACCEPTANCE TESTING	E-12
Introduction	E-12
Test equipment	E-12
Pulse generator	E-12
DME pulse modulator	E-15

LIST OF FIGURES

Fig. E-1	DME avionics signal generator block diagram	E-2
Fig. E-2	Pulse definitions - DME, internal mode	E-3
Fig. E-3	Pulse definitions - DME, external mode	E-4
Fig. E-4	2031 front panel with Option 010	E-5
Fig. E-5	2031 rear panel with Option 010	E-6
Fig. E-6	Utilities selection menu 1	E-7
Fig. E-7	Modulation mode selection menu	E-7
Fig. E-8	Avionics mode selection menu	E-7
Fig. E-9	DME status menu	E-8
Fig. E-10	DME selection menu	E-9
Fig. E-11	Pulse generator functional test set-up; continuous mode	E-13
Fig. E-12	Oscilloscope traces for SYNC and VIDEO outputs	E-14
Fig. E-13	Pulse generator functional test set-up; external trigger	E-14
Fig. E-14	Pulse modulator functional test set-up	E-15

LIST OF TABLES

Table E-1	Recommended test equipment	E-12
-----------	----------------------------------	------

GENERAL DESCRIPTION

DME (Distance Measuring Equipment) provides aircraft with accurate and continuous information of slant range distance from a reference ground point. This option provides an internal generator with the ability to produce gaussian shaped double pulses, and a linear RF modulator which produces a similar gaussian shaped RF spectrum. Panel connectors provide an external trigger input and synchronisation and video outputs. Option 010 requires Option 001 (Second Modulation Oscillator) and Option 006 (Avionics) to be fitted. A block diagram of the system is shown in Fig. E-1.

Note: All of the blocks shown are contained within the main 2030 instrument, but have been exploded for simplicity.

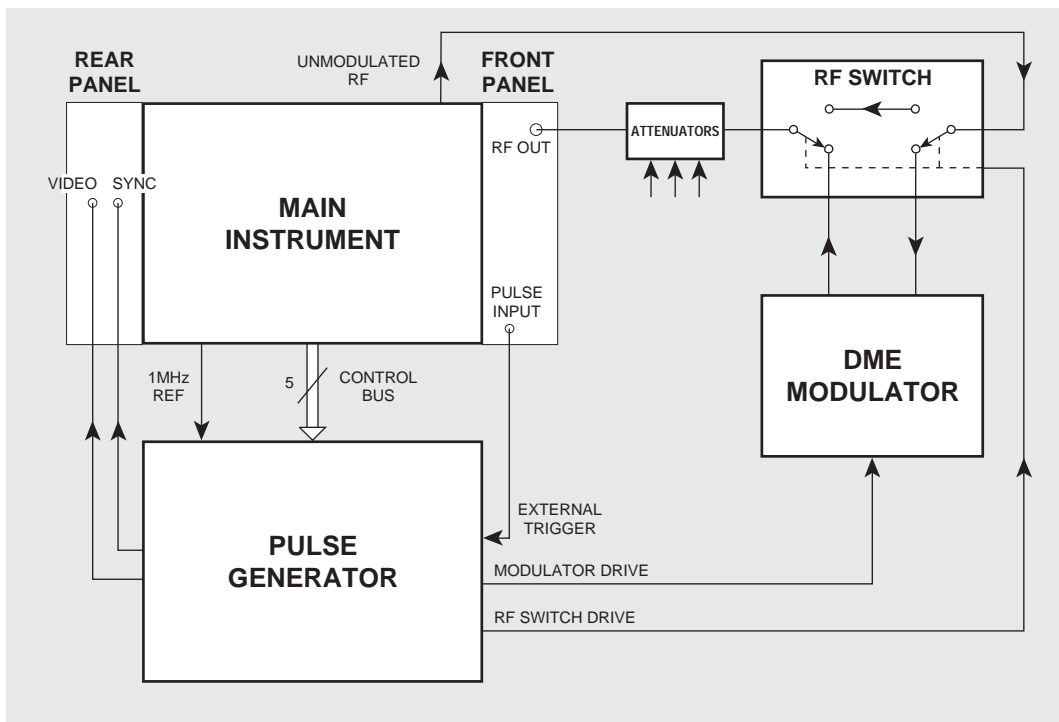

C2647

Fig. E-1 DME avionics signal generator block diagram

DME pulse generator

In addition to providing gaussian shaped pulses, the generator is able to alter rise and fall times and pulse widths. Continuous and externally triggered modes of operation are available, with all parameters adjustable in both.

A gaussian function/pulse, by definition, tends towards its final amplitude as time tends

$$f(t) = \frac{k}{\sqrt{\pi}} e^{-k^2 t^2}$$

towards infinity:

Where k is the constant $1/\sigma^2$ and σ is the variance of time, t .

At time $t = 0$, the pulse is at maximum amplitude, $k/\sqrt{\pi}$, and similarly, times for various amplitudes can be calculated. For example, the rise and fall times depend on the 10% and 90% of maximum amplitude points, and the width depends on the 50% of maximum amplitude points:

$$t_{10\%} = \frac{\sqrt{\log_e 0.1}}{k} \quad t_{90\%} = \frac{\sqrt{\log_e 0.9}}{k}$$

For a given rise or fall time, the constant k can be calculated from the above two equations, and used with a similar equation to calculate the time at 50% amplitude and the associated pulse width. In the same way, for a given pulse width, the 50% amplitude times and associated rise and fall times can be calculated to create a gaussian pulse.

Generating a truly gaussian pulse is not practical, since the amplitude would vary to infinite time. The theoretical pulse is therefore quantised and is assumed to have reached its maximum or minimum value when it is within one step of that value. This value is also used to time the SYNC (synchronisation) pulse, which accompanies the start of each pulse pair.

Figures E-2 and E-3 show the various pulse characteristics, and how SYNC, VIDEO and PULSE IN (external trigger) are related. They also show the limits which can be set on each.

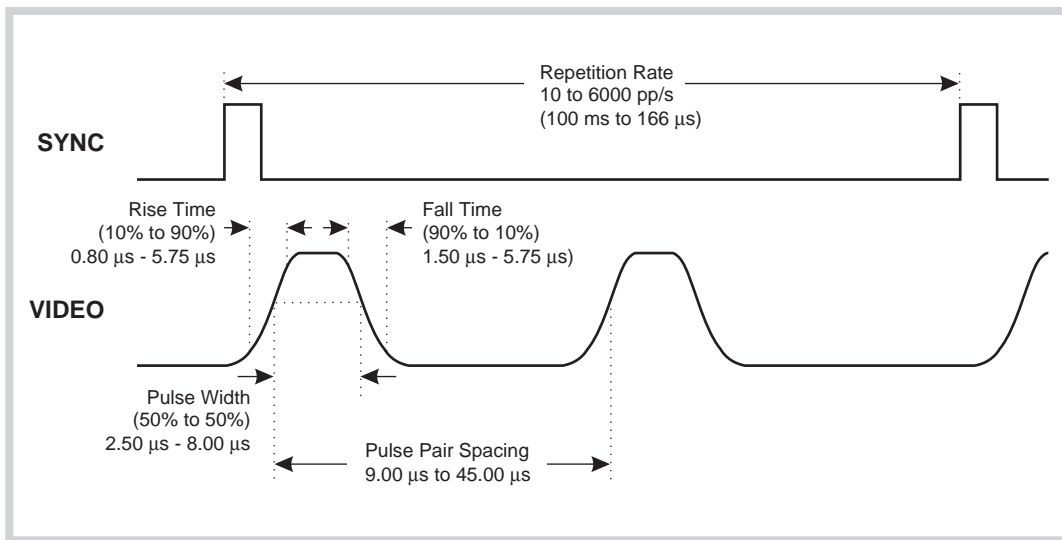

C2641

Fig. E-2 Pulse definitions - DME, internal mode

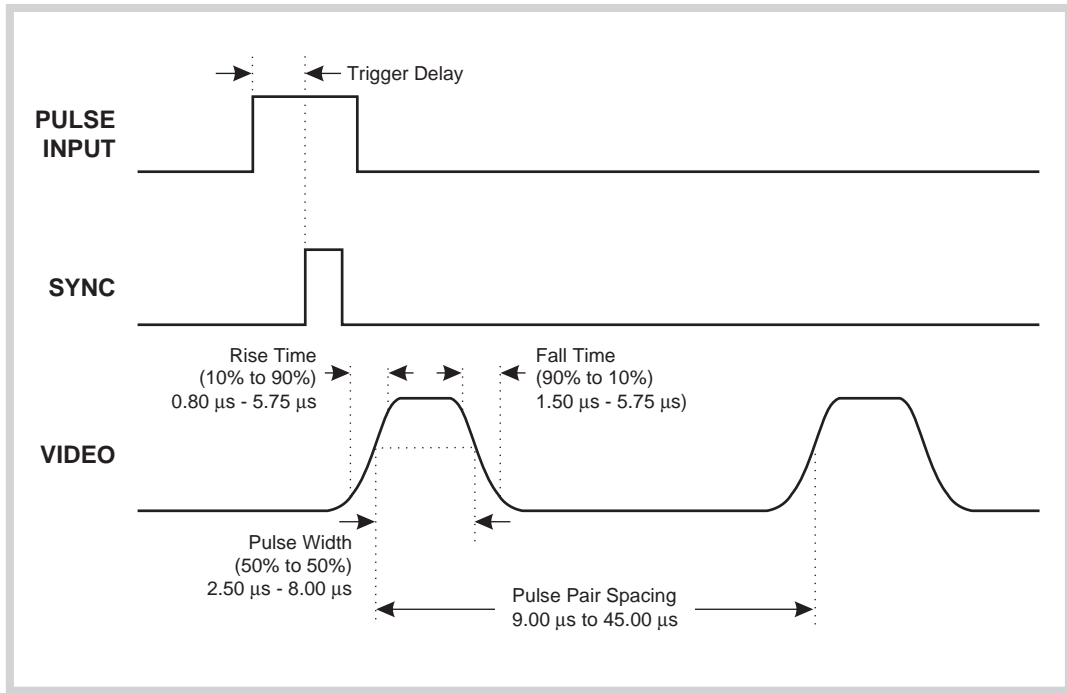

C2642

Fig. E-3 Pulse definitions - DME, external mode

DME pulse modulator

The gaussian shaped pulses from the generator can be used to modulate an RF carrier. A standard pulse modulator is in effect a switch, with the carrier being either enabled or disabled by the modulating signal. However, the DME modulator must be able to control the level of the RF signal at any particular time, and must have an ON/OFF ratio of at least 80 dB.

In order to fully meet the specifications of the DME radar system, 26 dB of linear control is required. After this control the RF signal can be 'killed' to meet the ON/OFF ratio specification, although the more linear the modulator, the more gaussian shaped the RF spectrum will be.

Fourier analysis on gaussian pulse modulation with a cut-off at 3 % of maximum amplitude (approx. -30dB), shows that 99% of energy should be contained within a 0.5 MHz bandwidth, centred on the carrier frequency. This figure is based on 2.5 μs rise and fall times. With times less than 1 μs the pulse bandwidth tends towards 0.5 MHz, and the energy figure falls dramatically.

PERFORMANCE DATA

A 2030 fitted with Option 010 conforms to the 2030 specification when in DME mode, with the following exceptions:

GENERATOR

Pulse characteristic	Double pulses, gaussian shaped
Pulse width range	2.50 μs to 8.00 μs
Rise time range	0.80 μs to 5.75 μs

Fall time range	1.50 μ s to 5.75 μ s
Pulse pair spacing range	9.00 μ s to 45.00 μ s
Repetition rate range	10 pp/s to 6000 pp/s (100 ms to 166.65 μ s)
Resolution (all above ranges)	0.05 μ s
Selection method	Keyboard or [\uparrow] and [\downarrow] keys at currently selected step size

MODULATOR

Frequency range	960 MHz to 1215 MHz
Level range	+10dBm to -110dBm in 0.1 dB steps
Level accuracy	Standard mode \pm 0.5 dB (\pm 1.5 dB)
ON - OFF ratio	> 80 dB
Pulse pair level accuracy	\pm 0.5 dB

DME OPERATION

Introduction

This section explains how to use Option 010 when fitted to a 2030 Signal Generator. Familiarity with the normal operation of the instrument is assumed.

Note...

When connecting the VIDEO and/or PULSE INPUT connectors to external equipment, a double screened coaxial cable should be used in order for the instrument to conform to EMC requirements.

Front panel

The front panel of the instrument fitted with Option 010 differs from the basic instrument as follows:

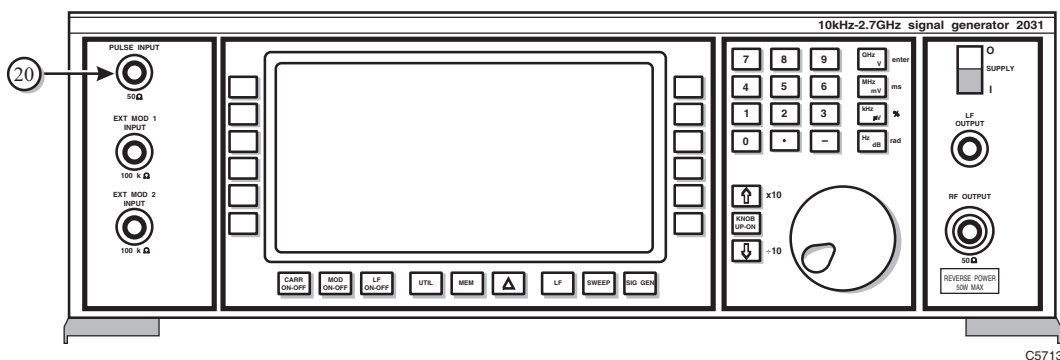

Fig. E-4 2031 front panel with Option 010

- (20) PULSE INPUT 50 Ω BNC socket accepts a pulsed signal to trigger the pulse generator or to directly control the pulse modulator (Option 002):TTL.

Rear panel

The rear panel of the instrument fitted with Option 010 differs from the basic instrument as follows:

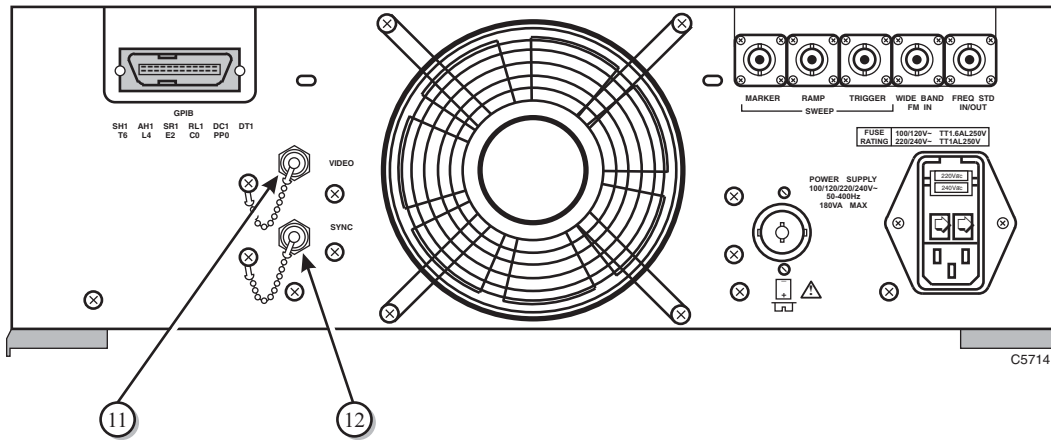
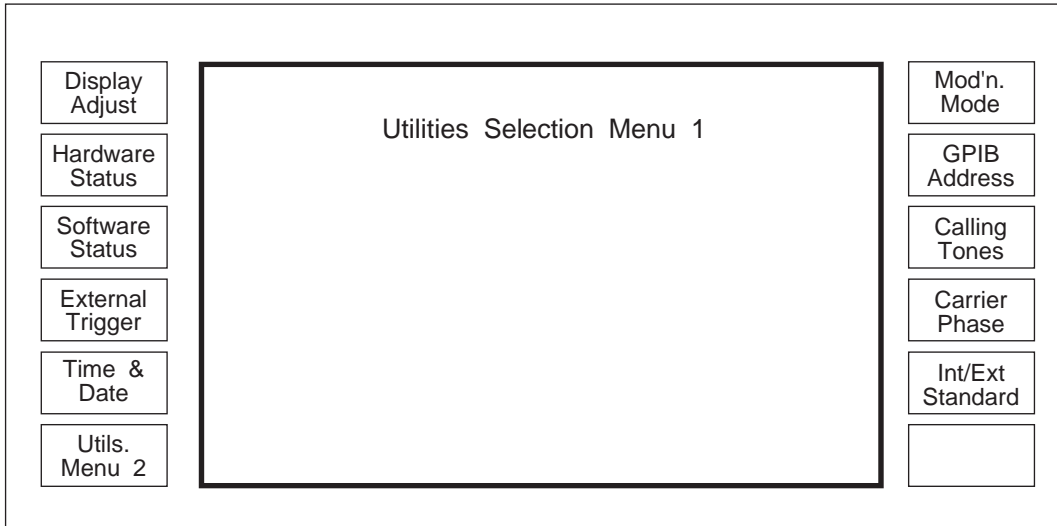

Fig. E-5 2031 rear panel with Option 010

- (11) VIDEO 50 Ω BNC socket provides the video output signal of the internal pulse generator. When used for pulse modulation this signal is synchronous with the RF pulse:TTL.
- (12) SYNC 50 Ω BNC socket supplies the sync signal which indicates the start of the video signal:TTL, 400 ns wide.

Operation

DME mode is selected by pressing the [UTIL] key and selecting the *[Mod'n Mode]* key on the Utilities Selection Menu 1, shown in Fig. E-6. This enters the menu shown in Fig. E-7. Selecting *[Avionics Mode]* from this menu will result in the Avionics Mode Selection Menu shown in Fig. E-8 being displayed. Pressing the appropriate soft key will result in the instrument entering the required mode of operation; whereas pressing *[Other Modes]* returns the display to the Modulation Mode Selection Menu.



C2636

Fig. E-6 Utilities selection menu 1

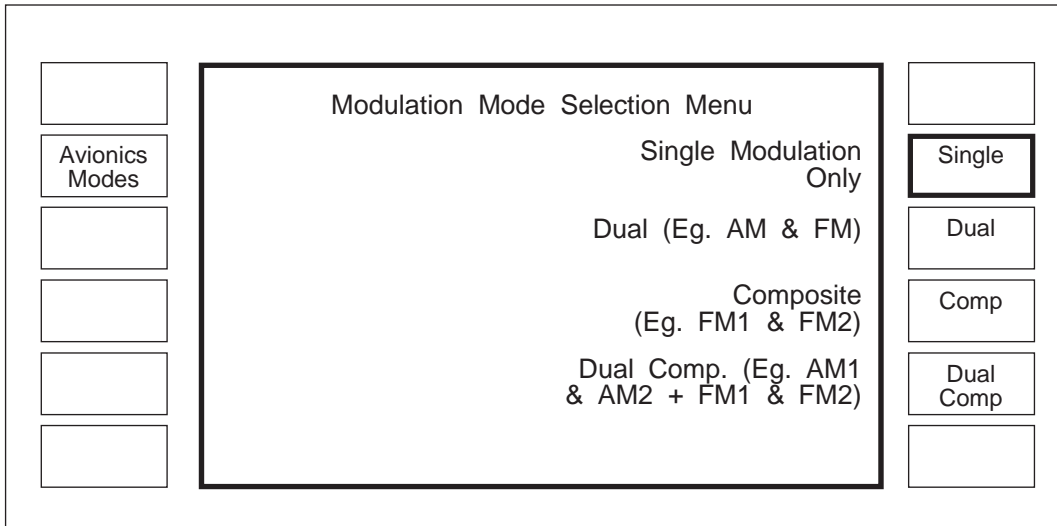

C2637

Fig. E-7 Modulation mode selection menu

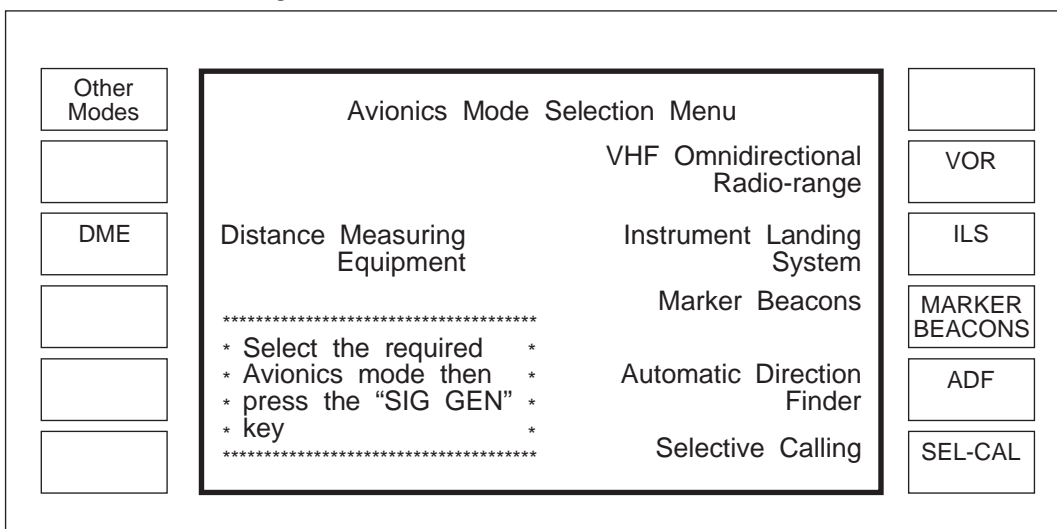

C2638

Fig. E-8 Avionics mode selection menu

Pressing [DME] followed by the [SIG GEN] key will result in the menu shown in Fig. E-9. The default carrier frequency of 1025 MHz, and default level of -110dBm are shown. RF status and frequency standard are also shown in the upper half of the display, whilst current settings (default values) for DME are shown in the lower half of the display.

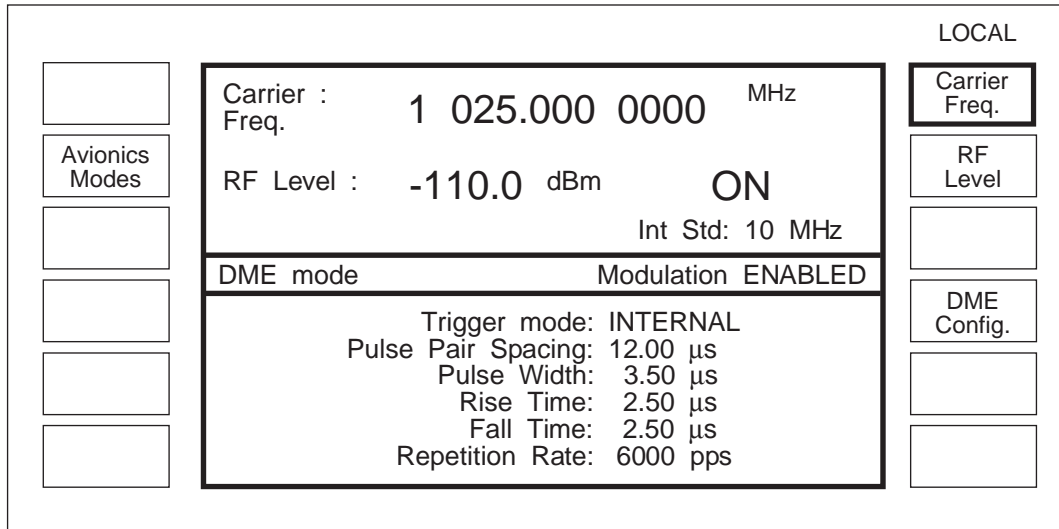

C2639

Fig. E-9 DME status menu

Pressing [DME Config.] will result in the menu shown in Fig. E-10. The various pulse settings can now be altered by pressing the appropriate key and either entering the new value or pressing the arrow keys [↑] and [↓]. *Step Size* sets the amount the highlighted parameter will be changed when the arrow key is pressed.

When parameters are changed, the pulse shape is likely to become non-gaussian. If this is the case, an error message will appear in the top portion of the screen. If the parameters set lead to an illegal pulse i.e. the pulse width is less than the sum of the rise and fall times or the sum of the pulse width, rise time and fall time is greater than the pulse pair spacing, then the outputs are disabled and a suitable message displayed. Outputs are disabled until a legal pulse (gaussian shaped, or not) can be derived from the parameters set.

An additional soft-key [*Select Gaussian*] is available, which changes rise and fall times to values which give a gaussian shaped pulse. This is very useful if the outputs have been disabled due to incorrect pulse parameters being set. In this situation, the [*Select Gaussian*] key is pressed, and the outputs will be re-enabled with legal gaussian parameters set. The instrument uses the pulse width as the basis for re-generating the gaussian pulse.

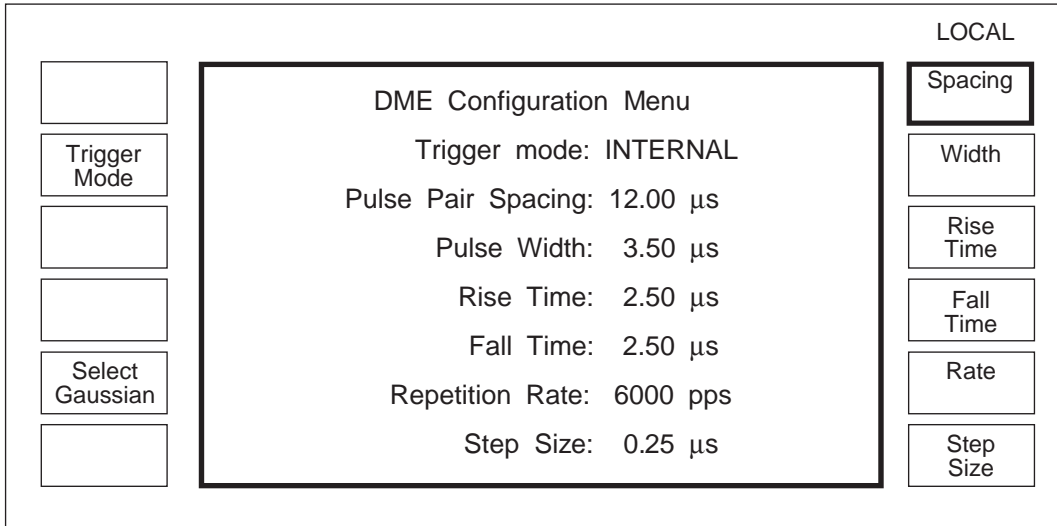

C2640

Fig. E-10 DME selection menu

The [*Trigger Mode*] key is used to toggle between internally generated pulses, and externally generated trigger. The external trigger input (PULSE INPUT on the front panel) presents a 50 Ω load, so the trigger source must be capable of driving TTL levels into 50 Ω .

Pressing [MOD ON-OFF] will disable the pulse modulator and cause an un-modulated RF signal at the currently set level to appear at the RF output. Pressing [CARR ON-OFF] will disable all RF output.

GPIB OPERATION

MODE	Set DME mode (in addition to existing modulation mode commands)
	Data type: Character Program Data
	Allowed suffices: None
	Default suffix: None
	Example: <code>MODE DME</code>
MODE?	Prepares message containing information on Modulation Mode in the following format: :MODE <mode>
	Example: <code>:MODE DME</code>

DME (Distance Measuring Equipment) mode

DME	[not used alone]
:TRIGGER	Select trigger mode
	Data type: Character Program Data (INTERNAL or EXTERNAL)
	Allowed suffices: None
	Default suffix: None
	Example: <code>DME:TRIGGER INTERNAL</code> <code>DME:TRIGGER EXTERNAL</code>
:GAUSSIAN	Format true gaussian pulses
	Data type: None
	Allowed suffices: None
	Default suffix: None
	Example: <code>DME:GAUSSIAN</code>
:PPS	Set DME pulse pair spacing
	Data type: Decimal Numeric Program Data
	Allowed suffices: Any one of: ms, us, ns
	Default suffix: ns
	Example: <code>DME:PPS 12US</code>
:WIDTH	Set DME pulse width
	Data type: Decimal Numeric Program Data
	Allowed suffices: Any one of: ms, us, ns
	Default suffix: ns
	Example: <code>DME:WIDTH 3.5US</code>
:RISE	Set DME pulse time

Data type: Decimal Numeric Program Data
Allowed suffices: Any one of: ms, us, ns
Default suffix: ns

Example: DME:RISE 2.5US

:FALL Set DME pulse fall time

Data type: Decimal Numeric Program Data
Allowed suffices: Any one of: ms, us, ns
Default suffix: ns

Example: DME:WIDTH 2.5US

:RATE Set DME pulse pairs/second

Data type: Decimal Numeric Program Data
Allowed suffices: None
Default suffix: None

Example: DME:RATE 6000

DME? Prepares message containing information on the DME configuration in the following format:

DME:TRIGGER<status>;PPS<nr1>;WIDTH<nr1>;RISE<nr1>;
FALL<nr1>;RATE<nr1>

where:<status> is a program mnemonic indicating whether the trigger is INTERNAL or EXTERNAL.

Examples: :DME:TRIGGER INTERNAL;PPS 12000;WIDTH 3500;RISE 2500;
FALL 2500;RATE 6000

:DME:TRIGGER EXTERNAL;PPS 24000;WIDTH 4000;RISE 2850;
FALL 2850

ACCEPTANCE TESTING

Introduction

The test procedures in this section enable you to verify that the electrical performance of the signal generator complies with the performance data given earlier. All tests may be performed with the instrument covers in place and should be carried out in the order given. For convenience the test equipment and specification for each test are summarized before the test procedure. These tests are in addition to those specified in Chapter 5 of the manual.

Before starting each test, use the [MEM] function to recall memory number 50. This will restore the instrument to factory default settings, and ensure that the following tests are carried out with the correct settings.

Test equipment

The test equipment recommended for acceptance testing is shown in Table E-1. Alternative equipment may be used providing it complies with the stated minimum performance.

Table E-1 Recommended test equipment

TEST EQUIPMENT		
Description	Minimum specification	Example
Spectrum analyser	DC to 1.5 GHz 3 MHz resolution bandwidth 3 MHz video filter 20 μ s sweep time (zero span)	IFR 2392
Oscilloscope	60 MHz 50 Ω inputs or 50 Ω feed-throughs	Philips PM3055
Pulse generator	1 MHz Capable of driving 50 Ω load	Hewlett Packard 8012B
Power meter	-30 dBm to +10 dBm with power sensor	IFR 6960B+6910

Pulse generator

TEST EQUIPMENT		
Description	Minimum specification	Example
Oscilloscope	60 MHz 50 Ω inputs or 50 Ω feed-throughs	Philips PM3055
Pulse generator	1 MHz Capable of driving 50 Ω load	Hewlett Packard 8012B

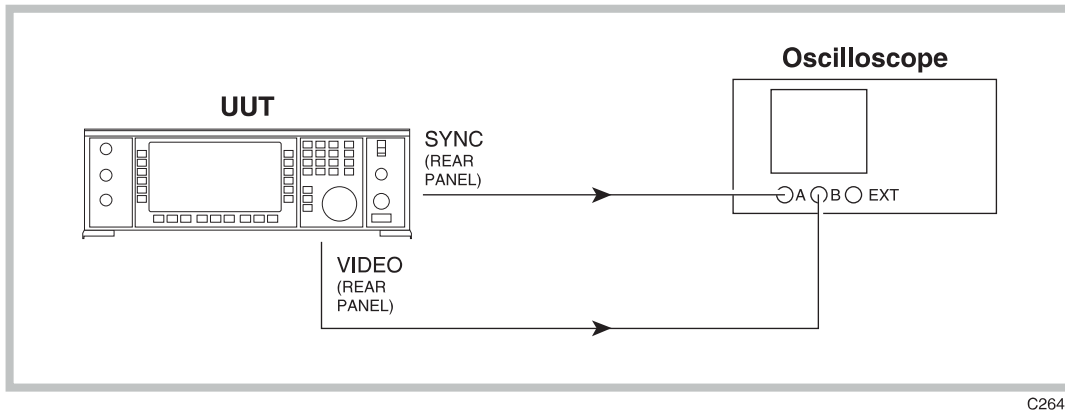

C2644

Fig. E-11 Pulse generator functional test set-up; continuous mode

- (1) Connect the test equipment as shown in Fig. E-11.
- (2) Set up the equipment as follows:

Unit under test:

Modulation mode	Avionics, DME
-----------------	---------------

Oscilloscope:

A & B volts/div	1 V DC
-----------------	--------

Timebase	1 μ s/div
----------	---------------

Trigger	A
---------	---

Pulse generator:

Continuous square wave

Period	100 μ s
--------	-------------

Level OFF / ON	0 V / 5 V into 50 Ω
----------------	----------------------------

- (3) The oscilloscope will display the traces shown in Fig. E-12a. The SYNC pulse width should be 400 ns. The VIDEO pulse should be gaussian shaped, with pulse width of 3.50 μ s and rise and fall times of 2.50 μ s. Amplitudes should be +2.5 V for both SYNC and VIDEO, providing the oscilloscope has 50 Ω inputs, or 50 Ω feed-throughs are used. High impedance inputs will produce nominal amplitudes of +5 V.

Reducing the timebase to minimum will show the rise time of the sync pulse. This is typically <2 ns.

Increasing the timebase to 20 μ s/div will produce the display shown in Fig. E-12b. Default values are 6000 pps (166 μ s) for the repetition rate and 12 μ s for the pulse pair spacing.

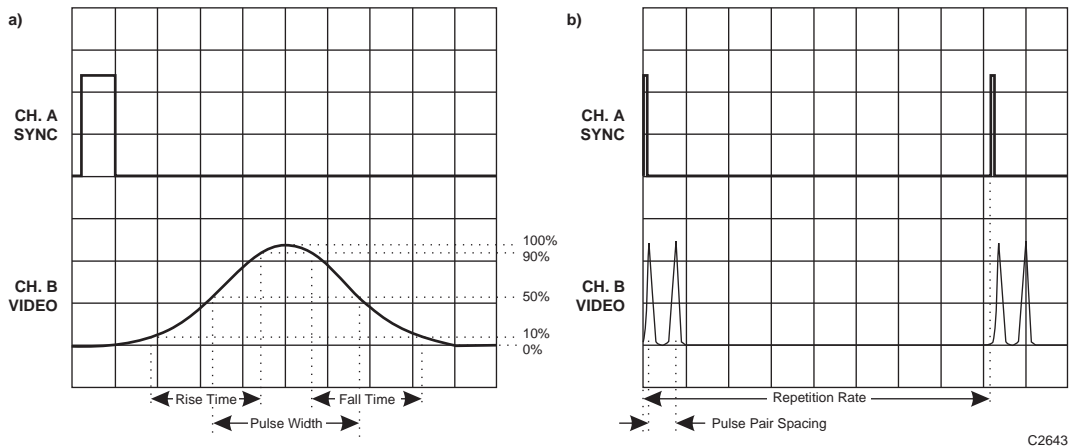

Fig. E-12 Oscilloscope traces for SYNC and VIDEO outputs

- (4) Press [DME Config.] and change the pulse pair spacing to 9 μ s. A message **ERROR 141: Pulse Profile Not Valid** will be displayed, and the outputs will be disabled. This is because the two gaussian pulses are now overlapping.

Note: The same will occur if:

- (i) The rise or fall times are increased without increasing the pulse width,
- (ii) The pulse width is increased without increasing the pulse pair spacing.

- (5) Press [Select Gaussian] and the pulse pair spacing will be automatically adjusted until valid gaussian pulse can be generated. The outputs are then re-enabled.

Note: If the rise or fall times, or the pulse width entered causes an invalid profile, the [Select Gaussian] key will automatically adjust the pulse width until a valid gaussian pulse can be generated.

- (6) Connect the test equipment as shown in Fig. E-13.

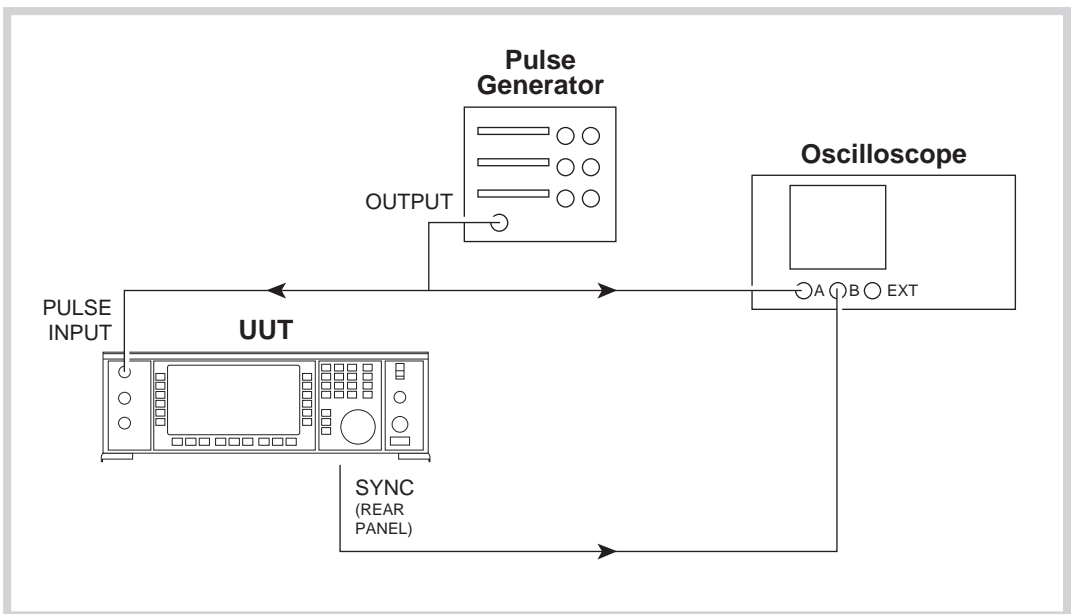
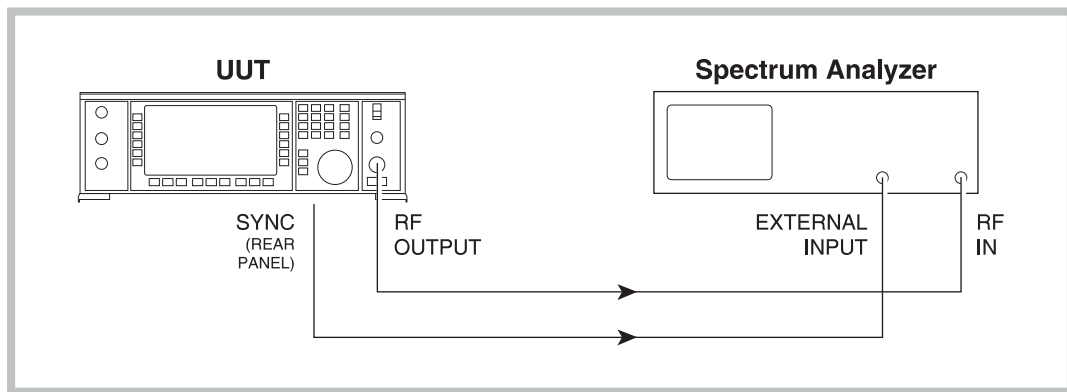

Fig. E-13 Pulse generator functional test set-up; external trigger

- (7) Under the DME Configuration Menu, toggle [Trigger Mode] to **EXTERNAL**. The oscilloscope will now display the same trace as in Fig. E-12b, except that the repetition rate should be the same as the external pulse generator period (100 μ s). Varying the external pulse period should produce a corresponding change in repetition rate.

DME pulse modulator

TEST EQUIPMENT		
Description	Minimum specification	Example
Spectrum analyser	DC to 1.5 GHz 3 MHz resolution bandwidth 3 MHz video filter 10 μ s sweep time (zero span)	IFR 2392



C2646

Fig. E-14 Pulse modulator functional test set-up

- (1) Connect the test equipment as shown in Fig. E-14.
- (2) **RF linearity**

Set up the equipment as follows:

Unit under test:

Modulation mode	Avionics, DME
RF level	0 dBm

Spectrum analyser:

Centre frequency	1025 MHz
Span	0 Hz
Ref level	0 dBm
Resolution bandwidth	≥ 3 MHz (30 MHz, 2392)
Video bandwidth	≥ 3 MHz (NONE, 2392)
Sweep time	1 μ s/div
Trigger mode	External
Vertical scale	Linear

The analyser should display a characteristically gaussian shaped pulse, width 3.5 μ s, rise and fall times 2.5 μ s. If the analyser has no external trigger facility, trigger mode should be set to VIDEO.

- (3) **Level accuracy**

With the equipment otherwise set up as in the previous test, set the sweep to 2 μ s/div, and the vertical scale to logarithmic, 1 dB/div. The peaks of the two pulses should have a nominal level of 0 dBm, and both peaks should have the same amplitude (± 0.5 dB). This should remain the case when the RF level is increased or decreased.

The instrument has its DME mode RF calibration carried out with modulation disabled. Press [MOD ON-OFF] key. Absolute level accuracy in this mode, measured using a calibrated power meter, should be that of the instrument in standard mode (e.g. single modulation) ± 0.5 dB.

(4) **ON/OFF ratio**

Set up the equipment as follows:

Unit under test:

Modulation mode	Avionics, DME
RF level	0 dBm
Pulse pair spacing	9 μ s (<i>Invalid Pulse</i> message displayed)
Modulation	Disabled (press [MOD ON-OFF] key)

Spectrum analyser:

Centre frequency	1025 MHz
Span	100 kHz
Ref level	0 dBm

The analyser should display an unmodulated signal at the centre frequency with an amplitude of 0 dBm. Press the [MOD ON-OFF] key, and the signal level should fall to less than -80 dBm.

Note: depending on the analyser used, it may be necessary to reduce the reference level or input attenuation in order to lower the noise floor of the analyser to less than -80 dBm.

Repeat the above process with the unit under test and analyser frequencies set to 960 MHz and 1215 MHz. The ON/OFF ratio should not be less than 80 dB.

INDEX

A

Accessories 1-14
Adjusting the display 3-41
ALC 3-23
Alternative tone standards 3-27, 3-31
Amplitude modulation 3-18
Avionics option B-1

B

Battery replacement 2-8
Beryllia v

C

Calibration 1-4, 3-44
Calibration due date 5-29
Carrier frequency 3-13
Carrier frequency accuracy 5-8
Carrier frequency offset 5-22
Carrier phase adjustment 3-42
Choice of units 3-13
Class I power cords (3-core) 2-2
Cleaning 2-10
Cleaning the LCD window 2-10
Connecting to supply 2-5
Continuous tone signalling 3-27
Control knob 3-5, 3-12
Conventions 3-4

D

Declaration of conformity 1-15
Default settings 3-8
Device dependent commands 3-8
Disconnecting device 2-5
Display 1-2
Display adjust 3-41
Display blanking 3-46
Displaying shifts 3-33
DME modulator Annex E E-1
DTMF 3-29

E

Elapsed time 3-44
Electrical hazards iv
Electronic attenuator 1-12
Electronic attenuator Option Appendix D-1
Error handling 3-64
Extended hysteresis 3-49
External AM 5-17
External FM 5-20

External modulation 5-13
External source selection 3-22
External trigger 3-42

F

Factory default settings 3-8
Fire hazards v
First time use 3-9
Frequency hopping 3-61
Frequency modulation 3-18
Frequency standard selection 3-43
Front panel 3-4
Fuses 2-6

G

General purpose interface bus (GPIB) 2-6
GMSK Bt 0.3 Annex A A-1
Goods-in checks 2-5
GPIB address 3-42
GPIB functions 3-2
GPIB mnemonics
 *CLS 3-7
 *ESE 3-7
 *ESE? 3-7
 *ESR? 3-7
 *IDN? 3-6
 *OPC 3-6
 *OPC? 3-6
 *OPT? 3-6
 *PUD 3-6
 *PUD? 3-6
 *RST 3-6
 *SRE 3-7
 *SRE? 3-7
 *STB? 3-6
 *TRG 3-6
 *TST? 3-6
 *WAI 3-6
AM 3-18
AM? 3-18
BACKL 3-38
BLANK 3-37
CCR? 3-50
CFRQ 3-10
CFRQ? 3-10
CLS 3-50
CSE 3-50
CSE? 3-50
CSR? 3-50
CTONES 3-22
CTONES? 3-22

- DATE? 3-38
 - DCFMNL 3-19
 - DEFTRG 3-39
 - ELAPSED? 3-38
 - ERASE 3-29
 - ERROR? 3-39
 - ESE 3-50
 - ESE? 3-50
 - ESR? 3-50
 - EXTTRG 3-39
 - FM 3-16
 - FM? 3-16
 - FSTD 3-37
 - FSTD? 3-37
 - HCR? 3-50
 - HOPSEQ 3-36
 - HOPSEQ? 3-36
 - HSE 3-44, 3-50
 - HSE? 3-44, 3-50
 - HSR? 3-50
 - IMODE 3-10, 3-30, 3-37
 - INTF1 3-21
 - INTF1? 3-21
 - KLOCK 3-39
 - KUNLOCK 3-39
 - LF 3-26
 - LF? 3-26
 - LFGF 3-27
 - LFGF? 3-27
 - LFGL 3-28
 - LFGL? 3-28
 - MOD 3-15
 - MOD? 3-15
 - MODE 3-14
 - MODE? 3-14
 - OPER? 3-38
 - PM 3-17
 - PM? 3-17
 - PULSE 3-20
 - PULSE? 3-20
 - RCL 3-29
 - RFLV 3-11
 - RFLV? 3-12, 3-13
 - RPPR 3-37
 - SCR? 3-50
 - SEQT 3-23
 - SEQT? 3-25
 - SRE 3-50
 - SRE? 3-50
 - SSE 3-50
 - SSE? 3-50
 - SSR? 3-50
 - STB? 3-50
 - STO 3-29
 - SWEEP 3-30, 3-34, 3-35
 - SWEEP? 3-31, 3-34
 - TIME? 3-38
 - WBFM 3-19
 - WBFM? 3-19
 - GPIB operation 3-1
- H**
- Hardware information 3-41
 - Hazard symbols iv
 - High output power option Appendix C C-1
- I**
- IEEE 488.2 3-2
 - IEEE to IEC conversion 2-7
 - Incrementing 3-33
 - Interface bus connection 2-8
 - Internal AM depth and distortion 5-15
 - Internal FM deviation 5-18
 - Internal phase modulation 5-23
 - Internal source selection 3-20
- K**
- Keyboard locking 3-46
- L**
- Last complete check date 5-28
 - Latch data 3-44
 - LF generator 3-54
 - LF level units 3-48
 - LF monitor 3-53
 - LF operation 3-53
 - LF output 3-53, 5-11
 - LF phase 3-21
 - Lithium batteries v
 - Locking and unlocking 3-45
 - Low intermodulation 3-23
- M**
- Main features 1-2
 - Markers 3-37
 - Memory 3-55
 - Recall 3-55
 - Store 3-58
 - Menus 3-7
 - Modulation 3-11, 3-14
 - Modulation ALC 3-23
 - Modulation modes 3-15
 - Modulation oscillator 5-9
- N**
- Number of steps 3-37
- O**
- Option 001 Second LF oscillator Appendix A A-1

Option 002 Pulse modulation Appendix B B-1
Option 003 High output power Appendix C C-1
Option 005 GMSK Bt 0.3 Annex A A-1
Option 006 Avionics Annex B B-1
Option 008 RF profiles and complex sweep Annex C C-1
Option 009 Pulse generator Annex D D-1
Option 010 DME modulator Annex E E-1
Option 012 Electronic attenuator Appendix D-1
Optional accessories 1-14
Options 1-4
Output level 3-13

P

Patent protection iii
Performance data 1-6
Phase modulation 3-18
Power up options 3-46
Program data 3-5
Program messages 3-4
Programming 3-4
Protection 1-4
Pulse generator Annex D D-1
Pulse modulation 3-24
Pulse modulation option Appendix B B-1
Putting into storage 2-10

R

Rack mounting 2-8
Real time clock battery 5-29
Rear panel 3-6
Recommended test equipment 5-3
Remote/local operation 3-5
Reverse power protection 3-14
RF level units 3-47
RF level utility 3-49
RF output 5-4
RF profiles and complex sweep Annex C C-1

Routine maintenance 2-8

S

C-Safety testing (routine) 2-8
Second modulation oscillator Appendix A A-1
Sequential calling tones 3-28
Software information 3-41
Source selection - external 3-22
Source selection - internal 3-20
Spectral purity 5-25
Status byte 3-40
Step time 3-37
Store erase 3-60
Sweep 3-34, 3-38

T

Technical description 4-1
Tilt warning vi
Time and date 3-46
Tone selection 3-27, 3-28
Tone standard editing 3-27, 3-31
Toxic hazards v

U

Utilities 3-40

V

Ventilation 2-2
Versions 1-14
Voltage selector 2-6

W

Wideband frequency modulation 3-19

AEROFLEX INTERNATIONAL LTD. SOFTWARE LICENCE AND WARRANTY

This document is an Agreement between the user of this Licensed Software, the Licensee, and Aeroflex International Limited, the Licensor. By opening this Software package or commencing to use the software you accept the terms of this Agreement. If you do not agree to the terms of this Agreement please return the Software package unopened to Aeroflex International Limited or do not use the software.

1. DEFINITIONS

The following expressions will have the meanings set out below for the purposes of this Agreement:

Add-In Application Software	Licensed Software that may be loaded separately from time to time into the Equipment to improve or modify its functionality
Computer Application Software	Licensed Software supplied to run on a standard PC or workstation
Designated Equipment	the single piece of Equipment upon which the licensed software is installed
Downloaded Software	any software downloaded from an Aeroflex web site
Embedded Software	Licensed Software that forms part of the Equipment supplied by Aeroflex and without which the Equipment cannot function
Licence Fee	the consideration ruling at the date of this Agreement for the use of one copy of the Licensed Software on the Designated Equipment
Licensed Software	All and any programs, listings, flow charts and instructions in whole or in part including Add-in, Computer Application, Downloaded and Embedded Software supplied to work with Designated Equipment

2. LICENCE FEE

The Licensee shall pay the Licence Fee to Aeroflex in accordance with the terms of the contract between the Licensee and Aeroflex.

3. TERM

This Agreement shall be effective from the date hereof and shall continue in force until terminated under the provisions of Clause 9.

4. LICENCE

- 4.1 Unless and until terminated, this Licence confers upon the Licensee the non-transferable and non-exclusive right to use the Licensed Software on the Designated Equipment.
- 4.2 The Licensee may not use the Licensed Software on other than the Designated Equipment, unless written permission is first obtained from Aeroflex and until the appropriate additional Licence Fee has been paid to Aeroflex.
- 4.3 The Licensee may not amend or alter the Licensed Software and shall have no right or licence other than that stipulated herein.
- 4.4 The Licensee may make not more than two copies of the Licensed Software (but not the Authoring and Language Manuals) in machine-readable form for operational security and shall ensure that all such copies include Aeroflex's copyright notice, together with any features which disclose the name of the Licensed Software and the Licensee. Furthermore, the Licensee shall not permit the Licensed Software or any part to be disclosed in any form to any third party and shall maintain the Licensed Software in secure premises to prevent any unauthorised disclosure. The Licensee shall notify Aeroflex immediately if the Licensee has knowledge that any unlicensed party possesses the Licensed Software. The Licensee's obligation to maintain confidentiality shall cease when the Licensed Software and all copies have been destroyed or returned. The copyright in the Licensed Software shall remain with Aeroflex. The Licensee will permit Aeroflex at all reasonable times to audit the use of the Licensed Software.
- 4.5 The Licensee will not disassemble or reverse engineer the Licensed Software, nor sub-licence, lease, rent or part with possession or otherwise transfer the whole or any part of the Licensed Software.

5. WARRANTY

- 5.1 Aeroflex certifies that the Licensed Software supplied by Aeroflex will at the time of delivery function substantially in accordance with the applicable Software Product Descriptions, Data Sheets or Product Specifications published by Aeroflex.
 - 5.2 The warranty period (unless an extended warranty for Embedded Software has been purchased) from date of delivery in respect of each type of Licensed Software is:

Embedded Software	12 months
Add-In Application Software	90 days
Computer Application Software	90 days
Downloaded Software	No warranty
 - 5.3 If during the appropriate Warranty Period the Licensed Software does not conform substantially to the Software Product Descriptions, Data Sheets or Product Specifications Aeroflex will provide:
 - 5.3.1 In the case of Embedded Software and at Aeroflex's discretion either a fix for the problem or an effective and efficient work-around.
 - 5.3.2 In the case of Add-In Application Software and Computer Application Software and at Aeroflex's discretion replacement of the software or a fix for the problem or an effective and efficient work-around.
 - 5.4 Aeroflex does not warrant that the operation of any software will be uninterrupted or error free.
-

6 The above Warranty does not apply to:

- 6.1 Defects resulting from software not supplied by Aeroflex, from unauthorised modification or misuse or from operation outside of the specification.
- 6.2 Third party produced Proprietary Software which Aeroflex may deliver with its products, in such case the third party Software Licence Agreement including its warranty terms shall apply.
- 7 The remedies offered above are sole and exclusive remedies and to the extent permitted by applicable law are in lieu of any implied conditions, guarantees or warranties whatsoever and whether statutory or otherwise as to the software all of which are hereby expressly excluded.

8. INDEMNITY

- 8.1 Aeroflex shall defend, at its expense, any action brought against the Licensee alleging that the Licensed Software infringes any patent, registered design, trademark or copyright, and shall pay all Licensor's costs and damages finally awarded up to an aggregate equivalent to the Licence fee provided the Licensee shall not have done or permitted to be done anything which may have been or become any such infringement and shall have exercised reasonable care in protecting the same failing which the Licensee shall indemnify Aeroflex against all claims costs and damages incurred and that Aeroflex is given prompt written notice of such claim and given information, reasonable assistance and sole authority to defend or settle such claim on behalf of the Licensee. In the defence or settlement of any such claim, Aeroflex may obtain for the Licensee the right to continue using the Licensed Software or replace it or modify it so that it becomes non-infringing.
- 8.2 Aeroflex shall not be liable if the alleged infringement:
 - 8.2.1 is based upon the use of the Licensed Software in combination with other software not furnished by Aeroflex, or
 - 8.2.2 is based upon the use of the Licensed Software alone or in combination with other software in equipment not functionally identical to the Designated Equipment, or
 - 8.2.3 arises as a result of Aeroflex having followed a properly authorised design or instruction of the Licensee, or
 - 8.2.4 arises out of the use of the Licensed Software in a country other than the one disclosed to Aeroflex as the intended country of use of the Licensed Software at the commencement of this Agreement.
- 8.3 Aeroflex shall not be liable to the Licensee for any loss of use or for loss of profits or of contracts arising directly or indirectly out of any such infringement of patent, registered design, trademark or copyright.

9. TERMINATION

- 9.1 Notwithstanding anything herein to the contrary, this Licence shall forthwith determine if the Licensee:
 - 9.1.1 As an individual has a Receiving Order made against him or is adjudicated bankrupt or compounds with creditors or as a corporate body, compounds with creditors or has a winding-up order made against it or
 - 9.1.2 Parts with possession of the Designated Equipment.
- 9.2 This Licence may be terminated by notice in writing to the Licensee if the Licensee shall be in breach of any of its obligations hereunder and continue in such breach for a period of 21 days after notice thereof has been served on the Licensee.
- 9.3 On termination of this Agreement for any reason, Aeroflex may require the Licensee to return to Aeroflex all copies of the Licensed Software in the custody of the Licensee and the Licensee shall, at its own cost and expense, comply with such requirement within 14 days and shall, at the same time, certify to Aeroflex in writing that all copies of the Licensed Software in whatever form have been obliterated from the Designated Equipment.

10. THIRD PARTY LICENCES

The software or part thereof may be the proprietary property of third party licensors. In such an event such third party licensors (as referenced on the package or the Order Acknowledgement) and/or Aeroflex may directly enforce the terms of this Agreement and may terminate the Agreement if the Licensee is in breach of the conditions contained herein.

11. EXPORT REGULATIONS

The Licensee undertakes that where necessary the Licensee will conform with all relevant export regulations imposed by the Governments of the United Kingdom and/or the United State of America.

12. NOTICES

Any notice to be given by the Licensee to Aeroflex shall be addressed to:

Aeroflex International Limited, Longacres House, Six Hills Way, Stevenage, SG1 2AN, UK.

13. LAW AND JURISDICTION

This Agreement shall be governed by the laws of England and shall be subject to the exclusive jurisdiction of the English courts. This agreement constitutes the whole Contract between the parties and may be changed only by memorandum signed by both parties.

© AEROFLEX INTERNATIONAL LTD 2004

**CHINA Beijing**

Tel: [+86] (10) 6539 1166
Fax: [+86] (10) 6539 1778

CHINA Shanghai

Tel: [+86] (21) 5109 5128
Fax: [+86] (21) 5150 6112

FINLAND

Tel: [+358] (9) 2709 5541
Fax: [+358] (9) 804 2441

FRANCE

Tel: [+33] 1 60 79 96 00
Fax: [+33] 1 60 77 69 22

GERMANY

Tel: [+49] 8131 2926-0
Fax: [+49] 8131 2926-130

HONG KONG

Tel: [+852] 2832 7988
Fax: [+852] 2834 5364

INDIA

Tel: [+91] 80 5115 4501
Fax: [+91] 80 5115 4502

KOREA

Tel: [+82] (2) 3424 2719
Fax: [+82] (2) 3424 8620

SCANDINAVIA

Tel: [+45] 9614 0045
Fax: [+45] 9614 0047

SPAIN

Tel: [+34] (91) 640 11 34
Fax: [+34] (91) 640 06 40

UK Burnham

Tel: [+44] (0) 1628 604455
Fax: [+44] (0) 1628 662017

UK Stevenage

Tel: [+44] (0) 1438 742200
Fax: [+44] (0) 1438 727601
Freephone: 0800 282388

USA

Tel: [+1] (316) 522 4981
Fax: [+1] (316) 522 1360
Toll Free: (800) 835 2352

As we are always seeking to improve our products, the information in this document gives only a general indication of the product capacity, performance and suitability, none of which shall form part of any contract. We reserve the right to make design changes without notice.

web www.aeroflex.com

Email info-test@aeroflex.com

November 2005