

PHILIPS

Regulated D.C. Power Supply

PE 1647

Operating manual

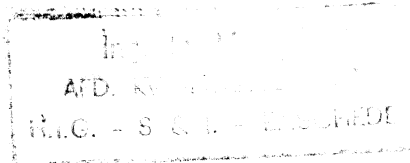
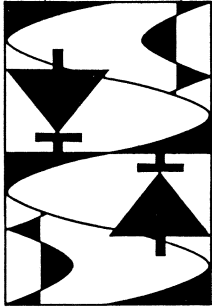

9499 150 09801

780620



Contents

1.	GENERAL	9
1.1.	Introduction	9
1.2.	Characteristics	9
1.2.1.	Technical data	10
1.2.2.	Environmental data	11
1.2.3.	Mechanical data	12
1.3.	Accessories	12
1.3.1.	Optional accessories	12
2.	DIRECTIONS FOR USE	13
2.1.	Installation	13
2.1.1.	Dismantling	13
2.1.2.	Earthing	13
2.1.3.	Overvoltage protection	14
2.1.4.	Remote sensing	14
2.1.5.	Remote on/off and off switching	15
2.1.6.	Programming the output voltage	15
2.1.7.	Programming the output current	15
2.1.8.	Series connection	16
2.1.9.	Parallel connection	16
2.1.10.	Combined facilities	17
2.1.11.	Load	17
2.1.12.	Mains connection	17
2.1.13.	Controls, indicators and terminals	18
2.2.	Operation	19
2.2.1.	Mains	19
2.2.2.	Output voltage	19
2.2.3.	Output current	19
2.2.4.	Overvoltage protection	19
2.2.5.	Thermal protection	19

List of figures

Fig. 1.	Front view	42
Fig. 2.	Rear view	42
Fig. 3.	Bottom view (bottom plate removed)	43
Fig. 4.	Top view (top plate removed)	43
Fig. 5.	Current-voltage characteristic	44
a.1.	Dynamic current fold-back characteristic for a load step change starting at $V_o = 75 \text{ V}$	44
a.2.	Dynamic current fold-back characteristic for a load step change starting at $V_o = 60 \text{ V}$	44
b.1.	Current source behaviour starting at $V_o = 75 \text{ V}$ with $\frac{dV}{dt} \leq -500 \text{ V/s}$	45
b.2.	Current source behaviour starting at $V_o = 60 \text{ V}$ with $\frac{dV}{dt} \leq -500 \text{ V/s}$	45
Fig. 6.	Transient recovery-time characteristic	45
Fig. 7.	Connecting the stabiliser for:	46
a.	Normal use	
b.	Remote sensing	
c.	Remote voltage control with external voltage	
d.	Remote voltage control with a resistor	

PHILIPS

Operating manual
Bedienungsanleitung
Notice d'emploi



REGULATED D.C. POWER SUPPLY
STABILISIERTES SPEISEGERÄT
ALIMENTATION STABILISÉE

PE 1647



9499 150 09801

780620

- e. Remote current control with external voltage
- f. Remote current control with a resistor
- g. Remote ON/OFF with a switch
- h. Remote "OFF"
- i. Series connection according to "Master-Slave" system
- j. Parallel connection according to "Master-Slave" system
- k. Combination of facilities given in Fig. 7d - 7g - 7i
- l. Combination of facilities given in Fig. 7b - 7d - 7f - 7g - 7j

Fig. 8. Circuit diagram

1. General

1.1. INTRODUCTION

The PE 1647 is a 1050 W stabilized power supply designed for supplying and testing electrical and electronic circuits.

Normally, the power supply is intended for 19-in rack mounting, but it can be adapted for use as a table-top version.

Regulation is achieved in two stages; a thyristor pre-regulator and a transistor series-regulator stage.

By means of thyristor pre-regulator optimum efficiency can be obtained and a favourable relation between dimensions and delivered power is achieved.

The transistor series-regulator gives continuously variable adjustment of the output voltage and current with good accuracy and stability with minimum ripple.

By means of coarse and fine controls, the output voltage can be continuously varied between 0 V and 75 V.

Similarly, coarse and fine controls, provided continuously variable output current between 0 A and 14 A.

In addition, the instrument has continuously variable over-voltage protection between 1 V and a value higher than 75 V.

Front-panel LED indicators (green) show whether the instrument is functioning as a constant-voltage source or as a constant current source.

A LED indicator (red) lights if the pre-selected over-voltage protection level has been reached (OVERVOLTAGE FAILURE), or the thermal protection or the overcurrent protection (14,32 A) is operating.

Two front-panel meters provide a visual indication of the stabilized output voltage and current.

The load can be connected either to the front-panel terminals or to the terminals at the rear of the instrument.

These connecting pins are floating with respect to earth, but either the + or the – terminal can be linked to the adjacent earth.

If a larger continuously adjustable voltage or current source is required than is available from one instrument, then instruments can be connected in series or parallel to provide increased power.

By means of the terminal block at the rear of the instrument, the following possibilities are available:

- series and parallel connection of instruments in accordance with "Master-Slave" systems;
- remote sensing to stabilise the output direct at the load. Any excessive output due to disconnection or changing of the load conductors or sensing conductors is also prevented;
- programming the value of the output voltage by means of an external resistance or an external voltage;
- programming the value of the output current by means of an external resistance or an external voltage;
- switching the output voltage from zero to the adjusted value, and from the adjusted value to zero by means of an external auxiliary contact;
- switching the output voltage to zero by means of an external voltage, whereupon the output voltage will remain at zero until the instrument is switched off and switched on again;
- a combination of the above possibilities.

NOTE: The design of this instrument is subject to continuous development and improvement.

Consequently, this instrument may incorporate minor changes in detail from the information contained in this manual.

1.2. CHARACTERISTICS

This instrument has been designed in accordance with IEC Publication 348 for Class I instruments and has been supplied in a safe condition. The present Instruction Manual contains information and warnings which shall be followed by the purchaser to ensure safe operation and to retain the instrument in a safe condition.

1.2.1. Technical data

1.2.1.1. General

Safety	In accordance with IEC 348, Safety Class 1
Isolation testvoltage	2100 V d.c. between primary and chassis 4200 V d.c. between primary and secondary 2100 V d.c. between secondary and chassis
Output terminals	Floating with respect to earth. The maximum permissible d.c. voltage between any one of the output terminals and chassis is 250 V. The "+" or "-" terminal may be connected to the chassis, if desired.
Radio interference	According to VDE 0875 below the N curve.

1.2.1.2. Input

A.C. voltage	110-220-240 V (+ or - 10 %)
Frequency	50 to 60 Hz
Consumption	2500 VA
Inrush current	< 100 A peak at 220 V mains
Efficiency	81 % at nominal mains voltage and maximum output power
Protection	- Primary, with fuses F1, F2 and F3 - Thermal fuses in transformer T27 - Thermal protection in transformer T26

1.2.1.3. Output

a. As d.c. voltage stabiliser

Range	0 to 75 V, continuously adjustable by coarse adjustment R1. This coarse control can be varied by 0,75 V using fine adjustment R2.
Resolution	≤ 0,2 mV
Output effects (Stability related to static operation)	
1. Line regulation	For mains voltage variations of + or - 10 % Source effect (change of output voltage for a mains voltage variation) 0.005 % of adjusted output voltage or 1 mV, whichever is the greater. Settling effect (relatively slow change of output voltage) (for a mains voltage or load variation): 0.01 % of adjusted output voltage or 1 mV, whichever is the greater.
2. Load regulation	For load variations from no load to full load and vice versa. Load effect + or - 15 mV Settling effect + or - 10 mV Note: Load effect is the immediate change of output voltage for a load variation (see IEC 478-1).
3. Temperature coefficient	0.005 % per K from the adjusted output voltage or 1 mV per K, whichever is the greater.
4. Periodic and random deviation (PARD)	R.M.S. value ≤ 1 mV. The high frequency spikes are at 1,4 A output current ≤ 40 mV _{p-p} and at 14 A output current ≤ 60 mV _{p-p} . Bandwidth 50 MHz.
Dynamic operation	
1. transient recovery time	≤ 50 μs for a step change from 80 % full load to full load and vice versa, and a $\frac{di}{dt}$ of 1 A/μs (see also fig. 6.).

2. dynamic internal impedance	For sinusoidal load variations of 80 % from full load to full load and a frequency of: $1 \text{ kHz} \leq 0,005 \ \Omega$ $10 \text{ kHz} \leq 0,05 \ \Omega$ $100 \text{ kHz} \leq 0,15 \ \Omega$ $250 \text{ kHz} \leq 0,25 \ \Omega$
Protection	<ul style="list-style-type: none"> – Overvoltage protection 1 V to a value higher than 75 V continuously adjustable with R5. – Reverse voltage protection – Constant current stabiliser – Overcurrent protection – Thermal protection
b. <u>As current stabiliser</u>	
Range	0 to 14 A, continuously adjustable by coarse adjustment R3. This coarse control can be varied by 0,45 A using fine adjustment R4.
Resolution	$\leq 10 \text{ mA}$
Output effects (stability related to static operation)	
1. Line regulation	For mains voltage variations of + or – 10 %. Source effect + or – 3 mA Settling effect + or – 2 mA
2. Load regulation	For load variations from point D to point E and vice versa (see Fig. 5.). Load effect + or – 3 mA Settling effect + or – 5 mA
3. temperature coefficient	$\leq 15 \text{ mA per K}$
4. ripple current	R.M.S. value $\leq 10 \text{ mA}$ with an output terminal connected to the chassis.
Cross-over point	See point B-C-D in Fig. 5. This value applies for any set output voltage between 0 and 75 V and output current between 0 and 14 A.
c. <u>Series connection</u>	
	Instruments may be series connected until the maximum permissible d.c. voltage of 250 V is reached between an output terminal and chassis.
d. <u>Parallel connection</u>	
	An arbitrary number of instrument may be connected in parallel for greater current outputs.

1.2.2. Environmental data

The environmental data are valid only if the instrument is checked in accordance with the official checking procedures. Details on these procedures and failure criteria are supplied on request by the PHILIPS organization in your country, or by N.V. PHILIPS' GLOEILAMPENFABRIEKEN, TEST AND MEASURING DEPT., EINDHOVEN. HOLLAND.

Ambient temperature:

- rated range of operation
- storage and transit

0 to +40 °C
–40 °C to +70 °C

Cooling

Forced air cooled
The air circulation may not be impeded.

Damp heat, cyclic tests
(12 + 12 hour cycle)

21 days ambient temperature 25 °C to 40 °C at a humidity of 93 %.

Bump tests

1000 bumps at an acceleration of 100 m/s^2 , $\frac{1}{2}$ sine for 6 ms duration in each of three directions.

Vibration tests

30 min. in each of three directions 10 Hz to 150 Hz, 0.7 mm_{p-p} and 50 m/s² acceleration.

1.2.3. Mechanical data

Dimensions

— rack-mounted

Height 132 mm (3E)
Width 444 mm (19")
Depth 477 mm (without handles)

— table-model version

Height 147 mm
Width 444 mm (19")
Depth 522 mm

Mass

37 kg net
49 kg with packaging

1.3. ACCESSORIES

Operating manual

2 feet and 2 mounting screws for fixing.

2. Directions for use

2.1. INSTALLATION

On delivery, check the instrument to ascertain whether any damage has been sustained in transit. If the safety of the instrument is suspect, it must be checked by a skilled service technician before being put into use.

Rack-mounting

This instrument is normally delivered for mounting in a 19-inch rack. For rack-mounting, the holes of the top and bottom cover plates will remain free to ensure adequate cooling of the instrument. It is recommended to keep a distance of 1E (44 mm) between this instrument and higher or lower instruments.

For easy insertion and removal of the instrument when rack-mounting is adopted, it is recommended to use sliding brackets to support the instrument. In order to maintain the ambient temperature of the instrument in the rack below 40 °C, it is possible to use the Philips fan unit, type PE 1373/74 for forced-air cooling (mounting height - 1E).

Table-mounting

For installation as a table-mounted version, proceed as follows:

- slide the feet delivered into the slots B (see also Fig. 3.), and then reattach the feet by means of the mounting screws, also delivered with the instrument.
- remove the plates (necessary for 19-inch rack-mounting) in the hand-grips after unscrewing four screws M4x20 (two per hand-grip). These screws are accessible via the slots in the side panels.

WARNING: Before any connection is made, the protective earth terminal shall be connected to a protective conductor (see section 2.1.2. Earthing).

2.1.1. Dismantling

The opening of covers or removal of parts, except those to which access can be gained by hand, is likely to expose live parts and also accessible terminals may be live.

The instrument shall be disconnected from all voltage sources before any adjustment, replacement or maintenance and repair during which the instrument will be opened.

If afterwards, any adjustment, maintenance or repair of the opened instrument under voltage is inevitable, it shall be carried out only by a skilled person who is aware of the danger involved.

The replacement of parts in the primary circuit of the instrument are at the user's own risk.

After replacement of such parts (the fuse excepted) a high-voltage test in accordance with IEC Publication 348 is strongly recommended.

Bear in mind that capacitors inside the instrument may still be charged, even if the instrument has been disconnected from all voltage sources.

The rear cover-plate over terminal block X5 (for mains connection) and protection fuses F1, F2 and F3 can be removed after withdrawing the four screws M3 X6 (see Fig. 2.).

The top and bottom cover-plate of the instrument can be slid out after first removing four screws M2, 5X4.

2.1.2. Earthing

The instrument must be earthed in accordance with the local safety regulations.

To this end, the instrument must be connected to a protective earth in one of the following two ways:

- to point 1 of the terminal block X5 (see Fig.2.)
- with the earthing screw  adjacent to terminal block X5.

Terminal block X5 is accessible after removing the rear cover-plate (see section 2.1.1 Dismantling).

If a three-core mains cable with mains plus is used, the mains plug shall be inserted into a socket output provided with a protective earth contact. The protective action shall not be negated by use of an extension cord without protective conductor.

WARNING: Any interruption of the protective conductor inside or outside the instrument or disconnection of the protective earth terminal, is likely to make the instrument dangerous.
 Intentional interruption is prohibited.
 When an instrument is brought from a cold into a warm environment, condensation may cause a hazardous condition. Therefore, make sure that the earthing requirements are strictly adhered to.

2.1.3. Overvoltage protection (OVP)

By means of R5 the trip voltage of the overvoltage protection (OVP) can be continuously adjusted from 1 V to a value higher than 75 V.

When the output voltage reaches the adjusted trip voltage, this is signalled by front-panel indicator V3 (FAILURE) and the current through thyristors V68 and V69 is blocked. Consequently, no more power is delivered from the input to capacitor C42 and C50. The power that is at this instant stored in C42 and C50 is discharged into the load and the output voltage decays to zero.

2.1.4. Remote sensing

Remote sensing enables the output voltage to be stabilised directly at the load. The variation in voltage drop in the connecting wires due to varying loads can thus be compensated for. In this way, the voltage can be maintained constant at the load.

When remote sensing is applied, the load is protected against inadvertent disconnection or sense inversion of the main load conductors. When the sense wires are disconnected, for example, the voltage on the load is equal to, or less than, the adjusted voltage of the instrument. If the sense or main load conductors is changed, or the load conductors become disconnected, the OVP opens and the output goes to zero.

For remote sensing, the connections on terminal block X4, and between X4 and the load, must be wired as given in Fig. 7b.

The current-carrying wires to the load must be sufficient cross-section so that the voltage loss in each of these wires is less than 0.5 V.

Screened or twisted wires must be used for the sense wires, to minimise interference voltages.

Depending on the application, it may be useful to connect a $560 \mu\text{F} \pm 50\%$ - 100 V capacitor directly across the load for better dynamic response when applying remote sensing.

NOTE: The instrument voltmeter P1 indicates the voltage on the output terminals, which is not necessarily that on the load.

2.1.5. Remote ON/OFF and OFF switching

The output voltage can be reduced to zero either by closing an auxiliary contact or by applying an external voltage, as follows:

- a. By means of an auxiliary contact the output voltage can either be set at the value determined by R1 and R2 (contact open) or reduced to zero (contact closed).
The auxiliary contact should be wired to terminal block X4, and the connection on the terminal block should be made as given in Fig. 7g. The maximum current through this contact is 1 mA, and the maximum voltage across the switch is 10 V.
- b. By means of an external voltage, the output voltage can be reduced to zero, and will remain at zero unless the instrument is switched OFF and then switched ON again, while the external source is disconnected. The value of the external voltage necessary to reduce the output to zero must be equal to or greater than 1,5 V and must be able to supply a current of 1 mA. To avoid damage to the instrument this external voltage must not be greater than 12 V.
To prevent current flowing from the instrument to the external voltage when the output voltage is reduced to zero, a diode (e.g. type BAW 62) must be connected in series with the external switching voltage. When a diode is used, the output voltage remains at the value adjusted by R1 and R2 as long as the external switching voltage is below 1 V. For remote OFF switching the connections on terminal block X4 and between X4 and the external voltage source must be made as given in Fig. 7h.

2.1.6. Programming the output voltage

The output voltage can be programmed by means of a potentiometer or by an adjustable voltage source as follows:

- a. By connecting a 0 - 10 k Ω , 0.1 W potentiometer (rheostat) as shown in Fig. 7d, the output voltage can be adjusted between 0 and V_{out} , where V_{out} is the output voltage adjusted by R1 and R2. When the potentiometer is set to 10 k Ω , V_{out} is adjustable by means of R1 and R2 between 0 and 75 V. The value of the potentiometer, 10 k Ω is proportional to V_{out} , therefore 1 k Ω is proportional to 0.1 V_{out} . If the potentiometer is linear, then the adjusted output voltage follows linearly.
- b. By connecting an adjustable voltage source as shown in Fig. 7c, the output voltage can be adjusted externally; the internal coarse and fine control R1 and R2 are then inoperative.
With a linear external voltage source of 0 to 10 V (2/15 V per output volt) and is able to supply a current of 1 mA, the output voltage can be linearly adjusted from 0 to 75 V. To reduce the internal resistance of the instrument, it is recommended that the voltage source has an internal resistance of less than 100 Ω .
To prevent additional ripple voltage at the output terminals, the wires should be twisted or screened.

2.1.7. Programming the output current

Remote programming of the output current is possible by means of a potentiometer or an adjustable voltage source, as follows:

- a. By means of a potentiometer (Fig. 7f.).
The potentiometer has a value of approximately 72 Ω per ampere output current.
For a potentiometer of value 0 to 1 k Ω , 0.1 W, the output current is adjustable from 0 to 14 A. The internal coarse and fine current controls R3 and R4 (see Fig. 1) are inoperative.
- b. By means of an adjustable voltage source (Fig. 7e.).
For an adjustable voltage source of 0 to 0.5 V and is able to supply a current of 0.5 mA, the output current is adjustable from 0 to 14 A (i.e. 35.7 mV per ampere).
The internal coarse and fine current controls R3 and R4 (see Fig. 1.) are inoperative.
The output current is linear with the voltage source.
To eliminate extra ripple to the load, the wires from the voltage source to terminal block X4 must be twisted or screened.

NOTE: The instrument features on overcurrent protection for inadvertent disconnection of the potentiometer or the voltage source.

2.1.8. Series connection

Instruments may be series connected until the maximum permissible d.c. voltage of 250 V between any output terminal and earth is reached.

WARNING: When one of the output terminals "+" or "-" is connected to earth, the adjusted output voltage is present between the unearthed output terminal and instrument chassis.

Instruments may be connected in series in two ways:

- a. By connecting the "+" output terminal (X2 or X8) of the first instrument with the "-" output terminal (X1 or X7) of the second instrument, and so on. The voltage on the load is then the sum of the individually adjusted output voltages.
If the output voltage of any instrument exceeds its adjusted OVP trip voltage, that instrument contributes no power to the load.
The current of each instrument must be adjusted higher than the required load current, but lower than the value that could cause damage to the load.
- b. By connecting in accordance with the Master-Slave system.
The output voltage of every instrument is adjusted by means of R1 and R2 (see Fig. 1) of the "master" instrument.
No adjustment is possible by R1 and R2 of the "slave" instruments; these controls are inoperative.
When R3 and R4 (see Fig. 1) of the slave instruments are set at maximum output current, it is possible to adjust for maximum load current with R3 and R4 of the master instrument.
If the OVP of the master instrument operates, the output voltage drops to 0 V. However, if the OVP of a slave instrument operates this instrument delivers no power to the load.
The OVP can be separately adjusted for each instrument.
For series connection in accordance with this system, a 64,9 k Ω , 1 %, 0.1 W resistor must be added and terminal block X4 must be wired, as shown in Fig. 7i.
It is recommended that the static internal resistance of the slave instruments should be improved by changing R202 type MR25, 1 %, from 468 Ω to 3,48 k Ω . This resistor can be ordered under code number 5322 116 54591 from the service department.
Resistor R202 (see Fig. 4.) is accessible after removing the top cover plate (see section 2.1.1. Dismantling).

2.1.9. Parallel connection

Parallel connection of instruments is unlimited, and can be achieved in two ways as follows:

- a. By connecting the "+" output (X2 or X8) together, and the "-" output (X1 or X7) together.
The maximum output voltage is then equal to the instrument having the highest adjusted output voltage.
The maximum current through the load is the sum of the individually adjusted current values.
The maximum current must be adjusted higher than the desired current value through the load, but lower than the current that could damage the load.
It is recommended that the power delivered by each instrument is approximately the same; i.e. the maximum output voltages and currents are set approximately equal for each instrument.
If the OVP for any instrument operates, that instrument will deliver no power to the load.
- b. By connecting in accordance with the Master and Slave system.
The maximum output current for all instruments in this system is adjusted with R3 and R4 (see Fig. 1.) from the master instrument. R3 and R4 of the slave instruments are inoperative.
The output current of the slave instruments is equal to the output current set on the master instrument.
The output voltage of the slave instruments must be adjusted higher (2 % approx.) than the output voltage of the master instrument.
The lowest adjusted OVP of the instruments, if operating, will cause all the OVP's to operate.
Parallel connection in this manner shall be made in accordance with terminal block X4 connections shown in Fig. 7j.

2.1.10. Combined facilities

The facilities given in section 2.1.3. to section 2.1.9. can be combined.

For example, in Fig. 7k the external connections are given for combining series connection in accordance with the master-slave system, remote voltage adjusting and remote ON/OFF.

In Fig. 7l, the external connections are given for combining parallel connection in accordance with the master-slave system, remote sensing, remote ON/OFF and remote voltage - and current control.

Data concerning other combinations can be requested from the PHILIPS organisation in your country or from N.V. PHILIPS' GLOEILAMPENFABRIEKEN, TEST AND MEASURING DEPT., EINDHOVEN, HOLLAND.

2.1.11. Load

The load may be connected either on the front panel or at the rear of the instrument. Connection on the front panel is made by means of the "+" and "-" output screw-terminal connections X2 and X1 (see Fig. 1). Load connection on the rear side is by screw-terminal X8 (positive) and screw-terminal X7 (negative) see Fig. 2. The load can be earthed via screw-terminal X3 (front) or screw-terminal X9 (rear). Where no facilities are used as given in section 2.1.3. to 2.1.10., the connections on terminal block X4 must be as given in Fig. 7.a.1. for load connection at the front and according to Fig. 7a.2. in the case the load is connected at the rear.

2.1.12. Mains connection

On delivery, the instrument is adjusted for 220 V mains.

For other mains voltages, the instrument must be adjusted to the appropriate value by a skilled person who is aware of the danger involved. The instrument can be adjusted to the appropriate mains voltage by adapting the wiring of X26 and X27*.

The table below indicates which connections and interconnections must be made for various mains voltages.

<i>Mains voltage</i>	<i>Connection to points of T27</i>	<i>Points to interconnect of X26 of X27</i>	
110 V	N and 4	1-4, 2-3	1-3, 2-4-5
220 V	N and 4	2-4	2-3, 4-5
240 V	N and 6	2-5	2-3, 4-5

Terminal block X26 (see Fig. 3.) and transformer T27 (see Fig. 3 and Fig. 4) are accessible after removing the top and bottom plate (see section 2.1.1. Dismantling).

Check before connecting the instrument to the mains that the correct fuse, F1, F2 and F3 are fitted.

For 220-240 V F1 and F2 25 A slow-blow and F3 0,2 A slow-blow

For 110 V F1 and F2 50 A slow-blow and F3 0,2 A slow-blow.

The fuse holders of F1, F2 and F3 are located under the cover plate at the rear of the instrument.

The mains voltage can be connected to terminal 2 and 3 of terminal block X5 (see also sections 2.1.1. Dismantling and 2.1.2. Earthing).

Fuse replacement

Make sure that only fuses with the required rated current and of the specified type are used for replacement.

The use of mended fuses and the short-circuiting of fuse holders shall be avoided. The instrument shall be disconnected from all voltage sources when a fuse is to be replaced.

The thermal fuse in transformer T27 shall be only replaced by a skilled person who is aware of the danger involved. A thermal fuse is included in the transformer T26.

*In order to meet the safety requirements, the wires must be fixed to the solder tags of the transformer in such a way that, when the tin melts, they do not become detached.

2.1.13. Controls, indicators and terminals

Front panel (see Fig. 1)

- R1 "COARSE"
Potentiometer for coarse adjustment (range ≈ 75 V) of the stabilised output voltage.
- V1 0 - 75 V
LED indicators green when the instrument is working as constant voltage source.
- R2 "FINE"
Potentiometer for fine adjustment (range 0,75 V) of the constant voltage output adjusted by R1.
- R3 "COARSE"
Potentiometer for coarse adjustment (range ≈ 14 A) of the stabilised constant current output.
- V2 0 - 14 A
LED indicates green if the instrument is working as a constant current source.
- R4 "FINE"
Potentiometer for fine adjustment (range 0.45 A) of the constant current output adjusted with R3.
- X1, X2 "–", "+" terminals
Between these terminals, the adjusted output voltage (R1 and R2) and the adjusted output current (R3 and R4) are available.
- X3 "⊕"
Terminal for earthing the positive or negative output terminal, or for earthing the load.
- S1 "POWER ON"
Control for switching the instrument ON and OFF.
- V3 "FAILURE"
LED indicates red when the OVP, or the thermal protection of the series-stage, or the overcurrent protection (14,32 A) is operating.
- R5 "ADJUST"
Potentiometer with screwdriver adjustment for setting OVP between ≤ 1 V and a value higher than 75 V.
- P2 "A"
Ampere meter, for indicating the output current (0 - 14 A).
- P1 "V"
Voltmeter for indicating the stabilised voltage on the output terminals (0 - 75 V).

Rear view (see Fig. 2.)

- X6 "⊕"
Earth screw for connection of the protective earth
- X5 "MAINS"
Terminal block for connecting the mains voltage (terminals 2 and 3) and protective earth (terminal 1).
- F1, F2 220 V - 25 A
110 V - 50 A
Fuses 25 A slow-blow for 220 V and 240 V mains voltage
50 A slow-blow for 110 V mains voltage
- F3 220 V - 0.2 A
Fuse 0.2 A slow-blow for 110 V, 220 V and 240 V mains voltage.
- X9 "⊕"
Terminal for earthing the positive or negative output terminal, or for earthing the load.
- X7, X8 "–", "+" terminals
Between these terminals, the adjusted output voltage (R1 and R2) and the adjusted output current (R3 and R4) are available.
- X4 Terminal block; possibility for connection the different facilities given in section 2.1.3. to section 2.1.10.

2.2. OPERATION

2.2.1. Mains

After mains connection (see section 2.1.12.) the instrument can be switched on by means of S1.

2.2.2. Output voltage

The stabilised output voltage is adjustable from 0 V to a value higher than 75 V by means of the coarse and fine controls. The adjustable value of R1 can be varied by 0,75 V with fine control R2.

2.2.3. Output current

The stabilised output current is adjustable from 0 A to a value higher than 14 A with coarse and fine adjustments R3 and R4. The adjustable value of R3 can be varied by 0.45 A with fine control R4. For the adjusting of the constant output current it is possible to short-circuit the output terminals. It is recommended that this is done at a low adjusted value of output voltage.

If the instrument works as a constant current source the output voltage (V_O) varies due to load variations.

At fast (≥ 500 V/s) and large drops of V_O , it is possible that the output current (I_O) could be lower than the adjusted value during a short time.

When for example $V_O = 75$ V and $I_O = 14$ A there must be a drop ≥ 50 V (see Fig. 5.a.1.) with a rate ≥ 500 V/s for the I_O to be lower than the adjusted I_O during 0.2 s (see Fig. 5.b.1.) at max.

At $V_O = 75$ V and $I_O = 10$ A, the drop must be ≥ 60 V and at $V_O = 75$ V and $I_O = 6$ A, $\geq 62,5$ V.

Figure 5.a.2. shows the voltage drop which must occur at a V_O of 60 V in the constant current range for the I_O (see Fig. 5.b.2.) to be lower than the adjusted I_O .

If the above mentioned phenomenon occurs, V2 (current-source indication) extinguished and V3 ("FAILURE" indication OVP) light up.

2.2.4. Overvoltage protection (OVP)

This is adjustable with R5 between ≤ 1 V and a value higher than 75 V.

To set OVP, turn R5 completely clockwise. Switch on and turn voltage control to indicate OVP level required.

Turn R5 anti-clockwise until "FAILURE" is lit (i.e. OVP operates).

When the OVP operates (indicated by V3) then the output voltage drops to 0 V. Switch OFF the instrument, turn R1 to the left, switch ON and adjust the required output voltage with R1 and R2. For checking the OVP at a voltage higher than 75 V it is possible to connect an external voltage in parallel with the instrument.

when it is switched on.

2.2.5. Thermal protection

The thermal protection (S51 in the circuit diagram) protects the power semi-conductors against too high a temperature.

When these semi-conductors are at excessive temperature, the thermal protection switches into operation the circuit of the OVP. Then the output voltage drops to 0 V.

Excessive temperature of the semi-conductors can occur because:

- the semiconductors have to dissipate too high a power.
- the air circulation is impeded, e.g. when the fan is blocked or the ventilation holes in top and bottom plate are obstructed.
- the ambient temperature is too high in respect of the power to be delivered, so the fan is unable to cool the semiconductors sufficiently.

When the OVP is operative (too high a temperature or overvoltage) this shall be indicated by the red light of V3 ("FAILURE").

After the OVP has been operative, the adjusted output voltage will be available only if the instrument is first switched "OFF" and then "ON" again.

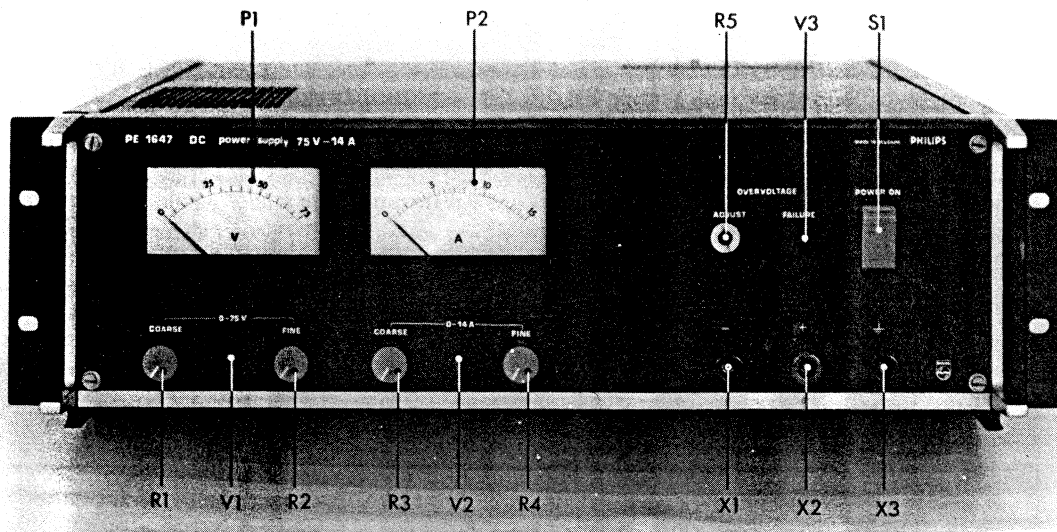

Fig./Abb. 1.

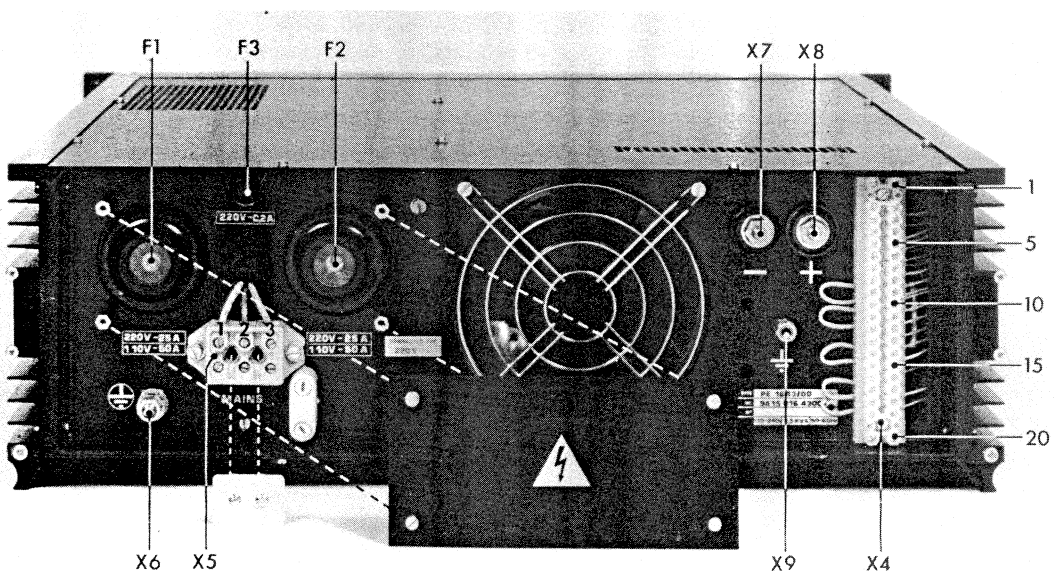

Fig./Abb. 2.

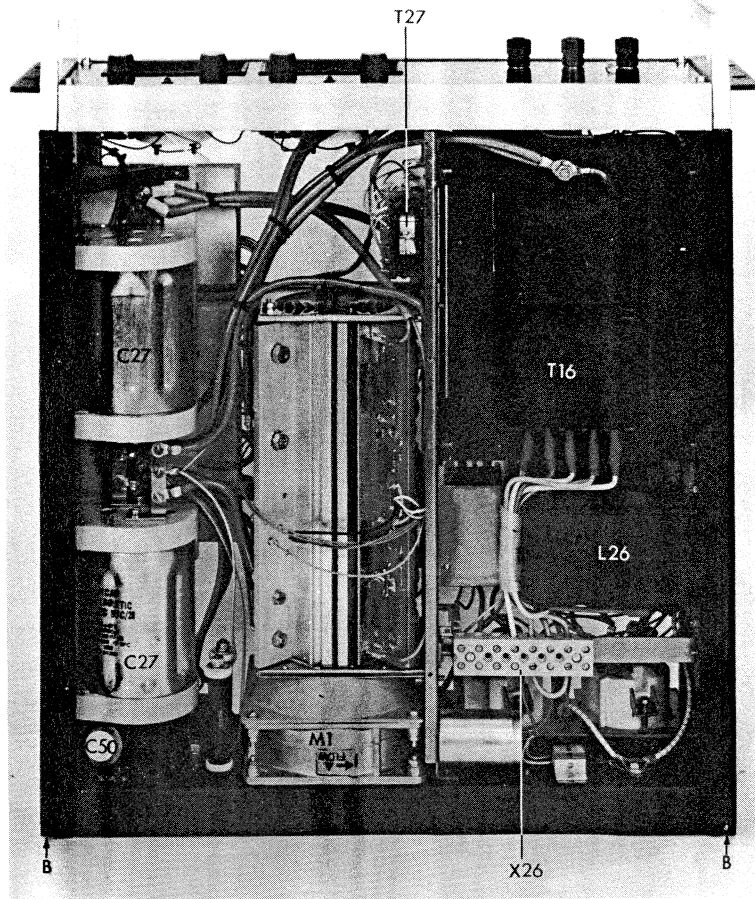

Fig./Abb. 3.

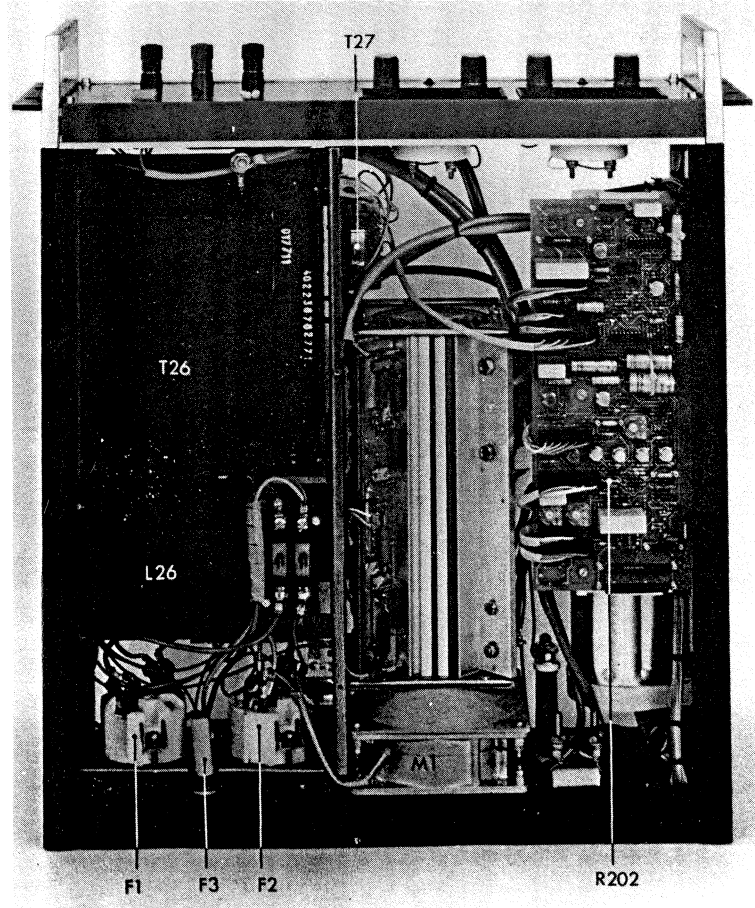

Fig./Abb. 4.

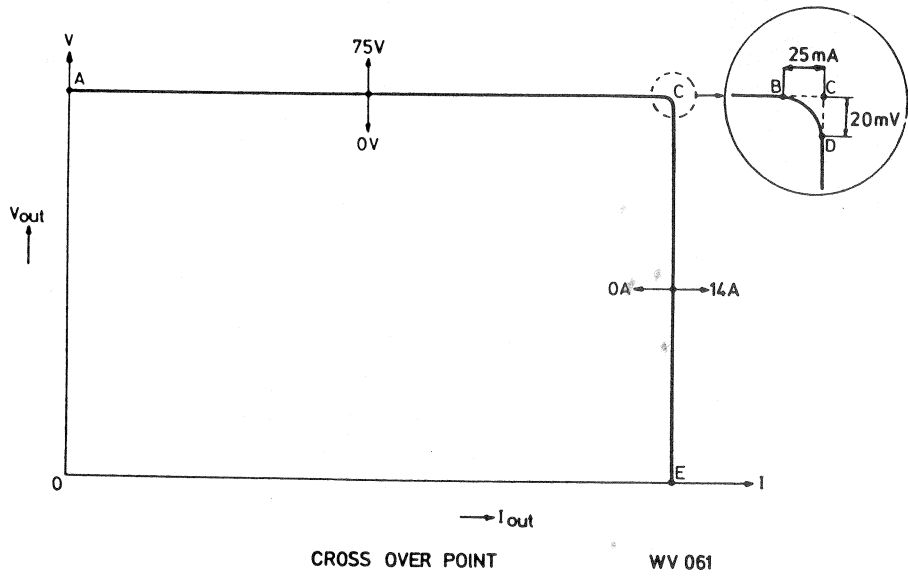

Fig./Abb. 5.

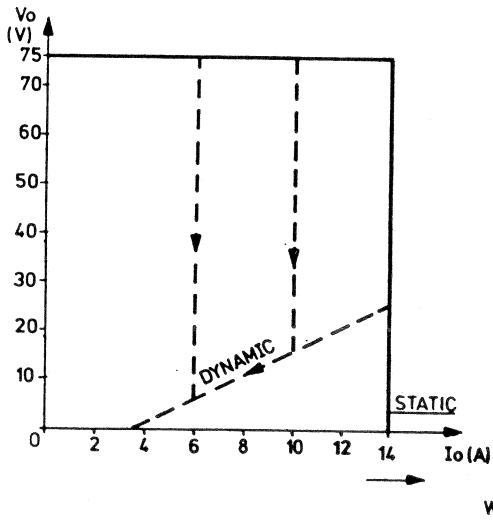

Fig./Abb.5a1.

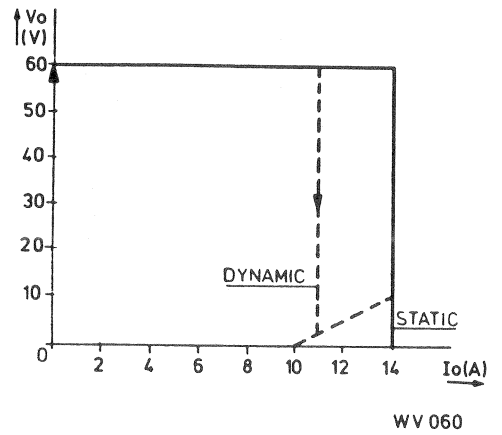
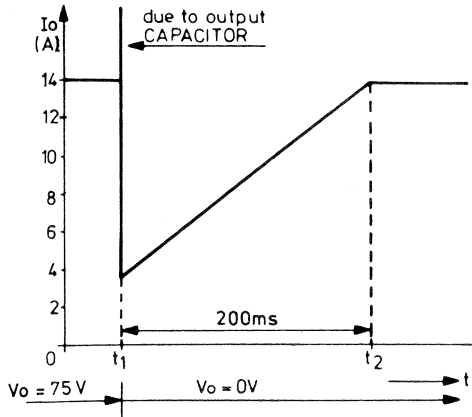

Fig./Abb. 5a2.



OUTPUT CURRENT

WV 057

Fig./Abb. 5b1.

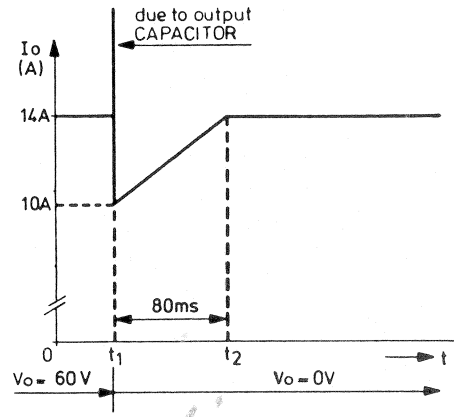

OUTPUT CURRENT

WV 059

Fig./Abb. 5b2.

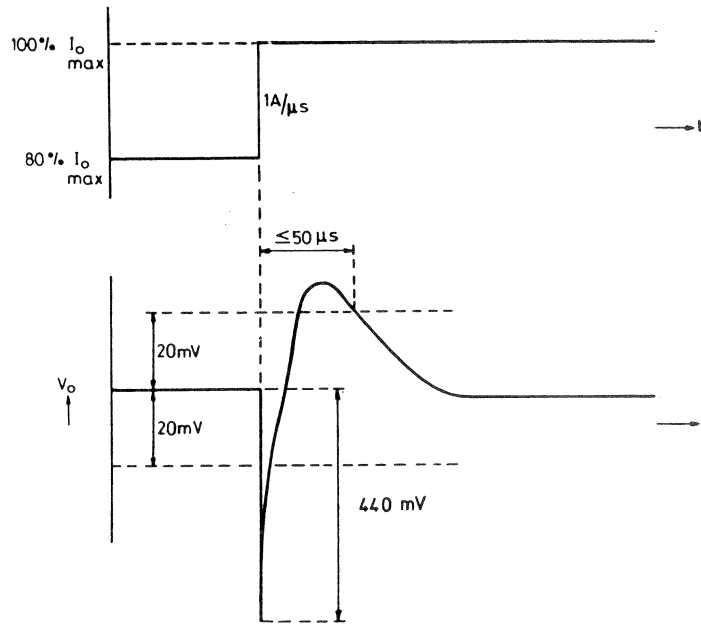

WV 056

Fig./Abb. 6.

PE 1647

