

FENG LIAISON

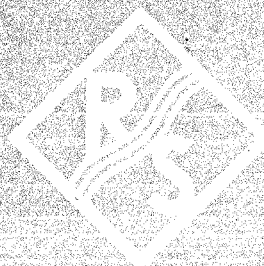

Spin di Bruno Marco
Via S. Luigi 27
10043 ORBASSANO (TO)
Tel. (011) 90.38.866 Fax 90.38.960

ROHDE & SCHWARZ

SKTU

BESCHREIBUNG

Instruction Book

NOISE GENERATOR

Type SKTU

BN 4151/2/50 BN 4151/2/60 BN 4151/2/75

R
5
R 8508
663
Bl. 1
(23 Bl.)

Note: Always quote the Type and Order Number (BN) in addition to the Serial Number (FNr.) of the set when asking for technical information and, in particular, when ordering repair parts.

Edition R 8508/663

(Translation of the German edition R 8312/263)

1. Specifications

BN 4151/2/50

Frequency range	3 to 1000 Mc
Source impedance	50 Ω
VSWR	less than 1.1
Noise power continuously variable . .	0 to 32 kT ₀ 0 to 15 db ⁰
Noise power stability, obtained by regulation of filament voltage	better than ± 1 kT ₀ with an AC supply variation of $\pm 10\%$ ⁰
Noise power indication by meter having the ranges	0 to 6.5 kT ₀ , 0 to 32 kT ₀ or 0 to 8 db, 0 to 15 db ⁰
Output connector	R&S connector Dezifix B FMU 11950/50 adaptable to other connector systems, see screw-in assemblies on page 13, section 7.1.5
Power supply	115/125/220/235 v 47 to 63 cps (25 va)
Valves, etc.	1 valve Type 5722 (Sylvania) 1 transistor GT/CTP 1109 2 transistors GT/OC 604 spec. 1 miniature glow lamp RL 210 1 0.4-amp fuse 0,4 C DIN 41571 1 0.1-amp fuse 0,1 C DIN 41571
Dimensions	470 x 195 x 260 mm (R&S Standard Cabinet 45)
Weight	9 kg

R 8508
663
Bl. 3

2. Specifications

BN 4151/2/60

Frequency range	3 to 1000 Mc
Source impedance	60 Ω
VSWR	less than 1.1
Noise power continuously variable	0 to 40 kT_o 0 to 16 db
Noise power stability, obtained by regulation of filament voltage	better than $\pm 1 kT_o$ with an AC supply variation of $\pm 10\%$
Noise power indication by meter having the ranges	0 to 8 kT_o , 0 to 40 kT_o or 0 to 9 db, 0 to 16 db
Output connector	R&S connector Dezifix B FMU 11950/60 adaptable to other connector systems, see screw-in assemblies on page 13, section 7.1.5
Power supply	115/125/220/235 v 47 to 63 cps (25 va)
Valves, etc.	1 valve Type 5722 (Sylvania) 1 transistor GT/CTP 1109 2 transistors GT/OC 604 spec. 1 miniature glow lamp RL 210 1 0.4-amp fuse 0,4 C DIN 41571 1 0.1-amp fuse 0,1 C DIN 41571
Dimensions	470 x 195 x 260 mm (R&S Standard Cabinet 45)
Weight	9 kg

R. 8508
663
Bl. 4

3. Specifications

BN 4151/2/75

Frequency range	3 to 1000 Mc
Source impedance	75 Ω
VSWR	less than 1.1
Noise power continuously variable	0 to 32 kT_0 0 to 15 db
Noise power stability, obtained by regulation of filament voltage	better than $\pm 1 kT_0$ with an AC supply variation of $\pm 10\%$
Noise power indication by meter having the ranges	0 to 6.5 kT_0 , 0 to 32 kT_0 or 0 to 8 db, 0 to 15 db
Output connector	R&S connector Dezifix B FMU 11950/75 adaptable to other connector systems, see screw-in assemblies on page 13, section 7.1.5
Power supply	115/125/220/235 v 47 to 63 cps (25 va)
Valves, etc.	1 valve Type 5722 (Sylvania) 1 transistor GT/CTP 1109 2 transistors GT/OC 604 spec. 1 miniature glow lamp RL 210 1 0.4-amp fuse 0,4 C DIN 41571 1 0.1-amp fuse 0,1 C DIN 41571
Dimensions	470 x 195 x 260 mm (R&S Standard Cabinet 45)
Weight	9 kg

R 8508
663
Bl. 5

4. General

In order to provide a means for accurately comparing the quality of four-terminal networks, especially receivers and amplifiers, with respect to their inherent noise, the noise figure F expressed in units of kT_o or db has been introduced. The noise figure F is the ratio of the noise power existing in the terminated output of a linear system to the noise power that would exist in the output if the system did not introduce an inherent noise. This is expressed by

$$F = \frac{N_o}{kT_o \Delta f_{\text{eff}} G_o} \quad (1)$$

where N_o = output noise in watts
 k = Boltzmann's constant, 1.38×10^{-23} joules/ $^{\circ}$ K
 T_o = absolute ambient temperature, 290° K
 Δf_{eff} = effective noise bandwidth in cps
 G_o = network power gain at the reference frequency f_o

In the case of an ideal system where no noise is introduced, the output noise power equals the input noise power multiplied by the power gain; thus an ideal system has a noise figure of $1 kT_o$ or 0 db.

The relationships between noise figures expressed in kT_o and db are given by

$$F(\text{db}) = 10 \log F(kT_o) \quad (2)$$

$$F(kT_o) = 10^{0.1 F(\text{db})}$$

For the conversion of kT_o to db and vice versa with an accuracy sufficient for practical applications, the conversion diagram in Fig. 4 on page 22 is provided.

R 8508
663
Bl. 6

The effective bandwidth Δf_{eff} of an amplifier system (refer to Fig. 1 on page 21) is determined by integrating the square of the output noise voltage (proportional to power) over the entire noise spectrum, theoretically from 0 to ∞ cps, and then dividing this integral by the square of the peak noise response voltage at f_o , thus obtaining the effective bandwidth Δf_{eff} .

This is expressed by

$$\Delta f_{\text{eff}} = \frac{1}{a^2} \int_{\omega = 0}^{\omega = \infty} [\alpha(\omega)]^2 d\omega \quad (3)$$

where

a = peak noise response voltage at f_0

α = noise voltage as function of frequency.

5. Fundamentals of Noise-Figure Measurements

The noise figure of a four-terminal network such as a receiver is best measured with a noise generator, producing a well-defined spectrum of white noise. The term "white noise" denotes a frequency spectrum all components of which are equal in amplitude. The receiver allows only a portion of such a spectrum to pass through depending upon its bandwidth, this bandwidth being the same for the inherent noise. It is therefore possible to determine noise figures using a comparison method whereby the bandpass characteristic does not enter into the measurement.

5.1 Temperature-limited Diode

A temperature-limited high-vacuum diode with a tungsten cathode is the answer to the problem of producing a noise power of continuous frequency spectrum since its noise current is constant and easily calculated. The noise current is given by the relation

$$I_N = \sqrt{2 e \cdot I_d \cdot \Delta f_{\text{eff}}} \quad (4)$$

where

e = 1.6×10^{-19} Coul

I_d = the diode current under temperature-limited conditions in amperes

Δf_{eff} = the effective noise bandwidth in cycles per second.

If a source resistance R_s equal to the load input resistance R_{in} is connected across this diode, an available noise power of

$$P_N = \left(\frac{I_N}{2}\right)^2 \cdot R_i = e/2 \cdot I_d \cdot \Delta f_{\text{eff}} \cdot R_i \quad (5)$$

is obtained.

Referred to a bandwidth of 1 cps,

$$\frac{P_N}{\Delta f_{\text{eff}}} = e/2 \cdot I_d \cdot R_i \quad (6)$$

Since, on the other hand

$$\frac{P_N}{\Delta f_{\text{eff}}} = kT_o \cdot F \quad (7)$$

the available specific noise power is

$$F = \frac{e \cdot I_d \cdot R_i}{2 kT_o} = 20 \cdot I_d \cdot R_i \quad (8)$$

Thus the determination of the available specific generator output reduces to a simple measurement of the diode DC current. This makes it possible to calibrate a meter for the diode current directly in terms of kT_o or db of the available specific generator noise power.

The signal voltage E_{in} which must be available across the receiver input to obtain a signal-to-noise ratio of 1 can be calculated if, besides the noise figure F , the effective noise bandwidth Δf_{eff} and the input impedance R_{in} of the receiver are known.

$$E_{in} = \sqrt{F \cdot kT_o \cdot \Delta f_{\text{eff}} \cdot R_{in}} \quad [v] \quad (9)$$

For example, a receiver with $R_{in} = 60 \Omega$, $\Delta f_{\text{eff}} = 10^6$ cps and $F = 5$ requires a signal voltage

$$E_{in} = \sqrt{5 \cdot 4 \cdot 10^{-21} \cdot 10^6 \cdot 60} = 1.1 \cdot 10^{-6} \text{ v} = 1.1 \mu\text{v}$$

In sensitivity measurements using a noise generator, a square-law voltmeter is required to determine the rms value of the noise voltage available at the network output. The measurement is best made in the IF section of the receiver: ahead of the detector in the case of AM receivers; ahead of the limiter stages in the case of FM receivers. For laboratory purposes, it is possible to use, e.g., an adapter which can be plugged into the valve socket instead of an IF valve. The pins of the adapter permit the noise voltage between the grid and cathode contacts to be tapped. A built-in trimmer simulates the valve capacitance at the grid to eliminate grid circuit detuning, though this would not be critical.

5.2 Determining the Receiver Noise Figure F

Connect noise generator to receiver input. Adjust noise generator output to zero and, on voltmeter connected to output of the linear receiver section, read the deflection due to inherent noise. Increase noise generator output until voltmeter reading has increased by the factor of $\sqrt{2}$. Read noise figure from meter of the noise generator.

Theoretically, a thermocouple type square-law voltmeter would appear to be the best choice. However, this type of voltmeter is here unsuitable as even a pulse of short duration, such as due to RF pickup (crackling), might destroy the thermocouple. Rectifier meters are more practical, but care must be exercised to operate the rectifier over the square-law portion of its characteristic. The use of a meter with a linear average reading rectifier would not entail too large an error. A peak reading voltmeter, however, is quite unsuitable.

A method enabling a non-calibrated meter other than a square-law type to be employed is to place ahead of the meter rectifier a switchable voltage divider which reduces the voltage by the factor of $\sqrt{2}$, i.e. halving the power. It is then just necessary to take the reading caused by inherent noise, to switch the voltage divider into circuit and to increase the generator output to obtain the same deflection.

6. Construction and Function

The noise source of the Noise Generator Type SKTU is a directly heated special-purpose diode Type 5722 manufactured by Sylvania. Fig. 2 on page 21 shows the simplified circuit diagram.

The special socket for the noise diode in the Noise Generator Type SKTU is built directly into a coaxial line (see circuit diagram on page 23). The impedances of the valve system and the internal leads are compensated additional inductance being avoided. This careful design permits a very wide frequency range of white noise to be obtained with a practically ohmic internal impedance. For the indicated upper limit the phase angle is less than 15° .

One end of the line is terminated by a coaxial resistor which, for special investigations, can be replaced by another terminating load, such as an aerial. It is then necessary to provide a low-impedance electrical connec-

R 8508
663
FB1. 9

tion between inner and outer conductors of the termination since the anode current of the noise diode flows through the inner conductor, terminating resistor and outer conductor. The terminating resistor constitutes the internal impedance of the generator across which the noise voltage is developed by the noise current from the diode. The internal resistance of the noise diode is in parallel with the terminating resistor, but this does not affect the internal impedance of the generator as the diode has practically an infinite impedance if operated in its temperature-limited condition. The operating voltages for the valve are filtered. A removable screening can protects the diode from picking up extraneous noise.

The moving-coil meter in the diode circuit measures the temperature-limited current of the valve in two ranges. The scale is calibrated directly in terms of kT_0 and db.

6.1 Adjustment and Stabilization of the Temperature-limited Current

The noise current of the diode and thus the noise power delivered to the receiver is determined by the temperature-limited anode current of the diode. This current in turn is a function of the cathode temperature. Thus the noise power can be adjusted by varying the filament voltage which is taken from the secondary of Tr2, rectified by G12 and smoothed by C3.

Due to the exponential relationship between the temperature-limited anode current and the absolute cathode temperature a slight change in the cathode temperature causes a considerable change in the temperature-limited current and thus in the available noise power. In order to maintain the noise power at a constant value during the measurement, the diode current must be stabilized by regulation of the filament voltage. This is achieved by a regulator circuit which consists of the transistors T1-T2-T3, the resistors R1-R2-R4-R7 and the battery Ba1 and operates in the following manner:

The diode current that is to be kept constant is tapped off at the input of the filter sections C5-R5-C8 and C6-L2-C9, reduced to the required value by the voltage divider R4-R7 and applied to the base of the transistor T3. The emitter voltage is determined by the voltage of Ba1 and is practically constant. The current flowing through T3 depends upon the difference between the base and emitter voltages. This difference changes if for some reason the anode current changes. As a result, the magnitude

R 8508

E 663

B1. 10

of the current flowing through T3 changes. Transistor T2 amplifies this current change and applies a correspondingly different voltage to the base of T1, the resistance of T1 and the current flowing through it thus being changed. Since T1 is in series with the filament of the diode and thus passes the filament current it acts like a variable series resistor regulating the filament current so that the diode current remains constant.

To ensure that the influence of AC supply fluctuations is eliminated by forward control, the voltage rectified by G12 is tapped off ahead of the regulator circuit and likewise applied to the base of T3 through R2-R4.

The desired noise power is obtained by varying the potential difference between base and emitter of T3 by means of the potentiometer R4. Once the noise power has been adjusted in this way it is kept constant by the regulator circuit.

The stability of the noise power adjusted for depends upon its magnitude. At full-scale deflection, i.e. at 40 or 32 kT_0 respectively, the noise power varies by not more than $\pm 1 kT_0$ in the case of AC supply fluctuations of $\pm 10\%$. At lower kT_0 values the stability is even better.

Since the temperature-limited current increases exponentially with the heater power, a potentiometer with an exponentially falling characteristic, R4, has been incorporated. In addition, the value of R7 has been selected so that an essentially linear relationship between the angle of rotation of R4 and the kT_0 value is obtained.

The battery, Ba1, which supplies the constant emitter voltage is a 1.2-v nickel-cadmium cell. During operation, even with the output power reduced to zero, a small current continually flows through T3 and charges the battery. The current is not larger than is permissible for trickle charging.

6.2 Operating Life of the Diode

The average operating life specified by Sylvania for the valve 5722 as a function of the filament voltage can be seen from Fig. 3. The curve refers to 40% reduction in filament diameter. In the Type SKTU only the range of up to about 4.9 v is utilized. As indicated, the life expectancy is 300 hours if the set is always operated with the maximum readable noise power. It is advisable to maintain maximum output only as long as it is absolutely necessary for the measurement.

R 8508
663

Bl. 11

7. Preparation for Use and Operating Instructions

7.1 Preparation for Use

7.1.1 Adjusting the Set to the Local Supply Voltage

The Type SKTU leaves our factory adjusted for a 220 v AC supply. To adjust it for operation from 115, 125 or 235 v, unscrew the cheesehead screws at the corners of the front panel, withdraw the chassis from its cabinet and insert a suitable fuse into the clips on the fuse strip marked by the given supply voltage. The 0.4-amp fuse provided for 220 v will do also for 235 v. If the local power supply is 115 or 125 v, insert a 0.8-amp fuse (0,8 C DIN 41571).

7.1.2 Setting the Mechanical Zero of the Meter

With the set switched off, the pointer should be at the mechanical zero. This is the mark 0 kT₀. The slotted screw recessed in the meter housing serves to correct the pointer position, if necessary. This is also possible with the set switched on provided the output control is turned fully counterclockwise.

7.1.3 Switching On

Put the toggle switch, which is located over the AC supply input, up for on. The glow lamp connected to the primary circuit of the power transformer is the voltage indicator.

The set is ready for operation immediately after switching on. For maximum life of the noise diode, adjust the noise power control for minimum output when not measuring.

7.1.4 Range Selection

To ensure good readability of the noise output adjusted for, two different meter ranges can be selected by a toggle switch on the left-hand side of the front panel. The inscriptions for this switch indicate full-scale deflection of the respective scale.

R 8508
663
Bl. 12

7.1.5 Cable Connection between Type SKTU and Receiver

The output of the Type SKTU, as indicated in the sections on specifications, is fitted with an R&S connector Dezifix B which is adaptable to other connector systems. The adaptation procedure is very simple: Unscrew the outer conductor of the Dezifix connector using the wrench FZM 10900 and remove the inner conductor with the aid of a 4-mm screwdriver. Insert the inner and the outer conductors of the required screw-in assembly. For the time being the following screw-in assemblies are available:

Desired connector on Type SKTU	Order Number
50-Ω socket UHF series (MIL)	FHD 10900/50
50-Ω plug UHF series (MIL)	FHS 10900/50
50-Ω socket N series (MIL)	FHD 20900/50
50-Ω plug N series (MIL)	FHS 20900/50
75-Ω socket N series (MIL)	FHD 20900/75
75-Ω plug N series (MIL)	FHS 20900/75
50-Ω socket C series (MIL)	FHD 30900/50
50-Ω plug C series (MIL)	FHS 30900/50
50-Ω socket BNC series (MIL)	FHD 40900/50
50-Ω plug BNC series (MIL)	FHS 40900/50
50-Ω socket 4,1/9,5	FID 20900/50
50-Ω plug 4,1/9,5	FIS 20900/50
50-Ω socket 7/16	FID 40900/50
50-Ω plug 7/16	FIS 40900/50
60-Ω socket 3,5/9,5	FID 20900/60
60-Ω plug 3,5/9,5	FIS 20900/60
60-Ω socket 6/16	FID 40900/60
60-Ω plug 6/16	FIS 40900/60
50-Ω connector 874 General Radio	FLA 20900/50
50-Ω connector H 4 Marconi	FLB 20900/50

R 8508
663
Bl. 13

We recommend that you employ great care when storing Dezifix connectors and screw-in assemblies since even slight mechanical damages may affect their electrical characteristics.

7.1.6 Noise Voltage Indication

To measure the noise figure of a receiver, a meter responding to effective voltage values, i.e. with a square-law response, should be used in conjunction with the noise generator. There is also a method of measurement which makes it possible to use an uncalibrated voltmeter without a square-law response. Both methods are described in section 7.2.

Our UHF Millivoltmeter Type URV with probe is well suited as an instrument responding to rms voltage values under the condition that a suitable divider is used with the probe so that the voltage fed to the instrument can be read in the 20-mv range. In this range, square-law rectification is practically guaranteed up to 15 mv. The set of dividers to use with the probe makes possible a coverage from 5 to 750 mv. With the 20-mv range used up to 15 mv, the following sub-ranges are possible:

5 to 15 mv without divider	(1:1),	f over 0.1 Mc
15 to 45 mv with divider	1:3,	f over 2 Mc
50 to 150 mv with divider	1:10,	f over 3 Mc
100 to 375 mv with divider	1:25,	f over 4 Mc
250 to 750 mv with divider	1:50,	f over 4 Mc.

7.2 Measuring Procedure

A receiver should always be measured within its linear section at a point where the noise voltage has attained a value that can be easily measured; i.e., ahead of the limiter stage in FM receivers and ahead of the demodulator in AM receivers.

In the case where an instrument is used which responds to rms voltage values, the following method is employed: With its output adjusted to zero, the noise generator is connected to the receiver input. The noise voltage read from the instrument is that produced by the receiver itself. The output of the noise generator is then increased until the noise voltage indicated by the instrument is increased by $\sqrt{2}$. Thus the noise power at the point of measurement is twice its former value. The noise figure of the receiver can then be read directly in kT_0 or db from the panel meter of the Type SKTU.

When measuring, check for overdriving which may exist in the section between the receiver input and the test point, since this will introduce a

R 8508
663
Bl. 14

measuring error. Overdriving may occur even at a relatively low rms value since the noise peaks rise far above the rms value.

This check is simple: It is merely necessary to see that the voltage across the test point increases according to the addition law for power. For example, if the inherent receiver noise power corresponds to a voltage output of $0.1 v_{\text{rms}}$, doubling the noise power with the aid of the noise generator results in a noise voltage of $0.1\sqrt{2} v_{\text{rms}}$. If the noise power is tripled, the output voltage is $0.1\sqrt{3} v_{\text{rms}}$. Therefore if a reading of $20 kT_0$ on the noise generator doubled the noise power output giving a output voltage of $0.1\sqrt{2} v_{\text{rms}}$, a reading of $40 kT_0$ would triple the power, thus giving a voltage of $0.1\sqrt{3} v_{\text{rms}}$. If this is true, the receiver is linear and free from overdrive up to the test point.

The chart at the front panel of the Type SKTU shows the approximate RF voltage that must be applied to a receiver of a given bandwidth and noise figure in order to obtain a signal-to-noise ratio of 1.

In the case where an rms-reading instrument is not available and a linear average-reading or peak-reading type is used, the above method applies except that a switchable voltage divider is placed in the input of the indicating instrument so that the input voltage can be reduced by a factor of $\sqrt{2}$, the power thus dropping to one half its former value. After the inherent noise voltage of the receiver has been read, the divider is switched in and the noise generator output increased until the same reading is again obtained.

It is easier to make a measurement when the receiver has an IF output and an attenuator box calibrated in db is at hand. The attenuator box is connected between the IF output and the indicating instrument. The procedure is the same as described above with the voltage divider, the only difference being that the attenuator box setting is changed by 3 db when making the measurements.

R 8508
663
Bl. 15

8. Maintenance

8.1 Battery

As mentioned previously, the battery Ba1 is a nickel-cadmium cell which is very robust and is charged during operation. It is thus always ready for use and does not require any maintenance.

If the instrument is not used for more than one year it may, however, happen that the battery slowly discharges and that its voltage is no longer sufficient. This is evidenced by the fact that full-scale meter deflection cannot be reached even with the output control advanced fully clockwise. In this case, leave the instrument switched on for one hour, with the output power reduced to zero. The battery will then again be ready for operation. If after this period full-scale deflection cannot be reached, the valve emission has decreased.

8.2 Adjustment of the Variable Resistor R7

If, due to a decrease in the emissivity of the diode, full-scale deflection cannot be reached with the output control advanced fully clockwise this can be remedied to a certain extent by means of R7. R7 is connected in series with the output control R4 and is accessible only after the chassis has been removed from its cabinet. It is mounted beside the fuse strip. Advance the output control to about 9/10 of full clockwise rotation and vary R7 until full-scale meter deflection is reached. This does not affect the calibration. If it is not possible to obtain full-scale deflection by varying R7, a new diode is required.

8.3 Replacement of the Noise Diode Type 5722

Remove the chassis from its cabinet. Loosen the screws of the tension band round the screening can of the valve and remove the can. The valve is then accessible for replacement. The calibration of the instrument is not affected by this valve replacement. Subsequently, adjust R7 as described under section 8.2 so that the control range and the angle of rotation of the output control are in agreement and the output power varies linearly.

R 8508
663
Bl. 16

9. Table of Replaceable Parts

Ref. No.	Designation	Ratings	R&S Stock No.
Ba1	Accumulator		BA 30013
C1	Capacitor, MP	8 μ f/250 v	CMR 8/250
C2	Capacitor, MP	8 μ f/250 v	CMR 8/250
C3	Capacitor, electrolytic	2500 μ f/35 v	CEE 21/2500/35
C4	Capacitor, feed-through, paper	50,000 pf/300 v	CPD 50 000/300
C5	Capacitor, feed-through, paper	50,000 pf/300 v	CPD 50 000/300
C6	Capacitor, feed-through, paper	50,000 pf/300 v	CPD 50 000/300
C7	Capacitor, bypass		incl.in 4151-1.1
C8	Capacitor, bypass		incl.in 4151-1.1
C9	Capacitor, bypass		incl.in 4151-1.1
C10	Capacitor, paper	50,000 pf/250 v	CPK 50 000/250
G11	Rectifier	250 v/60 ma	GNB 14/250/60
G12	Rectifier	30 v/2000 ma	GNB 11/30/2000 B
I1	Meter, moving-coil		INS 40504 for BN 4151/2/50 INS 40505 for BN 4151/2/60 INS 40506 for BN 4151/2/75
K1	Cord, power		LKA 08031/1

R 8508
663
Bl. 17

Ref. No.	Designation	Ratings	R&S Stock No.
L1	Choke, RF		DUF 311/20
L2	Choke, RF		DUF 311/20
R1	Resistor, depos. carbon	1 k Ω /0.25 w	WF 1 k/0,25
R2	Resistor, depos. carbon	approx. 25 k Ω /0.25 w	WF ...k/0,25
R3	Resistor, depos. carbon, variable	500 Ω lin.	WS 9122 F/500
R4	Resistor, depos. carbon, variable	1 k Ω log.	WS 5326/1 k
R5	Resistor, depos. carbon	50 Ω /0.25 w	WF 50/0,25
R6	SHF Standard Resistor Type RMC	60 Ω	33527/60
R7	Resistor, depos. carbon, variable	1 k Ω lin.	WS 9122 F/1 k
R8	Resistor, shunt		IZ 102/6,66 mA/ 33,3 mA (0,5)
R9	Resistor, depos. carbon	25 k Ω /2 w	WF 25 k/2
R10	Resistor, depos. carbon	500 Ω /2 w	WF 500/2
R11	Resistor, depos. carbon	300 Ω /0.05 w	WFK 613/300/0,05 for BN 4151/2/50
R12	Resistor, depos. carbon	16 Ω /0.25 w	WFK 633/16/0,25 for BN 4151/2/75
R11	Lamp, miniature, glow	220 v	RL 210
R01	Diode, noise		Sylvania 5722
S1	Switch, power (combination)		SKK 120
S2	Fuse panel		FD 60511
S3	Switch, RF, toggle		SR 301/2

R 8508
663
Bl. 18

Ref. No.	Designation	Ratings	R&S Stock No.
Si1	Fuse	400 ma (for 220/235 v)	0,4 C DIN 41571
Si2	Fuse	100 ma	0,1 C DIN 41571
T1	Transistor		GT/CTP 1109
T2	Transistor		GT/OC 604 spec.
T3	Transistor		GT/OC 604 spec.
Tr1	Transformer, power		4151 - 21

R 8508
663
Bl. 19

Guarantee

Rohde & Schwarz guarantee

F O R O N E Y E A R

each instrument manufactured and sold by them to be free from defects in material and workmanship, subject to clause 5 of their terms of delivery and payment.

This guarantee does not imply the right to rescind a sale or demand a reduction in purchase price. The firm's obligation under this guarantee is limited to the repair or replacement of the defective part or parts, provided the claim is asserted in writing immediately, or within one week at the latest, after discovery of the defect. The part or parts shall be returned to the factory, with transportation charges prepaid, within one week from the instruction by the firm to do so. The return charges shall likewise be covered by the purchaser. The firm does not assume any liability for damage resulting directly or indirectly from the defect. The guarantee shall be void if the part or parts have been tampered with.

The seals of the instrument shall be undamaged. Rohde & Schwarz guarantee valves for which the purchaser has not received the certificate of guarantee of the manufacturer. Defective valves which are held to be covered by this guarantee shall be returned to the factory for examination. The following details shall be specified:

Number, date and reference of the invoice;
type and serial number (FNr.) of the instrument;
specification of valve defect.

R O H D E & S C H W A R Z . M Ü N C H E N

R 8508
663
Bl. 20

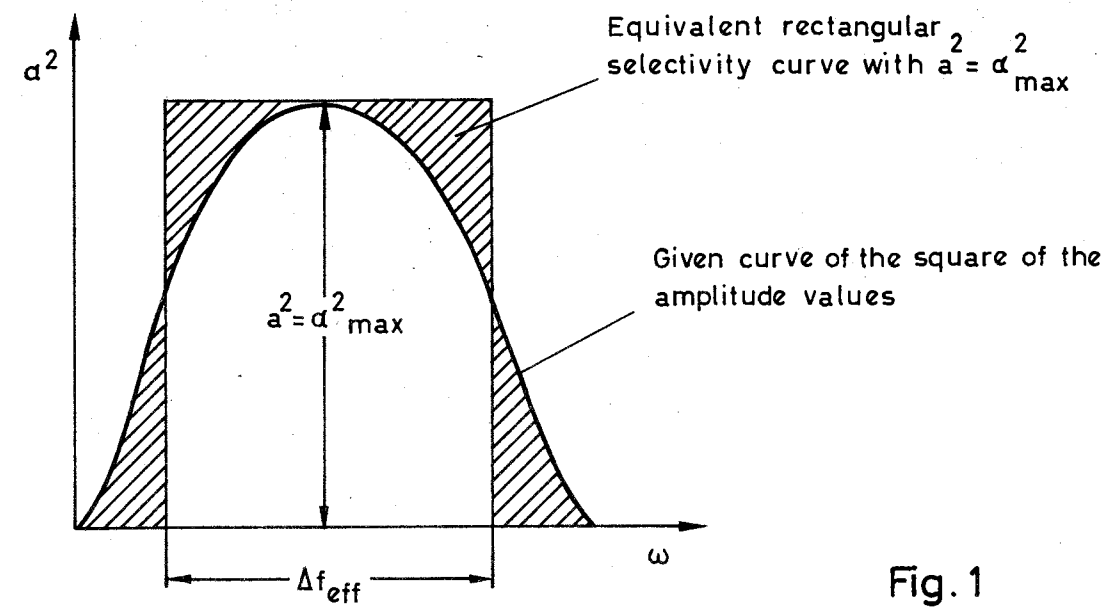

Fig. 1

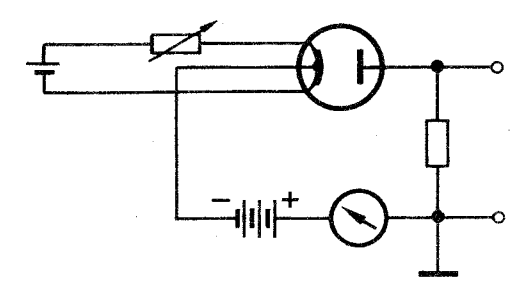

Fig. 2

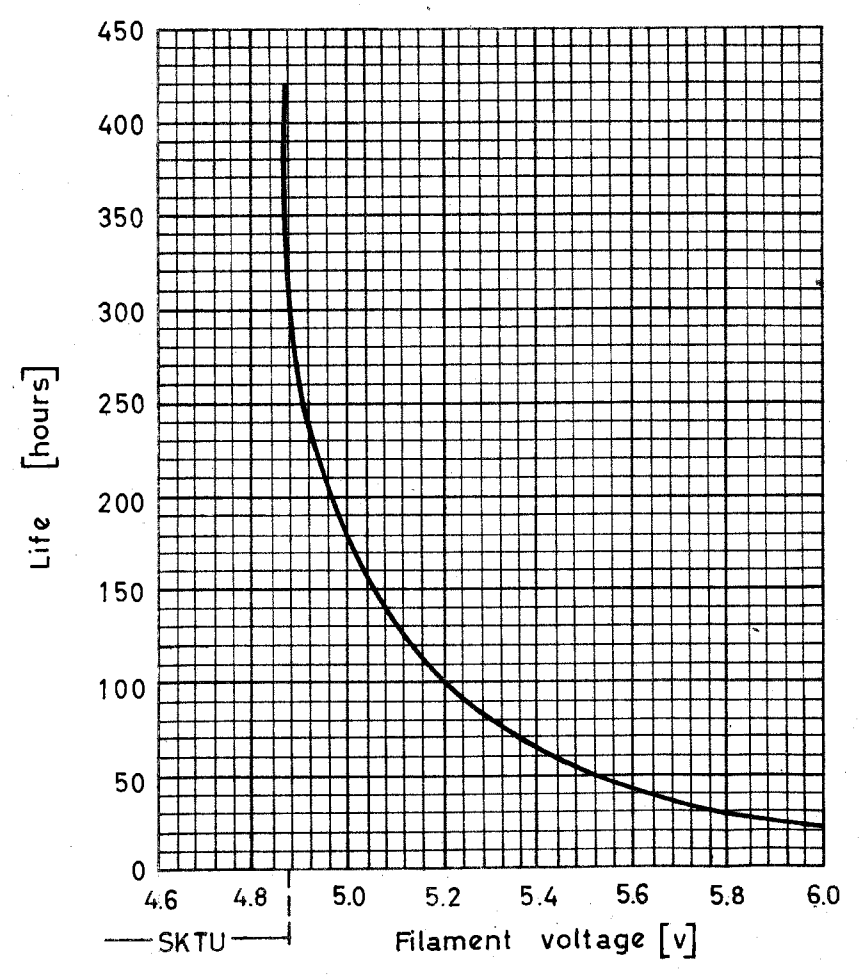

Fig. 3

R 8508
663
Bl. 21

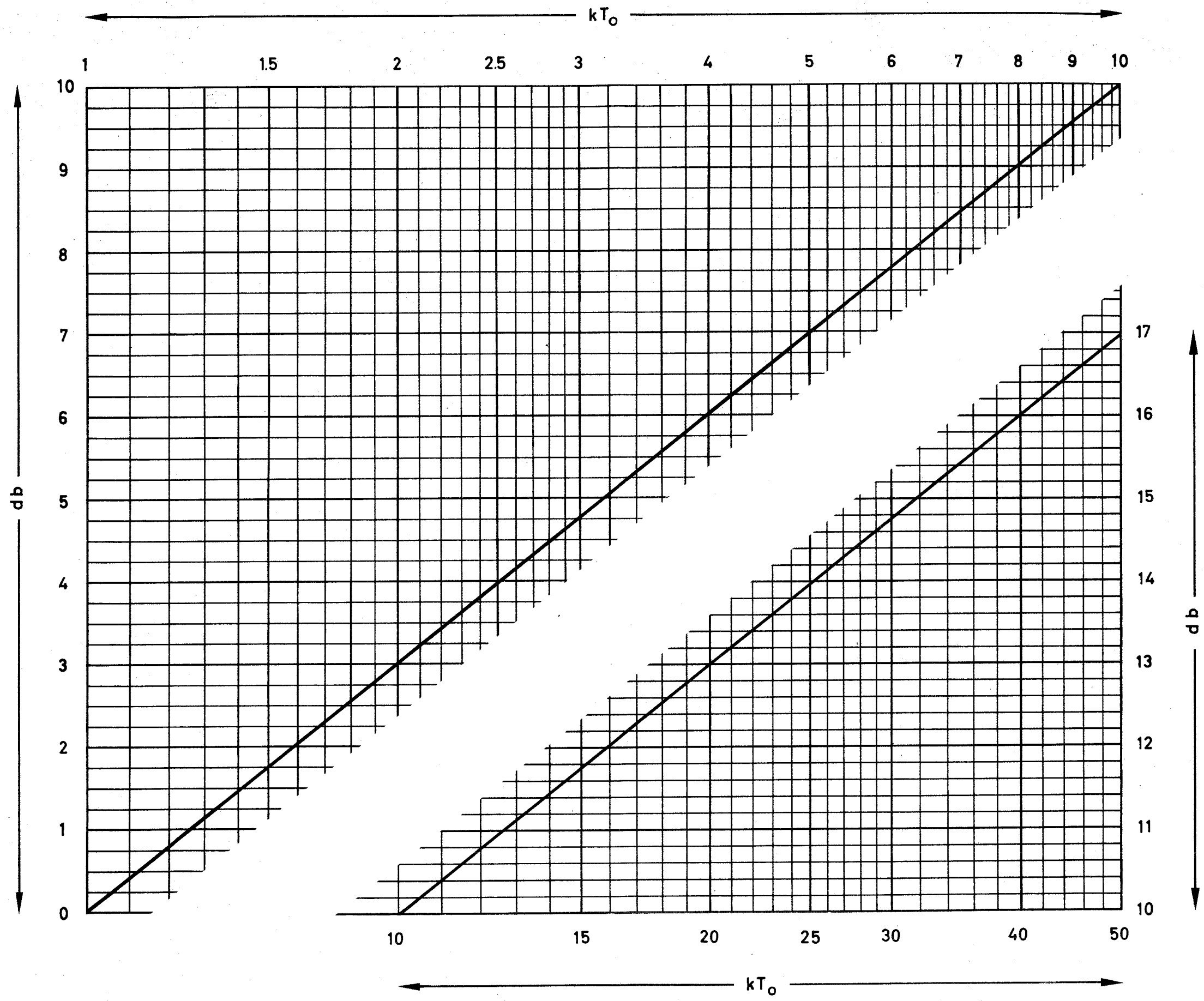
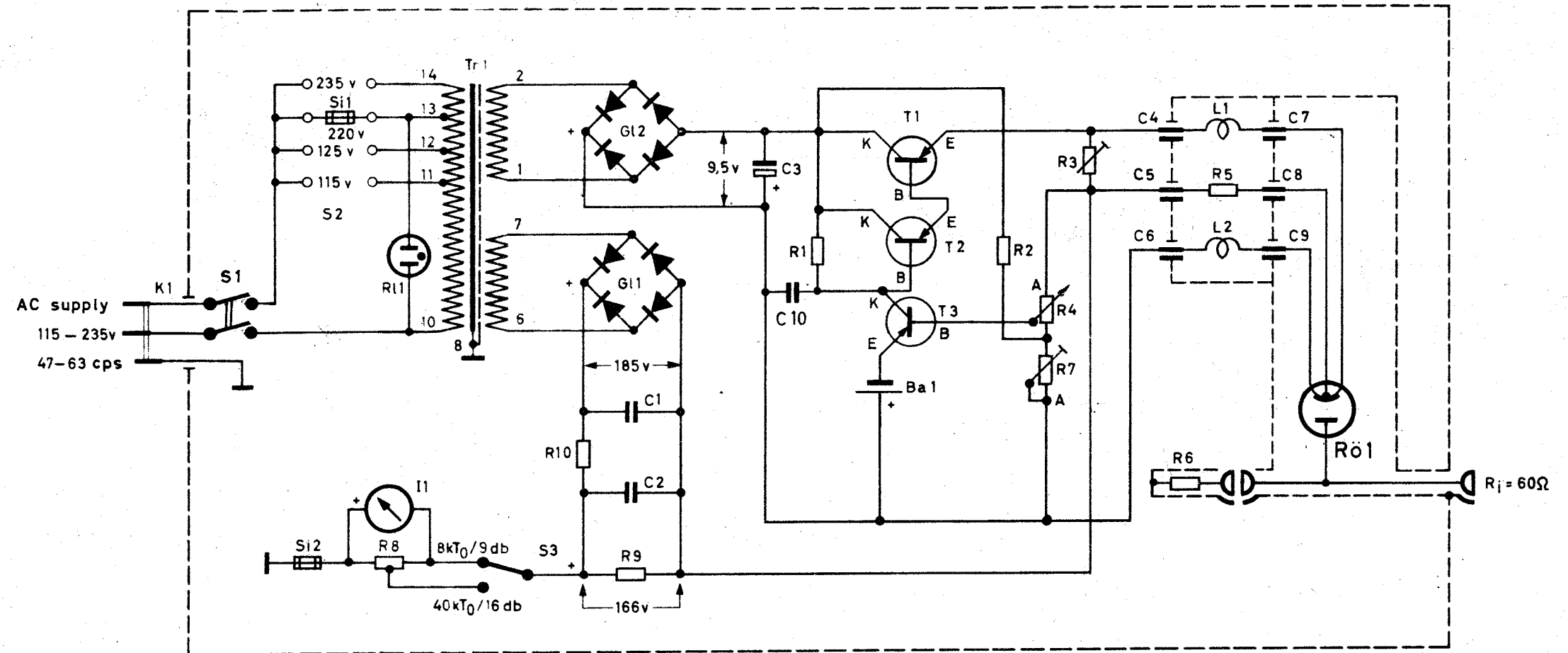
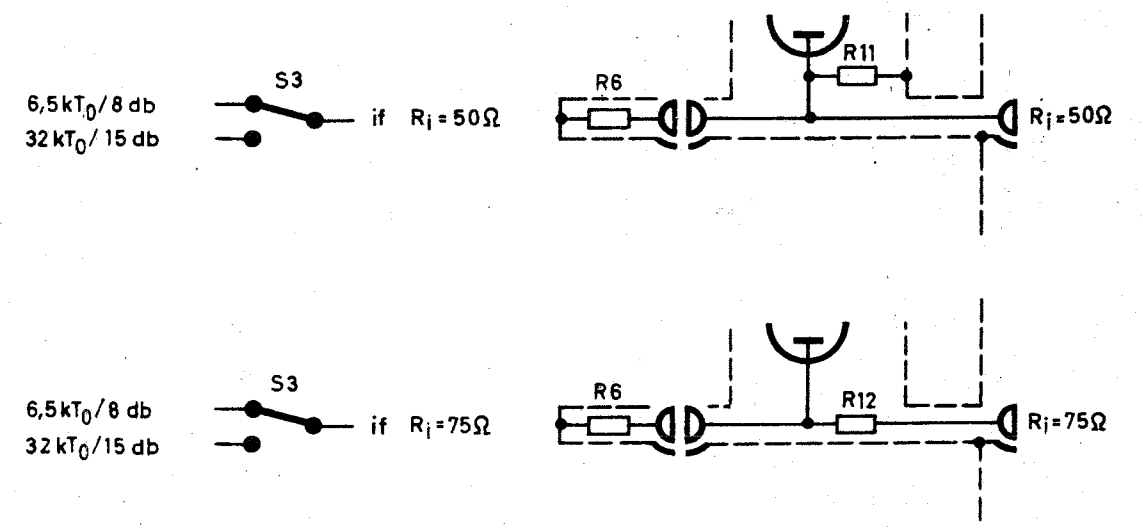
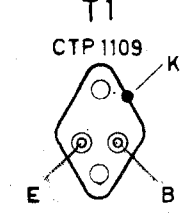
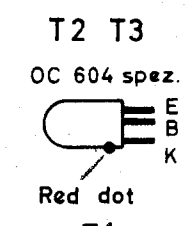
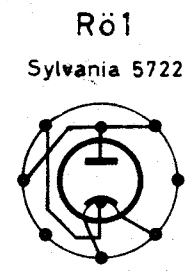

Fig.4
 For conversion of the noise
 figure from kT_o to db and vice versa

R8508
 663
 Bl. 22



Ä-Z., b" Nr. 5909



Voltages measured with high-impedance meter adjusted for 32 to 40 kT₀

NOISE GENERATOR
Type SKTU