

# INSTRUCTION MANUAL

Type MS111  
STANDARD-SIGNAL GENERATOR



## RADIOMETER

ELECTRONIC MEASURING INSTRUMENTS  
FOR SCIENTIFIC AND INDUSTRIAL USE

INSTRUCTION AND OPERATING MANUAL  
FOR

Type MS111  
STANDARD-SIGNAL GENERATOR

These instructions apply to  
type MS111 b instruments only



## Standard-Signal Generator type MS111

10 kc/s - 110 Mc/s

### Introduction

The type MS111 Standard-Signal Generator is designed as a precision laboratory instrument. Owing to its sturdy construction and its speed and simplicity of operation, however, it is also suitable for production testing of radio receivers and other instruments operating at radio or supersonic frequencies.

### Special features

- Extremely wide frequency range: 10 kc-110 Mc.
- Very low envelope distortion up to 90 % AM.
- No side-band clipping.
- Very low reaction of attenuator setting on frequency.
- Very low incidental frequency modulation.
- RF output level nearly constant through the entire frequency range up to 47 Mc.
- Electronically regulated power supply.

### Description

The type MS111 Standard-Signal Generator contains a carrier frequency oscillator followed by a grid modulated output stage which feeds two resistive attenuators in series. One attenuator has 2 dB steps, the other has 20 dB steps. The attenuator input voltage is measured by means of a vacuum-tube voltmeter. A built-in 400 cps oscillator can be used for amplitude modulation. The power supply is electronically regulated. The frequency range from 10 kc to 110 Mc is covered

in 12 ranges with 3 ranges per decade providing for a total scale length of 2.5 meters.

The rather small frequency variation of 1:2.2 on each range provides for a nearly constant RF output without the complication of an automatic level-control system. The output level is generally within  $\pm 1$  dB between 10 kc and 22 Mc, within  $\pm 2$  dB on the 21 Mc to 47 Mc range, and within  $\pm 3$  dB on the 46 to 110 Mc range.

The main dial has three frequency range engravings, each with an index which is illuminated when in use. The frequency is read directly in kc or Mc or is had after multiplying by 10.

An aperiodic output amplifier stage provides for the amplitude modulation and gives very low incidental FM and side-band cutting. The modulation percentage is read on the dial of the meter, which can be switched over from CARRIER to MOD. measurement.

The attenuator system is resistive and consists of a 2 dB step attenuator with 10 steps and a 20 dB step attenuator with 4 steps. The diode voltmeter monitoring the attenuator input has a negligible zero drift.

Two attenuator output terminals provide for 10 ohm and 75 ohm output, and a high level output jack provides for either a 200 ohm output or an inductive output capable of supplying about 0.5 watt to a 5 kilohm load when tuned to resonance with the oscillator in the 10 kc to 1 Mc range. The short-circuit current is max. 15-20 milliamps.

**SPECIFICATIONS:**

*Carrier frequency range:*

10 kc to 110 Mc in 12 direct reading ranges:

10-22 kc	1-2.2 Mc
21-47 -	2.1-4.7 -
46-110 -	4.6-11 -
100-220 -	10-22 -
210-470 -	21-47 -
460-1100 -	46-110 -

3 individual frequency dial engravings, each with an index, which is illuminated when in use.

*Frequency calibration:*

Accuracy:  $\pm 0.2$  to  $\pm 0.5$  % from 21 kc to 47 Mc, about 1.5 % from 10 kc to 22 kc and from 46 Mc to 110 Mc. Incremental frequency dial with 100 divisions.

*Frequency stability:*

Drift during warm-up period: about 0.2 % from 21 kc to 47 Mc. Half the max. drift is reached in about 1 hour.

*RF frequency response:*

- About  $\pm 1$  dB from 10 kc to 22 Mc.
- $\pm 2$  - - 21 Mc to 47 Mc.
- $\pm 3$  - - 46 Mc to 110 Mc.

*RF output:*

- 1) 0.2  $\mu$ V to 200 mV emf from attenuator output in 2 dB and 20 dB steps. Reading in micro-volts and dB over 1  $\mu$ V. Attenuator input continuously adjustable and monitored by vacuum-tube voltmeter covering 0.2 to 2 volts, provided with an additional dB scale.
- 2) 0.2 to 2 volts emf from a separate 200 ohm jack or max. about 1 volt unmodulated at the end of a correctly terminated cable on practically the entire frequency range.
- 3) Max. about 130 volts over a circuit connected to the 2 V jack and tuned to the carrier frequency with disconnected attenuator. When the circuit is loaded with 5 kilohms: max. about 50 volts from 10 kc to about 1 Mc (equivalent to 0.5 watt).

*Output impedance:*

At the upper attenuator jack: 10  $\Omega$ .  
 At the lower attenuator jack: 75  $\Omega$  (or 50  $\Omega$ ) 10  $\Omega$  higher on the 20-200 millivolt range.  
 At the 0.2-2 V jack: about 200  $\Omega$  or with disconnected attenuator: 50  $\mu$ H to 16 mH in parallel with about 50 pf, depending on the RF range chosen.

*Accuracy of output voltage:*

The voltmeter monitoring the 2 volt input of the attenuator is correct within 0.2 dB on the 10 kc-10 Mc range, within 0.5 dB on the 10 Mc-110 Mc range.

The attenuator accuracy is:  
 below 10 Mc: 0.5 dB  $\pm 0.2$   $\mu$ V  
 10-30 Mc: 1 dB  $\pm 0.5$   $\mu$ V  
 30-100 Mc: 1.5 dB  $\pm 1$   $\mu$ V

*Internal modulating oscillator:*

400 cps  $\pm 3$  %.  
 Distortion: less than 0.3 %.  
 Hum: less than 0.05 %.

*Amplitude modulation:*

Adjustable from zero to 90 %. Indication on meter accurate within 5 % at percentages over 30. External modulation characteristic flat within 1 dB from 20 cps to 10 kc. To provide 90 % modulation the external oscillator must supply about 11 volts into a 5 kilohm load at 1 kc.

*Incidental frequency modulation:*

30 cps per megacycle at 30 % modulation at frequencies below 30 Mc. About three times as great on the highest frequency range.

*Envelope distortion:*

About 0.5 % at 30 % modulation, about 1.5 % at 80 % modulation, and 3 to 5 % at 90 % modulation with 400 cps.

*Carrier noise level:*

Equivalent to less than 0.1 % modulation.

*Carrier distortion:*

About 7 %.

*Leakage:*

Double shielding provides for negligible stray fields.

*Power supply:*

112-125-150-200-220 and 240 volts, 50-60 cps.  
 Consumption: 65 watts.

*Tubes:*

- |                     |                   |
|---------------------|-------------------|
| 1 type EC81 or 6R4. | 2 - PL81 or 21A6. |
| 1 - EL83 or 6CK6.   | 1 - PCF80 or 8A8. |
| 1 - EAA91 or 6AL5.  | 1 - 85A2 or 5651. |

*Over-all dimensions:*

Height: 380 mm. Width: 560 mm. Depth: 270 mm.  
 Front panel complies with 19" standard.

*Mounting and finish:*

Steel cabinet finished in grey enamel.

*Weight:*

22 kilos.

*Extra accessories:*

Type SP15 Voltage Divider provides for 40 dB attenuation when connected to a 50 ohm generator outlet. Output impedance: 1 ohm.  
 Type KA15 Dummy Antenna complies with the 1948 standard of the I.R.E.  
 Type TL15 Test Loop also complies with the above standards. The field strength in volts per meter at a distance of 0.6 m from the test loop is equal to one tenth of the signal generator reading in volts.

Data subject to change without notice.



INDEX

Introduction	data sheet 15203	
Description	" " "	
Specifications	" " "	
		page
 <b>SECTION I - GENERAL DESCRIPTION</b>		
1-1 Operating principle		1-1
1-2 The radio frequency oscillator		1-1
1-3 The modulating amplifier		1-2
1-4 The modulation oscillator		1-3
1-5 The attenuator system		1-4
1-6 The Vacuum-Tube Voltmeter		1-5
1-7 The modulation meter		1-6
1-8 The power supply		1-6
1-9 Extra accessories		1-7
 <b>SECTION II - OPERATING INSTRUCTIONS</b>		
2-1 Connection		2-1
2-2 Controls, dials and terminals		2-1
2-3 Step-by-step operation		2-2
 <b>SECTION III - MAINTENANCE</b>		
3-1 General		3-1
3-2 Removing the instrument from the cabinet		3-1
3-3 Tube replacement		3-1
 Wiring diagram		 appendix

## SECTION I

## GENERAL DESCRIPTION

## 1-1 OPERATING PRINCIPLE

The Signal Generator consists of an unmodulated radio-frequency oscillator followed by an aperiodic modulating stage feeding two attenuators connected in cascade. The input voltage of the attenuators is measured by means of a diode voltmeter.

The modulation can be accomplished either by means of a 400 cps built-in oscillator or by means of an external tone generator. The meter can be switched over to measure the percentage modulation.

The power supply is electronically regulated.

## 1-2 THE RADIO FREQUENCY OSCILLATOR

The oscillator tube (tube No. 1) is operated as a Collpit oscillator with a split-stator tuning condenser having silver-plated brass plates and carefully made ball bearings in order to avoid back-lash. The total range from 10 kc to 110 Mc is covered in 12 sub-ranges, each decade having 3 ranges. The frequency dial is individually engraved in the 3 ranges from 210 kc to 2.2 Mc, and the accuracy is about 0.2% in these 3 ranges after the warm-up period. Outside the 0.21-2.2 Mc range the accuracy is better than 0.5% except for the first and the last range where the accuracy is about 1.5%. The 12 coils are mounted in a coil turret and all of them, except coil No. 1, can easily be removed by pressing outwards the appropriate "spoke" of the bronze wheel so that the stamping with the coil snaps out of the slot in the aluminum wheel.

Coil No. 1 is furnished with a small bracket at the end nearest to the shaft of the drum. This bracket is pressed against the aluminum wheel by means of a strap and a screw. The screw is accessible through a hole just above the rear bearing when the coil is in the top position next to the operating position.

The iron cores of the coils are secured in their position by nylon nuts. A PVC washer between the coil form and the nut provides for the smooth travel of the core.

The frequency dials has a coarse tuning knob and a fine tuning knob with a dial with 100 divisions. The friction drive used for the fine tuning is provided with ground driving wheels and accurate bearings providing for a very constant gearing and minimum backlash.

The RF voltage fed to the modulating stage is fairly constant through the ranges and generally it varies only about  $\pm 1$  db with the exception of the two ranges from 21 to 110 Mc. The frequency drift during the warm-up period depends somewhat on the frequency and is about 0.2%. Half the drift is present after the first hour. On the first range from 10 kc to 22 kc the drift is somewhat greater (it amounts to some hundred cycles).

### 1-3 THE MODULATING AMPLIFIER

consists of an output pentode operating with grid modulation. Both the RF and the AF signals are fed to the grid. The RF components of the anode current are stopped by an anode choke and fed to the 2 db step-attenuator. The choke is switched simultaneously with the coils of the oscillator in order to operate the modulating tube with an anode impedance as small as possible. By this means the inevitable AF output voltage from the modulating oscillator is kept at a minimum. Nevertheless the modulation trapezium viewed on the cathode ray tube of an oscilloscope will look distorted unless the RF frequency is very much higher than the modulating frequency or unless the small residual superimposed AF voltage is filtered out by means of a high-pass filter inserted between the signal generator and the oscilloscope. In fact the envelope distortion is completely independent of the superimposed AF voltage, and this voltage will in most cases be of no importance.

The envelope distortion is to some extent dependent on the modulating tube, but almost all tubes give a distortion of less than 3% at 80% modulation and generally there is no difficulty in finding a tube giving only about 1.5% distortion at 80% modulation with 1 kc. At 30% modulation the distortion is then about 0.3% and at 90% modulation somewhere between 2 and 5%. If the modulation percentage is so defined that the energy contained in the side bands is measured in proportion to the energy in the carrier instead of comparing the amplitudes, 100% modulation is obtainable by setting the meter to the last red line on the scale. The distortion at 1 kc is generally less than 5% but it will rise

in the case of over-modulation. The hum modulation is less than 0.1%. Owing to the aperiodical modulation there is no side-band clipping.

The modulation can be accomplished either by means of the built-in 400 cycle oscillator or by means of an external AF generator connected to the AF terminals. The input impedance is about 10 k $\Omega$ , and about 4 volts are required for 30% modulation. The modulation characteristic is flat within 1 dB from 20 cps to 10 kc at carrier frequencies higher than 200 kc. The modulation percentage is read on the built-in meter with the meter switch in position MOD. The accuracy is about 5%.

The modulation percentage is independent of the setting of the carrier output. The very loose coupling between the modulating tube and the RF oscillator provides for the very low frequency modulation of 30 cycles per megacycle at 30% - 400 cps - modulation at frequencies below 30 Mc. At 45 Mc there is about 5 kc FM at 30% AM, at 48 Mc there is about 0.4 kc FM and at about 90 Mc a maximum of 10 to 30 kc FM.

Due to the square law  $i_a$ - $V_g$  characteristic of the modulating tube the RF output will have a second harmonic of about 7% with 2 volts at the attenuator. The distortion is proportional to the output voltage from the modulating tube.

#### 1-4 THE MODULATION OSCILLATOR

is a Wien Bridge R-C oscillator operating on 400 cps. The accuracy is 3%, and the distortion is less than 0.3% - generally only about 0.1%. The hum is less than 0.05% - generally about 0.03%. Thus it is possible to take advantage of the low modulation distortion of the output tube also with the built-in 400 cycle oscillator used for modulation.

The oscillator operates by means of the triode part of tube No.4 and by means of tube No.5. It starts operating when the switch MODULATION is set to one of the positions INT. MOD. or 400 cps OUTPUT. The modulating voltage fed to the grid of the modulating tube is controlled by means of the knob MODULATION. The voltage is also present at the AF terminals when the switch MODULATION is set to position 400 cps OUTPUT. The maximum output voltage is about 20 volts. The output impedance is dependent on the setting of the knob and varies between 0 and about 2.5 k $\Omega$  with the knob in its mid-position. The output current



drawn must not exceed a few milliamps, otherwise the distortion will rise.

#### 1-5 THE ATTENUATOR SYSTEM

The output voltage from the modulating tube is fed to a three-position switch. With the switch in position ATT. the voltage is only present at the output jacks at the right-hand corner of the generator. With the switch in its mid-position the voltage is also present at the jack "RF 0.2-2 V EMF" and at this jack the maximum output voltage is had with the switch in position "Vmax". Two attenuators in cascade provide for an output voltage which can be set to any value between 2  $\mu$ V and 200 mV in 2 dB steps with full deflection of the voltmeter. Voltages between 0.2  $\mu$ V and 2  $\mu$ V can be had if the input at the attenuator is reduced correspondingly.

If the  $\mu$ V reading of the 2 dB step attenuator is multiplied by the factor reading of the 20 dB step attenuator, the output voltage is had in microvolts emf, provided that the meter reads 2 volts.

If the dB readings of the two attenuators and the meter are added up, the output level is had in dB over 1  $\mu$ V.

With the output switch set to position ATT. an input voltage of 2 volts to the attenuator is obtainable in the range from 10 kc to 46 Mc, and 1 volt in the highest frequency range.

The output impedance at one RF jack is 10 ohms for all positions of the 20 db step attenuator except for the x10,000 position where it is 23 ohms. At the other RF jack (immediately below) the impedance is 65 ohms higher, thus providing for correct termination of the 75 ohm cable.

The output impedance at the "0.2-2 V RF" jack is about 200 ohms. The output impedance is ostensibly zero, if the output meter is used for setting the output voltage to a preselected level to be maintained irrespective of variations in the load. With the output switch in position "Vmax" the attenuator is disconnected, and a maximum output current of 14-20 milliamps can be drawn when the output is short-circuited. The output impedance is dependent on the RF range chosen and it consists of the self-induction of the anode choke of the output tube in parallel with the capaci-

ty of the anode and all the components and the load connected to it. Output voltages of 100 volts or more can be had if the resonance frequency of the output circuit is in resonance with the oscillator, and the ohmic component of the load is 20 k $\Omega$  or more. Outputs between 0.2 and 0.7 watt to a 5 k $\Omega$  load are generally obtainable in the range 10 kc to 1 Mc, when tuning the output circuit to resonance with an external variable condenser.

The accuracy of the output voltage at the "0.2-2 V" jack is  $\pm 0.2$  db at frequencies below 12 Mc. With correct termination: 0.5 dB at 50 Mc and about 1.5 dB at 100 Mc with maximum obtainable deflection of the meter.

The accuracy of the attenuator is  $\pm 0.5$  dB  $\pm 0.1$   $\mu$ V at frequencies below 10 Mc and about  $\pm 1$  dB  $\pm 0.3$   $\mu$ V up to 47 Mc. On the highest frequency range: about 2 dB  $\pm 1$   $\mu$ V.

NOTE: The resistors of the 20 dB step-attenuator are rated for 0.1 watt and they will therefore only stand a current of about 0.1 amp. The attenuator should therefore never be exposed to voltages higher than 1 volt.

#### 1-6 THE VACUUM-TUBE VOLTMETER

operates with a double diode. One diode is used as rectifier and the other is used for compensating the initial current of the rectifying diode. The meter is connected directly to the diode through the variable resistor P2 which provides for calibration of the sensitivity. The zero setting resistor P1 is accessible through a hole in the front panel, but once set it will not be necessary to use it often. The diode introduces some distortion of the output voltage, but it reduces the second harmonic originating from the output tube so much that the resulting distortion is not greater with the diode than without.

The voltmeter measures the input voltage of the attenuator system and the voltage at the "0.2-2 V" jack, if this jack is connected to the attenuator by setting the output switch to position "2 V".

The dial of the meter is provided with a division for every 0.1 volt on the range 0.1 to 2 volts. The 2 volt division has to be used in order to make the attenuator dials direct reading. For convenience this division

is marked in red. There is a dB scale below the volt scale. Together with the dB figures of the attenuator dials it gives the output level in dB over 1  $\mu$ V. Output voltages within the 2 dB steps of the attenuator can be read from the upper scale with an almost maximum reading accuracy because only the upper end of the scale should be used.

While adjusting the carrier, the modulation must be switched off if the modulation percentage exceeds 30% or if the modulation frequency exceeds 1 kc, otherwise there is a risk of getting wrong indication due to the a-f voltage present at the diode.

#### 1-7 THE MODULATION METER

The meter is switched to measure the modulation percentage when the METER switch is set to position MOD.

The a-f voltage fed to the grid of the modulating tube is measured by means of 2 Germanium diodes as rectifiers. The rectified voltage is fed to the meter through the variable internal resistor P4 - "Calibration of M% Meter".

The frequency range is 30-15,000 cycles and the accuracy of indication is 5% at modulation percentages higher than 30.

#### 1-8 THE POWER SUPPLY

is electronically regulated with tube No.6 operating as series tube and the penthode section of tube No.4 operating as amplifier. The bridge connected selenium rectifiers are so rated that a lifetime exceeding 50,000 hours may be expected.

The regulated output voltage is 160\*volts, and all tubes except the anode of No.5 are operated at that voltage.

The instrument operates from a 50-60 cps power line and can be adjusted to the following voltages: 112-125-150-200-220 and 240 volts. The line fuse is mounted on the front panel and so is the power supply fuse which protects the selenium rectifier against damage in case of short-circuit in the electrolytic buffer condenser.

The consumption is about 65 watts.

## 1-9 EXTRA ACCESSORIES

The type SP15 Voltage Divider provides for 40 dB attenuation when connected to a signal generator with  $50\Omega$  output impedance.

The voltage divider consists of a  $49\Omega$  resistor in series with a  $1\Omega$  resistor across which the output voltage is present. The  $1\Omega$  resistor is of the disk type with negligible self induction providing for a uniform frequency response. The etched cover plate of the small cast box containing the resistors carries the circuit diagram. The two jacks of the box fit the PL259 plug of the cable supplied with the generator.

The type KA15 Dummy Antenna complies with the 1948 standards of the Institute of Radio Engineers. The etched cover of the small cast box containing the components carries the circuit diagram. The Dummy Antenna is connected to the signal generator by means of the cable supplied.

Use the  $10\Omega$  jack at frequencies up to about 4 Mc. At higher frequencies use the  $75\Omega$  jack.

The type TL15 Test Loop complies with the 1948 standards of the Institute of Radio Engineers.

The Loop is 0.25 m in diameter and consists of a three-turn winding in a copper tubing for electrostatic shielding. A  $403\Omega$  resistor is connected in series with the winding and mounted in a small housing at the base of the loop. The resistance is proportioned to make the field strength in volts per meter at an arbitrary distance of 0.6 m (24 inches) equal to one tenth of the signal generator reading in volts. The transmitting loop is to be connected to the  $10\Omega$  jack of the signal generator. The loop current will be approximately uniform up to about 20 Mc with a cable length of about 1.2 m.

## SECTION II

### OPERATING INSTRUCTIONS

#### 2-1 CONNECTION

Before switching on the instrument, make sure that the power line has been connected to the correct soldering tag of the transformer. The tags are numbered from 2 to 7 and correspond to the following voltages: 112-125-150-200-220 and 240 volts. When the instrument leaves the factory, the 220 volt tag is connected to one of the line plugs on the front panel. When switching over to another voltage, take care to set the pointer of the voltage scale below the line plug to the line voltage used.

The instrument is switched on with the power switch OFF ON and should be allowed to warm up for a few minutes.

#### 2-2 CONTROLS, DIALS AND TERMINALS

##### (a) Frequency controls

The main tuning dial has 3 engravings covering one decade. The frequency is read either directly in kc or Mc or is had after multiplying the reading with 10, depending on the setting of the range switch.

The range switch has 12 positions and covers the range from 10 kc to 110 Mc.

The main dial can be turned either by means of the big knob mounted on it or by means of the fine tuning knob through a friction drive.

The dial of the fine tuning knob has 100 divisions, and each division represents a detuning of max. 0.1%.

##### (b) Output controls

The output level is set by means of the two attenuators and the knob CARRIER. The attenuators are direct reading in microvolts when the CARRIER is so set that the meter reads 2 volts. The output level in dB over 1  $\mu$ V is had by adding up the dB readings of the attenuators and the meter.

## (c) Modulation controls

The switch MODULATION allows the signal generator to be modulated either by means of the built-in 400 cycle generator or by means of an external generator operating in the range 30-15,000 cps.

The modulation percentage is read on the meter with the METER switch in position MOD. and the modulation percentage is controlled by means of the knob MODULATION.

## (d) Terminals

The power input terminals provide for connecting to the jack connector of the type C12H13-1.5 power cord which is supplied with the Signal Generator.

The RF output terminals fit the American type UHF connector No. PL259. A 1 m long type C3A3 output cable provided with a UHF connector at both ends and having a characteristic impedance of 75  $\Omega$  is supplied with the instrument.

The AF terminals are used for connecting the external audio frequency generator to the signal generator. The input impedance is 10 k $\Omega$ , and about 10 volts are required for 90% modulation.

With the MODULATION switch in its mid-position the 400 cycle voltage from the built-in generator is available across the AF terminals. The output voltage depends on the setting of the knob MODULATION.

## 2-3 STEP-BY-STEP OPERATION

- (1) Set the line voltage selector to the voltage on which the instrument is to operate.
- (2) Connect the instrument to the power line, switch it on, and allow it to warm up for some minutes.
- (3) Set the METER switch to its mid-position and check the mechanical zero of the meter.
- (4) Set the METER switch to position CARRIER and the knob CARRIER to zero. Adjust the VTVM ZERO potentiometer by means of a screw driver (at least 100 mm - 4 inches - long) so that the meter reads zero again.

- (5) Set the RANGE switch knob to the appropriate range in order to obtain the desired output frequency, and set the main dial to that frequency. Use the illuminated index.
- (6) Set the knob CARRIER so that the meter reads 2 volts with the RF output switch at position ATT.  
  
Only 1 volt is guaranteed on the range 46-110 Mc.
- (7) Set the MODULATION switch to position INT. or 400 cps OUTPUT in the case of internal modulation, or to position EXT. in the case of modulation from an external generator. Connect the external generator to the terminals AF. Do not use position 400 cps OUTPUT with an external generator connected in the case of external modulation.
- (8) Set the METER switch to position MOD. and rotate the knob MODULATION until the meter reads the percentage required.
- (9) Connect the load to the 10 ohm RF jack when operating at low radio frequencies (10 kc to about 5 Mc) thus avoiding calculations if the impedance of the load is greater than 200 ohms. Use the 75 ohm jack and the 75 ohm cable at higher frequencies and terminate the cable in a 75 ohm resistor in order to avoid reflections. The voltage at the terminating resistor will then be half the emf output voltage read on the attenuator dials.

Connect the load to the "0.2-2 V" jack if a voltage within this interval is required, and set the output switch to 2 V. Terminate the 75  $\Omega$  cable in a 75  $\Omega$  resistor in order to avoid reflections at frequencies higher than 5 Mc. The voltage read on the meter will then be present at the end of the cable, but it is reduced to about 0.5 volt. If somewhat higher distortion of the output voltage can be tolerated, about 1 volt unmodulated is obtainable in the major part of the frequency range.

Set the RF output switch to position Vmax if a voltage higher than 2 volts or the maximum current obtainable is required. The meter has now been disconnected and the voltage at the load has to be measured with an external voltmeter. The maximum output voltage obtainable depends on the load and amounts to about 120 volts, if the output circuit is in resonance with the oscillator frequency.

### SECTION III

#### MAINTENANCE

#### 3-1 GENERAL

The type MS111 Signal Generator is of a sturdy design and will offer long troublefree service, if only the following precautions are taken:

The instrument should be protected against excessive moisture and, when operating, against elevated temperatures. To ensure free circulation of air the instrument must rest on its rubber feet, not directly on the bottom, and the top louvres must not be covered with papers or the like.

#### 3-2 REMOVING THE INSTRUMENT FROM THE CABINET

The instrument can easily be removed when the four fixing screws along the edge of the front panel have been removed.

#### 3-3 TUBE REPLACEMENT

It is generally not necessary to replace the tubes until they give rise to some kind of trouble, such as: no or insufficient output, no or faulty modulation, abnormal dependence on line voltage, etc.

Tube No. 1 is a type EC81 or 6R4 operating as RF oscillator. The tube is placed inside the oscillator box, which is taken apart by loosening all the screws pressing the big part of the box between the two lids (one lid is placed inside the other) and pulling out the big part. Replacement of the tube may sometimes involve an adjustment of the trimmers. The trimming, however, should not be made until the generator has been switched on for some hours.

All faultless specimens can be used.

Tube No. 2 is a type PL81 or 21A6 operating as modulator with grid modulation. Almost all specimens can be used and about half of a batch of tubes without making any adjustments. As the envelope distortion is dependent on the tube, this distortion should always be checked after a tube replacement. This is readily done by measuring separately the



side bands arising by the modulation by means of the type FRA 2 RADIO-METER Wave Analyzer, which is a very selective superheterodyne receiver with double conversion. As the first intermediate frequency is 50 kc and the first oscillator operates on the range 50 kc to 34 kc, the two measuring ranges from 0-16 kc and from 100-84 kc are covered. By setting the dial to 3 kc the instrument also becomes sensitive to 97 kc, and if the Standard Signal Generator operates at this frequency and e.g. is modulated with 400 cps, the carrier is found on the dial at 3 kc and the desired side bands of first order at 3.4 kc and 2.6 kc. The side bands which are due to the distortion of the modulation are located at 3.8 kc - 4.2 kc - 4.6 kc and so on, and are symmetrical with respect to 3 kc. The side bands due to hum are located at 3050-3010 and 30150 and so on, and are measured with the 2 cps band-width of the Wave Analyzer (see the appended data sheet on the type FRA 1 Wave Analyzer).

The cathode of tube No. 2 operates on about 18 volts, and the anode and screen grid on about 160 volts. If it is impossible to find a tube with about 1.5% distortion at 80% modulation with 400 cps, it may be an improvement to alter the 20 ohm unsurpassed part of the cathode resistor somewhat.

Tube No. 3 is a type EAA91 or 6AL5 double diode which can be replaced right away. After the replacement set the zero, check the sensitivity and correct the setting of the potentiometer P2 - CAL OF VTVM, if required. The check is easily made by measuring e.g. a 100 kc unmodulated output voltage of 2 volts at the 2 V jack with an external voltmeter which measures rms values or mean values and which has an input impedance of some kilohms in order not to increase the distortion from the output tube.

Tube No. 4 is a type PCF80 or 8A8. The penthode section of the tube is used as amplifier of the electronically regulated power-supply. Check the hum of the 160 volt output from the regulated power-supply after replacement. The hum should be less than 2 millivolts. A normal tube gives a reduction of the 100 cps hum at the anode of tube No. 6 of about 37 dB or 70 times. The 50 cps and 150 cps hum is generally 10 to 20 dB lower than the 100 cps hum. If the hum is not measured with a Wave Analyzer but with an ordinary vacuum-tube millivoltmeter, it is neces-

sary to stop the 400 cps oscillator by setting the switch MODULATION to position EXT. At 90% modulation with 400 cps a 400 cps voltage of about 50 millivolts is present at the 160 volt terminal and about 0.5 volt at the 260 volt terminal.

The triode part of the tube is used as first amplifier of the 400 cps oscillator. The potentials and the 400 cps voltages at the electrodes of the tube are to some extent dependent on the lamp in the cathode lead of the tube and on the 400 cps current fed to it from the output tube. Typical values are: 1.6 V d-c and 3.2 V a-c at the cathode - 32 V d-c and 2 V a-c at the anode. After replacement make sure that the distortion is less than 0.3% (generally it is about 0.15%) and that the hum is less than 0.05% (generally it is about 0.03%) measured with 10 V output at the AF jacks.

Tube No. 5 is a type EL83 or 6CK6 operating as output tube of the 400 cps oscillator. The d-c voltage at the cathode is about 2.6 volts and the 400 cps voltage about 1 volt. At the anode the values are about 15 to 20 volts 400 cps - depending somewhat on the lamp in the cathode lead of tube No. 4 and the resistor connected to it. Make sure that the distortion is sufficiently low after replacement of the tube.

Tubes No. 4 and 5 can generally be replaced without any change in distortion. The distortion will rise only if the tubes are defective in some respect.

Tube No. 6 is a type PL81 or 21A6 operating as series tube in the electronically regulated power supply.

The voltage at the anode is about 250 volts. At the cathode it is about 160 volts. The 100 cps hum at the anode is about 140 millivolts and about 2 millivolts at the cathode.

The grid is about 7 volts negative referred to the cathode at nominal line voltage with the CARRIER control at zero, where the drain from the power supply is heaviest. With 10% lower line voltage the cathode-grid voltage is about minus 2.5 volts. If this voltage is about minus 1 volt, the tube is probably worn out and must be replaced.

Tube No. 7 is a type 85A2 or 5651 voltage reference tube which can be replaced right away.

The regulating lamp in the cathode lead of the triode part of tube No.4 operates with such a low current (about 3.5 mA) that the filament does not even glow, and generally the lamp will never have to be replaced. In case it should be damaged, however, it is very important to check the distortion of the 400 cps oscillator after the replacement. Perhaps the value of the resistor feeding a 400 cps current to the lamp from the output tube will have to be changed somewhat in order to obtain the low distortion mentioned under section "Tube No.4".

MEC Type O-24 Nr. 669-1

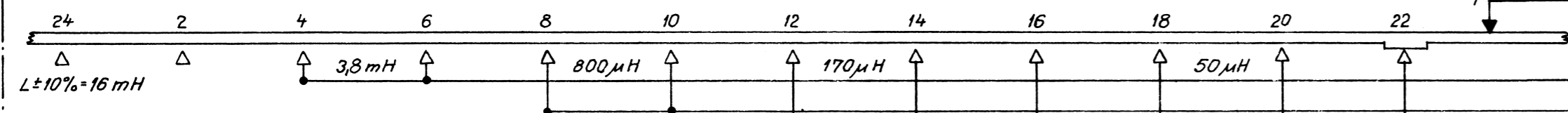

All Coils 4H  
Trimmer 2496  
4/20

POT 57 WT

10%  
keramisk

0,3 BM5

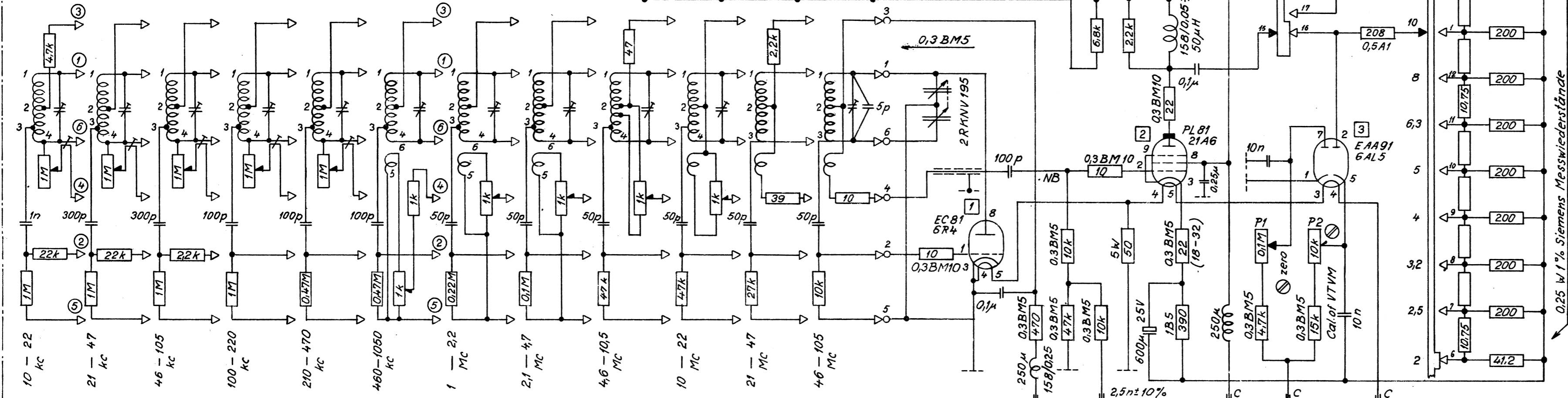

Spole nr. 1 2 3 4 5 6 7 8 9 10 11 12

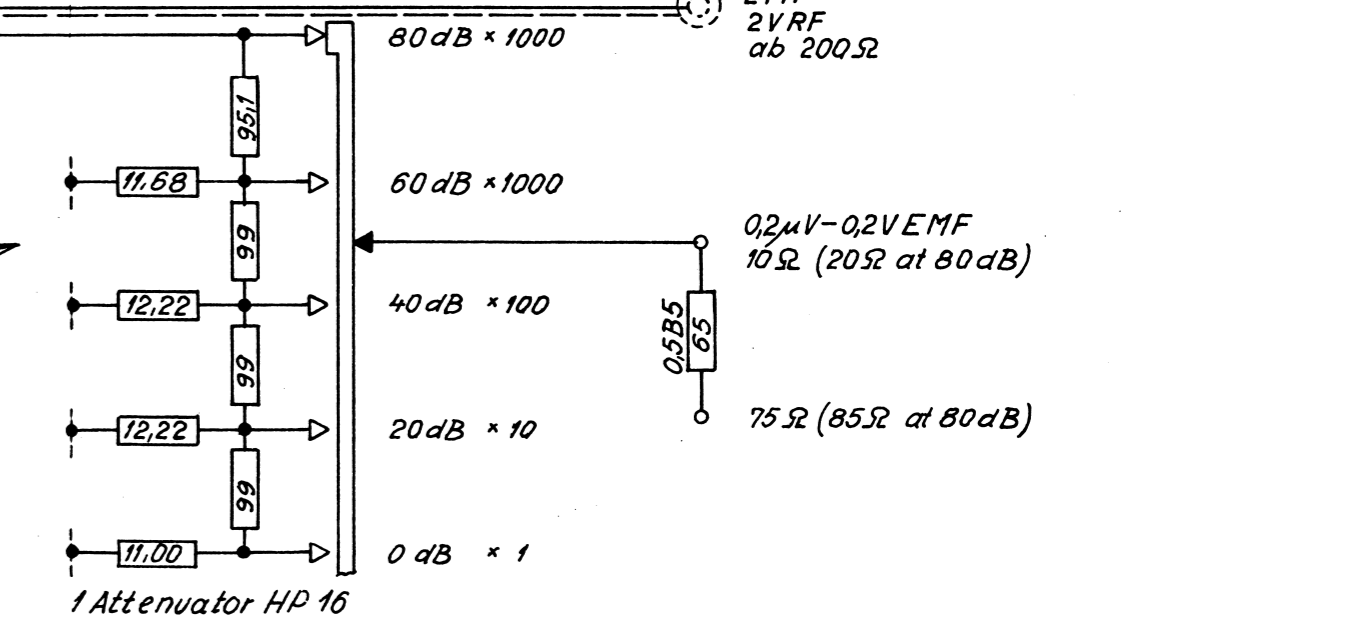

1 Attenuator HP 16

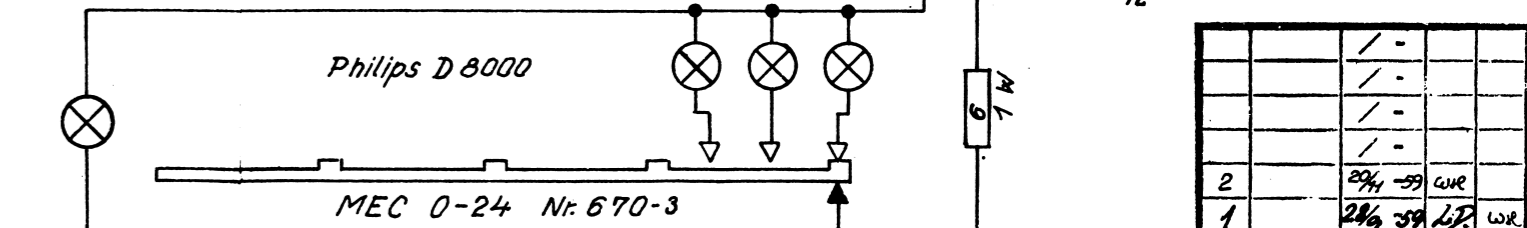
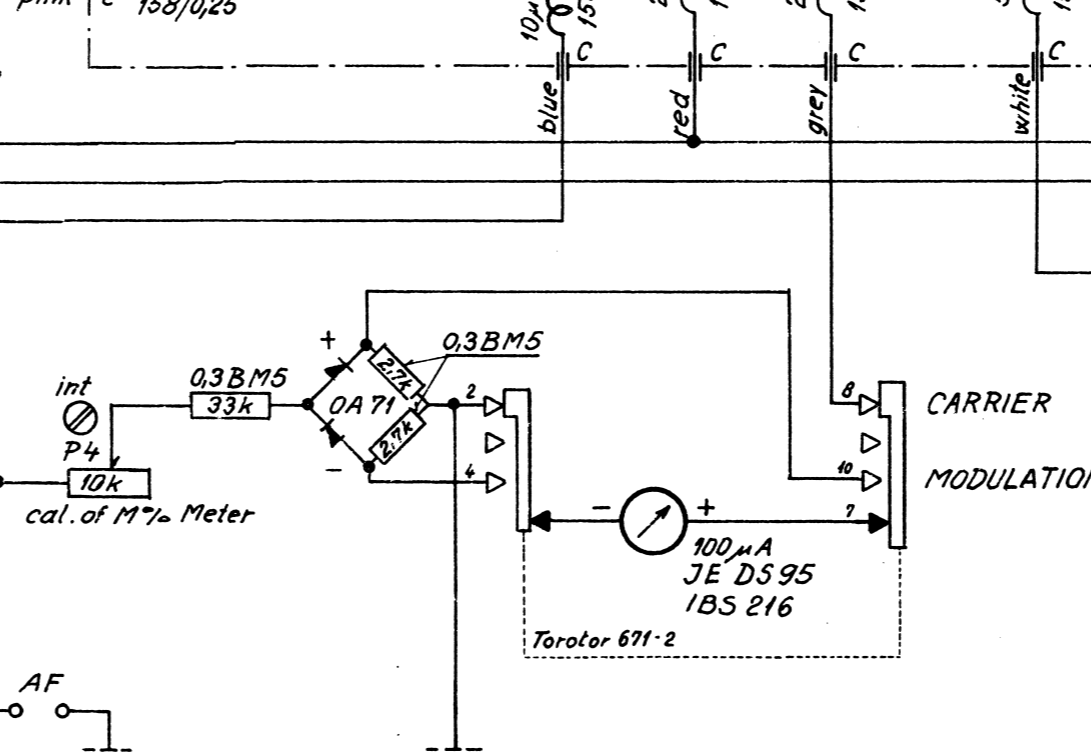
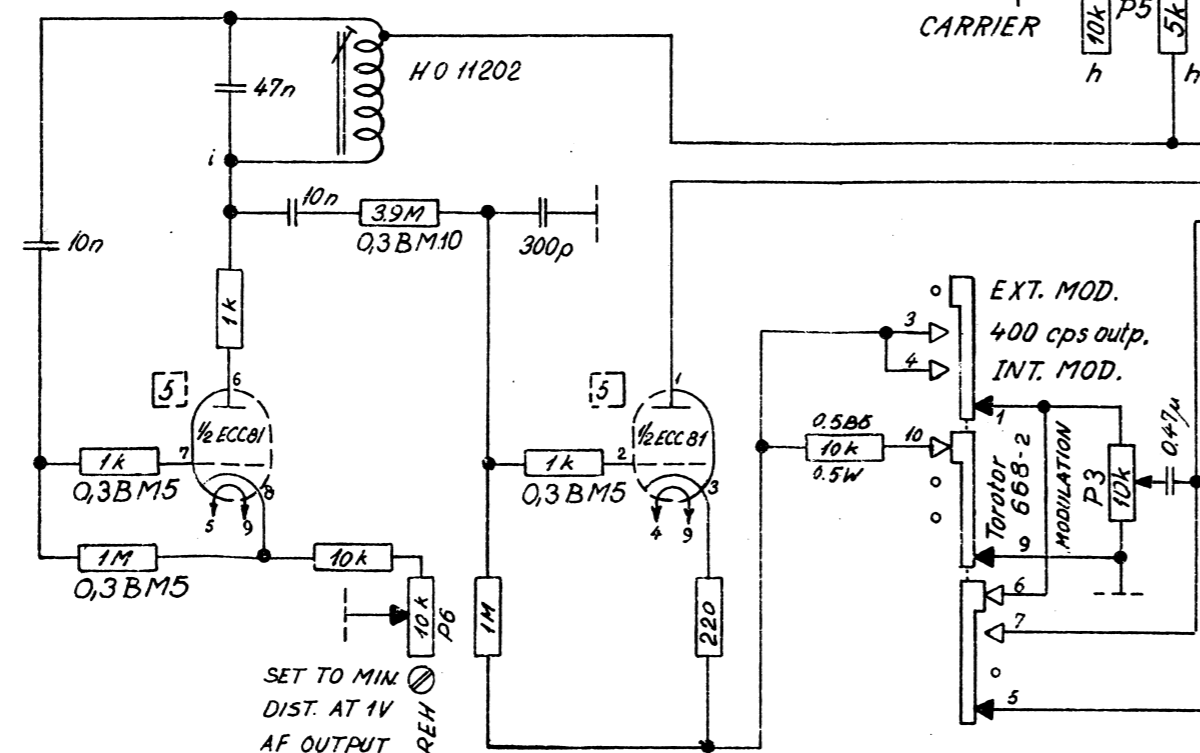
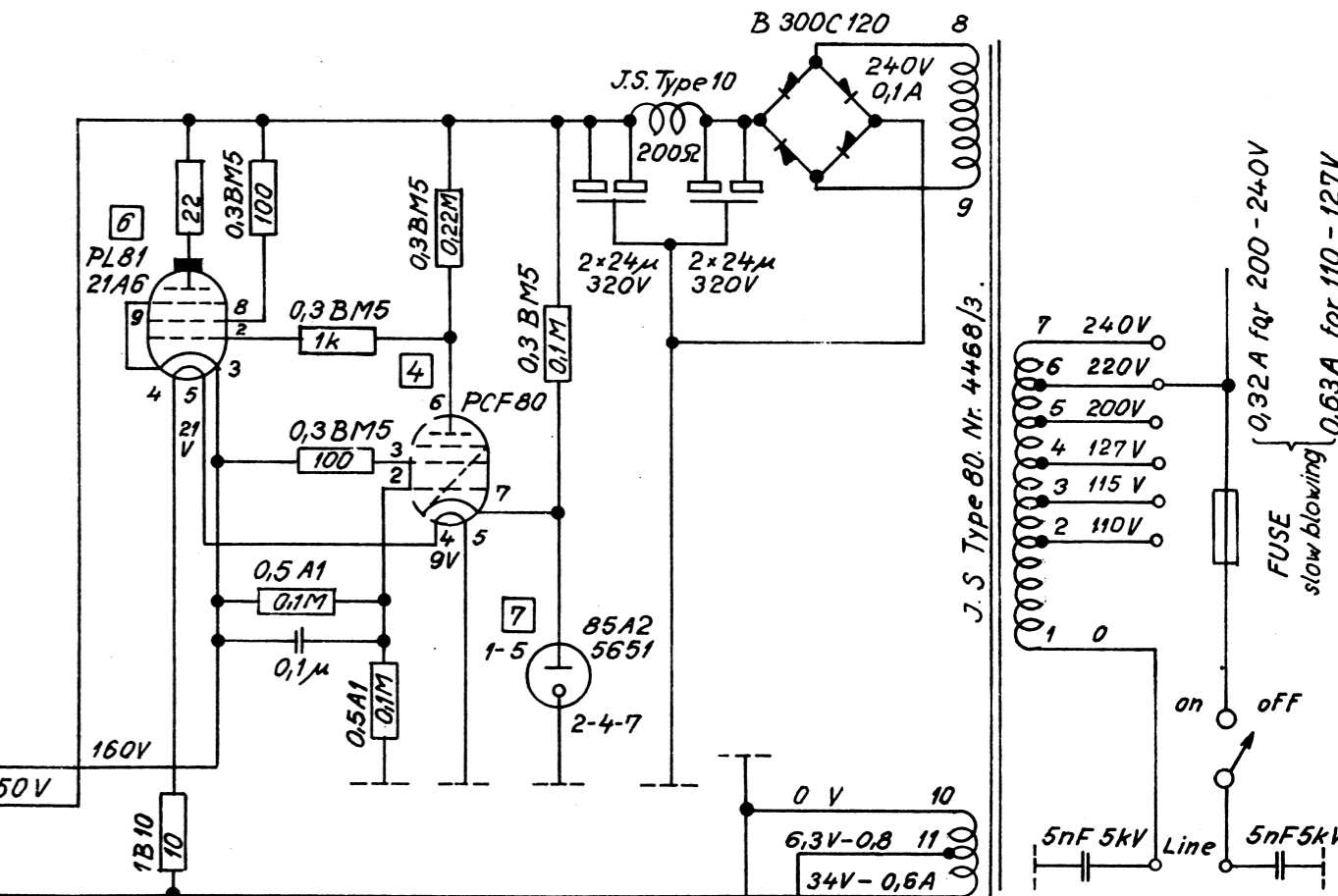

RADIOMETER  
COPENHAGEN  
This drawing must not be passed on to any person not authorized by us to receive it, nor be copied or otherwise made use of by such person without our authority

RADIOMETER  
KØBENHAVN  
Standard Signal Generator  
TYPE. MS 111b  
DIAGRAM. From no 30401 to no

1	2	3	4	5	6	7	8	9	10	11	12	13	14	15	16

Tegn. Van 186-59  
Konf. -  
Dato 24/59  
Erstatning: 1161-A2  
Erstet af