

PUBLICATION NO. R-OM-9087

ISSUE 2.2.84

9087

SYNTHESIZED SIGNAL
GENERATOR

RACAL-DANA

RACAL-DANA INSTRUMENTS INC.

4 Goodyear Street, PO Box C 19541, Irvine, Ca 92713, USA.
Telephone: (714) 859-8999. TWX: 910-595-1136, TLX: 678-341

RACAL-DANA INSTRUMENTS LTD.

Duke Street, Windsor, Berkshire SL4 1SB, United Kingdom
Telephone: Windsor (07535) 68101, TLX: 847013

RACAL-DANA INSTRUMENTS S.A.

18 Avenue Dutartre, 78150 Le Chesnay, France
Telephone: (3) 955-8888, TLX: 697 215

RACAL-DANA INSTRUMENTS GmbH

Hermannstrasse 29, D-6078 Neu Isenburg, Federal Republic of Germany
Telephone: 06102-2861/2, TLX: 412896

RACAL-DANA INSTRUMENTS ITALIA SRL

20161 Milano, Via Angeloni 8, Italy
Telephone: (02) 6459558/6468189 TLX: 315697

RACAL

PUBLICATION DATE: MAY 1983

Copyright © 1983 by Racal-Dana Instruments Ltd. Printed in England. All rights reserved.
This book or parts thereof may not be reproduced in any form without written permission of the publishers.

WARRANTY

Within one year of purchase, Racal-Dana will repair or replace your instrument, at our option, if in any way it is defective in material or workmanship. The instrument must be returned to the country of purchase, unless prior arrangement has been made, and Racal-Dana Instruments will pay all parts and labor charges. Just call Racal-Dana Product Service at (714) 859-8999 in U.S.A., Windsor (07535) 69811 in England, (3) 955-8888 in France, 06102-2861/2 in Germany or (02) 6459558/6468189 in Italy for assistance. We will advise you of the proper shipping address for your prepaid shipment. Your instrument will be returned to you freight prepaid.

PROPRIETARY NOTICE

This document and the technical data herein disclosed, are proprietary to Racal-Dana Instruments, Inc., and shall not, without express written permission of Racal-Dana Instruments, Inc., be used, in whole or in part to solicit quotations from a competitive source or used for manufacture by anyone other than Racal-Dana Instruments, Inc. The information herein has been developed at private expense, and may only be used for operation and maintenance reference purposes or for purposes of engineering evaluation and incorporation into technical specifications and other documents which specify procurement of products from Racal-Dana Instruments, Inc.

FOR YOUR SAFETY

Before undertaking any maintenance procedure, whether it be a specific troubleshooting or maintenance procedure described herein or an exploratory procedure aimed at determining whether there has been a malfunction, read the applicable section of this manual and note carefully the WARNING and CAUTION notices contained therein.

The equipment described in this manual contains voltage hazardous to human life and safety and which is capable of inflicting personal injury. The cautionary and warning notes are included in this manual to alert operator and maintenance personnel to the electrical hazards and thus prevent personal injury and damage to equipment.

If this instrument is to be powered from the AC line (mains) through an autotransformer (such as a Variac or equivalent) ensure that the common connector is connected to the neutral (earthed pole) of the power supply.

Before operating the unit ensure that the protective conductor (green wire) is connected to the ground (earth) protective conductor of the power outlet. Do not defeat the protective feature of the third protective conductor in the power cord by using a two conductor extension cord or a three-prong/two-prong adaptor.

Maintenance and calibration procedures contained in this manual sometimes call for operation of the unit with power applied and protective covers removed. Read the procedures carefully and heed Warnings to avoid "live" circuit points to ensure your personal safety.

Before operating this instrument:

1. Ensure that the instrument is configured to operate on the voltage available at the power source. See Installation Section.
2. Ensure that the proper fuse is in place in the instrument for the power source on which the instrument is to be operated.
3. Ensure that all other devices connected to or in proximity to this instrument are properly grounded or connected to the protective third-wire earth ground.

If at any time the instrument:

- Fails to operate satisfactorily
- Shows visible damage
- Has been stored under unfavorable conditions
- Has sustained stress

It should not be used until its performance has been checked by qualified personnel.

'POZIDRIV' SCREWDRIVERS

Metric thread cross-head screws fitted to Racal equipment are of the 'Pozidriv' type. Phillips type and 'Pozidriv' type screwdrivers are not interchangeable, and the use of the wrong screwdriver will cause damage. POZIDRIV is a registered trademark of G.K.N. Screws and Fasteners. The 'Pozidriv' screwdrivers are manufactured by Stanley Tools.

TABLE OF CONTENTS

| Section | Title | Page |
|---------|--|------|
| 1 | TECHNICAL SPECIFICATION | 1-1 |
| 2 | GENERAL DESCRIPTION | 2-1 |
| 2.1 | Introduction | 2-1 |
| 2.2 | RF Tuning | 2-1 |
| 2.3 | Frequency Sweep | 2-1 |
| 2.4 | RF Output | 2-1 |
| 2.5 | Modulation Facilities | 2-2 |
| 2.6 | Front Panel Setting Storage | 2-2 |
| 2.7 | Error Indications | 2-2 |
| 2.8 | Diagnostic Checks | 2-2 |
| 2.9 | Special Functions | 2-3 |
| 2.10 | Output Protection | 2-3 |
| 2.11 | GPIB Interface | 2-3 |
| 2.12 | External Step Switches | 2-4 |
| 2.13 | Maintenance | 2-4 |
| 3 | PREPARATION FOR USE | 3-1 |
| 3.1 | Packaging | 3-1 |
| 3.2 | Power Supply | 3-1 |
| 3.2.1 | AC Voltage Range Setting | 3-1 |
| 3.2.2 | Line Fuse | 3-1 |
| 3.2.3 | DC Fuses | 3-2 |
| 3.2.4 | Power Cord | 3-2 |
| 3.3 | Frequency Standard | 3-2 |
| 3.4 | External Step Switches | 3-2 |
| 3.5 | Battery Charging | 3-3 |
| 3.6 | Operator's Checks | 3-3 |
| 3.7 | Fitting the Fixed Rack Mounting Kit 11-1576 | 3-11 |
| 4 | OPERATING INSTRUCTIONS | 4-1 |
| 4.1 | Introduction | 4-1 |
| 4.2 | Description of Controls, Indicators and Connectors | 4-1 |
| 4.2.2 | Front Panel Items | 4-1 |
| 4.2.3 | Rear Panel Items | 4-5 |
| 4.3 | Switching On | 4-9 |
| 4.4 | Simplified Operating Procedure | 4-9 |
| 4.5 | Operating Instructions | 4-9 |
| 4.5.2 | Frequency | 4-11 |
| 4.5.3 | Frequency, Relative | 4-13 |
| 4.5.4 | Frequency, Sweep | 4-15 |
| 4.5.5 | Amplitude | 4-17 |
| 4.5.6 | Amplitude, Relative | 4-19 |
| 4.5.7 | Modulation, Amplitude | 4-22 |
| 4.5.8 | Modulation, Pulse | 4-24 |
| 4.5.9 | Modulation, Frequency | 4-26 |
| 4.5.10 | Modulation, Phase | 4-29 |
| 4.5.11 | Modulation, Mixed | 4-32 |
| 4.5.12 | Modulation, External Source | 4-33 |

TABLE OF CONTENTS (Continued)

| Section | Title | Page |
|---------|--|------|
| 4.5.13 | Increment | 4-34 |
| 4.5.14 | Step Size, Operator Set | 4-38 |
| 4.5.15 | Initialisation | 4-40 |
| 4.5.16 | Memory, Store | 4-41 |
| 4.5.17 | Memory, Recall (Normal) | 4-43 |
| 4.5.18 | Memory, Recall (Immediate) | 4-45 |
| 4.5.19 | Memory, Exchange | 4-47 |
| 4.5.20 | Standby | 4-49 |
| 4.5.21 | Special Functions | 4-50 |
| 4.5.22 | Error Codes | 4-53 |
| 4.5.23 | Reverse Power Protection Unit | 4-56 |
| 5 | OPERATION VIA THE GPIB | 5-1 |
| 5.1 | Preparation For Use With the GPIB | 5-1 |
| 5.1.1 | Introduction | 5-1 |
| 5.1.2 | Connections to the GPIB | 5-1 |
| 5.1.3 | Address Setting | 5-1 |
| 5.2 | Data Acceptance Modes | 5-3 |
| 5.3 | Display Updating | 5-4 |
| 5.4 | Data Output | 5-4 |
| 5.5 | The Instrument Status Data String | 5-5 |
| 5.6 | The Learn Mode | 5-6 |
| 5.6.1 | Introduction | 5-6 |
| 5.6.2 | Obtaining a Data String Output | 5-7 |
| 5.7 | Monitoring the Control Settings | 5-8 |
| 5.8 | SRQ and Status Byte Outputs | 5-12 |
| 5.8.1 | Status Byte Format | 5-12 |
| 5.8.2 | Status Byte Mask Register | 5-12 |
| 5.8.3 | Setting the Mask Register | 5-12 |
| 5.8.4 | Reading the Mask Register | 5-13 |
| 5.9 | Remote/Local Changeover | 5-13 |
| 5.9.1 | Local to Remote Changeover | 5-13 |
| 5.9.2 | Remote to Local Changeover | 5-13 |
| 5.9.3 | Local Lockout (LLO) | 5-13 |
| 5.10 | Logic Levels | 5-14 |
| 5.11 | GPIB Command | 5-14 |
| 5.11.2 | Immediate and Deferred Data Acceptance Modes | 5-14 |
| 5.11.3 | The Fast Learn Mode | 5-16 |
| 5.11.4 | The Long Learn Mode | 5-17 |
| 5.12 | Operating Instructions for Remote Control | 5-17 |
| 5.12.1 | Operating Modes | 5-17 |
| 5.12.2 | Command Codes for Remote Control | 5-17 |

LIST OF ILLUSTRATIONS

| Fig | Title | Page |
|-----|---------------------------------------|------|
| 3.1 | Functional Check Connections | 3-3 |
| 3.2 | Spectrum Analyzer Display | 3-5 |
| 3.3 | Fitting the Rack Mounting Kit 11-1576 | 3-12 |
| 4.1 | Front Panel | 4-7 |
| 4.2 | Rear Panel | 4-7 |
| 4.3 | Basic Signal Generator Functions | 4-10 |
| 4.4 | Changing Values | 4-10 |
| 5.1 | Typical Status Data String | 5-5 |
| 5.2 | Fast Learn Mode Timing | 5-16 |

LIST OF TABLES

| Table | Title | Page |
|-------|--|------|
| 3.1 | Check Frequencies | 3-4 |
| 3.2 | Check Frequencies | 3-4 |
| 5.1 | GPIB Connector Pin Assignment | 5-1 |
| 5.2 | Address Switch Setting | 5-2 |
| 5.3 | Special Function Number Bit Allocation | 5-5 |
| 5.4 | Special Function Number Bit Code | 5-6 |
| 5.5 | Long Learn Mode Data String Interpretation | 5-8 |
| 5.6 | Numerical Data Format | 5-9 |
| 5.7 | Modulation Data | 5-9 |
| 5.8 | AM Control Data | 5-10 |
| 5.9 | FM Control Data | 5-10 |
| 5.10 | ØM Control Data | 5-10 |
| 5.11 | Pulse Modulation Control Data | 5-11 |
| 5.12 | Incremental Control Data | 5-11 |
| 5.13 | REL and Sign Data | 5-11 |
| 5.14 | Status Byte | 5-12 |
| 5.15 | Character Acceptance Times | 5-14 |
| 5.16 | Processing Times | 5-15 |
| 5.17 | Processing Plus Data Acceptance Times | 5-15 |
| 5.18 | Bus Busy Times | 5-16 |
| 5.19 | Frequency Commands | 5-18 |
| 5.20 | Amplitude Commands | 5-18 |
| 5.21 | Modulation Commands | 5-19 |
| 5.22 | Memory Commands | 5-20 |
| 5.23 | Data Acceptance Mode Codes | 5-20 |
| 5.24 | Data Output Mode Codes | 5-21 |
| 5.25 | Status Byte Mask Setting Code | 5-21 |
| 5.26 | Increment System Commands | 5-22 |
| 5.27 | Miscellaneous Codes | 5-22 |
| 5.28 | Alphabetic List of Function Codes | 5-23 |
| 5.29 | Alphabetic List of Units Codes | 5-23 |

FREQUENCY

- Range** 10kHz to 1.3GHz (1300.000000MHz).
- Resolution** 1Hz throughout entire frequency range.
- Frequency Accuracy** Same as reference oscillator.
- Reference Oscillator** INTERNAL –
 Standard – Aging rate 3×10^{-9} per day after 3 months continuous operation. Warm up 6 minutes to $\pm 1 \times 10^{-7}$. Temperature stability $\pm 3 \times 10^{-9}$ per °C from 0°C to +45°C.
 Option 04B – Aging rate 5×10^{-10} per day after 3 months continuous operation. Warm up 20 minutes for $\pm 1 \times 10^{-7}$. Temperature stability $\pm 6 \times 10^{-10}$ per °C from -10°C to +45°C.
 Option 04L5 – Aging rate 1×10^{-9} per day. Warm up 30 minutes to $\pm 1 \times 10^{-7}$. Temperature stability 4×10^{-9} for change from 0°C to +50°C.
 EXTERNAL – Any 10MHz ± 100 Hz frequency standard at a level between 0.1V and 5V rms into 50Ω nominal.
- Reference Output** 10MHz sinewave at 0dBm ± 2 dB from BNC socket on rear panel. Output impedance 50Ω nominal.
- Switching Speed** The total time to change frequency depends upon the method of programming. The table below gives times for any frequency change to be within 100Hz of final frequency.

| Mode | Processor Time | Settling Time | Total Switching Time | Maximum Repetition Rate |
|------------|----------------|---------------|----------------------|-------------------------|
| Deferred | 12.5mS | 0.4mS | 12.7mS | 80/Sec |
| Immediate | 11.8mS | 0.4mS | 12mS | 85/Sec |
| Fast Learn | 0.47mS | 0.4mS | 0.87mS | 1500/Sec |
| DFA | 0.15mS | 0.4mS | 0.4mS | 2500/Sec |

SPECTRAL PURITY

| | Frequency Range | | | |
|--|--------------------------|--------------------------|------------|-------------|
| | 0.01-100MHz | 100-325MHz | 325-650MHz | 650-1300MHz |
| SSB phase Noise 3kHz to 1MHz offset from carrier (AM & CW modes) | -136dBc/Hz | -142dBc/Hz | -136dBc/Hz | -130dBc/Hz |
| SSB broadband noise floor ($\geq +13$ dBm O/P level) | -150dBc at > 5MHz offset | -150dBc at > 2.5% offset | | |
| Residual FM in 300kHz bandwidth | 0.5Hz rms | 0.25Hz rms | 0.5Hz rms | 1Hz rms |
| Spurious Signals > 3kHz off carrier | -90dBc | -97dBc | -91dBc | -85dBc |
| Power Line related and microphonically generated (measured) | -82dBc | -82dBc | -76dBc | -70dBc |
| Harmonics typically ($\leq +13$ dBm) | < -35dBc | | | < -30dBc |
| Sub-Harmonics | None | | | |

- 1 Typical Absolute (includes residual and reference oscillator noise).
 2 At 50Hz may be 3dB higher.

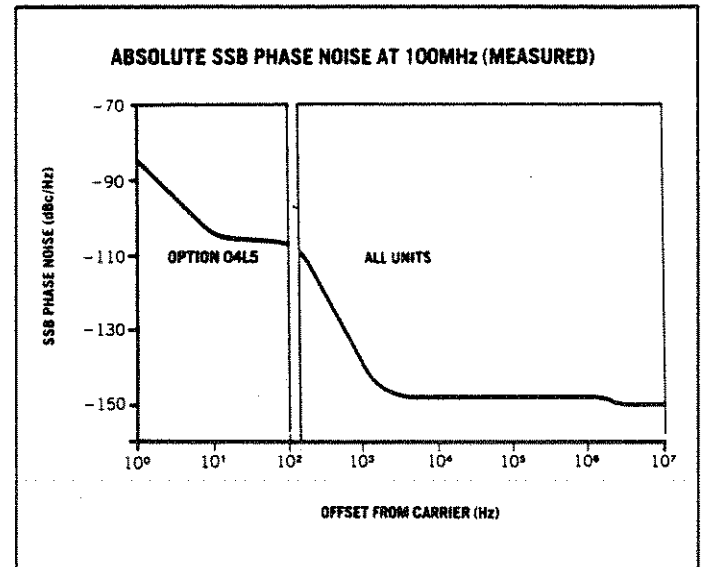

Absolute SSB Phase Noise (dBc/Hz) with Option 04L5 (Measured)

| Offset From Carrier | Carrier Frequency | | |
|---------------------|-------------------|--------|------|
| | 100MHz | 500MHz | 1GHz |
| 1Hz | -84 | -70 | -64 |
| 10Hz | -104 | -90 | -84 |
| 100Hz | -107 | -93 | -87 |
| 1kHz | -139 | -125 | -119 |

OUTPUT

Range Variable from +19dBm to -140dBm. (2V to 0.0224 μ V rms into 50 Ω).

Resolution 0.1dB.

Flatness ± 0.4 dB from 10kHz to 650MHz.
 ± 0.7 dB from 650MHz to 1300MHz.
 (above figures referenced to 400MHz).

Absolute Level Accuracy into 50 Ω

| Output Level | Frequency Ranges | |
|--------------------|------------------|-------------------|
| | 10kHz to 650MHz | 650MHz to 1300MHz |
| +13dBm to -37dBm | ± 0.6 dB | ± 1.0 dB |
| -37dBm to -120dBm | ± 1.0 dB | ± 1.8 dB |
| -120dBm to -140dBm | ± 1.5 dB | ± 2.3 dB |

- Notes
1. applicable at 23 $^{\circ}$ C \pm 5 $^{\circ}$ C.
 2. for 0 $^{\circ}$ to 55 $^{\circ}$ C add ± 0.8 dB to above figures.
 3. absolute level accuracy includes flatness, attenuator error, detector error, measurement uncertainty and SWR and is valid in all operating modes.

Impedance 50 Ω nominal.

SWR

| Output Level | ≤ 500 MHz | > 500 MHz |
|---------------|----------------|-------------|
| 3dBm to 19dBm | 1.6:1 | 1.8:1 |
| <3dBm | 1.2:1 | 1.3:1 |

Protection The output is protected against reverse power inputs up to 1W. Reverse Power Protection Unit (RPPU) is available to protect against reverse power up to 50W. See Option 11.

Level Switching Times 10mS to 50mS from last command statement to stable output, dependent on level change.

Resolution 3 digit resolution to minimum of 10Hz.

Accuracy (1kHz rate) $\pm 5\%$ of reading or 20Hz (whichever is greater).

Modulation Bandwidth (3dB) AC Coupled: 20Hz to 100kHz.
 DC Coupled: dc to 100kHz.

Input Level AC Coupled: Any level between 0.56V and 5.6V (peak to peak) gives specified accuracy.
 DC Coupled: 1.414V peak gives calibrated display.
 Input impedance: 600 Ω nominal.

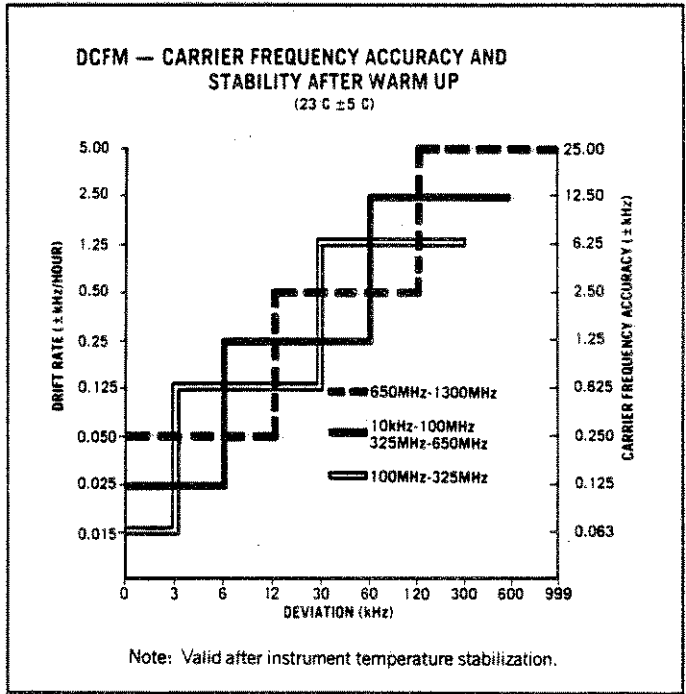

Distortion (1kHz rate) <3% at maximum deviation.
 <1% at 50% maximum deviation.
 <0.3% at 75kHz deviation from 88 to 108MHz carrier frequency.

Incidental AM on FM <0.2% (-60dBc) for deviations of 20kHz at 1kHz rate.

FREQUENCY MODULATION

Peak Deviation See below: -

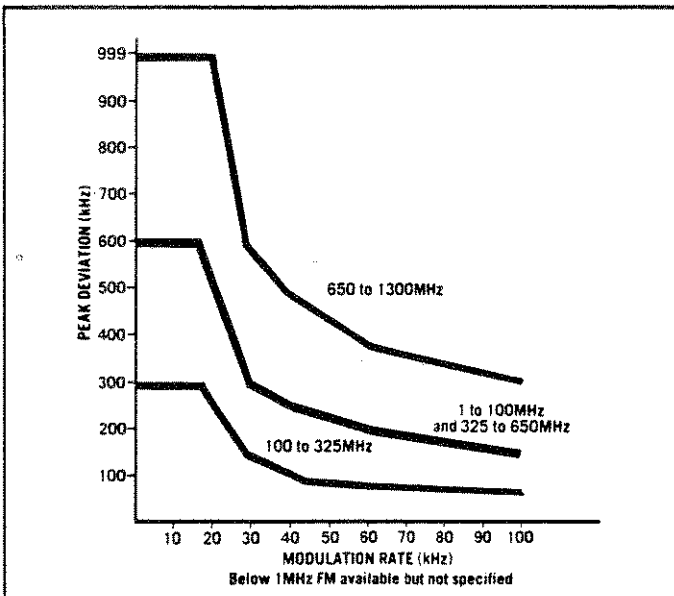

AMPLITUDE MODULATION

Modulation Depth 0 to 99% up to +13dBm reducing to zero at +19dBm.

Resolution 1%.

Accuracy (1kHz rate) ±2% of reading ±3% AM below 80%.
 Note:- Up to +13dBm the variation of modulation depth with carrier amplitude is less than ±0.5% AM, for VOR and ILS operation.

Modulation Bandwidth

| Frequency Range | Modulation Bandwidth (3dB) | |
|-----------------|----------------------------|-------------|
| 1.5-1300MHz | AC | 20Hz-20kHz |
| | DC | dc-20kHz |
| 0.4-1.5MHz | AC | 20Hz-5kHz |
| | DC | dc-5kHz |
| 10kHz to 400kHz | AC | 20Hz-0.1kHz |
| | DC | dc-0.1kHz |

Distortion (1kHz rate) < 1.5% up to 30% AM
< 3% up to 80% AM

Incidental Phase Modulation (1kHz rate) < 0.1 radian at 30% AM

Input Level AC Coupled: Any level between 0.56V and 5.6V (peak to peak) for specified accuracy.
 DC Coupled: 1.414V peak gives calibrated display.
 Input impedance: 600Ω nominal.

PHASE MODULATION

Phase Deviation 5 radians maximum above 60kHz carrier frequency.

Resolution 0.01 radian.

Modulation Bandwidth (3dB) 20Hz to 10kHz.

Accuracy (1kHz rate) ±10%.

Distortion (1kHz rate) < 3% at maximum phase deviation.

Input Level AC Coupled: Any level between 0.56V and 5.6V (peak to peak) gives specified accuracy.
 Input impedance: 600Ω nominal.

PULSE MODULATION

Rise and Fall Times 40nS(10%-90%).

Minimum Pulse Width 200nS

Pulse Repetition Rate

| Carrier Frequency | AC | DC |
|-------------------|-----------------------------|-----------|
| 10-1300MHz | 20Hz-2.5MHz | dc-2.5MHz |
| 0.01-10MHz | Available but not specified | |

On/Off Ratio > 50dB (10MHz to 750MHz).
> 35dB (750MHz to 1300MHz).

Input Level AC Coupled: 2.0V peak to peak.
 DC Coupled: Carrier off below +0.9V threshold.
 Carrier on above +1.7V threshold.

Input impedance: 16k Ω nominal.

Output Level Accuracy remains valid during pulse on.

Indication Front panel annunciator.

Specification valid for "Off" periods <25mS.

INTERNAL MODULATION SOURCES

Frequencies 400Hz, 1kHz.

Frequency Accuracy Same as reference oscillator.

Distortion < 1% Total Harmonic Distortion.

Outputs 2V rms ± 0.5dB emf from 600Ω.
 Rear panel BNC connectors.

DIGITAL SWEEP

Sweep Limits Variable from 10kHz to 1300MHz with 1Hz resolution.

Step Size Variable from 1Hz to 1299.99MHz with 1Hz resolution.

Sweep Speed Four selectable dwell times: 2mS/step, 20mS/step, 200mS/step and 1S/step nominal.

NON-VOLATILE MEMORY

Function Allows storage of complete front panel settings of frequency, output level and modulation.

Number of Stores 33.(100 with Option 10)
 Location 00 is used to store instrument status at switch-off or power interruption.

Memory Retention 30 days minimum at +40°C with instrument unpowered.

REMOTE PROGRAMMING

| | |
|-----------------------------|--|
| GPIO Interface | IEEE=STD=488, 1978. |
| Functions Controlled | All front panel functions except line power switch. |
| Status Indication | SRQ, Talk, Listen and Remote Annunciators. |
| Interface Functions | The interface contains the following IEEE/IEC defined "interface functions" subsets. |

| GPIO Subset | Description | Applicable Capability |
|----------------|----------------------------|---|
| SH1 | Source Handshake | Complete Capability |
| AH1 | Acceptor Handshake | Complete Capability |
| T6 | Talker | Complete except talk only 1. Basic talker 2. Serial poll 3. Unaddress if MLA |
| TE \emptyset | Extended Talker | None |
| L3 | Listener | Complete Capability 1. Basic Listener 2. Listen only mode 3. Unaddress if MTA |
| LE \emptyset | Extended Listener | None |
| SR1 | Service Request | Complete Capability |
| RL1 | Remote/Local | Complete Capability 1. REN – Remote Enable 2. LLO – Local Lockout 3. GTL – Go to Local |
| PP \emptyset | Parallel Poll | None |
| DC1 | Device Clear | Complete Capability 1. DCL – Device Clear 2. SDC – Selected Device Clear |
| DT \emptyset | Device Trigger | None |
| C \emptyset | Controller | None |
| E1 | Open Collector Bus Drivers | — |

| | |
|-----------------------------|--|
| Auxiliary Control | Auxiliary controls are provided via rear panel 50-way connector. |
| Functions controlled | <ol style="list-style-type: none"> Step Up/Step Down with selectable debounce by contact closure to ground or negative edge triggered TTL compatible signal. DFA provides access to microbus for remote control. |

GENERAL

| | | | | | | | |
|------------------------------|---|----------------|--|-----------|--|-------------|----------------------|
| Operating Temperature | 0°C to + 55°C. | | | | | | |
| Storage Temperature | -40°C to +70°C (memory retention not guaranteed below -20°C or above +65°C). | | | | | | |
| Humidity | 95% RH at +40°C. | | | | | | |
| EMC | Meets radiated and conducted limits of MIL-STD 461A methods RE02 and CE03, and VDE 0871. | | | | | | |
| Carrier Leakage | The voltage induced in a two turn 1 inch diameter loop 1 inch away from any surface is less than 0.5 μ V measured into a 50 Ω receiver. | | | | | | |
| Power Requirements | <table> <tr> <td>Voltage Ranges</td> <td>100 (90 to 110) V 120 (103 to 127) V 220 (193 to 237) V 240 (207 to 253) V AC</td> </tr> <tr> <td>Frequency</td> <td>45-66Hz. (For 400Hz operation consult factory).</td> </tr> <tr> <td>Consumption</td> <td>Approximately 320VA.</td> </tr> </table> | Voltage Ranges | 100 (90 to 110) V 120 (103 to 127) V 220 (193 to 237) V 240 (207 to 253) V AC | Frequency | 45-66Hz. (For 400Hz operation consult factory). | Consumption | Approximately 320VA. |
| Voltage Ranges | 100 (90 to 110) V 120 (103 to 127) V 220 (193 to 237) V 240 (207 to 253) V AC | | | | | | |
| Frequency | 45-66Hz. (For 400Hz operation consult factory). | | | | | | |
| Consumption | Approximately 320VA. | | | | | | |

OPTIONS

- 01 Rear Panel connectors. Alternative type N carrier output and BNC modulation inputs available on rear panel.
- 04B High Stability Frequency Standard Racal-Dana model 9421:
Aging rate 5×10^{-10} per day after 3 months continuous operation.
- 04L5 Low Noise Frequency Standard.
Aging rate 1×10^{-9} per day.
- 10 100 Store Non-Volatile Memory.
- 11 RPPU — Output protected up to 50 watts from a 50 Ω source over the frequency range 10kHz to 1.3GHz or to 50V dc.
Insertion loss: ± 0.2 dB (≤ 650 MHz)
 $+0.2$ dB to -0.8 dB (> 650 MHz)
Output SWR (typical):
 ≤ 500 MHz 1.3:1 (< 3 dBm)
 > 500 MHz 1.5:1 (< 3 dBm).
- 60 Rack Mounting Kit (fixed).
- 65 Rack Mounting Kit (slides).

ORDERING INFORMATION

| | |
|----------------|--|
| 9087 | Synthesized Signal Generator. |
| Options | 01 Rear Panel Connectors. |
| | 04B 9421 Frequency Standard. |
| | 04L5 Low Noise Frequency Standard. |
| | 10 100 Store Memory (11-1584). |
| | 11 Reverse Power Protection Unit. |
| | 60 Rack Mounting Kit (fixed) 11-1576. |
| | 65 Rack Mounting Kit (slides) 11-1577. |

ACCESSORIES

A comprehensive range of accessories is available for the 9087 including:-

| | |
|---------|---|
| 23-3174 | 50-75Ω Adaptor (10dB attenuation). |
| 23-3190 | N-BNC Adaptor. |
| 11-1579 | Service Support Kit. Maintenance Manual. |

MECHANICAL

Dimensions (Max.) In millimeters (inches).

Weight Approximately 25kg (55lbs).

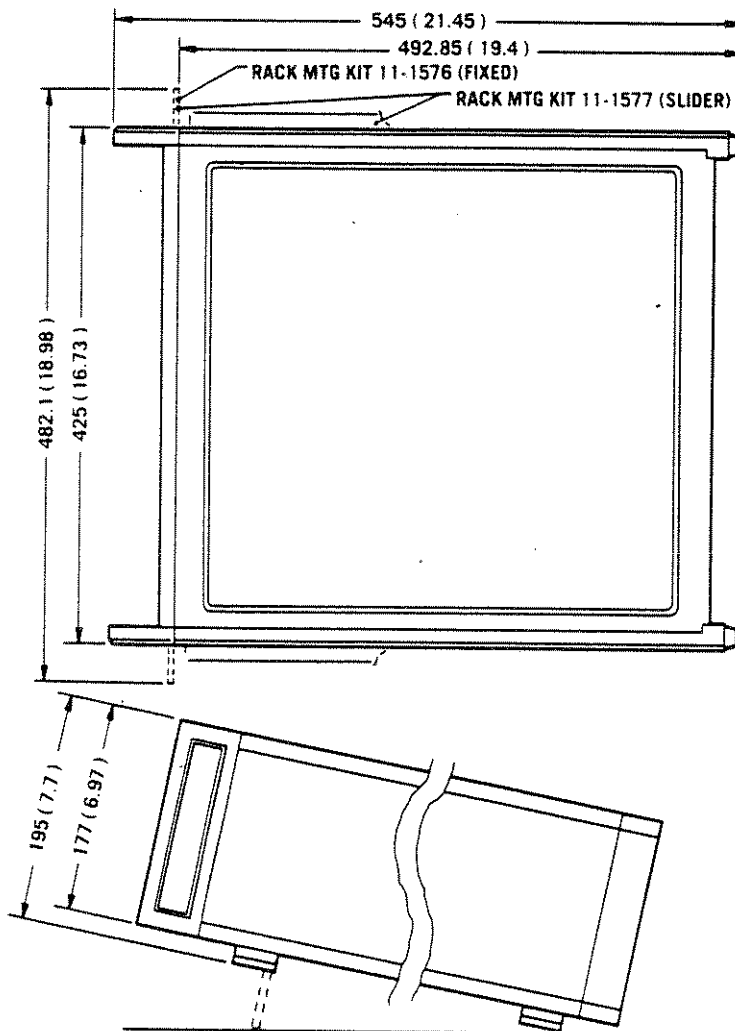

2.1 INTRODUCTION

2.1.11 The Racal-Dana signal generator Model 9087 is designed primarily for the testing of communication equipment over the frequency range from 10 kHz to 1.3 GHz. The RF output is phase-locked to the frequency standard, the wide frequency range being obtained by the use of a multi-loop synthesizer. The instrument is microprocessor controlled, and combines versatility with ease of control.

2.2 RF TUNING

2.2.1 Tuning may be effected in one of five ways. These are:

- (a) Numeric keyboard. The required frequency is set directly.
- (b) Step-up and step-down keys. The displayed frequency is changed in steps. The step size may be one of three pre-set values, or an operator set value.
- (c) Spinwheel. The displayed frequency changes in steps as the spinwheel is rotated. Again, the step size may be one of three pre-set values or an operator set value. The use of the spinwheel, particularly with a small step size, affords all the advantages of analogue tuning whilst retaining the stability of a synthesized system. A HOLD control is provided to isolate the spinwheel to prevent accidental changing of the frequency set.
- (d) GPIB. An internal interface is fitted.
- (e) Direct frequency access (DFA). The required frequency may be set by applying suitable control signals directly to the microprocessor data bus to a rear panel socket. The use of this method permits extremely rapid changes of frequency to be made. A special interface is required. Full details may be obtained from Racal-Dana Instruments.

2.2.2. The frequency set is displayed on a 10 digit, dot matrix LED display, affording 1 Hz resolution throughout the frequency range of the instrument. The decimal point is fixed, and leading zeroes are suppressed.

2.3 FREQUENCY SWEEP

2.3.1 The 9087 incorporates a frequency sweep facility which permits the output frequency to be swept, in steps, between two operator selectable frequencies. The step size can be selected by the operator, and four preset step rates are available.

2.4 RF OUTPUT

2.4.1 Automatic levelling maintains the output level within ± 0.4 dB for output frequencies up to 650 MHz, and within ± 1.0 dB for output frequencies in the range from 650 MHz to 1.3 GHz, relative to the 50 MHz level.

2.4.2 The output level range is from +19 dBm to -140 dBm into 50 Ω . The level may be set by means of a numeric keyboard, or the set value may be stepped up or down using either the step keys or the spinwheel. The step size may be one of three pre-set values, or an operator set value.

2.5 MODULATION FACILITIES

2.5.1 Amplitude, pulse, frequency and phase modulation facilities are provided. Two internal modulating frequencies, locked to the frequency standard, are provided, and external modulating sources may also be used. Details of the permissible range of modulating frequencies, and of the modulation depths and peak deviations which can be obtained, are to be found in Section 1 of this manual.

2.5.2 Amplitude or pulse modulation may be applied simultaneously with frequency or phase modulation. Either or both of the internal modulating sources, or a combination of internal and external sources may be used.

2.6 FRONT PANEL SETTING STORAGE

2.6.1 A non-volatile memory allows the storage of up to 33 (100 if the 100 location memory option is fitted) complete sets of front panel control settings. These may then be recalled when required. The recalled data may be implemented immediately, or may be displayed for checking before the instrument output is reset. This facility allows the contents of the store to be examined without affecting the output of the instrument.

2.6.2 An exchange facility allows the contents of any two store locations to be exchanged without affecting the output of the instrument.

2.6.3 On switching off, the current front panel control settings are stored automatically. On switching on again these settings are immediately implemented. An initialisation program is also provided to set the instrument to a known state.

2.7 ERROR INDICATIONS

2.7.1 Certain errors in the operation of the instrument will result in the flashing of a LED error indicator and the generation of a service request (SRQ) via the GPIB interface. The errors which can be detected are each given a two digit code, which can be displayed. The nature of the error can then be established by reference to the pull-out information card beneath the instrument or to Section 4 of this manual.

2.8 DIAGNOSTIC CHECKS

2.8.1 Several points in the instruments circuits are monitored for possible malfunction. The detection of a fault is indicated by the generation of an error indication. A digit in the numeric displays will flash to indicate the location of the fault.

2.8.2 In the event of overheating of the instrument it is switched automatically to the standby condition, with only the frequency standard and the microprocessor system active.

2.9 SPECIAL FUNCTIONS

2.9.1 A number of special functions are available to the operator. Details are give in Section 4 of this manual.

2.10 OUTPUT PROTECTION

2.10.1 The RF output will withstand the accidental application of reverse RF power at levels up to 1 W.

2.10.2 Protection against reverse powers of up to 50 W is given by the internally mounted reverse power protection unit option. This isolates the RF output socket, and sounds an audible alarm, when reverse powers are applied at above the threshold level. The device latches in the tripped state.

2.11 GPIB INTERFACE

2.11.1 An internally mounted interface to the IEEE 488 GPIB is provided. This enables all the instrument functions, except the line power switching and frequency standard changeover, to be remotely controlled. An adaptor to provide compatibility with the IEC 625-1 bus is available as an optional accessory.

2.11.2 Control via the GPIB may be exercised in one of three ways. These are:

- (a) Immediate Mode Control, in which each data byte accepted by the 9087 from the bus is processed before the next byte is accepted. This provides the shortest delay in completing the resetting of the 9087 output following a data entry made on a controller keyboard.
- (b) Deferred Mode Control, in which the complete data string is accepted from the bus and stored before processing is commenced. The use of the bus is therefore limited to the data transfer time, and better utilisation of the bus is possible at the cost of a small increase in the total time taken to vary the 9087 output parameters.
- (c) Learn Mode Control, in which data strings related to particular settings of the 9087 output are generated in the 9087 and stored in an external memory. When a data string is fed back to the 9087 as an addressed command the output parameters will be set to the related values. This provides a significant saving in time when compared with keyboard control, and, by feeding back a succession of data strings, the 9087 may be stepped rapidly through a number of different output parameter patterns. Two lengths of data string are available, the longer controlling the full range of output parameters and the other controlling frequency only. The longer data string may also be used to monitor the instruments settings. This may be found useful when the 9087 is used in operator interactive systems.

2.12 EXTERNAL STEP SWITCHES

2.12.1 External step-up and step-down switches may be fitted by the user to provide remote control of the instrument's incremental control function.

2.13 MAINTENANCE

2.13.1 It is recommended that customers take advantage of the repair and calibration service offered by Racal-Dana Instruments Ltd. and their agents. For customers wishing to carry out their own servicing a comprehensive Maintenance Manual is available from Racal-Dana Instruments. When ordering, the serial number of the instrument for which the manual is required should be quoted.

3.1 PACKAGING

3.1.1 Unpack the instrument carefully to avoid unnecessary damage to the factory packaging.

3.1.2 If the instrument is to be returned to Racal-Dana Instruments for calibration or repair, the original packaging should be used where possible. If this is not possible a strong shipping container should be used. This must be fitted with internal packing capable of preventing movement of the instrument within the container.

3.2 POWER SUPPLY

3.2.1 AC VOLTAGE RANGE SETTING

3.2.1.1 The supply voltage setting is varied by changing the position of a small printed circuit board located under the fuse on the rear panel. The setting in use can be seen through the clear plastic fuse cover.

3.2.1.2 If it is necessary to change the voltage range proceed as follows:

- (a) Switch the instrument off, and remove the line power socket.
- (b) Slide the clear plastic fuse cover to the left, to expose the fuse.
- (c) Pull the lug marked FUSE PULL out and to the left. This will remove one end of the fuse from its holder. Remove the fuse.
- (d) Using a pair of snipe nosed pliers, pull out the voltage setting board from beneath the fuse holder.
- (e) Reinsert the board so that the required voltage range can be read the correct way up, when viewed from above, looking at the rear of the instrument.
- (f) Push the lug marked FUSE PULL back into position.
- (g) Insert the correct fuse for the range selected into the fuse holder.
- (h) Slide the clear plastic cover to the right until it is clear of the line power plug. Insert the line power socket.

3.2.2 LINE FUSE

3.2.2.1 Check that the line fuse rating is correct for the local AC supply voltage. The fuse is a $\frac{1}{4}$ in x $1\frac{1}{4}$ in glass cartridge, anti-surge type. The Racal-Dana part numbers for replacement fuses are:-

90V to 132V supply 4 AT 23-0061
198V to 264V supply 2 AT 23-0036

3.2.3 DC FUSES

3.2.3.1 Check that the DC fuses are serviceable and of the correct rating. The fuses are mounted beneath a hinged cover on the rear panel of the instrument. The cover is released by removing the two screws in the upper and lower left hand corners. The fuses are numbered FS1 to FS9 from top to bottom, and are all of the 5 mm x 20 mm, glass cartridge, quick action type. The ratings and part numbers are:

| <u>Fuse Number</u> | <u>Rating</u> | <u>Part Number</u> |
|--------------------|---------------|--------------------|
| 1 | 2 A | 23-0008 |
| 2 | 2 A | 23-0008 |
| 3 | 2 A | 23-0008 |
| 4 | 1.5 A | 23-0007 |
| 5 | 3 A | 23-0009 |
| 6 | 3 A | 23-0009 |
| 7 | 3 A | 23-0009 |
| 8 | 2 A | 23-0008 |
| 9 | 0.5 A | 23-0004 |

3.2.4 POWER CORD

3.2.4.1 The power cord must be fitted with a suitable connector in accordance with the standard color code.

| | <u>European</u> | <u>American</u> |
|---------------|-----------------|-----------------|
| Live | Brown | Black |
| Neutral | Blue | White |
| Earth(Ground) | Green/Yellow | Green |

3.3 FREQUENCY STANDARD

3.3.1 If it is intended to use an external frequency standard this should be connected at the EXT. STANDARD I/P socket on the rear panel. The STANDARD switch on the rear panel should be set to EXT.

3.3.2 If the internal frequency standard is to be used ensure that the STANDARD switch is set to INT.

3.3.3 If it is intended to use the 10 MHz signal derived from the frequency standard, make the necessary connection at the rear panel 10 MHz STANDARD OUTPUT socket.

3.4 EXTERNAL STEP SWITCHES

3.4.1 If external control of the step up and step down functions is required, connect the external switches to the rear panel AUXILIARY CONTROL connector. The switches should be connected from pin 28 (for step up) and pin 29 (for step down) to 0V at pin 30. The mating connector required is a plug, 3M type 3564-1001, Racal-Dana part number 23-3320. Contact closure initiates the step.

3.4.2 Internal contact de-bouncing is provided. This is enabled on switching on or following initialisation, but can be disabled using special function 06 and enabled using special function 05. The procedure for using the special functions is given in Section 4.

3.5 BATTERY CHARGING

3.5.1 When the instrument is ready for use, the state of charge of the memory battery should be checked. Connect the instrument to the AC supply and set the LINE switch to ON. If the BATTERY LOW indicator lights the instrument should be left switched on (switched to the standby condition if not required for use) until the indicator is extinguished. A full charge cycle takes approximately 14 hours.

3.5.2 If the BATTERY LOW indicator lights the front panel control setting patterns stored in the memory may have been corrupted, and should be checked before use using special function 76.

3.6 OPERATOR'S CHECKS

3.6.1 FUNCTIONAL CHECKS

3.6.1.1 The procedure which follows checks all the instrument's functions to establish whether they perform normally. The procedure does not verify absolute accuracy. Detailed performance tests are given in Section 7 of the maintenance manual.

3.6.1.2 The recommended test equipment is:

- (a) Frequency Counter, Racal-Dana model 9514 with option 42.
- (b) Spectrum Analyzer, Hewlett Packard model 141T fitted with RF section 8554B and IF section 8552B.

Other equipment of similar specification may be used.

3.6.1.3 Connect the 9087 under test to the frequency counter as shown in Fig. 3.1. If a frequency counter other than the 9514 is used it is permissible to use the frequency standard in the 9087 as the reference. In this case the frequency counter should be set to operate from an external standard input, which should be provided from the 10 MHz STD OUT socket of the 9087

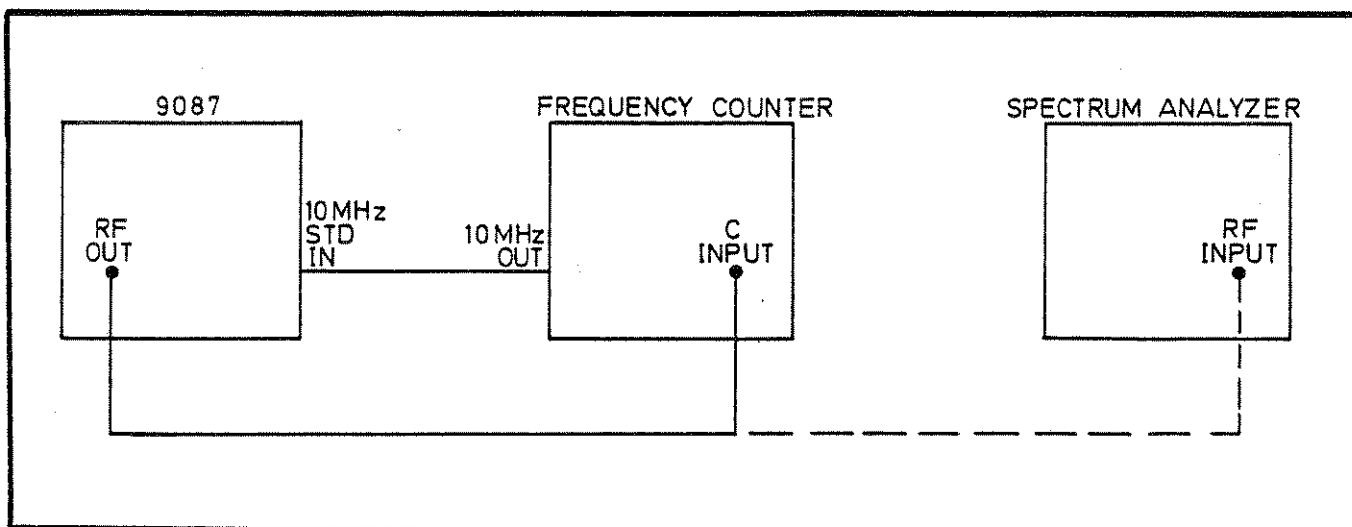

Fig 3.1 Functional Check Connections

3.6.1.4 Set the 9087 RF output amplitude to -10.0 dBm and frequency to the values in Table 3.1. The counter reading should be the frequency that is set plus the resolution error for the counter being used (for 9514, ± 1 Hz).

TABLE 3.1

Check Frequencies

| MHz |
|--------|
| 0.01 |
| 0.1 |
| 1.0 |
| 10.0 |
| 1000.0 |

3.6.1.5 Set the 9087 frequency to 111.111 111 MHz. Set the step size to 111.111 111 MHz. Select STEP, and use the STEP UP key to step the displayed frequency to each value shown in Table 3.2 in turn. Check that the frequency counter indicates the frequency on the 9087 display at each step. Repeat the test using the STEP DOWN key.

TABLE 3.2

Check Frequencies

| MHz |
|-------------|
| 111.111 111 |
| 222.222 222 |
| 333.333 333 |
| 444.444 444 |
| 555.555 555 |
| 666.666 666 |
| 777.777 777 |
| 888.888 888 |
| 999.999 999 |

3.6.1.6 Set the 9087 to sweep from 1 to 1300 MHz in 1 MHz steps at 20 ms/step. Set the 9087 RF output amplitude to +0 dBm. Set the spectrum analyzer to a center frequency of 650 MHz with 1250 MHz scan, fast scan rate, and a +10 dBm reference level.

3.6.1.7 Connect the 9087 RF OUTPUT to the RF INPUT of the analyzer, using low-loss RF cable with Type N connectors. The display should be a continuous sweep (that is, no jumps or gaps). Harmonics can be seen over most of the sweep and should be more than 35 dB below the carrier up to 650 MHz.

3.6.1.8 Stop the 9087 sweep and set the output amplitude to 0 dBm. Tune the 9087 over the whole frequency band in 10 MHz steps, using the spin wheel. Check that the displayed level does not vary more than 2 dB + analyzer flatness, and that there are no discontinuities in the response.

3.5.1.9 Tune the 9087 and analyzer to 150 MHz. Set the analyzer ref level to +10 dBm. Set the 9087 output level to 10 dBm. Using spin wheel, reduce the output amplitude in 0.1 dB steps to 0 dBm, then in 3 dB steps down to -66 dBm. Note that the level on the analyzer display decreases smoothly in appropriate steps without jumps or reversals.

3.6.1.10 Set the 9087 output level to 0 dBm, frequency to 650 MHz, and FM to 100 kHz peak deviation and 1 kHz rate (INT 1k). Set the spectrum analyzer to 650 MHz centre frequency, 50 kHz span/division and a 0dBm reference level. The analyzer display should be similar to Figure 3.2.

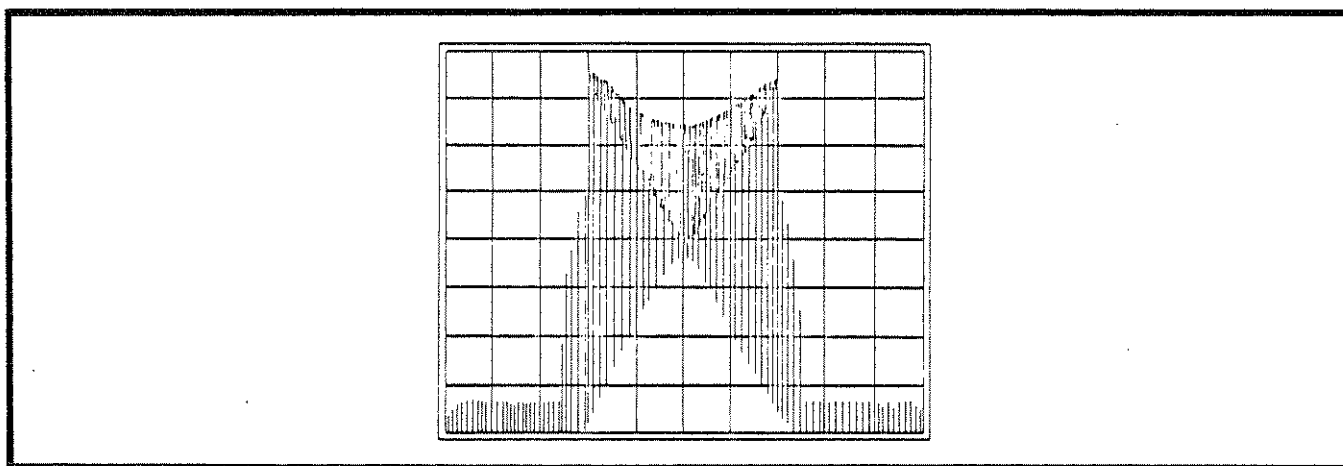

Fig 3.2 Spectrum Analyzer Display

3.6.1.11 Using the spin wheel, slowly decrease FM deviation to zero. The deviation displayed on the analyzer should decrease smoothly.

3.6.1.12 Set the 9087 to 50% AM at a 400 Hz rate (INT 400). Set the analyzer to zero span and fine tune the centre frequency for maximum level of the demodulated signal. Set the analyzer to linear amplitude mode. The demodulated signal should be a sine wave with a 2.5 ms period (that is, 400 Hz).

3.6.1.13 Set the 9087 to INT 1k (modulation rate). The period of the demodulated signal should become 1 ms (that is, 1 kHz).

3.6.2 GPIB CHECK

3.6.2.1 Introduction

3.6.2.1.1 The procedure which follows checks the ability of the 9087 to process or send GPIB messages. Each test may be performed separately, if required.

3.6.2.1.2 The validity of these checks is based on the following assumptions:

- (a) The 9087 operates correctly from the keyboard. This can be verified with the preceding functional check.

- (b) The 9087 memory circuits are good. This is verified automatically at each turn-on.
- (c) The controller properly executes GPIB operations to IEEE-488-1978.
- (d) The controller GPIB interface properly transfers the controller's instructions.

If the 9087 appears to fail any of the GPIB checks, the validity of the above assumptions should be confirmed before servicing the 9087.

3.6.2.1.3 The recommended test equipment is the Hewlett Packard HP-85 GPIB controller, with GPIB I/O ROM in the drawer. It is assumed that the select code of the controller I/O is 7 and that the address of the 9087 is 19 (the address set when the instrument leaves the factory). If any other controller or select code/address combination is used the GPIB commands given in the following paragraphs will require modification. The controller should be connected to the 9087 GPIB interface via a GPIB cable.

3.6.2.1.4 The 9087 does not require any special control settings. However, it should be initialised at the beginning of a series of checks. This is a good step to perform also at the end of the checks and before general operation.

3.6.2.1.5 If all of these checks are successful, the instrument's GPIB interface is operating correctly. These procedures do not check that all of the device dependent codes can be executed. However, if the 9087 works correctly from the keyboard, its memory circuits check correctly and the GPIB interface works correctly, then there is a high probability that it will respond to all program codes.

3.6.2.2 Remote and Local Message Check

3.6.2.2.1 This check assumes that the 9087 is in the local state, a default condition at turn-on. Thus, the Remote Check precedes the Local Check. If the instrument is in the remote state (that is, its front panel REMOTE indicator is lit), switch it off and then on again.

3.6.2.2.2 Test as follows:

| Action | HP85 Code |
|--|------------|
| Send the REN message true, followed by the 9087 listen address | REMOTE 719 |

Check that the 9087 REMOTE indicator is lit.

3.6.2.2.3 Test as follows:

| Action | HP85 Code |
|--|-----------|
| Send the 9087 listen address followed by the GTL message | LOCAL 719 |

Check that the 9087 REMOTE indicator is extinguished.

3.6.2.3 Local Lockout and Clear Lockout Check

3.6.2.3.1 The 9087 is put to the remote state before setting local lockout. Test as follows:

| Action | HP85 Code |
|--|-----------------|
| Send the REN message true, followed by the 9087 listen address | REMOTE 719 |
| Send the LLO message | LOCAL LOCKOUT 7 |

Check that the 9087 REMOTE indicator is lit. Operate the 9087 front panel LOCAL Key, and check that the REMOTE indicator remains lit.

3.6.2.3.2 Test as follows:

| Action | HP85 Code |
|----------------------------|-----------|
| Send the REN message false | LOCAL 7 |

Check that the 9087 REMOTE indicator is extinguished.

3.6.2.3.3 Test as follows:

| Action | HP85 Code |
|--|------------|
| Send the REN message true, followed by the 9087 listen address | REMOTE 719 |

Check that the 9087 REMOTE indicator is lit. Operate the LOCAL key on the 9087 front panel and check that the REMOTE indicator is extinguished.

3.6.2.4 Data Message Check

3.6.2.4.1 The 9087 is put to the remote state at the commencement of the check. Test a follows:

| Action | HP85 Code |
|---|-----------------------------|
| Send the REN message true, followed by the 9087 listen address | REMOTE 719 |
| Set the 9087 status byte mask to 377. Set the data output mode to send the data string by sending the 9087 listen address followed by the device dependent command string RS377IS | OUTPUT 719;"RS377IS" |
| Prepare a store to receive a 27 byte data string | DIM Z\$ 27 |
| Send the 9087 talk address. Store the 27 byte data string in the prepared store. Send the UNTALK message true when the string has been stored. | ENTER 719 USING "#,27A";Z\$ |
| Print the contents of the store. | DISP Z\$ |

Check that the store contains 00,00,00,00,00,00,377,000 followed by carriage return and line feed.

3.6.2.4.2 Test as follows:

| Action | HP85 Code |
|--|-----------------------------|
| Set the 9087 status byte mask to all 0's by sending the device dependent command string RS000 | OUTPUT 719;"RS000" |
| Prepare a store to receive a 27 byte data string | DIM M\$ 27 |
| Send the 9087 talk address. Store the 27 byte data string in the prepared store. Send the UNTALK message true when the string has been stored. | ENTER 719 USING "#,27A";M\$ |
| Print the contents of the store | DISP M\$ |

Check that the store contains 00,00,00,00,00,00,00,000 followed by carriage return and line feed.

3.6.2.5 SRQ and Status Btye Check

3.6.2.5.1 Test as follows:

| Action | HP85 Code |
|--|--------------------------------|
| Send the REN message true, followed by the 9087 listen address and the device dependent command string RS300 | REMOTE 7 OUTPUT 719;"RS300" |
| Set the 9087 to local control by either (a) sending the REM message false (b) sending the GTL message (c) operating the LOCAL key on the 9087 front panel | LOCAL 719 |

Activate special function 44, using the 9087 front panel controls. Check that the SRQ indicator lights.

3.6.2.5.2 Test as follows:

| Action | HP85 Code |
|--|------------------------|
| Store the status of the GPIB interface of the controller in binary form. | STATUS 7,2;5 |
| Print the status of the SRQ line | DISP "SRQ =";BIT (S,5) |

Check that the SRQ message has been sent true (SRQ status bit at 1 or SRQ line $\leq 0.8V$).

3.6.2.5.3 Test as follows:

| Action | HP85 Code |
|---|-----------------|
| Conduct a serial poll and store the status byte of the 9087 | R = SPOLL (719) |
| Print the contents of the store | DISP "R=";R |

Check that the SRQ indicator on the 9087 front panel is extinguished when the serial poll is made. The value of R should be 192 (store contents should be 11000000).

3.6.2.6 Device Clear and Selected Device Clear Check

3.6.2.6.1 The 9087 is put to the remote state with the frequency at a frequency other than 100 MHz at the commencement of the test. Test as follows:

| Action | HP85 Code |
|--|----------------------------------|
| Send the REN message true, followed by the 9087 listen address and the device dependent command string FQ555MZ | REMOTE 7 OUTPUT 719;"FQ555MZ" |
| Send the DCL message true | CLEAR 7 |
| Reset the 9087 frequency by sending the 9087 listen address and the device dependent command string FQ555MZ | OUTPUT 719;"FQ555MZ" |
| Send the SDC message true | CLEAR 719 |

Check that the 9087 frequency changes from 555 MHz to 100 MHz for both the DCL and SDC messages

3.6.2.7 IFC Check

3.6.2.7.1 The 9087 is put to the remote state at the commencement of the test. A dummy command string is sent to put the 9087 to the listener active state (LACS). Test as follows:

| Action | HP85 Code |
|---|------------|
| Send the REN message true followed by the 9087 listen address | REMOTE 719 |
| Send a dummy command string | OUTPUT 719 |
| Send the IFC message true | ABORTIO 7 |

Check that the REMOTE indicator on the 9087 lights after the first step and the LISTEN indicator lights when the dummy command string is received. Check that the LISTEN indicator is extinguished when the IFC message is received.

3.7 FITTING THE FIXED RACK MOUNTING KIT 11-1576

CAUTION: THE RACK MOUNTING KIT 11-1576 PROVIDES SUPPORT FOR THE 9087 AT THE FRONT OF THE RACK ONLY. BECAUSE OF THE WEIGHT OF THE INSTRUMENT, ADDITIONAL SUPPORT MUST BE PROVIDED AT THE REAR OF THE 9087, USING HANGERS SUITED TO THE RACK IN USE.

3.7.1 The kit contains a pair of mounting brackets and four screws. The method of fitting the kit is shown in Fig. 3.3. The fitting procedure is as follows:

- (a) Switch off the instrument and the AC supply. Remove the line power socket.
- (b) Stand the instrument upside down on a firm bench.
- (c) Remove two screws from each of the plastic mouldings at the rear corners of the instrument. Remove the mouldings.
- (d) Slide the bottom cover towards the rear of the instrument by about 1 inch, and lift the cover off.
- (e) Remove the bench feet from the bottom cover by removing the retaining screw from each foot. Replace the bottom cover.
- (f) Remove the side trim panels by sliding them to the rear of the instrument. Replace and secure the plastic mouldings removed in (c).

- (g) Remove the two screws securing the handle at one side of the instrument. Do not remove the handle.
- (h) Position a bracket from the kit at the side of the instrument, so that the two holes in a flange are positioned over the holes for the handle securing screws.
- (j) Secure the handle and bracket, using two of the countersunk headed screws from the kit.
- (k) Repeat (g) to (j) at the other side of the instrument.

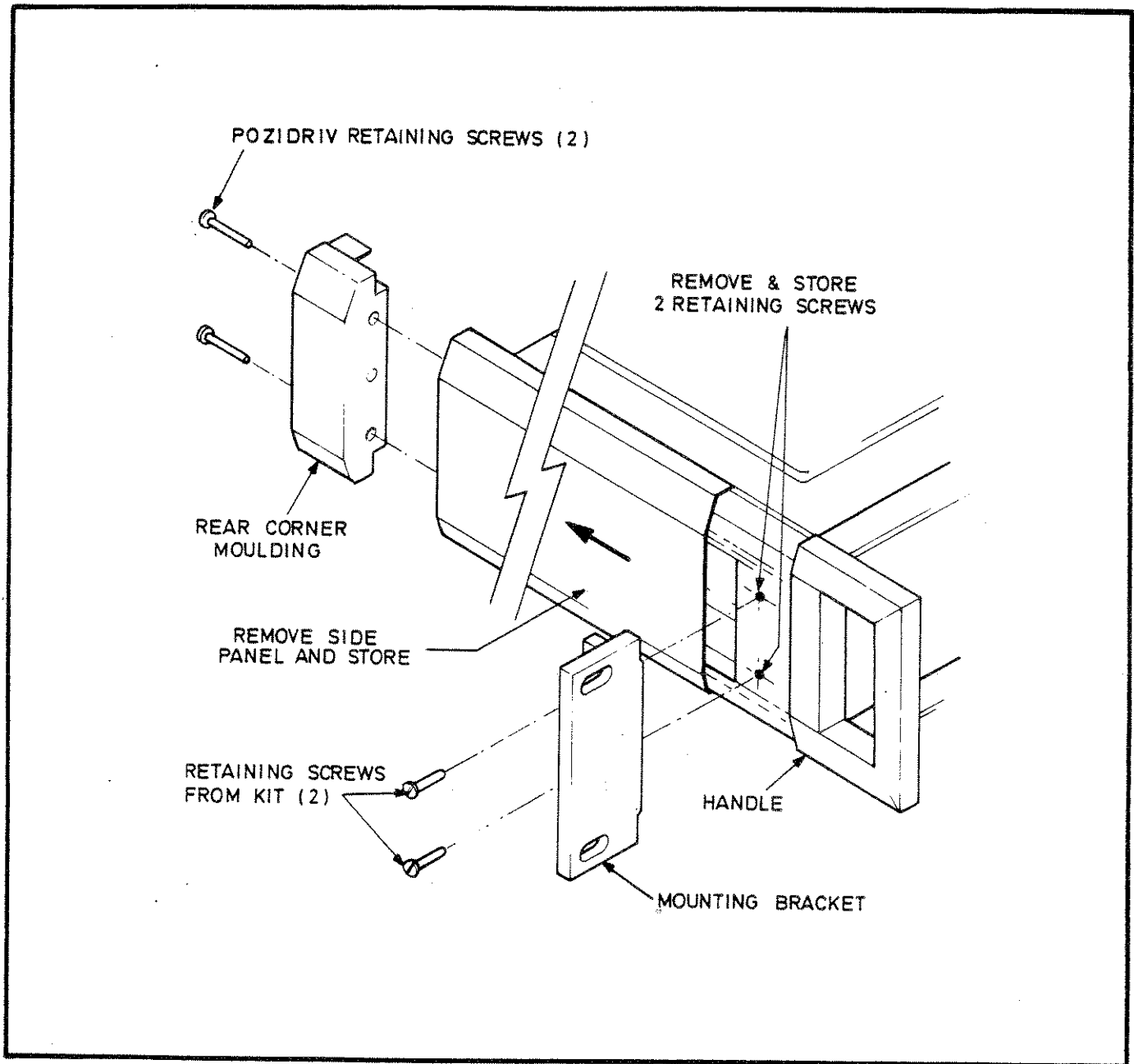

Fig. 3.3 Fitting the Rack Mounting Kit 11-1576

4.1 INTRODUCTION

4.1.1 The instrument should be prepared for use in accordance with the instructions given in Section 3. If the instrument is being used for the first time, or at a new location, pay particular attention to the setting of the supply voltage range selector.



4.2 DESCRIPTION OF CONTROLS, INDICATORS AND CONNECTORS









4.2.1 Each group of controls or connectors described is numbered to correspond with the indicators on Fig. 4.1 (front panel) or Fig. 4.2 (rear panel). With the exception of the LINE switch the front panel keys are of the pressure sensitive membrane type. The numeric indicators are of the LED dot-matrix type.



4.2.2 FRONT PANEL ITEMS

| Reference | Indicators, Controls and Connectors | Functions |
|-----------|--|--|
| ① | <p> GPIB Indicators</p> <p> REMOTE</p> <p> LISTEN</p> <p> TALK</p> <p> SRQ</p> | <p> ON: Indicates that the controller has placed the instrument in the remote operation mode.</p> <p> ON: Indicates that the instrument is programmed by the controller to function as a listener on the GPIB or is set to LISTEN ONLY.</p> <p> ON: Indicates that the instrument is programmed by the controller to function as a talker on the GPIB.</p> <p> ON: Indicates that the instrument is transmitting a service request (interrupt) to the controller in systems operation.</p> |
| ② | <p> RELATIVE</p> | <p> ON: Indicates that the frequency displayed is either a +ve or -ve offset from a previously set reference frequency.</p> |
| ③ | <p> Frequency Display</p> | <p> A ten digit display indicating frequency parameters or status codes and error information.</p> |
| ④ | <p> STEP SIZE</p> | <p> ON: Indicates that the frequency displayed is the current stored step size.</p> |

| Reference | Indicators, Controls and Connectors | Functions |
|-----------|--|---|
| ⑤ | Modulation Display | A 3 digit display with decimal points, indicating value of modulation in %, kHz or radians. |
| ⑥ | % kHz Rads PULSE CAL? | ON: Indicates modulation display is displaying % AM. ON: Indicates modulation display is displaying kHz deviation. ON: Indicates modulation display is displaying phase mod in radians. ON: Indicates that pulse modulation is selected. The modulation display is blanked. ON: Indicates that the actual modulation may not be as displayed. |
| ⑦ | RELATIVE | ON: Indicates that the amplitude displayed is a +ve or -ve offset from a previously set reference level. |
| ⑧ | Output Amplitude Display | A 3½ digit display indicating RF level, relative or step size in voltage units or dB. The display is also used for the special function No. |
| ⑨ | STEP SIZE | ON: Indicates that the amplitude displayed is the current stored step size in voltage units or dB. |
| ⑩ | dB dBm nV, μ V, mV dB μ V | ON: Indicates amplitude display is in dB - relative or step size. ON: Indicates amplitude display is in dBm (50 Ω source) ON: Indicates amplitude display is in voltage units, actual output RMS into 50 Ω , step size or relative. ON: Indicates amplitude display is in dB relative to 1 μ V. |
| ⑪ | Memory Display | A 2 digit display indicating the memory location for front panel set-ups or an error code for invalid commands/conditions. |
| ⑫ | BATT LOW | ON: Indicates memory battery voltage was low. |

| Reference | Indicators, Controls and Connectors | Functions |
|-----------|---|---|
| ⑬ | ERROR | FLASHING: Indicates an invalid command (Local or Remote) or a system hardware error. |
| ⑭ | DISPLAY ERROR CODE | Displays current error code when held in. |
| ⑮ | Memory Function - Control Keys | Keys for storing, receiving, exchanging and executing the front panel set-ups in designated locations. |
| ⑯ | Spinwheel  | Rotated in either direction to control the parameters of frequency, modulation, output level and memory location. |
| ⑰ | Increment Controls FINE MEDIUM COARSE STEP HOLD | Selects pre-set or user-defined step sizes for spinwheel and step up/down keys. ON: Disables spinwheel only. |
| ⑱ | Step Up - Step Down Keys   | One press changes value of current function by the selected increment. Provides continuous stepping when held in. |
| ⑲ | Units Keys | Used to terminate and action data entry. Also used for units conversion in amplitude mode. |
| ⑳ | Data Entry BACK SPACE | Entry of numeric values, +ve or -ve with or without decimal point for setting of all functions, special functions or memory locations. Provided for entry correction. |
| ㉑ | FM/Phase Mod AF IN | BNC socket for external modulating signal input (FM or \emptyset M) |
| ㉒ | HIGH | ON: External modulating signal level is too high. |
| ㉓ | LOW | ON: External modulating signal level is too low. |
| ㉔ | Modulation Primary Function Keys | Selects one of four modulation modes (Pulse, AM, FM, \emptyset M) for further manipulation. When associated LED is on modulation values can be altered either by keyboard entry or by the increment controls. |

| Reference | Indicators, Controls and Connectors | Functions |
|-----------|--|---|
| ②5 | Modulation Source and Control keys with indicators | Enables/disables modulation and the source for both Pulse/AM and FM/ØM. Each column of keys is independent. |
| ②6 | Pulse/AM Mod AF IN | BNC Socket for external modulating signal input (AM or Pulse mod) |
| ②7 |  | ON: Indicates RF Signal available at the output socket. (Toggle action key). |
| ②8 | RF OUTPUT | 'N' type connector (50 Ω) for RF output |
| ②9 |  | ON: Amplitude selected. Selects amplitude as the primary function. Values of Amplitude parameters can be entered via the keyboard or altered by the increment controls. |
| ③0 | LINE  | A press-on, press-off switch controlling the AC supply to the instrument. |
| ③1 |  | <p>ON: Indicates instrument is in standby mode.</p> <p>FLASHING: Instrument has overheated and shutdown into standby mode.</p> <p>Toggle action. Controls standby/normal modes. In standby mode processor and frequency standard only are active.</p> |
| ③2 |  | ON: Relative mode selected. Toggle action. Selects relative mode for either frequency or amplitude. Values entered in this mode are offsets from a reference value. |
| ③3 |  | Initiates the power up check cycle and leaves instrument in a pre-set state. |
| ③4 |  | ON: Step size mode selected. Toggle action. Selects and displays the step size mode for the required function (frequency or amplitude). Values cannot be entered via spinwheel. |
| ③5 |  | Returns instrument to local control from remote GPIB control, provided Local Lockout has not been sent. |

| Reference | Indicators, Controls and Connectors | Functions |
|-----------|---|---|
| (36) |  | ON: Frequency selected. Selects frequency as the primary function. Values of frequency parameters can be entered via the keyboard or altered by the increment controls. |
| (37) |  | Key plus two digits accesses additional features, including digital sweep and diagnostic routines. |
| (38) | SWEEP | ON: Frequency sweeping under special function control. |
| (39) | START | ON: Sweep start frequency displayed (special function 86). |
| (40) | STOP | ON: Sweep stop frequency displayed (special function 87). |

4.2.3 REAR PANEL ITEMS

| | | |
|------|-------------------------------|--|
| (41) | Supply Voltage Range Selector | This allows the selection of one of four line voltage ranges. The range selected can be read on the selecting plate through the clear plastic cover. |
| (42) | Line Fuse | The fuse is a $\frac{1}{4}$ in x $1\frac{1}{2}$ in glass cartridge pattern, and should be of the anti-surge type. See paragraph 3.2.2 for ratings. |
| (43) | Line Power Plug | The power input plug incorporates a filter, and external supply filtering should be unnecessary. |
| (44) | RF Output Connector | A 50 Ω Type N output connector may be fitted in this position as an alternative to the front panel position. |
| (45) | Auxiliary Control Socket | <p>Pins 28, 29 and 30 permit the connection of external step up and step down switches for the data incrementing system.</p> <p>The socket also provides direct access to the instrument address and data buses. The use of a special interface in conjunction with this socket permits extremely rapid frequency changes to be made. Details may be obtained from Racal-Dana Instruments.</p> |

| Reference | Indicators, Controls and Connectors | Functions |
|-----------|---|---|
| (46) | DC Fuses | The DC fuses are mounted below a hinged cover plate. The plate is released by removing the two screws at the left hand corners. |
| (47) | External 10 MHz Standard Input | A BNC connector is provided to permit the connection of a 10 MHz signal from an external frequency standard. |
| (48) | Internal Modulation Source Outputs | The 400 Hz and 1 kHz signals from the internal modulation source are available at these BNC sockets. The signals are available irrespective of whether the source is selected or modulation is enabled. |
| (49) | AF Input Sockets | The AF sockets for the connection of external modulation sources may be fitted in this position as an alternative to front panel mounting. |
| (50) | 10 MHz Standard Output | A 10 MHz signal, derived from the frequency standard in use, is available at this BNC connector. |
| (51) | Internal/External Frequency Standard Switch | This slide switch permits selection of the internal or external frequency standard. |
| (52) | GPIB Socket | This socket is wired for direct connection to the IEEE 488 bus. An adaptor to permit the instrument to be used with the IEC 625-1 bus is available as an optional accessory. |
| (53) | Address Switches | The upper five switches allow one of 31 Listen/Talk address pairs to be selected. Putting a switch to the right represents a logic '1'. The top switch represents the least significant bit (bit 1, on DIO 1). The sixth switch, when put to the right, selects the listen only mode. The setting of the remaining address switches is then irrelevant. |
| (54) | Internal Standard Frequency Adjustment | An aperture provides access for frequency adjustment of the internal standard. |

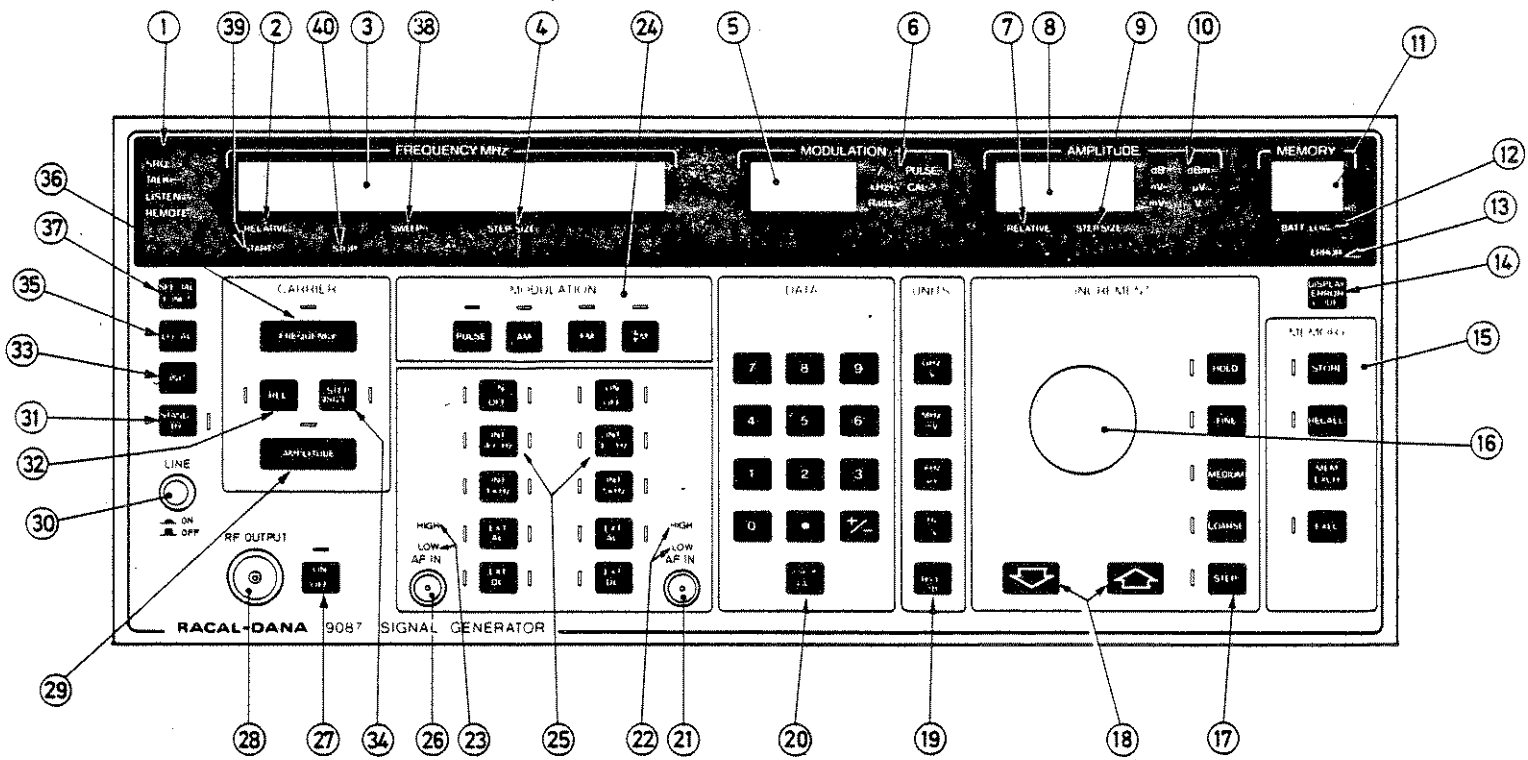

Fig. 4.1 Front Panel

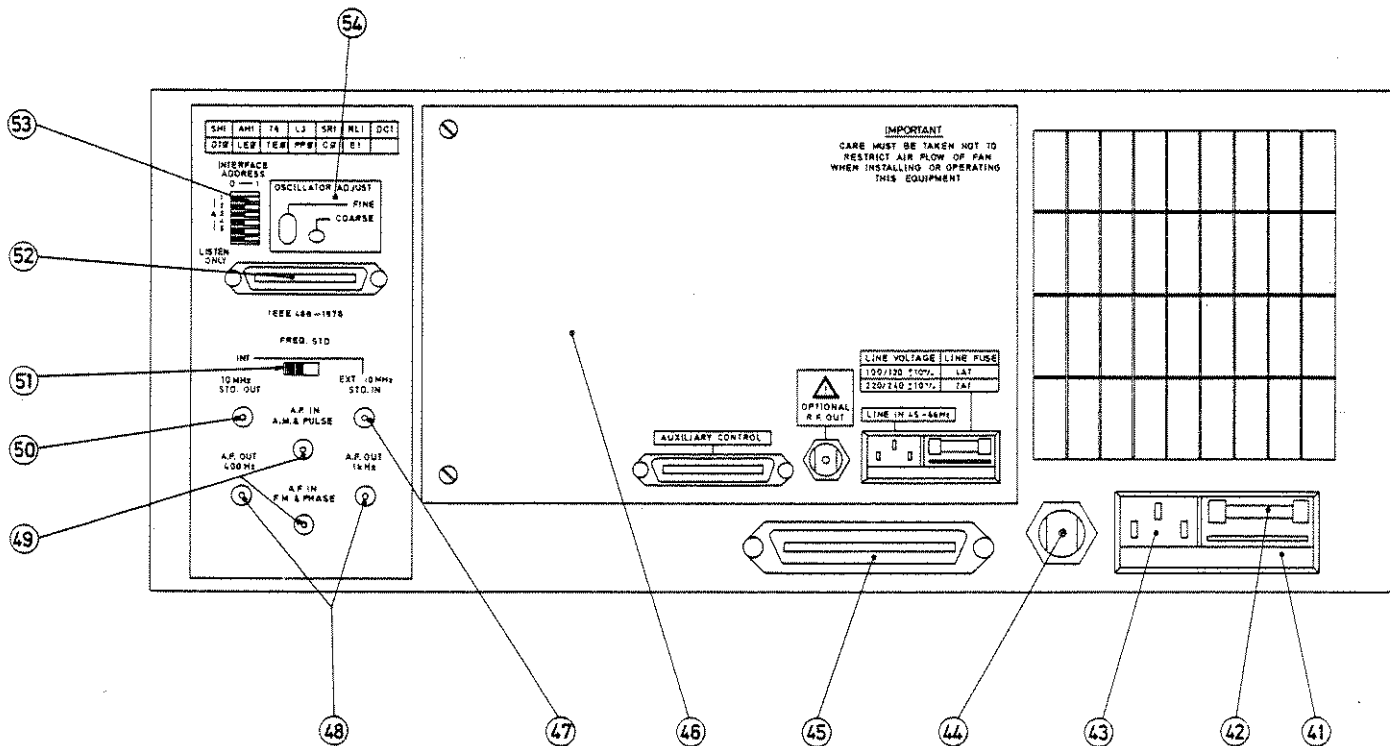

Fig. 4.2 Rear Panel

4.3 SWITCHING ON

4.3.1 Connect the instrument to the AC supply and set the LINE switch to ON. All the front panel LEDs will light for two seconds, after which the address set on the GPIB interface is displayed for 2 seconds. Error code 80 will be generated for a few minutes until the reference generator is in lock. Once this sequence is complete the instrument is ready for use, but time must be allowed for the frequency standard to reach operating temperature if the specified accuracy is required. The time required for the internal frequency standard is 6 minutes, for option 04A, and 20 minutes for options 04B and 04L5.

4.3.2 On switching on, checks are made of the microprocessor random access memory (RAM) and the read only memory (ROM). If errors are found, error code 01 or 02 will be generated, and the number of the faulty memory IC will be displayed. Further operation of the instrument is inhibited until the fault is corrected.

4.3.3 During the switching on sequence the front panel is automatically checked for stuck keys. If a fault is found error code 03 is generated and the code number of the faulty key is displayed.

4.3.4 A check is also made of the non-volatile memory. If an error is found error code 51 will be generated, and the number of the faulty memory IC will be displayed. Operation of the instrument is not inhibited when this fault is present, but data recalled from memory should be checked before use.

4.3.5 On switching on the instrument will be set to the same settings that were in use when the AC power was last switched off.

4.4 SIMPLIFIED OPERATING PROCEDURE

4.4.1 The basic functions of the signal generator are shown in Fig. 4.3. The procedure for changing displayed values is shown in Fig. 4.4.

4.5 OPERATING INSTRUCTIONS

4.5.1 Detailed operating instructions are given in paragraphs 4.5.2 to 4.5.23.

| | FUNCTION | DATA | | | | UNITS |
|------------------|-----------|------|---|---|---|-------|
| FREQUENCY | FREQUENCY | 1 | 9 | . | 3 | MHz |
| AM DEPTH | AM | 8 | 0 | | | % |
| FM DEVIATION | FM | 7 | 5 | | | kHz |
| PHASE MODULATION | PM | | 4 | | | Rads |
| AMPLITUDE | AMPLITUDE | +/- | 1 | 2 | 6 | dB |

The parameters in the examples above are selected by value and follow the Function - Data - Units format.

Modulation source. There are two internal modulation signals (400 Hz or 1 kHz). Either of these may be selected, or an external signal AC or DC coupled via the front panel connectors.

Fig. 4.3 Basic Signal Generator Functions

The values of all parameters are selectable in one or more of four different ways.

- (1) Data entry via keyboard.
- (2) Increment via step up Step down keys or auxiliary inputs.
- (3) Spinwheel increment
- (4) GPIB programming.

1. Data entry takes the form Function - Data - Units, e.g.

| | | | | | |
|-----------|------|---|---|---|-------|
| FREQUENCY | 1 | 0 | . | 7 | MHz |
| FUNCTION | DATA | | | | UNITS |

2. Function values can be changed in selectable steps by pressing the step up or step down keys or by using external switches connected to the AUXILIARY CONTROL SOCKET on the rear panel.
3. Values can also be changed in selectable steps by rotating the spinwheel in either direction.
4. Complete instrument operation and parameter setting can be achieved by using a GPIB controller. The instrument accepts simple instructions in the form FQ 125 MZ (frequency of 125 MHz).

Fig. 4.4 Changing Values

Frequency

4.5.2

Description. This instruction describes how to set the RF signal frequency.

Operating Characteristics:

Range: 10 kHz to 1300.000 000 MHz

Resolution: 1 Hz

Procedure Select FREQUENCY, data and units

Example:

| | | | |
|-----------------------------|-----------------------|---------------------|--------------|
| Set RF signal to 232.71 MHz | | | |
| LOCAL (Keystrokes) | Function FREQUENCY | Data 2 3 2 . 7 1 | Units MHz |
| GPIB (program codes) | FQ Function | 2 3 2 . 7 1 Data | MZ Units |

Keys and Program Codes



| Keys | Codes | Associated Error Codes | Code | Reason |
|-----------|-------|------------------------|------|--|
| Frequency | FQ | | 10 | Frequency entered greater than 1.3 GHz |
| GHz | GZ | | 11 | Frequency entered less than 10 kHz |
| MHz | MZ | | 40 | Sequence error |
| KHz | KZ | | | |
| Hz | HZ | | | |

Indications

When the FREQUENCY key is pressed the indicator above the key lights. This shows that data entries will be directed to the frequency system.

The digits of the selected frequency enter the display as the keys are pressed. Up to 10 digits and a decimal point may be entered.

When the units key is pressed the display is realigned to show the frequency entered in MHz, with 1 Hz resolution, irrespective of the units in which entry was made.

Leading zeros are blanked.

Comments

Up to the point where the units key is pressed the entry can be corrected using the BACKSPACE key, or by reselecting FREQUENCY and starting the entry again.

The output frequency changes to the value entered when the units key is pressed.

The output frequency will be set to 1.3 GHz when error code 10 is generated and 10 kHz when error code 11 is generated. The true output frequency, not the value entered, will be displayed.

When the FREQUENCY indicator is lit the frequency displayed can be changed using the increment controls.



As an alternative to the use of the units code, the frequency set via the GPIB can be expressed in exponential form, e.g. FQ1376.2E+03 will set a frequency of 1.3762 MHz. Frequency data will be assumed to be in Hz for entries made in the exponential format.

The code FQ sent without data will select frequency as the primary function.

Related Instructions

Frequency Relative
Increment
Step Size, Operator Set
Frequency, Sweep

Frequency, Relative

4.5.3

Description

This instruction describes how to set the output frequency and display it relative to a chosen reference frequency.

Operating Characteristics:

Frequency Offset Range: 1 Hz to 1299.990 000 MHz

Procedure

Set the required reference frequency

Press **REL** (LED on and RELATIVE indicator below frequency display lit).

Set the displayed offset such that

Required output frequency = Reference frequency + Displayed frequency offset.

To return to the normal display mode, ensure that the FREQUENCY key indicator is lit and then press either **REL** or **FREQUENCY**

Example

Set a reference frequency of 11.7 MHz. Set the output frequency to have an offset of 75 kHz below the reference and display the offset. (Output frequency is 11.625 MHz).

| | Function | Data | Units |
|-------------------------|------------------------------------|-----------------------------------|---------------------------------|
| LOCAL (keystrokes) | FREQUENCY REL | 1 1 . 7 ± 7 5 | MHz kHz |
| GPIB (program codes) | FQ FR Function | 11.7 -75 Data | MZ KZ Units |

Keys and Program Codes

| Keys | Codes |
|-------------------------|-------|
| FREQUENCY | FQ |
| FREQUENCY and REL | FR |
| GHz | GZ |
| MHz | MZ |
| kHz | KZ |
| Hz | Hz |

Associated Error Codes

| Code | Reason |
|------|---|
| 12 | Reference frequency and frequency offset entered require an output frequency greater than 1.3 GHz |
| 13 | Reference frequency and frequency offset entered require an output frequency less than 10 kHz |
| 40 | Sequence error. |



Indications

When the FREQUENCY key is pressed the indicator above the key lights. This shows that data entries will be directed to the frequency system.

When the reference frequency has been set, this value, in MHz, will be shown in the frequency display.

When the REL key is pressed the key indicator will light. A RELATIVE legend below the frequency display will be illuminated and the frequency display will show the last frequency offset entered.

The digits of the new frequency offset enter the display as the keys are pressed. Up to 10 digits and a decimal point may be entered.

Comments

When the REL key is pressed the output frequency will change to a value determined by the last frequency offset entered.

Up to the point where the units key is pressed the entry can be corrected using the BACKSPACE key.

The frequency offset entered is set, and the output frequency changes, when the units key is pressed.

The \pm key is only required when entering negative offsets. It can be used at any point during the data entry.

The sign of the displayed offset can be changed by pressing \pm and any frequency units key.

If any function key other than FREQUENCY is operated the relative mode for frequency is maintained. The REL key indicator will be extinguished, but the RELATIVE indicator below the frequency display will remain lit.

When the FREQUENCY and REL key indicators are lit the displayed frequency offset can be changed using the increment controls.

The output frequency will be set to 1.3 GHz when error code 12 is generated and 10 kHz when error code 13 is generated. The actual offset, not the value entered, will be displayed.



As an alternative to the use of the units code, the offset can be expressed in exponential form, e.g. FR-12.5E+03 will set a negative frequency offset of 12.5 kHz. Frequency data will be assumed to be in Hz for entries made in the exponential format.

The code FR sent without data will put the instrument to the relative frequency mode, using the last frequency offset entered.

Related Instructions

Frequency
Increment
Step Size, Operator Set

Frequency, Sweep

4.5.4

Description

This instruction describes how to set up and use the frequency sweep facility.

Operating characteristics:

Start frequency: 10.000 kHz to 1299.999 999 MHz
 Stop frequency : 10.001 kHz to 1300.000 000 MHz
 Increasing frequency sweep only is permitted.
 Frequency step size: 1 Hz to 1299.990 MHz
 Dwell time: 2 ms : Special Function 82
 20 ms : Special Function 83
 200 ms : Special Function 84
 1 s : Special Function 85

Procedure

Set start frequency
 Set stop frequency
 Set step size
 Select dwell time and start sweep
 To stop the sweep, press any key or operate the spinwheel.

Example

Set a start frequency of 29.200 000 MHz and a stop frequency of 30.800 000 MHz. Initiate a frequency sweep with a step size of 25 kHz and a dwell time of 200 ms.

| | | | | |
|-----------------------|-----------|---------|-------|-----------------------------------|
| LOCAL (keystrokes) | Function | Data | Units | Store Start Frequency |
| | FREQUENCY | 2 9 . 2 | MHz | SPECIAL FUNCT 8 0 |
| | | | | |
| | | Data | Units | Store Stop Frequency |
| | | 3 0 . 8 | MHz | SPECIAL FUNCT 8 1 |
| | | | | |
| | Function | Data | Units | Select Dwell Time and Start Sweep |
| | STEP SIZE | 2 5 | kHz | SPECIAL FUNCT 8 4 |

| | | | | |
|----------------------------|-----------------------|---------------------|--------------------|---|
| GPIB (program codes) | <u>FQ</u> Function | <u>29.2</u> Data | <u>MZ</u> Units | <u>DG 80</u> Store Start Frequency |
| | | <u>30.8</u> Data | <u>MZ</u> Units | <u>DG 81</u> Store Stop Frequency |
| | <u>FS</u> Function | <u>25</u> Data | <u>KZ</u> Units | <u>DG 84</u> Select Dwell Time and start sweep |

Keys and
Program Codes



| Keys | Codes | Associated Error Codes | Code | Reason |
|------------------|-------|------------------------------|------|--|
| FREQUENCY | FQ | | 40 | Sequence error |
| GHz | GZ | | 45 | Attempt made to start sweep with step size of zero |
| MHz | MZ | | | |
| kHz | KZ | | | |
| Hz | HZ | | | |
| SPECIAL FUNCT | DG | | | |

Indications

When the sweep is operating a SWEEP legend appears below the frequency display.

The frequency display shows the output frequency throughout.

Comments

The start and stop frequencies can be displayed, whether the sweep is operating or not, using special functions 86 and 87. A SWEEP START or SWEEP STOP legend will appear below the frequency display. If the start frequency stored is greater than the stop frequency stored the values will be exchanged when the sweep is started.

The step size used for the sweep is the operator set step size for frequency increments. Any previously entered step size will be over-written.

If the sweep is interrupted it will restart from the start frequency.

Related
Instructions

Frequency
Step Size, Operator Set

Amplitude

4.5.5

Description

This instruction describes how to set RF signal amplitude.

Operating Characteristics:

Range: +19 dBm to -140 dBm (2 V - 22.4 nV) into 50 Ω .
Resolution: 0.1 dBm

Residual Signal Level:

With the RF output off the residual signal output will be at least 150 dB/Hz below the carrier level set.

Carrier Level Settling Time:

The carrier level is re-established 400 μ s after switching the RF on.

Procedure

Select AMPLITUDE, data, and units.

To turn the RF output on, press output



(LED on)

To turn the RF output off, press output



(LED off)

Example

| Set RF signal amplitude to -12.7 dBm or 51.8 mV | | | |
|---|---------------------|-------------|---------------------|
| LOCAL (keystrokes) or | Function | Data | Units |
| | AMPLITUDE | +/- 1 2 . 7 | dB |
| | AMPLITUDE | 5 1 . 8 | mV |
| GPIB (program codes) | AP -12.7 DB | OR | AP 51.8 MV |
| | Function Data Units | | Function Data Units |

Keys and Program Codes



| Keys | Codes | Associated Error Codes | Code | Reason |
|---------------|-------|------------------------|----------------|---|
| AMPLITUDE | AP | | 15 | Amplitude input exceeds +19 dBm or 2.0 V |
| V | VO | | | |
| mV | MV | | 16 | Amplitude input less than -140 dBm or 22.4 nV |
| μ V | UV | | | |
| nV | NV | | | |
| dB | DB | 40 | Sequence error | |
| RF OUTPUT ON | OP1 | | | |
| RF OUTPUT OFF | OP0 | | | |

Indications

When the AMPLITUDE key is pressed the indicator above the key lights. This shows that data entries will be directed to the amplitude system.

The digits of the selected amplitude enter the display as the keys are pressed. Up to four digits and a decimal point can be entered. The units indicator lights when the units key is pressed.

When the units key is pressed the display shows up to four digits, with resolution of 0.1 dB, for amplitudes entered in dBm or up to three digits, with floating decimal point, for amplitudes entered in voltage units.

Up to the point where the units key is pressed the entry can be corrected using the BACKSPACE key, or by reselecting AMPLITUDE and starting the entry again.

The output amplitude changes to the value entered when the units key is pressed.

The output amplitude will be set to +19 dB (2 V) when error code 15 is generated and -140 dBm (22.4 nV) when error code 16 is generated. The true amplitude, not the value entered, will be displayed.

When the AMPLITUDE indicator is lit the amplitude displayed can be changed using the increment controls.

Comments

The display units may be changed from 'volts' to 'dB' by pressing the dB key. Similarly, pressing any 'VOLTS' key will change the display mode to 'VOLTS' mode from 'dB' mode.



As an alternative to units code the value may be expressed in exponential form, e.g. AP100E-03 (100 mV). Amplitude data will be assumed to be in volts. Units conversion may be achieved via GPIB by transmitting no data with the required units e.g. APUV. This will not change the actual output amplitude.

Related Instructions

Amplitude, Relative
Increment
Step Size, Operator Set.

Amplitude, Relative

4.5.6

Description

This instruction describes how to set the output amplitude to have an operator selectable offset from a chosen reference amplitude.

Operating Characteristics:

Amplitude Offset Range: 0.1 dB to 159 dB
0.1 nV to 1.99 V

Procedure

Set the required reference amplitude

Press **REL** (LED on and RELATIVE indicator below amplitude display lit).

Set the displayed offset such that

Required output amplitude = Reference amplitude +
Displayed amplitude offset.

To return to the normal display mode ensure that the AMPLITUDE key indicator is lit and then press either **REL** or **AMPLITUDE**

Example 1

Set a reference amplitude of 1 V. Set the output amplitude to have an offset of 0.1 V below the reference and display the offset. (Output amplitude is 900 mV).

| | | | |
|-------------------------|--|----------------------------------|-------------------------------|
| LOCAL (keystrokes) | Function AMPLITUDE REL | Data 1 ± . 1 | Units V V |
| GPIB (program codes) | AP AR Function | 1 - . 1 Data | VO VO Units |

Example 2

| | | | |
|---|------------------------------|------------------|------------------------|
| Set a reference amplitude of 1 μ V. Set the output amplitude to be 30 dB above the reference level. (Output amplitude is +30 dB μ V). | | | |
| LOCAL (keystrokes) | Function AMPLITUDE REL | Data 1 3 0 | Units μ V dB |
| GPIB (program codes) | AP AR Function | 1 30 Data | UV DB Units |

Keys and Program Codes

| Keys | Codes | Associated Error Codes | Code | Reason |
|-------------------|-------|------------------------|------|--|
| AMPLITUDE | AP | | 17 | Reference amplitude and amplitude offset entered demand an output amplitude greater than +19 dBm (2 V) |
| AMPLITUDE and REL | AR | | | |
| V | VO | | 18 | Reference amplitude and amplitude offset entered demand an output amplitude less than -140 dBm (22.4 nV) |
| mV | MV | | | |
| μ V | UV | | | |
| nV | NV | | | |
| dB | DB | | 40 | Sequence error |



Indications

When the AMPLITUDE key is pressed the indicator above the key lights. This shows that data entries will be directed to the amplitude system.

When the reference amplitude has been set, this value, in dB or voltage units, will be shown in the amplitude display.

When the REL key is pressed the key indicator will light. A RELATIVE legend below the amplitude display will be illuminated, and the amplitude display will show the last amplitude offset entered.

Comments

When the REL key is pressed the output amplitude will change to a value determined by the last amplitude offset entered.

Up to the point where the units key is pressed the entry can be corrected using the BACKSPACE key.

The amplitude offset entered is set, and the output amplitude changes, when the units key is pressed.

The offset can be entered in dB relative to a voltage level, or in voltage units relative to a level in dBm.

The \pm key is only required when entering negative offsets. It can be used at any point during the data entry.

The reference amplitude and the amplitude offset may be entered in any combination of dB and voltage units.

The sign of the displayed offset can be changed by pressing \pm and the units key corresponding to the displayed value.

If any function key other than AMPLITUDE is operated the relative mode for amplitude is maintained. The REL key indicator will be extinguished, but the RELATIVE indicator below the amplitude display will remain lit.

The output amplitude will be set to +19 dBm (2 V) when error code 17 is generated and -140 dBm (22.4 nV) when error code 18 is generated. The actual offset, not the value entered, will be displayed.

When the AMPLITUDE and REL key indicators are lit the displayed amplitude offset can be changed using the increment controls.



As an alternative to the use of the units code, the offset can be expressed in exponential form, e.g. AR-12E-03 will set a negative amplitude offset of -12 mV. Amplitude data will be assumed to be in volts for entries made in the exponential format.

The code AR sent without data will put the instrument to the relative frequency mode, using the last amplitude offset entered.

Related Instructions

Amplitude
Increment
Step Size, Operator Set

Modulation, Amplitude

4.5.7

Description

This instruction describes how to set up and use the AM system.

Operating Characteristics:

AM Depth: 0% to 99%

Resolution: 1%

Modulating Frequency:

| Carrier Frequency | Internal Source | External Source |
|---------------------|-----------------|---|
| 1.5 MHz to 1300 MHz | 400 Hz or 1 kHz | AC: 20 Hz to 20 kHz (-3dB) DC: DC to 20 kHz (-3dB) |
| 0.15 MHz to 1.5 MHz | 400 Hz or 1 kHz | AC: 20 Hz to 5 kHz (-3dB) DC: DC to 5 kHz (-3dB) |

Procedure

Select AM, data and %

Select Modulating frequency or external source.

To turn modulation on, press AM

| |
|-----|
| ON |
| OFF |

 (LED on)

To turn modulation off, press AM

| |
|-----|
| ON |
| OFF |

 (LED off)

Example

| Set AM, 75% depth, 1 kHz frequency from internal source and switch modulation on. | | | | | | | | | | | | | |
|---|--|------------|---|---------------|-----------|--|---|--|-----|------|--|----|-----|
| LOCAL (keystrokes) | Function <table border="1"><tr><td>AM</td></tr></table> | AM | Data <table border="1"><tr><td>7</td><td>5</td></tr></table> | 7 | 5 | Units <table border="1"><tr><td>%</td></tr></table> | % | Source <table border="1"><tr><td>INT</td><td>1kHz</td></tr></table> | INT | 1kHz | ON <table border="1"><tr><td>ON</td><td>OFF</td></tr></table> | ON | OFF |
| AM | | | | | | | | | | | | | |
| 7 | 5 | | | | | | | | | | | | |
| % | | | | | | | | | | | | | |
| INT | 1kHz | | | | | | | | | | | | |
| ON | OFF | | | | | | | | | | | | |
| GPIB (program codes) | AM Function | 75 Data | % or PC Units | MA3 Source | MA1 ON | | | | | | | | |

Keys and Program Codes



| Keys | Codes |
|------------|---------|
| AM | AM |
| % | % or PC |
| OFF | MA0 |
| ON | MA1 |
| 400 Hz INT | MA2 |
| 1 kHz INT | MA3 |
| EXT AC | MA4 |
| EXT DC | MA5 |

Associated Error Codes

| Code | Reason |
|------|---|
| 24 | AM depth entry excessive |
| 25 | AM depth excessive for output amplitude |
| 32 | External modulating signal input level too low |
| 33 | External modulating signal input level too high |
| 40 | Sequence error |

Indications

When the AM key is pressed the indicator above the key lights. This shows that data entries will be directed to the AM system.

When the AM key is the last MODULATION key pressed, the modulation depth is shown in the modulation display. Two digits are displayed.

The CAL? indicator to the right of the modulation display lights if AM is enabled with

- (a) EXT DC selected
- (b) EXT AC selected with a carrier frequency below 1.5 MHz
- (c) a carrier frequency below 150 kHz.

When AM is selected as the form of modulation given by the AM/Pulse system, the status of the system is shown by the indicators to the right of the control keys.

Comments

Up to the point where the % key is pressed the entry can be corrected by means of the BACKSPACE key.

The resolution for AM depth is 1%. Entries made with greater resolution will be rounded to the nearest 1% when the % key is pressed.

Whenever AM is selected as the form of modulation to be given by the AM/PULSE modulation system, the control keys remain functional when the AM primary function key indicator is not lit.

When AM is deselected the settings of the system control keys for AM are stored. The stored values will be recalled when AM is reselected.

Related Instructions

Modulation, External Source
 Modulation, Mixed
 Increment

Modulation, Pulse

4.5.8

Description

This instruction describes how to set up and use the pulse modulation system.

Operating Characteristics (maximum OFF time of 50 ms)

ON/OFF Ratio:

> 50 dB for carrier frequency from 10 MHz to 750 MHz

> 35 dB for carrier frequency from 750 MHz to 1300 MHz.

Rise and Fall Time:

< 40 ns

Modulating Frequency:

| Carrier Frequency | Internal Source | External Source |
|--------------------|------------------|---|
| 10 MHz to 1300 MHz | 400 Hz and 1 kHz | AC: 20 Hz to 2.5 MHz DC: DC to 2.5 MHz |

Procedure



Select PULSE

Select internal modulating frequency or external source.

To turn modulation on, press Pulse  (LED on)

To turn modulation off, press Pulse  (LED off)

Example

| Enable pulse modulation, external source, DC coupled and switch modulation on. | | | |
|--|---|--|---|
| | Function | Source | ON |
| LOCAL (keystrokes) |  |  |  |
| GPIB (program codes) | PM └─ Function | MP5 └─ Source | MP1 └─ ON |

Keys and Program Codes



| Keys | Codes |
|------------|-------|
| PULSE | PM |
| OFF | MP0 |
| ON | MP1 |
| 400 Hz INT | MP2 |
| 1 kHz INT | MP3 |
| EXT AC | MP4 |
| EXT DC | MP5 |

Associated Error Codes

| Code | Reason |
|------|---|
| 32 | External modulating signal input too low |
| 33 | External modulating signal input too high |
| 40 | Sequence error |
| 42 | Data input attempted with PULSE selected |

Indications

When the PULSE key is pressed the indicator above the key lights.

When the PULSE key is the last MODULATION key pressed, the modulation display is blanked. A PULSE indicator to the right of the display lights.

When PULSE is selected as the form of modulation given by the AM/Pulse system, the status of the system is shown by the indicators to the left of the control keys.

If pulse modulation is enabled with a carrier frequency below 10 MHz the CAL? indicator will light.

Comments

No data entry may be made with PULSE selected.

Whenever pulse modulation is selected as the form of modulation given by the AM/PULSE modulation system, the control keys remain functional when the pulse modulation primary function key indicator is not lit.

When PULSE is deselected the settings of the system control keys for pulse modulation are stored. The stored values will be recalled when PULSE is reselected.

Related Instructions

Modulation, External Source
Modulation, Mixed.

Modulation, Frequency

4.5.9

Description This instruction describes how to set up and use the FM system.

Operating Characteristics:

Peak Deviation: 0 kHz to 999 kHz

Maximum Resolution: 10 Hz

Modulating Frequency:

| Carrier Frequency | Internal Source | External Source |
|--------------------|-----------------|---|
| 10 kHz to 1300 MHz | 400 Hz or 1 kHz | AC: 20 Hz to 100 kHz (-3dB) DC: DC to 100 kHz (-3dB) |

Procedure

Select FM, data and units

Select modulating frequency or external source

To turn modulation on, press FM ON OFF (LED on)

To turn modulation off, press FM ON OFF (LED off)

Example

| Set FM peak deviation to 12.5 kHz, 400 Hz internal modulation source and switch modulation on | | | | | |
|---|-----------------------------|---|------------------------------|--|--|
| | Function | Data | Units | Source | ON |
| LOCAL (keytrokes) | <input type="checkbox"/> FM | <input type="checkbox"/> 1 <input type="checkbox"/> 2 <input type="checkbox"/> . <input type="checkbox"/> 5 | <input type="checkbox"/> kHz | <input type="checkbox"/> INT 400 Hz | <input checked="" type="checkbox"/> ON <input type="checkbox"/> OFF |
| GPIB (program codes) | <u>FM</u> Function | <u>12.5</u> Data | <u>KZ</u> Units | <u>MF2</u> Source | <u>MF1</u> ON |

Keys and Program Codes



| Keys | Codes |
|------------|-------|
| FM | FM |
| MHz | MZ |
| kHz | KZ |
| Hz | HZ |
| OFF | MF0 |
| ON | MF1 |
| 400 Hz INT | MF2 |
| 1 kHz INT | MF3 |
| EXT AC | MF4 |
| EXT DC | MF5 |

Associated Error Codes

| Code | Reason |
|------|---|
| 20 | Frequency deviation set excessive for carrier frequency in use. |
| 21 | Frequency deviation entry excessive for frequency range in use |
| 30 | External modulating signal input too low |
| 31 | External modulating signal input too high |
| 40 | Sequence error |

Indications

When the FM key is pressed the indicator above the key lights. This shows that data entries will be directed to the FM system.

When FM key is the last MODULATION key pressed the peak deviation is shown in the modulation display. Up to three digits and a decimal point are displayed. Excess digits are ignored. The deviation is displayed in kHz, with the greatest possible resolution, irrespective of the units of entry.

When FM is selected as the form of modulation given by the FM/DM system, the status of the system is shown by the indicators to the left of the control keys.

When FM is used with EXT DC selected the CAL? indicator to the right of the modulation display will light.

Comments

Up to the point where the units key is pressed the entry can be corrected using the BACKSPACE key.

Entries made with resolution greater than 10 Hz will be rounded and displayed to the nearest 10 Hz.

Whenever FM is selected as the form of modulation given by the FM/DM system, the control keys remain functional when the FM primary function key indicator is not lit.

When FM is deselected the settings of the system control keys for FM are stored. The stored values will be recalled when FM is reselected.

When the FM indicator is lit the peak deviation displayed can be changed using the increment controls.



In addition to the use of the units code, the peak deviation set via the GP1B can be expressed in exponential form, e.g. FM 12.5E+03 will set a peak deviation of 12.5 kHz. Frequency modulation data will be assumed to be in Hz.

**Related
Instructions**

Modulation, External Source
Modulation, Mixed
Increment

Modulation, Phase

4.5.10

Description

This instruction describes how to set up and use the phase modulation system.

Operating Characteristics:

Peak Phase Deviation:

| Carrier Frequency | Maximum Peak Phase Deviation |
|-------------------|---|
| 10 kHz to 60 kHz | As given by $\frac{\text{Carrier frequency} \cdot 10^4}{\text{Modulating frequency}}$ radians |
| 60 kHz to 130 MHz | 5 radians |

Resolution: 0.01 radian
 Modulating Frequency: 400 Hz or 1 kHz from internal source
 20 Hz to 10 kHz (-3 dB) from external source

Procedure









Select Φ M, data and Rads

Select modulating frequency or external source.

To turn modulation on, press Phase Modulation  (LED on)

To turn modulation off, press Phase Modulation  (LED off)

Example

| Set Phase Modulation, peak deviation to 1.57 radians, external source, AC coupled, and switch modulation on. | | | | | |
|--|---|--|---|---|---|
| LOCAL (keystrokes) | Function | Data | Units | Source | ON |
| |  |     |  |  |  |
| GPIB (program codes) | Function | Data | Units | Source | ON |
| | <u>HM</u> | <u>1.57</u> | <u>RD</u> | <u>MH4</u> | <u>MH1</u> |

Keys and Program Codes



| Keys | Codes |
|------------|-------|
| ΦM | HM |
| Rads | RD |
| OFF | MH0 |
| ON | MH1 |
| 400 Hz INT | MH2 |
| 1 kHz INT | MH3 |
| EXT AC | MH4 |

Associated Error Codes

| Code | Reason |
|------|---|
| 22 | Peak phase deviation entered excessive |
| 23 | Peak phase deviation excessive for carrier frequency |
| 30 | External modulating signal input too low |
| 31 | External modulating signal input too high |
| 40 | Sequence error |
| 43 | External modulating signal input with DC coupling not permitted |

Indications

When the ΦM key is pressed the indicator above the key lights. This shows that data entries will be directed to the phase modulation system.

When the ΦM key is the last MODULATION key pressed the peak phase deviation is shown in the modulation display. Three digits and a decimal point are displayed.

When phase modulation is selected as the form of modulation given by the FM/ΦM system, the status of the system is shown by the indicators to the right of the control keys.

Comments

Up to the point where the RADS key is pressed the entry can be corrected by means of the BACKSPACE key.

The resolution for peak phase deviation is 0.01 radian.

Whenever phase modulation is selected as the form of modulation given by the FM/ΦM system, the control keys remain functional when the ΦM primary function key indicator is not lit.

When phase modulation is deselected the settings of the system control keys for phase modulation are stored. The stored values will be recalled when phase modulation is reselected.

If phase modulation is enabled with a carrier frequency less than 60 kHz the CAL? indicator to the right of the modulation display lights to warn that the calibration of the display is not guaranteed.

When the ΦM indicator is lit the peak phase deviation displayed can be changed using the increment controls.



In addition to the use of the units code, the peak phase deviation set via the GPIB can be expressed in exponential form, e.g. HM3.5E-01 will set a peak phase deviation of 0.35 radians. Phase modulation data will be assumed to be in radians.

**Related
Instructions**

Modulation, External Source
Modulation, Mixed
Increment

Modulation, Mixed

4.5.11

Description

This instruction describes how to operate the instrument with more than one modulation system active.

Operating Characteristics:

Possible Modulation Combinations: AM and FM
 AM and Φ M
 Pulse and FM
 Pulse and Φ M





Procedure

Set the required modulation parameters for the forms of modulation to be used, as instructed in the individual modulation instructions.

Enable and disable the modulation systems using the appropriate ON/OFF key.

To change the form of modulation provided by a system, press the primary function key for the required modulation. The modulation parameters last used with that form of modulation will be recalled.

Example

| | | | |
|---|--|--|---|
| Change from AM+FM to PULSE+FM, using the previously stored parameters for pulse modulation. Enable pulse modulation | | | |
| LOCAL (keystrokes) | System Changeover  | Enable  | Enablement is not required if this is already included in the stored settings |
| GPIB (program codes) | MP1  Select Pulse Modulation and Enable | OR | PM  Select Pulse Modulation. Set stored control settings |

Indications

The modulation display shows the parameters of the form of modulation selected by the last operation of a modulation primary function key. The form of modulation is shown by the units indicator or PULSE indicator.

The status of the selected form of modulation for each system is shown by the indicators beside the control keys.

Related Instructions

Modulation, Amplitude
 Modulation, Pulse
 Modulation, Frequency
 Modulation, Phase
 Modulation, External Source

Modulation, External Source

4.5.12

Description

This instruction describes how to connect and set the level of an external modulating signal source.

Operating Characteristics:

Input Socket: Separate BNC sockets are provided for the AM/PULSE and FM/ Φ M systems.

Input Impedance: 16 k Ω for PULSE
600 Ω for AM, FM and Φ M

Input Level:

| | AC | DC |
|----------|---------------------------------|-------------------------------|
| AM | 0.56 V to 5.6 V peak-to-peak | 1.414 V peak |
| PULSE | > 3.0 V peak-to-peak | ON = > 1.7 V OFF = < 0.9 V |
| FM | 0.56 V to 5.6 V peak-to-peak | 1.414 V peak |
| Φ M | 0.56 V to 5.6 V peak-to-peak | DC coupling not permitted |

Procedure

Connect external source to the appropriate input socket.

Switch on source

Select the external modulating source, with AC or DC coupling, as required, using the appropriate modulation system control key.

Adjust the source level.

NOTE: For AC coupling with AM, FM or Φ M the level should be adjusted until the HIGH and LOW indicators adjacent to the AF input socket are both extinguished. For all other cases the level must be set using external measuring equipment.

Related Instructions

Modulation, Amplitude
Modulation, Pulse
Modulation, Frequency
Modulation, Phase
Modulation, Mixed

Increment

4.5.13

Description

This instruction describes how to step a displayed value up or down by a pre-selected amount using the step keys, auxiliary control inputs or the spinwheel.

Operating Characteristics:

Controllable Parameters: Frequency
 Frequency offset
 Amplitude
 Amplitude offset
 AM depth
 FM peak deviation
~~FM~~ peak deviation
 Memory location (in recall mode only)

Parameter Selection: By means of the primary function key or RECALL key relating to the display to be changed.

Step Size Selection: By means of the COARSE, MEDIUM and FINE sensitivity keys or the STEP key.

NOTE: The use of the STEP key is permitted for frequency or amplitude only.

Step Sizes Available:

| Primary Function | Step Size | | |
|----------------------------|---|---------------------------------|--|
| | Coarse | Medium | Fine |
| Frequency | 1 MHz | 1 kHz | 1 Hz |
| Amplitude (volts) | Most significant digit | Second digit | Least significant digit |
| Amplitude (dB) | 10 dB | 1 dB | 0.1 dB |
| Amplitude Relative (volts) | Most significant digit of reference level | Second digit of reference level | Least significant digit of reference level |

| | | | |
|---------------------------|------------------------|--------------|-------------------------|
| AM depth | 10 % | 5 % | 1% |
| FM peak deviation | Most significant digit | Second digit | Least significant digit |
| PM peak deviation | 1 rad | 0.1 rad | 0.01 rad |
| Memory (recall mode only) | One memory location | | |

Spinwheel Disablement: The spinwheel, but not the step keys can be disabled by selecting **HOLD** (LED on). The spinwheel is enabled by selecting **HOLD** a second time (LED off).

Procedure

Select required function
 Display the parameter to be changed
 Select COARSE, MEDIUM or FINE to obtain the required step size.
 For frequency and amplitude only, the operator set step size may be enabled by selecting STEP.
 Operate the step up or step down key, the external step switch or the spinwheel.

Example 1

| | | | |
|--|---------------------------|---------------------------|--|
| Display the frequency offset and change the offset by -2.998 kHz | | | |
| LOCAL (keystrokes) | Function FREQUENCY REL | Step Size 1 kHz MEDIUM | -3 kHz ↓ ↓ ↓ |
| | Step Size 1 Hz FINE | +2 Hz ↑ ↑ | The spinwheel or external step switches may be used instead of the step keys |
| GPIB (program codes) | FR Function | IN3 Step Size 1 kHz | FD FD FD -3 kHz |
| | IN2 Step Size 1 Hz | FU FU -2 Hz | |

Example 2

| | | | |
|--|-----------------------|-------------------|------------------------------|
| Display the output amplitude and increase the value displayed by the value of the operator selected step | | | |
| LOCAL (keystrokes) | Function AMPLITUDE | Step Size STEP | Step Up ↑ |
| GPIB (program codes) | IN5 Step Size | | AU Amplitude Step Up |

Keys and Program Codes

| Keys | Codes | Associated Error Codes | Code | Reason |
|---------------------------|-------|------------------------|------|-----------------------------------|
| FREQUENCY and STEP UP | FU | | 40 | Sequence error |
| FREQUENCY and STEP DOWN | FD | | 41 | Invalid use of increment controls |
| AMPLITUDE and STEP UP | AU | | | |
| AMPLITUDE and STEP DOWN | AD | | | |
| HOLD (Spinwheel enabled) | IN0 | | | |
| HOLD (Spinwheel disabled) | IN1 | | | |
| COARSE | IN2 | | | |
| MEDIUM | IN3 | | | |
| FINE | IN4 | | | |
| STEP | IN5 | | | |

Indications When the required primary functions key is pressed the indicator above the key lights. This shows that data entries from the increment controls will vary the value shown in the corresponding display.

The key indicator to the left of the selected sensitivity key lights.

Comments The spinwheel should be turned clockwise to increase and anti-clockwise to decrease the parameter to be changed.

A succession of steps can also be obtained by pressing and holding the step up key or the step down key.

Software de-bouncing of the external step switches is selected using special function 05 and disabled using special function 06. The de-bouncing time is 20 ms.

Related Instructions Frequency
Frequency, Relative
Amplitude
Amplitude, Relative
Modulation, Amplitude
Modulation, Frequency
Modulation, Phase
Step Size, Operator Set.

Step Size, Operator Set

4.5.14

Description

This instruction describes how to set the operator-selectable step size for use with the increment controls.

Operating Characteristics:

Range and Resolution:

| Function | Units | Range | Resolution |
|-----------|-------|---------------------|--------------------------|
| Amplitude | Volts | 0.1 nV to 1.99 V | 1 LSD of displayed value |
| Amplitude | dB | 0.1 dBm to 159 dBm | 0.1 dBm |
| Frequency | Hz | 1 Hz to 1299.99 MHz | 1 Hz |

Procedure

Select AMPLITUDE or FREQUENCY as required, unless already active.

Press **STEP SIZE** (LED on)

Enter data and units, using keyboard

If no change to the step size is required press **STEP SIZE** (LED off) or any primary function key

Example

| Set amplitude step size to 1.2 dB or 51.8 mV | | | | | | | |
|--|-----------------------------|--------------------|--------------------|-------|-----------------------------|---------------------|--------------------|
| | Function | Step Size | Data | Units | | | |
| LOCAL (keystrokes) | AMPLITUDE | STEP SIZE | 1 . 2 | dB | | | |
| or | AMPLITUDE | STEP SIZE | 5 1 . 8 | mV | | | |
| GPIB (program codes) | <u>AS</u> Amplitude Step | <u>1.2</u> Data | <u>dB</u> Units | or | <u>AS</u> Amplitude Step | <u>51.8</u> Data | <u>MV</u> Units |

Keys and Program Codes



| Keys | Codes | Associated Error Codes | Code | Reason |
|-------------------------|-------|------------------------|------|-------------------------------------|
| AMPLITUDE and STEP SIZE | AS | | 14 | Frequency step size entry excessive |
| FREQUENCY and STEP SIZE | FS | | 19 | Amplitude step size entry excessive |
| V | VO | | 40 | Sequence error |
| mV | MV | | 41 | Invalid use of increment controls |
| μV | UV | | | |
| nV | NV | | | |
| dB | DB | | | |
| GHz | GZ | | | |
| MHz | MZ | | | |
| kHz | KZ | | | |
| Hz | HZ | | | |

Indications

The key indicator of the primary function selected will light when the key is pressed.

When STEP SIZE is selected the key indicator will light. A STEP SIZE legend below the display corresponding to the selected function will be illuminated. The display will show the last step size entered.

The display will revert to the normal mode, with the STEP SIZE legend and the STEP SIZE key indicator extinguished, if the STEP SIZE key is operated a second time or if any function key is operated.

The display will revert to the normal mode when the units key is released following the entry of a new step size by means of the keyboard.

Comments

Up to the point where the units key is pressed the entry can be corrected using the BACKSPACE key.

The increment controls cannot be used to change a displayed step size.



In addition to the use of the units code, the step size set via the GPIB can be expressed in exponential form, e.g. AS1.8E-03 will set an amplitude step size of 1.8 mV
 FS25E+03 will set a frequency step of 25 kHz
 Data will be assumed to be in volts or Hz.

Related Instructions

Increment
 Frequency Sweep

Initialisation

4.5.15

Description

This instruction describes how to initialise the instrument settings.

Operating characteristics: The instrument initialisation routine is as follows:

All the front panel LEDs will be switched on for two seconds, after which the address set on the GPIB is displayed, in binary and decimal form, for two seconds. A check for corruption of the ROM contents is made, followed by a check of the functioning of the non-volatile memory. The instrument is then set to the following state:

| | |
|---------------------------|-------------------------|
| Frequency | 100 MHz |
| Relative frequency offset | 0 MHz |
| Frequency step size | 12.5 kHz |
| Sweep start frequency | 1 MHz |
| Sweep stop frequency | 1.3 GHz |
| | |
| Amplitude | -30 dBm |
| Relative amplitude offset | 0 dBm |
| Amplitude step size | 3 dB |
| | |
| Modulation | All forms disabled |
| AM/Pulse system | AM |
| FM/ØM system | FM |
| AM | 0%, 400 Hz INT, OFF |
| Pulse | 400 Hz INT, OFF |
| FM | 0 kHz, 400 Hz INT, OFF |
| ØM | 0 rads, 400 Hz INT, OFF |
| Modulation display | FM |
| | |
| RF Output | ON |
| Spinwheel | Enabled |
| Sensitivity | COARSE |
| Primary function | FREQUENCY |
| RPPU (if fitted) | Reset |

Procedure

Press INIT

Keys and Program Codes



| Keys | Codes |
|------|-------|
| INIT | IP |

Associated Error Codes

| Code | Reason |
|------|--|
| 02 | ROM contents corrupted |
| 51 | Functional failure of non-volatile memory. |

Comments

No checks of ROM contents or non-volatile memory function are made on initialisation via the GPIB.

Memory, Store

4.5.16

Description

This instruction describes how to store the current front panel settings of the instrument in a designated location within the instrument's non-volatile memory.

Operating Characteristics:

Available Locations: Normal 33
Optional 100

Location Address: Two digit number

Write Protection: Write protection of the whole memory, not individual locations, is available as a special function.

Procedure

Press **STORE** (LED on)

Enter the two digit address of the required location using the numeric keyboard (EXEC key LED flashes)

Press **EXEC** (LED off)

Example

| Store current front panel settings in memory location 07 | | | |
|--|--------------------------|------------------------|--|
| LOCAL (keystrokes) | Function STORE | Location 0 7 | Store Displayed Pattern EXEC |
| GPIB (program codes) | <u>MS</u> Function | <u>07</u> Location | <u>ME</u> Store Displayed Pattern |

Keys and Program Codes



| Keys | Codes |
|-------|-------|
| STORE | MS |
| EXEC | ME |

Associated Error Codes

| Code | Reason |
|------|--|
| 40 | Sequence error |
| 41 | Invalid use of spinwheel or increment keys |
| 44 | Exponential entry of address not permitted |
| 50 | Memory board not fitted |
| 53 | Memory location not available. |
| 54 | Single digit entered as address |
| 55 | Attempted use of MEM EXCH key |
| 56 | Store attempted when WRITE PROTECT is set |

Indications

The STORE key indicator lights when the key is pressed. This shows that data entries will be directed to the store system.

The digits of the selected memory location will appear in the memory display as they are entered.

The indicator of the EXEC key will flash when the second address digit is entered.

The indicators of the STORE and EXEC keys are extinguished, and the memory display is blanked when storage is complete.

Comments

Up to the point where the EXEC key is pressed the memory location may be changed by means of the BACKSPACE key, or by reselecting STORE and making the entry again.

The address entered must contain two digits. A leading zero must be entered for locations 00 to 09.

Location 00 is used to store the instrument's status when power is switched off. Under these circumstances data in this location will be overwritten.

The spinwheel and step keys can not be used to change a displayed location address.

The primary function, the special functions enabled and the SRQ mask setting are not stored.

Memory, Recall (Normal)

4.5.17

Description

This instruction describes how to view the contents of the non-volatile memory locations and set the instrument output to the pattern stored in a selected location.

Operating Characteristics:

Available Locations: Normal 33
Optional 100

Location Address: Two digit number

Display of Stored Pattern: The pattern stored in a selected location can be displayed on the instrument's front panel without change to the output.

Procedure

Press **RECALL** (LED on)

Enter two digit address of the required location using the numeric keyboard (EXEC key LED flashes).

Change address, if required, using keyboard, spinwheel or step keys.

To set the output to a displayed pattern, press **EXEC** (LED off).

The instrument leaves the recall mode when this is done.

To leave the recall mode without change of output, press any primary function key.

Example

| | | | | |
|---|---------------|------------|-----------------------|------------|
| Examine contents of memory locations 02, 07, 08 and 09. Set the pattern stored in location 09 | | | | |
| LOCAL (keystrokes) | Function | Location | Function | Location |
| | RECALL | 0 2 | RECALL | 0 7 |
| | Location | Location | Set Displayed Pattern | |
| | ↑ | ↑ | EXEC | |

| | | | | | |
|-------------------------|-----------|-----------|-----------|-----------|---------------------|
| GPIB (program codes) | <u>MR</u> | <u>02</u> | <u>MR</u> | <u>07</u> | |
| | Function | Location | Function | Location | |
| | <u>MR</u> | <u>08</u> | <u>MR</u> | <u>09</u> | <u>ME</u> |
| | Function | Location | Function | Location | Set Display Pattern |

Keys and Program Codes



| Keys | Codes | Associated Error Codes | Code | Reason |
|--------|-------|------------------------|------|--|
| RECALL | MR | | 40 | Sequence error |
| EXEC | ME | | 44 | Exponential entry of address not permitted |
| | | | 50 | Memory board not fitted |
| | | | 52 | Recalled location has a checksum error |
| | | | 53 | Recalled location not available |
| | | | 54 | Single digit entered as address |

Indications

The RECALL key indicator lights when the key is pressed. This shows that data entries from the keyboard or increment controls will be directed to the recall system.

The digits of a location address selected using the keyboard will enter the memory display as they are entered.

The indicator of the EXEC key will flash when the second digit is entered, and the display will show the contents of the selected memory location.

The display reverts to showing the actual instrument output, with the memory display blank, when RECALL is selected before entering a new address.

The RECALL key indicator is extinguished and the memory display is blanked when the instrument leaves the recall mode.

Comments

The Memory Recall (Immediate) mode will provide faster operation if it is not necessary to view the contents of a memory location before setting the instrument output.

Related Instructions

Memory Recall, Immediate

Memory, Recall (Immediate)

4.5.18

Description

This instruction describes how to set the instrument output to a setting pattern held in the instrument's non-volatile memory.

Operating Characteristics:

Available Locations: Normal 33
Optional 100

Location Address: Two digit number

Procedure



Press **RECALL** (LED on)

Press **EXEC** (LED on)

Enter two digit address, or change an address already displayed, using the keyboard, spinwheel or step keys.

To leave the recall mode press any primary function key.

Example

| | | | | |
|--|---|--|----------|---|
| Set the instrument output to the patterns held in memory locations 02, 09, 08, 07 and 08 in succession | | | | |
| LOCAL (keystrokes) | Function | Location | Location | Location |
| | RECALL EXEC | 0 2 | 0 9 |  |
| | Location | Location | | |
| |  |  | | |
| GPIB (program codes) | MR | ME | 02 | 09 |
| | | | | |
| | Function | Location | Location | Location |
| | 07 | 08 | | |
| | | | | |
| | Location | Location | | |

Keys and Program Codes



| Keys | Codes |
|--------|-------|
| RECALL | MR |
| EXEC | ME |

Associated Error Codes

| Code | Reason |
|------|--|
| 40 | Sequence error |
| 44 | Exponential entry of address not permitted |
| 50 | Memory board not fitted |
| 52 | Recalled location has a checksum error |
| 53 | Recalled location not available |
| 54 | Single digit entered as address |
| 55 | Attempted use of MEM EXCH key |

Indications

The RECALL key indicator lights when the key is pressed. This shows that data entries from the keyboard or increment controls will be directed to the recall system.

The EXEC key indicator lights when the key is pressed. It remains lit until the instrument leaves the recall mode.

The digits of a location address selected using the keyboard will enter the memory display as they are entered.

The leading digit of the memory display is blanked when the first digit of a subsequent address is entered using the keyboard.

The RECALL and EXEC key indicators are extinguished and the memory display is blanked when the instrument leaves the recall mode.

Comments

To view the contents of a memory location before setting the instrument output use the Memory Recall (Normal) mode.

Related Instructions

Memory, Recall, Normal

Memory, Exchange

4.5.19

Description

This instruction describes how to exchange the contents of two locations in the instrument's non-volatile memory.

Procedure

Press **RECALL** (LED on)

Enter two digits of first location address (EXEC key LED flashes)

Press **MEM EXCH**

Enter two digits of second location address

Press **EXEC** (LED off)

Example

| | | | | | |
|---|---------------------------|-----------------------|-----------------------------|-----------------------|------------------------|
| Exchange the contents of memory locations 07 and 22 | | | | | |
| LOCAL (keystrokes) | Function RECALL | Location 0 7 | Function MEM EXCH | Location 2 2 | Execute EXEC |
| GPIB (program codes) | <u>MR</u> Function | <u>07</u> Location | <u>MI</u> Function | <u>22</u> Location | <u>ME</u> Execute |

Keys and Program Codes



| Keys | Codes |
|----------|-------|
| RECALL | MR |
| MEM EXCH | MI |
| EXEC | ME |

Associated Error Codes

| Code | Reason |
|------|--|
| 40 | Sequence error |
| 41 | Invalid use of spin-wheel or step keys |
| 44 | Exponential entry of address not permitted |
| 50 | Memory board not fitted |
| 52 | Recalled location has checksum error |
| 53 | Recalled location not available |
| 54 | Single digit entered as address |
| 56 | Store attempted when WRITE PROTECT is set |

Indications

The RECALL key indicator lights when the key is pressed. This shows that data entries made from the keyboard will be directed to the recall system.

The digits of the first location address appear in the memory display as they are entered.

The EXEC key indicator will flash when the second digit is entered, and the display will show the contents of the selected memory location.

The display reverts to showing the actual output of the instrument, with the memory display blanked, when the MEM EXCH key is pressed.

The digits of the second location address appear in the memory display as they are entered.

The display will show the contents of the selected memory location when the second digit is entered.

The RECALL and EXEC key indicators are extinguished, and the display reverts to showing the actual output of the instrument, with the memory display blanked, when the EXEC key is pressed.

Comments

No change to the actual output of the instrument occurs at any time during the memory exchange procedure.

Since the memory exchange procedure involves writing to the memory it cannot be performed when WRITE PROTECT is set.

Related Instructions

Special Functions

Standby

4.5.20

Description This instruction provides information regarding the standby mode.

Operating Characteristics:

Circuits Active in Standby Mode: The internal frequency standard, the microprocessor system and the battery charging system remain active.

Automatic Entry to Standby Mode: The instrument is automatically switched to standby in the event of overheating.

Procedure To switch to standby press  (LED on)

To revert to normal mode press  (LED off)

Keys and Program Codes



| Keys | Codes | Associated Error Codes | Code | Reason |
|---------------|-------|------------------------|------|--|
| STANDBY (on) | GS1 | | 73 | GPIB command interpreted while in standby mode |
| STANDBY (off) | GS0 | | 99 | Over temperature error |

Indications

The STANDBY key indicator lights when the key is pressed to switch to standby.

The STANDBY key indicator flashes and SRQ (if enabled) is generated when the instrument is switched to standby following an over temperature condition.

The BATTERY LOW indicator will light if a full battery charging cycle is in progress.

Apart from the above, all front panel displays and indicators are blanked.

Special Functions

4.5.21

Description This instruction describes how to call and cancel the instrument's special functions.

Procedure

Press SPECIAL
FUNCT

Enter the required special function number.

Special functions marked * are selected automatically on switching on.

Special functions marked ** are cancelled by the operation of any primary function key or the entry of fresh data.

Special function 20 is cancelled by operating the spinwheel.

**Keys and
Program Codes**



| Keys | Codes |
|------------------|-------|
| SPECIAL FUNCT | DG |

**Associated
Error
Codes**

| Code | Reason |
|------|--|
| 40 | Sequence error |
| 44 | |
| 47 | Exponential entry of special function number not permitted |
| | Invalid special function number entered |

Indications

For special functions 20, 21, 22, 23, 40, 45, 82, 83, 84, 85, 86 and 87 the special function number appears in the amplitude display while the function is active.

For special functions 71 and 76 the special function number appears in the amplitude display while the check is being carried out. If an error is found, a code number indicating the location of the fault appears in the frequency display and an error code is generated.

Comments

The following special functions are available.

| Function Number | Function |
|-----------------|--|
| 01 | Disable front panel annunciator |
| 02 | Select clunker as annunciator |
| 03 | Select beeper as annunciator |
| 05* | External step switch lines debounced |
| 06 | External step switch lines not debounced |
| 07* | Display out-of-lock error if present |
| 08 | Inhibit out-of-lock error display |
| 20 | Display code of key held pressed (see Note 3) |
| 21** | Display options code (see Note 1) |
| 22** | Display software revision number |
| 23** | Display special functions selected (see Note 2) |
| 31** | Turn on all displays (LED check) |
| 40** | Display GPIB address. (The test pattern is displayed if set to listen only) |
| 41* | Displays updated at the end of each command received via the GPIB |
| 42 | Displays not updated when in remote control |
| 43 | Displays updated for each byte received via the GPIB |
| 44 | Generate SRQ immediately if bit 7 of the SRQ mask is set |
| 45** | Display the SRQ mask setting |
| 50 | Trigger RPPU warning device |
| 51 | Reset RPPU warning device |
| 70 | Initiate charge cycle for non-volatile memory battery. (The cycle is terminated automatically after approximately 14 hours, or when the instrument is switched off). |
| 71 | Check functioning of non-volatile memory |
| 72 | Set all memory locations to current instrument settings |
| 73 | Remove WRITE PROTECT |
| 74 | Set WRITE PROTECT |
| 76 | Check for corruption of non-volatile memory data |
| 80 | Take present output frequency as sweep start frequency |
| 81 | Take present output frequency as sweep stop frequency |
| 82** | Sweep dwell time approximately 2 ms |
| 83** | Sweep dwell time approximately 20 ms |
| 84** | Sweep dwell time approximately 200 ms |
| 85** | Sweep dwell time approximately 1 s |
| 86** | Display sweep start frequency |
| 87** | Display sweep stop frequency |

Note 1: When the options code is displayed the fitting of an option is indicated by the allocated frequency display digit being set to '1'. The digit allocation is:

| 1 | 2 | 3 | 4 | 5 | 6 | 7 | 8 | 9 | 10 |
|----------------|------|------------------------|-------------------------|-------------|------------------------------|-------------|------|-------------|----------------|
| Always | GPIB | 33 address store | 100 address store | Always 0 | Auxiliary Control Unit | Always 0 | RPPU | Always 0 | Always |

Note 2: When the special functions codes is displayed the enablement of a function is indicated by the allocated frequency display digit being set as shown.

| 1 | 2 | 3 | 4 | 5 | 6 | 7 | 8 | 9 | 10 |
|----------------|------|------|--------------|-------------|--------------|--------------|--------------|------|----------------|
| Always | 1=42 | 1=43 | 0=73 1=74 | Always 0 | 0=07 1=08 | 0=05 1=06 | 0=02 1=03 | 1=01 | Always |

Note 3: Special functions marked * are selected automatically on switching on.

Special functions marked ** are cancelled by the operation of any primary function key or the entry of fresh data.

Special function 20 is cancelled by operating the spinwheel.



To cancel those special functions marked ** via the GPIB send any primary function code with no data. Care must be taken over selecting the code to be used as additional, unwanted, changes to the instrument settings may occur.

Error Codes

4.5.22

Description

This instruction describes how to read and interpret the error codes.

Procedure

Generation of error is signalled by ERROR indicator flashing

Press

| |
|--------------------------|
| DISPLAY ERROR CODE |
|--------------------------|

 and hold to read error code

Read error code from memory display.

Those codes marked * cannot be cleared until the cause of error has been removed. Other codes are cancelled automatically after they have been read or if a new data entry is made.

Keys and Program Codes



| Keys | Codes |
|--------------------------|-------|
| DISPLAY ERROR CODE | WY |

Indications

The ERROR indicator flashes when an error code is generated.

The error code number appears in the memory display and the ERROR indicator is lit when the DISPLAY ERROR CODE key is held pressed.

The ERROR indicator is reset and the memory display returns to normal when the key is released, except in the case of those errors which can only be cleared by removal of the cause of error.

Comments

The interpretation of the error codes is as follows:

| Code | Error |
|------|---|
| 00 | No error |
| 01* | Microprocessor RAM error on initialisation |
| 02* | ROM error: frequency display shows faulty ROM number |
| 03* | Stuck key on initialisation: frequency display shows code of stuck key. |
| 09* | RPPU tripped. Reset by switching carrier on |
| 10 | Frequency entry excessive: output set to 1.3 GHz |
| 11 | Frequency entry too low: output set to 10 kHz |
| 12 | Relative frequency offset too high: offset to give output of 1.3 GHz |
| 13 | Relative frequency offset too negative: offset set to give output of 10 kHz |
| 14 | Frequency step size entry excessive: reset to 1299.990 MHz |
| 15 | Amplitude entry excessive: output set to 2.00 V (+19 dBm) |
| 16 | Amplitude entry too low: output set to 22.4 nV (-140 dBm) |
| 17 | Relative amplitude offset too high: offset set to give output of 2.00 V (+19 dBm) |
| 18 | Relative amplitude offset too negative: offset set to give output of 22.4 nV (-140 dBm) |
| 19 | Amplitude step size entry excessive: reset to 1.99 V or 159 dB |
| 20* | FM deviation excessive for output frequency |
| 21 | FM deviation entry excessive for frequency range: reset to maximum permissible value |
| 22 | Phase deviation entry excessive: reset to 5.00 radians |
| 23* | Phase modulation excessive for output frequency |
| 24 | AM depth entry excessive: reset to 99% |
| 25* | AM excessive for output amplitude |
| 30* | FM/ØM modulating signal level too low |
| 31* | FM/ØM modulating signal level too high |
| 32* | AM/Pulse modulating signal level too low |
| 33* | AM/Pulse modulating signal level too high |
| 40 | Key operation sequence error |
| 41 | Invalid use of spinwheel or step keys |
| 42 | Data input attempted when in Pulse mode |
| 43 | External DC input not permitted in phase mode |
| 44 | Exponential entry attempted for store, recall or special functions |
| 45 | No step size set for frequency sweep |
| 47 | Invalid special function code entered |
| 50 | Memory board not fitted |
| 51 | Error detected during memory test: frequency display shows faulty RAM number |

| Code | Error |
|------|---|
| 52 | Recalled memory location contains checksum error |
| 53 | Recalled memory location out of range |
| 54 | Incomplete memory address entered |
| 55 | MEM EXCH key operated in Store mode or Immediate Execute Recall mode |
| 56 | Write Protect set |
| 57 | Corruption of memory contents detected during test: frequency display shows corrupted location number |
| 70 | GPIB letter command unknown |
| 71 | GPIB numeric command out of range |
| 72 | GPIB learn mode input interrupted and aborted |
| 73 | GPIB command interpreted whilst in standby mode |
| 80* | Reference generator loop out of lock |
| 81* | Output loop out of lock |
| 82* | Comb loop out of lock |
| 83* | FM system PLL out of lock |
| 84* | FM system FLL out of lock |
| 88* | Output system AGC loop error |
| 90* | Power supply - 15 V supply failure |
| 91* | Power supply -5.2 V supply failure |
| 92* | Power supply +5 V (D) supply failure |
| 93* | Power supply +5 V (A) supply failure |
| 94* | Power supply +15 V supply failure |
| 95* | Power supply +24 V supply failure |
| 96* | Power supply +18 V supply failure |
| 97* | Power supply +24 V OVEN supply failure |
| 99* | Overtemperature error - instrument switched to standby. To reset press STANDBY key. |

Error code 73 will be cleared when the instrument leaves the standby mode. The instrument will be set according to the commands received whilst in standby.

Those codes marked * cannot be cleared until the cause of error has been removed. Other codes are cancelled automatically after they have been read or if a new data entry is made.



The error codes can be read via the GPIB using the instrument status data string.

Reverse Power Protection Unit

4.5.23

Description This instruction describes how to use the reverse power protection unit (RPPU) option.

Operating Characteristics

Protection Level: Up to 50 W, continuous, or to 50 V DC.

Frequency Range: DC to 2.6 GHz

Isolation: >40 dB from 10 kHz to 1.3 GHz
>30 dB from 1.3 GHz to 2.6 GHz

Trigger Level: <1 W

Output VSWR: 1.6:1 for output levels of 3 dBm and above
1.3:1 for output levels below 3 dBm

Action: When tripped the 9087 RF OUTPUT socket is latched in the open circuit state.
An audible warning is given.

Procedure Operate the 9087 normally.
If the RPPU trips, disconnect the source of reverse power.
Switch the RF output on to reset the protection unit.

Keys and Program Codes



| Keys | Codes |
|-----------|-------|
| RF OUTPUT | OP1 |

Associated Error Codes

| Code | Reason |
|------|--------------|
| 09 | RPPU tripped |

Indications When the RPPU is tripped an audible warning is given and the RF output ON/OFF key indicator is extinguished.

Comments The audible warning, but not the switching, of the RPPU can be tested using the special functions.

Related Instructions Special Functions

SECTION 5

OPERATION VIA THE GPIB

5.1 PREPARATION FOR USE WITH THE GPIB

5.1.1 INTRODUCTION

5.1.1.1 The instrument must be prepared for use in accordance with the instructions given in Section 3 before the additional instructions given in this section are carried out.

5.1.2 CONNECTION TO THE GPIB

5.1.2.1 Connection to the GPIB is made via a standard IEEE 488 bus connector, mounted on the rear panel. The pin assignment is given in Table 5.1. An adaptor, Racal-Dana part number 23-3254, to convert the connector to the IEC 625-1 standard is available as an optional accessory.

TABLE 5.1

GPIB Connector Pin Assignment

| Pin | Signal Line | Pin | Signal Line |
|-----|-------------|-----|-----------------|
| 1 | DIO 1 | 13 | DIO 5 |
| 2 | DIO 2 | 14 | DIO 6 |
| 3 | DIO 3 | 15 | DIO 7 |
| 4 | DIO 4 | 16 | DIO 8 |
| 5 | EOI | 17 | REN |
| 6 | DAV | 18 | Gnd. (6) |
| 7 | NRFD | 19 | Gnd. (7) |
| 8 | NDAC | 20 | Gnd. (8) |
| 9 | IFC | 21 | Gnd. (9) |
| 10 | SRQ | 22 | Gnd. (10) |
| 11 | ATN | 23 | Gnd. (11) |
| 12 | SHIELD | 24 | Gnd. (5 and 17) |

5.1.3 ADDRESS SETTING

5.1.3.1 The interface address is set on five of six rear panel mounted switches. The sixth switch must be set to the logic '0' position (to the left as viewed from the rear of the instrument). The top switch is used to set the least significant address bit. The permitted address settings, in decimal and ASCII character form, are given in Table 5.2.

TABLE 5.2

Address Switch Settings

| SWITCH SETTINGS | | | | | ADDRESS CODES | | |
|-----------------|----|----|----|----|---------------|----------------------|--------------------|
| | | | | | DECIMAL | ASCII LISTEN ADDRESS | ASCII TALK ADDRESS |
| A5 | A4 | A3 | A2 | A1 | | | |
| 0 | 0 | 0 | 0 | 0 | 0 | SP | @ |
| 0 | 0 | 0 | 0 | 1 | 1 | ! | A |
| 0 | 0 | 0 | 1 | 0 | 2 | " | B |
| 0 | 0 | 0 | 1 | 1 | 3 | # | C |
| 0 | 0 | 1 | 0 | 0 | 4 | \$ | D |
| 0 | 0 | 1 | 0 | 1 | 5 | % | E |
| 0 | 0 | 1 | 1 | 0 | 6 | & | F |
| 0 | 0 | 1 | 1 | 1 | 7 | ' | G |
| 0 | 1 | 0 | 0 | 0 | 8 | (| H |
| 0 | 1 | 0 | 0 | 1 | 9 |) | I |
| 0 | 1 | 0 | 1 | 0 | 10 | * | J |
| 0 | 1 | 0 | 1 | 1 | 11 | + | K |
| 0 | 1 | 1 | 0 | 0 | 12 | , | L |
| 0 | 1 | 1 | 0 | 1 | 13 | - | M |
| 0 | 1 | 1 | 1 | 0 | 14 | . | N |
| 0 | 1 | 1 | 1 | 1 | 15 | / | O |
| 1 | 0 | 0 | 0 | 0 | 16 | 0 | P |
| 1 | 0 | 0 | 0 | 1 | 17 | 1 | Q |
| 1 | 0 | 0 | 1 | 0 | 18 | 2 | R |
| 1 | 0 | 0 | 1 | 1 | 19 | 3 | S |
| 1 | 0 | 1 | 0 | 0 | 20 | 4 | T |
| 1 | 0 | 1 | 0 | 1 | 21 | 5 | U |
| 1 | 0 | 1 | 1 | 0 | 22 | 6 | V |
| 1 | 0 | 1 | 1 | 1 | 23 | 7 | W |
| 1 | 1 | 0 | 0 | 0 | 24 | 8 | X |
| 1 | 1 | 0 | 0 | 1 | 25 | 9 | Y |
| 1 | 1 | 0 | 1 | 0 | 26 | : | Z |
| 1 | 1 | 0 | 1 | 1 | 27 | :: | [|
| 1 | 1 | 1 | 0 | 0 | 28 | < | \ |
| 1 | 1 | 1 | 0 | 1 | 29 | = |] |
| 1 | 1 | 1 | 1 | 0 | 30 | > | ^ |

Instrument
despatched
with this
setting

5.1.3.2 The instrument is despatched with the address switches set to decimal 19 (ASCII 3 (listen) and ASCII S (talk)). The address set, in both binary and decimal format can be displayed by pressing

SPECIAL FUNCT 4 0

when in local control or by sending the command DG40 via the GPIB. If the 9087 is in local control the address display will be updated as the switches are changed.

5.1.3.3 When the sixth, bottom, switch is put to the logic '1' position the interface is switched to the listen only mode. The settings of the upper five switches are then irrelevant. In this mode the instrument will accept all commands sent via the bus, and cannot be addressed to talk. If an attempt is made to display the address when in the listen only mode the frequency display will show:



5.2 DATA ACCEPTANCE MODES

5.2.1 When the 9087 is under remote control, two modes of accepting device dependent commands generated at the controller are available. These are:

- (a) The immediate mode
- (b) The deferred mode

The mode to be used is selected by the operator, the deferred mode being selected automatically on switching on.

5.2.2 When the instrument is operating in the immediate mode each byte of an addressed command is processed as it is received, the following byte being accepted only when processing is complete. The bus is thus occupied for the data transfer and the data processing time. This method gives the fastest change in 9087 control setting when a slow controller is used. No end of string indication is required.

5.2.3 When operating in the deferred mode strings of addressed commands are accepted and stored without change to the 9087 control settings. The bus is released and processing of the data is commenced when the end of string indication is received. The bus is therefore occupied for the time taken to transfer the data only, and better bus utilisation is possible. The end of string indication may be CR, LF, ASCII X, ASCII x or the EOI line set low for the duration of the last byte. If a combination of these indicators is received all but the first will be ignored.

5.2.4 The input buffer used has a capacity of 256 bytes. If the command string is longer than this, data transfer will be stopped when the store is full. The bus will be held while the first 256 bytes are processed, after which data transfer will continue.

5.3 DISPLAY UPDATING

5.3.1 When the immediate mode of data acceptance is in use, each byte received is acted upon before the next byte is accepted. Since the time taken to update the display forms a significant part of the time required to process a byte, the system operating speed can be improved by reducing the frequency at which display updating occurs. The following three modes are available:

- (a) Displays updated at the end of each data string recognised as a command. This mode is automatically selected on switching on, or by using special function 41.
- (b) Displays blanked. This permits the maximum operating speed. The complete display is blanked except for the amplitude display, which shows 42, and the GPIB indicators. The mode is selected using special function 42.
- (c) Displays updated following the acceptance of each data byte. This corresponds to the form of updating used when the instrument is operating under local control. Although the operating speed is low, this mode can prove useful when checking the operation of the 9087 and the bus. The mode is selected using special function 43.

5.4 DATA OUTPUT

5.4.1 The instrument generates three different forms of data string related to its operating status and control settings. These are:

- (a) The instrument status data string
- (b) The fast learn mode data string
- (c) The long learn mode data string

5.4.2 The required form of output is obtained by setting the interface output mode by means of the appropriate code, sent as an addressed command, and then addressing the instrument to talk. The output mode will remain set until an alternative mode is set or the instrument is switched off. The mode giving the instrument status data string is selected on switching on.

5.5 THE INSTRUMENT STATUS DATA STRING

5.5.1 The data output mode giving the instrument status data string is set using the addressed command IS. The string contains 27 bytes, consisting of:

- (a) Six two-digit, decimal, error code numbers, each followed by a comma
- (b) A three-digit, octal number, representing the setting of the status byte mask register, followed by a comma.
- (c) A three-digit, octal, special function number.
- (d) CR and LF

The EOI line is set low for the duration of the transmission of LF. The first error code number in the string is the one appearing in the display.

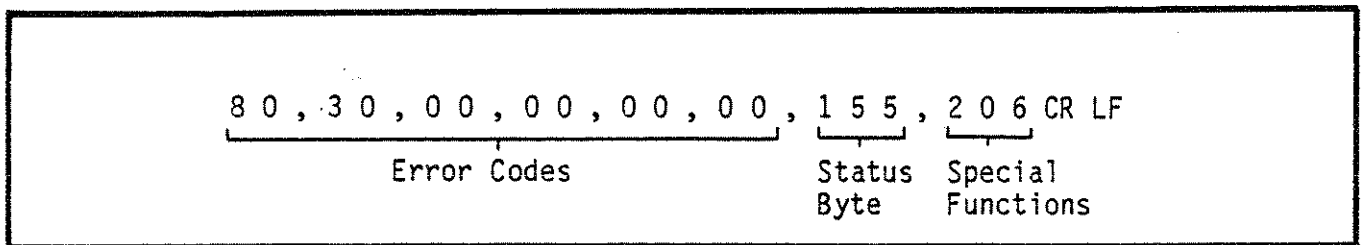

Fig. 5.1 Typical Status Data String

5.5.2 The error code numbers should be interpreted according to Table 4.9 in Section 4. The interpretation of the status byte mask setting is given in paragraph 5.8. The special function number should be interpreted in accordance with Table 5.3, Table 5.4 and Table 4.8 of Section 4.

TABLE 5.3

Special Function Number Bit Allocation

| First Digit | | Second Digit | | | Third Digit | | |
|-------------|----|--------------|---|-----|-------------|----|----|
| DN | DE | STLK | 0 | IOL | DB | BC | FB |

TABLE 5.4

Special Function Number Bit Code

| Bit Settings | Function | Number of Special Function Enabled |
|--------------|--|------------------------------------|
| DN DE | | |
| 0 0 | Display options with remote control via GPIB | 41 |
| 0 1 | | 43 |
| 1 0 | | 42 |
| STLK | | |
| 0 | Write Protect | OFF |
| 1 | | ON |
| IOL | | |
| 0 | Out of lock error display | ON |
| 1 | | OFF |
| DB | | |
| 0 | Auxiliary input debounce | ON |
| 1 | | OFF |
| BC FB | | |
| X 1 | Front panel annunciator selection | OFF |
| 0 0 | | CLUNK |
| 1 0 | | BEEP |

5.6 THE LEARN MODE

5.6.1 INTRODUCTION

5.6.1.1 The learn mode provides a means of resetting the controls of the 9087 rapidly, using pre-determined data strings. The data strings are produced in the 9087, the content of a string being governed by the control settings in use at the time the string is generated. The strings are fed via the bus to an external store, which must be provided as part of the bus system. The store must be capable of handling 8 bit binary data. When a data string is fed back to the 9087 as an addressed command the control settings will be returned to those in use when the data string was generated.

5.6.1.2 Two lengths of data string are possible. The shorter string, of 13 bytes, controls the frequency setting only. The longer string, of 61 bytes, controls the complete range of instrument settings. Each string includes a header, which indicates the length of the string, @9 being used for the shorter string and @A for the longer. The form of string generated can be selected by the operator by using the appropriate interface output mode code.

5.6.1.3 When a data string is transmitted from the 9087 to store, the EOI line is set low for the duration of the final byte. No CR or LF is transmitted. If no action is taken to stop the acceptance of data the data string will be repeated continuously.

5.6.1.4 When a learn mode data string is transmitted back to the 9087 the header is recognised, and the instrument enters the learn mode automatically. For the fast learn mode the frequency display shows ten decimal points. The header indicates the number of bytes in the string. No end of string indicator should be added. It is essential that no interruption of the string occurs during transfer.

5.6.1.5 Once a learn mode data string has been received the 9087 will remain in the learn mode until an addressed command not commencing with the ASCII character @ is received. It will then revert to the immediate or deferred mode, according to which was last selected.

5.6.2. OBTAINING A DATA STRING OUTPUT

5.6.2.1 When operating in the remote control mode a data string output is obtained as follows:

- (a) Address the 9087 to listen.
- (b) Send the addressed command LM1 or LM2, according to the length of data string required.
- (c) Address the store which is to accept the data string to listen.
- (d) Address the 9087 to talk.
- (e) Stop the data transfer when the string has been stored by sending the UNTALK command.

5.6.2.2 The 9087 will only transmit a learn mode data string under the control of the bus controller. However it is frequently more convenient to set up the content of the data string using the front panel in the local control mode. The following procedure will permit the process to be controlled from the 9087:

- (a) Set the 9087 status byte mask, as instructed in paragraph 5.8.3, such that bit 7 (SRQ) and bit 8 (operator requests response) of the status byte are enabled.
- (b) Program the controller such that, after detecting SRQ, conducting a serial poll and receiving a status byte with bits 7 and 8 at '1' from the 9087 it will:
 - (i) address the 9087 to listen
 - (ii) send the addressed command LM1 or LM2, according to which length of data string is required. Address the store which is to receive the data string to listen
 - (iii) address the 9087 to talk
 - (iv) send ATN false

- (v) stop the data transfer when the string has been stored by sending the UNTALK command.
- (vi) return the 9087 to local control, ready for a further data string to be set up, if required.
- (c) Set up the 9087 controls to the required pattern.
- (d) Press SPECIAL FUNCT 4 4

This will cause the 9087 to send the SRQ message, resulting in a serial poll followed by the transfer of a data string to store.

5.7 MONITORING THE CONTROL SETTINGS

5.7.1 It is possible to read, and if necessary record, the 9087 function and output settings by making use of the learn mode data strings. In practice, because of the complex nature of the short data string, it will be found to be more convenient to use the long string even when information relating to frequency setting only is required.

The data string is obtained from the 9087 as previously described. The bytes should be interpreted as shown in Table 5.5

TABLE 5.5
Long Learn Mode Data String Interpretation

| Byte Number | | Data Format |
|-------------|--------------------------|-----------------------|
| 1 and 2 | Header | Byte 1 = @ Byte 2 = A |
| 3 | Modulation control | See Table 5.7 |
| 4 | AM control | See Table 5.8 |
| 5 | FM control | See Table 5.9 |
| 6 | ØM control | See Table 5.10 |
| 7 | Pulse modulation control | See Table 5.11 |
| 8 | AM depth | 2 digits |
| 9 to 11 | FM deviation | 6 digits |
| 12 and 13 | ØM deviation | 3 digits |
| 14 | Incremental controls | See Table 5.12 |
| 15 | REL and sign data | See Table 5.13 |
| 16 to 20 | Reference frequency | 10 digits |
| 21 to 25 | Relative frequency | 10 digits |
| 26 to 30 | Output frequency | 10 digits |
| 31 to 35 | Frequency step size | 10 digits |
| 36 and 37 | Amplitude step size | 4 digits |
| 38 and 39 | Reference amplitude (dB) | 4 digits |
| 40 and 41 | Relative amplitude (dB) | 4 digits |
| 42 and 43 | Output amplitude (dB) | 4 digits |
| 44 to 49 | Reference amplitude (V) | 12 digits |
| 50 to 55 | Relative amplitude (V) | 12 digits |
| 56 to 61 | Output amplitude (V) | 12 digits |

- Note: (1) Numerical data are in packed BCD, two digits per byte. The format is as shown in Table 5.6.
- (2) Full numerical data are given for FM deviation, reference amplitude (volts), and output amplitude (volts). The data are rounded to three significant figures to provide the control signals for the 9087 output and displays.
- (3) In Tables 5.7 to 5.13 a bit set to logic '1' indicates a selected condition.

TABLE 5.6
Numerical Data Format

| | | | | | | | | |
|-------|------------------------|---|-------------------|-----|--------------|---|---|-------------------------|
| Byte | DI08 | 7 | 6 | 5 | 4 | 3 | 2 | 1 |
| | MSB | | | LSB | MSB | | | LSB |
| First | Most significant digit | | | | Second digit | | | |
| ↓ | | | ↓ | | | ↓ | | |
| Last | | | Penultimate digit | | | | | Least significant digit |

TABLE 5.7
Modulation Data

| Bit Number | | | | | | | |
|------------|---|-------------------|---|----|---------------------|----|----|
| 8 | 7 | 6 | 5 | 4 | 3 | 2 | 1 |
| - | - | CAL? indicator | - | ØM | Pulse modulation | FM | AM |

TABLE 5.8

AM Control Data

| Bit Number | | | | | | | |
|------------|---|--------------------|----------|-----------------|----------------|--------------|--------------|
| 8 | 7 | 6 | 5 | 4 | 3 | 2 | 1 |
| - | - | Pulse - mod set | AM ON | AM INT 400Hz | AM INT 1kHz | AM EXT AC | AM EXT AC |

TABLE 5.9

FM Control Data

| Bit Number | | | | | | | |
|------------|---|-----------|----------|-----------------|----------------|--------------|--------------|
| 8 | 7 | 6 | 5 | 4 | 3 | 2 | 1 |
| - | - | ØM set | FM ON | FM INT 400Hz | FM INT 1kHz | FM EXT AC | FM EXT DC |

TABLE 5.10

ØM Control Data

| Bit Number | | | | | | | |
|------------|---|---|----------|-----------------|----------------|--------------|---|
| 8 | 7 | 6 | 5 | 4 | 3 | 2 | 1 |
| - | - | - | ØM ON | ØM INT 400Hz | ØM INT 1kHz | ØM EXT AC | - |

TABLE 5.11

Pulse Modulation Control Data

| Bit Number | | | | | | | |
|------------|---|---|-------------|--------------------|-------------------|-----------------|-----------------|
| 8 | 7 | 6 | 5 | 4 | 3 | 2 | 1 |
| - | - | - | Pulse ON | Pulse INT 400Hz | Pulse INT 1kHz | Pulse EXT AC | Pulse EXT DC |

TABLE 5.12

Incremental Control Data

| Bit Number | | | | | | | |
|------------|---|--------------|--------|--------|------|------|------|
| 8 | 7 | 6 | 5 | 4 | 3 | 2 | 1 |
| - | - | Output ON | Coarse | Medium | Fine | Hold | Step |

TABLE 5.13

REL and Sign Data

| Bit Number | | | | | | | |
|------------------------------------|-----------------------------------|---|--|--|--|--|-------------------------------------|
| 8 | 7 | 6 | 5 | 4 | 3 | 2 | 1 |
| Freq. system in rel. mode | Amp. system in rel. mode | Freq. rel. sign 0=+ve 1=-ve | Amp. rel. sign 0=+ve 1=-ve | Amp. ref. sign 0=+ve 1=-ve | Amp. output sign 0=+ve 1=-ve | Amp. display mode 0=dB 1=V | Amp. step mode 0=dB 1=V |

5.8 SRQ AND STATUS BYTE OUTPUTS

5.8.1 STATUS BYTE FORMAT

5.8.1.1 The status byte is transmitted via the GPIB by the 9087 in response to a serial poll. The byte should be interpreted as shown in Table 5.14.

TABLE 5.14
Status Byte

| Bit Number | | | | | | | |
|----------------------------|-----|--------------|--------------|-------------|------------------|---|------------------------------|
| 8 | 7 | 6 | 5 | 4 | 3 | 2 | 1 |
| Operator requests response | RQS | Syntax error | End of sweep | Entry error | Hardware failure | 0 | External inputs out of range |

5.8.2 STATUS BYTE MASK REGISTER

5.8.2.1 The circumstances under which the 9087 will send the SRQ message and the content of the status byte are both governed by the contents of the status byte mask register. The mask register contains eight bits, corresponding to the eight bits of the status byte. If a mask register bit is at logic '1' the corresponding bit of the status byte is enabled and will reflect the instrument's status. When a mask register bit is at logic '0' the generation of the corresponding bit of the status byte is inhibited.

5.8.2.2 In the case of bit 7, a logic '1' in the mask register will result in the RQS indication being included in the status byte. The SRQ message will then be sent true if any bit in the status byte is set. A logic '0' in this position in the mask register will prevent the RQS indication appearing, and will also disable the generation of the SRQ message.

5.8.3 SETTING THE MASK REGISTER

5.8.3.1 Entries are made into the mask register by means of an addressed command consisting of the alpha characters RS followed by three octal digits. The first digit is limited to 0 to 3, and relates to bits 8 and 7. The second and third digits may be from 0 to 7, the second digit relating to bits 6, 5 and 4 and the third digit to bits 3, 2 and 1. An entry of RS 277, for example, will inhibit the RQS indication and the generation of the SRQ message, but will enable all the other status byte bits. On switching on the mask is set to 155.

5.8.4 READING THE MASK REGISTER

5.8.4.1 The setting of the mask register is included in the instrument status data string, and may be read via the GPIB as instructed in paragraph 5.5.

5.9 REMOTE/LOCAL CHANGEOVER

5.9.1 LOCAL TO REMOTE CONTROL CHANGEOVER

5.9.1.1 The 9087 is switched from local to remote control by the following sequence of control and data line messages:

- (a) Remote enable (REN) true (low).

This primes the remote control enable, but the 9087 remains in local control. REN must remain true if any instrument on the bus is to remain in remote control.

- (b) Attention (ATN) true (low).

- (c) Listen address.

The 9087 enters the listener addressed state (LADS) on recognition of its listen address.

- (d) ATN false (high).

The 9087 enters the listener active state (LACS) after a delay, and enters the remote state (REMS) on receipt of the first data byte.

5.9.1.2 No change to any of the 9087 control settings occurs on changeover from local to remote control.

5.9.2 REMOTE TO LOCAL CONTROL CHANGEOVER

5.9.2.1 The 9087 will be switched from remote to local control on:

- (a) Operation of the front panel LOCAL key. This is effective only if local lockout is not set.

- (b) Receiving the go to local (GTL) command when in the LADS.

- (c) Receiving the REN message false (high). This is independent of the addressed state of the 9087.

5.9.2.2 No change to any of the 9087 control settings occurs on changeover from remote to local control.

5.9.3 LOCAL LOCKOUT (LLO)

5.9.3.1 Operation of the front panel LOCAL key during the transfer of data to the 9087 could result in the instrument being switched from remote to local control with the control settings in an unknown state. To prevent this the LOCAL key can be disabled by setting local lockout.

5.9.3.2 Local lockout may be set at any time when the REN message is true (low). The recognition of the LLO message is not dependent on the addressed state of the instrument. Apart from the disablement of the LOCAL key it causes no changes to the operation of the 9087. The only method of cancelling LLO is to send the REN message false (high). This affects all instruments on the bus, putting them to the local control state (LOCS).

5.10 LOGIC LEVELS

5.10.1 The control, handshake and data lines operate at standard +5 V TTL levels. Negative logic is used, i.e. logic '1' is represented by a level ≤ 0.8 V and logic '0' by a level of ≥ 2 V.

5.11 GPIB COMMAND EXECUTION TIME

5.11.1 The following paragraphs provide information regarding the time required for the 9087 to receive and respond to a command sent via the GPIB, and the time for which the bus is busy during the operation. The total delay in executing a command is determined by the time taken to accept the command, and the processing and settling times needed by the 9087 to reach the required output state. These factors depend upon:-

- (a) the data acceptance mode, and
- (b) the display updating mode in use.

5.11.2 IMMEDIATE AND DEFERRED DATA ACCEPTANCE MODES

5.11.2.1 The acceptance times per character for the immediate and deferred modes are shown in Table 5.15.

TABLE 5.15
Character Acceptance Times

| Character | Immediate Mode | Deferred Mode. |
|-----------|----------------|----------------|
| Letters | 0.46 ms | 0.38 ms |
| Numbers | 0.74 ms | 0.38 ms |
| Symbols | 0.61 ms | 0.38 ms |

5.11.2.2 The processing time depends upon the nature of the command, and not necessarily on the number of characters received. The processing times required for certain typical commands are given in Table 5.16, and these times, combined with the required data acceptance times, are given in Table 5.17.

TABLE 5.16

Processing Times

| Command | Normal Display Update | | No Display Update | |
|-----------------|-----------------------|----------|-------------------|----------|
| | Immediate | Deferred | Immediate | Deferred |
| MRØØME | 13.32 ms | 9.22 ms | 5.42 ms | 5.62 ms |
| FQ1.234567890GZ | 6.37 ms | 9.08 ms | 1.89 ms | 6.82 ms |
| AP-123DB | 7.11 ms | 6.98 ms | 2.69 ms | 4.78 ms |
| AM98%MA1MA4 | 11.81 ms | 8.78 ms | 3.93 ms | 6.76 ms |
| FM68KZMF1MF4 | 11.02 ms | 7.10 ms | 2.02 ms | 4.84 ms |

TABLE 5.17

Processing Plus Data Acceptance Times

| Command | Normal Display Update | | No Display Update | |
|-----------------|-----------------------|----------|-------------------|----------|
| | Immediate | Deferred | Immediate | Deferred |
| MRØØME | 16.64 ms | 11.50 ms | 8.74 ms | 9.24 ms |
| FQ1.23456789ØGZ | 16.22 ms | 14.78 ms | 11.74 ms | 12.52 ms |
| AP-123DB | 11.78 ms | 10.02 ms | 7.36 ms | 7.82 ms |
| AM98%MA1MA4 | 18.14 ms | 12.96 ms | 10.26 ms | 10.94 ms |
| FM68KZMF1MF4 | 17.66 ms | 11.66 ms | 8.66 ms | 9.40 ms |

5.11.2.3 The processing time includes the time devoted to updating the display. This occurs once only per command string in the deferred mode, following the recognition of a valid command string terminator, but may occur more than once in each command string when operating in the immediate mode. For this reason, when normal display updating is used, the processing time is less in the deferred mode. The saving in time will be greater than that indicated in Table 5.17 when command strings containing more than one command are used.

5.11.2.4 If display updating is inhibited by the enablement of special function 42, the processing time for the immediate mode is less than that for the deferred mode. This is because there is no saving in the time taken to update the display, but time is used in the deferred mode to store the characters as they are received, and to recall them for processing once the command string terminator is recognised.

5.11.2.5 Settling time must be allowed in addition to the data acceptance and processing times. The time required for this depends upon the nature and magnitude of the change made.

5.11.2.6 The times for which the bus is busy during the receipt and execution of typical commands are shown in Table 5.18. It can be seen that the use of the deferred mode permits better bus utilisation.

TABLE 5.18

Bus Busy Times

| Command | Normal Display Update | | No Display Update | |
|-----------------|-----------------------|----------|-------------------|----------|
| | Immediate | Deferred | Immediate | Deferred |
| MR00ME | 9.16 ms | 2.28 ms | 3.52 ms | 2.28 ms |
| FQ1.234567890GZ | 12.24 ms | 5.70 ms | 9.96 ms | 5.70 ms |
| AP-123DB | 7.12 ms | 3.04 ms | 4.92 ms | 3.04 ms |
| AM98%MA1MA4 | 14.94 ms | 4.18 ms | 9.04 ms | 4.18 ms |
| FM68KZMF1MF4 | 15.14 ms | 4.56 ms | 8.36 ms | 4.56 ms |

5.11.3 THE FAST LEARN MODE

5.11.3.1 In the fast learn mode the data input to the 9087 always consists of a string of 13 bytes. The total execution time required is the sum of

- (a) 390 μ s data acceptance time
- (b) 80 μ s for data transfer within the 9087
- (c) 400 μ s settling time.

5.11.3.2 Since the processing time is 680 μ s, the receipt of a second string may commence before settling is complete. Operation at the maximum rate is illustrated in Fig. 5.2.

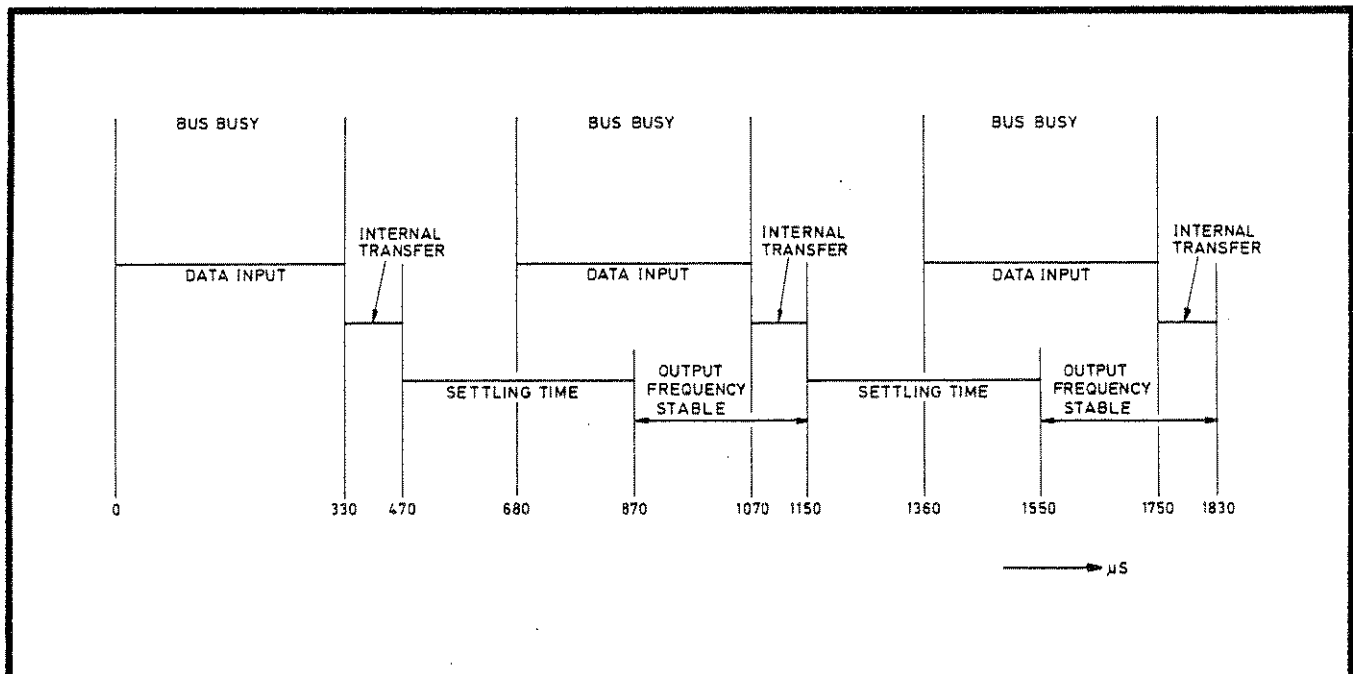

Fig. 5.2 Fast Learn Mode Timing

5.11.4 THE LONG LEARN MODE

5.11.4.1 In the long learn mode the data input to the 9087 always consists of a string of 61 bytes. The total execution time required is the sum of

- (a) 1.97 ms data acceptance time
- (b) 7.83 ms for data processing within the 9087
- (c) Settling time dependent upon the nature and magnitude of the output changes made.

5.11.4.2 The total processing time, which must be allowed to elapse before the receipt of a second data string commences, is 12.23 ms with normal display updating or 10.00 ms if display updating is inhibited.

5.12 OPERATING INSTRUCTIONS FOR REMOTE CONTROL

5.12.1 OPERATING MODES

5.12.1.1 The 9087 can be operated via the GPIB in either the addressed mode or the listen only mode. In the addressed mode the instrument's functions and RF output can be controlled by means of device dependent commands, sent via the bus, when the instrument is addressed to listen, and data regarding the instrument's status or output can be read when the instrument is addressed to talk. In the listen only mode the instrument will accept all commands sent via the bus, and cannot be addressed to talk.

5.12.2 COMMAND CODES FOR REMOTE CONTROL

5.12.2.1 When the 9087 is addressed to listen, or is in the listen only mode it can be controlled by means of the device dependent commands listed in Tables 5.19 to 5.27. In commands containing numerical data the use of the decimal point is optional. If required, spaces, commas and semicolons may be included in commands or command strings as an aid to clarity without affecting the operation of the 9087.

5.12.2.2 It is essential that the operation of the instrument using the front panel controls, as described in Section 4, is understood before operation using the GPIB is attempted.

TABLE 5.19

Frequency Commands

| Function | Function Code | Data | Units or Exponent |
|-------------------------------|---------------|------------------------|----------------------------------|
| Set frequency | FQ | Up to 10 digits and DP | GZ, MZ, KZ, HZ or E± 2 digits |
| Set frequency step | FS | | |
| Set relative frequency offset | FR | | |
| Frequency step up | FU | | |
| Frequency step down | FD | | |

Note: For the exponent format the unit of entry is Hz.

TABLE 5.20

Amplitude Commands

| Function | Function Code | Data | Units or Exponent |
|-------------------------------|---------------|-----------------------|---------------------------------------|
| Set amplitude | AP | Up to 4 digits and DP | VO, MV, UV, NV, ±dB or E± 2 digits |
| Set amplitude step | AS | | |
| Set relative amplitude offset | AR | | |
| Amplitude step up | AU | | |
| Amplitude step down | AD | | |

Note: For the exponent format the unit of entry is volts.

TABLE 5.21

Modulation Commands

| Function | Function Code | Data | Units or Exponent |
|--------------------------|---------------|-----------------------|---------------------------|
| Set AM depth | AM | Up to 2 digits | %, PC, E± 2 digits |
| Set FM deviation | FM | Up to 3 digits and DP | MZ, KZ, HZ or E± 2 digits |
| Set ØM deviation | HM | Up to 3 digits and DP | RD or E± 2 digits |
| Select pulse modulation | PM | | |
| AM control | MA | 1 digit from Ø to 5 | |
| FM control | MF | 1 digit from Ø to 5 | |
| ØM control | MH | 1 digit from Ø to 4 | |
| Pulse modulation control | MP | 1 digit from Ø to 5 | |

Note: (1) For the exponent format the units of entry are:

- (a) % for AM
- (b) Hz for FM
- (c) radians for ØM

(2) The coding for the control data is:

- Ø = Modulation off
- 1 = Modulation on
- 2 = Select internal 400 Hz source
- 3 = Select internal 1 kHz source
- 4 = Select external source, AC coupled
- 5 = Select external source, DC coupled

TABLE 5.22
Memory Commands

| Function | Function Code | Memory Address | Execute |
|--|---------------|----------------------|---------|
| Store front panel settings | MS | 2 digits | ME |
| Recall front panel settings | MR | 2 digits | |
| Set instrument to recalled settings | | | ME |
| Memory exchange | MR | 2 digits MI 2 digits | ME |
| Recall, display and set a stored pattern | MR ME | 2 digits | |

Note: The memory exchange sequence does not affect the RF output of the 9087. The display will show the first memory location contents when the first address is entered and the second location contents when the second address is entered. The exchange is implemented by the 9087 ME command, and the display then reverts to the current instrument settings.

TABLE 5.23
Data Acceptance Mode Codes

| Mode | Code |
|-----------|------|
| Deferred | RM1 |
| Immediate | RM2 |

Note: When the deferred mode is in use an end of string indication is required. This may be CR, LF, ASCII X, ASCII x or the EOI line set low (true) for the duration of the final byte.

TABLE 5.24

Data Output Mode Codes

| Function | Code |
|---|------|
| Send instrument status data string when addressed to talk | IS |
| Send long learn mode string when addressed to talk | LM1 |
| Send fast learn mode string when addressed to talk | LM2 |

Note: The sending of the status byte in response to a serial poll is not affected by the output mode code.

TABLE 5.25

Status Byte Mask Setting Code

| Function | Function Code | Data |
|----------------------|---------------|----------------|
| Set status byte mask | RS | 3 octal digits |

TABLE 5.26

Increment System Commands

| Function | Code |
|--------------------|------|
| Spinwheel HOLD off | IN 0 |
| Spinwheel HOLD on | IN 1 |
| COARSE sensitivity | IN 2 |
| MEDIUM sensitivity | IN 3 |
| FINE sensitivity | IN 4 |
| STEP selected | IN 5 |

TABLE 5.27

Miscellaneous Codes

| Function | Code |
|-------------------------|--|
| Switch to standby | GS 1 |
| Cancel standby | GS 0 |
| Carrier on | OP 1 |
| Carrier off | OP 0 |
| Initialise | IP |
| Enable special function | DG 2 digits of special function number |
| Display error code | WY |

Note: (1) The device clear (DCL) or selected device clear (SDC) messages may be substituted for code IP

(2) The special functions are listed in Section 4 Table 4.8. To exit from those special functions marked** send any primary function code.

TABLE 5.28

Alphabetic List of Function Codes

| Code | Meaning | Code | Meaning |
|------|----------------------|------|--------------------------|
| AD | Amplitude step down | IP | Initialise |
| AM | Amplitude modulation | IS | Status data string |
| AP | Amplitude | LM | Learn mode data string |
| AR | Amplitude, relative | MA | AM control |
| AS | Amplitude step size | ME | Memory execute |
| AU | Amplitude step up | MF | FM control |
| DG | Special function | MH | Phase modulation control |
| FD | Frequency step down | MI | Memory Exchange |
| FM | Frequency modulation | MP | Pulse modulation control |
| FQ | Frequency | MR | Memory recall |
| FR | Frequency, relative | MS | Memory store |
| FS | Frequency step size | OP | Carrier control |
| FU | Frequency step up | PM | Pulse modulation |
| GS | Standby | RM | Data acceptance mode |
| HM | Phase modulation | RS | Status byte mask |
| IN | Increment | WY | Display error code |

TABLE 5.29

Alphabetic List of Units Codes

| Code | Units | Code | Units |
|------|----------|------|---------|
| DB | dB | MZ | MHz |
| E | Exponent | NV | nV |
| GZ | GHz | PC | % |
| HZ | Hz | RD | Radians |
| KZ | kHz | UV | μV |
| MV | mV | VO | V |
| | | % | % |

RACAL-DANA Instruments Inc.

U. S. REPRESENTATIVES

ALABAMA
(800) 327-0853

ALASKA
(503) 241-8624

ARIZONA
(602) 252-5242

ARKANSAS
(918) 496-1457

CALIFORNIA
Northern
(408) 727-2341
Southern
(714) 859-8999
Los Angeles
(213) 628-8825

COLORADO
(303) 592-1717

CONNECTICUT
(617) 890-7195

DELAWARE
(609) 853-1605

DISTRICT OF COLUMBIA
(703) 941-0525

FLORIDA
(305) 724-0920 or
(800) 432-6288

GEORGIA
(800) 327-0853

HAWAII
(808) 847-4300

IDAHO
(714) 859-8999

ILLINOIS
(312) 932-4922

INDIANA
(800) RAC-DANA

IOWA
(800) RAC-DANA

KANSAS
(800) RAC-DANA

KENTUCKY
(800) RAC-DANA

LOUISIANA
(713) 780-2511

MAINE
(617) 990-7195

MARYLAND
(703) 941-0525

MASSACHUSETTS
(617) 890-7195

MICHIGAN
(800) RAC-DANA

MINNESOTA
(800) RAC-DANA

MISSISSIPPI
(800) 327-0853

MISSOURI
(800) RAC-DANA

MONTANA
(714) 859-8999

NEBRASKA
(800) RAC-DANA

NEVADA
(714) 859-8999

NEW HAMPSHIRE
(617) 890-7195

NEW JERSEY
Northern
(201) 423-3039
Southern
(609) 853-1605

NEW MEXICO
(602) 252-5242

NEW YORK
New York City,
Long Island
(516) 242-3454
Upstate New York
(315) 475-1500

NORTH CAROLINA
(800) 327-0853

NORTH DAKOTA
(312) 932-4922

OHIO
(800) RAC-DANA

OKLAHOMA
(918) 496-1457

OREGON
(503) 241-8624

PENNSYLVANIA
Eastern
(609) 853-1605
Western
(800) RAC-DANA

PUERTO RICO
(305) 724-0920

RHODE ISLAND
(617) 890-7195

SOUTH CAROLINA
(800) 327-0853

SOUTH DAKOTA
(312) 932-4922

TENNESSEE
(800) 327-0853

TEXAS
Austin
(512) 451-5174
Dallas
(214) 661-0300
Houston
(713) 780-2511
San Antonio
(512) 342-3031

UTAH
(714) 859-8999

VERMONT
(617) 890-7195

VIRGINIA
(703) 941-0525

WASHINGTON
(503) 241-8624

WEST VIRGINIA
Eastern
(703) 941-0525
Western
(800) RAC-DANA

WISCONSIN
(800) RAC-DANA

WYOMING
(714) 859-8999

CANADA
Ontario
(416) 625-0600 or
(613) 725-0288
Quebec
(514) 744-5829
Alberta
(403) 458-4669
British Columbia
(604) 434-2611



FACTORY SERVICE



RACAL-DANA INSTRUMENTS INC.
4 Goodyear Street
Irvine, California 92714
Telephone: (714) 859-8999

PRODUCT SERVICE TWX 910-595-1136

REGIONAL SERVICE CENTER



RACAL-DANA INSTRUMENTS INC.
5101 "D" Blacklick Road
Annandale, Virginia 22003
Telephone: (703) 941-0525

REPAIR REQUEST FORM

To allow us to better understand your repair requests, we suggest you use the following outline and include a copy with your instrument to be sent to your local Racal-Dana repair facility.

Model Number _____ Options _____ Date _____

Serial Number _____ P. O.# _____

Company Name _____

Address _____

City _____ State _____ Zip Code _____

Contact _____ Phone Number _____

1. Describe, in detail, the problem and symptoms you are having.

2. If you are using your unit on the bus, please list the program strings used and the controller type, if possible.

3. List all input levels, and frequencies this failure occurs.

4. Indicate any repair work previously performed.

5. Please give any additional information you feel would be beneficial in facilitating a faster repair time. (I. E., modifications, etc.)
