

FILE COPY

Universal Counter-Timer

9904

Operators Handbook

RACAL

The Electronics Group

PUBLICATION NUMBER WOH 8154
ISSUE 3.12.89

9904

UNIVERSAL COUNTER-TIMER

RACAL-DANA

RACAL-DANA INSTRUMENTS INC.
4 Goodyear Street, P.O. Box C-19541, Irvine, Ca 92713, USA.
Telephone: (714) 859-8999. TWX 910-595-1136. TLX 678-341

Duke Street, Windsor, Berkshire SL4 1SB, United Kingdom.
Telephone: Windsor (0753) 858101. TLX: 847013

RACAL-DANA INSTRUMENTS S.A.
18 Avenue Dutartre, 78150 Le Chesnay, France.
Telephone: (3) 955 88 88. TLX: 697 215

RACAL-DANA INSTRUMENTS GmbH.
Hermannstrasse 29, D-6078 Neu Isenburg, Federal Republic of Germany.
Telephone: 06102 2861/2. TLX: 412896

RACAL-DANA INSTRUMENTS ITALIA (srl)
Via Mecenate 84/A, 20138 Milano M1, Italy.
Telephone: (02) 5062767/5052686/503444. TLX: 315697

RACAL

PUBLICATION DATE: AUGUST 1977

Copyright © 1977 by Racal-Dana Instruments Ltd. Printed in England. All rights reserved.
This book or parts thereof may not be reproduced in any form without written permission of the publishers.

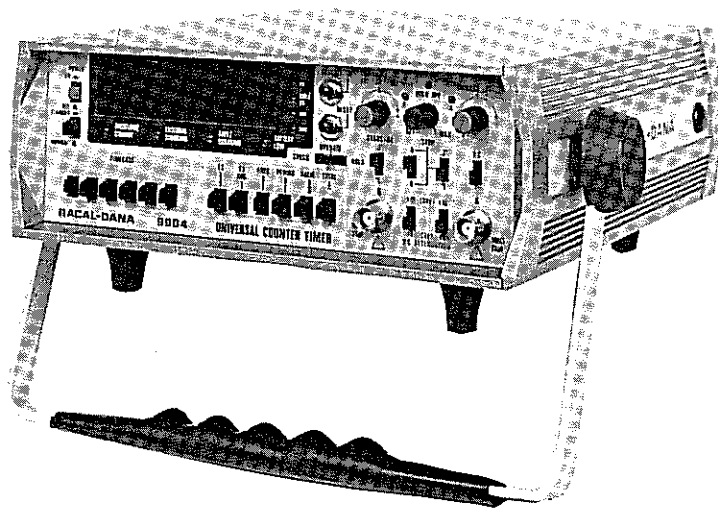

Universal Counter Timer 9904

RACAL
WOH 8154

CONTENTS

	<u>Page</u>
FRONTISPIECE	
TECHNICAL SPECIFICATION	Tech.Spec.(1) to Tech.Spec.(8)
SUPPLEMENTARY DATA	Tech. Spec. (9) to Tech.Spec.(12)
 CHAPTER 1	
GENERAL DESCRIPTION	
INTRODUCTION	1 - 1
OPERATING FACILITIES	1 - 1
POWER SUPPLY	1 - 1
FREQUENCY STANDARD	1 - 2
CARRYING HANDLE	1 - 2
MAINTENANCE	1 - 2
 CHAPTER 2	
PREPARATION FOR USE	
AC SUPPLY VOLTAGE SELECTION	2 - 1
POWER FUSE	2 - 4
POWER LEAD (LINE CORD)	2 - 4
POWER SWITCHING	2 - 4
SELF CHECK	2 - 4
CONNECTION OF EXTERNAL FREQUENCY STANDARD	2 - 5
REFERENCE FREQUENCY OUTPUT	2 - 6
BATTERY CHARGING	2 - 6
REMOVAL OF COVERS	2 - 6
CONTACT CLOSURE OPERATION	2 - 7
FITTING BATTERY PACK (OPTION)	2 - 7
FITTING RACK MOUNTING KIT (OPTION)	2 - 9
 CHAPTER 3	
DESCRIPTION OF CONTROLS INDICATORS AND CONNECTIONS	3 - 1
DESCRIPTION OF CONTROLS	3 - 1
INDICATORS	3 - 6
REAR PANEL ITEMS	3 - 6

CHAPTER 4

OPERATING INSTRUCTIONS

POWER SUPPLY	4 - 1
FREQUENCY MEASUREMENT	4 - 1
Overflow Procedure	4 - 2
PERIOD MEASUREMENT	4 - 2
TIME INTERVAL	4 - 3
RATIO	4 - 5
TOTALIZE	4 - 5
BATTERY ECONOMY OPERATION	4 - 7
STANDBY OPERATION WITH AC POWER	4 - 7

LIST OF TABLES

Table No.

1	Data Output Connector	Tech.Spec.(9)
2	Function Information	Tech.Spec.(10)
3	Time Base Selection	Tech.Spec.(10)
4	Self Check Readout	2 - 5

ILLUSTRATIONS

Fig. No.

1	Data Sequence Diagram	Tech.Spec.(11)
2	Control Sequence Diagram	Tech.Spec.(12)
3a/3b	Line Voltage Selection	2-2/2-3
4	Contact Closure Supply	2 - 7
5	Plan View: Rack Mounting II - 1126	2 - 9
6	Hold Off Principle	3 - 4

TECHNICAL SPECIFICATION

MEASURING FUNCTIONS

Modes of Operation	Frequency, Single and Multiple Period, Single and Multiple Ratio, Single and Double Line Time Interval, Single and Double Line Time Interval Averaging, Totalizing.
--------------------	---

DISPLAY

Format	Seven digits in-line, LED seven segment display with automatically positioned decimal point.
--------	--

Latch	The display is latched for Frequency Period and Ratio measurement and automatically unlatched in all other modes.
-------	---

Display Time	Gate Time + 0.15s in Frequency, Period and Ratio Modes. 1.5s in other modes. A switched hold position is provided.
--------------	---

Measurement Check	Counter reads 1MHz in Frequency mode.
-------------------	---------------------------------------

Segment Check	Sets all LED's to 8 when Check and Reset selected.
---------------	--

Reset	Manual by push-button, or automatic.
-------	--------------------------------------

Overflow/Standby Indication	LED illuminated when overflow occurs, or instrument is in the standby mode.
-----------------------------	---

Gate/Charging Indicator	LED illuminated when gate is open or when internal batteries are on full charge rate.
-------------------------	---

Battery Low Indicator	LED illuminated when internal batteries require charging.
-----------------------	---

Units Indicator	Four LED's indicate the units of the display.
-----------------	---

External Standard Indicator	An LED indicates when external standard is operating.
-----------------------------	---

CHANNEL A INPUT - AC-COUPLED

Frequency Range	10Hz to 50 MHz.
Sensitivity	10mV r.m.s. (continuously variable by sensitivity control).
Maximum Signal Level	250V r.m.s. up to 20 kHz. 50V r.m.s. up to 100 kHz. 10V r.m.s. above 100 kHz.
Maximum Input Level	The d.c. level + peak signal level must not exceed 400V over the full frequency range.
Input Impedance	1M Ω in parallel with approximately 25pF (falling to 100k Ω at 4V r.m.s. with Sensitivity control in the 10mV position).

CHANNELS A and B DC COUPLED

Frequency Range	A Channel : d.c. - 20MHz. * B Channel : d.c. - 10MHz.
Pulse Duration	25ns minimum at trigger points.*
Sensitivity	\pm 140mV about offset level for \pm 3V offset. \pm 1.4V for \pm 30 volt offset.
Trigger Levels	\pm 3V or 30V nominal with switched zero offset position.
Trigger Lamps	Trigger lamps flash to indicate when input level is passing through input hysteresis threshold.
Attenuator	X10 attenuator selected by front panel switches giving increased offset with reduced sensitivity.
Input Impedance (approximate)	1M Ω /25p falling to 100k Ω at \pm 5V on X1. 1M Ω /25p falling to 900k Ω at \pm 50V on X10.
Overload Protection	X1, 100V rms up to 1 MHz, declining to 10V rms at 20 MHz. X10, 100V rms up to 1 MHz, declining to 40V rms at 20 MHz.
Hold Off	This control allows the user to hold off the stop signal for approximately 0.1ms to >100ms in the T.1 or totalize mode. This delay may be measured by selecting Check and T.1.

* Refer to measurement function for limits on maximum frequency or minimum pulse width.

CHANNELS A & B DC COUPLED (continued).

Start Inhibit	This facility inhibits the start signal if desired (control available on Pin J of Data o/p connector and at pin on rear panel).
Connection	B.N.C. Sockets on front panel.

FREQUENCY MEASUREMENT

Input	Channel A
Frequency Range	AC mode: 10Hz - 50MHz. DC mode: d.c. - 20MHz.
Coupling	a.c. or d.c.
Gate Times	1 ms to 100s in decade steps.
Accuracy	\pm 1 count \pm time base accuracy.

SINGLE & MULTIPLE PERIOD MEASUREMENT

Input Channel	Channel A
Range	1 μ s to 10s.
Clock Unit	1 μ s
Coupling	a.c. or d.c.
Periods Averaged	1 to 10 ⁵ in decade multiples.
Accuracy	\pm 0.3% \pm Freq. Std Number of periods averaged accuracy
Bandwidth	\pm 1 count, at 50mV r.m.s. a.c. input or 100mV d.c. input with 40dB S/N ratio. Automatically reduced to 10MHz (3dB) when Period selected (AC mode).

TIME INTERVAL SINGLE & DOUBLE LINE

Input Channel	Single Line: Channel B Double Line: start Channel B stop Channel A
Time Range	100ns to 10^5 s (28 hours).
Clock Units	100ns to 10ms
Start/Stop Signals	Electrical or contact.
Manual Start/Stop	By single push button on front panel.
Trigger Slope Selection	Electrical: positive or negative slopes can be selected on both Start and Stop signals.
Accuracy:	± 1 count \pm trigger error \pm frequency standard accuracy.
Trigger Error: (in ns)	= $\frac{10}{2 \times \text{Signal slope at trigger point (V/\mu s)}}$

TIME INTERVAL AVERAGING SINGLE & DOUBLE LINE

Input Channel	Single Line: Channel B Double Line: Start Channel B Stop Channel A
Time Range	150 ns to 1 s
Dead Time Between Intervals	150 ns minimum
Clock Unit	100 ns
Time Intervals Averaged	1 to 10^5 in decade multiples.
Accuracy	\pm Timebase accuracy \pm system error \pm averaging error. System error: 10ns maximum per input channel. This is the difference in delays between start and stop signals and can be minimised by matching externally.
	Averaging Error = $\frac{(\text{Trigger error} + 100)}{\sqrt{\text{Intervals averaged}}}$ (in nanosecs)
	Trigger Error = $\frac{10}{2 \times \text{Signal slope at trigger point (V/\mu s)}}$ (in nanosecs)

RATIO

High Frequency Input	Channel A: (AC: 10Hz - 50MHz DC: 0 - 20MHz)
Low Frequency Input	Channel B: d.c. - 10MHz.
Accuracy	± 1 count \pm trigger error on Channel B.
Reads	$\frac{\text{Frequency A}}{\text{Frequency B}} \times n$
Multiplier n	1 to 10^5 in decade multiples.

TOTALIZING

Input Channel	Channel A (d.c. to 10MHz).
Maximum Rate	10^7 events per second.
Pulse Width	50ns minimum at trigger points.
Pre-Scaling	Events can be prescaled in decade multiples (n) from 1 to 10^5 .
Reads	$\frac{\text{Number of input events}}{n} + 1$ count
Manual Start/Stop	Single push button on front panel.
Electrical Start/Stop	By electrical signal applied to Channel B. Specification as for Time Interval, Single line working.

FREQUENCY STANDARD

Internal Frequency Standard	Refer to Options O4A, O4B and O4C on Page Tech. Spec (7). Option O4C will normally be fitted.
-----------------------------	---

EXTERNAL FREQUENCY STANDARD INPUT

Frequency	1MHz, up to 4:1 ratio, pulse or sinewave.
Input Socket	Applied to channel B input socket and provides external standard for Frequency and Period measurement only. The instrument automatically changes to external standard operation when the external standard is connected and switched on.

STANDARD FREQUENCY OUTPUT

Frequency	1MHz.
Level	Standard t.t.l. output, or 600mV p-p into 50Ω.
Waveform	Approximately rectangular
Connector	BNC socket on rear panel.

EXTERNAL SIGNALS

Data Outputs	Eight digits with overflow and decimal points in serial BCD form at standard t.t.l. levels.
Other Outputs	Function, timebase data and overflow information. Schmitt trigger outputs from both d.c. channels.
Inputs	Reset and print hold.

POWER SUPPLY

AC Mains (line power) operation

Voltage

Appropriate transformer connections allow six pairs of voltage ranges to be selected, and a rear panel switch selects between the upper and lower range of each pair :-

- (1) 94-106 V / 106-119V
- (2) 106-119V / 118-132V
- (3) 188-212V / 200-225V
- (4) 200-225V / 212-238V
- (5) 212-238V / 224-251V
- (6) 224-251V / 235-265V

Refer to Chapter 2 for setting instructions.

Frequency	45-450Hz
Consumption	19VA approximately.

MECHANICAL

	<u>Height</u>	<u>Width</u>
Dimensions	83mm (case only) 110mm overall	240mm (case only) 284 overall
Weight	Depth: 268mm 2.7kg (excluding battery pack) Battery pack 1.5kg.	

ENVIRONMENTAL & SAFETY SPECIFICATIONS

Operating Temperature	0°C to +55°C (to +40°C with Battery Option).
Storage Temperature	-40°C to +70°C (to +60°C with Batteries).
Humidity	95% r.h. at +40°C.
Mechanical	In accordance with IEC 68
Safety	Meets IEC 348 (BS4743).

OPTION 01 SERIAL TO PARALLEL INTERFACE

Data and Control Information	8 decades of data in 4 line BCD, 1248 3 line decimal point position, print command, print hold, reset, overflow and time-base information. Logic levels t.t.l. compatible.
------------------------------	--

FREQUENCY STANDARD 04A

Type	Model 9442 A fast warm up ovened precision oscillator suitable for the majority of applications.
Frequency	5MHz.
Ageing Rate	± 3 parts in 10 ⁹ / day after 3 months continuous operation.
Warm-up Time	Better than ± 2 parts in 10 ⁷ within 6 minutes.
Temperature Stability	Better than ± 3 parts 10 ⁹ per °C over the range -10°C to +45°C. Useable to +55°C.

FREQUENCY STANDARD 04B

Type	Model 9421. An ovened oscillator of the utmost precision for use when the highest long term accuracy is essential. Not available when battery pack option is fitted.
Frequency	5MHz
Ageing Rate	± 5 parts in 10 ¹⁰ / day after 3 months continuous operation.
Warm-up Time	Better than ± 1 part in 10 ⁷ within 20 minutes.
Temperature Stability	Better than ± 6 parts in 10 ¹⁰ per °C over the range -10°C to +45°C. Useable to +55°C.

FREQUENCY STANDARD 04C

Type	An unovened crystal oscillator suitable for less critical applications or where the instrument will normally be used with the customer's external standard.
Frequency	5MHz
Ageing Rate	± 1 part in 10 ⁶ per month.
Temperature	± 8 parts in 10 ⁶ over temperature range 0°C to 55°C. ± 3 parts in 10 ⁶ over temperature range +20°C to +40°C.

OPTION 07: BATTERY POWER PACK: PART NO. 11-1009

Mechanical	Battery pack is mounted on a metal tray inside the instrument and connected via a polarised 4-pin connector to the main p.c.b.
Selection	By means of 3-position Line Power/Charge Battery Power switch on rear panel.
Battery Life	4½ hours minimum continuous at +20°C, 15 hours minimum on standby at +20°C
Battery Condition	Indicated by 'Battery Low' l.e.d. on front panel.
Charge Time	14 hours at +20°C.
Standby Facility	With Normal/Standby switch in standby position only the internal standard is operational. Pressing the Reset switch activates the counter for approximately 1 minute after which it reverts to the standby condition.

ACCESSORIES

Accessories supplied:	Operating handbook and spare fuses
Accessories available:	19-inch rack mounting kit (11-1126) Rigid carrying case (15-0450) Padded carrying case (15-0444) Data output connector (23-5147)

DATA OUTPUT CONNECTIONS

Data and Command information is available via a 28-way edge connector accessible by removing a cover on the rear panel. The facilities and pin connections are listed in Table 1 below. The logic for time base and function data is given in Tables 2 and 3.

TABLE 1.

Data Output Connector

Pin	Facility	Pin	Facility
1	-5V (nominal)	A	0V
2	+5V (nominal)	B	*Overflow (Static)
3	Key Way	C	Key Way
4	$\overline{4}$ (BCD)	D	$\overline{1}$ (BCD)
5	$\overline{8}$ (BCD)	E	$\overline{2}$ (BCD)
6	External Hold Input	F	10kHz Sync.
7	External Reset Input	H	Main Gate
8	Not used	J	Start Inhibit
9	\overline{c} Function	K	\overline{z} Time Base
10	\overline{b} Information	L	\overline{y} Information
11	\overline{a} (See Table 2)	M	\overline{x} (See Table 3)
12	$\overline{R_0}$	N	Not used
13	Hold/Reset	P	Not used
14	Not used	R	Not used

- NOTES: 1. For further information on External Hold Input and External Reset input refer to paras. A5 and A6 on page Tech. Spec. (12).
2. On pin J the application of logical '0' level inhibits the start channel.

Function Data

Function information format : 3 lines coded as follows. The table gives the logic available at the edge connector. The inverse levels are applied to the CDI Chip in the instrument.

TABLE 2

Function Information

Function	Code		
	\bar{a}	\bar{b}	\bar{c}
Frequency	1	1	1
Average Period	0	1	1
Totalize A : Start/Stop 'B'	0	1	0
Ratio n A n	1	1	0
T.I. (single or double line not averaged)	0	0	1
T.I. (single or double line averaged) 1		0	1

Time Base Selection Data Output

Time Base information : 3 lines coded as follows.

TABLE 3

Time Base Selection

Code x y z	Frequency Gate Time	Multiplier 'n'	Time Interval Clock
1 1 1	1ms	1	0.1 μ s
0 1 1	10ms	10^1	1 μ s
1 0 1	100ms	10^2	10 μ s
0 0 1	1 sec	10^3	100 μ s
1 1 0	10 sec	10^4	1ms
0 1 0	100 sec	10^5	10ms

DATA, TIME BASE AND CONTROL PRINCIPLES

FUNCTION AND TIME BASE CODES

A1. The function and time base requirements are applied internally to the CDI chip on a six-line code. The inverse states of this code are fed out to the rear data output connector. The function and time base information codes are given in Tables 2 and 3 on the previous page.

DATA OUTPUT FORMAT

A2. In standard format the b.c.d. output data is available at the 28-way edge connector in a bit parallel byte serial form. The data is sequenced by a 10kHz synchronising signal. An additional synchronising pulse (R_0) determines the first state (10^0 digit). Accessories are available to give data output in parallel format (for printers etc.) or IEC/ASCII bus compatible format.

A3. The ten data output states are as follows: the timing is shown in Fig. 1.

States	Facility
1 to 8	Digit (display information).
9	Overflow for 10^3 , 10^4 , 10^6 and 10^7 digits on pins D, E, 4 and 5 respectively.
10	Decimal point position in kHz units, plus overflow information for 10^5 digit, via pin 5.

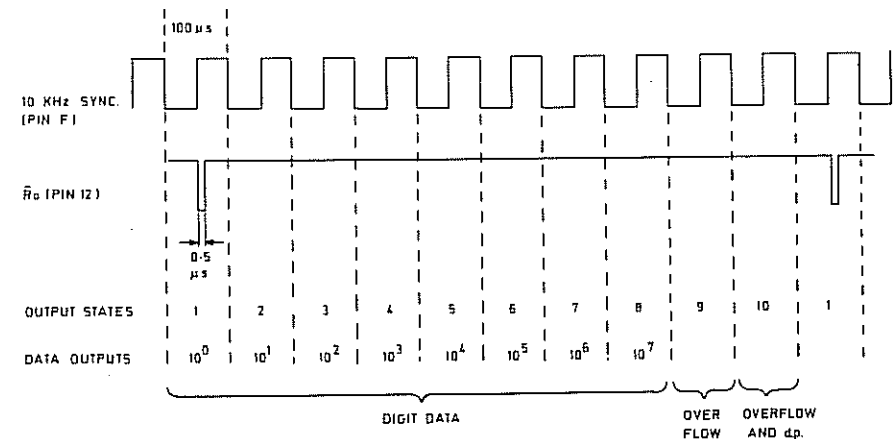

Data Sequence Diagram

Fig.1

CONTROL SEQUENCE

A4. Figure 2 shows the control sequence diagrammatically (not to scale).

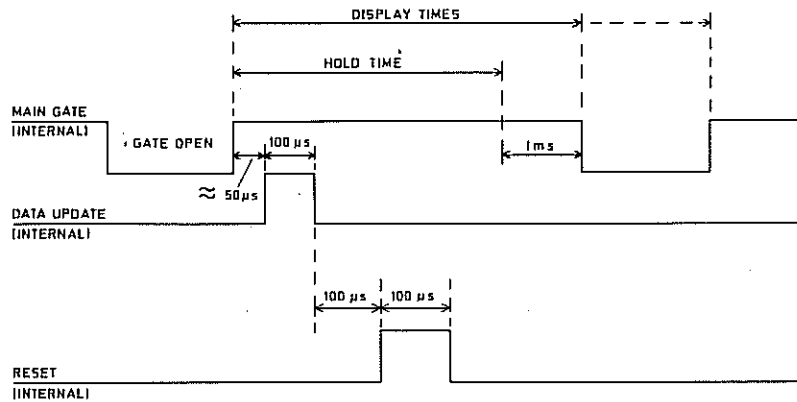

Control Sequence Diagram Fig. 2

NOTE: The longer display time applies to the latched modes.

External Hold

A5. If, when used with external circuitry, it is required to extend the cycle time, the external hold, (logic '0', pin 6) must be applied during the gate or hold time. In order to initiate a new cycle of measurement, the external hold must go 'high' for not less than 200 μs.

External Reset

A6. External reset is achieved by the application of logic '0' to pin 7 of the connector for a period of not less than 5 ms, on returning to '1' level this will reset the display to 'all zeros' and initiate a new measurement cycle.

Start Inhibit

A7. A logical '0' applied to pin J of the data connector (Table 1) or to the Start Inhibit pin on the rear panel, inhibits the start channel and thus permits selection of the required start signal.

CHAPTER 1

GENERAL DESCRIPTION

INTRODUCTION

1.1 The 9904 is a seven-digit universal counter timer, powered from line power or optional internal batteries and with a comprehensive range of facilities as follows.

OPERATING FACILITIES

- 1.2 (a) Frequency measurement ranges: AC coupled: 10 Hz to 50 MHz.
DC coupled: DC to 20 MHz.
- (b) Period measurement, 1 to 10^5 periods in decade steps, a.c. or d.c. coupled.
- (c) Ratio measurement.
- (d) Time Interval, single or double line, with manual or electrical start/stop signal, trigger slope selection.
- (e) Time Interval average, single or double line, with trigger slope selection.
- (f) Totalize, with electronic or manual start/stop.

1.3 In addition to the usual control facilities such as AC/DC input selection, manual Hold and Reset, Check etc., the 9904 incorporates variable sensitivity on the 'A' channel and variable d.c. offset on both 'A' and 'B' channels. Variable hold-off is available when using Time Interval or Totalize mode. The amount of hold-off (in milliseconds) can be displayed. The start channel can be inhibited by application of logical '0' to a rear panel pin or the data connector.

POWER SUPPLY

AC (Line) Supply

1.4 The instrument operates from a.c. supplies between 94 and 265 volts, 45-450 Hz. Tappings and a link on the internal line transformers provide for a choice of six voltage ranges. A rear panel switch must be set to select either the upper or lower half of the chosen range. Refer to Chapter 2 for details.

Battery Power Supply (Option)

1.5 The instrument can operate either from normal line power supplies, or from an internal battery pack containing re-chargeable nickel cadmium cells. The batteries allow 4½ hours continuous operation from the full charged condition. A 3-position rear panel switch selects line or battery power, or full rate charging of the batteries from the internal charging circuit. When on battery operation a warning light indicates when the battery voltage is low.

Battery Charging

1.6 To fully charge a discharged battery requires 14 hours. Avoid over-charging as it will progressively reduce battery charge capacity. When the instrument is operating from line power the batteries receive a trickle charge which can continue indefinitely without detriment to the batteries.

Battery Economy (Standby) Facility

1.7 This facility may be used when continuous readout is not required. On BATTERY operation with the front panel switch at STANDBY, the instrument is 'off' except for the internal frequency standard. If the RESET button is depressed and released the instrument will then operate normally for approximately one minute, after which it reverts to the standby condition. This operation may be repeated as required.

FREQUENCY STANDARD

1.8 Customers are offered a choice of two high stability temperature controlled frequency standards from the Racal-Dana range, or an unovered oscillator. Details are given on page Tech. Spec (8). The high stability units should be serviced only by Racal-Dana or authorised agents. An aperture in the rear panel provides access for calibration of the frequency standard. A 1MHz reference frequency, derived from the standard in use is available from a BNC socket on the rear panel.

1.9 When an external frequency standard is connected and switched on the instrument automatically changes to external standard operation, (on Frequency and Period only) and the front panel l.e.d. illuminates to show this.

CARRYING HANDLE

1.10 The instrument is fitted with a combined carrying handle and bench stand. To adjust the stand, press in the two handle bosses simultaneously, while setting the stand to the desired position.

MAINTENANCE

1.11 The customer is recommended to take advantage of the servicing facilities offered by Racal-Dana Instruments Ltd, and agents. A comprehensive maintenance manual is, however, available for purchase at the address on the title page of this book.

CHAPTER 2

PREPARATION FOR USE

AC SUPPLY VOLTAGE SELECTION

Introduction

2.1. A label on the rear panel shows the voltage range to which the instrument is set. Six pairs of voltage ranges are obtainable by appropriate arrangement of a link and tapings on the transformer tag board. A two-position slide switch on the rear panel enables the user to select either the upper or lower range from each pair. (see Fig.3a and 3b).

2.2 When the selection procedure has been completed, a label showing the selected range pair must be affixed to the rear panel. Instruments are manufactured with a permanent panel marking for the 212-251V range. Five spare labels are supplied in the accessories bag for use if another voltage range has to be selected.

Voltage Selection Procedure

- 2.3
- (1) Unplug the power cable from the supply and remove the top cover (para.2.12).
 - (2) Refer to Fig.3a or Fig.3b and note the diagram which corresponds to desired voltage range. Note that the switch diagram is drawn as seen within the unit.
 - (3) Remove the snap-on plastic cover plate from the transformer tag board. (It clips on at the corners).
 - (4) Using a soldering iron, arrange the link and switch leads on the transformer tag board to conform with the chosen diagram. Do not disturb the neutral lead, which remains on the 0V tag on all times.
 - (5) Refit the plastic plate to the tag board.
 - (6) On the outer face of the rear panel set the A/B switch to the position for the required upper or lower half of the voltage range.
 - (7) Attach the appropriate voltage label.
 - (8) Carefully re-check the work against the diagram, then replace the top cover.

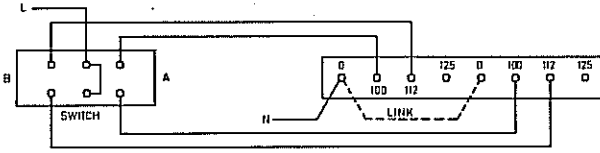

94-106V (SWITCH TO 'A')
106-118V (SWITCH TO 'B')

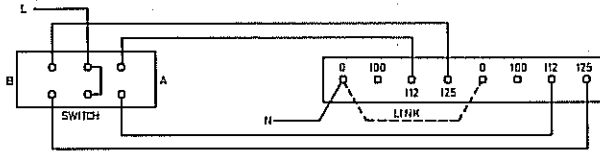

106-118V (SWITCH TO 'A')
118-132V (SWITCH TO 'B')

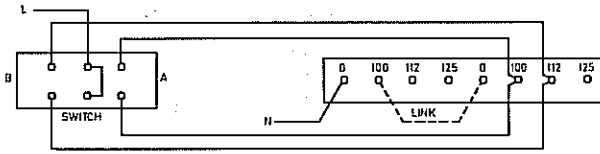

188-212V (SWITCH TO 'A')
200-225V (SWITCH TO 'B')

Line Voltage Selection
(CONTINUED ON FIG. 3b)

Fig. 3a

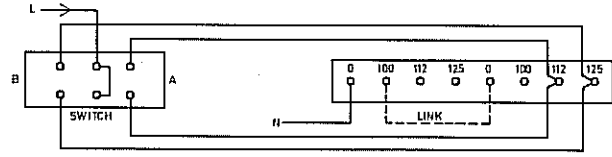

200-225V (SWITCH TO 'A')
212-238V (SWITCH TO 'B')

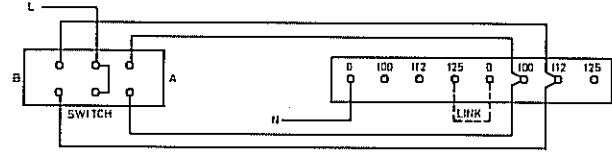

212-238V (SWITCH TO 'A')
224-251V (SWITCH TO 'B')

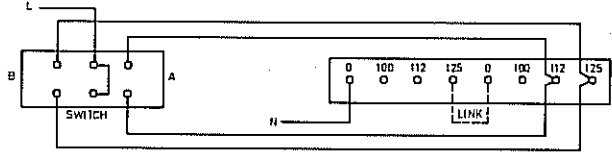

224-251V (SWITCH TO 'A')
235-265V (SWITCH TO 'B')

Line Voltage Selection

Fig. 3b

POWER FUSE

2.4 Check that the power fuse on the rear panel is correctly rated for the supply voltage. Fuses are the glass cartridge type, 20 x 5mm, as follows:-

Supply Range	Fuse Rating	R-D Part.No.
188V - 265V	125mA anti-surge	23-0043
94V - 132V	250mA anti-surge	23-0031

POWER LEAD (LINE CORD)

2.5 Fit a suitable plug to the power lead, observing the colour codes, as follows:-

Connection	European	U.S.A.
Line.....	Brown	Black
Neutral.....	Blue	White
Earth (Ground).....	Green/Yellow	Green

POWER SWITCHING

- 2.6 (1) Set the rear panel switch to Line Power, or BATTERY Power, according to power supply.
- (2) Connect the line power lead (if using a.c. supply) and set the NORMAL/STANDBY switch to NORMAL.
- (3) Set the POWER switch to ON. If using battery power, verify that the BATTERY LOW indicator is not illuminated. Illumination indicates that batteries need charging.

SELF CHECK

- 2.7 (1) Set the CHECK/OPERATE/HOLD switch to CHECK and set Timebase (n) to 1. Verify that the GATE lamp illuminates. The instrument will now display 1000kHz. Refer to Table 4 and check the display and decimal points (Frequency column) for each of the Timebase (n) buttons. Verify that the kHz/μs l.e.d. indicator illuminates.
- (2) Depress the PERIOD button and verify the Period readouts in Table 4. Again check the kHz/μs indicator.
- (3) Briefly hold in the RESET button and verify that the display reads 'all eights' (segment check).
- (4) Finally, return the CHECK/OPERATE/HOLD switch to OPERATE.

TABLE 4

SELF CHECK READOUT

Range 'n' Selected	Display (± 1 count)	
	Frequency	Period
1	0001000.	0000001.
10 ¹	001000.0	000001.0
10 ²	01000.00	00001.00
10 ³	1000.000	0001.000
10 ⁴	*000.0000	001.0000
10 ⁵	*00.00000	01.00000
	* Overflow lamp will illuminate after 10 seconds (10 ⁴) and 100 seconds (10 ⁵).	

CONNECTION OF EXTERNAL FREQUENCY STANDARD

- 2.8 The requirements for the external reference frequency source are given in the Technical Specification. It should be borne in mind that the accuracy of measurement is directly related to the accuracy of the frequency standard used.
- 2.9 The connection for the external frequency standard is via the front panel 'B' input socket (this socket is not used for measurement in Frequency and Period modes). When the frequency standard signal is applied, the instrument will automatically change to external standard operation and the front panel l.e.d. will illuminate to indicate this.

REFERENCE FREQUENCY OUTPUT

2.10 The 1MHz reference output is available via the BNC socket on the rear panel.

BATTERY CHARGING (with optional battery pack)

- 2.11 (1) Set the rear panel switch to CHARGE.
(2) Connect the line power supply.
(3) Set the POWER switch to ON and the NORMAL/STANDBY switch to NORMAL.

NOTE: To fully charge a discharged battery required 14 hours. Avoid over-charging, as it will progressively reduce battery charge capacity.

REMOVAL OF COVERS

WARNING: DANGEROUS AC VOLTAGES ARE EXPOSED WHEN COVERS ARE REMOVED WITH AC SUPPLY CONNECTED.

- 2.12 (1) Set the POWER switch to 'off', switch off the a.c. supply at the supply point and unplug the power lead.
(2) Remove the rubber bungs (located near to the rear end) from both side panels of the instrument and slacken, by about two turns, the screws revealed.
(3) Grip the rear panel assembly and ease it back from the main case to the maximum extent available (about 5 mm).
(4) The rear edge of either cover can now be lifted and the cover withdrawn outwards and rearwards.
(5) To replace the covers reverse the above procedure.

CONTACT CLOSURE OPERATION

2.13 Contact closure timing operates via the 'B' input socket. An external current source with a sink of, say, 0.5mA must be provided by the user. With the HOLD OFF l.e.d. on, a variable contact bounce suppression of up to 100 ms is provided internally. A typical contact closure arrangement for a supply up to +100V is illustrated below.

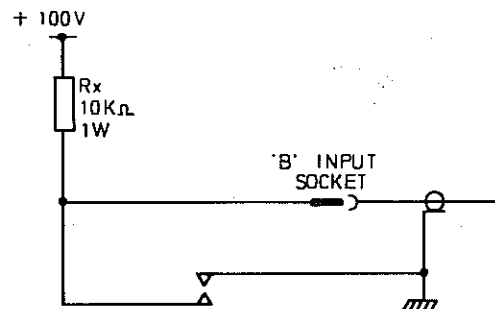

Contact Closure Supply Fig. 4

FITTING BATTERY PACK (OPTION)

NOTE: The battery pack cannot be fitted if frequency standard model 9421 is fitted.

Component Parts

2.14 The battery pack option contains the following items:-

<u>Item</u>	<u>Part No.</u>	<u>Quantity</u>
Battery Pack Assembly complete with batteries and connecting lead.	11-0920	1
Mounting Bracket Assembly	11-0907	1
Locator Pegs	14-1486	2
Screws M4, 6mm	24-7729	4
Washers (crinkle M4)	23-2802	4
Washers (small, plain, M4)	24-2705	2

BATTERY PACK FITTING PROCEDURE

- 2.15
- (1) Switch off, disconnect the a.c. supply and remove the top cover (para. 2.12).
 - (2) Looking at the front of the instrument, screw the two locator pegs into the threaded holes on the inner face of the right hand side member.
 - (3) Place the mounting bracket against the inner face of the left hand side member with the hole in the bracket located over the carrying handle nut.
 - (4) Secure the bracket to the two threaded holes in the side member, using M4 screws and crinkle washers.
 - (5) Take the battery pack assembly, with batteries uppermost and the connecting lead to the left. Carefully lower the right hand end into the instrument so that two holes in the right hand end fit on to the locator pegs fitted in (2).
 - (6) Lower the left hand end on to the mounting bracket so that the slots line up with the outer screw holes in the bracket.
 - (7) Insert two M4 screws, with plain and crinkle washers, into the screw holes and make secure.
 - (8) Plug the connecting lead on to pins 48 to 51 on the main p.c.b. These pins are just to the right of the mains transformer, and are spaced to prevent reversed connection.
 - (9) Replace the top cover and check the instrument on battery power. Charge the batteries if necessary.

FITTING RACK MOUNTING KIT (OPTION) TYPE 11-1126

- 2.16
- (1) Remove the bench type handle assembly by carefully prising off the plastic caps from the handle pivots, and then extracting the screws which secure the assembly to the unit. Store safely for possible future use.
 - (2) Remove the rubber bungs referred to in 'removal of covers' procedure and completely remove the two screws revealed. This allows the rear panel to be drawn away from the side panels (as far as wiring permits).
 - (3) With the rear panel drawn backwards, slide out the trim strips from the side panels. Store them safely for possible future use. Then refit the rear panel and secure firmly with the two screws removed in (2).
 - (4) At the front of the instrument, remove the screw securing the front panel on one side and discard. Refer to diagram below and fit bracket (item 3) using spacers (items 10 and 11) screws (item 25) and washers (item 19).
 - (5) Repeat (4) on the other side of the front panel.
 - (6) Fit the rack type handles (item 1) to the plates (item 5) using two Taprite screws (item 32) to each handle.
 - (7) Fit the plate assemblies to brackets on the unit, using two of items 15, 20 and 28 to each plate assembly.

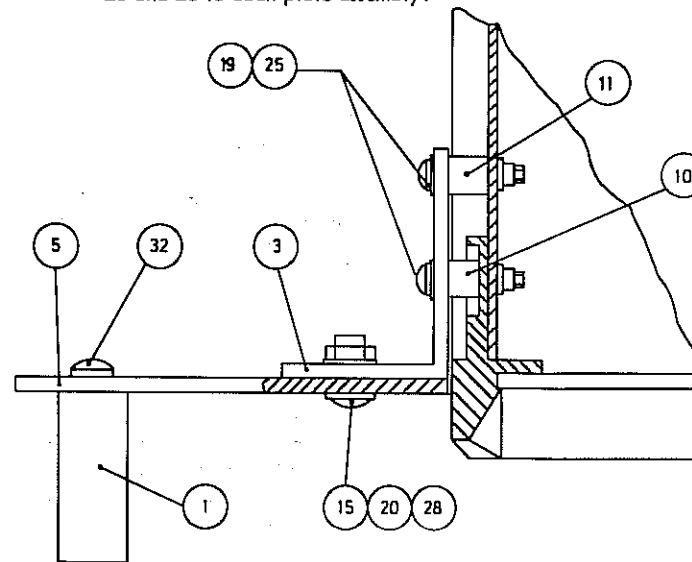

Plan View: Rack Mounting 11-1126 Fig.5

CHAPTER 3

DESCRIPTION OF CONTROLS INDICATORS AND CONNECTIONS

Function Push-button
Switch Bank:

This bank of six press switches, located near the centre of the front panel, selects the following measurement modes:-

- (i) T.I.
Provides time interval measurement between two successive events. The events may be on one line (B-B) or separate lines (B-A), with start and stop slopes of the same or opposite polarity.
- (ii) T.I. Avg.
This mode is suitable for the measurement of short repetitive events, with start/stop controls as in T.I. By averaging over a number of events the resolution is increased.
- (iii) FREQ.A
Provides frequency measurement of the 'A' channel input with readout in kHz.
- (iv) PERIOD A
Provides period measurement on 'A' channel signal with readout in microseconds.
- (v) RATIO $n \frac{A}{B}$
Refer to Chapter 4, para.4.10.
- (vi) TOTAL $\frac{A}{n}$
Provides accumulated total of events applied to Channel A, with prescaling by the factor 'n' according to the switch selected in the Timebase switch bank.

DESCRIPTION OF CONTROLS (Cont'd)

- Time Base Range: This bank of six 'n' switches offers a choice of gate times, and clock units on T.I. The multiplier 'n' associated with each switch may also be defined as follows:-
- (a) The number of periods averaged on 'period average' measurement.
 - (b) The 'A' input pre-scale factor on 'totalise'.
 - (c) The 'B' input pre-scale factor on 'ratio'.
 - (d) The number of intervals averaged on 'time interval average'.
- START Slope Switch: A slide switch which selects either positive - going or negative-going trigger edge for start of time interval and totalize measurements. Applies to Channel 'B' only.
- STOP Slope Switch: Selects the required 'stop' trigger edge polarity on TI, TIAvg and totalize, on Channel 'A' or 'B', according to the setting of the Stop Channel Selection switch.
- Stop Channel (A/B) Selection Switch: Position 'B' selects single line (Channel 'B' only). Position 'A' selects double line (Start on Channel 'B', Stop on Channel 'A').
- AC/DC Switch: This switch selects either a.c. or d.c. coupling in the 'A' channel amplifier.
- Operation on DC Mode
The use of d.c. mode is recommended in the following circumstances:
- (a) For signals having a slow rate of rise and fall (e.g. sinusoidal signals of frequency lower than 10 Hz).
 - (b) For signals of rectangular waveform which have a mark/space ratio other than 1 : 1 provided the frequency is less than 10 MHz.
 - (c) Random pulses.

DESCRIPTION OF CONTROLS (Cont'd)

AC SENSITIVITY and TRIGGER LEVEL

This is a dual potentiometer and switch operated by a single control, which performs two functions in the 'A' channel:-

Sensitivity

The attenuator control is operative on 'A' channel signals when the AC/DC switch is at AC. It is particularly useful in filtering out h.f. interference on lower frequency measurements.

DC trigger Level

The control provides d.c. offset from -3V to +3V when the AC/DC switch is at DC. If offset is not required the control should be turned fully anti-clockwise to the switched ('0') position. When the 'A' channel attenuator switch is set to X10 the d.c. offset range becomes +30V to -30V.

TRIGGER LEVEL Control ('B' Channel)

The principles of this control are identical to the 'A' channel Trigger level described above.

START/STOP Push button:

Provides manual start/stop on Time Interval and Totalize modes.

CHECK/OPERATE/HOLD Switch:

In the OPERATE position the instrument provides updating of the display. In the HOLD position the display is held but a single shot update can be obtained by depressing the adjacent RESET button. In the CHECK position the following facilities are available:-

- (a) 1 MHz self check display.
- (b) With RESET button depressed, and held down, an 'all 8's' display is provided for segment check.
- (c) With T.I. function selected the Hold Off delay in milliseconds is displayed.

DESCRIPTION OF CONTROLS (Cont'd)

HOLD OFF Control

Hold Off is used on time interval and totalize to delay the operation of the stop pulse, thus disregarding unwanted pulses occurring within a time (up to 100 ms) selected by the Hold Off control. The amount of Hold Off selected can be displayed by selecting T.I. and CHECK. An l.e.d. illuminates when the variable hold-off is in use.

Referring to the diagram below, if a is the desired time interval, then the Hold Off period will prevent pulses x and y from causing a premature stop.

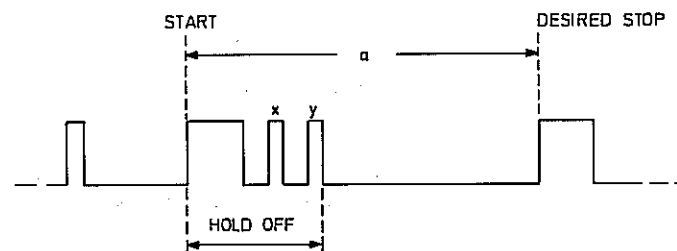

Hold Off Principle

Fig. 6

RESET Push Button:

When the RESET button is depressed and released the instrument will clear down to zero and initiate a new measurement. The RESET button is also used in the segment check.

Attenuator (X1/X10) Switches:

When X1 is selected the TRIGGER LEVEL controls have a d.c. offset range of +3V to -3V. When X10 is selected 20dB of attenuation is inserted and the offset range becomes +30V to -30V.

DESCRIPTION OF CONTROLS (Cont'd)

POWER ON/OFF Switch

The function of this switch is affected by the setting of the rear panel LINE POWER/CHARGE/BATTERY POWER switch, and by the NORMAL/STANDBY switch.

POWER ON Position

With LINE POWER selected, the a.c. supply is connected to the instrument for normal operation. Trickle charging of the batteries, if fitted, will take place.

With BATTERY POWER selected, battery power (if fitted) is connected to the instrument.

With CHARGE selected, the batteries (if fitted) will receive a full rate charge when a.c. supply is connected.

POWER OFF Position

In the 'off' position the charging and operating facilities are switched off, irrespective of the type of power supply.

NORMAL/STANDBY Switch

In the NORMAL position the POWER switch has its full range of functions. In STANDBY position the power supply from either line or battery source is restricted, in that the frequency standard remains in continuous operation but the instrument only operates in response to the battery economy facility, as described in paras. 4.14 and 4.15.

Input Connectors

The 'A' and 'B' input connectors are BNC type. The symbol \triangle advises the user to consult the handbook for further details. Reference should be made to the Technical Specification at the front of the book, and to operating instructions in Chapter 4.

INDICATORS

OVERFLOW/STANDBY Indicator

The OVERFLOW indicator will illuminate when the count exceeds the capacity of the 7-digit display. When STANDBY is selected, the i.e.d. illuminates after approximately one minute of normal operation (see para.4.15).

BATTERY LOW Indicator

Illumination indicates that the batteries will be exhausted within a few minutes.

GATE/CHARGING Indicator:

This indicator illuminates as follows:-

- (a) When the counter gate is 'open' thus the illumination period is related to gate time selected.
- (b) When the batteries are receiving full charge a steady illumination is obtained (at the same time the readout display will be blank).

EXTERNAL STANDARD Indicator

The i.e.d. illuminates when an external frequency is connected to Input 'B' and is functioning (on Frequency and Period modes).

Channel 'A' and Channel 'B' Trigger

These i.e.d.'s flash when the input signal is passing through the hysteresis threshold of the associated input Schmitt Triggers. These indications assist the setting up of the DC TRIGGER LEVEL control.

Measurements Units

The 'ms', 'kHz/ μ s', 'ns' and 'sec' i.e.d.'s indicate the appropriate unit for the display.

HOLD OFF Indicator

When the HOLD OFF control is moved from the OFF position the i.e.d. illuminates.

REAR PANEL ITEMS

LINE POWER/CHARGE/BATTERY POWER Switch:

This switch selects the operational power source (battery or Line Power). The CHARGE position provides full-rate battery charging when the power is connected and the front panel power switches are at ON and NORMAL.

REAR PANEL ITEMS (Cont'd)

Data Output Connection	The facilities provided by this 28-way connector are listed in Table 1 on page Tech. Spec (9).
Marker 'A' and 'B' Output Pins:	The pins Marker A and Marker B allow the user to monitor the state of the Schmitt triggers in the Channel 'A' and 'B' d.c. amplifiers.
Start Inhibit Pin:	A logical '0' applied to this pin inhibits the Start channel, allowing unwanted signals to be rejected.
Power Plug:	A three-core power cord is supplied with the instrument to mate with this connector.
Power Fuse:	Fuse ratings are marked on the rear panel. A surge resisting 5 x 20 mm glass cartridge type must be used.
Osc. Adjust:	This aperture provides access to the calibration adjustment in the frequency standard unit.
Voltage Selection Switch:	This switch has two positions, A and B. It must be set in conjunction with selectedappings on the line power transformer. Instructions are given in Chapter 2. It is essential that the label adjacent to the switch shows the voltage range selected.
1 MHz O/P Socket:	A TTL 1 MHz reference signal derived from the frequency standard in use is available at this BNC socket.

CHAPTER 4

OPERATING INSTRUCTIONS

POWER SUPPLY

4.1 Line Power: Before operating a new instrument or at a new location check that the line voltage selection and fuse rating are correct (see rear panel label). Set the rear panel switch to LINE POWER. When batteries are fitted trickle charging will occur.

Battery Supply (Option): Set the rear panel switch to BATTERY POWER. Set the POWER switch to ON and verify that the BATTERY LOW indicator is not illuminated.

FREQUENCY MEASUREMENT

4.2 In this mode the unknown frequency is gated to the counter decades for the gating period selected by the chosen Time Base push-button. For frequencies below 10 kHz the use of period mode will give greater resolution.

- (1) Set the POWER switch to ON and NORMAL/STANDBY switch to NORMAL.
- (2) Set the following controls:-
 - (a) Function switch to FREQUENCY - 'A'.
 - (b) AC/DC switch to AC or DC, as required.
 - (c) If using A.C. mode set the SENSITIVITY control initially to the maximum clockwise position.
 - (d) If using D.C. mode set the same control to the '0' (switched) position (fully anti-clockwise). Set the 'A' attenuator switch (X1/X10) as required.
 - (e) CHECK/OPERATE/HOLD switch to OPERATE.
- (3) Connect the unknown signal to the 'A' input socket. Ensure that there is no external connection made to the 'B' input.
- (4) Select the required Time Base ('n') push-button. (See Table 5).
- (5) If using AC mode adjust the SENSITIVITY control anti-clockwise to obtain stable counting. If on DC mode adjust the same control for the required d.c. triggering level.
- (6) Switching to HOLD stops the automatic updating of the display. Press and release the RESET button to obtain a single-shot update.

TABLE 5
Time Base Range Selection (Frequency Mode)

Frequency Gate Time	Multiplier 'n'	Resolution
1 ms	1	1kHz
10 ms	10 ¹	100 Hz
100 ms	10 ²	10Hz
1s	10 ³	1Hz
10s	10 ⁴	0.1Hz
100s	10 ⁵	.01Hz

Overflow Procedure

4.3 To obtain high resolution when measuring higher frequencies it may be advantageous to "overspill" one or more of the left-hand digits. First of all, select a short gate time and record the most significant digits displayed, then select a time base button giving a longer time to display the less significant digits to the required resolution.

PERIOD MEASUREMENT

4.4 This mode is recommended for measuring low frequencies in the range 10Hz to 10kHz with improved resolution. The incoming unknown signal is taken to the time base decade dividers, the output of which (selected by the Time Base (n) push-button) gates the internal reference frequency to the counter decades. The display indicates the actual value of the period of the incoming signal in microseconds. Greater accuracy is obtained by selecting a longer time base range thus taking the measurement over a greater number of periods.

Period Operation

- 4.5 (1) Set the POWER switch to ON and NORMAL/STANDBY switch to NORMAL.
- (2) Set the following controls:-
- (a) Function switch to PERIOD 'A'.
 - (b) AC/DC switch to AC or DC, as required.
 - (c) If using AC mode, set the SENSITIVITY control initially to maximum clockwise.
 - (d) If using DC mode set the same control to zero offset, '0' (switched) position. Set the 'A' attenuator (X1/X10) switch as required.
 - (e) CHECK/OPERATE/HOLD switch to OPERATE.

- (3) Connect the unknown signal to the 'A' input socket. Ensure that there is no external connection made to the 'B' input.
- (4) Select the number of cycles to be timed by depressing the relevant Time Base 'n' button. A greater number of cycles give enhanced resolution, but longer measuring time.
- (5) If on AC mode adjust the SENSITIVITY control anti-clockwise for stable counting. If on DC mode adjust the same control to required DC offset. For zero offset set the control to '0' (switched) position.
- (6) If on HOLD, press and release the RESET button for a single shot reading.

TIME INTERVAL (T.I. and T.I. Average)

4.6 In this mode the instrument is effectively serving as a stop-watch by counting clock pulses derived from the frequency standard. The time interval may be controlled by successive events on a single line (such as pulse widths) in which case Input 'B' is used with the Stop Channel (A/B) Selection switch set to 'B'.

4.7 For timing events on separate lines the Stop Channel Selection switch must be set to 'A'. The 'start' signal is applied to the 'B' input and the 'stop' signal to the 'A' input. Trigger slopes can be selected by the START/STOP slope switches. Unwanted stop signals can be inhibited by use of the HOLD OFF control.

4.8 The T.I. mode is most suited to the measurement of single intervals such as pulse widths. A range of widths from 100 ns to several hours may be measured by selecting the appropriate clock unit. The maximum clock rate is 100 ns, therefore resolution on short duration pulses is likely to be unsatisfactory, but can be improved by the use of T.I. Average mode, which increases resolution by the averaging of the inherent ± 1 count 'gate uncertainty' factor over a number of time intervals (1 to 10⁵). It should be noted, when time averaging, that the repetition rate of the pulses under measurement must not be harmonically related to the frequency standard in use.

Time Interval Operation

- 4.9 (1) Set the POWER switch to ON and NORMAL/STANDBY switch to NORMAL.
- (2) Set the following controls:-
- (a) Function: depress the T.I. or T.I.Avg button, as required.

- (b) HOLD OFF control to OFF, or as required.
 - (c) Stop Channel Selection switch: for single line select B; for double line select A.
 - (d) AC/DC switch to DC for double line measurement.
 - (e) START and STOP switches: select required triggering polarities. (Not required for manual timing).
 - (f) Attenuators (X1/X10) as required.
 - (g) CHECK/OPERATE/HOLD to OPERATE.
- (3) Connect the input (s). For single line timing connect the external signals to Input 'B'. For double line connect the 'start' line to 'B' and the 'stop' line to 'A'.
 - (4) Press the Time Base ('n') button which provides the appropriate readout. One of the l.e.d. indicators will illuminate to indicate the units of the display.
 - (5) For manual timing press the START/STOP push-button as required (on T.I. only).
 - (6) If operating on HOLD press and release the RESET button to initiate a new (non-manual) timing process.

$$\text{RATIO } n \frac{A}{B}$$

4.10 In this mode, two unknown signals are fed to inputs 'A' and 'B'. Generally the higher frequency is fed via input socket 'A' to the counter decades and the lower frequency is fed through input socket 'B' to the time-base decades, but this input arrangement may be reversed, as for example, when the lower frequency has a smaller amplitude (e.g. 10mV) and the higher frequency a considerably larger amplitude. The display indicates the ratio $n \frac{A}{B}$ and the reading must be divided by the factor 'n' to obtain the ratio $\frac{A}{B}$.

Ratio Operation

- 4.11 (1) Set the POWER switch to ON and NORMAL/STANDBY switch to NORMAL.
- (2) Set the following controls:-
 - (a) The FUNCTION switch to RATIO $n \frac{A}{B}$.
 - (b) The 'A' channel AC/DC switch to AC or DC as appropriate.
 - (c) HOLD OFF control to OFF.
 - (d) CHECK/OPERATE/HOLD switch to OPERATE.
- (3) Connect the input signals to sockets 'A' and 'B'. (See para. 4.10).
- (4) Set TRIGGER LEVEL controls as required.
- (5) Press the Time Base ('n') button which gives a full display without overspill.
- (6) If operating on HOLD press and release the RESET button for a new reading.
- (7) To obtain the true ratio the displayed reading must be divided by the factor 'n' indicated above the selected Time Base button.

$$\text{TOTALIZE } \frac{A}{n}$$

4.12 In this mode, signals on input socket 'A' are prescaled and taken to the counter decades. The count can be controlled manually by the START/STOP button, or electrically by timing signals connected to the socket 'B'. This mode permits a number of events occurring with random timing to be counted over a chosen period.

Totalize Operation

- 4.13 (1) Set the POWER switch to ON and NORMAL/STANDBY switch to NORMAL.
- (2) Set the following controls:-
- (a) The Function switch to TOTAL $\frac{A}{n}$.
 - (b) The Stop Channel Selection switch to 'B'.
 - (c) The attenuators (X1/X10) as required.
 - (d) The AC/DC switch to DC.
 - (e) HOLD OFF switch to OFF, or as required.
 - (f) CHECK/OPERATE/HOLD switch to OPERATE.
 - (g) The START and STOP switches to select the required trigger edge polarities.
- (3) Connect the signal to be totalized to socket 'A' and the electrical timing signals (if used) to socket 'B'.
- (4) Press the Time Base button which will provide suitable units for the count. For example, if the $n = 10^3$ switch is depressed the display will be in units of 1000 (within the accuracy of measurement).
- NOTE: If the $n = 1$ switch is depressed a count of 1 will be displayed initially when the main gate opens).
- (5) Set the TRIGGER LEVEL controls as required.
- (6) If operating on HOLD, press and release the RESET button for a single shot reading.
- (7) If manual control is required, press the START/STOP button to commence counting and again to terminate counting.
- (8) In order to obtain the true total the displayed reading must be multiplied by the scaling factor 'n' indicated above the selected Time Base push-button.

BATTERY ECONOMY OPERATION

- 4.14 (1) Prepare the instrument for battery power supply (para.4.1) and normal measurement.
- (2) Set the POWER switch to ON and NORMAL/STANDBY switch to STANDBY. Briefly press the RESET button. The instrument will operate for approximately one minute and then revert to standby as indicated by the Overflow/Standby l.e.d. To repeat the operation press RESET when required.

STANDBY OPERATION WITH AC POWER

- 4.15 The operation described in 4.14 (2) can be used with line powered instruments. It may be noted that if the unit is switched from NORMAL to STANDBY within one minute of switching on, the display will remain on for a brief period before settling into the 'display off' standby condition.