

# Digital Voltmeter 7075

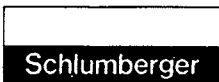

Part No. 70750011

Issue 3, January 1978



THE SOLARTRON ELECTRONIC GROUP LIMITED  
FARNBOROUGH HAMPSHIRE ENGLAND GU14 7PW  
TEL: FARNBOROUGH 44433 (STD 0252)  
CABLES: SOLARTRON FARNBOROUGH HANTS  
TELEX: 858245 SOLARTRON FARNBOROUGH

## TECHNICAL MANUAL



# CONTENTS

<b>SECTION 1</b>	<b>GENERAL DESCRIPTION</b>	1.1
	Safety	1.2
	Front Panel	1.3
	Rear Panel	1.4
	Controls	1.5
	Input Connector	1.7
	Display	1.9
	Rack Mounting	1.9
<b>SECTION 2</b>	<b>SPECIFICATIONS AND GENERAL INFORMATION</b>	
<b>SECTION 3</b>	<b>OPERATING INSTRUCTIONS</b>	
	Preliminaries	3.1
	Operation	3.2
<b>SECTION 4</b>	<b>MEASUREMENT TECHNIQUES</b>	4.1
	Input Resistance	4.1
	Input Current	4.2
	Interference Rejection	4.3
	Series Mode	4.4
	Common Mode	4.6
	Integration Time	4.9
	A.C. Measurement	4.10
	Resistance Measurement	4.12
	Ratio Measurement	4.14
<b>SECTION 5</b>	<b>SERVICING</b>	5.1
	Presentation of Information	5.1
	Principles of Operation	5.3
	Functional Description	5.4
<b>SECTION 6</b>	<b>CIRCUIT DESCRIPTIONS</b>	6.1
	Analogue Introduction	6.1
	D.C. Input	6.3
	Input Amplifier	6.5
	D.C. Ranging	6.7
	V to t Convertor	6.9
	A.C. Conversion	6.13
	Resistance	6.15
	Reference	6.17
	Floating Logic	6.19
	Self Test	6.20
	Integrator Control	6.21
	Power Supply	6.23
	Digital Introduction	6.27
	Counters and Memory	6.29
	Control Logic	6.33
	The Display, Display Drive and Phase Locked Clock	6.41

	Circuit diagrams	
	Pcb 1	6.44
	Pcb 2	6.41
	Pcb 3	6.33, 6.40
	Pcb 4	6.29, 6.32
	Pcb 5	6.4, 6.6, 6.8 6.10, 6.14, 6.18
	Pcb 6	6.16, 6.22
	Pcb 7	6.24, 6.25
	Pcb 10	6.15
	Pcb 11	6.40
	Pcb 12	6.12
	Pcb 13	6.23
	Mainframe	6.23
<b>SECTION 7</b>	<b>PARTS LIST</b>	<b>7.1</b>
	Pcb 1	7.2
	Pcb 2	7.2
	Pcb 3	7.2
	Pcb 4	7.3
	Pcb 5	7.4
	Pcb 6	7.6
	Pcb 7	7.7
	Pcb 10	7.7
	Pcb 11	7.8
	Pcb 12	7.8
	Pcb 13	7.8
	Main Assembly	7.8
<b>SECTION 8</b>	<b>SETTING-UP AND CALIBRATION</b>	
	Introduction	8.1
	Test Equipment	8.2
	Part 1 - Setting-up Procedures	8.2
	Part 2 - Calibration Procedures	8.14
<b>SECTION 9</b>	<b>PARALLEL BCD INTERFACE UNIT 70754</b>	
	Connection	9.1
	Logic Levels	9.1
	Input Information	9.2
	Output Information	9.5
	Timing Diagram	9.8
	Connector Tables	9.9&9.10
	Parallel BCD Interface Unit	9.12
	Circuit Description	9.13
	Board 1 (Pcb 21)	9.13
	Board 2 (Pcb 22)	9.15
	Board 3 (Pcb 23)	9.17
	Parts List (Pcb 21)	9.19
	(Pcb 22)	9.19
	(Pcb 23)	9.19
<b>APPENDIX</b>	<b>Introduction</b>	<b>A2</b>
	General Description	A2
	Calibration Cover 70759D	A3

Solartron pursue a policy of continuous development and product improvement. The specifications in this document thus may be changed without notice.

# SECTION 1

# General Description

The 7075, with its simple to use controls and clear, easy-to-read display enables the most inexperienced user to discover that precise digital measurement is now within his grasp.

Automatic range selection means that there is, basically, only one operator decision to be made - that of the quantity to be measured : dc volts, ac volts or resistance. The instrument instantaneously evaluates the order of magnitude of the applied input and selects the appropriate range.

**Ranging Points:**            Range-up > 140 000 digits reading.  
(5 x 9's)                    Range-down < 12 000 digits reading.

N.B. Excessive series mode signals may cause range-up to occur earlier.

The facilities available are those of:-

DC Voltage	continuous range from 1 $\mu$ V to 1kV
AC (RMS) Voltage	continuous range from 1 $\mu$ V to 750V rms (1.1kV Peak).
Resistance	continuous range from 1m $\Omega$ to 14M $\Omega$

**True rms measurement:** many instruments in the past presented the mean value of an alternating quantity or if rms value was displayed, it was arrived at by some method of 'doctoring' the mean value actually measured. The disadvantage of that system is that validity of the reading is very much dependent on waveform shape, only a pure sinusoidal input giving acceptable results.

The 7075 is a true rms measuring instrument, in which the input is directly converted to its root mean square at the measurement stage. The displayed reading, therefore, is the precisely computed rms value of the alternating quantity being measured.

A twelve decade display is used, bright and sharply defined, no extraneous light being permitted to degrade the displayed reading. The fixed decimal point and unique grouping of the displayed digits makes possible an instant appreciation of the order of magnitude of the reading thus obviating the need for multiple and submultiple unit annunciators.

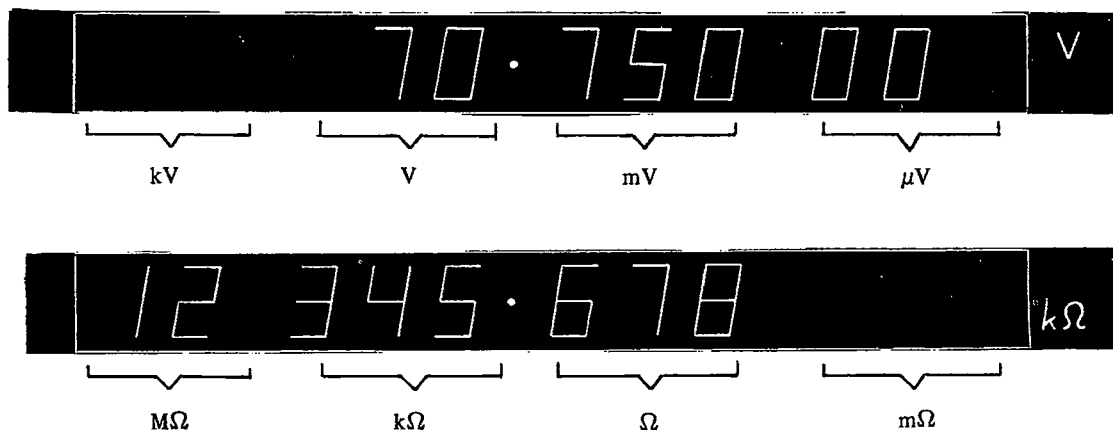

Scale length from 3 x 9's to 7 x 9's can be selected by the user, the above being typical 7 x 9's displays.

The display 'moves' to the right as the applied input reduces in magnitude; leading zeros, except that to the immediate left of the decimal point, are suppressed; and if the quantity is negative the minus sign travels with the display always maintaining its position immediately to the left of the most significant whole digit.

The new conversion technique used is capable of obtaining linearities two orders better than those possible using dual ramp and related techniques. An important property of this method is that the applied input is being continuously averaged. Together with the very fast autoranging system, this feature makes conventional filters, with their associated problems, unnecessary. A new exclusive digital filtering technique is utilised whereby the difficulty that used to be associated with low frequency ac measurement has, with the 7075, become a thing of the past.

Operator confidence is increased by a self check facility. At the touch of a button the instrument can be commanded to carry out a series of tests designed to prove the correct functioning of all its circuits, displaying the result of each check instantaneously.

## SAFETY

Your 7075 has been carefully engineered with ease of use as one of the primary considerations. Attention has also been given to making the instrument immune to most inadvertent overloads and to ensuring operator safety. However it should be appreciated that even the most sophisticated of measuring instruments can be dangerous when connected to high voltages, unless elementary safety precautions are observed.

The voltage limit of 1.1kV means that no damage will be caused to the instrument at this level of input. Other than the displayed reading, however, no indication is given to the user that a voltage of such a magnitude is present at the input terminals. Care should therefore be exercised whenever the dvm input leads are being connected to/removed from live circuits, especially where high voltages are known to exist or high transients could occur.

Similarly, when using the instrument on mains operated equipment capable of delivering high voltage outputs, it is strongly recommended that the equipment under test is NOT switched off with the dvm still connected. For example, consider the 7075 connected across the secondary winding of a large mains transformer. The instrument's very high input resistance is such that, in the event of the mains supply being interrupted, the resultant back emf induced in the undamped secondary could be of the order of 100kV. This is obviously hazardous to the user and would certainly harm the voltmeter.

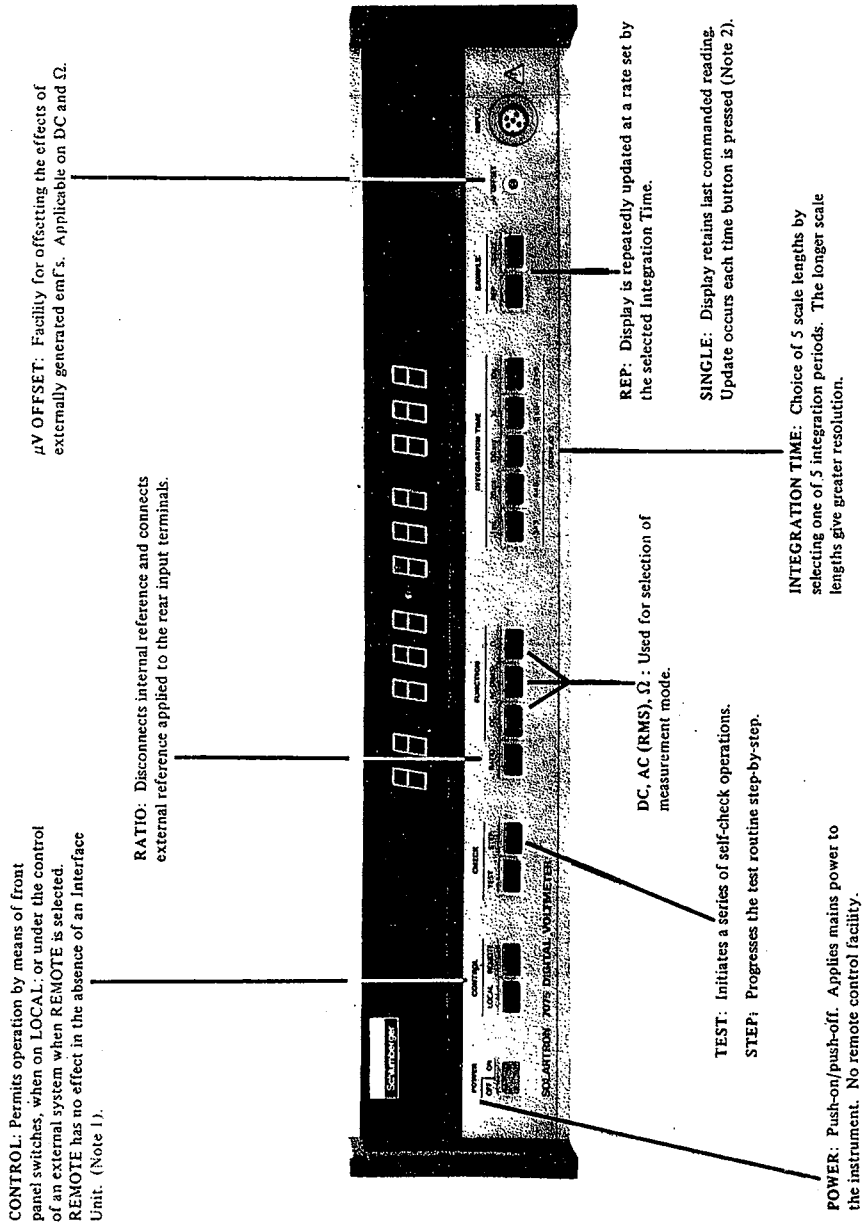

**NOTES**

1. An external command from the Interface Unit, FRONT PANEL LOCKOUT, can be used to inhibit all front panel controls (except POWER).
2. When in SINGLE operation, changes of FUNCTION or INTEGRATION TIME will not be implemented until the SINGLE button is again pressed.

**CONNECTOR SOCKET SKI** for use with Systems Interface Unit or data processing options.

**EXTERNAL REFERENCE** terminals used only for RATIO measurement.

**POWER INLET SOCKET.** No voltage tapping are required over the stated range.

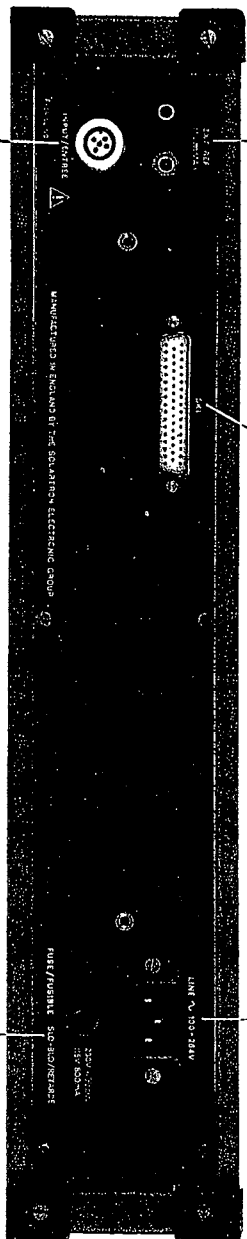

**REAR INPUT SOCKET** wired in parallel with normal front input.

**SUPPLY FUSE:** 800mA value for both 115V and 230V supply voltage.



## CONTROLS

The push button controls are arranged in groups in accordance with the decisions which have to be made for any measurement.

### 1. POWER



This mains switch operates with a push on - push off action and is clearly marked to indicate whether on or off. The display is always illuminated when the instrument is switched on, thus obviating the need for separate button illumination. The switch cannot be remotely controlled, however remote switch-off can be achieved by interrupting the power supply.

### 2. CONTROL

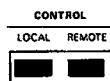

With the (optional) interface unit fitted, selection of LOCAL inhibits the effect of all remote command inputs except FRONT PANEL LOCKOUT (a command signal from the interface unit) and control is via the front panel push buttons. When REMOTE is selected all functions except SAMPLE are controlled by remote command inputs (see Section 5), the remaining three groups of push-buttons being disabled. With no interface unit fitted selecting REMOTE has no effect.

### 3. CHECK

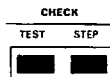

When TEST is selected the Self Test programme is initiated, designed to check the overall function of the instrument. Progression from one test to the next is effected by pressing the STEP button. The 5 tests check the function of:-

- |                                      |                                                  |
|--------------------------------------|--------------------------------------------------|
| 1. The DC Measurement system         | Should display 7V DC $\pm$ 0.005V                |
| 2. The A - D converter internal zero | Should read zero $\pm$ 0.0002V                   |
| 3. The AC converter                  | Should display 10V AC $\pm$ 0.01V                |
| 4. The Ohms converter                | Should display 10k $\Omega$ $\pm$ 0.02k $\Omega$ |
| 5. The Display                       | Should display a "full house" of eleven 8's.     |

### 4.a. RATIO



This push on - push off switch, when selected, replaces the internal reference with the user's choice of external reference applied to the terminals on the Rear Panel. A suitable reference voltage between 2 and 11 volts should be used. This function is not available with resistance measurement. N.B. It is important to disconnect any external reference supply when not making Ratio measurements.

### b. FUNCTION

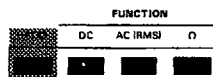

These three push buttons are mechanically linked, mutually exclusive and left-justified electronically. The mechanical linkage ensures that, barring misuse, selection of one switch automatically disengages any other which had previously been selected. Should accident or misuse result in the forcing in of two of these buttons simultaneously, left-justification causes the left hand one of the pair to be the function selected electronically.

## 5. INTEGRATION TIME

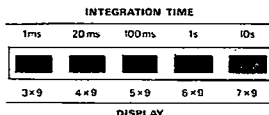

Each push button selects one of five available measurement times and, as can be seen from the legend below the switches, causes the display length to vary between  $3 \times 9$ 's and  $7 \times 9$ 's. The switches are of the mutually exclusive mechanically linked type with left justification as described above (4b).

The tables in Section 2 show the results of varying integration time. It should be particularly noted here, however, that when the longer integration times are used, there is a finite delay between successive updatings of the reading. This lengthening of the conversion time is true for both REP and SINGLE operation. During the delay any alteration the operator might make to the front panel controls will not be effective.

For more detailed information on the significance of integration time, the user is referred to Section 4 (Measurement Techniques).

## 6. SAMPLE

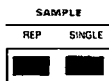

When REP is selected (i.e. normal operation) the instrument makes repeated readings at the rate determined by the selected Integration Time, each reading updating the display. When SINGLE is selected the display presents the next complete reading, and holds it. Updating of the displayed information is achieved by a further pressing of the SINGLE button, which initiates one further measurement. As a safety precaution the autorange circuits will still cause range-up while SINGLE is selected and overload protection remains operative. However care must still be exercised to ensure that the specified limits of input for the displayed mode of operation are never exceeded.

## 7. $\mu$ V OFFSET

The instrument's internal zero is extremely stable and no operator adjustment is necessary. The  $\mu$ V OFFSET is provided to 'back-off' any small disturbances to the instrument zero which might be generated externally to the dvm. In those applications where, for example, thermal effects generated in the external circuit could be of significance and degrade the measured result, use of the  $\mu$ V offset will provide a correction of approximately  $\pm 10\mu$ V.

## FRONT PANEL LOCKOUT

Not apparent from the front panel legends is a facility known as Front Panel Lockout. Under the control of an external electrical command applied via the optional interface unit the action of all front panel controls, except POWER, can be inhibited. This command signal even disables "LOCAL" and can be used to prevent unauthorised use of the dvm when it is committed within a system or, with suitable remote programming, enables a test sequence to include both automatic and manual control.

## INPUT CONNECTOR

The input connector simply pushes into the front panel socket with a 'snap-in' action. This cannot be released by pulling on the cable, but separation occurs when the skirt of the connector is pulled away from the panel.

The skirt of the connector acts as an isothermal chamber thus preventing errors which could otherwise result from temperature differentials across the input terminals.

Three types of input lead are available as follows:-

(a) 2 Way Lead (supplied as standard).

This input lead may be used for all standard measurements. The RED lead is connected to HiV and should be used as Hi, normally at the largest potential with respect to earth. The BLACK lead is connected to LoV and provides the return path. The 2 cores are enclosed in a braided screen which is connected to Guard. At the free-end of the cable, this screen is connected to the black lead thus effectively preserving the guard right up to the signal source. This prevents the measurement being affected in any way by common mode current flowing in the screen and via leakage to earth. The input may be floated above mains' earth by up to 500V, the use of higher common mode voltages is not recommended purely to ensure safety for equipment and the user. The guard is not made available as a separate termination.

(b) 3 Way Lead

In some rare measurement situations, common mode voltages can have an affect on the readings. Most users will never encounter the problem, but those who do can still eliminate error by using this lead which has 2 cores and a screen which is available to the user. The RED should be used for Hi and the BLACK for Lo as above. The screen is available as Guard and colour-coded GREEN.

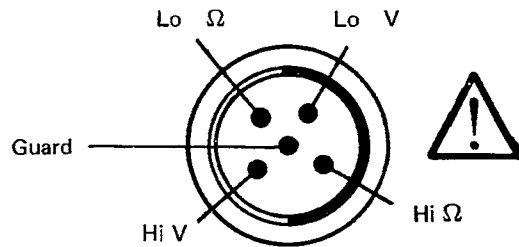

Input connector socket, showing pin identification (front panel view).

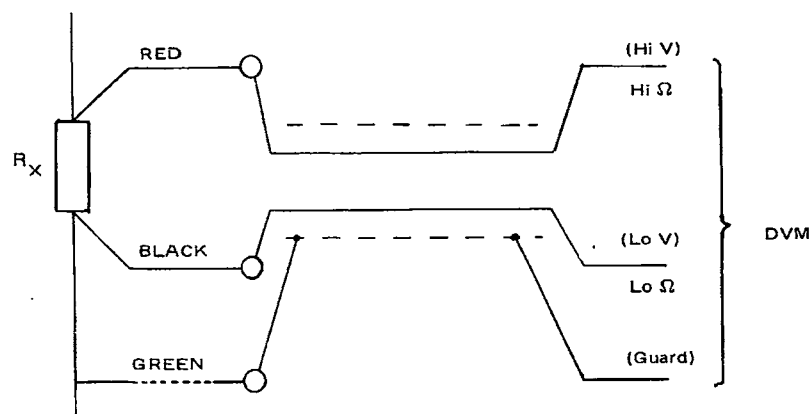

Note. In both (a) and (b) Hi $\Omega$  and Lo $\Omega$  are internally connected within the lead to HiV and LoV respectively. The same lead can thus be used for both voltage and resistance measurement.

When the 3-way lead is not being used as illustrated the GREEN wire should be connected to Lo (BLACK).

(c) 5 Way Lead

This lead has 4 cores and a screen which is available to the user. The RED lead is connected to HiV, the BLACK lead to LoV, the YELLOW to Hi $\Omega$ , the BLUE to Lo $\Omega$  and the GREEN to GUARD.

When measuring low values of resistance, the voltage dropped along the leads can sometimes introduce errors. This effect may be eliminated by employing the 4 wire technique in which two wires supply the current to the resistor and two others sense the potential developed across it.

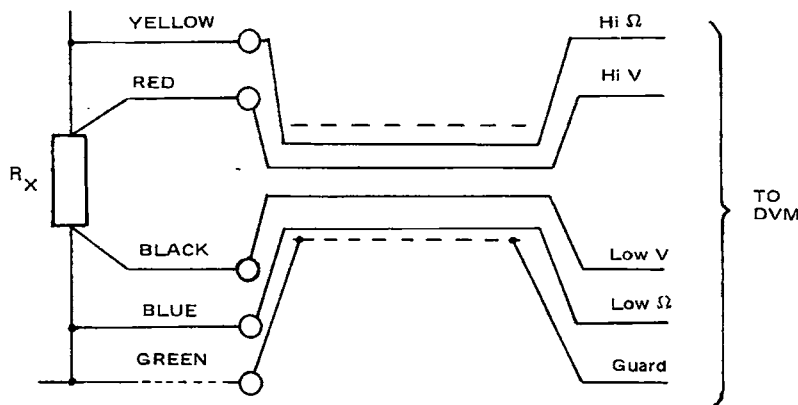

The example shows the correct method of using the lead, the order of connections is important, i.e. the RED and BLACK leads should be as close to the resistor as possible. The GREEN (guard) may be used as previously detailed to reduce common mode interference if this introduces errors.

These and other leads are available to order as Optional Accessories. (see full Accessories List Section 2).

To preserve the integrity of readings obtainable with this instrument it is recommended that only copper connecting clips, as supplied, are used with the input connector.

**Rear Input**

A rear input socket is fitted as standard, wired in parallel with the normal front input. This is provided as an alternative (e.g. in rack mounting use of the instrument) and connections should never be made to both front and rear input sockets.

N.B. The symbol which appears in places on the instrument of an exclamation mark enclosed within a triangle, , is an indication to the user that reference should now be made to relevant sections of this book.

A pull-out instruction card, repeating the basic operating parameters, is mounted below the front panel.

## DISPLAY

The display area is covered by a tinted screen laminated with a circularly polarised membrane to inhibit stray light or reflected light which might otherwise reduce the clarity of the reading. The front surface is lightly frosted to eliminate surface reflection from overhead lights or light coloured garments worn by the user. Very slight de-focussing results from this frosting.

The reading is updated at the selected integration rate or on pressing the SINGLE button as described earlier.

From left to right the displayed information is:-

- (a) **RATIO** Selection of RATIO operation illuminates this legend.
- (b)  $\sim$  This sign is displayed when AC (RMS) is selected.
- (c) **Numerical Indication.** Plasma discharge tubes are used to present the result of measurement. The numerals are grouped in threes, for ease of reading.
- (d) **Decimal Point.** This is a fixed point, floating display instrument, leading zeroes being suppressed.
- (e) **Units.** V and k $\Omega$  annunciators are illuminated as a result of selecting the required mode of measurement with the FUNCTION buttons.
- (f) **REMOTE** An indication that the instrument is under REMOTE control - only applicable when the (optional) interface unit is fitted.

**BUSY** Should this legend be illuminated it advises the operator that the reading currently being displayed should be regarded as invalid. The legend is extinguished when the new result is displayed. The BUSY signal has the additional function of inhibiting the front panel push buttons. Thus once a command has initiated a measurement, the instrument will not abort that reading.

## INVALID READINGS

In addition to 'BUSY' described above, an indication that a reading is invalid is that of a flashing display. Normally this occurs as a result of an overload on the range in use. Notwithstanding this automatic warning, the user is reminded that the limits of input specified should never be exceeded.

The limits are:-

- DC** 1100V DC
- AC** 750V RMS (1100V Peak)  
above 20kHz limit is 200V RMS  
400V dc when on AC

N.B. These limits only apply to LOCAL operation - for details of limits applicable when instrument is under REMOTE control see Technical Specification and Section 5.

## RACK MOUNTING

The overall dimensions conform to international standards for rack mounting. The instrument can if desired be rack mounted within its case, no additional protection being necessary. Users who so wish can remove the covers which are simply secured by four screws. For rack mounting either the handle-less rack mounting fittings, or the combination handle/ears should be substituted for the normal handles. Rack mounting fixtures of both types are included in the accessory pack supplied with the voltmeter, (See Accessories list in Section 2).



This section contains a copy of the technical specification applicable to the voltmeter.

The 7075 has been designed and manufactured to the highest specification possible for an instrument of its type. Where typical figures are quoted, they are realistic estimates of obtainable performance based on known component tolerances and stability. Guaranteed performance, on the other hand, is specified from the results of exhaustive tests, stringently controlled, applied to every instrument produced. "Worst-case" figures are quoted in many instances, hence your 7075 may be found to exhibit a performance better in some particulars than the tables suggest. However no additional claims are made for the instrument above that published in the current data sheet.

## SPECIFICATIONS

Manufacturers calibration temperature 20°C.

**Table 1** GUARANTEED PERFORMANCE 1s Integration

Nominal Range	Input Sensitivity	Displayed Full Scale	Limits of Error						Input Resistance	
			24 hrs ± 1°C ± [% rdg. + % f.s.]		6 mnth ± 5°C ± [% rdg. + % f.s.]		1 yr ± 5°C ± [% rdg. + % f.s.]			
10mV	1μV	0.013 999V		0.007		0.007		0.007		> 10GΩ
100mV	1μV	0.139 999V	0.0014	0.0014	0.002	0.0014	0.003	0.0014		> 10GΩ
1V	1μV	1.399 999V	0.0006	0.0004	0.002	0.0008	0.003	0.001		> 10GΩ
10V	10μV	13.999 99 V	0.0003	0.0002	0.0015	0.0005	0.002	0.0008		> 10GΩ
100V	100μV	139.999 9 V	0.0007	0.0005	0.003	0.0008	0.004	0.001		10MΩ
1000V	1mV	1 000.000 V	0.0007	0.0007	0.003	0.0008	0.004	0.001		10MΩ

**Table 2** TYPICAL PERFORMANCE 10s Integration

Nominal Range	Input Sensitivity	Displayed Full Scale	Limits of Error						Input Resistance	
			24 hrs ± 1°C ± [% rdg. + % f.s.]		6 mnth ± 5°C ± [% rdg. + % f.s.]		1 yr ± 5°C ± [% rdg. + % f.s.]			
10mV	1μV	0.013 999V		0.007		0.007		0.007		15GΩ
100mV	1μV	0.139 999V		0.0007	0.001	0.0007	0.0015	0.0007		20GΩ
1V	1μV	1.399 999V	0.0004	0.00015	0.001	0.0003	0.0015	0.0005		200GΩ
10V	1μV	13.999 999V	0.00015	0.0001	0.0005	0.00025	0.001	0.0004		1000GΩ
100V	10μV	139.999 99 V	0.0005	0.0002	0.0015	0.0005	0.002	0.0007		10MΩ
1000V	100μV	1 000.000 0 V	0.0005	0.0003	0.0015	0.0005	0.002	0.0008		10MΩ

### Reduced scale lengths

Scale Length	Integration Time	Input Sensitivity	Limits of Error [1 year ± 5°C]
5 x 9	100ms	1μV	± 0.004% rdg. ± 1 digit ± 1μV
4 x 9	20ms	1μV	± 1 digit ± 1μV
3 x 9	1ms	10μV	± 1 digit ± 10μV

### Temp. coeff.

Range	< ± [% rdg. + % f.s.] per °C	
10mV	0.0004	0.0015
100mV	0.0004	0.0002
1V	0.0004	0.0001
10V	0.0002	0.00007
100V	0.0005	0.0001
1000V	0.0005	0.0001

Zero offset < ± 0.2μV per °C

#### Input Current

Typically < 20pA at 20°C

#### Overload protection:

Autorange: 1.1kV

Commanded ranges:

up to 10V: 350V

100V & 1000V: 1.1kV

#### Linearity:

error due to non-linearity is less than 1ppm and is included in the above specification.

#### Temperature corrections:

need be applied only when operating beyond the temperature limits quoted under Limits of Error.



Manufacturers calibration temperature 20°C.

Performance guaranteed above 10% of f.s. (i.e. Range-change point)

**Table 3** 24 hrs at 20°C ± 1°C 1s integration

Nominal Range	Input Sensitivity	Displayed Full Scale	Limits of Error		
			10Hz to 40Hz	40Hz to 10kHz	10kHz to 100kHz
100mV	1µV	0.139 999V	± 0.3% rdg. ± 0.05% f.s.	± 0.05% rdg. ± 0.05% f.s.	± 0.5% rdg. ± 0.2% f.s.
1V	10µV	1.399 99 V			
10V	100µV	13.999 9 V			
100V	1mV	139.999 V			
1000V	10mV	750.00 <sup>§</sup> V	± 0.3% rdg. ± 0.1% f.s.	± 0.05% rdg. ± 0.1% f.s.	± 0.5% rdg. ± 0.4% f.s.

<sup>§</sup>Above 20kHz: 200V rms max.

**Table 4** 6 months at 20°C ± 5°C 1s integration

Nominal Range	Limits of Error		
	10Hz to 40Hz	40Hz to 10kHz	10kHz to 100kHz
100mV	± 0.4% rdg.	± 0.1% rdg.	± 0.5% rdg.
1V	± 0.08% f.s.	± 0.06% f.s.	± 0.2% f.s.
10V	± 0.4% rdg.	± 0.1% rdg.	± 0.7% rdg.
100V	± 0.08% f.s.	± 0.06% f.s.	± 0.2% f.s.
1000V	± 0.4% rdg. ± 0.08% f.s.	± 0.1% rdg. ± 0.1% f.s.	± 0.7% rdg. ± 0.4% f.s.

**Table 5** 1 year at 20°C ± 5°C 1s integration

Nominal Range	Limits of Error		
	10Hz to 40Hz	40Hz to 10kHz	10kHz to 100kHz
100mV	± 0.5% rdg.	± 0.15% rdg.	± 0.6% rdg.
1V	± 0.1 f.s.	± 0.1% f.s.	± 0.2% f.s.
10V	± 0.5% rdg.	± 0.15% rdg.	± 1.0% rdg.
100V	± 0.1% f.s.	± 0.1% f.s.	± 0.2% f.s.
1000V	± 0.5% rdg. ± 0.2% f.s.	± 0.15% rdg. ± 0.2% f.s.	± 1.0% rdg. ± 0.4% f.s.

## Other integration times

Time	Sensitivity	Scale Length	Min. Frequency*	Specification
10s	1µV	139 999	as Tables 3 to 5	as Tables 3 to 5
100ms	1µV	139 999	40Hz	as Tables 3 to 5
20ms	10µV	13 999	100Hz	add ± 0.01% f.s.
1ms	100µV	1 399	400Hz	add ± 0.1% f.s.

\* < 40Hz best performance is given by 1s or 10s integration.

## Temp. coeff.

Range	<± [% rdg. + % f.s.] per °C	
100mV	0.015	0.004
1V	0.015	0.004
10V	0.015	0.004
100V	0.015	0.004
1000V	0.015	0.004

### Overload protection:

100mV & 1V ranges: 350V peak  
 10V, 100V, 1000V ranges: 1.1kV peak  
 All ranges, above 20kHz: 200V rms

### Crest factor:

5: 1 at f.s.

### Input impedance:

at input socket: 1MΩ//< 150pF  
 of standard input cable: < 300pF

### Very low frequency measurement:

Useful readings can be made down to 1Hz with <1dB error by employing the 10s integration time.

### Temperature corrections:

need be applied only when operating beyond the temperature limits quoted under Limits of Error.

Manufacturers calibration temperature 20°C.

**Table 6** GUARANTEED PERFORMANCE 1s integration

Nominal Range	Input Sensitivity	Displayed Full Scale	Limits of Error						Measuring Current
			24 hrs ± 1°C ± [% rdg. + % f.s.]		6 mnth ± 5°C ± [% rdg. + % f.s.]		1 yr ± 5°C ± [% rdg. + % f.s.]		
10Ω	1mΩ	0.013 999kΩ		0.014		0.014	0.01	0.014	1mA
100Ω	1mΩ	0.139 999kΩ	0.001	0.002	0.003	0.002	0.005	0.002	1mA
1kΩ	1mΩ	1.399 999kΩ	0.002	0.0005	0.003	0.001	0.005	0.0015	1mA
10kΩ	10mΩ	13.999 99 kΩ	0.002	0.0003	0.0025	0.0008	0.004	0.001	1mA
100kΩ	100mΩ	139.999 9 kΩ	0.001	0.0005	0.003	0.001	0.006	0.0015	10μA
1MΩ	1Ω	1 399.999 kΩ	0.001	0.0003	0.003	0.001	0.006	0.0015	10μA
10MΩ	10Ω	13 999.99 kΩ	0.002	0.001	0.006	0.0015	0.008	0.0015	1μA

Maximum dissipation in unknown: 14mW    Maximum overload: 250V rms    Maximum Voltage, Lo current/Lo sense: 10V peak.

**10s integration time:** specification as above, but having one additional decade displayed on ranges 10kΩ and above.

## Reduced scale lengths

Scale Length	Integration Time	Input Sensitivity	Limits of Error 1 year ± 5°C
5 x 9	100ms	1mΩ	± 0.008% rdg. ± 1 digit ± 1mΩ
4 x 9	20ms	1mΩ	± 1 digit ± 2mΩ
3 x 9	1ms	10mΩ	± 1 digit ± 10mΩ

**Open circuit condition:**

A source resistance of 1000GΩ ensures full protection to external circuits.

## Temp. coeff.

Range	<± [% rdg. + % f.s.] per °C	
10Ω	0.0007	0.0015
100Ω	0.0007	0.0002
1kΩ	0.0007	0.0001
10kΩ	0.0005	0.00007
100kΩ	0.0007	0.0001
1MΩ	0.0007	0.0001
10MΩ	0.0012	0.0001

Zero offset <± 0.2mΩ per °C

**Temperature corrections:**

need be applied only when operating beyond the temperature limits quoted under Limits of Error.

## RATIO FACILITY

Reference Voltage: 2 to 11V  
 Input Resistance: Ref Hi to Ref Lo: 2 MΩ  
 Ref Hi to Sig Lo: 1.7MΩ  
 Ref Lo to Sig Lo: 1.7MΩ  
 Reference Overload: 100V peak differential  
 100V peak either terminal to Sig Lo.

**Limits of Error**

1 yr at 20°C ± 5°C: ± [Normal % rdg. + 0.005% rdg. + (Normal % f.s. + 0.005% rdg.)  $\frac{10}{V_{Ref}}$  ]

Temperature Coefficient: ± [Normal % rdg. T.C. + 0.001% rdg. + (Normal % f.s. T.C. + 0.001% rdg.)  $\frac{10}{V_{Ref}}$  ]

Ratio of peak interference to 1 digit reading error.

## Series mode

Maximum Series Mode:	Autorange:	1.1kV pk	
	Command Range:	$1.5 \times V_{\text{Range}}$	
DC Measurement:	Rejection of 50 (60) Hz $\pm$ 3%:	> 70dB	
Ratio Measurement:	Rejection of 50 (60) Hz $\pm$ 3% at Ref.:	> 40dB	

## Effective common mode

Measured with 1k $\Omega$ imbalance in Lo lead.			
Maximum Common Mode:			500V dc or peak ac.
DC Measurement:	Rejection of dc:		> 150dB
	Rejection of 50 (60) Hz $\pm$ 3%:		> 144dB
AC Measurement:	Rejection of dc:		> 150dB
	Rejection of 50 (60) Hz $\pm$ 3%:		> 74dB
Ratio Measurement:	Max. Common Mode		30V
	Ref. Hi or Lo to Sig Lo:		> 80dB
	Rejection of Sig Common Mode		
	Ref Lo to Sig Lo with up to 80 $\Omega$ lead imbalance:		

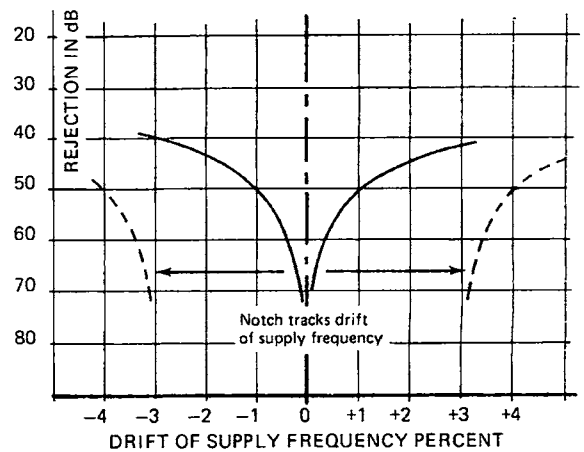
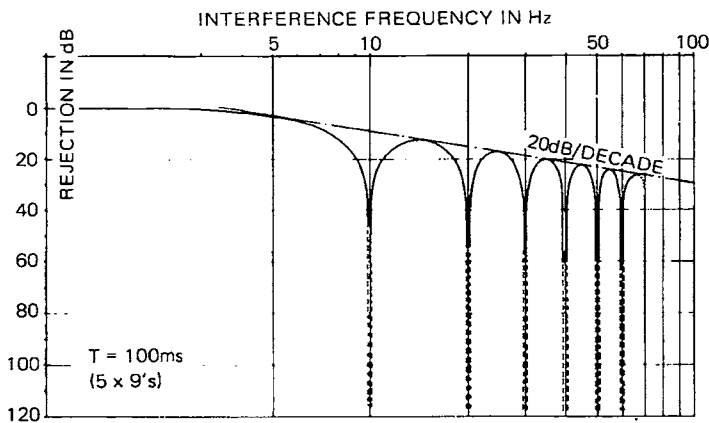

In the measurement of dc voltage 7075 gives the mean (average) value of the input during the chosen integration time. Except for 1ms, the times are multiples of the period of the mains supply. Hence the curves for interference rejection exhibit deep notches at discrete frequencies, those for 100ms shown above having a notch every 10Hz. By using the 10s integration the notches become spaced at only 0.1Hz intervals. Furthermore the tangent to the peaks, while retaining the slope of 20dB/decade, is spaced 20dB lower on 1s integration and 40dB lower on 10s integration.

The precise integration time is locked to the period of the mains supply by a digital servo. The notches move to right or left as supply frequency changes thus preserving maximum rejection up to a shift of  $\pm$  3%. This is beyond the limit of frequency deviation specified for the national grid.

## Environment

---

Working Temperature Range: 0 to + 50°C.  
Storage Temperature Range: -30 to + 70°C.  
Maximum Relative Humidity: 70% at + 40°C.  
Other specifications to Solartron spec. 50/01/102.

---

## Power supply

---

Voltage: 100 to 264V (no mains tap).  
Frequency: 50(60)Hz  $\pm$  3%. Internal switch provides optional  
400Hz operation. The instrument is capable of  
operating up to 2400Hz supply frequency.  
Consumption: Approx. 65VA (35W)  
Fuse 800mA Slo Blo

---

## GENERAL INFORMATION

### Dimensions

Width:	443mm (17.4ins)	Rack mounting depth,
Height:	89mm (3.5ins)	over interface + cable:
Depth:	465mm (18.3ins)	533mm (21ins).
Weight:	9.1kg (20lbs)	

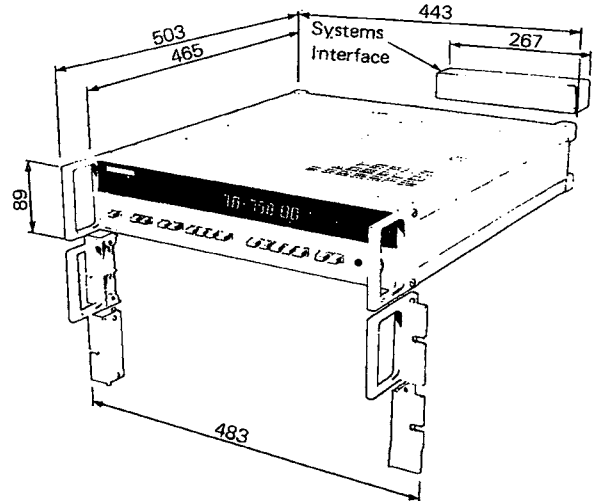

### Safety

This instrument conforms to IEC 348 recommendations.

### Accessories

Included Accessories		Part No.	Optional Accessories		Part No.
Input Cable		A2000168	Systems Interface (Parallel BCD)		70754A
Crocodile Clip (copper)		355901030	Systems Interface (IEC TC66/IEEE 488)		70755A
Test Probe	Red	351901020	High Voltage Probe		70757A
Test Probe	Black	351901010	3-Terminal input lead		3193
Spare fuse	800mA	360106310	5-Terminal input lead		3183
Mains cable		480140220	Telescopic Rack Slides (pair)		70759A
Rack mounting handles	(2 off)	429700101	ESI Kelvin clip leads (pair)		70758E
Rack mounting ears	(2 off)	469601201	Low thermal lead kit		70758D
Operating Manual		70750010	Master Series adaptor lead		70758G
Technical Manual		70750011	Service kit		70759C
			Calibration cover		70759D