

DIGITAL MULTIMETER 7140



Part No. 71400030

Issue 2 December 1977

Schlumberger

THE SOLARTRON ELECTRONIC GROUP LIMITED
FARNBOROUGH HAMPSHIRE ENGLAND GU14 7PW
TEL: FARNBOROUGH 44433 (STD 0252)
CABLES: SOLARTRON FARNBOROUGH HANTS
TELEX: 858245 SOLARTRON FARNBOROUGH

TECHNICAL MANUAL

19©75

Printed in England by The Solartron Electronic Group Ltd.

CONTENTS

		Page
SECTION 1	GENERAL INTRODUCTION	1.1
SECTION 2	OPERATION	
	Preliminary Adjustments	2.1
	Operation	2.1
SECTION 3	SERVICING	
	Introduction	3.1
	Presentation of Information	3.1
	Functional Description	3.2
	Circuit Description	
	Analogue	3a.1
	Digital	3b.1
	Power Supplies	3c.1
SECTION 4	SETTING UP AND CALIBRATION	
	Introduction	4.1
	Test Equipment	4.1
	Part 1 - Setting Up Procedures	4.2
	Part 2 - Calibration Procedures	4.7
SECTION 5	PARTS LISTS	
	PCB No. 1	5.2
	PCB No. 2	5.4
	PCB No. 3	5.5
	Main Assembly	5.5
	Accessories	5.5
SECTION 6	SPECIFICATION	6.1
APPENDIX		
	FET Selection Procedure	A.2
	Setting Up Case 70502	A.3

SECTION 1 General

INTRODUCTION

The 7140 Digital Multimeter (DMM) combines the advantages of a compact and versatile multimeter with the precision and convenience of a digital instrument. Automatic range selection and polarity decision give rapid readings. The complete absence of range switching enables the user to concentrate on the task in hand and apart from selecting the actual measurement mode required all other measurement decisions are undertaken automatically, so reducing the risk of damage to the user's equipment, as well as to the DMM.

The DMM covers the following measurement modes, all auto-ranging.

DC VOLTAGE

10 μ V - 1000V

AC VOLTAGE

10 μ V - 700V

RESISTANCE

100m Ω - 11M Ω

DC CURRENT

1nA - 1.1A

With a scale length of 109.99.

Model 7140 also incorporates an automatic over-range indication, automatic overload protection and automatic blanking of unused digits.

Model 7144 incorporates a digital output in parallel BCD form for use with printers and other output devices.

SECTION 2 Operation

This section provides all the necessary instructions concerning preliminary adjustments and operating procedures required to put the instrument into everyday use.

PRELIMINARY ADJUSTMENTS

Before using the instrument for the first time the following preliminary adjustments should be carried out:

(a) Check that the voltage selection switch on the rear panel is in the correct position.

(b) Check that the correct fuse is fitted as follows:-

230V	150mA	Slo-Blo	1¼" x ¼"
115V	300mA	Slo-Blo	1¼" x ¼"

(c) Connect a suitable connector to the input mains lead as follows:-

Brown	-	Line (Live)
Blue	-	Neutral
Yellow/Green	-	Earth

This earth connection is essential for stability of readings and user safety

(d) Plug into the mains supply and switch the instrument ON.

OPERATION

The operation of this instrument under most conditions will be found to be self-evident. The only operator decision required is the selection of the measurement mode required.

During operation, the following factors should be borne in mind:-

1. Since the instrument will automatically change ranges to suit the applied input potential, care should be taken to note the decimal point position in combination with the unit indicators.
2. In the event of an unintentional voltage or current overload, the offending potential should be removed as soon as possible since continuous overload may eventually cause damage to the instrument.
3. Due to the high input impedance of the input amplifier, the display readings will be random when the instrument is left with its input terminals as follows:-
 - (a) Open circuited on 'V.DC' and 'V.AC' modes.
 - (b) Short circuited on 'µA' and 'mA' modes.

Random readings can cause the range relay to switch on and off which can be prevented by short circuiting the input terminals in the case of (a) and open circuiting them in the case of (b).

4. In the ' Ω ' mode, open circuited input terminals produce an overload condition i.e. a steady '1' being displayed. Short circuited input terminals produce a nominal zero condition.
5. When measuring voltages on the lowest range and resistance on the highest range of the DMM, pick-up on the input leads may become a problem. If this occurs it is recommended that the leads be kept as short as possible and/or screened.

SECTION 3 Servicing

This section provides detailed servicing information for the instrument. Setting-up procedures and calibration are covered in Section 4.

INTRODUCTION

This Servicing Section is based on the functional block system of circuit diagrams, whereby components are grouped together to form a functional entity. A large scale block diagram is used to describe the overall operation of the Digital Multimeter (DMM). This diagram is then sub-divided to produce blocked circuit diagrams.

Information regarding circuit descriptions, component locations, printed circuit board layouts and any specific cautionary notes concerning components or testing procedures are arranged to be fully visible with the appropriate circuit diagram. Full calibration and setting up procedures are located in Section 4.

PRESENTATION OF INFORMATION

A brief glance through this section will reveal that the section is sub-divided into three major sub-sections, each of which deals with a major function in the DMM. Located within each section are block type circuit diagrams, always folding out clear to the right, with a functional description of each on the left hand text page. The pcb layout diagrams are arranged to fold out clear to the left, allowing cross reference between diagram and component location.

Referring to any of these diagrams, it can be seen that the major functional signal pathways are shown as bold lines, whilst those of a minor or control function are shown with thinner lines. The arrows indicate the direction of functional flow, which in the majority of cases will be from left to right of the diagram. Most feedback paths however, will flow from right to left.

These rules, although generally followed, are not rigidly adhered to where observance may cause ambiguity or is extravagant of space.

COMPONENT LOCATION

Diagrams of the printed circuit boards associated with each circuit diagram and photographs illustrating the method of access are reproduced in a manner enabling them to be examined in conjunction with the diagrams. By this method the physical position of any component can be quickly established:

COMPONENT NUMBERING

Each printed circuit has its own component numbering. This means that on a circuit diagram more than one component may be shown with the same component number. When this occurs care must be taken to ensure that the correct part is identified if it is required to replace the component. For instance, in the 7140 there are several pcb's, all of which include a component numbered R1.

The correct item must be identified from the parts list by reference to the pcb or assembly on which it is mounted.

POWER RAIL NOTATION

The power rails are shown as short detached bars with the nominal voltage annotated. On any one pcb, all bars annotated with the same voltage are electrically connected together and correspond to the appropriate rail notation shown on the power supplies circuit diagram, referenced 10.

The 0V rail in some cases is associated with the signal paths, annotated SIGNAL 0V and followed by a reference number 1 to 5 inclusive, thereby identifying the decoupling components used for that particular group of components. All identically referenced zero volt lines are electrically connected together at the 0V STAR POINT on pcb 1 (C18 -ve).

It must be remembered that the voltages shown are approximate, being proportional to the load taken through the appropriate decoupling resistors. A voltage reading which is inconsistent with the value given on the diagram should not, therefore, be taken as a symptom of unserviceability without reference to other indications.

ELECTRICAL CONNECTIONS

Electrical connections used are mainly of the Berg pin and socket type. Two plugs and sockets are employed using Berg pin/socket combinations. These are clearly identified, with all the remaining Berg pin/socket connections bearing only a number.

Transformer connections used are of the disconnect pin type.

SPLIT PADS

The split pads provide a means of adjusting circuit resistance and also for isolating various parts of the circuit during fault diagnosis.

They are short circuited by running solder across the gap and open circuited by removing the solder. Care should be taken not to apply excessive heat during these operations.

FUNCTIONAL DESCRIPTION

The Model 7140 Digital Multimeter (DMM) may be looked upon as an instrument which divides down into three major functional areas. These are shown as coloured areas in the adjacent KEY DIAGRAM.

This diagram should be looked upon as a pictorial index as within each of these coloured areas are further blocks, each referenced with a number which refers to a specific block/circuit diagram within each section of this manual.

It is important when using these diagrams that the information should be looked at from a functional view-point before dealing with any actual detailed servicing. That is to say, deduce what could be the problem before actually looking at specific circuit details.

With reference to the KEY DIAGRAM, the input signal is applied to an ANALOGUE signal processing section. The primary function of this block is to scale the input signal into a form suitable for use by the DIGITAL (A/D Converter) section.

The input signal in all cases is converted into a dc signal. Since the A/D Converter can only handle signals within the range 0-11V directly, the analogue section provides a 100/1 attenuation on the higher ranges.

The scaled analogue input is then converted into a digital form by means of the triple ramp technique of integration (for a detailed explanation, refer to Section 3B), the result of which is displayed on a light emitting diode (LED) display.

The third major functional block provides the power supplies to operate the whole instrument. This block also provides timing pulses to relate the measurement to the incoming mains supply frequency in order to overcome ac interference.

GENERAL NOTE:-

The numbers in each of the blocks shown below refer to the appropriate block and circuit diagrams contained in this section.

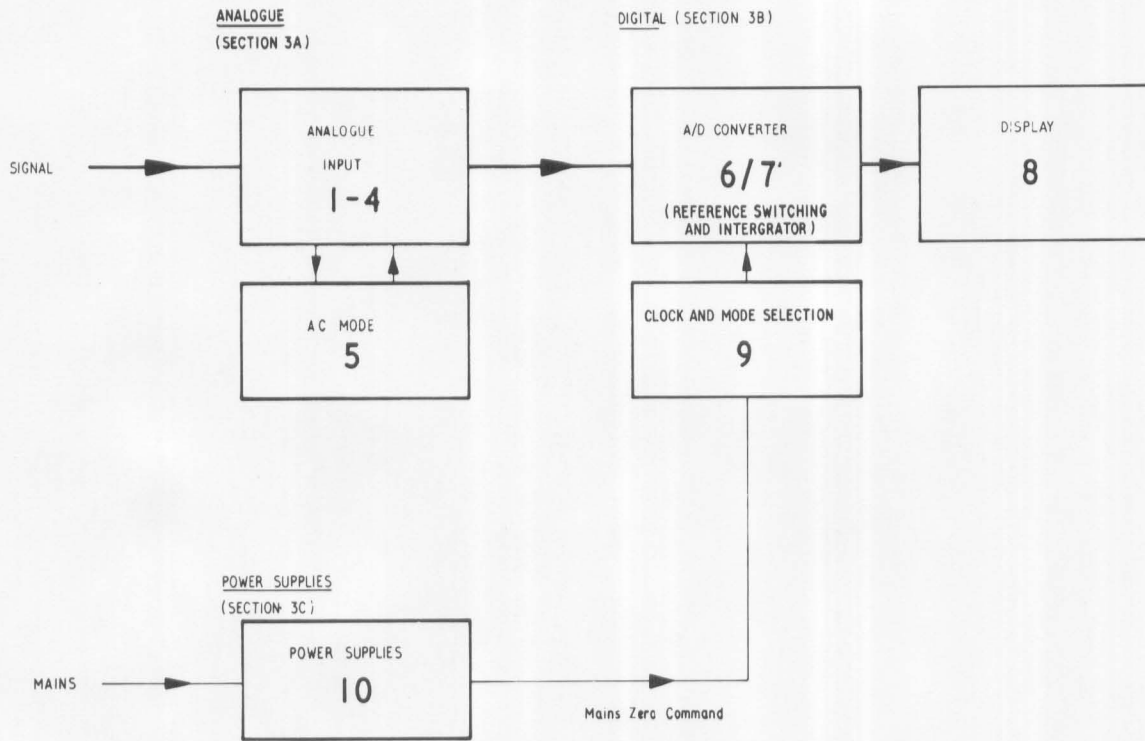

Fig. 3.1. Key Diagram (Pictorial Index).

This sub-section deals with the ANALOGUE section of the instrument whose primary function is to convert the input signal into an acceptable form suitable for digital conversion by the DIGITAL section (SUB-SECTION 3B - DIGITAL).

SIGNAL CONVERSION

INTRODUCTION

The purpose of these sections of circuitry is to convert the incoming signal into dc suitable for conversion by the A/D Converter in the DIGITAL section of the instrument.

DC MEASUREMENT

In this mode of operation, since the applied signal is already dc, the circuitry serves to scale the input to within the upper 11V limit acceptable to the A/D Converter input.

The INPUT AMPLIFIER is arranged in a series feedback configuration to provide a very high input impedance to the applied signal on the unattenuated ranges (0-11V).

The Analogue Input circuit in the 'V.DC' mode is shown on DIAGRAM 1.

RESISTANCE MEASUREMENT

The resistance measuring mode, ' Ω ', is shown on DIAGRAM 2. Consider the following simplified diagram.

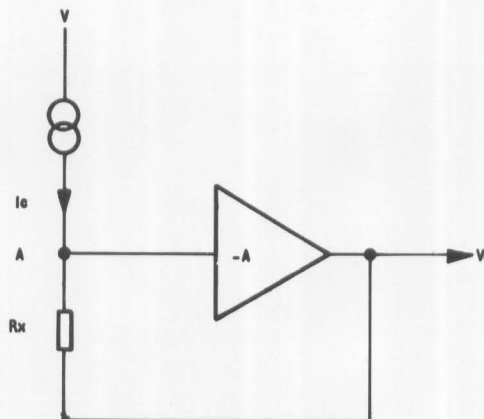

Point A is a 'virtual earth' input to a very high gain amplifier (INPUT AMPLIFIER). In order that the current flowing into and out of point A is balanced, the output of the amplifier V_o must rise to develop a potential drop across the applied unknown resistance R_x such that the constant current I_e derived from the reference voltage all flows through R_x . The final value of V_o when the circuit balances will be proportional to R_x and it is this output which is used by the A/D Converter for conversion to units of resistance.

CURRENT MEASUREMENT

Following from the above description of resistance measurement, it can be seen that if we make R_x a known value (R_{V6}/R_6 on DIAGRAM 3), the output of the amplifier V_o will be proportional to the unknown applied current.

AC MEASUREMENT

The section of circuitry used for converting the applied input to dc is shown separately on DIAGRAM 5.

The applied signal passes through a separate INPUT ATTENUATOR network and, via the AC AMPLIFIER buffer stage and SCALING RESISTORS, to the SUMMING JUNCTION. This point acts as a 'virtual earth' to the INPUT AMPLIFIER which follows. The output of this amplifier passes through the RECTIFIER SYSTEM which then divides the amplifier output into positive and negative half cycles by rectifier action. The positive half cycle output is filtered by the LOW PASS FILTER to form the equivalent dc input to the A/D Converter.

Since the rectified output would produce the mean value of the applied input, provision is made (R_{V3}) to scale the signal input such that the final displayed reading is the rms (root mean square) as opposed to mean value of the applied signal. It should be remembered that this scaling action will only be valid when the input wave form is sinusoidal.

TEST WAVEFORMS

FRAME 3A - 1

UPPER TRACE

A typical output waveform produced by the CHOPPER DRIVE (DIAGRAM 4) at TR4 collector. The output at TR3 collector is an inverted form of this trace.

LOWER TRACE

A typical output waveform produced by the DEMODULATOR (DIAGRAM 4) at the junction of C5 and R11.

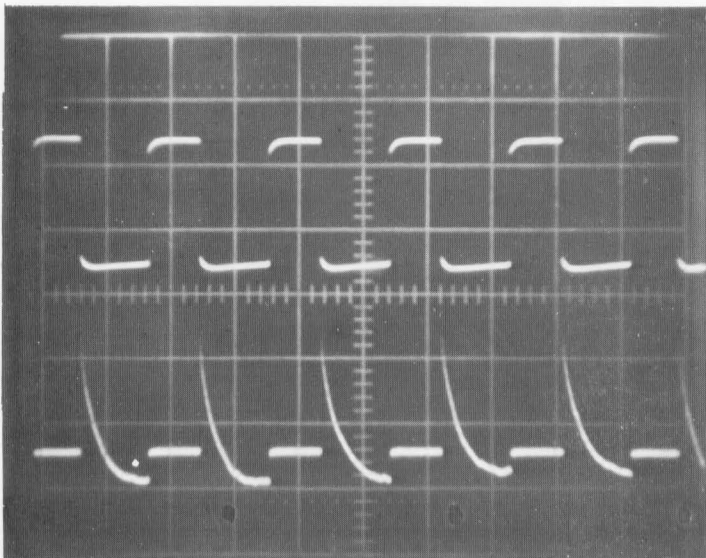

Time/cm:- 2ms.

Volts/cm:- 500mV.

Frame 3A-1 Chopper/Demodulator waveforms.

FRAME 3A - 2

UPPER TRACE

A typical output waveform produced at diode D3 cathode, the output from block RECTIFIER SYSTEM (DIAGRAM 5) used to provide dc to the A/D Converter for operation on ac V mode.

LOWER TRACE

A typical output waveform provided by the complementary common base stage formed by TR1/2 in block RECTIFIER SYSTEM (DIAGRAM 5) and used to drive both halves of the diode feedback loop. The sharp transitions about the zero of the output waveform overcome possible non-linear rectification, due to diode characteristics up to about 0.7V.

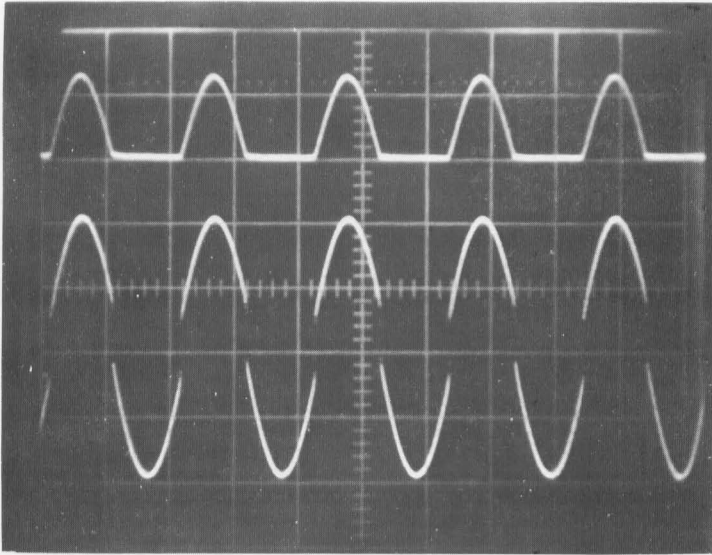

Time/cm:- 1ms.

Volts/cm:- 1V.

Frame 3A-2 Rectifier System waveforms.

DC MODE

In this mode of operation the correct attenuation is applied by the Auto Ranging function of the instrument.

DC ATTENUATOR/RESISTOR

The attenuation available on 'V.DC' is decided by relay RLB as follows:-

RLB energised:- 100/1 attenuation

RLB de-energised:- no attenuation

INPUT AMPLIFIER

This acts as a buffer between the voltmeter input and the Integrator (DIAGRAM 7).

OHMS MODE

In this mode of operation, the -10.000V output from the Inverter (REFERENCE SWITCHING, DIAGRAM 6) is used to provide a constant potential which, in conjunction with the DC Attenuator/Resistor, produces the appropriate test current ($100\mu\text{A}$ or $1\mu\text{A}$). The test current whilst flowing through the unknown resistance, produces a potential drop which is proportional to the value of unknown resistance. Refer to diagram 6 for further details of the -10.000V voltage source.

DC ATTENUATOR/RESISTOR

This resistance network is normally used as the DC Attenuator. When the ' Ω ' mode is selected the network, in conjunction with relay RLB, decides the value of test current as follows:-

RLB energised:- $1\mu\text{A}$ nominal

RLB de-energised:- $100\mu\text{A}$ nominal

INPUT AMPLIFIER

This is used in operational amplifier configuration with the unknown resistor as the feedback resistor.

CURRENT MODE

In this mode of operation the unknown current flows through one of two resistances R6, R73 (depending on whether μA or mA is selected,) producing a potential drop across it which is proportional to the unknown current.

INPUT AMPLIFIER

This is used in operational amplifier configuration. In the μA mode current is fed to the virtual earth. In the mA mode the amplifier is voltage fed, the voltage being that developed across R75. The amplifier gain is increased to $\times 10$.

Fuse FS2 protects the mA circuit against excess current

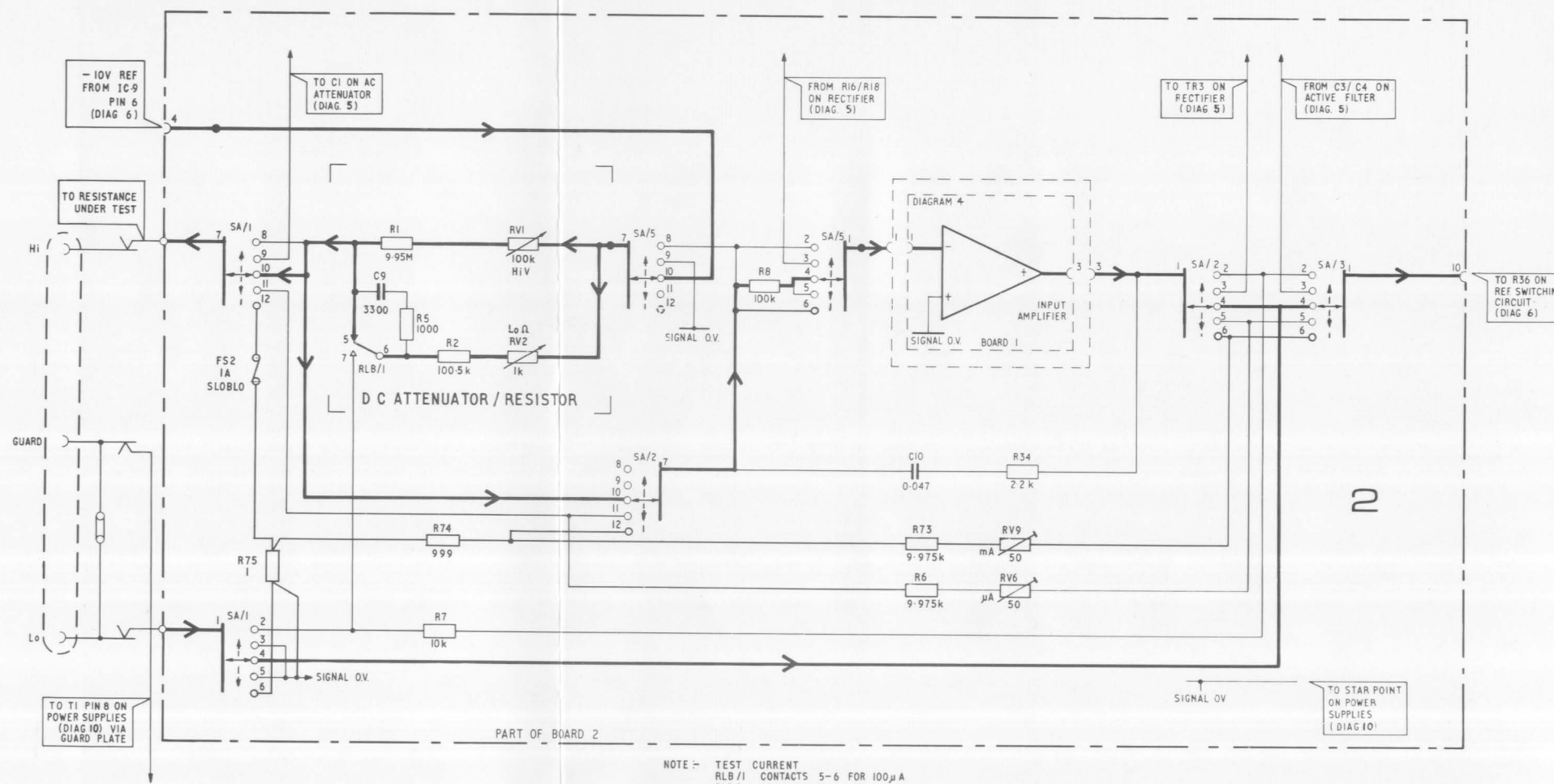
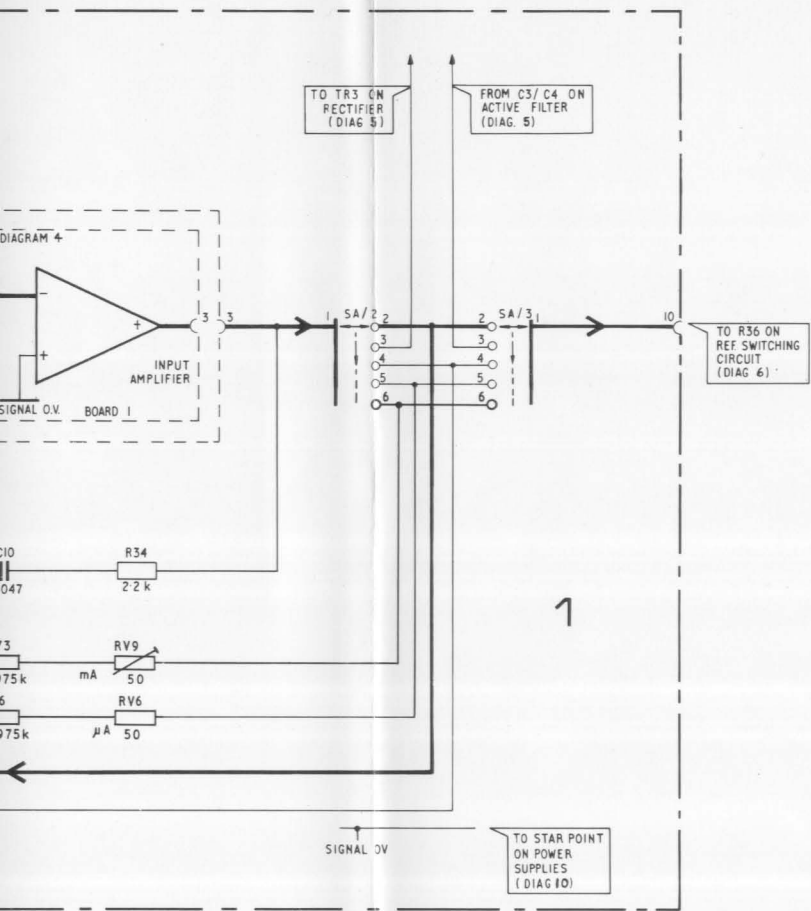

NOTE - TEST CURRENT
 RLB/I CONTACTS 5-6 FOR 100µA
 RLB/I CONTACTS 7-6 FOR 1µA

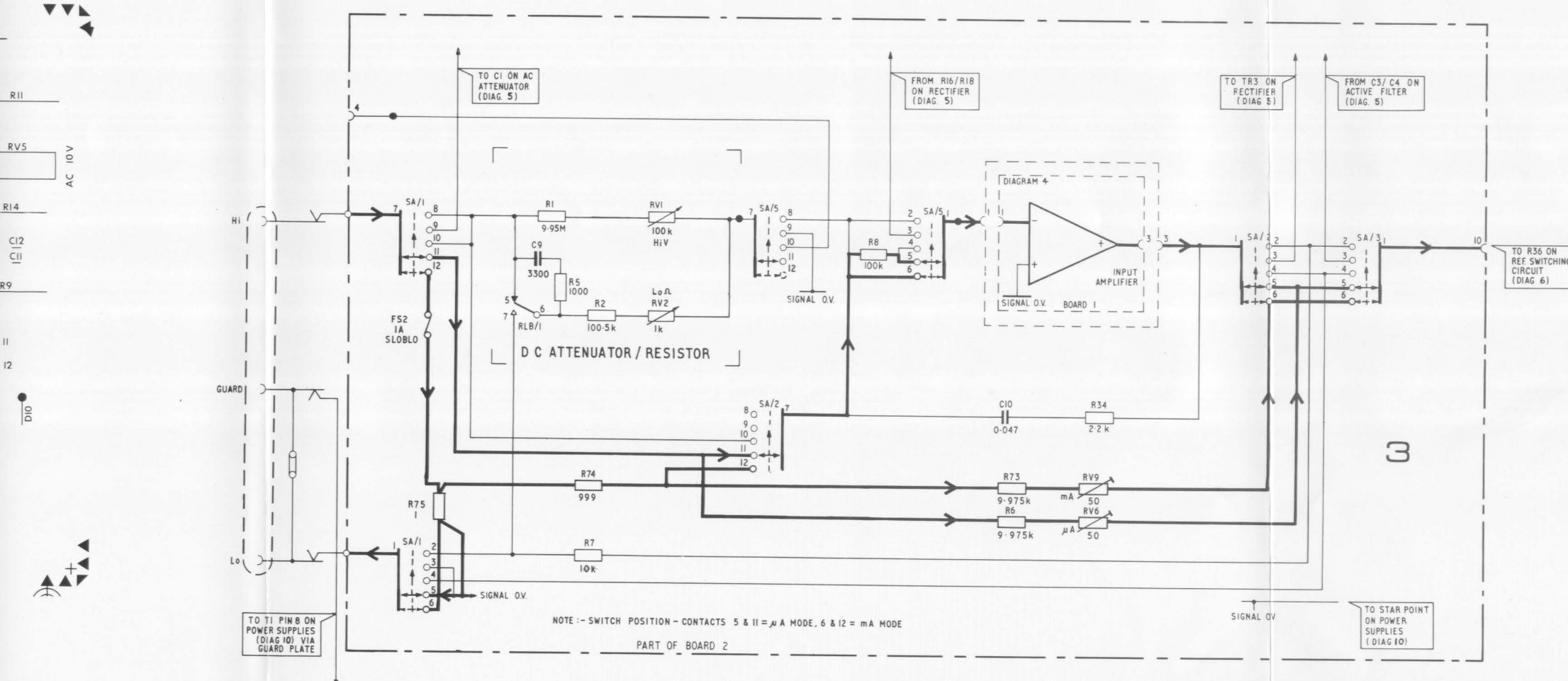

NOTE - SWITCH POSITION - CONTACTS 5 & 11 = µA MODE, 6 & 12 = mA MODE

1 ANALOGUE INPUT CIRCUIT DIAGRAM (IN DC MODE)

2 ANALOGUE INPUT CIRCUIT DIAGRAM (IN OHMS MODE)

2a PCB 2 COMPONENT AND COPPER TRACK LAYOUT

3 ANALOGUE INPUT CIRCUIT DIAGRAM (IN CURRENT MODE)

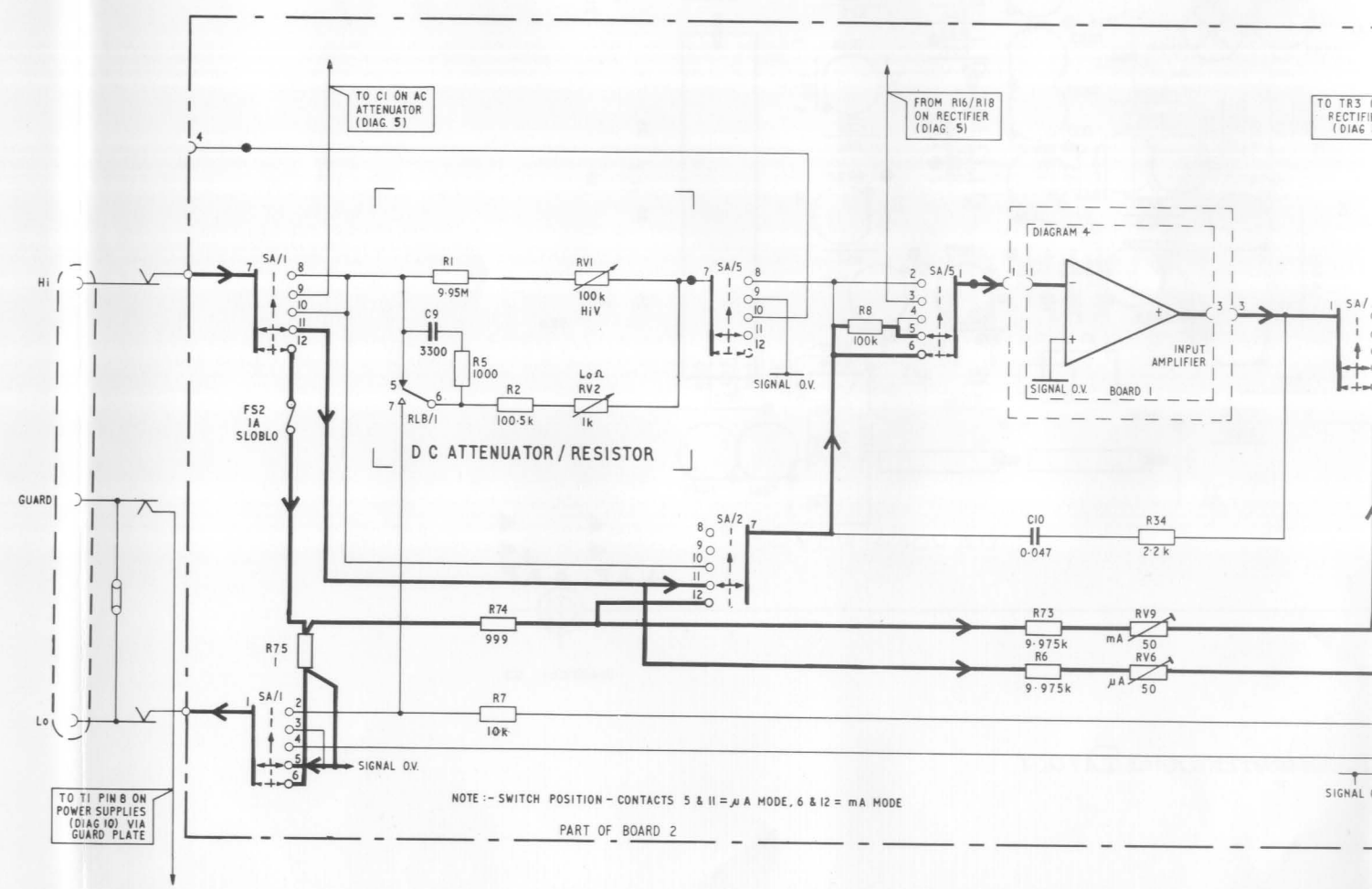
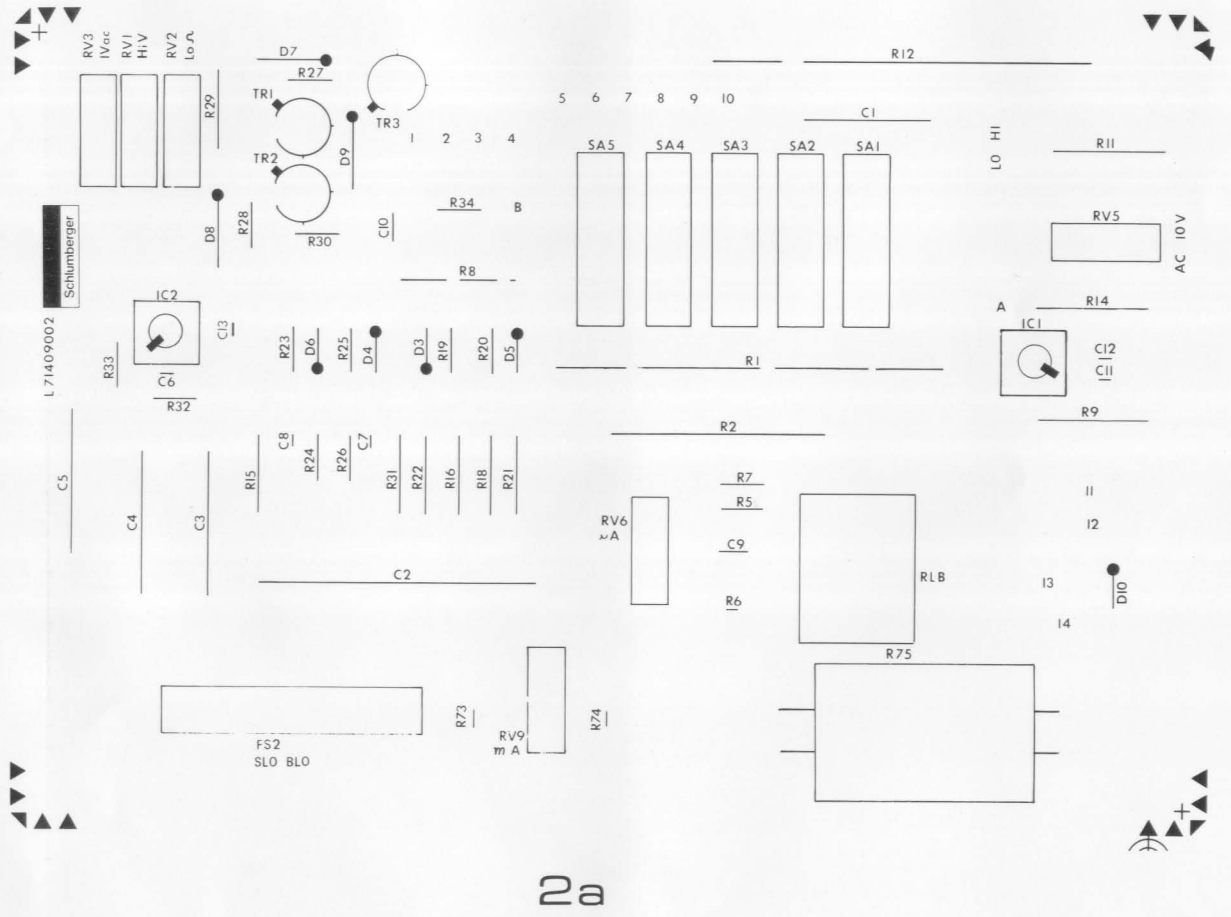
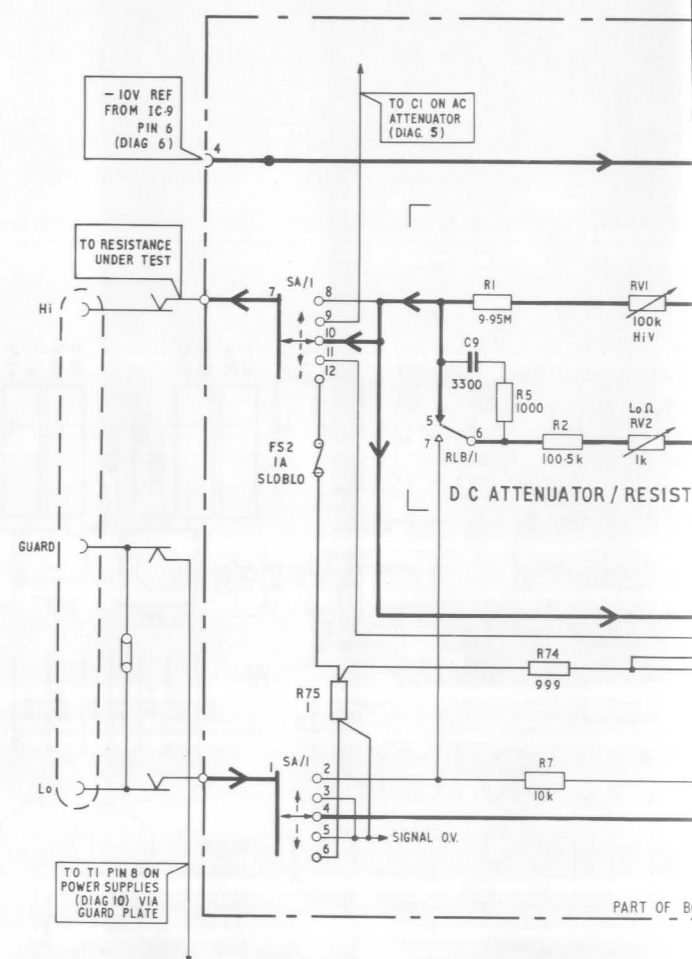
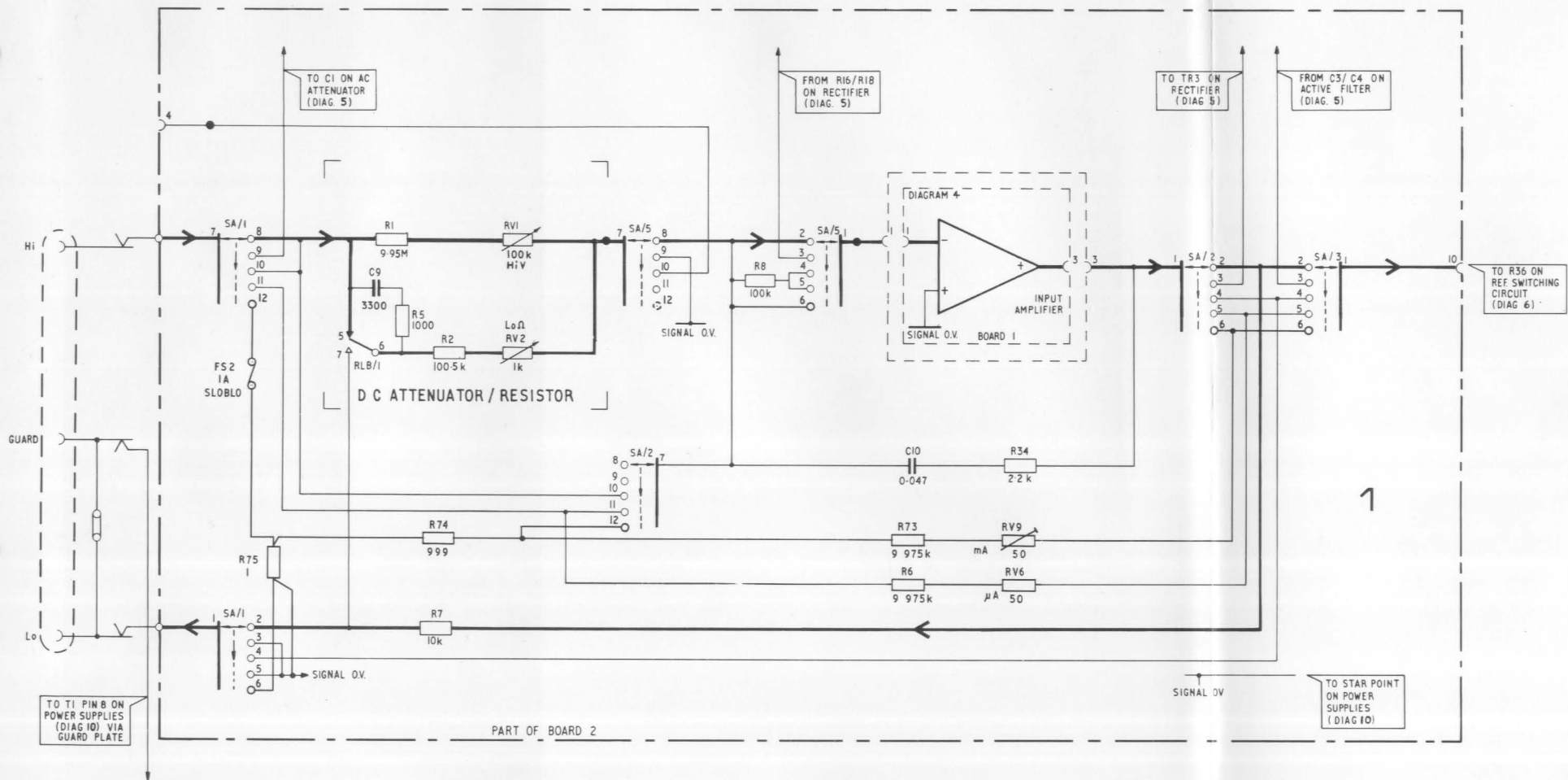

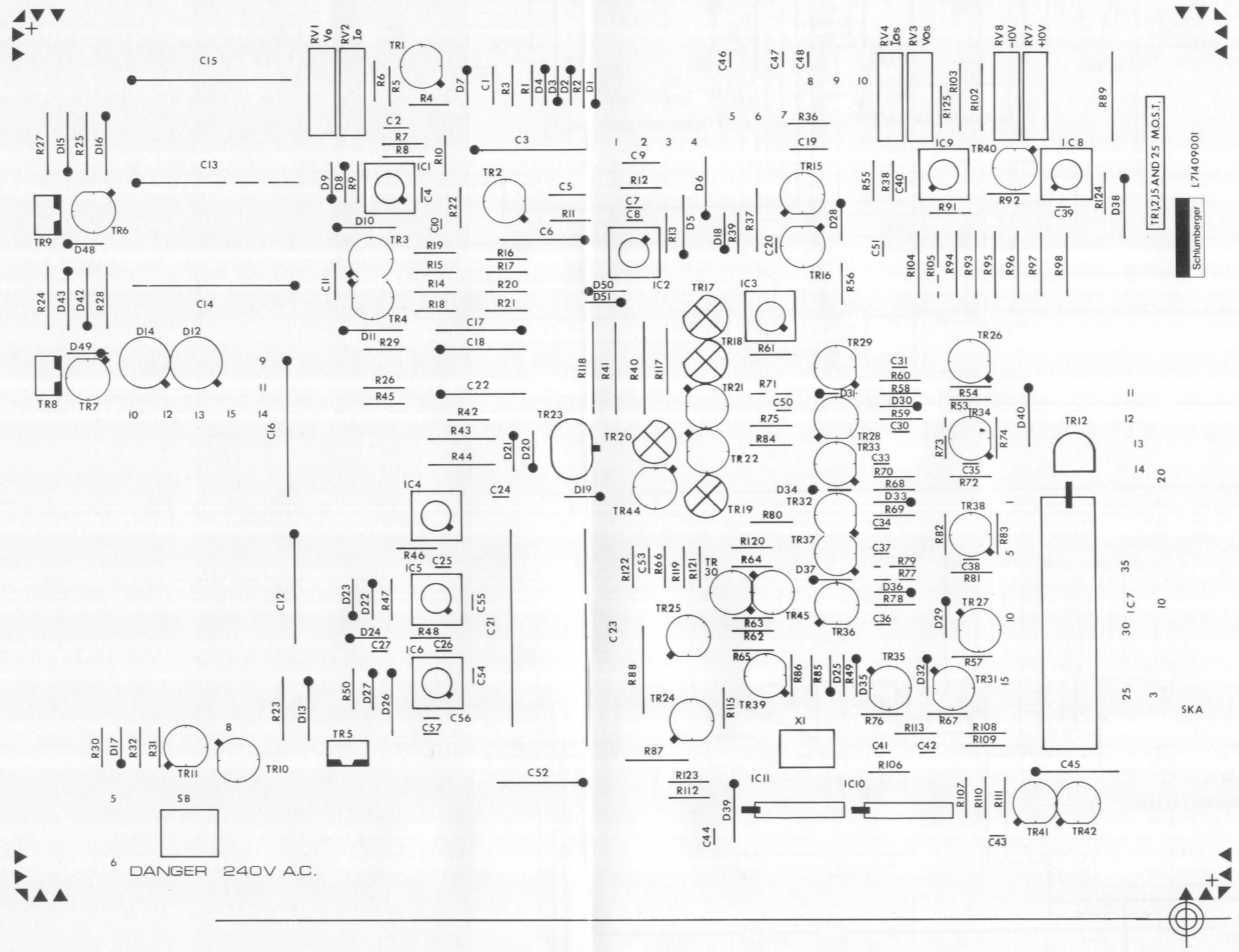

TRI,2,5 AND 25 MO.S.T.

Schlumberger L71409001

SKA

71409401 03

3a PCB 1 COMPONENT AND COPPER TRACK LAYOUT

INPUT AMPLIFIER

PROTECTION NETWORK

D1 and D2 protect the CHOPPER AMPLIFIER during overload conditions. D3/D4 in conjunction with D5/D6 limits the OUTPUT AMPLIFIER output to within $\pm 12V$.

LOW-PASS FILTER

R3, R4 and C1 form a low-pass filter which removes the high frequency components ($> 100Hz$) from the dc channel and prevents spikes from the CHOPPER (Modulator) circuitry reaching the input terminals.

CHOPPER DRIVE

A 275Hz emitter-coupled Multivibrator TR3/4 for driving the CHOPPER and DEMODULATOR.

A small proportion of the anti-phase output is applied via RV2 to minimise chopper-spikes produced by TR1 in the CHOPPER (Modulator) circuitry.

(Refer to Section 4 - Setting Up Procedure for details on the adjustment of RV2).

CHOPPER (MODULATOR)

The filtered output from the LOW PASS FILTER is 'chopped up' by alternately shorting the signal to earth via TR1 to form an ac type signal. The chopping frequency is determined by the in-phase output of the CHOPPER DRIVE multivibrator.

Anti-phase chopper drive is applied to G2 of TR1 to minimise chopper spikes.

RV1 (Vo) provides a small dc voltage to the Chopper output, compensating for small offsets.

CHOPPER AMPLIFIER

IC1, whose gain and frequency response are defined by C3, C4, R8 and R9, amplifies the input (chopped) waveform produced by the CHOPPER (Modulator). The ac gain is 10,000 and the dc gain is unity.

DEMODULATOR

The output from the CHOPPER AMPLIFIER is fed via C5 to TR2 where it is dc restored. The ac component is removed by filter R11 and C6, leaving the dc component only.

OUTPUT AMPLIFIER

The ac component ($> 2Hz$) of the input voltage is coupled directly via R12/C9 to the inverting input of the amplifier while the dc component on C6 (DEMODULATOR) is added into the non-inverting input.

The output is applied to the PROTECTION NETWORK which limits the over-all amplifier output to within $\pm 12V$.

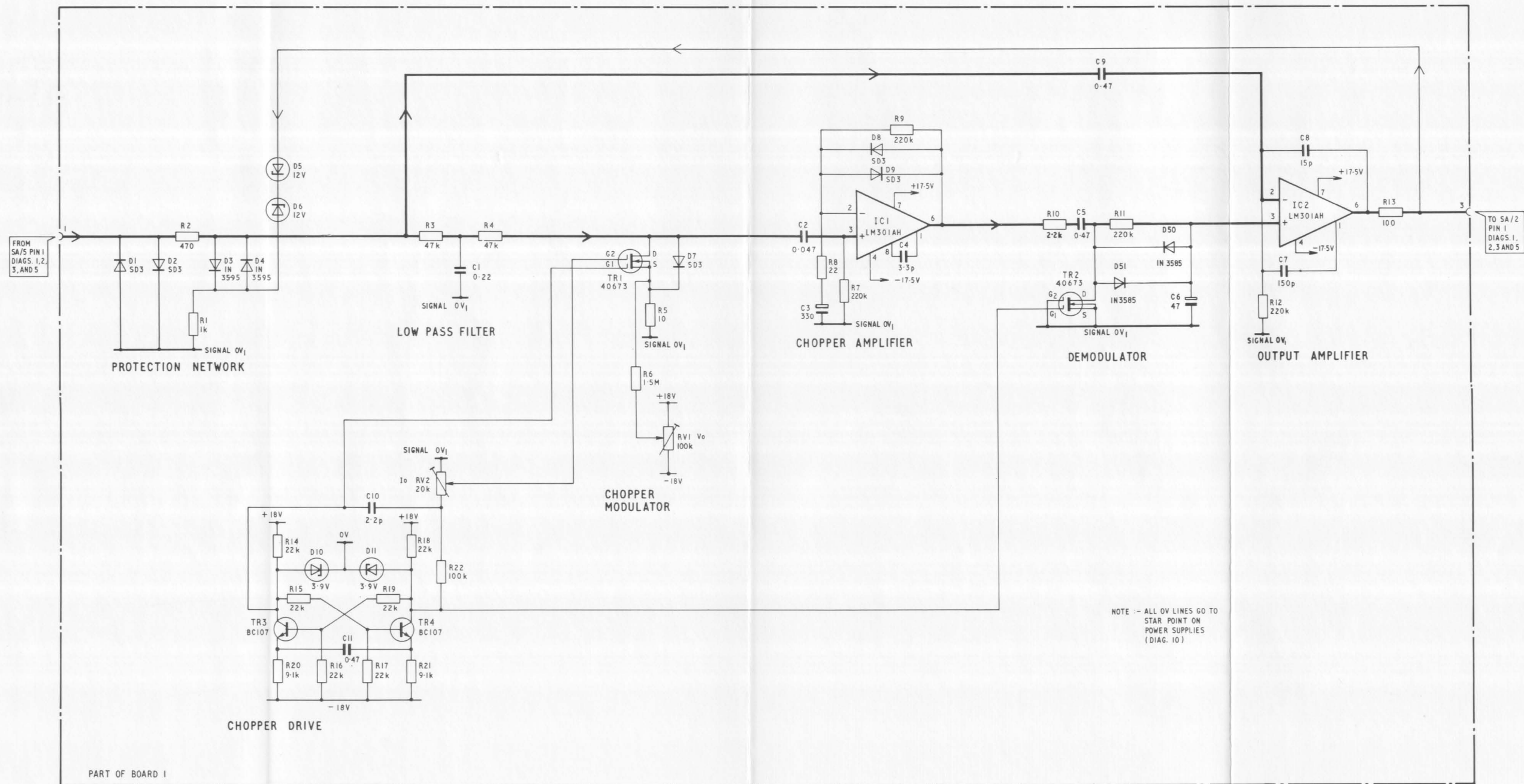

4 INPUT AMPLIFIER CIRCUIT DIAGRAM

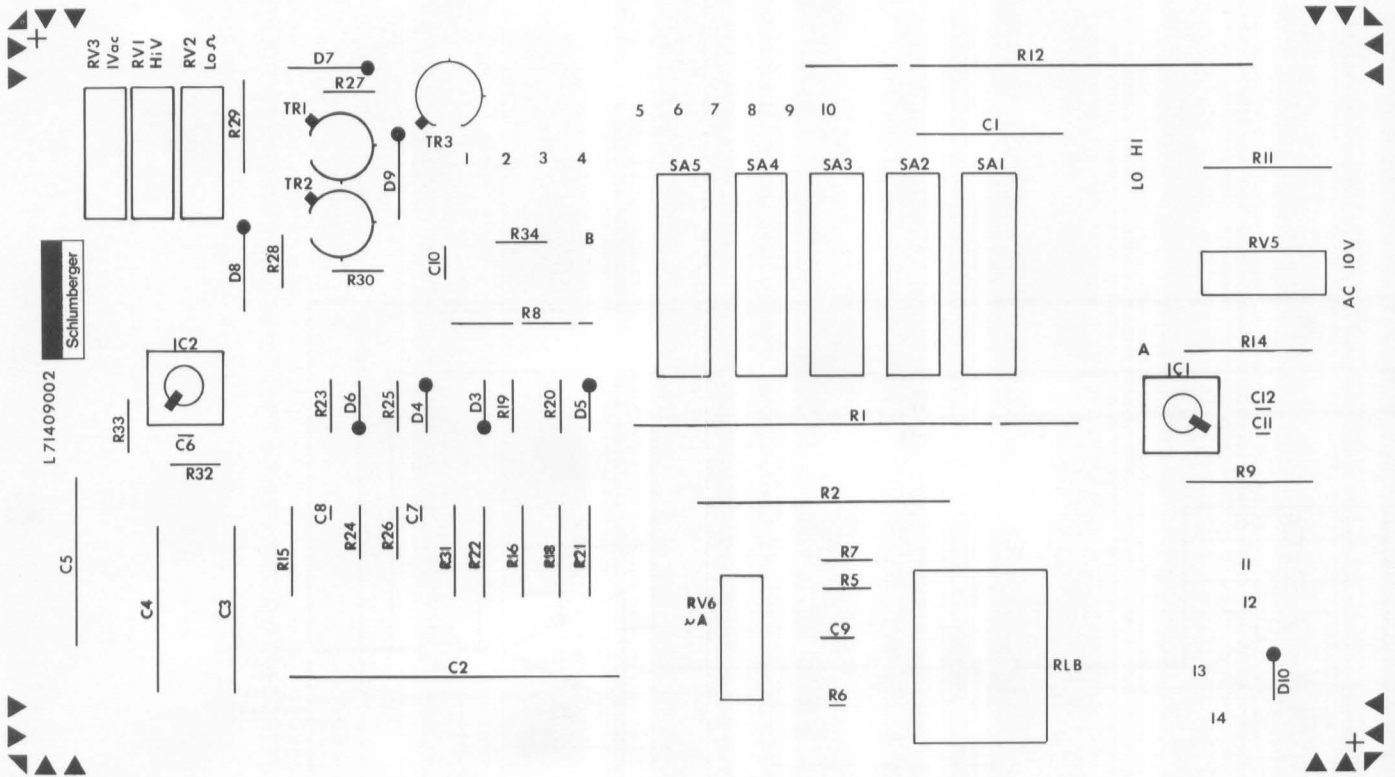

4a PCB 2 COMPONENT AND COPPER TRACK LAYOUT

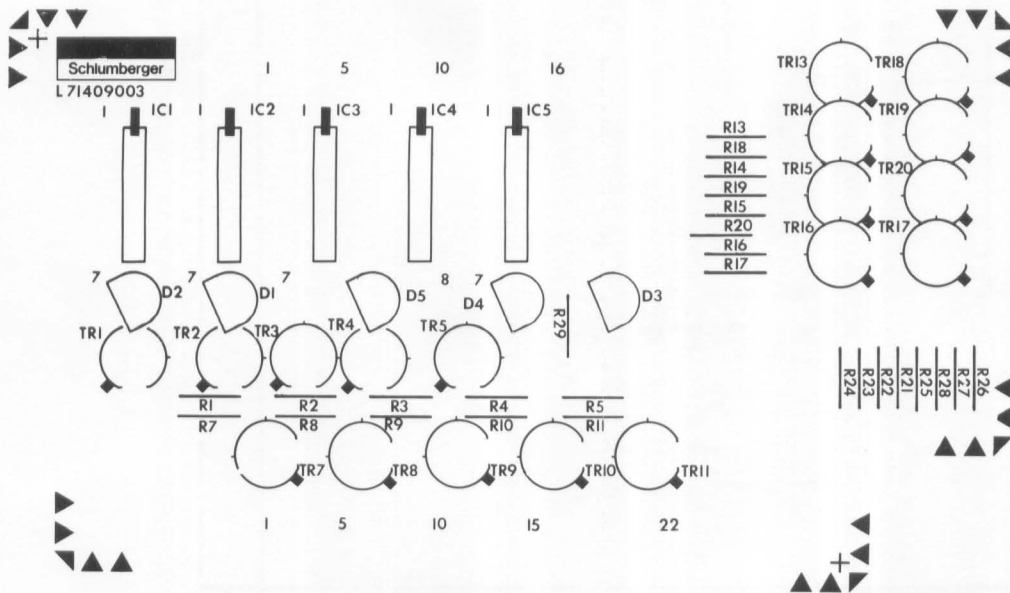

4b PCB 3 COMPONENT AND COPPER TRACK LAYOUT

AC MODE

INPUT ATTENUATOR

On the 10V, 100V and 750V ranges, relay RLB is energised to attenuate the input signal by a factor of 100. The input impedance is $1\text{M}\Omega$ whether the attenuator is energised or not.

AC AMPLIFIER

This is a voltage follower stage, isolating the input from the SCALING RESISTORS. R14 in conjunction with IC1 provides overload protection.

SCALING RESISTORS

The applied input plus the feedback signals via R16/R18 in the RECTIFIER SYSTEM are summed at the 'virtual earth' of the INPUT AMPLIFIER. RV3 scales the input signal so that the final displayed value on the LED module represents the rms (root-mean-square) value of the applied input assuming a pure sine-wave shape.

RECTIFIER SYSTEM

The output of the INPUT AMPLIFIER (DIAGRAM 4) drives the complementary common base stage formed by TR1/2. Positive half-cycles are fed back to the 'virtual earth' via D4/D3 and precision resistor R16. Negative half-cycles are fed back via D6/D5 and R18. Only the positive half-cycles are taken for digital conversion.

R25/R26/C7 and R23/R24/C8 are shaping networks which improve frequency response at low signal levels.

LOW PASS FILTER

IC2 is connected as a low-pass active filter to remove high frequency components from the rectified ac signal. The filter has a nominal cut-off frequency of 4.5Hz and provides 60dB per decade attenuation.

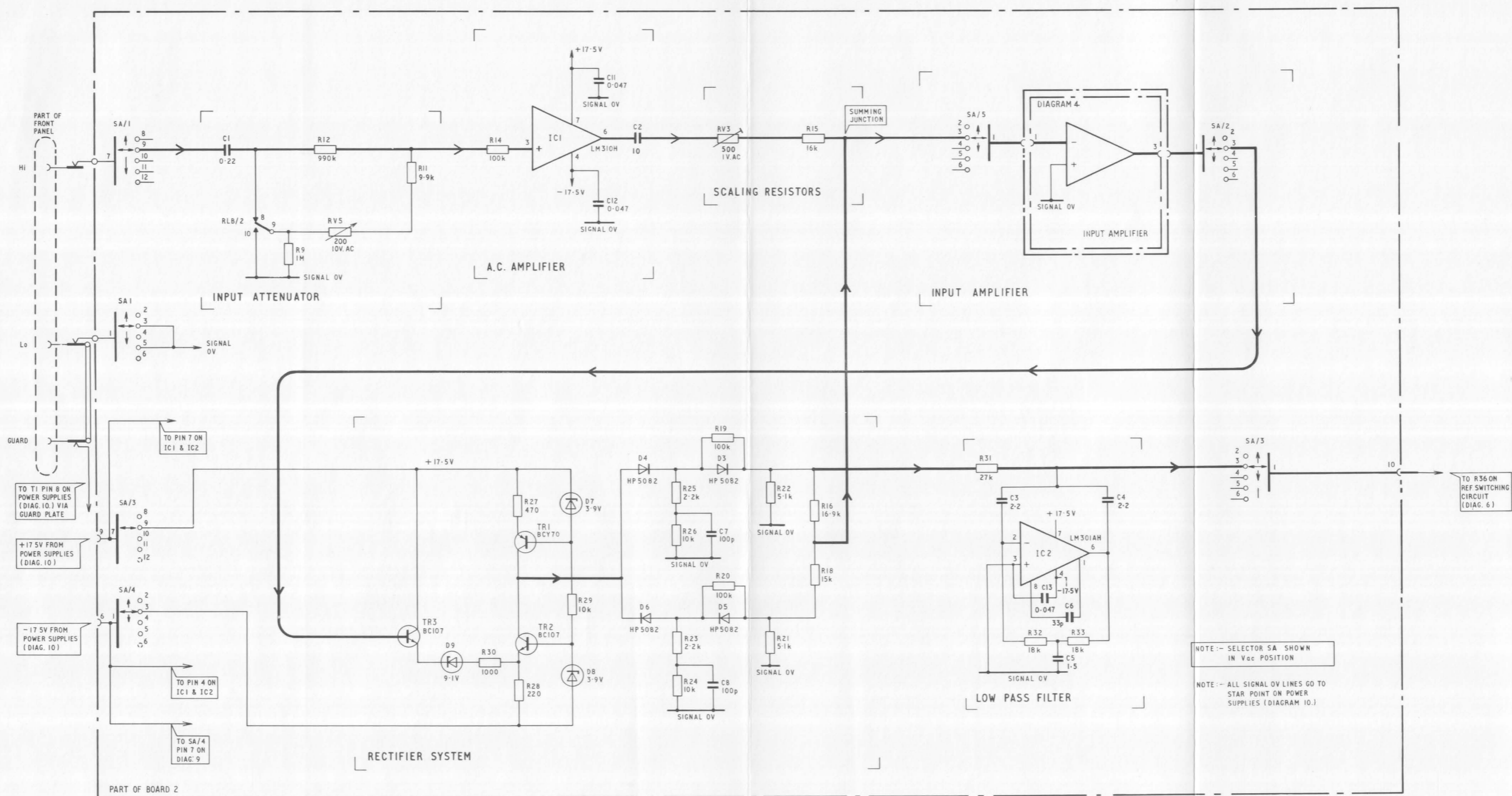

5 AC MODE CIRCUIT DIAGRAM

This sub-section deals with the DIGITAL section of the instrument whose primary function is to convert the dc analogue input into digital form.

TRIPLE RAMP DIGITAL CONVERSION

INTRODUCTION

The triple ramp technique of analogue to digital conversion may be considered as a refined version of the well known dual ramp technique with the addition of a third ramp. This third ramp (known as fine ramp-down) acts like a 'vernier' upon the usual ramp-down period.

BASIC PRINCIPLES OF OPERATION

Examination of the following simplified circuit diagram serves to illustrate the principles used to perform analogue to digital conversion in this instrument.

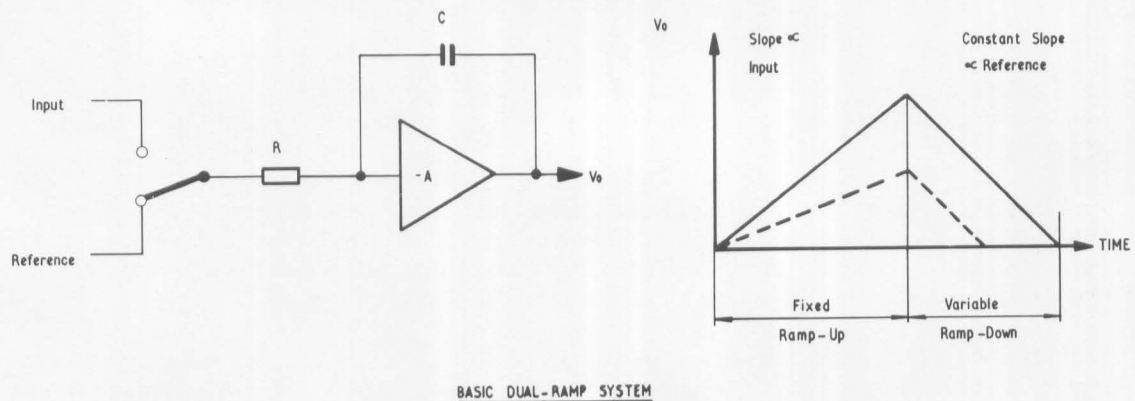

When the integrator is connected to the input its output 'ramps-up' at a rate which is proportional to the value of the input. After a fixed time the switch changes over and connects the reference in place of the input. It is so arranged that the reference voltage is of opposite polarity to that of the input, so that the integrator output now 'ramps-down' at a defined rate which is determined by the value of the reference.

If the ramp-up period is made constant by using a clock pulse generator to gate the input switch, the number of pulses produced during the 'ramp-down' period, the length of which is controlled by the slope of the reference voltage, will be directly proportional to the applied input.

Since both ramp-up and ramp-down periods are related to a common timebase, any variations of clock frequency do not affect the reading.

In the DMM, the reference voltage used during this 'ramp-down' period (known as 'coarse ramp-down') is actually 10V, so each ramp-down pulse with a 'full-house' counter length of 10,000 will represent 1mV. The total number of pulses collected between the end of ramp-up and the point where the integrator output was driven to zero is a direct measure of the applied input voltage to within 1mV.

Looking at a greatly magnified view of the integrator output waveform at the point where the integrator output passed through zero, it can be seen that there is an inherent digitising error within the system, the magnitude of which can be 1mV.

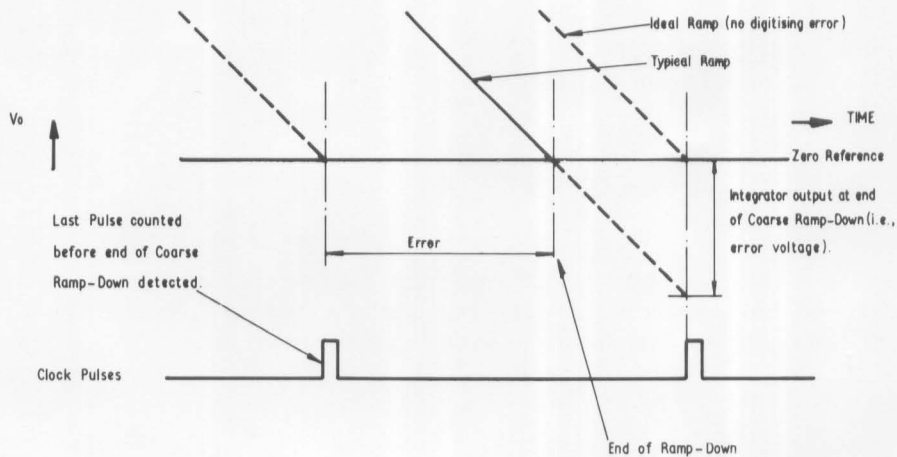

If we allow the integrator output to continue beyond zero until the next clock pulse, the integrator capacitor will be charged to a level representing the difference between 1mV and the true measured input.

By adding two extra less significant decades to the counter, the minimum decade would represent $10\mu\text{V}$. If we complement* the counter and then re-organise it such that it counts down to zero when driven by further clock pulses, by changing the ramp-down rate, the final count overall could represent the applied input when the integrator output again passes through zero.

In the DMM, this second ramp-down reference voltage is 100mV so that each new clock pulse will represent $10\mu\text{V}$. In order to drive the integrator output to zero, the new ramp-down reference polarity is made opposite to the coarse ramp-down polarity. This third ramp is known as 'fine ramp-down'.

It can be seen that the final measurement could, in theory, be within $10\mu\text{V}$ of the applied input.

* COMPLEMENTING

The action of complementing a number within a counter can be followed by referring to the following example.

We have a hypothetical counter capable of holding a total count of 100 pulses. If we count say 60 input pulses, still required to 'fill-up' the counter will be 100-60 i.e. 40. It is this number which is defined as the complement of the number 60 in this example.

MEASUREMENT CYCLE DRIVES

INTRODUCTION

All stages of analogue to digital conversion are controlled by IC7-board 1, whose outputs turn on or off appropriate FET switches to select the appropriate sections of circuitry required at each stage of a measurement cycle.

ELECTRICAL ARRANGEMENT

There are eight cycle control drive outputs as follows:-

IC7-pin 11	Drift Correct
pin 12	Earth Clamp
pin 13	Spoiler
pin 14	Neg. Fine Reference
pin 15	Pos. Fine Reference
pin 16	Pos. Coarse Reference
pin 17	Neg. Coarse Reference
pin 18	Input Switch

During a typical measurement cycle, each of these pins will assume the states shown in Table 3B-1. The Pause periods 1-4 are for internal use within the integrated circuit to allow time for internal re-organisation of the counter, range selection and other tidying up operations required. The duration of these periods will change depending upon the range, length of ramp-down, spoiler time etc. so differing pause periods should not be interpreted as indications of faulty operation.

TABLE 3B - 1 CONTROL CYCLE SEQUENCE

L = low $\leq -16V$ H = high $\geq +8V$

IC7 - Board 1

Period	11	12	13	14	15	16	17	18
Drift Correct	L	L	H	H	H	H	H	L
Pause 1	H	L	H	H	H	H	H	L
Ramp-Up	H	H	H	H	H	H	H	L
Spoiler Period	H	H	L	H	H	H	H	L
Pause 2	H	L	H	H	H	H	H	L
Coarse Ramp	H	L	H	H	H	H*	L*	H
Pause 3	H	L	H	H	H	H	H	L
Fine Ramp	H	L	H	L*	H*	H	H	H
Pause 4	H	L	H	H	H	H	H	L

Levels marked* will be inverted when the applied signal input is negative (with respect to the terminal on the front panel).

AUTO-RANGING

INTRODUCTION

The DMM is fully auto-ranging for all modes of operation. Range switching is divided into two parts, basic range selection and/or attenuator switching.

RANGE SELECTION

Each of the ranges is coded with a letter, the actual range depicted by each being dependent upon the measurement mode selected (refer Tables 3B - 2 to 4).

The basic ranges are coded A, B and C and progress in decade steps with A the highest. A, B or C followed by the letter R indicates the basic range together with the 100/1 attenuator stage, making a range selection with a full scale reading 100 times greater than that for the basic range alone.

TABLE 3B-2 VOLTAGE MEASUREMENT CODING

Nominal Range	Range of Current Displayed	Range Coding
1000V	1099.9 to 100.0V	AR AR
100V	109.99 to 10.00V	BR BR
10V	10.999 to 1.000V	A CR
1V	1.0999 to 1.0000V 999.9 to 100.0mV	B B
100mV	109.99 to 0.00mV	C C

TABLE 3B - 3 RESISTANCE MEASUREMENT CODING

Nominal Range Ω	Range of Resistance Displayed	Range Coding
10M	10999 to 1000k	AR
1M	1099.9 to 100.0k	BR
100k	109.99 to 10.00k	A
10k	10.999 to 1.000k	B
1k	1.0999 to 1.0000k Ω 999.9 to 0.0 Ω	C

TABLE 3B - 4 CURRENT MEASUREMENT CODING

Nominal Range	Range of Current Displayed	Range Coding
1000 μ A	1099.9 to 100.0 μ A	A
μ A mode 100 μ A	109.99 to 10.00 μ A	B
10 μ A	10.999 to 0.000 μ A	C
1000 μ A	1099.9 to 100.0mA	A
mA mode 100mA	109.99 to 10.00mA	B
10mA	10.999 to 0.000mA	C

Ranging up or ranging down occurs just after the fine ramp-down period in the measurement cycle, and unless a range change decision occurs, the range in use will remain constant for the remainder of the cycle.

RANGE-UP SEQUENCE

A range-up decision will occur if the total count at the end of fine ramp-down in the counter equals or exceeds 1.1 times that count which corresponds to the nominal full-scale count for the particular range in use. Take for example the 1V range, a range-up decision occurs if the measured voltage is 1.1 volts or higher, making 1.0999V the highest voltage which will not cause a range-up decision.

RANGE-DOWN SEQUENCE

A range-down decision will occur if the total count in the counter after a measurement falls below 0.1 times that which corresponds to nominal full-scale count except when the particular range in use is the lowest for the mode of operation. In this instance, operation will be maintained on that range for all readings down to zero. Therefore for all but the lowest of a group of ranges 0.1000 times the nominal full-scale value is the lowest reading which will not cause a range-down decision.

RANGE SWITCHING (DIAGRAM 7)

The input signal to the INTEGRATOR is rescaled by changing the value of the Integrator Input Resistor. The three ranges (A, B and C), effective resistances and scaling factors are as follows:-

RANGE	INTEGRATOR INPUT RESISTOR	SCALING FACTOR
A	1M Ω (R41)	1:1
B	100k Ω (R41//R40 \approx 100k Ω)	1:10
C	10k Ω (R41//R118 \approx 10k Ω)	1:100

By this method the dynamic range of the INTEGRATOR may be 0 – 11V, 0 – 1.1V or 0 – 0.11V respectively.

For inputs above 11V dc or 1.1V ac the attenuator relay, RLB, provides 100:1 attenuation on dc and ac ranging.

IC7 - PCB No. 1 (MOS - LS1) INTEGRATED CIRCUIT

This 40 - lead dual-in-line ceramic package contains the digital circuitry used to control the measurement cycle, count and gate clock pulses, provide signals to drive the LED display and to rescale the Integrator during auto-ranging.

Details of all pin connections and functions are on the Clock and Mode Selection diagram, referenced 9. Where inputs from, and outputs to IC7 occur on other circuits, these are identified by the effected IC7 terminal number shown enclosed in a square.

WARNING

Before attempting to remove this integrated circuit, ensure that all power supplies are switched off.

MOS Integrated Circuits are prone to damage by static charges. It is therefore advisable to ensure that all items likely to come into contact with MOS ICs and/or the circuits in which they are employed are bonded together and are earthed. Affected ICs are notified on their pcbs.

SELECTED FET'S TR17 - 20 (PCB No. 1)

Whenever any one of these components is replaced, it is essential that a component with the same colour coding is used or alternatively, replace the whole set.

NOTE. Reference should be made to the selection procedure detailed in the APPENDIX section of this manual.

DISPLAY

INTRODUCTION

The type of display used in this instrument is a light emitting diode (LED) 7-bar segment, time-shared type arranged to display 5 digits and a polarity sign.

7-bar SEGMENT FORMAT

Each of the possible digits, 0 to 9, is displayed using the universally accepted 7-bar segment format. In order to display a digit, a specific group of bars, each comprising a light emitting diode, is energised.

Each bar has been referenced with a letter a-g, and are arranged in the form of a figure 8 as shown below.

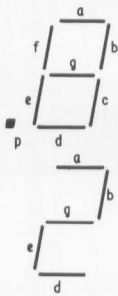

For example, suppose we wish to display the digit 2. In this case, bars a, b, d, e and g would be energised, all other bars being left de-energised.

The actual bars used to represent each digit are shown on DIAGRAM 8.

GENERAL ORGANISATION OF DISPLAY

The display used can display up to 5 characters, each of which comprises a 'diode tree' as shown below. The most significant digit can only display a one and/or a minus.

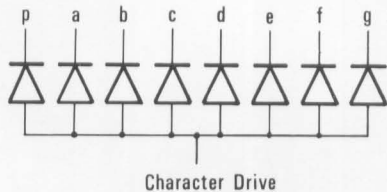

Each diode of a 'tree' corresponds to a specific bar as detailed above.

NOTE: The decimal point for each character is positioned to the left and will be energised whenever the 'p' bar is called for at the same time as the appropriate character.

In the DMM, each of the 5 possible characters is energised via the appropriate CHARACTER DRIVER (DIAGRAM 8) in sequence. In order that a particular digit may be displayed, the appropriate 7-BAR SEGMENT DRIVERS (DIAGRAM 8) are energised. For a group of diodes to light, both the segment and character drives must be present at the same time but since only one character drive will be present at any one time only one character will ever be on. It should be noted that the 1st character is incomplete, the surplus segments of which are arranged as the UNITS ANNUNCIATOR DISPLAY (DIAGRAM 8).

The polarity window will only display a negative sign, absence of display signifying a positive potential applied to the instrument. When 'V.AC' or ' Ω ' is selected, no sign is displayed.

LOGIC ELEMENTS

NAND GATES (DIAGRAM 9)

Elements IC10a and b are logic elements performing a NAND function (positive logic) for which the following truth tables apply:

IC10a	Pin No.	1	2	3
		H	H	L
		L	H	H
		H	L	H
		L	L	H
IC10b	Pin No.	4	5	6
		H	H	L
		L	H	H
		H	L	H
		L	L	H

Logic Levels

H = -11V to -14.5V

L = -16.5V to -17.5V

D - TYPE BISTABLE (DIAGRAM 9)

Elements IC11 a and b are logic bistables (Flip-flops) performing a D-type function (positive logic) for which the following rules apply:

1. Whenever the CK (Clock) input goes high (positive logic), the Q output assumes the same state as that present on the D input.
2. Whenever the CK input is low, the D input level has no effect.
3. The \bar{Q} output is always the complement of the Q output.

VOLTAGE LEVELS

Caution should be taken when investigating this section of circuitry not to short any of the logic element connections to the 0V rails, since this action could apply a minimum level of -12V to the element and almost certainly damage it. It is recommended that the -18V rail should be used as a return path for test equipment and make appropriate adjustments to indicated readings.

TEST WAVEFORMS

FRAMES 3B-1/2

UPPER TRACE

This shows a typical input waveform at the INTEGRATOR (DIAGRAM 7) 'virtual earth' input.

LOWER TRACE

A typical ramp-up waveform produced at the input of the X100 AMPLIFIER (DIAGRAM 7) at C21/R46. The small insert shows a typical fine ramp-down. Note that the coarse ramp-down cycle is shorter than that shown in the main trace for illustration purposes only.

FRAMES 3B - 3/4

UPPER TRACES

These traces illustrate typical CHARACTER DRIVER (DIAGRAM 8) outputs. The outputs are taken from the collector of TR9 instead of the 'floating' collector of TR3, providing a well defined pulse.

LOWER TRACES

These traces illustrate typical 7-BAR SEGMENT DRIVER (DIAGRAM 8) outputs. The outputs are taken from the 'a' bar output, the collector of TR13, and are as follows.

Trace 3B-3 shows the 'a' bar segment, aligned underneath the 3rd character driver output, in a de-energised state. This depicts the missing 'a' bar of the figure 4 in this example.

Trace 3B-4 shows the 'a' bar segment in the energised state, in this example the top of the figure 3.

- NOTES:-**
1. The traces 3B-3/4 were taken with the BCD Output Module, and its inherent pull-up effect on the SEGMENT DRIVERS, fitted. Under this condition the trace of any bar not selected is pulled up. If tested without this pull-up effect, the position of the non-selected bar trace is indeterminate.
 2. Due to the internal organisation of IC7, multiplexing of the Character and Segment Drivers produces a Six Character waveform, although only five characters are displayed on the DMM.

FRAME 3B-5

UPPER TRACE

Typical output waveform at IC7-pin 19 of clock input phase ϕ 1 - refer CLOCK DRIVERS (DIAGRAM 9).

LOWER TRACE

This is the clock input at IC7-pin 20 in phase ϕ 2.

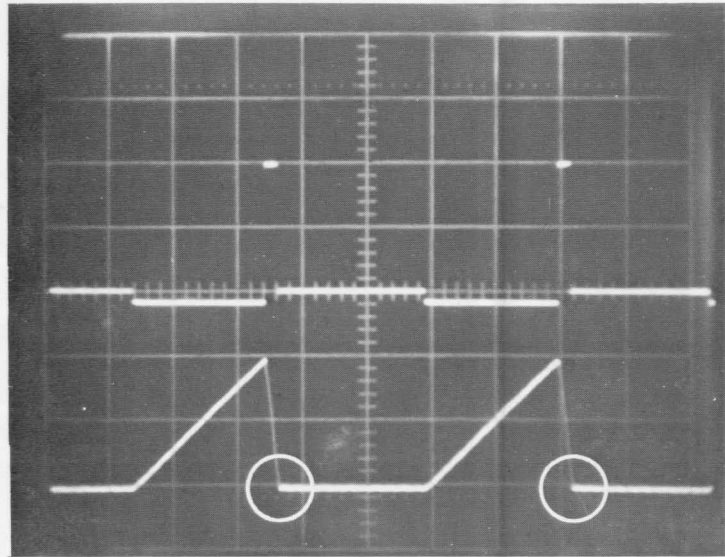

Frame 3B-1 Typical Integrator waveforms.

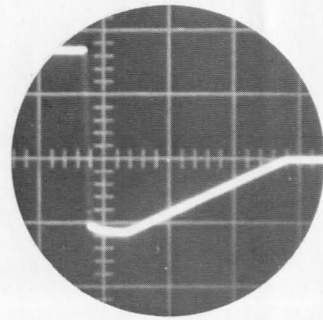

Time/cm:- 50ms.
Volts/cm:- 5V.

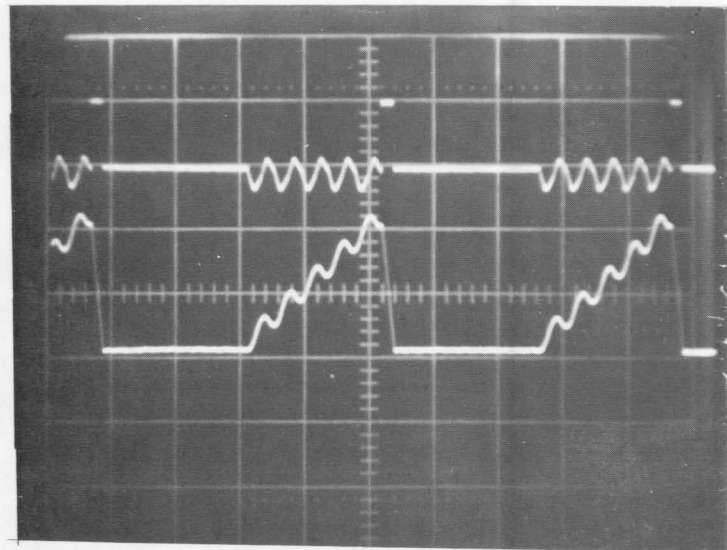

Frame 3B-2 Typical Integrator waveforms with ac interference.

Time/cm:- 5 μ s.
Volts/cm:- 20V.

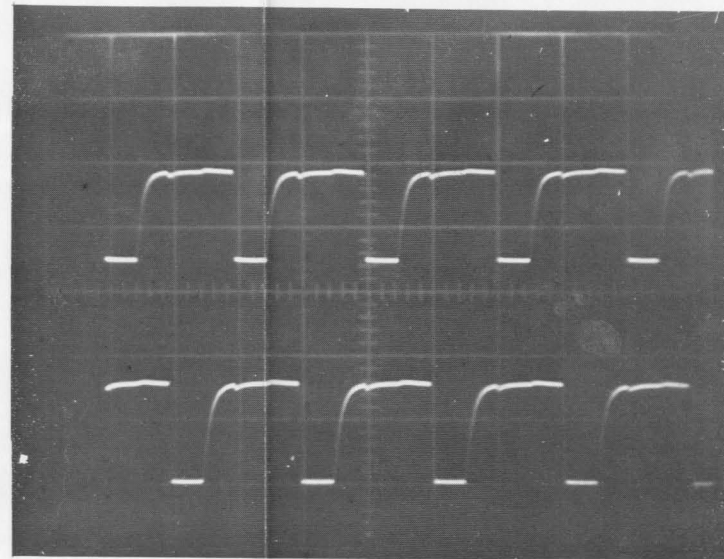

Frame 3B-5 Typical Clock waveforms.

Time/cm:- 50ms.
Volts/cm:- 10V.

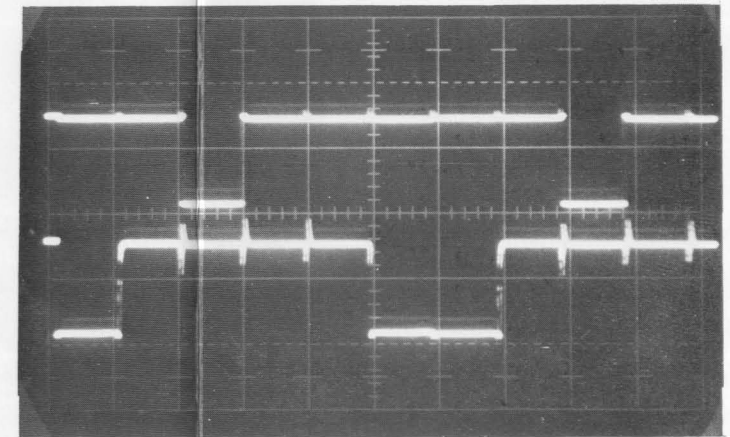

Time/cm:- 200 μ s.
Volts/cm:- 5V.

Frame 3B-3 3rd Character with 'a' Segment de-energised (e.g. numeral 4).

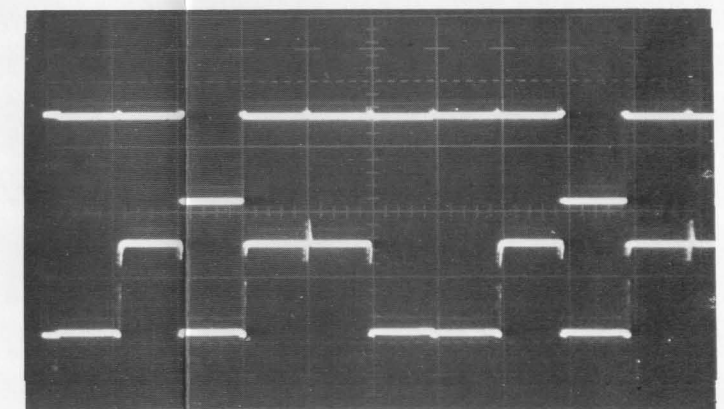

Time/cm:- 200 μ s
Volts/cm:- 5V.

Frame 3B-4 3rd Character with 'a' Segment energised (e.g. numeral 3).

REFERENCE SWITCHING

REFERENCE VOLTAGE SOURCE

IC8 is connected as a non-inverting amplifier amplifying the voltage of reference zener D38 to give +10V, adjusted by means of R97 and R98 (Links LKA and LKB) and RV7 to give correct calibration. The output is +10.000V for use as a positive coarse reference. R93/R94 form a potential divider to provide +100mV for use as positive fine reference.

INVERTER

IC9 is connected as an inverter to produce - 10.000V from the REFERENCE VOLTAGE SOURCE. RV8 is adjusted to compensate for resistor tolerance and any dc offset. R104/R105 form a potential divider to provide - 100mV for use as negative fine reference.

EARTH CLAMP

During ramp-up, IC7-pin 12 goes high, thus via TR26 allowing TR15 to conduct to apply the unknown input signal to the A/D Converter. Similarly, TR16 is turned off thus unclamping the INPUT BUFFER AMPLIFIER from signal earth. At the end of ramp-up, IC7-pin 12 goes low, thus turning off TR15 and reclamping the INPUT BUFFER AMPLIFIER to earth via TR16.

INPUT BUFFER AMPLIFIER

A buffer stage providing input isolation to the INTEGRATOR (DIAGRAM 7). RV3 is provided for trimming out any internal voltage offset of IC3 while RV4 adjusts the input current compensation.

INPUT SWITCH DRIVER and INPUT SWITCH

During ramp-up, IC7-pin 18 goes low, applying the unknown input signal to the INTEGRATOR (DIAGRAM 7). TR17 is chosen such that the FET switches TR18 or TR19 in the COARSE REFERENCE SWITCHES and TR17 are of equal impedance to the INTEGRATOR (DIAGRAM 7) during both ramp-up and the appropriate coarse ramp-down period.

(Refer to the FET Selection Procedure in the APPENDIX of this manual for details of selection).

NEG. COARSE REFERENCE SWITCH

If the COMPARATOR (DIAGRAM 7) detects a positive input signal during ramp-up, IC7-pin 17 goes low during the coarse ramp-down period. This turns on TR19 applying -10.000V as a negative reference input to discharge the level (proportional to the applied input signal) stored on the integrating capacitor C21 in the INTEGRATOR (DIAGRAM 7) during ramp-up.

NEG. FINE REFERENCE SWITCH

If the input signal was negative during ramp-up, IC7-pin 14 goes low, turning on TR21 during the fine ramp-down period to apply - 100mV as a fine reference signal to the INTEGRATOR (DIAGRAM 7).

POS. COARSE REFERENCE SWITCH

If the COMPARATOR (DIAGRAM 7) detects a negative input signal during ramp-up, IC7-pin 16 goes low during the coarse ramp-down period. This turns on TR18 applying +10.000V as a positive reference input to discharge the level (proportional to the applied input signal) stored in the integrating capacitor C21 in the INTEGRATOR (DIAGRAM 7) during ramp-up.

POS. FINE REFERENCE SWITCH

If the input signal was positive during ramp-up, IC7-pin 15 goes low, turning on TR22 during the fine ramp-down period to apply + 100mV as a fine reference signal to the INTEGRATOR (DIAGRAM 7).

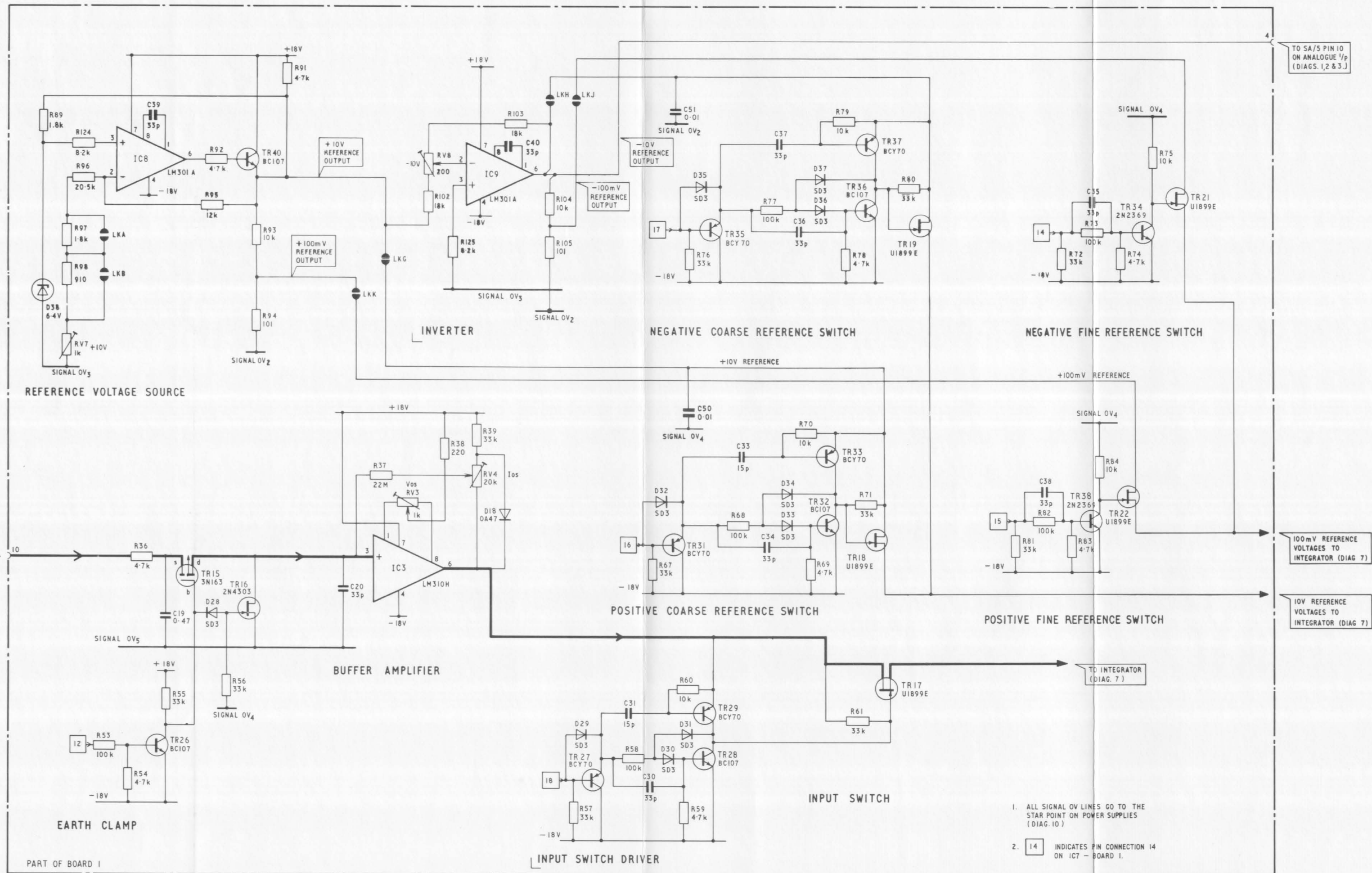

6 REFERENCE SWITCHING CIRCUIT DIAGRAM

INTEGRATOR

INTEGRATOR

IC4 is connected as an operational integrator. The signal input is applied to one side of a differential stage formed by TR23. The other input is a dc level stored in the DRIFT CORRECT circuitry by C23. This maintains the 'virtual earth' of the integrator at 0V with respect to the output of the INPUT BUFFER AMPLIFIER (DIAGRAM 6) and therefore eliminates drift.

X100 AMPLIFIER

The X100 amplifier stage is to enable the COMPARATOR to detect very low integrator outputs, thus accurately defining the end of each ramp-down period.

COMPARATOR

The output of the X100 AMPLIFIER is compared with earth; for a positive input, the output of IC6 will be negative; similarly for a negative input, the output will be positive. The purpose of the comparator is to detect when the input changes from one polarity to the other i.e. when the INTEGRATOR output passes through zero signifying the end of coarse or fine ramp-down as appropriate. The state of this output after completion of ramp-up determines the polarity of the applied coarse and fine reference drives used during the remainder of the measurement cycle. An output of $<+0.5V$ corresponds to positive polarity. A level $> +10V$ corresponds to negative polarity.

DRIFT CORRECT

Between the end of fine ramp-down and the start of the next ramp-up, IC7-pin 11 goes low, turns on TR25 and charges up C23 to the level of the combined offset errors of the INTEGRATOR and INPUT BUFFER AMPLIFIER (DIAGRAM 6) so that during the ramp-up and ramp-down periods, these offsets are compensated for.

SPOILER

At the end of ramp-up, IC7-pin 13 goes low, TR24 conducts to allow a small proportion of the INTEGRATOR output to be applied to TR23 to hold the charge on C21 until a "mains zero crossing" occurs, thus enhancing series mode rejection.

RANGE SWITCH DRIVE

When IC7 pin 3 goes low, TR30 is turned off. TR44 is turned on selecting an Integrator resistor value of $100k\Omega$ (R40//R41).

When IC7 pin 2 goes low, TR45 is turned off. TR20 is turned on selecting an Integrator resistor value of $10k\Omega$ (R118//R41).

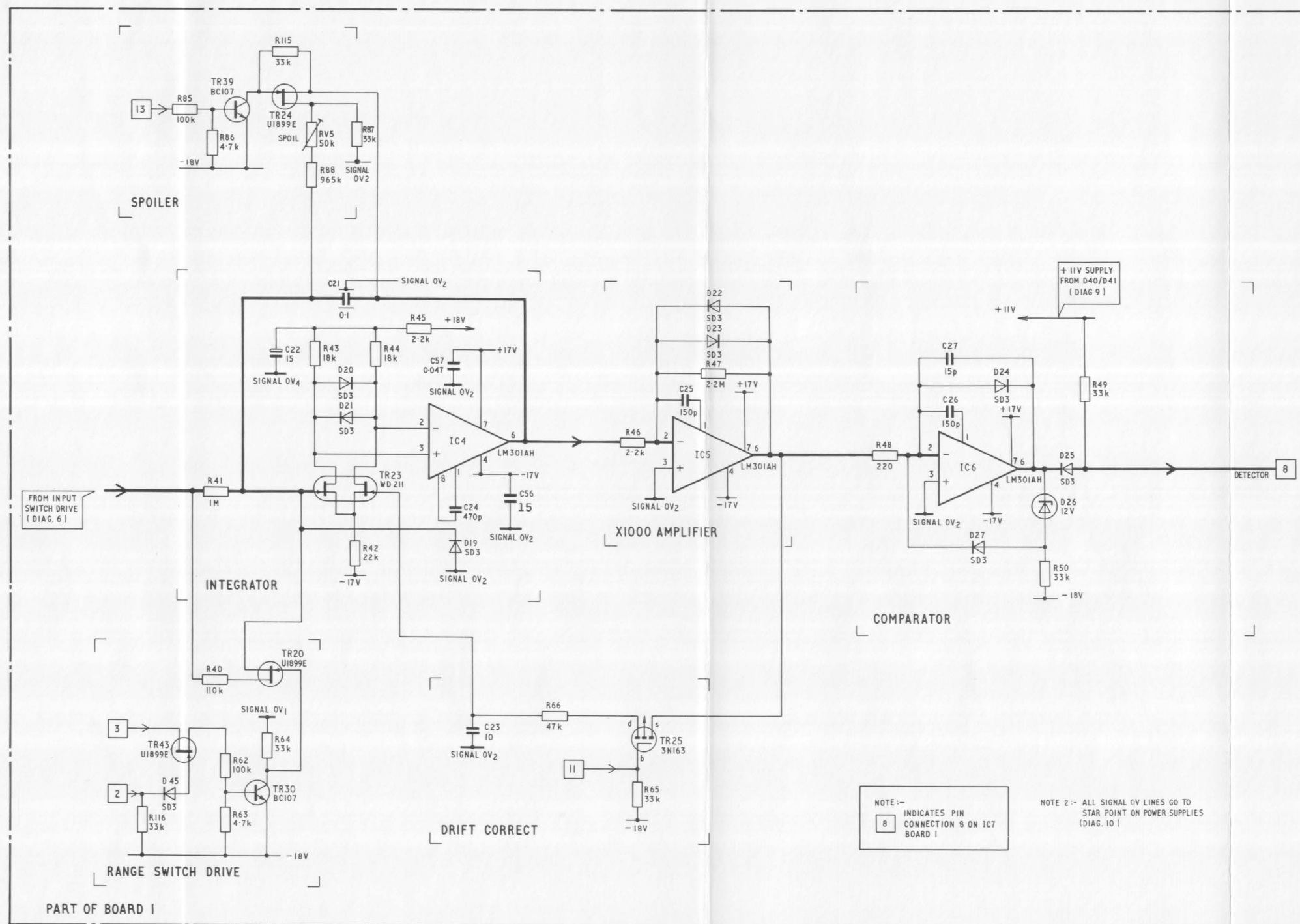

7 INTEGRATOR CIRCUIT DIAGRAM

DISPLAY

7-BAR SEGMENT DRIVERS

When the relevant output of IC7 goes Hi, the appropriate segment in the display will be lit up, provided that particular character has been selected. For example if IC7 pin 30 goes Hi all the 'g' bars will be selected instantaneously. Since only one CHARACTER DRIVER can be selected at any one time, only the 'g' bar on the selected character will be lit up.

CHARACTER DRIVERS

The characters are displayed serially commencing with the most significant. Whenever the appropriate character input goes Hi all the selected segments within that character will be energised and will light up.

UNITS ANNUNCIATOR DISPLAY

Whenever IC7 pin 28 goes Hi together with any bar segment driver representing a Unit Annunciator (d, a, e, f and p), the affected indicator will light up (mV, V, Ω , k Ω and μ A respectively).

CLOCK AND MODE SELECTION

CLOCK OSCILLATOR

A stable Ceramic Resonator controlled oscillator producing a source of timing pulses at 404kHz.

DIVIDE BY 4

A binary divider stage dividing the input signal by a factor of 4. The resultant output frequency of each output is 101kHz. Reference should be made to the text for details of the phase relationship between each output.

CLOCK DRIVERS

The input clock pulse train (101kHz) drives TR41 and TR42 on and off, forming output pulses between +11V and -18V (maximum amplitude = 28.5V) which are of sufficient amplitude to drive the clock inputs of IC7 (MOS - LSI circuits).

A second output is taken from the emitter of TR42 to provide clock pulses for the BCD Output Module.

MODE SELECTION SWITCH

At each switch position, the appropriate input of IC7 will be held low thus selecting the appropriate mode. When VDC is selected, all the mode inputs go high and the DC mode is assumed.

RELAY DRIVE

Whenever IC7-pin 38 goes high, relay RLB is energised. Diode D10 (Bd. 2) provides a discharge path for the relay coil back emf when the relay is turned off.

IC7 (MOS - LSI) INTEGRATED CIRCUIT

IC7 is illustrated with its function identities and the diagram numbers on which these functions are effected.

The logic used by IC7 is as follows.

Positive Logic:-	Bar Drivers	Negative Logic:-	The remaining functions except the following:-
	IC Drivers (Characters)		Detector
	Top Range		Line Frequency
			Clock (ϕ_1 and ϕ_2)
			Supply Rails

Supply Rail voltages are:-

Vss	=	11V Nominal
Vdd	=	-18V Nominal
Vee	=	0V

- NOTES:-
1. Terminals marked N/A are not used and must not be connected to any other part of the circuitry.
 2. Before attempting to remove this MOS Integrated Circuit ensure that all power supplies are switched off and that the necessary anti-static charge measures are taken. See warning on page 3b-5.

This sub-section deals with the POWER SUPPLIES section of the instrument whose primary function is to provide all the internal dc levels required to operate the instrument.

POWER SUPPLIES

GENERAL ARRANGEMENT

This section of circuitry provides all the dc voltage levels required to operate the instrument.

0V Rails.

Within the instrument, the common return paths (0V rails) are carefully separated to reduce interference. Care should be taken not to short these rails together other than where shown.

Split Pads LKL and LKM (pcb No. 1)

These pads enable the user to isolate the stabilised supplies from the associated section of circuitry. Since these pads are continuations of the printed circuit copper work, care should be taken not to over-heat these connections causing the track to lift away from the board.

50/60Hz SHAPER

A small proportion of the incoming mains frequency is sampled; the signal is clipped and is used by IC7 (MOS-LS1 circuit) to provide mains zero timing reference points.

VOLTAGE RAIL USAGE

The following table gives the nominal rail voltages provided and the circuit diagrams on which they appear.

+18V	4, 6, 7, 9
-18V	4, 6, 7, 9, 10
+17.5V	4, 5
-17.5V	4, 5, 9
+6V	8, 9

A nominal 10V rms output is available from transformer T1, terminals 5 and 6 for use on the BCD Output Module.

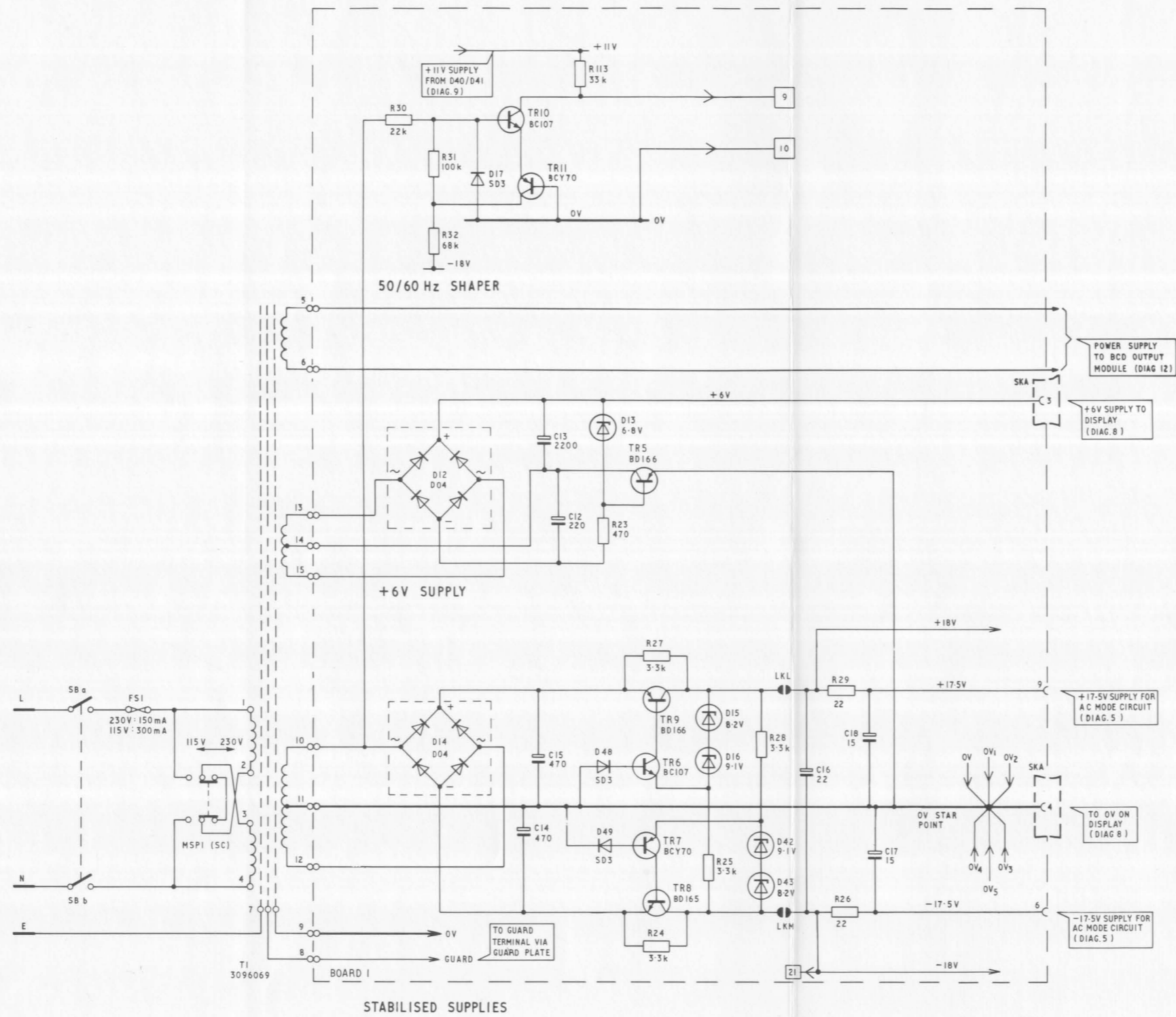

10 POWER SUPPLIES CIRCUIT DIAGRAM

SECTION 4 Setting Up & Calibration

INTRODUCTION

This section provides a comprehensive setting-up and calibration procedure which may be necessary after a rectification and/or component replacement on the Digital Multimeter.

It is divided into two parts as follows.

1. Setting-Up Procedures

These involve partial strip down of the instrument in order to effect initial adjustments of the circuit parameters.

2. Calibration Procedures

The final adjustments to provide an instrument performance which is compatible with the specification published in Section 6 of this manual.

For a normal calibration only Part 2 of this section needs to be carried out. Where an instrument fails a calibration, or has had a rectification and/or component replacement, it is advisable to carry out the full procedure detailed in this section.

NOTE:- It is essential when carrying out Part 1 or 2, that the procedure be completed, and carried out in the order given.

TEST EQUIPMENT

The test equipment used must have an accuracy uncertainty equal to or better than that shown in the calibration test tables.

The following test equipment should be available to perform the following procedures correctly.

- (a) Variac.
- (b) Digital Voltmeter (e.g. Type 7040).
- (c) Oscilloscope Type 1740 or A100.
- (d) Decade Resistance Standard (e.g. ESI Model RS624).
- (e) AC Voltage Standard (e.g. Hewlett Packard Models 745A and 746A).
- (f) Decade Voltage Divider (e.g. ESI Model RV622A).
- (g) AC Source (e.g. Bradley 232).
- (h) DC Source (e.g. Time Model 2003, $\pm 0.02\%$).
- (j) DC Voltage Standard (e.g. Kintel 351).
- (k) 1A current Source (e.g. Fluke 382A)
- (l) Resistance Standard. $1\Omega \pm 0.005\%$ 4 terminal (e.g. Cropico RS1)

- (m) Additional items:- Resistor, 1k ohm \pm 10% (0.125W).
 Resistor, 27k ohm \pm 10% (0.125W).
 Resistor, 1M ohm \pm 10% (0.125W).
 Capacitor 1 μ F (non-polarised).

PART 1. SETTING UP PROCEDURES

PRELIMINARY

1. Prepare the instrument as follows:-

CAUTION:- IT IS ESSENTIAL THAT THE INSTRUMENT BE ISOLATED FROM THE MAINS SUPPLY BEFORE OUTER CASE REMOVAL, DUE TO THE UNCOVERED TERMINALS ON THE ON/OFF SWITCH.

CAUTION:- BEWARE OF GUARD POTENTIAL ON GUARD PLATE WITH INSTRUMENT CASE REMOVED.

- a. Remove the 4, 2.5mm screws holding the outer case to the rear panel assembly, Fig. 4.1.



Fig. 4.1. View of Rear Panel, showing location of the 4 securing screws.

- b. Select the 'V.DC' mode (This orientates the selector switch shaft with it's key flat facing upwards).
 - c. Remove the GUARD - Lo link (if fitted).
 - d. Gently ease out the pcb and rear panel assembly away from the front panel. Fig. 4.5, at rear of section, shows the location and function of each potentiometer.
 - e. Remove the 2 sets of Berg pins and the 4 screws attaching pcb 2 to pcb 1. Remove pcb 2.
2. Link Berg socket 2 to Berg socket 10.
 3. Check that the Mains Selector in the rear panel is set to the appropriate voltage, and that the correct rated fuse is fitted.

For 230V:-	150mA	SLO BLO FUSE
115V:-	300mA	SLO BLO FUSE

4. Apply power to the instrument and allow a sufficient warm up period.
5. Check that the rail voltages are within the limits specified over the input voltage range as follows.

For 230V:-	195.5 to 253 Volts.
115V:-	97.75 to 126.5 Volts.

TEST BETWEEN	LIMITS OVER MAINS VARIATION	
	MINIMUM	MAXIMUM
C16 (+ve) to C18 (-ve)	+16.0V	+18V
C16 (-ve) to C18 (-ve)	-16.0V	-18V
C13 (+ve) to C18 (-ve)	+5.7V	+7.0V
C45 (+ve) to C45 (-ve)	+25V	+30V
C52 (+ve) to C52 (-ve)	+4.75V	+5.35V

BUFFER Vos Ios

1. Select 'V.DC' mode. Short circuit Berg sockets 2 and 10. Connect voltmeter between Berg socket 2 and D18 cathode, via a 1k ohm resistor.
2. Adjust RV3 for $0 \pm 20\mu\text{V}$ on voltmeter. Replace the link between Berg sockets 2 and 10 by a 27k ohm resistor.
3. Adjust RV4 for $0 \pm 10\mu\text{V}$ on the voltmeter. Remove voltmeter and two resistors (27k ohm and 1k ohm).

POSITIVE REFERENCE

Select 'V.DC' mode. Using the DC Standard and the Decavider, apply -10V , -1V and -100mV in turn to Berg sockets 2 and 10 (-ve to socket 10), adjusting RV7 to share the error between the three voltage levels evenly as follows:-

- 10.000V ± 2 bits
- 1.0000V ± 2 bits
- 100.00mV ± 2 bits

NOTE:- If RV7 does not have enough adjustment, the links LKA and LKB will require re-adjustment as follows:-

- a. Connect -10V ($\pm 0.02\%$ absolute) from DC Standard to Berg sockets 2 and 10 (-ve to socket 10).
- b. Ensure that links LKA and LKB are open circuit and that RV7 is at maximum resistance (fully clockwise).
- c. Apply -10V standard and note the reading. Look up the range which includes this reading in Table 4.1 and set links LKA and LKB accordingly.

READING RANGES		LINKS	
		A	B
10000	10142	1	1
10129	10283	1	0
10266	10433	0	1
10417	10599	0	0

Legend
0 = Short Circuit

Table 4.1

- d. Repeat the -10V , -1V and -100mV test as detailed previously.

RE-ASSEMBLY

1. Fit pcb 2 to pcb 1, securing it by the 4 screws.
2. Fit the link between GUARD and LO terminals and insert the 2 sets of Berg pins into their sockets, ensuring they are fully engaged.

INPUT AMPLIFIER

NOTE:- The waveform at TR3 collector, using a dc coupled oscilloscope set to 1V/cm and 1ms/cm, should be a square wave; amplitude $4V \pm 0.4V_{pp}$, period $4ms \pm 1ms$, mark/space ratio $1 : 1 \pm 10\%$.

1. Select 'V.DC' mode and short circuit the input terminals. Ensure that RV1 range of adjustment is greater than $\pm 80\mu V$.
2. Remove the short circuit from the input terminals. Apply $+100\mu V$ and $-100\mu V$ alternately to the input terminals, using a dc source having an output resistance of 10k ohms.
3. Adjust RV1 for equal positive and negative readings.
4. Remove dc source and connect a 1M ohm resistor and $1\mu F$ non-polarised capacitor in parallel between the Hi and Lo terminals.
5. Adjust RV2 for a zero reading, $\pm 10\mu V$. Remove resistor and capacitor.
6. Repeat tests 2 to 5 inclusive until the errors are within the limits:-

Input:- $+100\mu V/-100\mu V$	Reading:- $0.10mV \pm 1 \text{ bit}$
Input:- $1M\Omega//1\mu F$	Reading:- $0.00mV \pm 10 \text{ bits}$

NOTE:- If adjustment is necessary repeat operations 2 to 5 inclusive.

7. Remove the dc source.

NEGATIVE REFERENCE

1. Select 'V.DC' mode.
2. Connect $10V \pm 0.02\%$ absolute across the 6 decade Decavider, using the DC Standard.
3. Apply $+10V, -10V, +1V, -1V, +100mV$ and $-100mV$ dc in turn to the input terminals.
4. Adjust on RV8 to make the negative reading equal to the positive reading at each voltage level.
5. Share errors between RV7 and RV8 such that the:-

$\pm 10V$ Inputs read	$\pm 10.000 \pm 2 \text{ bits}$
$\pm 1V$ Inputs read	$\pm 1.0000 \pm 2 \text{ bits}$
$\pm 100mV$ Inputs read	$\pm 100.00 \pm 2 \text{ bits}$

NOTE:- Problems in meeting these limits will result if the 'ON' resistance of TR's 17, 18, 19 and 20 are not matched. See Appendix.

LINEARITY

1. Select 'V.DC' mode. With the 10V DC Standard and Decavider connected to the input terminals as in previous test, check the linearity in accordance with Table 4.2.

INPUT	READING	TOLERANCE
10.0	10.000V	± 3 bits
5.0	5.000V	± 2 bits
1.05	1.050V	± 1 bit
	RANGE CHANGE	
0.95	950.0mV	± 2 bits
1.05	1.0500V	± 2 bits
	RANGE CHANGE	
1.15	1.150V	± 1 bit
	RANGE CHANGE	
0.5	500.00mV	± 2 bits
	RANGE CHANGE	
0.095	95.00mV	± 2 bits
0.01	10.00mV	± 2 bits
0.001	1.00mV	± 2 bits
0.0001	0.10mV	± 2 bits
0.00005	0.05mV	± 2 bits
0.00003	0.03mV	± 2 bits
0.00002	0.02mV	± 2 bits
0.00001	0.01mV	± 2 bits

Table 4.2

2. Repeat for negative values using the same voltage source.
3. If the DMM falls outside the linearity tolerances, it is recommended that the Setting Up Procedure should be repeated.

OHMS MODE

1. Set to 'Ω' mode and short circuit the input terminals. The reading should be 0 ± 3 bits.
2. Connect 100k ohms $\pm 0.01\%$ absolute across the input terminals. Adjust RV2 (pcb 2) to obtain 100.00kΩ reading.

DC ATTENUATOR

Select 'V.DC' mode and connect input terminals to 100V $\pm 0.01\%$ absolute. Adjust RV1 (pcb 2) to give 100.00V reading.

DC μ A

Select ' μ A.DC' mode and connect input to 1000 μ A $\pm 0.01\%$ absolute current source (100k ohms from 100V is convenient). Adjust RV6 (pcb 2) to give 1000.0 μ A ± 1 bit reading.

DC mA

1. Select 'mA DC' mode, and open circuit terminals. Reading should be $0.000\text{mA} \pm 10$ bits (excluding noise, which should not exceed 14 bits). Adjust RV1 as required.

Note: If adjustment of RV1 is necessary to achieve the specified reading, the INPUT AMPLIFIER checks and adjustment will have to be repeated.

2. Connect 95/950mA Current Source in series with $1\Omega \pm 0.01\%$ Standard Resistor to the input terminals, monitoring the voltage across the Resistor with a voltmeter calibrated to $\pm 0.01\%$ accuracy (e.g. 7050 dvm).
3. Adjust the current source for a nominal $500.0\text{mV} \pm 10\%$ reading on the monitor voltmeter. Adjust RV9 on pcb 2 to give the same reading of $500.0\text{mA} \pm 1$ bit.
4. Increase the current to $950\text{mA} \pm 10\%$ and check that the reading will hold for 1 minute.
5. Remove the Current Source.

AC ZERO

Switch to 'V.AC' mode. Short circuit TR1 (pcb 2) collector (case) to 0V. Adjust RV4 until the readings stop reducing. Reading must be less than 5 bits. Remove the short circuit.

AC SCALE

1. Select 'V.AC' mode. Connect the input $1\text{V} \pm 0.1\%$ absolute 1kHz sinewave. On pcb 2, adjust RV3 to give $1.0000\text{V} \pm 5$ bits.

AC ATTENUATOR

1. Select 'V.AC' mode. Connect the input to $10\text{V} \pm 0.2\%$ absolute 1kHz sinewave. Adjust RV5 (pcb 2) to obtain $10.000\text{V} \pm 5$ bits.

INTERFERENCE REJECTION

SERIES MODE

1. Connect instrument as shown in Fig. 4.2.

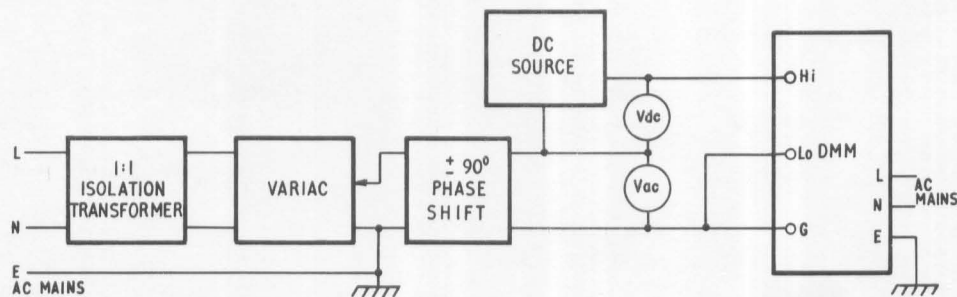

Fig. 4.2. Interference Rejection:- Series Mode Test Circuit.

2. Switch to 'V.DC' mode and set (V.dc) to approximately 500mV and (V.ac) to zero. Note the instrument reading.
3. Increase (V.ac) to 1 Volt. Reading must not change by more than 1mV.

COMMON MODE

AC Rejection

1. Connect instrument as shown in Fig. 4.3.

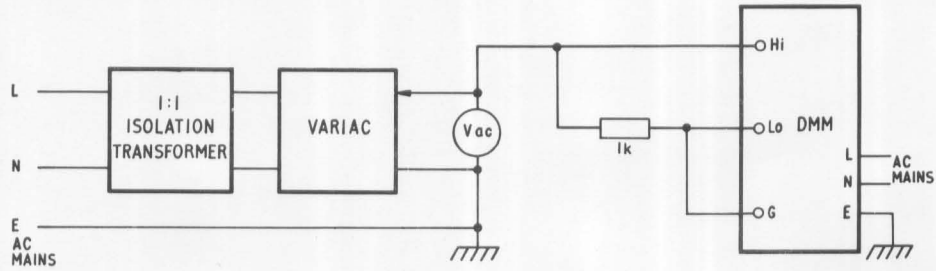

Fig. 4.3. Interference Rejection:- Common Mode (ac) Test Circuit.

2. Switch to 'V.AC' mode and set (V.ac) to 100V. Reading shall be less than 100mV.

DC Rejection

1. Connect instrument as shown in Fig. 4.4.

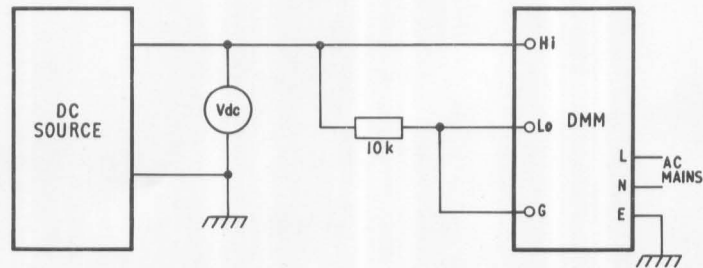

Fig. 4.4. Interference Rejection:- Common Mode (dc) Test Circuit.

2. Switch to 'V.DC' mode and set (V.dc) to 500V. Reading shall be less than 5mV.

This concludes the setting up of the DMM and it should now be followed by a full calibration.

PART 2. CALIBRATION PROCEDURES

INTRODUCTION

The following calibration is basically the final calibration to which all instruments are subjected, prior to despatch from the factory.

For the greatest accuracy the DMM should be removed from its case and fitted into a Setting Up Case, Part No. 70502 before a calibration is attempted. Failing this, allowances must be made for variations in the working temperatures.

See Appendix for details of Setting Up Case.

PRELIMINARY PROCEDURE

The DMM will have to be removed from its case and fitted into the Setting Up Case (if available).

CAUTIONARY NOTES

1. IT IS ESSENTIAL THAT THE INSTRUMENT BE COMPLETELY ISOLATED FROM THE MAINS SUPPLY BEFORE REMOVING THE CASE, DUE TO THE POSITION AND UNPROTECTED NATURE OF THE ON/OFF SWITCH TERMINALS.
2. BEWARE OF THE GUARD PLATE POTENTIAL WITH INSTRUMENT CASE REMOVED.
 1. Remove the 4, 2.5mm screws which secure the DMM case to the rear panel. See Fig. 4.1.
 2. Remove the GUARD - Lo link (if fitted).
 3. Gently ease out the rear panel and pcb assembly, away from the front panel.
 4. Fit assembly into the Setting Up Case (if available), or position assembly in convenient position with the guard plate insulated if required and with easy access to the potentiometers.
 5. Ensure that the correct mains selection has been made and that the correct rated fuse is fitted.

For	230V:-	150mA SLO BLO
	115V:-	300mA SLO BLO

CALIBRATION

The calibration sequence must be carried out in the order given. Calibration should be carried out at an ambient temperature $23^{\circ}\text{C} \pm 1^{\circ}\text{C}$ after a warm-up period of approximately half an hour in the Setting-Up Case.

STANDARD SETTINGS

During the warm up period the DMM should be set to the following standard conditions.

1. Mode set to 'V.DC'.
2. Input terminals short circuited.
3. Apply power to the DMM and switch instrument ON.

CALIBRATION PROCEDURE 1

Select 'V.DC' on Mode Selector

TEST	INPUT		OPERATION	READING		RESULT
	VALUE	± %		VALUE	± bits	
1	1MΩ//1μF	10	Adj. Bd.1/RV2.	± 0.00mV	2	
2	S/C	—	Adj. Bd.1/RV1.	± 0.00mV	0	
3	1MΩ//1μF	10	Adj. Bd.1/RV2.	± 0.00mV	10	
4	+0.10mV	2	Adj. Bd.1/RV1 and repeat for equal +ve and -ve readings.	0.10mV	2	
5	-0.10mV	2		-0.10mV	2	
6	S/C	—	Check.	± 0.00mV	2	
7	+9.500V	0.004	Adj. Bd.1/RV7. (1)	9.500V	1	
8	+9.500V	0.004	Check, with 1MΩ in series.	9.500V	5	
9	-9.500V	0.004	Adj. Bd.1/RV8. (1)	-9.500V	2	

NOTES:-

- (1) Adjust for equal reading, split any deviations equally between readings.

CALIBRATION PROCEDURE 2

Select 'Ω' on Mode Selector

TEST	INPUT		OPERATION	READING		RESULT
	VALUE	± %		VALUE	± bits	
1	105.00kΩ	0.01	Adj Bd 2/RV2	105.00kΩ	1	
2	50.00kΩ	0.01	Check	50.00kΩ	2	
3	5.000kΩ	0.01	Check	5.000kΩ	3	
4	10.500kΩ	0.01	Check	10.500kΩ	4	
5	867.8Ω	0.01	Check	867.8Ω	5	
6	1.0500kΩ	0.01	Check	1.0500kΩ	6	
7	O/C	—	Overload Check (1)	1----- kΩ	—	
8	S/C	—	Check	0.0Ω	3	

NOTES:-

- (1) Ensure that overload condition is indicated by a steady '1' being displayed and that the remaining 4 characters are blanked out.

CALIBRATION PROCEDURE 3

Select 'V.DC' on Mode Selector

TEST	INPUT		OPERATION	READING		RESULT
	VALUE	± %		VALUE	± bits	
1	+9.500V	0.004	Check.	9.500V	2	
2	+1.200V	0.004	Check.	1.200V	1	
3	+0.9500V	0.004	Check.	950.0mV	2	
4	+120.0mV	0.004	Check.	120.0mV	1	
5	+10.00mV	0.02	Check.	10.00mV	2	
6	+95.00mV	0.004	Check.	95.00mV	3	
7	-9.500V	0.004	Check.	-9.500V	2	
8	-1.200V	0.004	Check.	-1.200V	1	
9	-0.9500V	0.004	Check.	-950.0mV	2	
10	-120.0mV	0.004	Check.	-120.0mV	1	
11	-10.00mV	0.02	Check.	-10.00mV	2	
12	-95.00mV	0.004	Check.	-95.00mV	3	
13	+95.00V	0.004	Adj. Bd.2/RV1.	95.00V	2	
14	+1000.0V	0.005	Check.	1000.0V	5	
15	-120.0V	0.004	Check.	-120.0V	1.5	

CALIBRATION PROCEDURE 4

Select 'Ω' on Mode Selector

TEST	INPUT		OPERATION	READING		RESULT
	VALUE	± %		VALUE	± bits	
1	500.0kΩ	0.01	Check	500.0kΩ	2	
2	1.0500MΩ	0.01	Check	1050.0kΩ	4	
3	10.000MΩ	0.05	Check	1000kΩ	10	
4	5.000MΩ	0.05	Check	5000kΩ	7	

CALIBRATION PROCEDURE 5

Select ' μ A.DC' on Mode Selector

TEST	INPUT		OPERATION	READING		RESULT
	VALUE	\pm %		VALUE	\pm bits	
1	O/C	—	Check.	0.000 μ A	2	
2	+1.0000mA (1)	0.01	Adj.Bd.2/RV6 (5)	1000.0 μ A	4	
3	+9.000 μ A (2)	0.001	Check.	9.000 μ A	5	
4	+1.000 μ A (3)	0.05	Check.	1.000 μ A	2	
5	-20V	10	Overload check. (4)	-1----- μ A	—	
6	-1.0000mA (1)	0.01	Check.	-1000.0 μ A	4	
7	-9.000 μ A (2)	0.01	Check.	-9.000 μ A	5	
8	-1.000 μ A (4)	0.05	Check.	-1.000 μ A	2	

NOTES:-

- (1) Recommend 100V source via a 100k ohm resistor.
- (2) Recommend 9V source via a 1M ohm resistor.
- (3) Recommend 1V source via a 1M ohm resistor.
- (4) Ensure that overload is indicated by flashing '1' with the remaining 5 characters blanked out.
- (5) For adjustment of this potentiometer the case must be removed.

CALIBRATION PROCEDURE 6

Select 'mADC' on Mode Selector

TEST	INPUT		OPERATION	READING		RESULTS
	VALUE	\pm %		VALUE	\pm bits	
1	O/C	—	Check	\pm 0.000mA	30	
2	95.00mA	0.01	Check	95.00mA	7	

Potentiometer RV2(Lo.Ω)
Defines the 100μA reference current from -10V reference in 'Ω' mode (DIAG.2)

Potentiometer RV9 (mA)
Adjusts amplifier gain on mA ranges (DIAG.3)

Potentiometer RV6 (μA)
Sets the 1000μA scaling (DIAG.3)

Potentiometer RV5 (100V.AC)
Sets the 100V ac scaling (DIAG.6).

Potentiometer RV7 (+10V)
Sets the +10V reference voltage output for coarse ramp down (DIAG.7)

Potentiometer RV8 (-10V)
Sets the -10V reference voltage output for coarse ramp down (DIAG.7)

Potentiometer RV3 (1V.AC)
Sets the 1V ac scaling (DIAG.5)

Potentiometer RV1 (Hi.V)
Adjusts the value of dc attenuation (DIAG.1)

Potentiometer RV1 (Vo)
Compensates for the Input Amplifier (DIAG.4) offset voltage.

Potentiometer RV2(1o)
Compensates for the Input Amplifier (DIAG.4) offset current.

Potentiometer RV4 (1os)
Compensates for Buffer Amplifier (DIAG.6) offset current.

Potentiometer RV3 (Vos)
Compensates for Buffer Amplifier (DIAG.6) offset voltage.

HIGH VOLTAGE WARNING
Bare terminals on this switch are at mains potential.

HIGH VOLTAGE WARNING
This Guard Plate is at the same potential as input Lo, not earth.

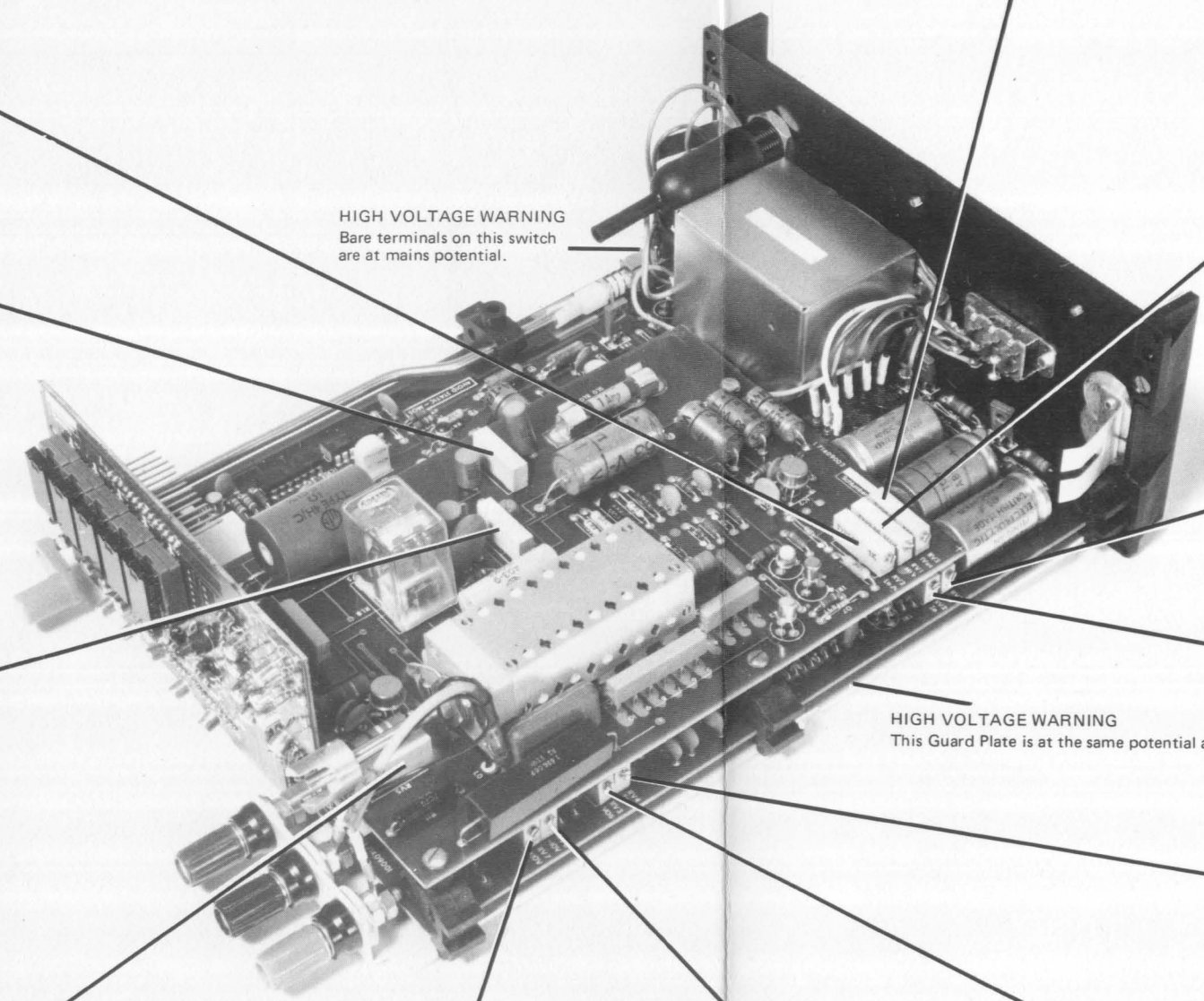

Fig. 4.5. View of PCB Assembly, identifying the Potentiometers and their Functions.

CALIBRATION PROCEDURE 7

Select 'VAC' on Mode Selector

TEST	INPUT		OPERATION	READING		RESULT
	VALUE	±%		VALUE	±bits	
1	0.9500V	0.02	At 1kHz Adjust Bd.2/RV3	950.0mV	3	
2	1.00mV	1	At 1kHz Adjust Bd.1/RV4	1.00mV	2	
3	S/C	—	Check	0.00	7	
4	500.0mV	0.02	At 1kHz Check	500.0mV	6	
5	95.00mV	0.02	At 1kHz Check	95.00mV	10	
6	0.9500V	0.05	At 40kHz Check	950.0mV	12	
7	0.9500V	0.05	At 20kHz Check	950.0mV	12	
8	0.9500V	0.02	At 10kHz Check	950.0mV	12	
9	95.00mV	0.02	At 10kHz Check	95.00mV	15	
10	9.500V	0.02	At 1kHz Adjust Bd.2/RV5	9.500V	2	
11	95.00V	0.02	At 1kHz Check	95.00V	10	
12	1.200V	0.02	At 1kHz Check	1.200V	6	
13	9.500V	0.02	At 10kHz Check	9.500V	18	
14	95.00V	0.02	At 10kHz Check	95.00V	15	
15	750.00V	0.05	At 1kHz Check	750.00V	12	
16	500.0V	0.05	At 10kHz Check	500.0V	10	
17	9.500V	0.02	At 20kHz Check	9.500V	18	

NOTES:-

- (1) For adjustment of this potentiometer the case must be removed.

This concludes the calibration of the DMM. If the instrument fails any of the prescribed tests it is suggested that the Setting Up Procedures in Section 4 be carried out, followed by a further calibration before any fault diagnosis is attempted.

The serviceable DMM should now be isolated from the supplies and refitted into its case.

NOTE:- Ensure that 'V.DC' is selected on both the switch and the front panel knob to ensure correct mating of the key flat.

SECTION 5 Parts Lists

This section contains detailed parts lists for each of the printed circuit boards fitted in the instrument. When ordering spare parts, it is essential to quote the instrument serial number, located on the rear panel, as well as the full description shown in the appropriate parts list.

COMPONENT PARTS LIST ABBREVIATIONS

CIRCUIT REFERENCES

AE	Aerial	R	Resistor (Ω)
B	Battery	RE	Recording Instrument
C	Capacitor (μ F)	RL	Relay
CSR	Thyristor	S	Switch
D	Diode	SK	Socket
FS	Fuse	T	Transformer
IC	Integrated Circuit	TP	Terminal Post (or Test Point)
L	Inductor	TR	Transistor
LP	Lamp (including Neon)	V	Valve
LK	Link	X	Other Components
M	Motor		
ME	Meter		
MSP	Mains Selector Panel	Also Used:-	
PL	Plug	RNL	Non Linear Resistor (Ω)
		RV	Variable Resistor (Ω)

COMPONENT TYPES

Fixed Resistors

Carbon Composition
Carbon Film
Cracked Carbon
Metal Film
Metal Oxide
Power Wirewound
Precision Wirewound
Temperature Sensitive
Thick Film
Thin Film
Voltage Sensitive

Variable Resistors

CACP Carbon Front Panel Multiturn
CAFM Carbon Front Panel Single Turn
CKCA Carbon Preset Multiturn
MEFM Carbon Preset Single Turn
MEOX Cermet Front Panel Multiturn
POWW Cermet Front Panel Single Turn
PRWW Cermet Preset Multiturn
TEMP Cermet Preset Single Turn
TKFM Wirewound Front Panel Multiturn
TNFM Wirewound Front Panel Single Turn
VOLT Wirewound Preset Multiturn
Wirewound Preset Single Turn

Capacitors

Air
Aluminium Electrolytic
Aluminium Solid
Polycarbonate
Ceramic
Polyester Foil
Polyester Metallised
Glass
Mica
Metallised Lacquer
Paper Foil
Paper Metallised
PTFE
Polypropylene Film
Polystyrene
Tantalum Dry
Tantalum Foil
Tantalum Wet

AIR
ALME
ALMS
CARB
CERM
ESTF
ESTM
GLAS
MICA
MLAC
PAPF
PAPM
PTFE
PYLN
STYR
TAND
TANF
TANW

PCB No. 1

Cct Ref	General Description					Solartron Part No.	Cct Ref.	General Description					Solartron Part No.
R1	CACP	1000	1/8W	10%	172031000	R79	CACP	10k	1/8W	10%	172041000		
R2	CACP	470	1/8W	10%	172024700	R80	CACP	33k	1/8W	10%	172043300		
R3	CACP	47k	1/8W	10%	172044700	R81	CACP	33k	1/8W	10%	172043300		
R4	CACP	47k	1/8W	10%	172044700	R82	CACP	100k	1/8W	10%	172051000		
R5	CACP	10	1/8W	10%	172011000	R83	CACP	4.7k	1/8W	10%	172034700		
R6	CACP	1.5M	1/8W	10%	172061500	R84	CACP	10k	1/8W	10%	172041000		
R7	CACP	220k	1/8W	10%	172052200	R85	CACP	100k	1/8W	10%	172051000		
R8	CACP	22	1/8W	10%	172012200	R86	CACP	4.7k	1/8W	10%	172034700		
R9	CACP	220k	1/8W	10%	172052200	R87	MEFM	33k	1/8W	0.5%	192743302		
R10	CACP	2.2k	1/8W	10%	172032200	R88	MEFM	990k	1/4W	0.25%	160400488		
R11	CACP	220k	1/8W	10%	172052200	R89	MEFM	1.8k	1/4W	0.5%	198231801		
R12	CACP	220k	1/8W	10%	172052200								
R13	CACP	100	1/8W	10%	172021000	R91	CACP	4.7k	1/8W	10%	172034700		
R14 to R19	MEOX	22k	1/4W	5%	195642200	R92	CACP	4.7k	1/8W	10%	172034700		
R20	MEOX	9.1k	1/4W	5%	195639100	R93	MEFM	10k	1/8W	.25%	192841002		
R21	MEOX	9.1k	1/4W	5%	195639100	R94	MEFM	101	1/8W	.25%	192821012		
R22	MEOX	100k	1/4W	5%	195651000	R95	MEFM	12k	1/10W	0.5%	169607901		
R23	MEOX	470	1/2W	5%	193524700	R96	MEFM	20.5k	1/10W	0.5%	169607901		
R24	CACP	3.3k	1/4W	10%	172333300	R97	MEFM	1.8k	1/8W	1%	192731801		
R25	CACP	3.3k	1/4W	10%	172333300	R98	MEFM	910	1/8W	1%	192729101		
R26	CACP	22	1/8W	10%	172012200	R102	MEFM	18k	1/10W	0.5%	169607301		
R27	CACP	3.3k	1/4W	10%	172333300	R103	MEFM	18k	1/10W	0.5%	169607301		
R28	CACP	3.3k	1/4W	10%	172333300								
R29	CACP	47	1/8W	10%	172014700	R104	MEFM	10k	1/8W	.25%	192841002		
R30	CACP	22k	1/8W	10%	172042200	R105	MEFM	101	1/8W	.25%	192821012		
R31	CACP	100k	1/8W	10%	172051000	R106	CACP	470	1/8W	10%	172024700		
R32	CACP	68k	1/8W	10%	172046800	R107	CACP	2.2k	1/8W	10%	172032200		
R36	CACP	4.7k	1/8W	10%	172034700	R108	CACP	8.2k	1/8W	10%	172038200		
R37	CACP	22M	1/4W	10%	172372200	R109	CACP	8.2k	1/8W	10%	172038200		
R38	CACP	220	1/8W	10%	172022200	R110	CACP	47k	1/8W	10%	172044700		
R39	CACP	33k	1/8W	10%	172043300	R111	CACP	47k	1/8W	10%	172044700		
R40	MEFM	110k	1/4W	0.5%	198251101	R112	MEOX	1000	1/4W	5%	195631000		
R41	MEFM	1M	1/4W	1%	198361002	R113	CACP	33k	1/8W	10%	172043300		
R42	MEOX	22k	1/4W	5%	195642200	R115	CACP	33k	1/8W	10%	172043300		
R43	MEFM	18k	1/8W	0.5%	192741802	R117	MEFM	100	1/4W	0.5%	192721002		
R44	MEFM	18k	1/8W	0.5%	192741802	R118	MEFM	10k	1/4W	0.5%	198241001		
R45	CACP	2.2k	1/8W	10%	172032200	R119	CACP	33k	1/8W	10%	172043300		
R46	CACP	2.2k	1/8W	10%	172032200	R120	CACP	100k	1/8W	10%	172051000		
R47	CACP	220k	1/8W	10%	172052200	R121	CACP	4.7k	1/8W	10%	172034700		
R48	CACP	220	1/8W	10%	172022200	R122	CACP	10k	1/8W	10%	172041000		
R49	CACP	33k	1/8W	10%	172043300	R123	CACP	10k	1/8W	10%	172041000		
R50	CACP	33k	1/8W	10%	172043300	R124	CACP	8.2k	1/8W	10%	172038200		
R53	CACP	100k	1/8W	10%	172051000	R125	CACP	8.2k	1/8W	10%	172038200		
R54	CACP	4.7k	1/8W	10%	172034700								
R55	CACP	33k	1/8W	10%	172043300	C1	ESTM	.22	100V	10%	225452200		
R56	CACP	33k	1/8W	10%	172043300	C2	ESTM	.047	100V	10%	225444700		
R57	CACP	33k	1/8W	10%	172043300	C3	TANW	330	6V	10%	265183300		
R58	CACP	100k	1/8W	10%	172051000	C4	CERM	3.3p	200V	15%	240603300		
R59	CACP	4.7k	1/8W	10%	172034700	C5	ESTM	0.47	63V	10%	225154700		
R60	CACP	10k	1/8W	10%	172041000	C6	TANW	47	6V	20%	265274700		
R61	CACP	33k	1/8W	10%	172043300	C7	CERM	150p	500V	20%	241321500		
R62	CACP	100k	1/8W	10%	172051000	C8	CERM	15p	500V	20%	241311500		
R63	CACP	4.7k	1/8W	10%	172034700	C9	ESTM	.47	63V	10%	225154700		
R64	CACP	33k	1/8W	10%	172043300	C10	CERM	2.2p	200V	15%	240602200		
R65	CACP	33k	1/8W	10%	172043300	C11	ESTM	.47	63V	10%	225154700		
R66	CACP	1M	1/8W	10%	172061000	C12	ALME	220	16V	-20%	273382200		
R67	CACP	33k	1/8W	10%	172043300								
R68	CACP	100k	1/8W	10%	172051000	C13	ALME	2200	10V	-10%	273192200		
R69	CACP	4.7k	1/8W	10%	172034700								
R70	CACP	10k	1/8W	10%	172041000	C14	ALME	470	40V	-10%	273784700		
R71	CACP	33k	1/8W	10%	172043300								
R72	CACP	33k	1/8W	10%	172043300								
R73	CACP	100k	1/8W	10%	172051000	C15	ALME	470	40V	-10%	273784700		
R74	CACP	4.7k	1/8W	10%	172034700								
R75	CACP	10k	1/8W	10%	172041000								
R76	CACP	33k	1/8W	10%	172043300	C16	ALME	22	40V	-10%	273772200		
R77	CACP	100k	1/8W	10%	172051000								
R78	CACP	4.7k	1/8W	10%	172034700								
						C17	TANW	15	20V	20%	265871500		
						C18	TANW	15	20V	20%	265871500		
						C19	ESTM	0.47	63V	10%	225154700		
						C20	CERM	33p	500V	20%	241313300		
						C21	PTFE	.1	100V	2%	208950001		
						C22	TANW	15	20V	20%	265871500		
						C23	ESTM	4.7	63V	20%	219964700		
						C24	CERM	470p	500V	20%	241324700		

Cct Ref.	General Description					Solartron Part No.	Cct Ref.	General Description					Solartron Part No.
C25	CERM	150p	500V	20%	241321500	TR1	40673					300555210	
C26	CERM	150p	500V	20%	241321500	TR2	40673					300555210	
C27	CERM	15p	500V	20%	241311500	TR3	BC107					300553320	
C30	CERM	33p	500V	20%	241313300	TR4	BC107					300553320	
C31	CERM	15p	500V	20%	241311500								
C33	CERM	15p	500V	20%	241311500	TR5	BD166					300555150	
C34						TR6	BC107					300553320	
to						TR7	BCY70					300553590	
C40	CERM	33p	500V	20%	241313300	TR8	BD165					300555160	
C41	CERM	100p	500V	20%	241321000	TR9	BD166					300555150	
						TR10	BC107					300553320	
						TR11	BCY70					300553590	
						TR12	MPS-A-13					300554560	
C42	CERM	.047	25V	+50% -25%	241944700	TR13	BC107					300553320	
						TR14	BC107					300553320	
C43	CERM	470p	500V	20%	241324700	TR15	3N163					300554530	
C44	CERM	.047	25V	+50% -25%	241944700	TR16	2N4303					300553160	
C45	TANW	4.7	35V	20%	266064700	TR17							
						to	U1899E					300554320	
C46						TR22							
to						TR23	WD211					300555060	
C48	CERM	1000p	500V	20%	241331000	TR24	U1899E					300554320	
C50	CERM	0.01	25V	-25% +50%	241941000	TR25	3N163					300554530	
						TR26	BC107					300553320	
C51	CERM	0.01	25V	-25% +50%	241941000	TR27	BCY70					300553590	
						TR28	BC107					300553320	
C52	TANW	15	20V	20%	265871500	TR29	BCY70					300553590	
C53	ESTM	0.033	100V	10%	225443300	TR30	BC107					300553320	
						TR31	BCY70					300553590	
C54	CERM	3.3p	200V	15%	240603300	TR32	BC107					300553320	
C55	CERM	3.3p	200V	15%	240603300	TR33	BCY70					300553590	
C56	TANW	15	20V	+20%	265871500	TR34	2N2369					300552390	
C57	CERM	0.047	25V	+50% -25%	241944700	TR35	BCY70					300553590	
						TR36	BC107					300553320	
D1	SD3				300522160	TR37	BCY70					300553590	
D2	SD3				300522160	TR38	2N2369					300552390	
D3	IN3595				300523590	TR39							
D4	IN3595				300523590	to	BC107					300553320	
						TR42							
D5	Zener	12V	.4W	5%	300521480	TR44	U1899E					300554320	
D6	Zener	12V	.4W	5%	300521480	TR45	BC107					300553320	
D7	SD3				300522160								
D8	SD3				300522160	IC1	LM301AH					510000620	
D9	SD3				300522160	IC2	LM301AH					510000620	
D10	Zener	3.9V	.4W	5%	300521420	IC3	LM310H					510090040	
D11	Zener	3.9V	.4W	5%	300521420	IC4	LM301AH					510000620	
D12	W04				300524700	IC5	LM301AH					510000620	
						IC6	LM301AH					510000620	
D13	Zener	6.8V	.4W	5%	300522540	IC7	MOS Logic					519600304	
D14	W04				300524700	IC8	LM301AH					510000620	
D15	Zener	8.2V	.4W	5%	300521330								
D16	Zener	9.1V	.4W	3%	300525590	IC9	LM301AH					510000620	
						IC10	SN74LS00N					510002000	
D17	SD3				300522160	IC11	SN74L74N					510001110	
D18	OA47				300520850								
D19						X1	Ceramic Resonator					301900101	
to													
D25	SD3				300522160								
D26	Zener	12V	.4W	5%	300521480	SB	Vertical P.V. Socket					352501690	
D27							Horizontal Receptacle					352501700	
to							Push Button Switch					379601001	
D37	SD3				300522160		40 Way D.I.L. I.C. Socket					300584880	
D38	Zener	6.4V	1/4W	5%	300525050								
D39	Zener	5.1V	.4W	5%	300521310		Disconnect Crimp					351501070	
D40	Zener	6.8V	.4W	5%	300522540		Disconnect Pin					355900550	
D41	HP5082				300524910								
D42	Zener	9.1V	.4W	3%	300525590								
D43	Zener	8.2V	.4W	5%	300521330								
D48	SD3				300522160								
D49	SD3				300522160								
D50	IN3595				300523590								
D51	IN3595				300523590								
RV1	CMPM	1M	1/3W	10%	130661000								
RV2	CMPM	20k	1/3W	10%	130642000								
RV3	CMPM	1000	1/3W	10%	130631000								
RV4	CMPM	20k	1/3W	10%	130642000								
RV7	CMPM	1k	1/3W	10%	130631000								
RV8	CMPM	200	1/3W	10%	130622000								

PCB No. 2

Cct Ref.	General Description					Solartron Part No.	Cct Ref.	General Description					Solartron Part No.
*R1	MEFM	9.95M	2W	0.25%	169603802	SA	Switch 5 wafer 2 Pole 5 way					379609205	
R2	MEFM	100.5k	1W	0.25%	169603802	RLB	Relay 90					301201903	
R5	CACP	1000	1/8W	10%	172031000	* Two Pole Change Over							
R6	PRWW	9.975k	1/3W	0.1%	160300407								
R7	CACP	10k	1/8W	10%	172041000							Washer 8 BA Small	411000040
R8	CACP	100k	1W	10%	172551000							Vertical P.V. Socket	352501690
R9	CACP	1M	1W	10%	172561000								
*R11	MEFM	9.9k	1/4W	0.5%	169606201	FS2 Fuse 1A Slo-Blo						360103080	
*R12	MEFM	990k	1/4W	0.5%	169606201								
R14	CACP	100k	1W	10%	172551000								
*R15	MEFM	16k	1/4W	0.5%	169606101								
*R16	MEFM	16.9k	1/4W	0.5%	169606101								
R18	MEFM	15k	1/8W	0.5%	192741502								
R19	CACP	100k	1/8W	10%	172051000								
R20	CACP	100k	1/8W	10%	172051000								
R21	MEFM	5.1k	1/16W	1%	192635102								
R22	MEFM	5.1k	1/16W	1%	192635102								
R23	MEOX	2.2k	1/4W	5%	195632200								
R24	MEOX	10k	1/4W	5%	195641000								
R25	MEOX	2.2k	1/4W	5%	195632200								
R26	MEOX	10k	1/4W	5%	195641000								
R27	MEOX	470	1/4W	5%	195624700								
R28	MEOX	220	1/4W	5%	195622200								
R29	MEFM	10k	1/8W	0.5%	192741002								
R30	CACP	1000	1/8W	10%	172031000								
R31	MEFM	27k	1/8W	0.5%	192742702								
R32	MEOX	18k	1/4W	5%	195641800								
R33	MEOX	18k	1/4W	5%	195641800								
R34	MEOX	2.2k	1/4W	5%	195632200								
R73	PRWW	9.975k	0.33W	0.1%	160300407								
R74	PRWW	999	1/4W	0.1%	160300412								
R75	PRWW	1Ω	1.5W	0.01%	169608702								
C1	ESTF	.22	400V	20%	226152200								
C2	ESTM	10	63V	20%	219971000								
C3	ESTM	2.2	63V	20%	219962200								
C4	ESTM	2.2	63V	20%	219962200								
C5	ESTM	1.5	63V	20%	219961500								
C6	CERM	33p	500V	20%	241313300								
C7	CERM	100p	500V	20%	241321000								
C8	CERM	100p	500V	20%	241321000								
C9	CERM	3300p	2kV	+40% -20%	208450137								
C10	ESTM	0.047	100V	10%	225444700								
C11	CERM	0.047	25V	+50% -25%	241944700								
C12	CERM	0.047	25V	+50% -25%	241944700								
C13	CERM	0.047	25V	+50% -25%	241944700								
D3 to D6	HP 5082-6221					300525380							
D7	Zener	3.9V	.4W	5%	300521420								
D8	Zener	3.9V	.4W	5%	300521420								
D9	Zener	9.1V	.4W	5%	300521340								
D10	SD3					300522160							
D11	SD3					300522160							
RV1	CMPM	100k	1/3W	10%	130651000								
RV2	CMPM	1k	1/3W	10%	130631000								
RV3	CMPM	500	1/3W	10%	130625000								
RV5	CMPM	200	1/3W	10%	130622000								
RV6	CMPM	50	1/3W	10%	130615000								
RV9	CMPM	50	1/3W	10%	130615000								
TR1	BCY 70					300553590							
TR2	BC 107					300553320							
TR3	BC 107					300553320							
IC1	LM 310H					510090040							
IC2	LM 301AH					510000620							

*Absolute Match

PCB No. 3

Cct Ref.	General Description				Solartron Part No.
R1 to R5	CACP	1000	1/8W	10%	172031000
R7 to R11	CACP	390	1/8W	10%	172023900
R13 to R19	CACP	82	1/8W	10%	172018200
R20	CACP	100	1/8W	10%	172021000
R21 to R28	CACP	10k	1/8W	10%	172041000
R29	CACP	22	1/8W	10%	172012200
D1 to D5	5082 - 4494				300750080
TR1 to TR5	2N2906A				300554500
TR7 to TR12	BC 107				300553320
TR13 to TR19	2N2222A				300555410
TR20	BC107				300553320
IC1	LED MAN 73				300730340
IC2 to IC5	LED MAN 72				300730330
	14 PIN D.I.L. SOCKET				300584680
	POST				355500980
	TRANSISTOR PAD				300584220

MAIN ASSEMBLY

Cct Ref.	General Description	Solartron Part No.
T1	Mains Transformer Mains Lead Mains Lead Retainer	309606904 480140200 354003580
	Fuse Holder Fuse Rubber Boot	360202000 360103040 16000213
MSP1	Mains Selector Switch	375000500
	Input Terminal (Black) Input Terminal (Green) Input Terminal (Red) Guard Link	355100360 355100370 355100380 16200102

ACCESSORIES

Cct Ref.	General Description	Solartron Part No.
	Input Lead Assy (Red) Input Lead Assy (Black)	359900090 359900080
	Test Prod Black Test Prod Red	351901030 351901040
	Crocodile Clips (2)	355901030
	Polythene Bag	810000160
	Fuse 150mA Fuse 300mA	360103040 360103170

SECTION 6 - Specifications

This section contains a copy of the technical specification applicable to this instrument.

This instrument is designed and manufactured to a higher specification than is claimed commercially. In order that the user may benefit as appropriate, this technical manual may relate to a superior performance. In the event of contradictions between specifications, no additional claims are made for the instrument above that claimed in the current data sheet.

General

Display

Type:	7 Bar Red Light emitting diodes
Scale Length:	10.999 max.
Polarity Indication:	Displayed for negative dc inputs
Overload Indication:	DC/AC/ μ A/mA/flashing 1, Ω , k Ω steady 1
Annunciator:	mV, V, μ A/mA, Ω , k Ω
Ranging:	Automatic, redundant leading zeros are blanked.

Environment

Working Temperature Range	0 to +45 $^{\circ}$ C
Storage Temperature Range	-30 to +70 $^{\circ}$ C
Maximum Relative Humidity	70% at 40 $^{\circ}$ C

Power Supply

Voltage:	115V/230V + 10% - 15%		
Frequency:	50Hz \pm 1% or 60Hz \pm 1%		
Consumption:	12VA		
Fuses:	230V	150mA	Slo Blo
	115V	300mA	Slo Blo

Size

Width:	216mm	(8.5in)
Height:	89mm	(3.5in)
Depth:	280mm	(11ins)
Weight:	2.73kg	(6 lbs)

Technical Specification

◇Manufacturing calibration temp. 23°C.
 Specification valid for calibration at 20 to 25°C.
 Temperature corrections need be applied only when operating beyond
 the temperature limits quoted under Limits of Error.

DC voltage (V DC)

Nominal Range	Input Sensitivity	Limits of Error [◇]								Input Resistance
		24 hrs ± 1°C ± [% rdg. + % f.s.]		6 mnths ± 5°C ± [% rdg. + % f.s.]		1 year ± 5°C ± [% rdg. + % f.s.]		Temp. coeff. per °C ± [% rdg. + % f.s.]		
100mV	10μV	0.02	0.02	0.02	0.02	0.02	0.02	0.004	0.002	> 1000MΩ
1V	100μV	0.01	0.01	0.02	0.01	0.02	0.01	0.004		> 1000MΩ
10V	1mV	0.01	0.01	0.02	0.01	0.02	0.01	0.004		> 1000MΩ
100V	10mV	0.02	0.01	0.03	0.01	0.03	0.01	0.007		10.1MΩ
1kV	100mV	0.05	0.01	0.05	0.01	0.05	0.01	0.007		10.1MΩ

Full Scale = Nominal Range + 10% (except 1kV range where f.s. = Nominal Range) Overload Immunity 1000V dc

AC Voltage (V AC)

Nominal Range	Input Sensitivity	Limits of Error [◇]								Input Impedance
		24 hrs ± 1°C ± [% rdg. + % f.s.]		6 mnths ± 5°C ± [% rdg. + % f.s.]		1 year ± 5°C ± [% rdg. + % f.s.]		Temp. coeff. per °C ± [% rdg. + % f.s.]		
100mV	10μV	0.1	0.08	0.15	0.1	0.15	0.1	0.006	0.004	1MΩ/100pF
1V	100μV	0.1	0.03	0.15	0.04	0.15	0.04	0.006		1MΩ/100pF
10V	1mV	0.2	0.06	0.2	0.06	0.2	0.06	0.015	0.004	1MΩ/100pF
100V	10mV	0.2	0.02	0.2	0.04	0.2	0.04	0.015		1MΩ/100pF
750V*	100mV	0.2	0.02	0.2	0.04	0.2	0.04	0.015		1MΩ/100pF

*500V max. above 1kHz

Full Scale = Nominal Range + 10% (except 750V where f.s. = Nominal Range) Overload Immunity 1100V pk

□Typical limits for other frequency bands

20Hz to 40Hz: ± 0.5% rdg ± 0.4% f.s.

20kHz to 50kHz: ± 0.5% rdg ± 0.4% f.s.

50kHz to 100kHz: ± 2.0% rdg ± 0.5% f.s.

Resistance (Ω)

Nominal Range	Input Sensitivity	Limits of Error [◇]								Current thro' R
		24 hrs ± 1°C ± [% rdg. + % f.s.]		6 mnths ± 5°C ± [% rdg. + % f.s.]		1 year ± 5°C ± [% rdg. + % f.s.]		Temp. coeff. per °C ± [% rdg. + % f.s.]		
1kΩ	100mΩ	0.04	0.03	0.05	0.03	0.05	0.03	0.003	0.002	100μA
10kΩ	1Ω	0.04	0.01	0.05	0.01	0.05	0.01	0.003		100μA
100kΩ	10Ω	0.02	0.01	0.05	0.01	0.05	0.01	0.003		100μA
1MΩ	100Ω	0.04	0.01	0.05	0.01	0.05	0.01	0.005		1μA
10MΩ	1kΩ	0.1	0.02	0.15	0.02	0.15	0.02	0.005		1μA

Maximum dissipation in unknown: 1mW Full Scale = Nominal Range + 10% Overload Immunity 200V pk

DC current (μA/mA DC)

Nominal Range	Input Sensitivity	Limits of Error [◇]								Input Resistance
		24 hrs ± 1°C ± [% rdg. + % f.s.]		6 mnths ± 5°C ± [% rdg. + % f.s.]		1 year ± 5°C ± [% rdg. + % f.s.]		Temp. coeff. per °C ± [% rdg. + % f.s.]		
10μA	1nA	0.04	0.03	0.05	0.03	0.05	0.03	0.005	0.002	< 5Ω
100μA	10nA	0.04	0.01	0.05	0.01	0.05	0.01	0.005		< 5Ω
1mA	100nA	0.04	0.01	0.05	0.01	0.05	0.01	0.005		< 5Ω
10mA	1μA	0.04	0.3	0.05	0.4	0.05	0.4	0.005	0.02	< 2Ω
100mA	10μA	0.04	0.04	0.05	0.05	0.05	0.05	0.005		< 2Ω
1A	100μA	0.04	0.05	0.05	0.05	0.05	0.05	0.005		< 2Ω

Full Scale = Nominal Range + 10%

7144 only: external current shunts for 10mA, 100mA & 1A ranges

Overload Immunity Ranges 1 to 3 10mA
 Ranges 4 to 6 1.1A

Common Mode Rejection

Measured with an imbalance of $1k\Omega$ in the input leads

Maximum Common Mode Voltage: 500V dc or peak ac

DC Measurement: Rejection of dc $>120\text{dB}$
Rejection of 50/60Hz $\pm 1\% >120\text{dB}$

AC Measurement: Rejection of dc $>120\text{dB}$
Rejection of 50/60Hz $\pm 1\% >40\text{dB}$

Minimum input isolation resistance to earth 100M Ω

Maximum input capacitance to earth 1000pF

Series Mode Rejection

DC Measurement: Rejection of 50/60Hz $\pm 1\% >60\text{dB}$

Figure quoted relates to peak interference and peak reading errors.

Accessories

Short linking	—		16200102
Test Probe	—	Red	351901040
Test Probe	—	Black	351901030
Crocodile Clip	—	(2 off)	355901030
Input Lead	—	(Red)	359900090
Input Lead	—	(Black)	359900080
Spare fuses		150mA	360103040
		300mA	360103170

Optional Accessories

Rack mounting kit 70501

Servicing

Servicing of the 7140 or 7144 should not be attempted without reference to the technical manual. Users unfamiliar with MOS components should not remove the instrument from its case.

Optional Servicing Accessories

Setting up case	70502
Board extender	70503
Servicing Manual	7140 0030

APPENDIX

This section contains specialised selection procedures and/or test equipment to facilitate servicing.

CONTENTS

	Page
FET Selection Procedure	A2
Setting Up Case 70502	A3

FET SELECTION PROCEDURE

PURPOSE

To select four FET's type U1899E with R_{on} matched to within 1Ω at a drain-source current of $100\mu A$.

TEST PROCEDURE

The following test procedure should be carried out using the test circuit shown below or Solartron Test Equipment TG1100/1.

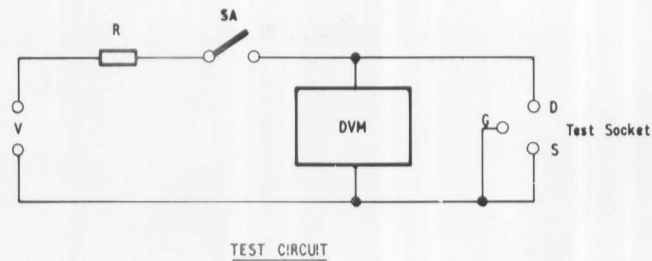

$$\left. \begin{array}{l} V = 10V \\ R = 100k \end{array} \right\} \quad \frac{V}{R} = 100\mu A \pm 0.2\%$$

- Devices to be tested should be allowed to settle to the ambient temperature of the chamber in which the matching operation is to be done. This temperature should be $23^{\circ}C \pm 1^{\circ}C$.
- Place the device under test in the test socket using tweezers or pliers to ensure that its temperature is not raised by handling.
- Press switch SA and note DVM reading. Use the relation $1mV = 10\Omega$ to calculate the R_{on} value.
- Mark the top of the device with two coloured dots of paint as shown in following view employing the standard colour code. R_{on} to be given to nearest whole number, e.g.

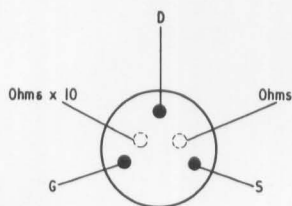

TOP VIEW

45.6 Ω	YELLOW-BLUE
46.3 Ω	YELLOW-BLUE
46.5 Ω	YELLOW-VIOLET

- (e) Select sets of four devices, each with the same colour code.

COLOUR CODE

0	Black
1	Brown
2	Red
3	Orange
4	Yellow
5	Green
6	Blue
7	Violet
8	Grey
9	White

SETTING-UP CASE 70502

INTRODUCTION

In order to achieve the greatest accuracy during a calibration it is essential that the operating temperatures affecting circuit components are as near as possible to those experienced within the instrument case during normal operation.

The Setting-Up Case 70502 enhances the calibration accuracy by allowing access for adjustments whilst the instrument is functioning under normal working conditions.

GENERAL DESCRIPTION

The Setting-Up Case is basically a normal instrument case with holes drilled in convenient positions allowing access to the potentiometers. Fig. A1 shows the side view of the Case with the access holes and the relevant potentiometers.

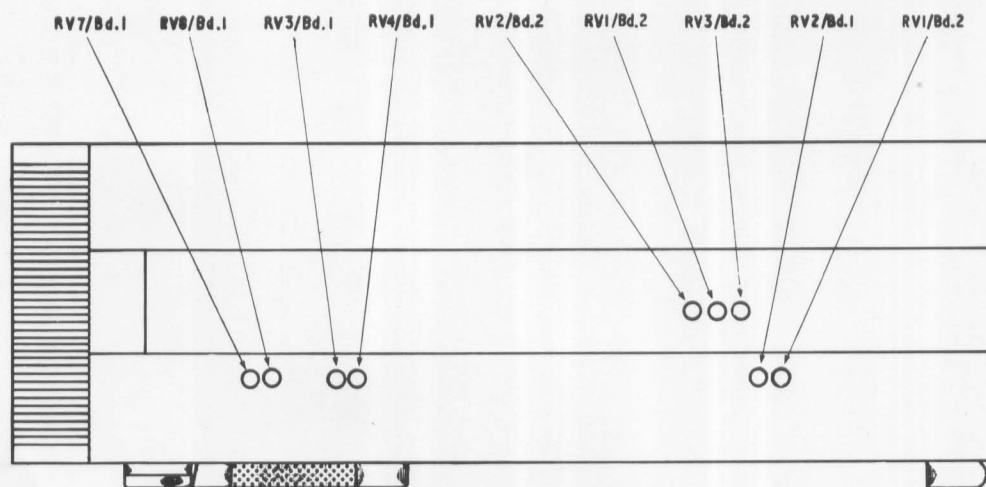

Fig. A.1. View of Setting-Up Case showing potentiometer access holes.