

MONTÁŽNI SESTAVY
МОНТАЖНЫЕ УЗЛЫ
MOUNTING ASSEMBLIES

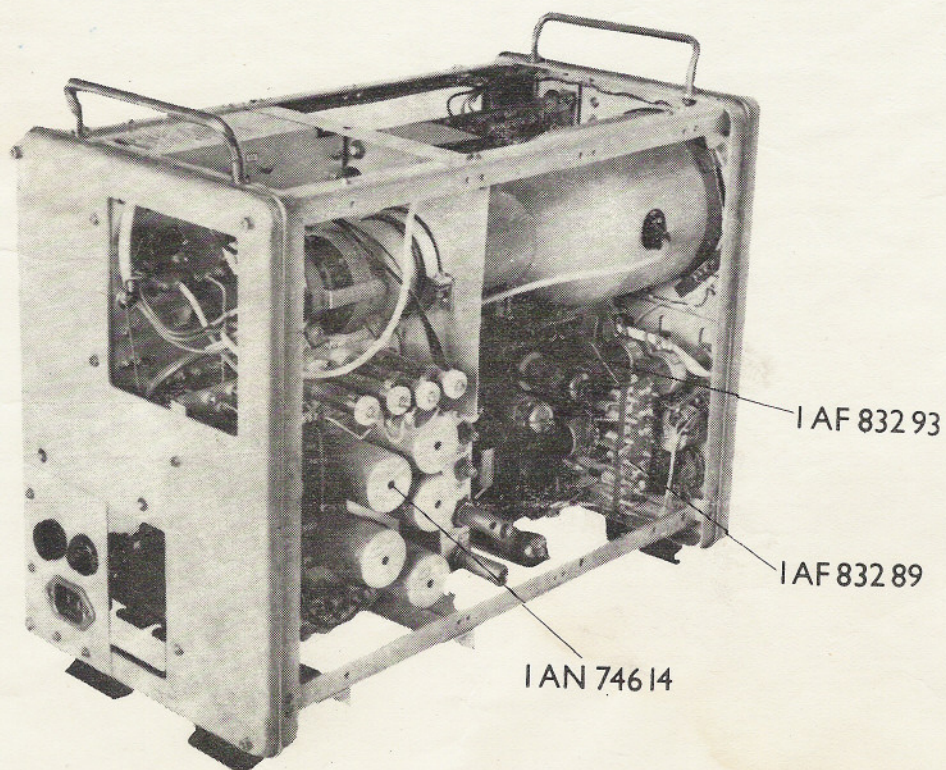

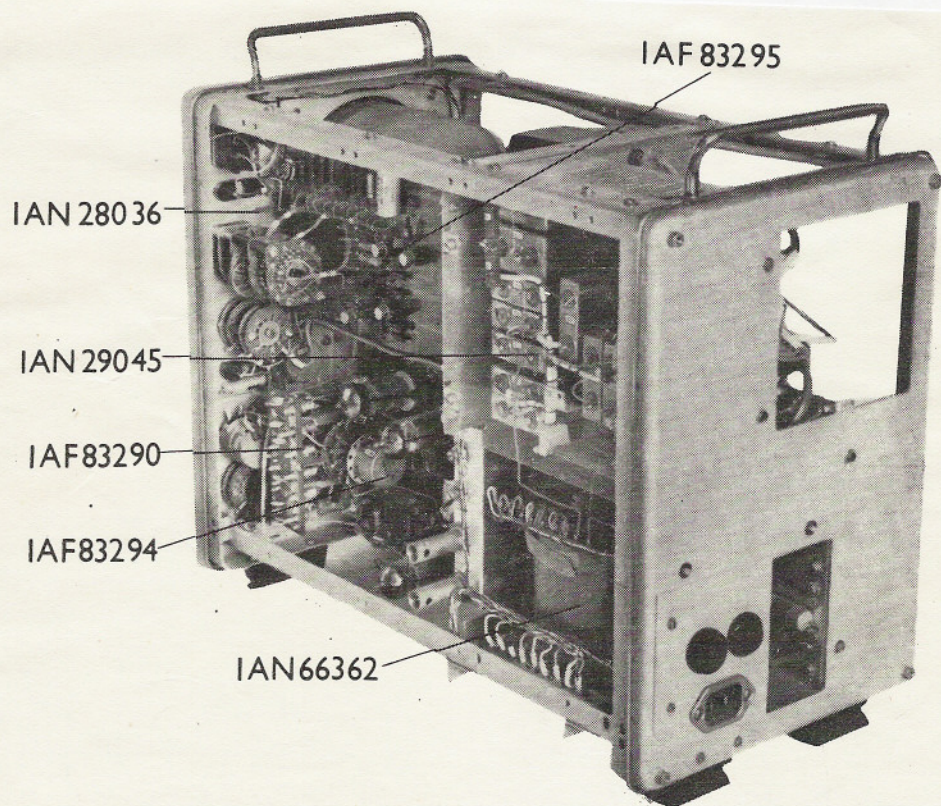
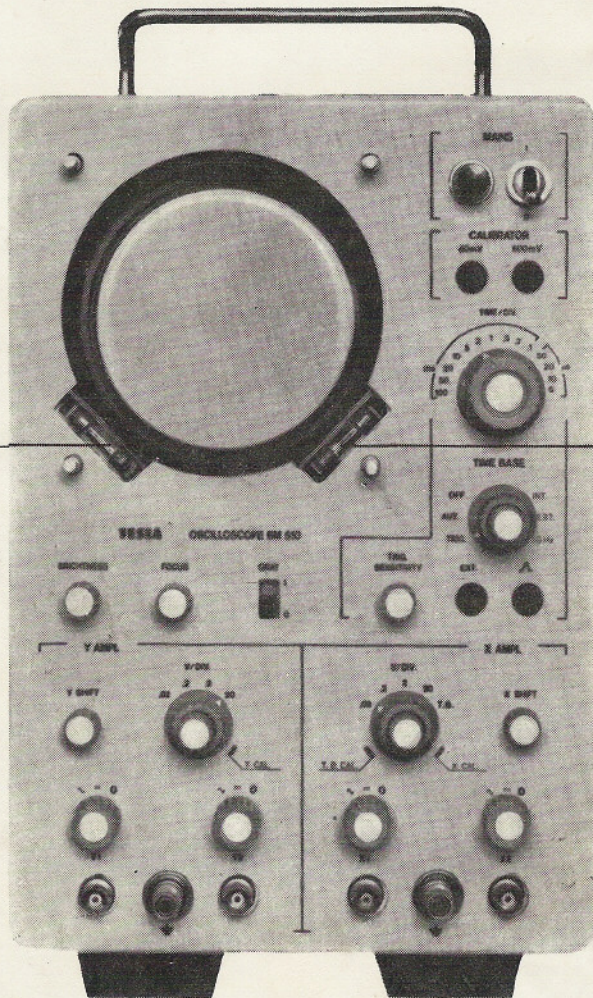

Ž3

Ž2

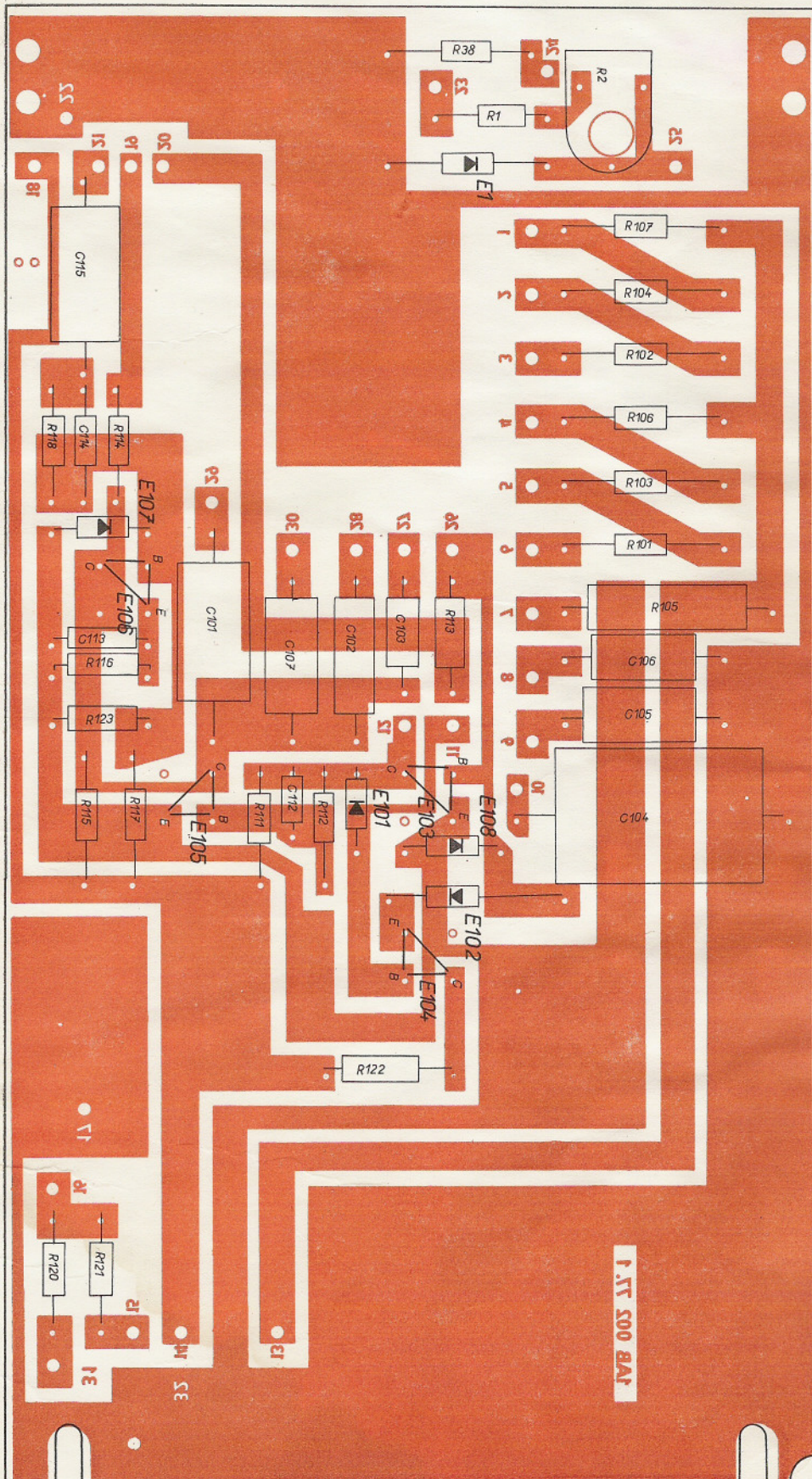

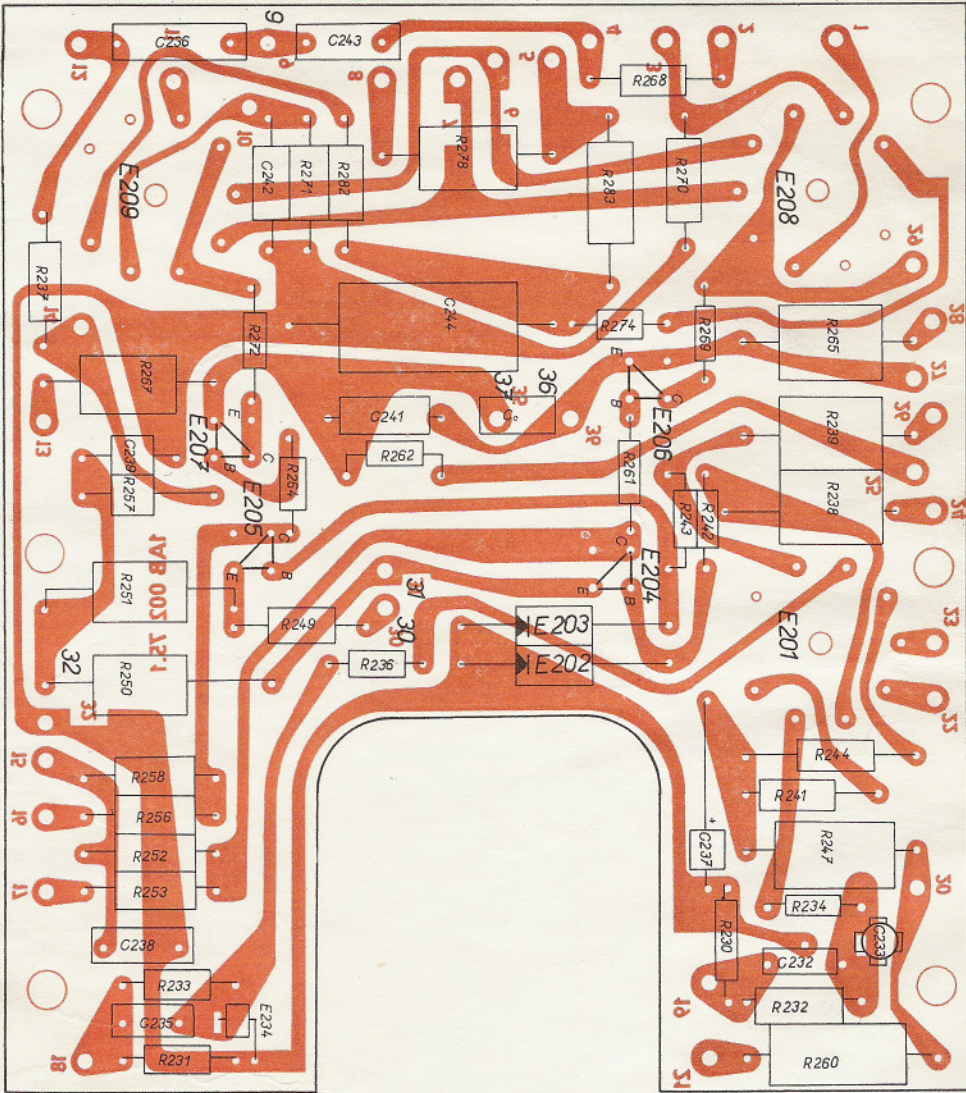

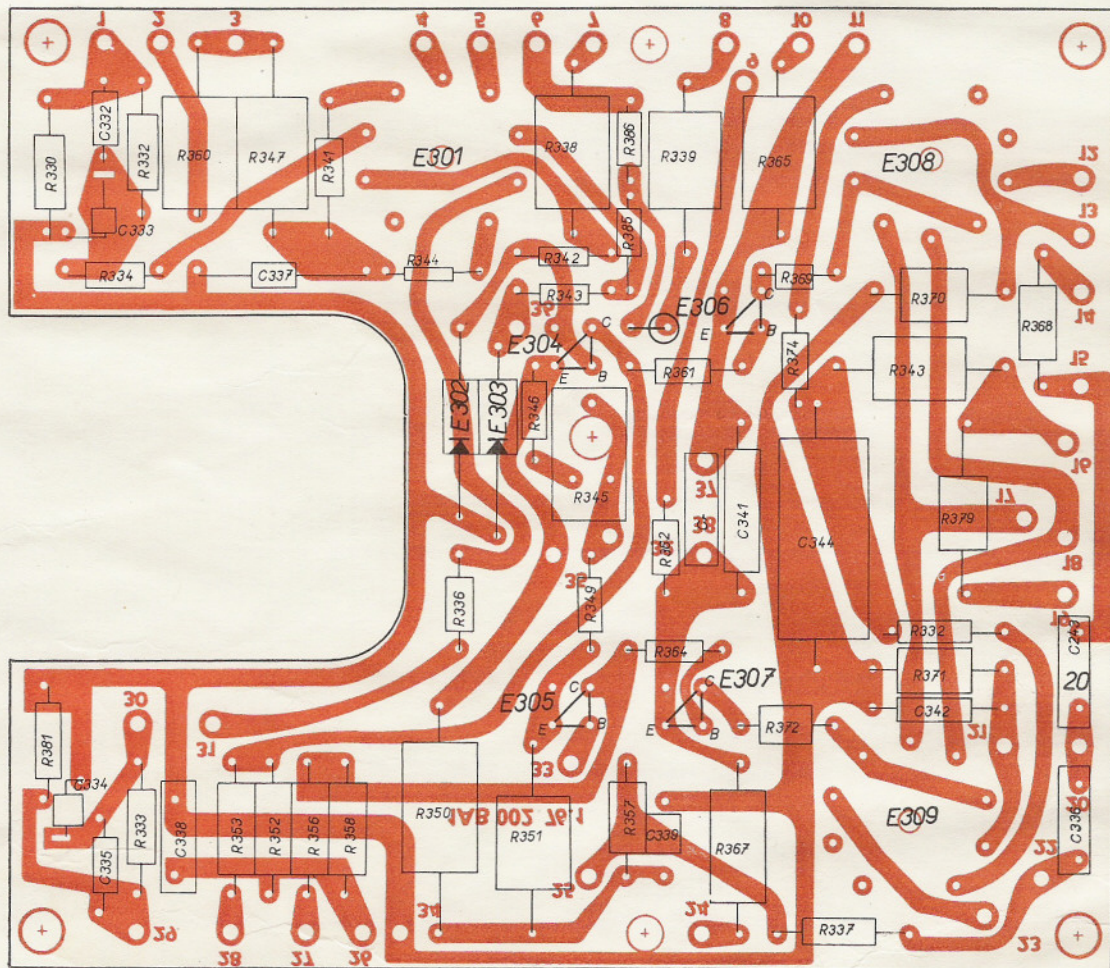

R332	u (at) C344	se mění na (is changed to)	R382
R343	- " -	- " -	R383
R379	- " -	- " -	R378
R381	- " -	- " -	R331
C243	- " -	- " -	C343

1AF 832 94

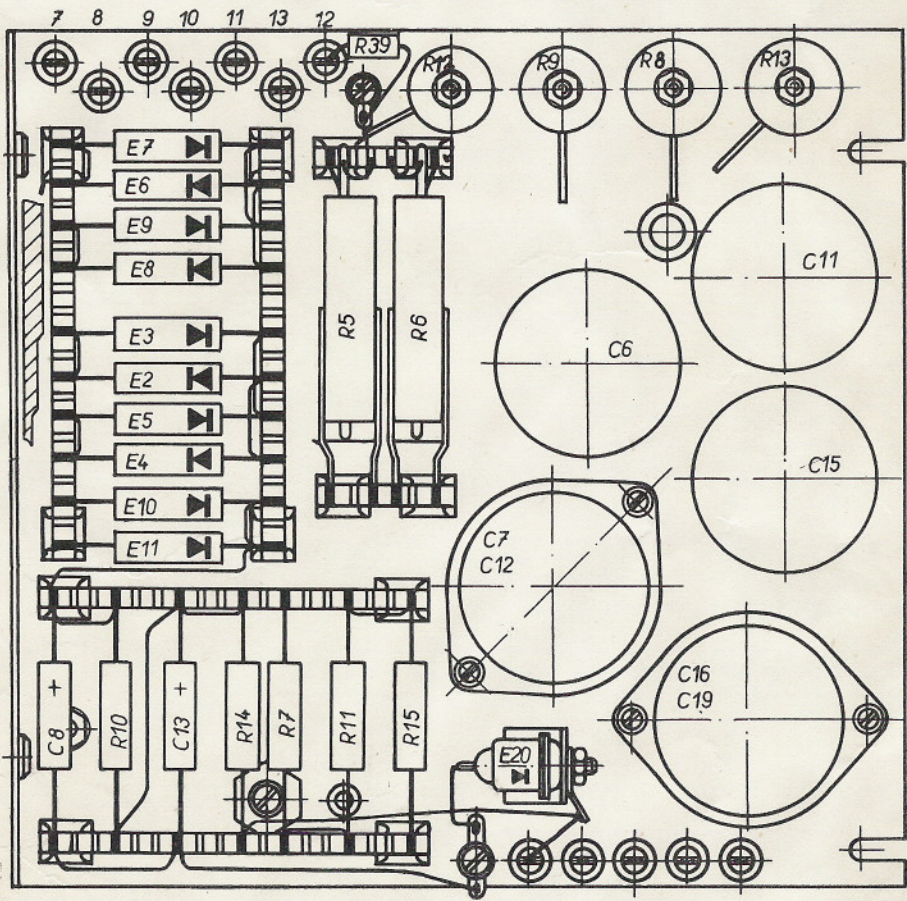

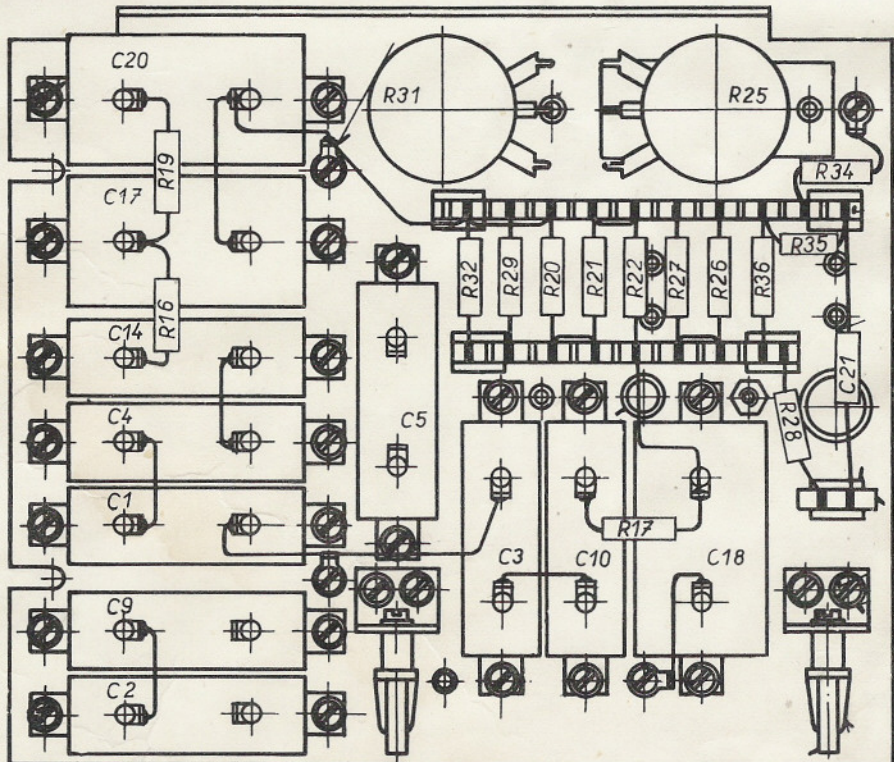
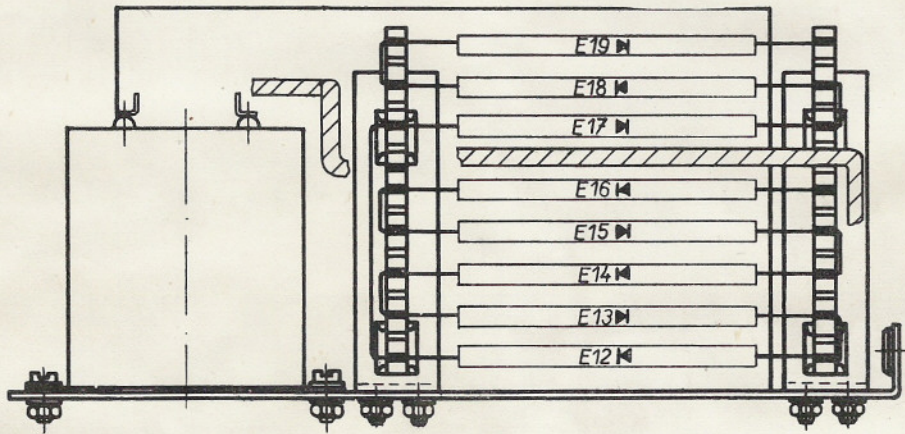

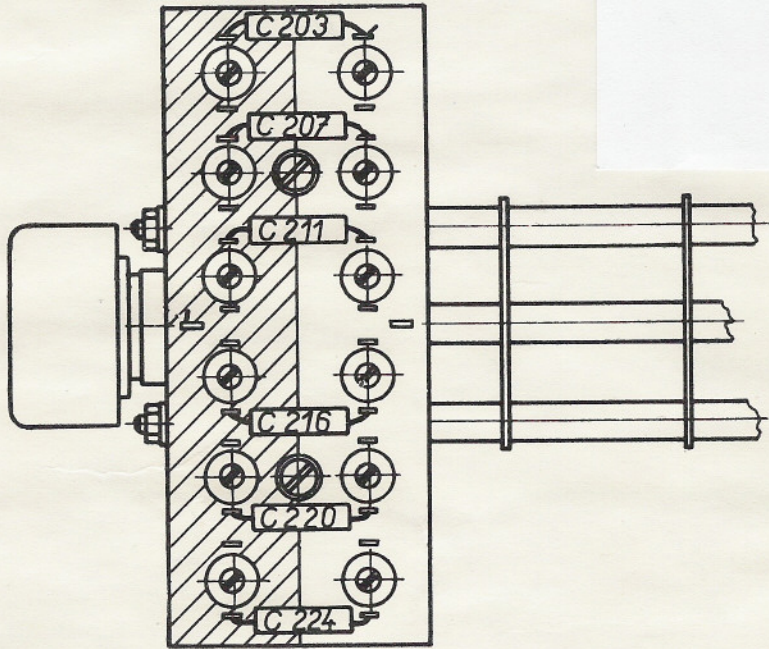

1AF 832 89

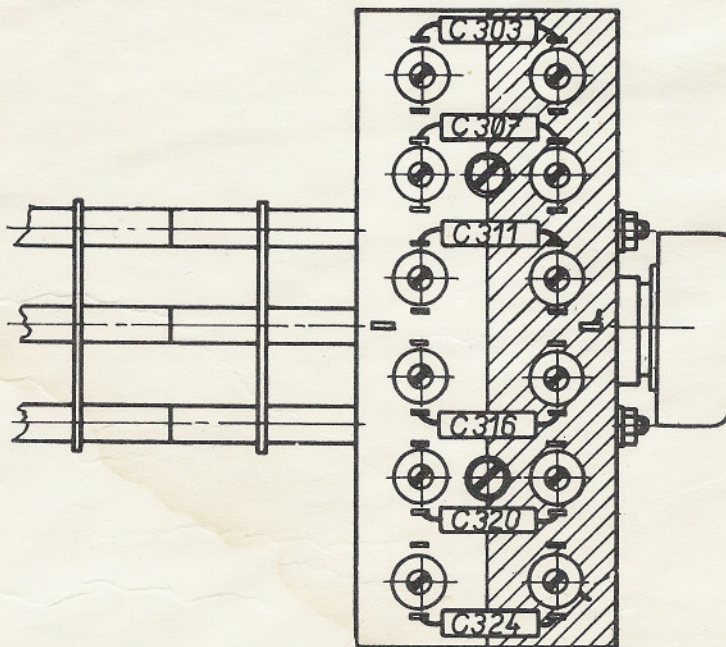

1AF 832 90

S 202

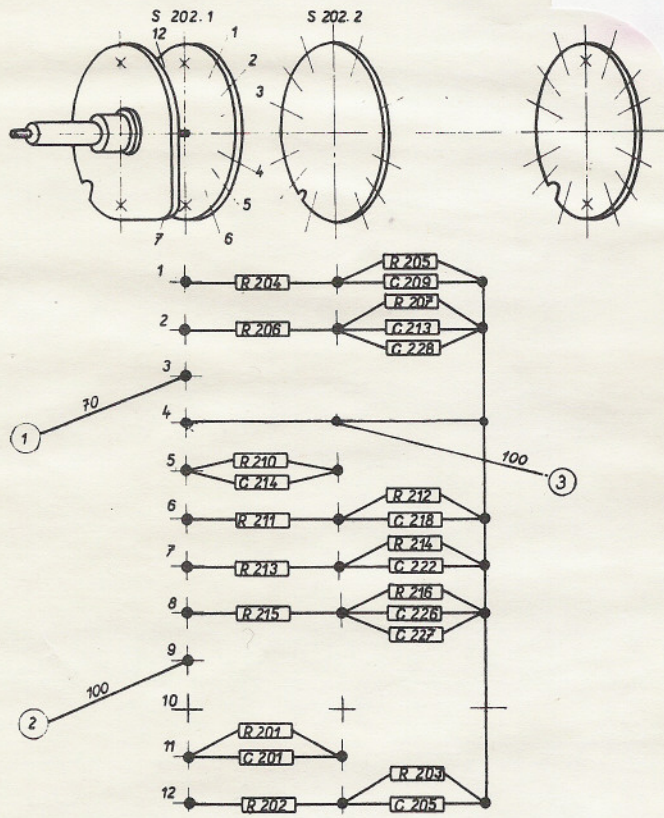

S 302

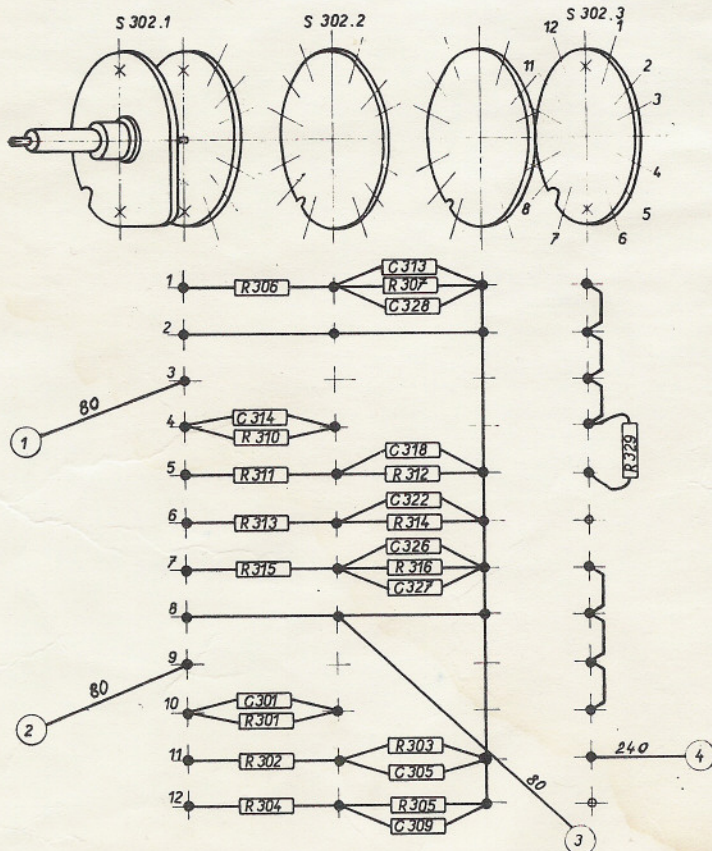

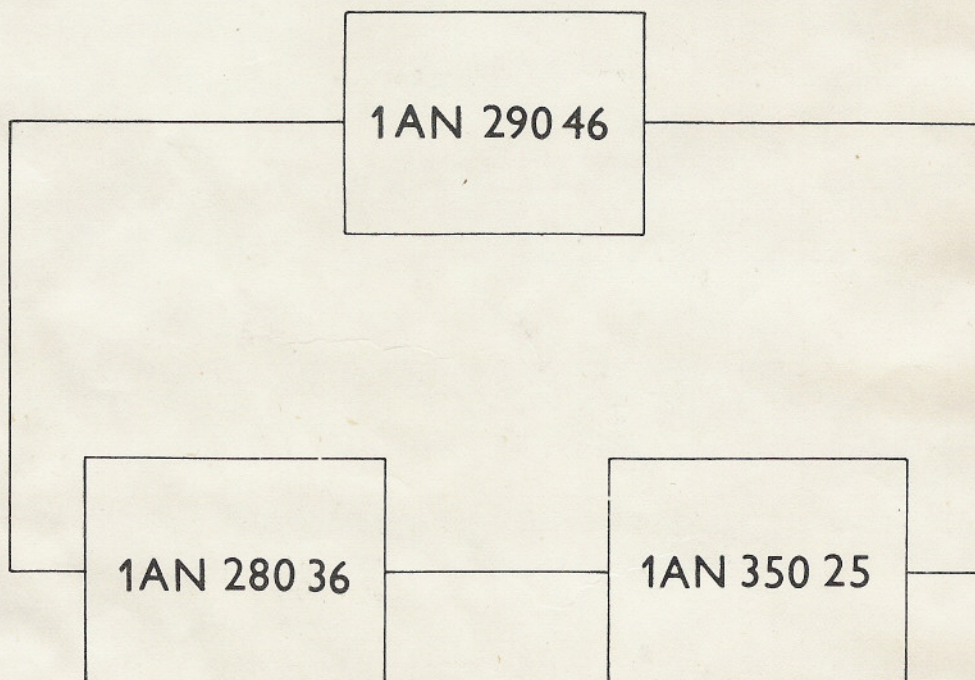

1 AN 280 36	– Časová základna	-- Time base	-- Генератор развертки
1 AN 290 46	– Zdroje	-- Power supplies	-- Источники
1 AN 350 25	– Zesilovač vertikální	-- Vertical amplifier	-- Вертикальный усилитель

S 101.1

S 101.2

S 101.3

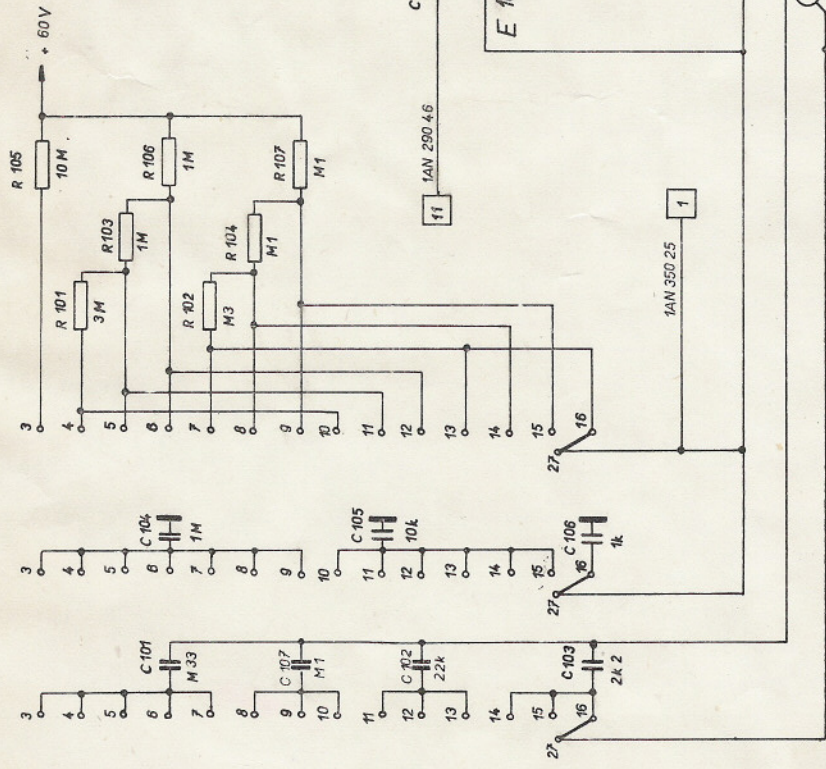

S 102

S 103

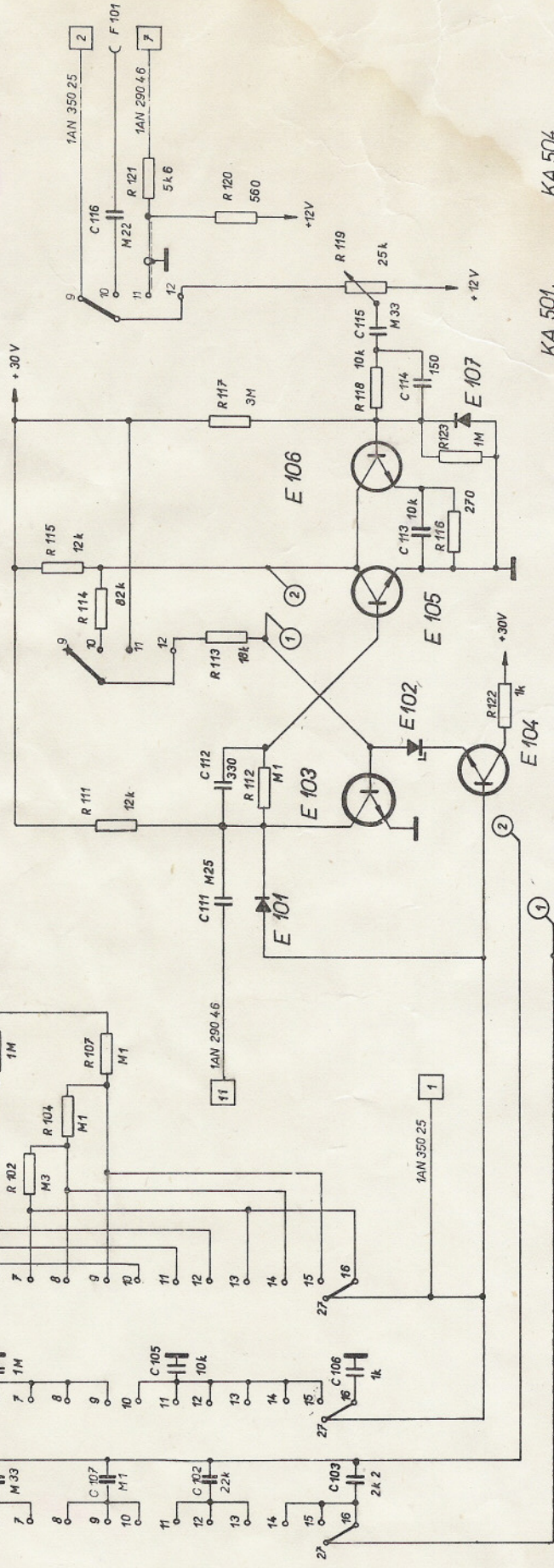

KA 504



KA 501,



KZ 721



KF 506, KF 508



KA 236

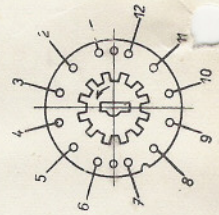

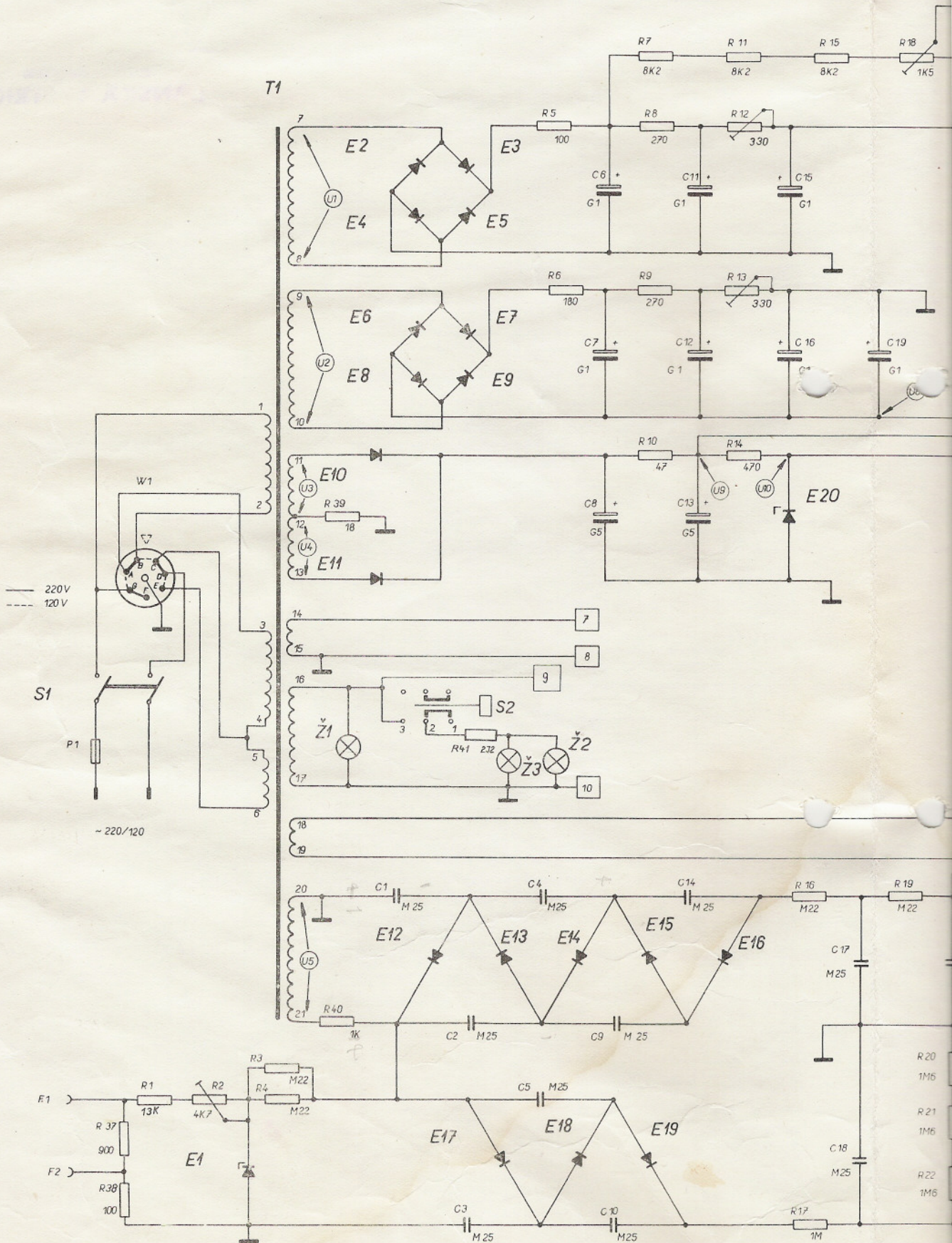

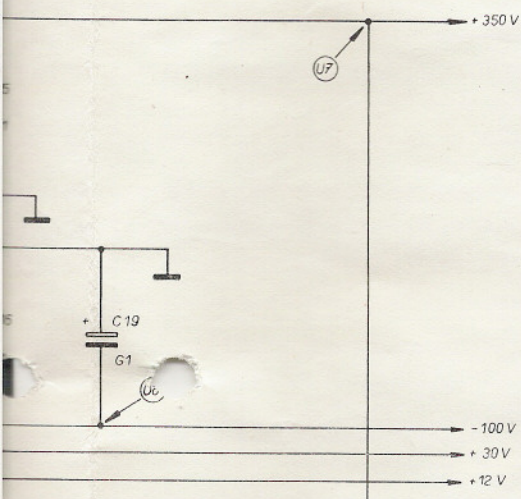
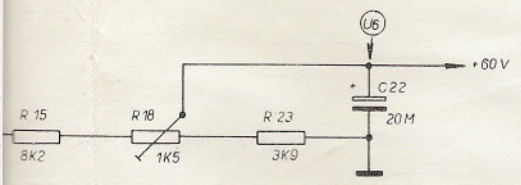

E20

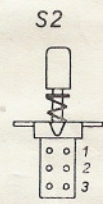
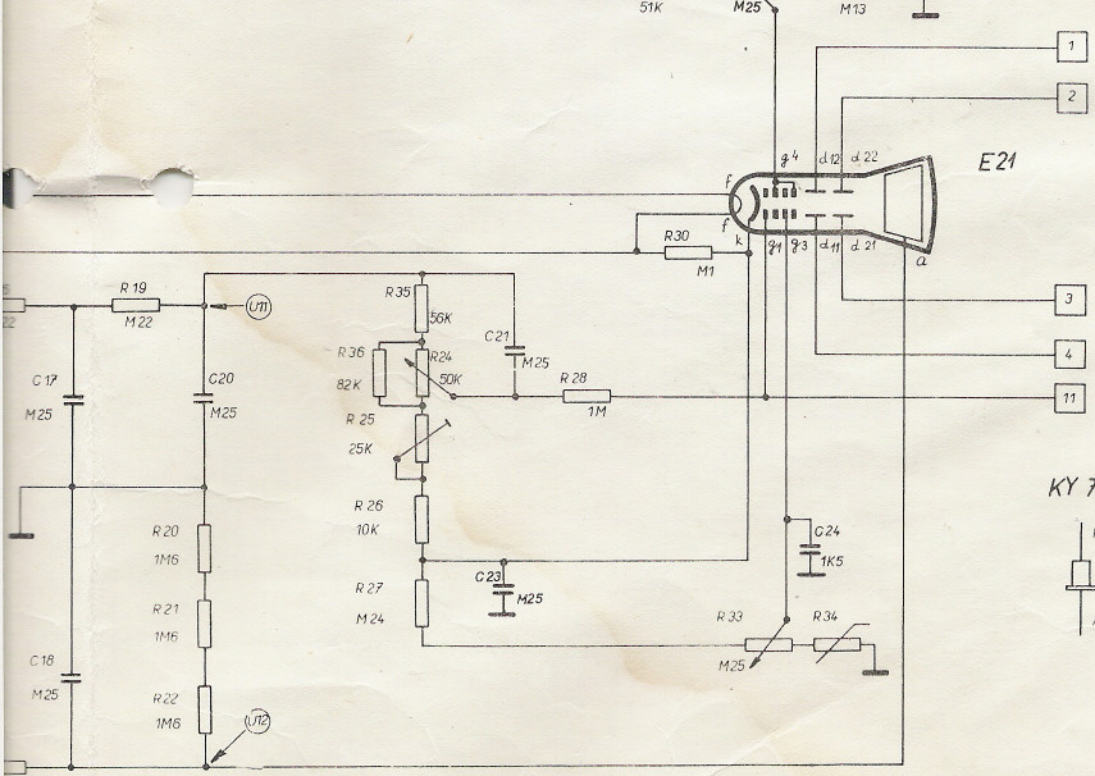
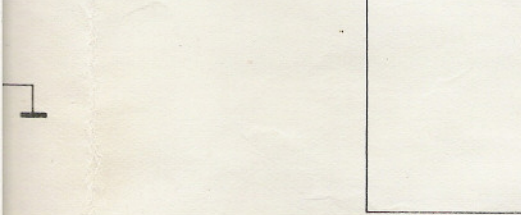

B10SS

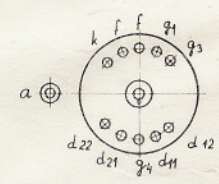

KY 702, KY 705

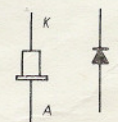

KZZ 74

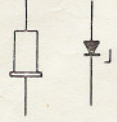

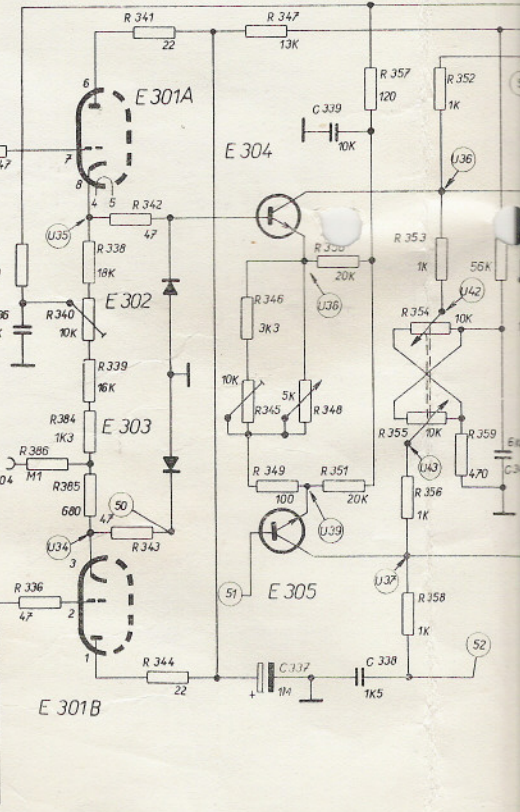
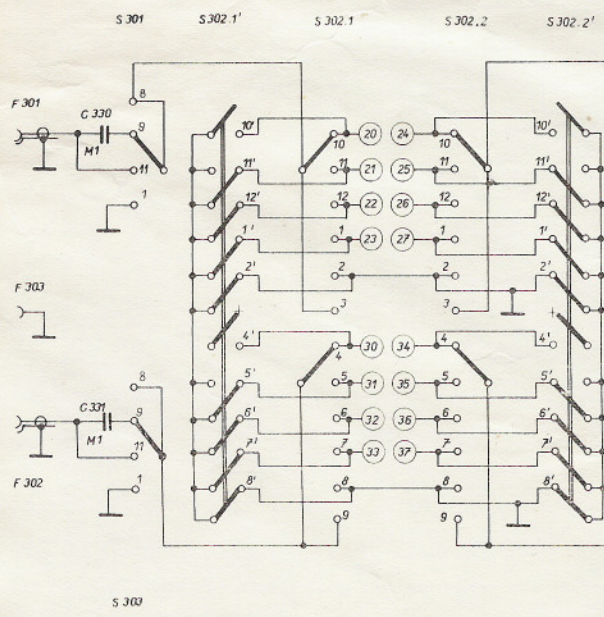
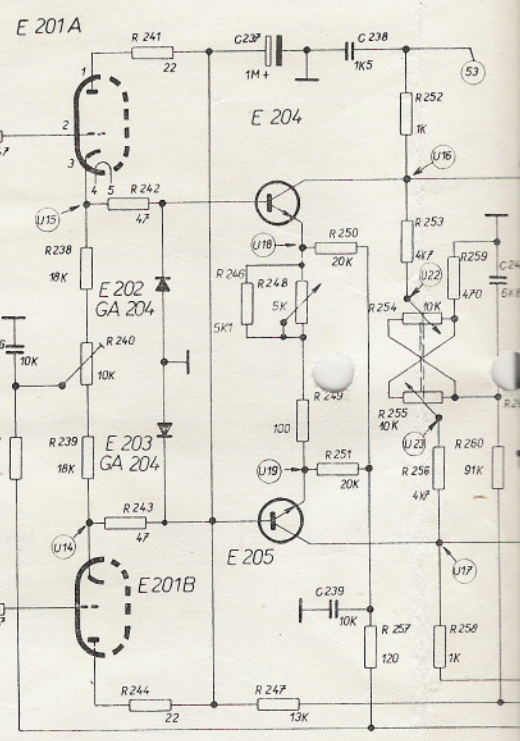
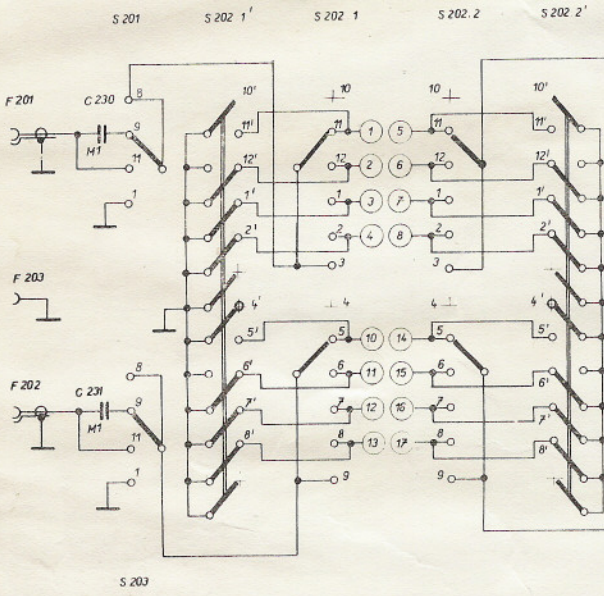

1 1AN 280 36

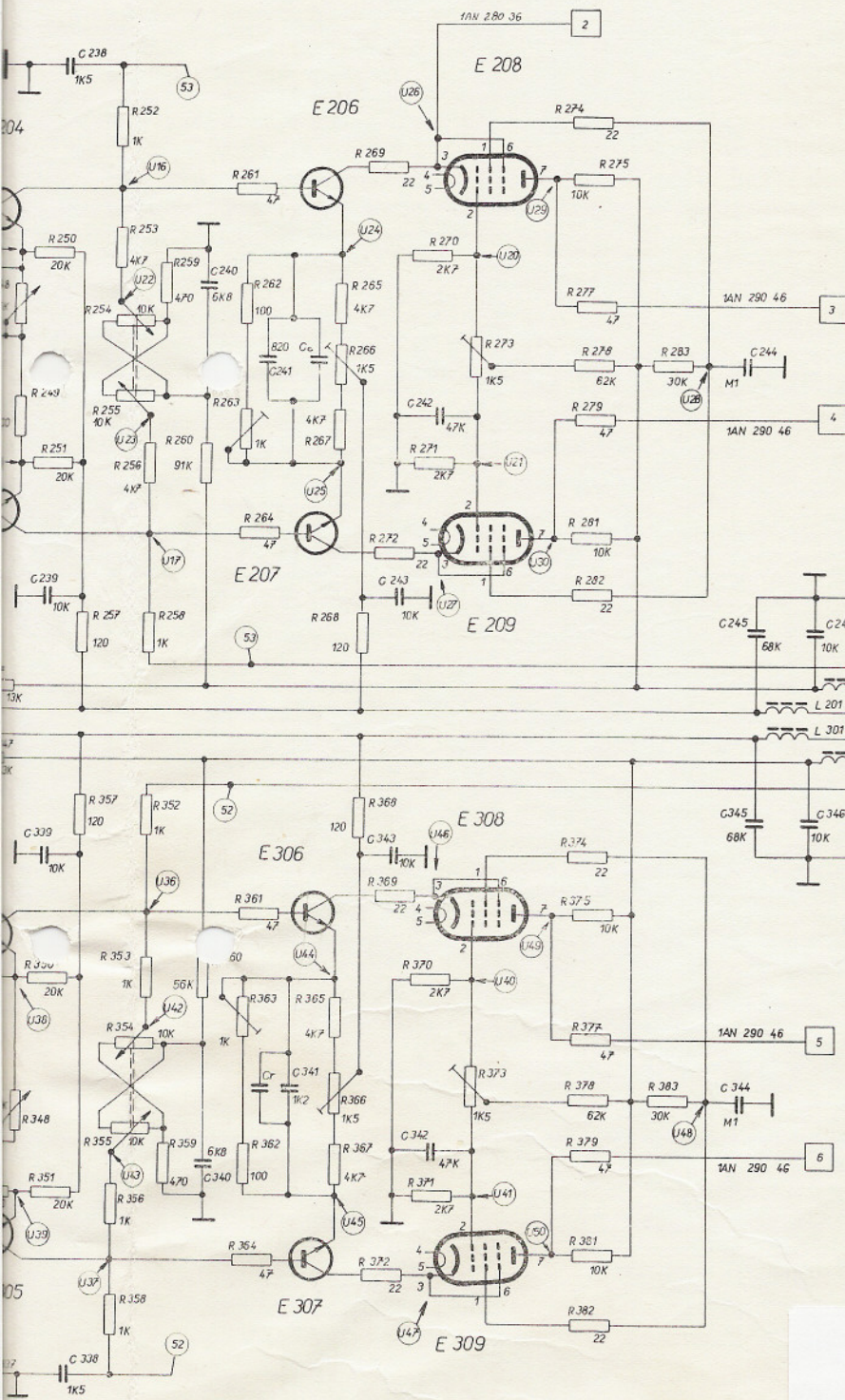

ECC 85, EL83



GA 204

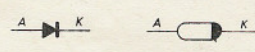

KSY 62

