

INSTRUCTION MANUAL

Model 650

2 MHz VARIABLE PHASE SYNTHESIZER

© 1986 Wavetek

This document contains information proprietary to Wavetek and is provided solely for instrument operation and maintenance. The information in this document may not be duplicated in any manner without the prior approval in writing from Wavetek.

1-800-472-3239

Manual Revision: 1/92
Manual Part Number: 1300-00-0420
Instrument Part Number: 1000-00-0420

Scans By *Artek Media*

Artek Media
1042 Plummer Cir. SW
Rochester, MN 55902

www.artekmedia.com

“High resolution scans of obsolete technical manuals”

If you are looking for a quality scanned technical manual in PDF format please visit our WEB site at www.artekmedia.com or drop us an email at manuals@artekmedia.com and we will be happy to email you a current list of the manuals we have available.

If you don't see the manual you need on the list drop us a line anyway we may still be able to point you to other sources. If you have an existing manual you would like scanned please write for details, This can often be done very reasonably in consideration for adding your manual to our library.

Typically the scans in our manuals are done as follows;

- 1) Typed text pages are typically scanned in black and white at 300 dpi.
- 2) Photo pages are typically scanned in gray scale mode at 600 dpi
- 3) Schematic diagram pages are typically scanned in black and white at 600 dpi unless the original manual had colored high lighting (as is the case for some 70's vintage Tektronix manuals).

If you purchased this manual from us (typically through our Ebay name of ArtekMedia) thank you very much. If you received this from a well-meaning “friend” for free we would appreciate your treating this much like you would “share ware”. By that we mean a donation of at least \$5-10 per manual is appreciated in recognition of the time (a manual can take as much as 40 hours to reproduce, book, link etc.), energy and quality of effort that went into preserving this manual. Donations via PayPal go to: manuals@artekmedia.com or can be mailed to us the address above.

Thanks



Dave & Lynn Henderson
Artek Media

WARRANTY

Wavetek warrants that all products manufactured by Wavetek conform to published Wavetek specifications and are free from defects in materials and workmanship for a period of one (1) year from the date of delivery when used under normal operating conditions and within the service conditions for which they were furnished.

The obligation of Wavetek arising from a Warranty claim shall be limited to repairing, or at its option, replacing without charge, any product which in Wavetek's sole opinion proves to be defective within the scope of the Warranty. In the event Wavetek is not able to modify, repair or replace non-conforming defective parts or components to a condition as warranted within a reasonable time after receipt thereof, Buyers shall be credited for their value at the original purchase price.

Wavetek must be notified in writing of the defect or nonconformity within the Warranty period and the affected product returned to Wavetek's factory or to an authorized service center within (30) days after discovery of such defect or nonconformity.

For product warranties requiring return to Wavetek, products must be returned to a service facility designated by Wavetek. Buyer shall prepay shipping charges, taxes, duties and insurance for products returned to Wavetek for warranty service. Except for products returned to Buyer from another country, Wavetek shall pay for return of products to Buyer.

Wavetek shall have no responsibility hereunder for any defect or damage caused by improper storage, improper installation, unauthorized modification, misuse, neglect, inadequate maintenance, accident or for any product which has been repaired or altered by anyone other than Wavetek or its authorized representative and not in accordance with instructions furnished by Wavetek.

Exclusion of Other Warranties

The Warranty described above is Buyer's sole and exclusive remedy and no other warranty, whether written or oral, is expressed or implied. Wavetek specifically disclaims the implied warranties of merchantability and fitness for a particular purpose. No statement, representation, agreement, or understanding, oral or written, made by an agent, distributor, representative, or employee of Wavetek, which is not contained in the foregoing Warranty will be binding upon Wavetek, unless made in writing and executed by an authorized Wavetek employee. Under no circumstances shall Wavetek be liable for any direct, indirect, special, incidental, or consequential damages, expenses, losses or delays (including loss of profits) based on contract, tort, or any other legal theory.

SAFETY FIRST



Protect yourself. Follow these precautions:

- Don't touch the outputs of the instrument or any exposed test wiring carrying the output signals. This instrument can generate hazardous voltages and currents.
- Don't bypass the power cord's ground lead with two-wire extension cords or plug adaptors.
- Don't disconnect the green and yellow safety-earth-ground wire that connects the ground lug of the power receptacle to the chassis ground terminal (marked with \oplus or \triangle).
- Don't hold your eyes extremely close to an rf output for a long time. The normally nonhazardous low-power rf energy generated by the instrument could possibly cause eye injury.
- Don't plug in the power cord until directed to by the installation instructions.
- Don't repair the instrument unless you qualify and know how to work with hazardous voltages.
- Pay attention to the **WARNING** statements. They point out situations that can cause injury or death.
- Pay attention to the **CAUTION** statements. They point out situations that can cause equipment damage.

WARNING

DO NOT RECHARGE, SHORT CIRCUIT, DISASSEMBLE, OR APPLY HEAT TO THE LITHIUM BATTERY INSIDE THE 650. VIOLATING THIS RULE COULD RELEASE POTENTIALLY HARMFUL LITHIUM. OBSERVE POLARITY WHEN YOU REPLACE THE BATTERY.

CAUTION

The 650 can deliver up to 12½ watts of output power. Always keep the output signal levels within the power range of your load.

CONTENTS

SECTION 1 GENERAL DESCRIPTION

1.1	FUNCTION AND CAPABILITIES	1-1
1.2	LEARNING TO USE THE 650	1-2
1.3	ACCESSORIES	1-2
1.4	SPECIFICATIONS	1-2
1.4.1	Waveforms (Functions)	1-2
1.4.2	Primary Modes	1-2
1.4.3	Secondary Modes	1-2
1.4.4	Triggering	1-2
1.4.5	Modulation	1-3
1.4.6	Channel Outputs	1-3
1.4.7	Sweep	1-3
1.4.8	GPIB Interface	1-5
1.4.9	I/O Connections	1-5
1.4.10	Environmental	1-6
1.4.11	Options	1-6

SECTION 2 INSTALLATION AND MAINTENANCE

2.1	INTRODUCTION	2-1
2.2	STEP-BY-STEP INSTALLATION	2-1
2.3	HOW TO RECEIVE AND INSPECT SHIPMENTS	2-1
2.4	HOW TO RETURN EQUIPMENT FOR REPAIR	2-1
2.5	MECHANICAL INSTALLATION	2-1
2.6	ELECTRICAL INSTALLATION	2-1
2.6.1	Power Verification and Connection	2-2
2.6.2	Signal Connection	2-2
2.6.3	GPIB Connection	2-2
2.6.4	Setting the GPIB Address	2-2
2.7	INITIAL CHECKOUT AND OPERATION VERIFICATION	2-4
2.8	SYSTEM (MASTER/SLAVE) INSTALLATION	2-14
2.9	BATTERY REPLACEMENT	2-14
2.10	SCHEDULED MAINTENANCE	2-16
2.10.1	Air Filter Maintenance	2-16

SECTION 3 CAPABILITIES

3.1	INTRODUCTION	3-1
3.2	NON-SWEEP MODES	3-2
3.3	SWEEP CHOICES	3-4
3.4	SWEEP MODES	3-8
3.5	CHANNEL CONTROL	3-10
3.6	TRIGGERING	3-13
3.7	MODULATION	3-14
3.8	SHIFT KEYING	3-16
3.9	SWEEP PROGRESS INDICATORS	3-17

CONTENTS

SECTION 4 OPERATION REFERENCE

4.1	INTRODUCTION	4-1
4.2	FRONT PANEL	4-2
4.3	REAR PANEL	4-4
4.4	OPERATING PRINCIPLES	4-6
4.5	MENU KEYS	4-8
4.5.1	Main	4-8
4.5.2	Trigger	4-8
4.5.3	Channel	4-9
4.5.4	Sweep	4-10
4.5.5	Utility	4-14
4.5.6	 GPIB	4-15
4.5.7	Stored Settings	4-15
4.5.8	Reset	4-15
4.6	FUNCTION KEYS	4-16
4.6.1	Channel Number	4-16
4.6.2	Manual Trigger	4-16
4.6.3	Hold/Resume	4-17
4.6.4	Quick Calibrate	4-17
4.6.5	Exponent	4-17
4.6.6	Clear	4-18
4.6.7	Execute	4-19
4.7	PROGRAMMING CHARTS	4-20
4.7.1	How to Use the Programming Charts	4-22
4.7.2	Non-Sweep Operation	4-23
4.7.3	Sweep Frequency Operation	4-24
4.7.4	Sweep Phase Operation	4-26
4.7.5	Combined Sweep Operation	4-28
4.7.6	Sequence Frequency Operation	4-30
4.7.7	Sequence Phase Operation	4-32

SECTION 5 DETAILED OPERATION

5.1	INTRODUCTION	5-1
5.2	Main KEY MENU TREE	5-3
5.2.1	Overall Operation	5-3
5.2.2	Soft Key Operation	5-3
5.3	Channel KEY MENU TREE	5-4
5.3.1	Overall Operation	5-4
5.3.2	Soft Key Operation	5-8
5.4	Trigger KEY MENU TREE	5-11
5.4.1	Overall Operation	5-11
5.4.2	Soft Key Operation	5-12
5.5	Sweep KEY MENU TREE	5-13
5.5.1	Overall Operation	5-13
5.5.2	Soft Key Operation	5-17
5.5.3	Continuous Sweeps	5-22
5.5.4	Triggered Sweeps	5-24
5.5.5	FSK Sweeps	5-26
5.5.6	Sequenced Sweeps	5-27
5.5.7	FM and PM Sweeps	5-31
5.5.8	Delta-Frequency Sweep	5-35

CONTENTS

5.6	Utility KEY MENU TREE	5-35
5.6.1	Configuration Menu	5-37
5.6.2	Hold-In Menu	5-37
5.6.3	Calibration Menus	5-38
5.6.4	Self-Test Menu	5-38
5.6.5	Troubleshoot Menu	5-42
5.6.6	Environment Menu	5-42
5.7	GPIB KEY MENU TREE	5-42
5.7.1	Overall Operation	5-42
5.7.2	Soft Key Operation	5-44
5.8	Stored Settings KEY MENU TREE	5-44
5.8.1	Overall Operation	5-44
5.8.2	Soft-Key Operation	5-45
5.9	Reset KEY MENU TREE	5-47
5.10	AMPLITUDE MODULATION	5-47

SECTION 6 GPIB OPERATION

6.1	INTRODUCTION	6-1
6.2	GENERAL PROCEDURE	6-1
6.3	650 COMMANDS	6-1
6.3.1	Command Types	6-1
6.3.2	Command Syntax	6-2
6.3.3	Command List	6-3
6.4	UNIVERSAL AND ADDRESSED COMMANDS	6-9
6.5	DETAILED COMMAND DESCRIPTIONS	6-9
6.5.1	EXTERNALCAL? Command	6-9
6.5.2	FRONTPANEL, LLO, and GTL Commands	6-9
6.5.3	FUNCTION TEST Command	6-10
6.5.4	GET Command	6-10
6.5.5	HELP? Command	6-10
6.5.6	MAINPARAM?, CHNLPARAM?, DCL, SDC, and RESET Commands	6-11
6.5.7	SELFTEST Command	6-12
6.5.8	VERSION? Command	6-12
6.6	SERVICE REQUESTS	6-13
6.6.1	SRQ Concepts	6-13
6.6.2	SRQ Commands	6-13
6.6.3	SRQ Messages	6-15
6.7	DISPLAYING MESSAGES ON THE 650 SCREEN	6-18
6.8	GPIB MENU KEYS	6-19
6.8.1	ADRS Key	6-19
6.8.2	LOCAL Key	6-19
6.8.3	LSNBUF Key	6-19
6.8.4	SRQ Key	6-19
6.8.5	SRQBUF Key	6-21
6.8.6	SYNTAX Key	6-21
6.9	DEMONSTRATION PROGRAMS	6-21
6.9.1	Triggered Frequency Sweep Program (Wavetek 6000)	6-21
6.9.2	Triggered Frequency Sweep Program (IBM-PC/National)	6-22
6.9.3	SRQ GPIB Program (Wavetek 6000)	6-23

CONTENTS

SECTION 7 CALIBRATION

7.1	INTRODUCTION	7-1
7.2	MANUAL CALIBRATION	7-2
7.2.1	Overview	7-2
7.2.2	Step-By-Step Procedure	7-3
7.3	AUTO CALIBRATION	7-10
7.3.1	Overview	7-10
7.3.2	Step-By-Step Procedure	7-10
7.4	QUICK CALIBRATION	7-11
7.4.1	Overview	7-11
7.4.2	Step-By-Step Procedure	7-12
7.5	SYSTEM CALIBRATION	7-12
7.5.1	Overview	7-12
7.5.2	Step-By-Step Procedure	7-12
7.6	EXTERNAL CALIBRATION	7-15
7.6.1	Overview	7-15
7.6.2	Detailed Procedure	7-16

SECTION 8 APPLICATION: PHASE METER CALIBRATION

8.1	INTRODUCTION	8-1
8.2	TEST DESCRIPTION	8-1
8.3	QUICK TEST	8-1
8.4	SWEEP TESTS	8-3
8.5	WAVETEK 740 EXAMPLE	8-10

ILLUSTRATIONS

Installation and Maintenance

		Page
2-1	Voltage Selector and Fuse	2-2
2-2	GPIB Address Selection	2-3
2-3	Oscilloscope Connection for Checkout and Verification Procedure	2-6
2-4	Lithium Battery Location	2-15

Operation Reference

4-1	Front Panel	4-3
4-2	Rear Panel	4-5
4-3	How the 650 Generates Phase-Coherent Waveforms	4-7
4-4	Oscilloscope Connection for Examples	4-21

Detailed Operation

5-1	Main Key Menu Tree	5-2
5-2	Channel Menu Shift Operation	5-4
5-3	Channel Key Menu Tree	5-5
5-4	Channel Menu Functions	5-6
5-5	Allowable Combinations of Amplitude, Offset, and Output	5-9
5-6	Phase Shift Sign Conventions	5-11

ILLUSTRATIONS

5-7	Trigger Key Menu Tree	5-12
5-8	Sweep Key Menu Tree	5-14
5-9	Sequence Tables	5-28
5-10	Frequency Modulation Signal Processing	5-32
5-11	Phase Modulation Signal Processing	5-33
5-12	Simultaneous Frequency/Phase Modulation Signal Processing	5-34
5-13	Utility Key Menu Tree	5-36
5-14	Frequency Sweep Hold	5-37
5-15	Waveform Voltage Hold	5-37
5-16	Self-Test Operating Flowchart	5-39
5-17	Circuit Board and Power Supply Locations	5-41
5-18	GPIB Key Menu Tree	5-43
5-19	Stored Settings Key Menu Tree	5-44
5-20	Reset Key Menu Tree	5-47
5-21	Amplitude Modulation	5-48

GPIB Operation

6-1	650 Status Byte and SRQ Mask	6-14
6-2	How the 650 Displays the Listen and SRQ Buffers	6-20

Calibration

7-1	Calling the Manual Calibration Menu	7-3
7-2	Summary of Manual Calibration	7-4
7-3	Manual Calibration Aberration and Rise Time	7-9
7-4	Calling the Auto-Cal Menu	7-10
7-5	Interconnection of Multiple 650 Units	7-13
7-6	External Calibration Test Setup	7-17

Application: Phase Meter Calibration

8-1	Electrical Connections for the Sweep Tests	8-4
8-2	Wavetek 740 Measured-Phase vs Frequency Graphs	8-11

TABLES

General Description		Page
1-1	Amplitude Range, Resolution, and Accuracy	1-4
1-2	Offset Range, Resolution, and Accuracy	1-4
1-3	DC Range, Resolution, and Accuracy	1-4
1-4	Sequenced Sweeps Throughput	1-5
Installation and Maintenance		
2-1	GPIB Connector Pin Functions	2-2
2-2	Initial Checkout and Operation Verification Procedure	2-4
Operation Reference		
4-1	Connector Electrical Specifications	4-4
4-2	Connector/Switch Functions and References	4-5

TABLES

Detailed Operation

5-1	PHASE and DELAY Application Conditions	5-10
5-2	Sweep Menu Terminology and Modes	5-15
5-3	Mode-Dependent Output and Monitor Functions	5-16
5-4	Step Rates of Compensated and Uncompensated Sweeps	5-19
5-5	Sweep Functions Available for Each Sweep Mode	5-21
5-6	Self-Test Messages	5-40

GPIB Operation

6-1	650 Command Syntax	6-4
6-2	650 Command Set	6-5
6-3	SRQ Programming Error Messages	6-15
6-4	SRQ Hardware Error Messages	6-16
6-5	SRQ Event Messages	6-17

Calibration

7-1	Manual Calibration Major Adjustment Steps	7-2
7-2	Manual Calibration Procedure	7-5
7-3	Auto Calibration Error Messages	7-11
7-4	System Auto Calibration Procedure	7-14

Application: Phase Meter Calibration

8-1	Quick Test	8-2
8-2	90° Sweep Test	8-3
8-3	120° Sweep Test	8-7
8-4	240° Sweep Test	8-9

SECTION 1

GENERAL DESCRIPTION

1.1 FUNCTION AND CAPABILITIES

Function. The Wavetek Model 650 Variable Phase Synthesizer generates multiple waveforms at controlled phase angles. Each channel's output signal maintains an absolutely fixed and precisely controllable phase relationship with the output signals of the other channels. Phase accuracy holds for fixed frequency, swept frequency, and swept phase operation. Digital generation

of the signals guarantees fixed accuracy across the entire range of frequency and phase.

Capabilities. The following additional capabilities of the 650 support its primary role as a phase synthesizer and enable it to serve a wide range of phase and non-phase-related applications. Section 3 of this manual explains these capabilities in more detail.

Category	Capabilities		
Non-Sweep Modes	Continuous Triggered Burst	Sync Gated Async Gated Phase Lock	Waveform Hold AM
Sweep Choices	Frequency Sweep Phase Sweep Both Sweep Sequential Sweep	Hold Sweep Linear Sweep Log Sweep	Sine Sweep Random Sweep AM/FM/PM
Frequency/Phase/ Both Sweep Modes	Continuous Sweep with Auto Reset Continuous Sweep with Auto Reverse Triggered Sweep with Auto Reset Triggered Sweep with Auto Reverse Triggered Sweep/Hold with Trig Reset/Hold		Triggered Sweep/Hold with Trig Reverse/Hold Sequential with Triggered Steps Sequential with Continuous Stepping Sequential with Triggered Single Pass
Channel Control	Sine, Triangle, Square, Ramp, DC Waveforms Output Impedance Waveform Amplitude	Waveform Offset Square Wave Duty Cycle Phase Control Frequency Multiplication	Amplitude Modulation Sync Output Delta Frequency Ramp Duty Cycle
Triggering	Internal External	Front Panel GPIB	
Modulation	Frequency Modulation Phase Modulation	Amplitude Modulation Combined (FM/PM)	
Shift Keying	Synchronous Frequency Shift Keying (S-FSK) Asynchronous Frequency Shift Keying (A-FSK) Asynchronous Multiple Frequency Shift Keying Asynchronous Multiple Phase Shift Keying		
Sweep Progress	Screen Sweep Monitor	Sweep Horizontal Out	Sweep Marker
Unit Control	Front Panel	GPIB	MATE (optional)
Memory	25 Stored Instrument Setups		Lost-Power Instrument Setup

1.2 LEARNING TO USE THE 650

Follow this procedure to teach yourself operation of the 650:

First, learn basic operation of the controls. Run through the initial checkout and operation verification procedure exactly as written. You'll find this procedure in section 2 (installation and maintenance)

Second, learn more about each control. Run through the checkout procedure again, but before you use each control or menu, find and read the description of it in section 4 (operation reference). Depart from the checkout procedure and try some of the other functions as you read about them.

Third, run the programming examples. The programming charts in section 4.7 of the manual give keystroke-by-keystroke examples that set up the six basic operating modes of the 650. Run through several of these examples to get familiar with the setup, operation, and capabilities of these modes.

1.3 ACCESSORIES

The standard 650 contains two channels. You can purchase four options:

- Two additional channels per 650
- Multiple-650 systems that can generate up to 40 synchronized signals
- MATE Interface
- Rack slides

1.4 SPECIFICATIONS

NOTE

With 0Ω source selected and 'FUNC OUT' terminated with a load greater than 100Ω, the 'FUNC OUT' cable length must be less than six feet.

1.4.1 Waveforms (Functions)

Programmable sine, square, triangle, ramp, dc and variable-duty-cycle-square and ramp.

Range

- Sine, Square:** 0.1 MHz to 2 MHz.
- Ramp, Triangle:** 0.1 MHz to 200 kHz.
- Resolution:** 10 digits or 0.1 MHz.
- Accuracy:** ± 5 ppm.
- Stability:** ± 3 ppm.

Waveform Quality

Sine Wave: (Frequency Ratio = 1):

Frequency	Spurious	Harmonics
≤10 kHz	≤-70 dBc	≤-60 dBc
≤100 kHz	≤-60 dBc	≤-50 dBc
≤2 MHz	≤-50 dBc	≤-33 dBc

Square Wave:

- Rise/Fall Time: ≤100ns.
- Aberrations: ≤5% (From 50Ω into a 50Ω load), ≤10% (From 0Ω into a 50Ω load).
- Duty Cycle: 20 to 80% ±3% ±15ns.

Triangle/Ramp:

- Linearity: ≥99% ≤10kHz; ≥90% <200kHz.
- Duty Cycle: 0 to 100% ±3% ±15ns.
- Aberrations: ≤5% (Vp-p) for the following conditions:
 - Frequencies at or below 10 kHz and duty cycle 1 to 99%
 - Frequencies above 10 kHz to 200 kHz and duty cycle 10 to 90%.

1.4.2 Primary Modes

Continuous, triggered, gated and burst.

Burst Count: 1 to 65535.

1.4.3 Secondary Modes

Phase Shift

Phase Resolution:

Phase Range	Phase Resolution
0 to 99,999.995°	0.005°
100,000.00 to 999,999.99°	0.01°
1,000,000.0 to 9,999,999.9°	0.1°

Phase Accuracy: For compared channels of equal amplitude and compared channels of unequal amplitude with amplitude ratios up to 10.

Sine Wave Phase Accuracy For

Frequency	Sine Wave Phase Accuracy For	
	Equal Ampl Angle	Unequal Ampl Angle
<1 kHz	0.005°	0.020°
<10 kHz	0.030°	0.100°
<100 kHz	0.100°	0.500°
<1 MHz	0.500°	2.000°
<2 MHz	1.000°	5.000°

Phase Delay

- Delay Resolution:** 3 digits.
- Delay Range:** - 2 to + 2ms.

Phaselock

- Phaselock Range:** 40 Hz to 2 MHz.
- Initial Lock Time:** ≤4 sec.
- Re-lock Time:** 100 periods + 100 ms.

Delta Frequency

- Range:** - 1000 to + 1000 Hz.
- Resolution:** 3 digits but max 0.1 mHz.
- Accuracy:** 0.1%

1.4.4 Triggering

Internal Trigger Signal

- External Availability:** Present at **Marker Out** connector in non-sweep modes.
- Range:** 2.5 mHz to ≥200 kHz.
- Resolution:** 3 digits.
- Accuracy:** 0.1%.

External Trigger Signal**Frequency Range:** 0 to ≥ 200 kHz.**Amplitude Range:** +10 to -10V.**Level Setting Resolution:** 0.1V.**Level Accuracy:** $\pm 0.3V$.**1.4.5 Modulation****Amplitude Modulation****Range:** 0 to 100%.**AM Bandwidth:** 0 to 20 KHz.**Modulation Gain (VCG):** 10.**AM Input Impedance:** $> 10k\Omega$.**Protection:** ± 50 Vdc (Momentary).**Phase Modulation****Range:** Programmable $0 \pm 1080^\circ$.**PM Bandwidth:** 25 kHz.**Voltage Controlled Phase Modulation (VCPM):** -1V to +1V for full modulation between programmed start and stop phase with 8 bit resolution.**PM Input Impedance:** $\geq 1M\Omega$.**Protection:** ± 50 Vdc momentary.**Frequency Modulation****Programmable start and stop frequency in range** 0.1 mHz to 2 MHz.**FM Bandwidth:** 20 kHz.**Voltage Controlled Frequency Modulation (VCFM):** -1V to +1V for full modulation between programmed start and stop frequency values with 8 bit resolution.**Frequency Shift Keying**

Asynchronous (Async FSK) and Synchronous (Sync FSK).

Max Rate of FSK: 40 kHz (25 μ s per step).**Max No. of Different Frequencies in FSK Mode:** 100.**Switching Time Between Frequencies:** ≤ 500 ns.**Phase Shift Keying****Max Rate of PSK:** 65 kHz.**Phase Shift Keying Capabilities:** Dual Phase Shift Keying (DPSK) and Quadrature Phase Shift Keying (QPSK) through sequenced phase sweep mode.**Max No. of Different Phase Values in PSK Mode:** 100.**Pulse Position Modulation****Max Rate of PPM:** 65 kHz.**Max No. of Different PPM Values:** 99.**1.4.6 Channel Outputs****Function**

Sine, square, triangle, dc, ramp or programmable duty cycle square or ramp.

Amplitude Range, Resolution, and Accuracy

See table 1-1.

Offset Range, Resolution, and Accuracy

See table 1-2.

DC**Maximum Range:** $\pm 12.5mV \pm 25V$.**Range, Resolution, and Accuracy**

See table 1-3.

Frequency Ratio

Each channel can deliver a frequency from 1 to 99 times the main frequency.

Output ImpedanceChoices: 0 Ω , 50 Ω , and OFF (output relay open). The 50 Ω impedance requires a 50 Ω termination.**1.4.7 Sweep****Frequency Sweep****Modes:**

- 1: Continuous with Reset.
- 2: Continuous with Reverse.
- 3: Triggered with Reset.
- 4: Triggered with Reverse.
- 5: Triggered with Hold and Reset.
- 6: Triggered with Hold and Reverse.
- 7: Synchronous FSK.
- 8: Asynchronous FSK.
- 9: Externally Triggered Sequence.
- 10: Continuous (Looping) Sequence.
- 11: Stepped Sequence on Trigger.
- 12: External FM.

Range: 0.1 mHz to 2 MHz.**Resolution:** 10 digits but max 0.1 mHz.**Accuracy:** 5ppm $\pm 10 \mu$ Hz.**Sequenced Sweeps (Modes 9, 10, 11):**

No. of Programmable Steps (Index): 1 to 99.

Frequency Switching Time: ≤ 500 ns.

Throughput: Refer to table 1-4.

Phase Sweep**Modes:**

- 13: Continuous with Reset.
- 14: Continuous with Reverse.
- 15: Triggered with Reset.
- 16: Triggered with Reverse.
- 17: Triggered with Hold and Reset.
- 18: Triggered with Hold and Reverse.
- 19: Externally Triggered Sequence.
- 20: Continuous (Looping) Sequence.
- 21: Stepped Sequence on Trigger.
- 22: Delta Frequency Sweep.
- 23: External PM (Phase Modulation).

Range: -10^6 to $+10^6$ degrees continuous**Resolution:** 5 millidegrees.**Accuracy:** Refer to table.**Sequenced Sweeps (Modes 19, 20, 21):** Number of Programmable Steps (Index): 1 to 99.Phase Switching Time: ≤ 500 ns.

Throughput: Refer to table 1-4.

Table 1-1. Amplitude Range, Resolution and Accuracy

Output Impedance	Range (Vp-p)	Resolution	Accuracy		
			≤100 kHz	≤1 MHz	≤2MHz
0Ω	2.5 – 50	1 mV	±0.5% ±2 mV	±1.5% ±2 mV	±3% – ±2mV
50Ω	0.025 – 0.25	10μV	(typ: ±0.1% ±1 mV)	(typ: ±0.2% ±1 mV)	(typ: ±1.0% ±1 mV)
	0.25 – 2.5	100μV			
	2.5 – 25	1 mV			

Table 1-2. Offset Range, Resolution and Accuracy

Output Impedance	Range (Vp-p)	Resolution	Accuracy
0Ω	±25	1 mV	0.5% ± 30 mV
50Ω	±12.5	1 mV	0.5% ± 20 mV
	±1.25	0.1 mV	0.5% ± 10 mV
	±0.125	10μV	0.5% ± 5 mV (typ: 0.1% ± 3 mV)

Table 1-3. DC Range, Resolution and Accuracy

Output Impedance	Range (Vp-p)	Resolution	Accuracy
0Ω	±25V	1 mV	0.3% ± 10 mV
50Ω	±12.5V	1 mV	0.3% ± 5 mV
	±1.25V	0.1 mV	0.3% ± 2 mV
	±0.125V	10μV	0.3% ± 1 mV

Table 1-4. Sequenced Sweeps Throughput

Sequence Mode	Compensation	
	On	Off
9: Triggered Frequency	1.214 kHz	42 kHz
10: Continuous Frequency	1.210 kHz	38 kHz
11: Stepped Frequency	1.209 kHz	37 kHz
19: Triggered Phase	1.228 kHz	70 kHz
20: Continuous Phase	1.225 kHz	61 kHz
21: Stepped Phase	1.224 kHz	58 kHz
26: Triggered Combined	1.188 kHz	24 kHz
27: Continuous Combined	1.186 kHz	23 kHz
28: Stepped Combined	1.183 kHz	22 kHz

Combined Frequency and Phase Sweep Modes:

- 24: Combined Simultaneous.
Frequency/Phase Sweep (with identical start/stop frequency for all channels, except for ratio <>1, but individually programmed start and stop phase for each channel).
- 25: Triggered Combined Sweeps with Hold and Reset.
- 26: Externally Triggered Frequency/Phase Sequence.
- 27: Continuous (Looping) Frequency/Phase Sequence.
- 28: Stepped Frequency/Phase Sequence on Trigger.
- 29: External Combined FM/PM.

Range, Resolution and Accuracy: Same as for Frequency Sweep and Phase Sweep.

Sequenced Sweeps (Modes 26, 27, 28): Number of Programmable Steps (Index): 1 to 99.

Switching Time: ≤500 ns.

Throughput: Refer to table 1-4.

Sweep Functions

Linear: Sweep progresses linearly from programmed start to stop value.

Log: Sweep progresses in a logarithmic fashion from start to stop value.

Random: Swept parameter changes in a random pattern uniformly distributed between start and stop value.

Sine: Swept parameter (frequency, phase or both) changes in a sinusoidal pattern from start to stop value.

NOTE Combined sweep modes 24 and 25 permit only the linear sweep function

Sweep Time

Range: 10 ms to 10⁷ sec.

Resolution: 3 digits but max 1 ms.

Accuracy: 0.1%.

Sweep Resolution: Use the following fixed step rate table to derive phase and frequency sweep resolution.

Fixed Step Rates: (For combinations of sweep function, swept parameter and compensation.) Refer to the following table.

Fixed Step Rates

Sweep Function	Compensation	
	On (Steps/sec)	Off (Steps/sec)
<i>Frequency Sweep</i>		
Linear	1143	13,333
Log	962	4,167
Sine	1053	6,667
Random	1156	15,400

Phase Sweep

Linear	1176	20,000
Log	1010	5,263
Sine	1064	7,143
Random	1183	22,200

Combined Frequency and Phase Sweep

Linear	1053	6,667
--------	------	-------

Modulation Sampling Speed

Module Mode	Compensation	
	On	Off
12: Ext FM	1.179 kHz	20.8 kHz
23: Ext PM	1.190 kHz	25.0 kHz
29: Comb FM + PM	1.004 kHz	5.1 kHz

1.4.8 GPIB Interface

Address Range

0 to 30 switch selectable. Rear panel switch enables/disables front panel entry of address.

Subsets

SH1, AH1, TE0, L4, RL1, PP0, DC1, C0, E2.

1.4.9 I/O Connections

Reference Out

Impedance: 50Ω source.

Level: TTL, <0.4V, >2.4V into 50Ω.

Fanout: 10 reference inputs.

Frequency: 10 MHz, ± 5 ppm.

Protection: ± 5 Vdc momentary.

Reference In**Impedance:** >1k Ω , ac coupled.**Level:** >500 mVp-p, <50 Vdc.**Frequency:** 10 MHz \pm 1%.**Protection:** \pm 50 Vdc momentary.**Trigger Input****Impedance:** >5 k Ω .**Level:** >500 mVp-p, < \pm 10 Vdc.**Input:** 0 to >200 kHz, 20 ns min.**Protection:** \pm 50 Vdc momentary.**Hold Input****Impedance:** <1 k Ω .**Level:** TTL, active low.**Protection:** \pm 20 Vdc momentary.**Function:** selectable sweep or waveform hold.**FM/PM Input****Impedance:** >1 M Ω .**Level:** - 1 to + 1V (for full range).**Protection:** \pm 50 Vdc.**Sampling Speed:**

Mode	Comp Off	Comp On
Ext FM	20 kHz	1kHz
Ext PM	25 kHz	1kHz
Ext FM/PM	5 kHz	1kHz
Resolution	8 mV	
Accuracy	\pm 5%	

Marker Out**Impedance:** 50 Ω source.**Level:** TTL, <0.4V, >2.4V into 50 Ω .**Output:** Low when freq/phase < marker.**Protection:** \pm 20 Vdc momentary.**2.048 V Out****Impedance:** 1 k Ω .**Level:** 2.04V \pm 1%.**Output:** Internal V ref cal test point.**Protection:** \pm 50 Vdc momentary.**Phase Cal Input**

The Phase Cal input externally calibrates a master/slave pair or group or measures phase shift through external circuits. A relay connects the **Phase Cal In** BNC to the internal circuits for these measurements and disconnects it at all other times.

Impedance: >300 Ω .**Level:** 40 Vp-p max.**Input:** Slave channel for multi-unit cal.**Protection:** Unprotected when calibrating, protected to \pm 100 Vdc otherwise.**Horiz Out****Impedance:** 1 k Ω .**Level:** 0 to + 10 Vdc.**Output:** % of sweep.**Accuracy:** \pm 2%.**Resolution:** 40 mV.**Protection:** \pm 50 Vdc momentary.**Phase Out*****Impedance:** <50 Ω .**Level:** TTL.**Output:** Sync pulse for master/slave configuration.**Protection:** None.**Phase Clear*****Impedance:** <50 ohm.**Level:** TTL.**Output:** Clear pulse for master/slave configuration.**Protection:** None.

*Phase Out and Phase Clear only lock units together in a master/slave pair or group.

Channel Func Out**Impedance:** 50 Ω , 0 Ω selectable.**Level:** - 25 V to + 25 V.**Output:** Main function output.**Protection:** Current limit at 500 mA. Withstands \pm 60 Vdc indefinitely.**Sync Out****Impedance:** 50 Ω source.**Level:** TTL, <0.4, >2.4 V into 50 Ω .**Output:** Sync in phase with sine wave. Phase accuracy not specified.**Protection:** \pm 20 Vdc momentary.**AM Input****Impedance:** >10 k Ω .**Level:** 0 to + 5 V.**Input:** Modulation signal up to 20 kHz BW.**Protection:** \pm 50 Vdc momentary.**1.4.10 Environmental****Temperature Range:** 0° to 50°C. 25° \pm 10°C for specified performance.**Warm-up Time:** 20 minutes for specified performance.**Relative Humidity:** 95% at 25°C and sea level (non-condensing).**Altitude:** Sea level to 10,000 ft for operation. Sea level to 40,000 ft for storage.**Dimensions:** 42.9 cm (16.9 in.) wide; 13.3 cm (5.3 in.) high; 54.6 cm (21.5 in.) deep.**Weight:** 16.3 kg (36 lb) 2 CH; 20.5 kg (45 lb) 4 CH.**Power:** 90 to 126, 190 to 252 Vac, 48 to 66 Hz, \leq 250 watts.**1.4.11 Options****001: Two Additional Channels**

Two additional channels and the associated RAM board mount in the chassis for a total of four channels.

010: MATE Interface

SECTION 2

INSTALLATION AND MAINTENANCE

2.1 INTRODUCTION

This section provides the following installation and maintenance information:

Section	Page
2.2 Step-By-Step Installation	2-1
2.3 How to Receive and Inspect Shipments	2-1
2.4 How to Return Equipment for Repair	2-1
2.5 Mechanical Installation	2-1
2.6 Electrical Installation	2-2
2.7 Initial Checkout and Operation Verification	2-4
2.8 System (Master/Slave) Installation	2-14
2.9 Battery Replacement	2-14
2.10 Scheduled Maintenance	2-16

2.2 STEP-BY-STEP INSTALLATION

Install your 650 with the procedure given below. Adapt the steps as necessary to suit your requirements. The sections given in the reference column cover each step in detail.

Step	Section
1. Unpack and inspect the 650	2.3
2. Verify the AC power/fuse configuration	2.6.1
3. Set the GPIB address switch (optional)	2.6.4
4. Verify operation	2.7
5. Rack mount the unit (optional)	2.5
6. Auto-calibrate the unit	7.3
7. Connect signal leads	2.6.2
8. Begin operation	3, 4, & 5

2.3 HOW TO RECEIVE AND INSPECT SHIPMENTS

Follow these steps when you receive a shipment of Wavetek equipment:

- Inspect the shipment.** Before the driver leaves, check the shipment for missing boxes and inspect each box for damage. Have the driver describe the box damage and list any shortages on the delivery bill.

- Unpack the boxes.** After the driver leaves, unpack the boxes. Save all the packing material
- Inspect the equipment for damage.** Inspect it carefully, regardless of the condition of the shipping boxes.
- If necessary, file a damage claim.** If you find any damage, call the shipper immediately (within 10 days) and start the claim process.
- Call us.** Call our customer service department (619-279-2200) and tell us that the equipment arrived damaged.

2.4 HOW TO RETURN EQUIPMENT FOR REPAIR

Follow these steps when you return equipment to Wavetek:

- Save the packing material.** Always return equipment to us in its original packing material and boxes. If you use inadequate material, you'll have to pay to repair any shipping damage as carriers won't pay claims on incorrectly packed equipment.
- Call us and ask for a return authorization.** Our customer service representative will ask for your name, telephone number, company name, equipment type, and a description of the problem.
- Pack and ship the equipment.**

2.5 MECHANICAL INSTALLATION

Mounting. You can either put the 650 on a test bench or rack mount it. Rack mounting requires either chassis rails or rack slides (Wavetek part number 1000-00-0358).

Cooling. In bench and rack use, leave at least 3 inches behind the 650 so that cooling air can freely enter and leave the rear panel. In addition, rack mounting requires free flow of air through the rack.

2.6 ELECTRICAL INSTALLATION

This section covers the following topics:

- 2.6.1 Power Verification and Connection
- 2.6.2 Signal Connection

2.6.3 GPIB Connection

2.6.4 Setting the GPIB address.

2.6.1 Power Verification and Connection

NOTE

Unless you specified otherwise, your 650 requires 120 Vac and a ½ amp fuse. European units generally require 220 – 240 Vac.

Follow this procedure to verify and, if necessary, change the 650's input voltage.

1. Pull the power cord out of the power/fuse case on the rear panel.
2. Slide the plastic door to the left.
3. Rotate the FUSE PULL lever to the left, then pull out the fuse.
4. Read the voltage on the voltage selection printed circuit card inside the power/fuse case. Leave the card installed if the number matches the voltage you need (see the table below). To change to a different voltage, pull the card and reinsert it as shown in figure 2-1.
5. Compare the ampere rating on the fuse to the ampere ratings given in the following table for the range of input voltages. If the fuse has the right rating, keep it. If the fuse has the wrong rating, replace it.

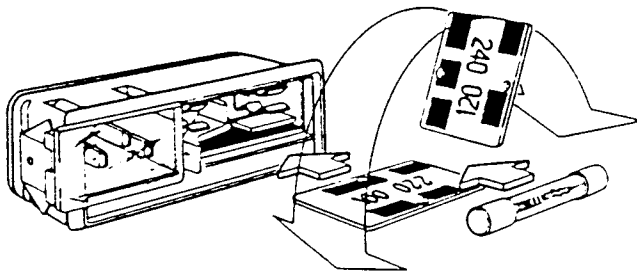

Card Position	Input Vac	Required Fuse
100 or 120	90 to 126	3.0 A, 250V, Slo-Blo
220 or 240	190 to 252	1.5 A, 250V, Slo-Blo

Figure 2-1. Voltage Selector and Fuse

6. Rotate the FUSE PULL lever back into the normal position, insert the correct fuse, and close the cover door.
7. Plug the power cord back into the power/fuse case, then connect it to your local power source.

2.6.2 Signal Connection

Use RG58U or equivalent 50Ω coaxial cable equipped with BNC connectors to distribute signals.

Refer to section 4 of this manual for signal connector information. In that section, figure 4-2 locates the rear panel connectors, table 4-1 gives their electrical specifications, and table 4-2 states the function of each one.

2.6.3 GPIB Connection

The IEEE-488 connector on the rear panel allows an external computer to control the 650 through the General-Purpose Interface Bus (GPIB).

Use standard pre-wired GPIB bus cables (available from Wavetek in one and two meter lengths) to connect the 650 and the other instruments on the bus to your controller. Table 2-1 names the signal carried by each pin of the GPIB connector (Amphenol 57-10240 or equivalent).

Table 2-1. GPIB Connector Pin Functions

Pin	Signal	Pin	Signal
1	DIO1	13	DIO5
2	DIO2	14	DIO6
3	DIO3	15	DIO7
4	DIO4	16	DIO8
5	EOI	17	REN
6	DAV	18	Signal Ground
7	NRFD	19	Signal Ground
8	NDAC	20	Signal Ground
9	IFC	21	Signal Ground
10	SRO	22	Signal Ground
11	ATN	23	Signal Ground
12	Chassis Ground	24	Signal Ground

2.6.4 Setting the GPIB Address

The controlling computer requires that you give a unique address to each instrument on the GPIB bus.

Set the power-up address of the 650 with the rear-panel **Address Selector** switch as shown in figure 2-2. You can override the rear-panel address by entering an address at the front panel with the **GPIB** key. However, a power loss or shut-down will erase the front-panel address.

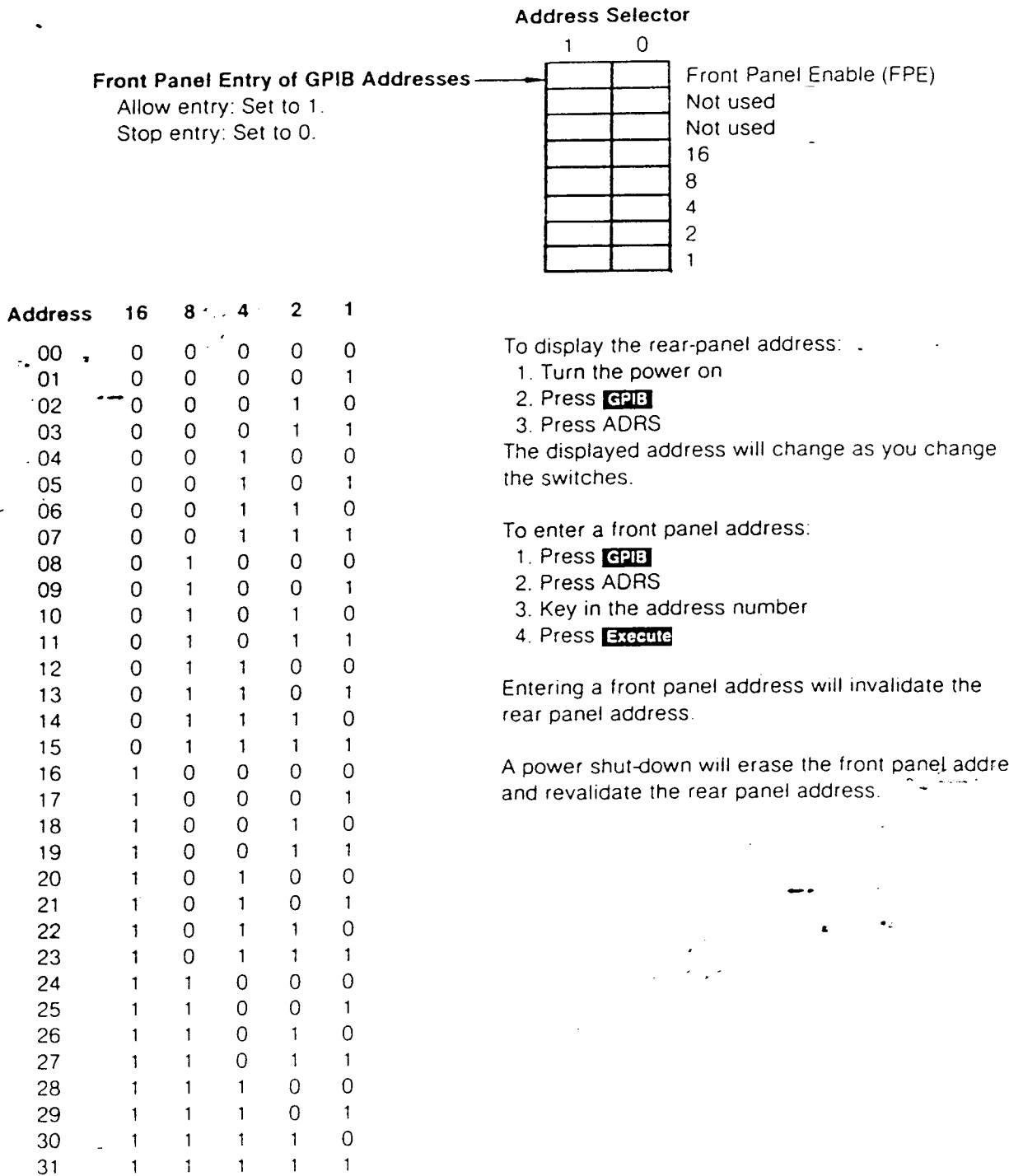

Figure 2-2. GPIB Address Selection

2.7 INITIAL CHECKOUT AND OPERATION VERIFICATION

The initial checkout and operation verification procedure tests the hardware and the operation of every front panel control. You can use it for two purposes:

- **Receiving Checkout.** The incoming inspection department should run this procedure to verify that the 650 hardware and controls work properly. The 650 left our factory in perfect condition. This procedure verifies that it received no shipping damage.
- **New Operator Training.** If you've never operated a 650 before, run this procedure to learn basic operation of the controls. See section 1.2 of this manual (learning to use the 650) for self-teaching instructions.

Power-Up Conditions. The 650 sets its parameters to selected known values at power-up. For example, power-

up conditions include open output relays, the main frequency set to 1000 Hz, and the sweep turned off. By using many of these power-up conditions, the initial checkout procedure avoids the additional steps required to enter new conditions and remains as short as possible.

Time Required. About 20 minutes, excluding hook-up time.

Equipment Required:

- Oscilloscope, 2 channels
- 2 BNC feedthrough terminations, 5W, 50Ω (40W, 50Ω optional)
- 2 BNC coaxial cables

CAUTION

The 650 can generate enough power to damage the 5W feedthrough termination. Always keep the output signal levels within the range of your load.

Table 2-2. Initial Checkout and Operation Verification Procedure

Step	Action	Screen Display or Response
1.	Remove all cables (if any) from the rear panel connectors.	
2.	Turn the power on.	<pre> WAUETEK MODEL 650 VARIABLE PHASE SYNTHESIZER 4 CHANNELS INSTALLED (Ux.x) </pre>
3.	Press the Utility key to bring up the utility menu.	<pre> LCD viewing angle: ## Deg chl ---environment--- ---hardware--- beep backlt VIEW config cal test </pre>
4.	Rotate the cursor knob to adjust the viewing angle of the liquid crystal display to suit yourself.	<pre> LCD viewing angle: 30 Deg chl ---environment--- ---hardware--- beep backlt VIEW config cal test </pre>
5.	Press the TEST key (F6) to bring up the self test menu.	<pre> chl -self test- ---trouble shoot- start abort select </pre>

Table 2-2. Initial Checkout and Operation Verification Procedure (Continued)

Step	Action	Screen Display or Response
6.	Press the START key (F1) to begin sequential testing of the 650 circuits.	<pre> SELFTEST IN PROGRESS %% TESTING [CIRCUIT NAME] %% -self test- ---trouble shoot- START abort select </pre> <p>The name of the circuit currently under test will appear on the second line of the display as the test proceeds. Table 5-6 in section 5 lists all the circuit name messages.</p>
7.	Wait until the test finishes (about 3 minutes for two channels or 5 minutes for four channels).	<pre> SELFTEST STOPPED ***** PASSED ALL TESTS ***** -self test- ---trouble shoot- START abort select </pre>
8.	If an error message (see table 5-6) appears, press the START key (F1) to re-run self test.	<p>If the error message repeats, the 650 will require calibration or repair.</p>
9.	Turn the power off, then back on.	<pre> WAUETEK MODEL 650 VARIABLE PHASE SYNTHESIZER 4 CHANNELS INSTALLED (V2.1) </pre>
10.	Connect the 650 to the oscilloscope and set the controls as shown in figure 2-3.	---
11.	Press the Channel key to bring up the channel menu for channel 1.	<pre> amplitude: 05.000 Upp ch1 01.767 Urms output ratio delay duty shift AMPL offset phase func </pre>
12.	Press the SHIFT key (F1) to transpose the bottom two rows.	<pre> amplitude: 05.000 Upp ch1 01.767 Urms ampl offset phase func shift output ratio delay duty </pre>

CAUTION

The 650 can generate enough power to damage the 5W feedthrough termination. Always keep the output signal levels within the power range of your load. Use 40W loads to test the maximum power.

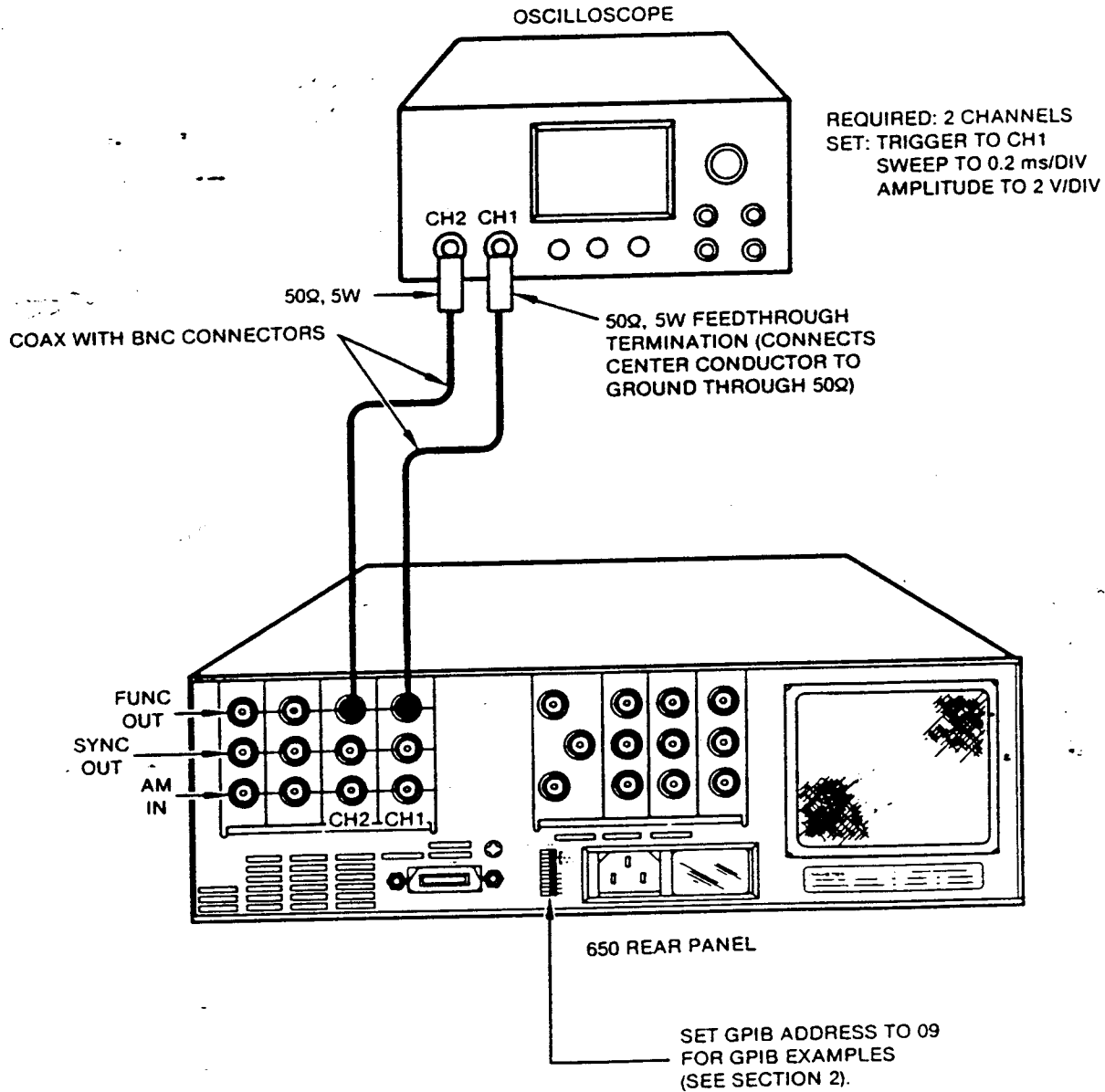

Note: If you omit the 50Ω loads and connect the channel outputs directly to the oscilloscope, the output waveforms will have 10V peak-to-peak amplitudes instead of the 5V p-p amplitudes given in the procedure.

Figure 2-3. Oscilloscope Connection for Checkout and Verification Procedure

Table 2-2. Initial Checkout and Operation Verification Procedure (Continued)

Step	Action	Screen Display or Response
13.	Press the OUTPUT key (F3) to call the CH1 output menu.	<pre>output: OFF(0) ch1 --output on/off--- OFF on-50<> on-0<></pre>
14.	Press the ON-50Ω key (F2) to turn on the output of channel 1.	<pre>output: ON 50 OHM(1) ch1 --output on/off--- off ON-50<> on-0<></pre>
<p>The oscilloscope will display a 1000 Hz 5Vp-p sine wave for channel 1.</p>		
15.	Press the Channel Number key to start the channel selection process.	<pre>output: ON 50 OHM(1) CH1 --output on/off--- off ON-50<> on-0<></pre>
16.	Press the 2 key to select channel 2.	<pre>channel: 2 ch1 --output on/off--- off on-50<> on-0<></pre>
17.	Press the Execute key to complete the channel selection process.	<pre>EXECUTE CH2 --output on/off--- off on-50<> on-0<></pre>
18.	Press the ON-50Ω key (F2) to turn on the output of channel 2.	<pre>output: ON 50 OHM(1) ch2 --output on/off--- off ON-50<> on-0<></pre>

The oscilloscope will display a 1000 Hz 5Vp-p sine wave for channel 2. The two waves will have the same phase.

Table 2-2. Initial Checkout and Operation Verification Procedure (Continued)

Step	Action	Screen Display or Response
19.	Press the Channel key to bring up the channel menu for channel 2.	<pre> amplitude: 05.000 Upp ch2 01.767 Urms output ratio delay duty shift AMPL offset phase func </pre>
20.	Press the PHASE key (F5) to display the phase of channel 2.	<pre> phase: 0,000,000.000 Deg ch2 output ratio delay duty shift ampl offset PHASE func </pre>
21.	Key in 180 on the keypad to start the phase entry process.	<pre> phase: 180 ch2 output ratio delay duty shift ampl offset PHASE func </pre>
22.	Press the Execute key to give the 180 phase to channel 2.	<pre> phase: 0,000,180.000 Deg ch2 output ratio delay duty shift ampl offset PHASE func </pre> <p data-bbox="797 1213 1430 1283">The channel 2 sine wave will change to 180° out of phase with the channel 1 sine wave.</p>
23.	Press the Main key to call the Main menu.	<pre> frequency: 001,000.0000 Hz ch2 -----main menu----- FREQ period mode burcnt </pre>
24.	Key in this number sequence to test the keys: 123456789.0 Exponent +/- 2	<pre> frequency: 123456789.0E-2 ch2 -----main menu----- FREQ period mode burcnt </pre>

Table 2-2. Initial Checkout and Operation Verification Procedure (Continued)

Step	Action	Screen Display or Response
25.	Press the Clear key to erase the entry and return to the previous display.	<pre> frequency: 001,000.0000 Hz ch2 -----main menu----- FREQ period mode burcnt </pre>
26.	Key in this number sequence: 2 Exponent 3, then press Execute .	<pre> frequency: 002,000.0000 Hz ch2 -----main menu----- FREQ period mode burcnt </pre> <p data-bbox="891 747 1542 814">The oscilloscope will display a 2000 Hz sine wave for both channels.</p>
27.	Repeatedly press the left cursor arrow to move the cursor to the thousands position.	<pre> frequency: 002,000.0000 Hz ch2 -----main menu----- FREQ period mode burcnt </pre>
28.	Press the up cursor arrow twice to change the frequency to 4,000 Hz.	<pre> frequency: 004,000.0000 Hz ch2 -----main menu----- FREQ period mode burcnt </pre> <p data-bbox="899 1304 1528 1371">The oscilloscope will display 3000 Hz then 4000 Hz sine waves.</p>
29.	Press the down cursor arrow twice to return the frequency to 2000 Hz.	<pre> frequency: 002,000.0000 Hz ch2 -----main menu----- FREQ period mode burcnt </pre> <p data-bbox="899 1612 1511 1646">The oscilloscope will display 2000 Hz sine waves.</p>
30.	Press the right cursor arrow twice to move the cursor to the tens position.	<pre> frequency: 002,000.0000 Hz ch2 -----main menu----- FREQ period mode burcnt </pre>

Table 2-2. Initial Checkout and Operation Verification Procedure (Continued)

Step	Action	Screen Display or Response
31.	Rotate the cursor knob clockwise to increase the frequency, then counterclockwise until the frequency reads 1000 Hz.	<pre> frequency: 001,000.0000 Hz ch2 -----main menu----- FREQ period mode burcnt </pre> <p>The oscilloscope waveforms will display the changing frequency.</p>
32.	Press the Sweep key to call the sweep menu.	<pre> sweep mode: OFF (0) ch2 -----sweep select----- --dynamic-- OFF freq phase both comp monit </pre>
33.	As you perform the following steps, refer to the sweep menu tree in the operation reference section.	Watching the tree as you press the keys will show you how the menu trees operate.
34.	Press the FREQ key (F2) to call the frequency sweep parameters menu.	<pre> ch2 ---frequency sweep parameters--- mode limits time marker func </pre>
35.	Press the MODE key (F1) to call the frequency sweep mode menu.	<pre> sweep mode: OFF (0) ch2 -----frequency sweep mode menu----- cont trig s-fsk a-fsk seqnce extfm </pre>
36.	Press the TRIG key (F2) to call the triggered frequency sweep mode menu.	<pre> sweep mode: OFF (0) ch2 -trig freq sweep mode menu- reset revers hld/rs hld/rv </pre>

Table 2-2. Initial Checkout and Operation Verification Procedure (Continued)

Step	Action	Screen Display or Response
37.	Press the RESET key (F1) to active sweep mode 3: <code>FREQ:TRIG-RESET(3)</code>	<pre>sweep mode: FREQ:TRIG-RESET(3) ch2 -trig freq sweep mode menu- RESET revers hld/rs hld/rv</pre>
38.	Press the Manual Trigger key to trigger the sweep.	Both channels will sweep from 1000 Hz to 10,000 Hz in one second, then reset to 1000 Hz.
39.	Press the Sweep key to recall the sweep menu.	<pre>ch2 -----sweep select----- --dynamic-- off FREQ phase both comp monit</pre>
40.	Press the OFF key (F1) to turn off the frequency sweep.	<pre>sweep mode: OFF (0) ch2 -----sweep select----- --dynamic-- OFF freq phase both comp monit</pre>
41.	Press the PHASE key (F3) to call the phase sweep parameters menu.	<pre>ch2 -----phase sweep parameters----- mode limits time dlt-a-f marker func</pre>
42.	Press the MODE key to call the phase sweep mode menu.	<pre>sweep mode: OFF (0) ch2 -----phase sweep mode menu----- cont trig seqnce delta ext-pm</pre>
43.	Press the CONT key to call the continuous phase sweep mode menu.	<pre>sweep mode: OFF (0) ch2 Cont phase sweep mode menu reset revers</pre>

Table 2-2. Initial Checkout and Operation Verification Procedure (Continued)

Step	Action	Screen Display or Response
44.	Press the REVERS key to active sweep mode 14: PHASE:CONT-REVERSE(14)	<pre>sweep mode: PHASE:CONT-REVERSE(14) ch2 Cont phase sweep mode menu reset REVERS</pre> <p>Channel 2 will continuously sweep phase left and right 360°.</p>
45.	Press the Hold/Resume key.	Channel 2 will stop the phase sweep at the current position and hold the waveform in place.
46.	Press the Hold/Resume key.	Channel 2 will resume sweeping from the stopped position.
47.	Press the Trigger key to call the trigger menu.	<pre>trigger level: 01.4 Vdc ch2 --trigger-- ---source--- --slope-- freq LEVEL EXTRNL intrnl POS neg</pre>
48.	Press the GPiB key to call the GPiB menu.	<pre>gpib address: 09 (00001001) -----disply gpib----- ---send--- ADRS srqbuf lsnbuf syntax local srq</pre> <p>The rear panel Address Selector switch determines the power-up GPiB address.</p>
49.	Press the SYNTAX key to display the GPiB amplitude command.	<pre>0: AMPLITUDE:AM -----disply gpib----- ---send--- adrs srqbuf lsnbuf SYNTAX local srq</pre>
50.	Rotate the cursor knob to scan through the complete list of 650 GPiB commands. See table 6-2 in section 6 for more about each command.	<pre>115: VERSION?:URS? -----disply gpib----- ---send--- adrs srqbuf lsnbuf SYNTAX local srq</pre>

Table 2-2. Initial Checkout and Operation Verification Procedure (Continued)

Step	Action	Screen Display or Response
51.	Press the Stored Settings key to call the stored settings menu.	<pre>no settings recalled -- store setting menu- store RECALL disabl enable</pre>
52.	Press the Quick Calibrate key to quick calibrate the 650. See section 7.1 for more information about quick calibration.	<pre>no settings recalled *** quick cal *** -- store setting menu-- = store RECALL disabl enable</pre> <p data-bbox="867 779 1438 842">The *** quick cal *** message will flash in the position shown above.</p>
53.	Press the Reset key to call the reset menu.	<pre>--reset menu- params ovoid</pre>
54.	Press PARAMS key to reset the parameters to the power-up conditions.	<pre>RESET --reset menu- PARAMS ovoid</pre> <p data-bbox="878 1293 1495 1386">The waveforms on the oscilloscope will disappear because the power-up conditions include open output relays.</p>

2.8 SYSTEM (MASTER/SLAVE) INSTALLATION

Up to ten 650 units, each with four channels, can interconnect to form a system that provides up to 40 phase-coherent, phase-controlled signals. One unit, called the master, serves as the phase reference for the other units, called slaves.

Connect the units as shown in figure 7-5 in the calibration section. Mount the units one above the other in a rack and keep the cables as short as possible. After you have finished installing the units, calibrate the system as described in section 7.5.

2.9 BATTERY REPLACEMENT

An internal lithium battery protects the auto calibration data and stored settings of the 650. You can expect this battery to last for about 5 years.

Effects of Data Loss. Loss of auto calibration data poses no serious problem because the auto-cal procedure can restore it easily. Loss of stored settings poses more of a problem, but only if you store a lot of complicated setups. Keep a written record of your important setups.

Front Panel Warning. The 650 warns of low battery voltage when you power up. Normally, the power-up display looks like this:

WAVETEK MODEL 650
VARIABLE PHASE SYNTHESIZER
4 CHANNELS INSTALLED
(Ux . x)

A 650 with low battery voltage will power up with this display:

WAVETEK MODEL 650
*** 3V battery is low: ### V ***
4 CHANNELS INSTALLED
(Ux . x)

GPIB Warning. If the 650 connects through the GPIB bus to an instrumentation controller, it will also signal low battery by sending an SRQ (service request) to the controller and placing a /HE:2 LOW BATTERY = ## V/ message in the SRQ buffer. See section 6 for further GPIB information.

Voltage Ranges. The battery voltage falls into the following ranges. Once a battery drops below 2.4 volts, it usually takes from 10 to 100 hours to drop into the data loss region.

3.0V to 2.4V	Good battery. Normal voltage operating range.
2.4V to 2.0V	Failing battery. Data remains protected, but the 650 will generate low-battery warning messages.
2.0V to 0V	Dead battery. Data loss.

Battery Ordering. To get a new battery, order Lithium Battery, 3V, Part Number 4000-02-0009 from Wavetek.

Tools Required:

- Low-wattage printed circuit soldering iron
- Solder extractor
- Rosin-core solder
- Screwdrivers

BATTERY REPLACEMENT PROCEDURE

NOTE

Removing the battery erases the auto-calibration data and the stored settings.

1. Record on paper your stored settings, if any.
2. Turn off the 650 and pull the power cord out of its rear-panel socket.
3. Remove the three screws at the top back that hold the cover in place.
4. Remove the top cover by pulling it up at the back, then sliding it to the rear.
5. Remove the three screws that hold the rear-panel decal plate in place.
6. Remove the decal plate.
7. Remove the μ P/Sample and Hold board (see figure 2-4).
8. Locate the lithium battery (see figure 2-4).

WARNING

DO NOT RECHARGE, SHORT CIRCUIT, DISASSEMBLE, OR APPLY HEAT TO THE LITHIUM BATTERY. VIOLATING THIS RULE COULD RELEASE POTENTIALLY HARMFUL LITHIUM. OBSERVE POLARITY WHEN YOU REPLACE THE BATTERY.

9. Use the low-wattage soldering iron and solder extractor to unsolder the battery. Avoid excessive heat.
10. Insert the new battery and solder it in place. Avoid excessive heat.
11. Put the μ P/Sample and Hold board back in the 650.
12. Replace the decal plate and the screws that hold it in place.

13. Replace the top cover and the screws that hold it in place.
14. Plug in the power cord and turn on the 650. The standard power-up display should appear.
15. Wait 20 minutes to allow the internal temperature to stabilize, then run auto calibration by pressing this key sequence: **Utility** CAL START.
16. Re-enter your stored settings (if any) either manually or via the GPIB. You can re-enter them while the internal temperature stabilizes.

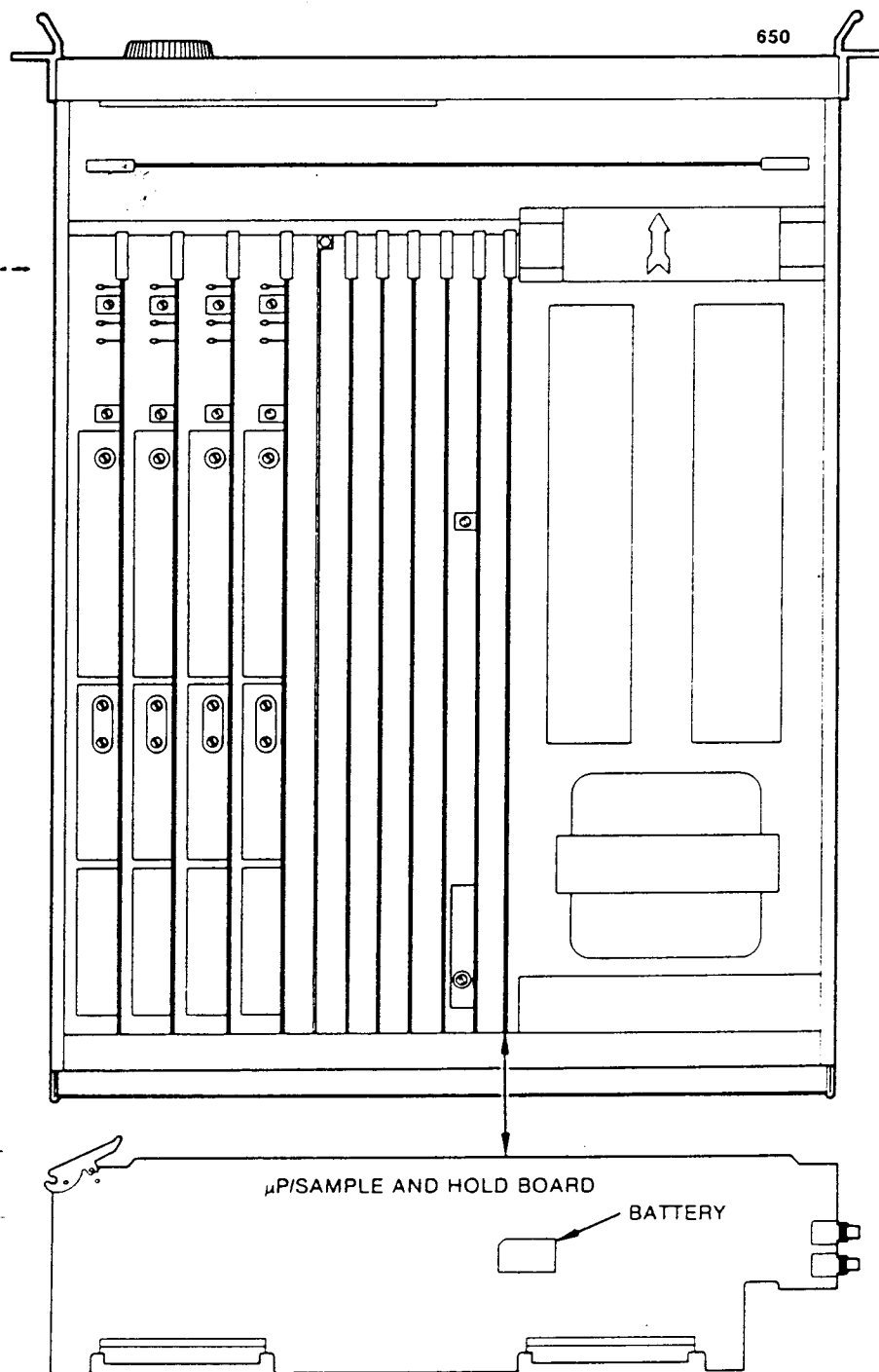

Figure 2-4. Lithium Battery Location

2.10 SCHEDULED MAINTENANCE

The 650 requires the following periodic maintenance:

Period	Action	Reference
Weekly	Run auto calibration	7.3
Monthly	Clean air intake	2.10.1
6 Months	Check manual calibration, re-calibrate if necessary.	7.2

2.10.1 Air Filter Maintenance

Remove the lint from the wire screen air intake on the rear panel of the 650 once every month or more often if necessary.

SECTION 3

CAPABILITIES

3.1 INTRODUCTION

This section describes the capabilities of the Model 650 with a series of illustrations. Each illustration describes one capability and contains a waveform

drawing, a page number reference to the operating instructions, and brief specifications. The capabilities fall into these categories:

Category	Capabilities	Page
Non-Sweep Modes	Continuous Triggered Burst Sync Gated Async Gated Phase Lock Waveform Hold	3-2
Sweep Choices	Frequency Sweep Phase Sweep Both Sweep Sequential Sweep Hold Sweep Linear Sweep Log Sweep Sine Sweep Random Sweep	3-4
Sweep Modes	Continuous Sweep with Auto Reset Continuous Sweep with Auto Reverse Triggered Sweep with Auto Reset Triggered Sweep with Auto Reverse Triggered Sweep/Hold with Trig Reset/Hold Triggered Sweep/Hold with Trig Reverse/Hold Sequential with Triggered Steps Sequential with Continuous Stepping Sequential with Triggered Single Pass	3-8
Channel Control	Waveform Choices Frequency Multiplier Waveform Amplitude Waveform Offset Square Wave Duty Cycle Ramp Duty Cycle Phase Output Impedance Amplitude Modulation Sync Out Delta Frequency	3-10
Triggering	Internal External Front Panel GPIB	3-13
Modulation	Frequency Modulation Phase Modulation Amplitude Modulation Combined (FM/PM)	3-14
Shift Keying	Synchronous Frequency Shift Keying (S-FSK) Asynchronous Frequency Shift Keying (A-FSK) Asynchronous Multiple Frequency Shift Keying Asynchronous Multiple Phase Shift Keying	3-16
Sweep Progress Indicators	Screen Sweep Monitor Sweep Horizontal Out Sweep Marker	3-17

CONTINUOUS

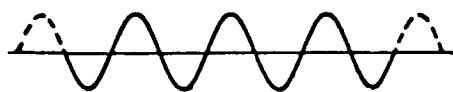

CH1-4

Page 5-3

TRIGGERED

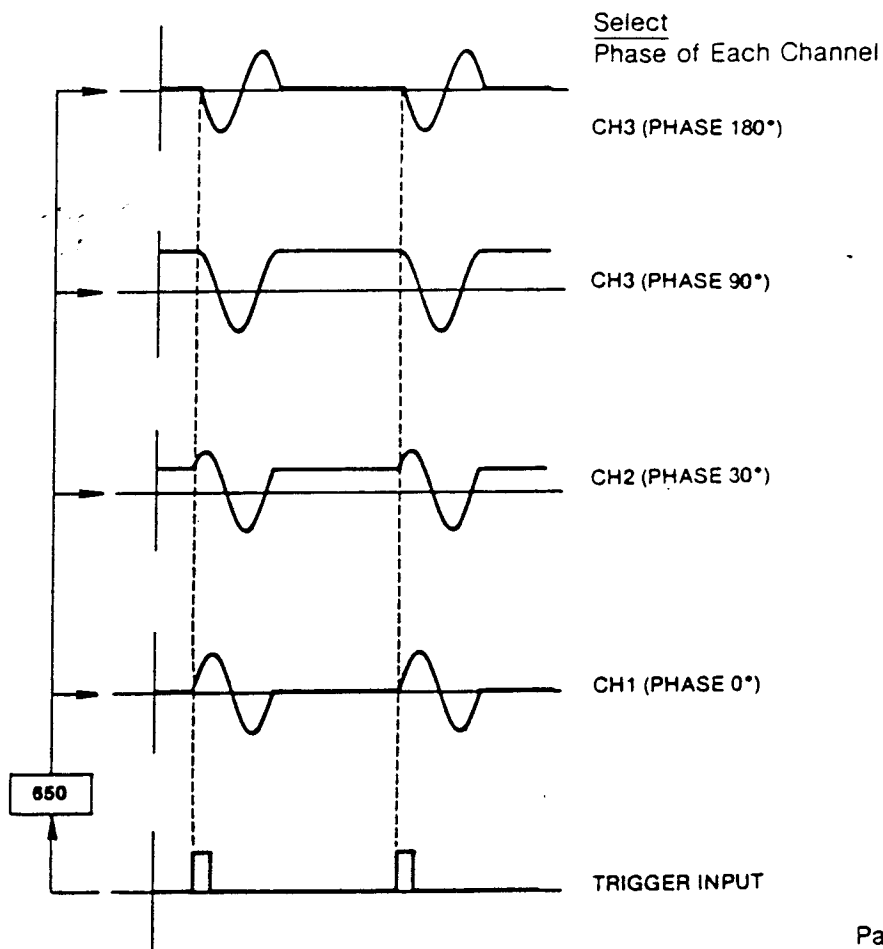

Page 5-3

BURST

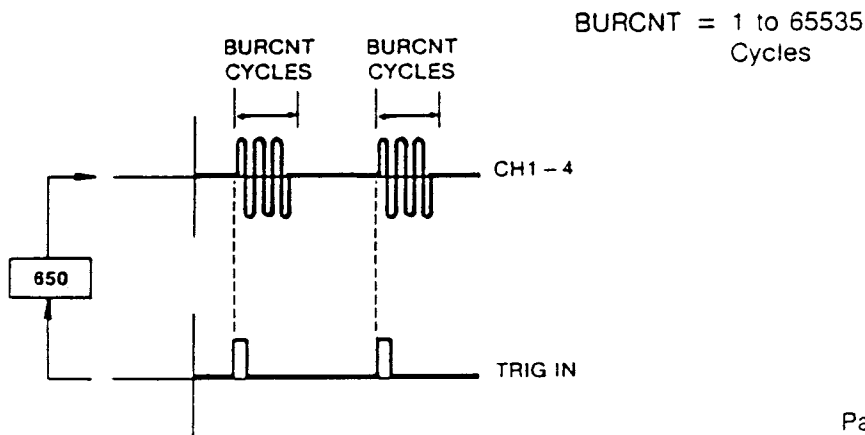

Page 5-3

SYNC GATED

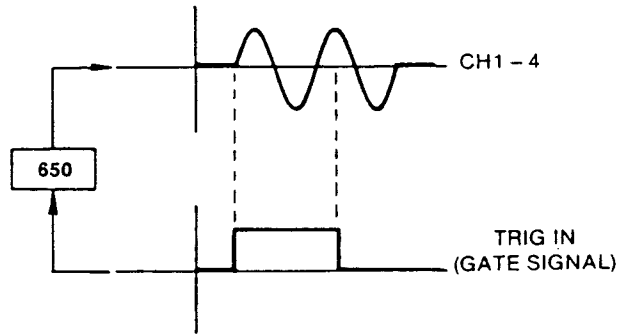

Page 5-3

ASYNCH GATED

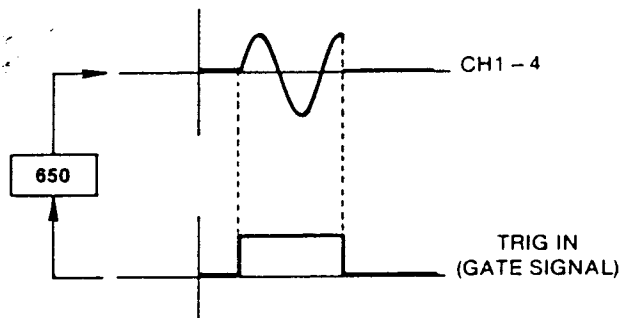

Page 5-3

PHASE LOCK

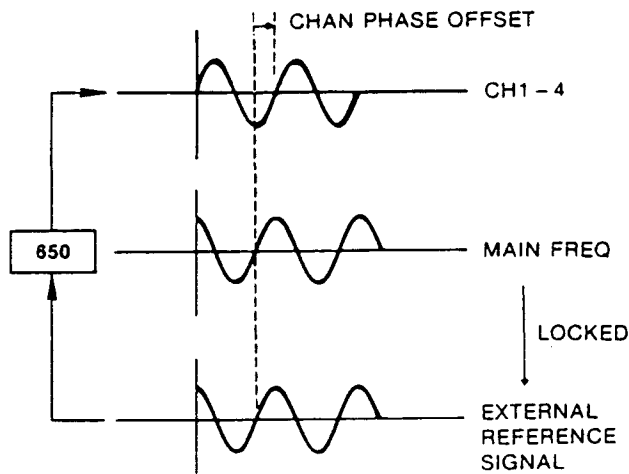

Note: Trig level must be adj. within Range of Input Signal

40 Hz to 2 MHz
>500 mVp-p

Page 5-3

WAVEFORM HOLD

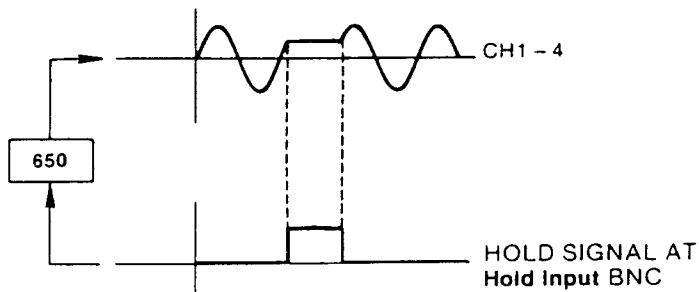

Page 5-37

FREQUENCY SWEEP

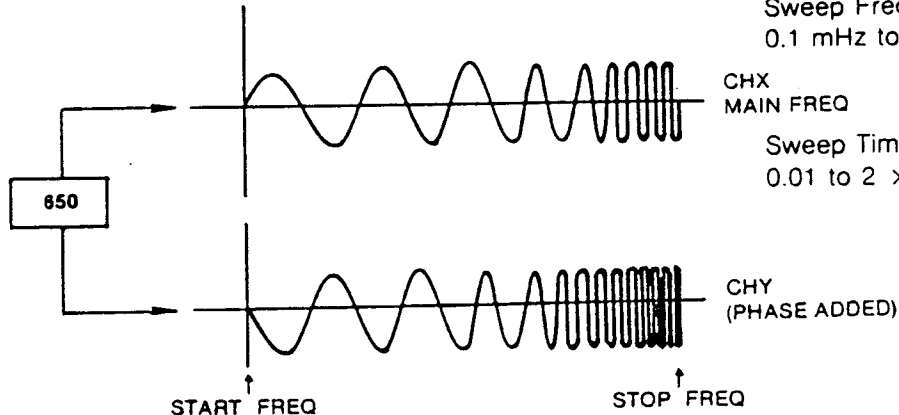

Sweep Freq Range:
0.1 mHz to 2 MHz

Sweep Time Range:
0.01 to 2×10^7 sec

PHASE SWEEP

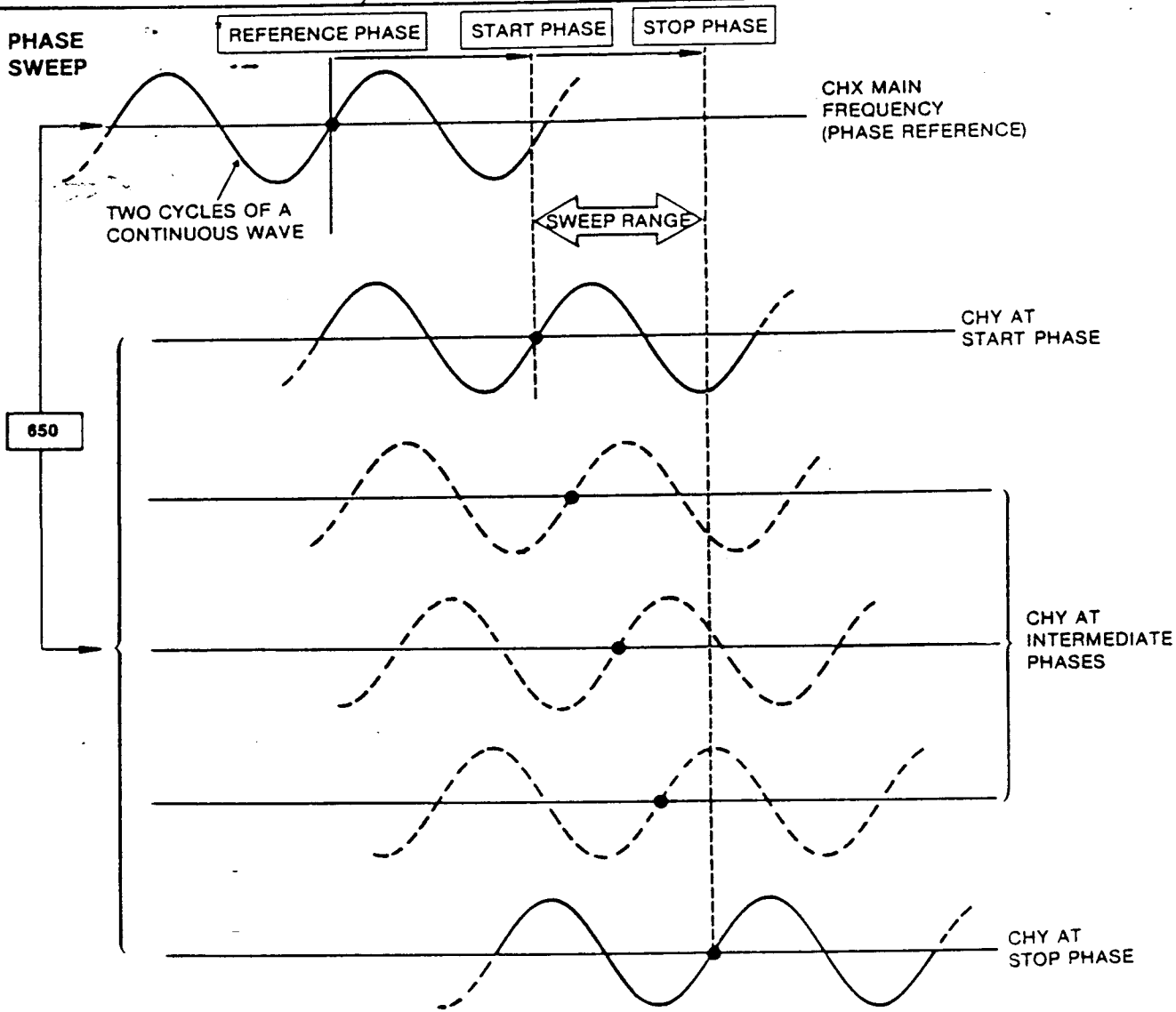

Phase Sweep Range:
 -10^6 to $+10^6$ degrees

Sweep Time Range:
0.01 to 2×10^7 sec

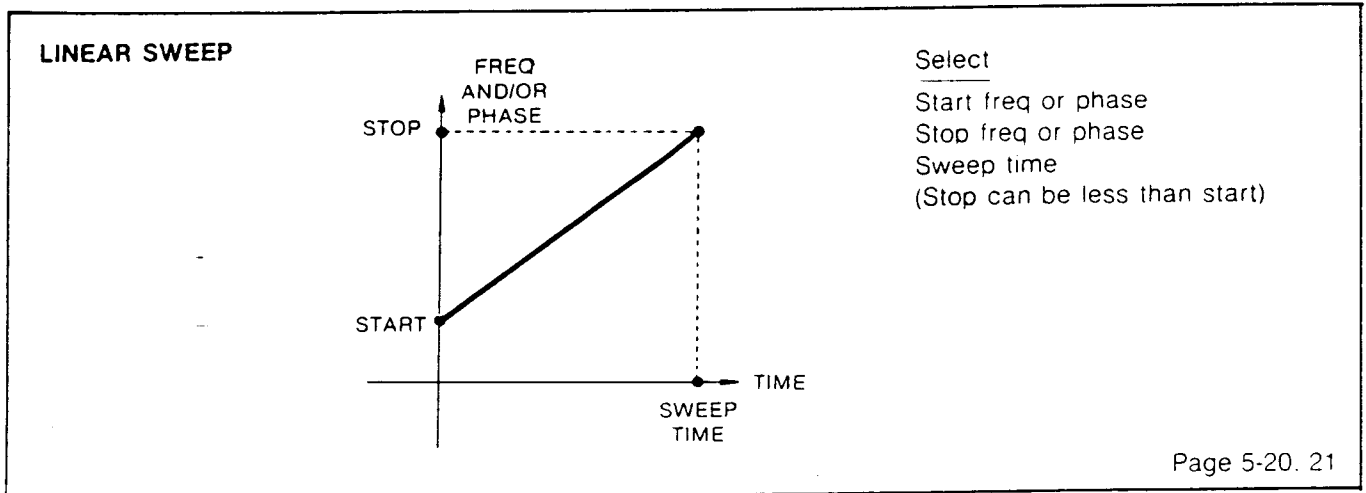
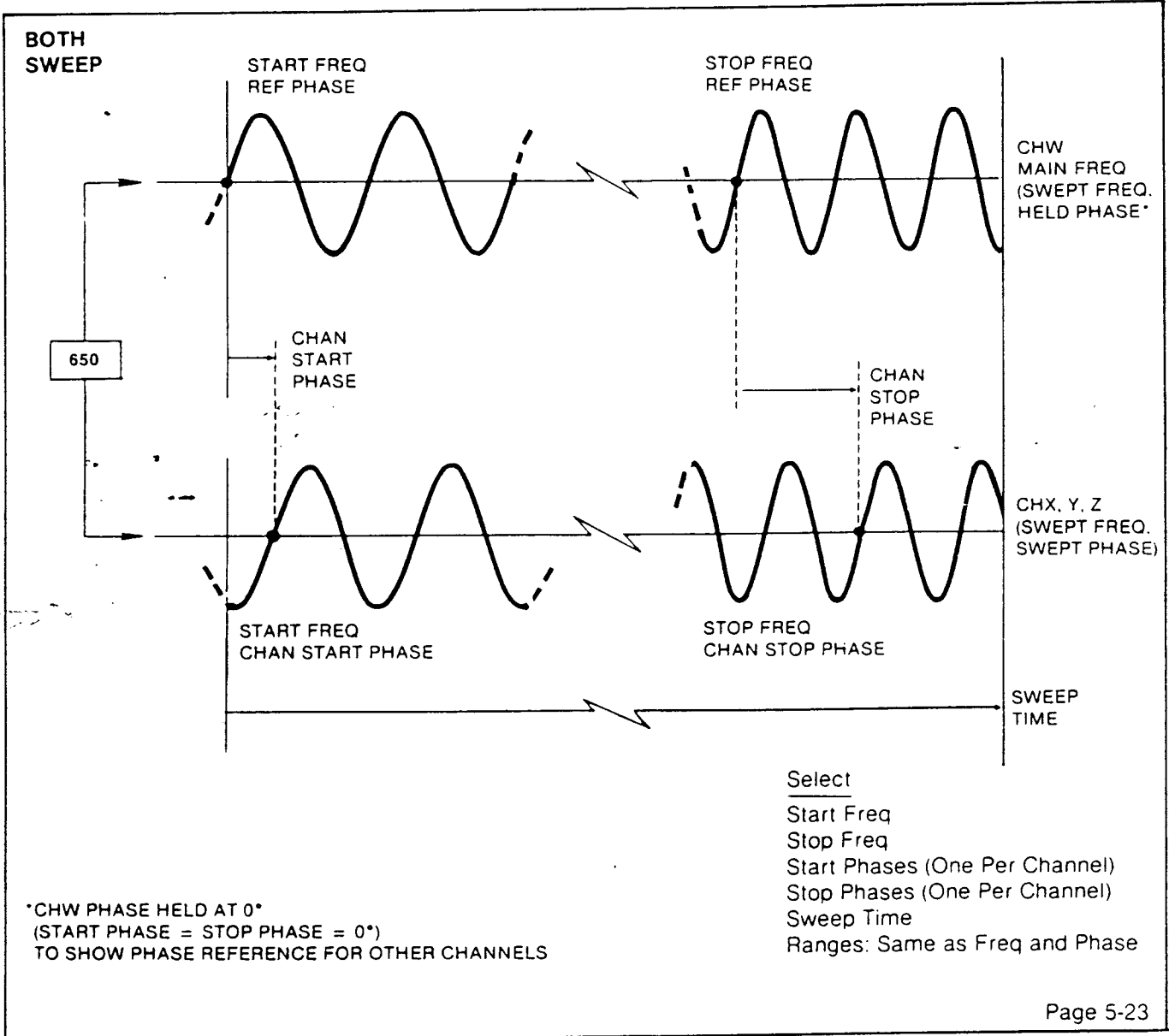

LOG SWEEP

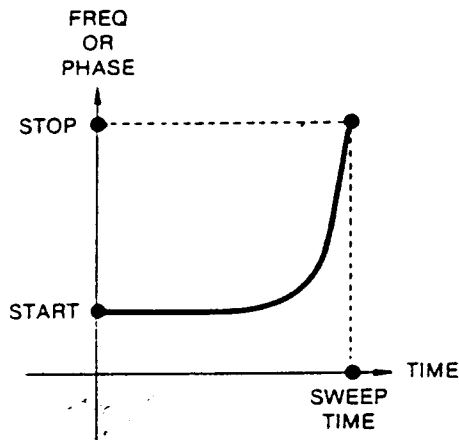

Select
 Start freq or phase
 Stop freq or phase
 Sweep time
 (Stop can be less than start)

Page 5-20, 21

SINE SWEEP

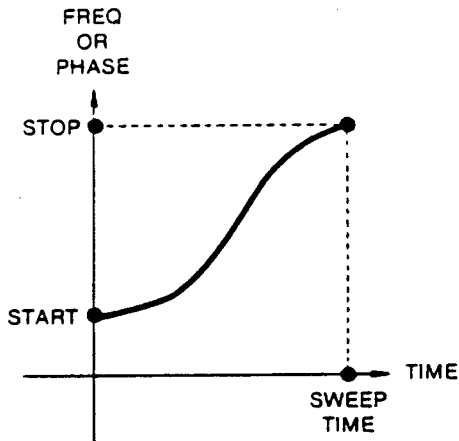

Select
 Start freq or phase
 Stop freq or phase
 Sweep time
 (Stop can be less than start)

Page 5-20, 21

SEQUENTIAL SWEEP

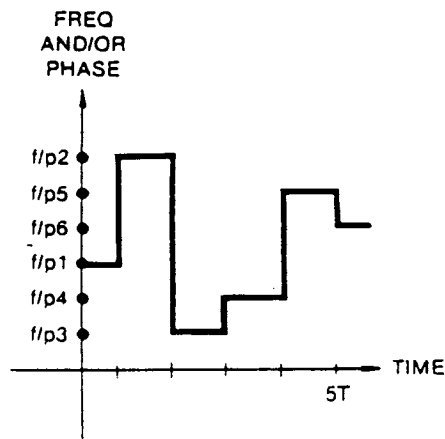

Select
 Freq or phase of each step
 (99 steps max)
 Time per step

Page 5-27

RANDOM SWEEP

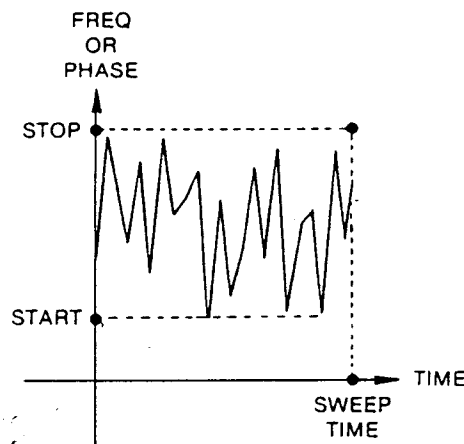

Select
Start (lower limit) freq or phase
Stop (upper limit) freq or phase
Sweep time

HOLD SWEEP

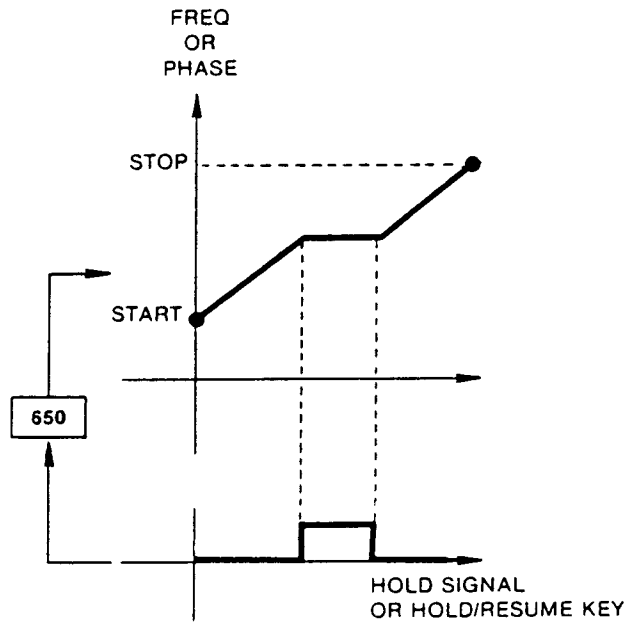

CONTINUOUS SWEEP WITH AUTO RESET

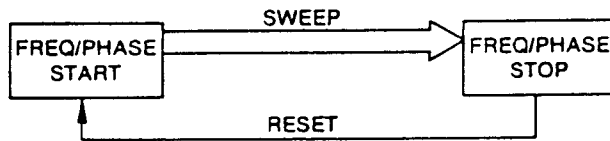

	FREQ	PHSE	BOTH
MODE	1	13	24
PAGE	5-22	5-22	5-23

CONTINUOUS SWEEP WITH AUTO REVERSE

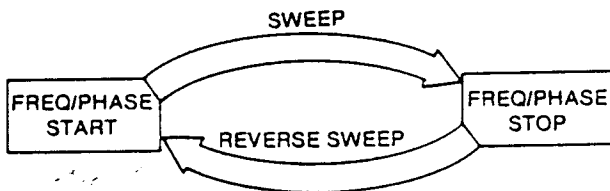

	FREQ	PHSE	BOTH
MODE	2	14	—
PAGE	5-22	5-22	—

TRIGGERED SWEEP WITH AUTO RESET

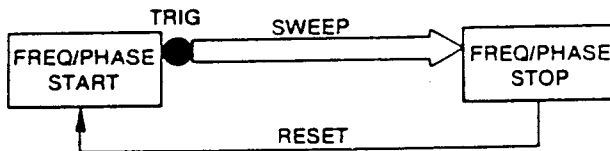

	FREQ	PHSE	BOTH
MODE	3	15	—
PAGE	5-24	5-25	—

TRIGGERED SWEEP WITH AUTO REVERSE

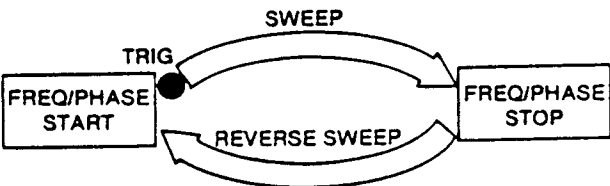

	FREQ	PHSE	BOTH
MODE	4	16	—
PAGE	5-24	5-25	—

TRIGGERED SWEEP/HOLD WITH TRIG RESET/HOLD

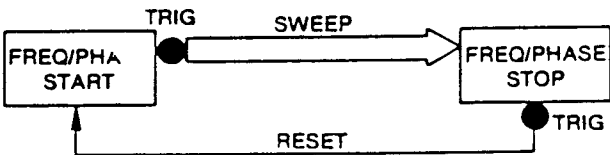

	FREQ	PHSE	BOTH
MODE	5	17	25
PAGE	5-24	5-25	5-25

TRIGGERED SWEEP/HOLD WITH TRIG REVERSE/HOLD

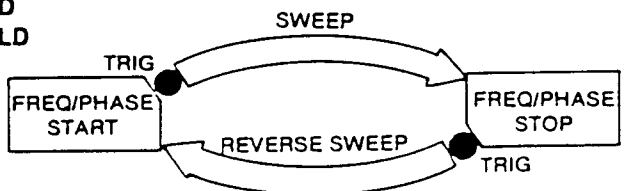

	FREQ	PHSE	BOTH
MODE	6	18	—
PAGE	5-24	5-25	—

Note: START<STOP or START>STOP

SEQUENTIAL WITH TRIGGERED STEPS

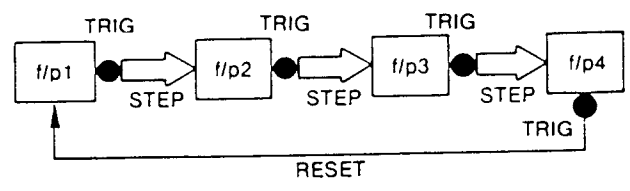

EXTR-SEQUENCE			
	FREQ	PHSE	BOTH
MODE	9	19	26
PAGE	5-29	5-29	5-30

SEQUENTIAL WITH CONTINUOUS STEPPING

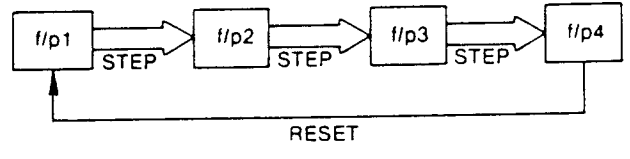

CONT-SEQUENCE			
	FREQ	PHSE	BOTH
MODE	10	20	27
PAGE	5-29	5-29	5-30

SEQUENTIAL WITH TRIGGERED SINGLE PASS

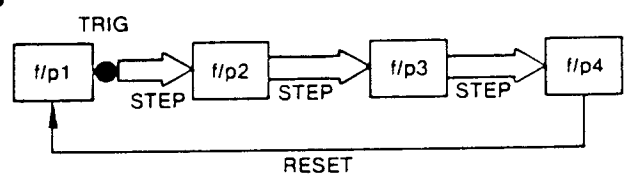

TRIG-SEQUENCE			
	FREQ	PHSE	BOTH
MODE	11	21	28
PAGE	5-29	5-29	5-30

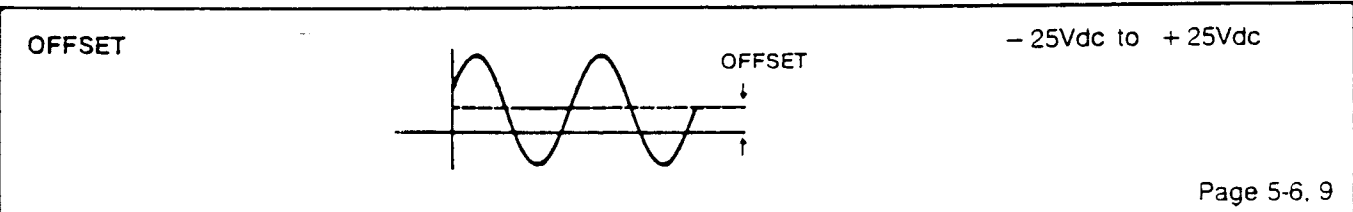
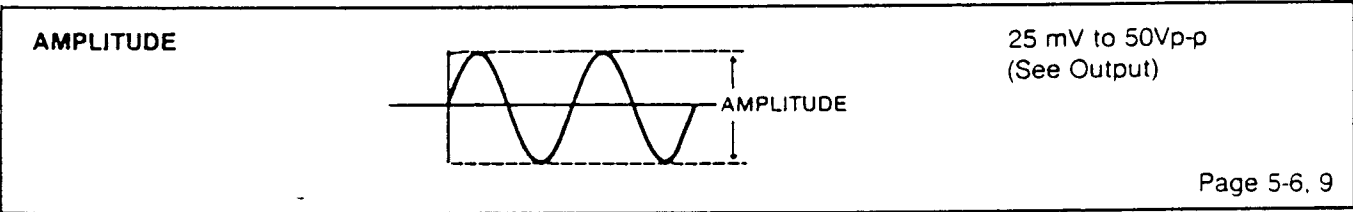
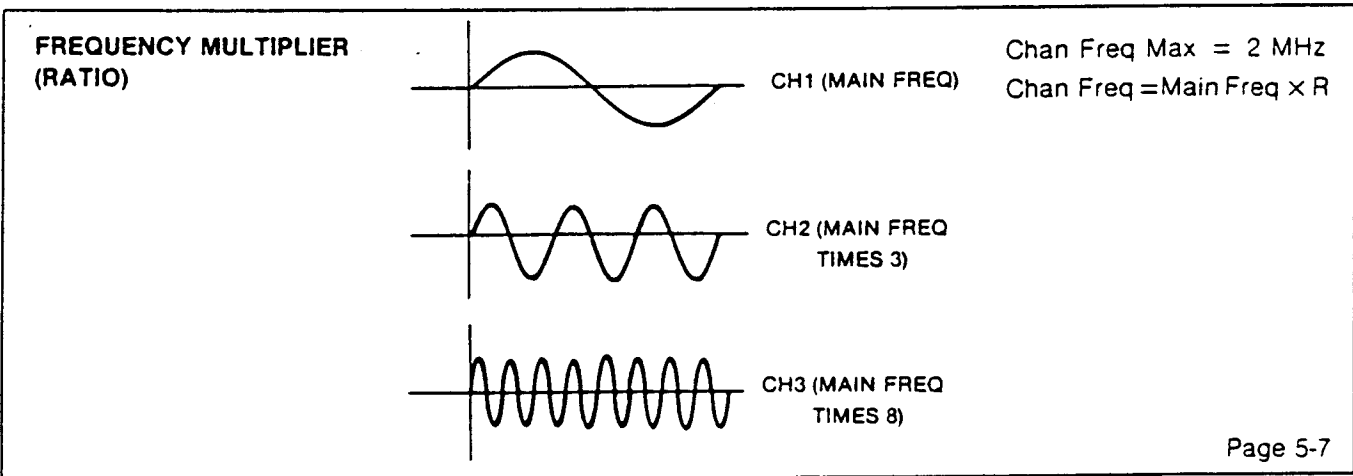
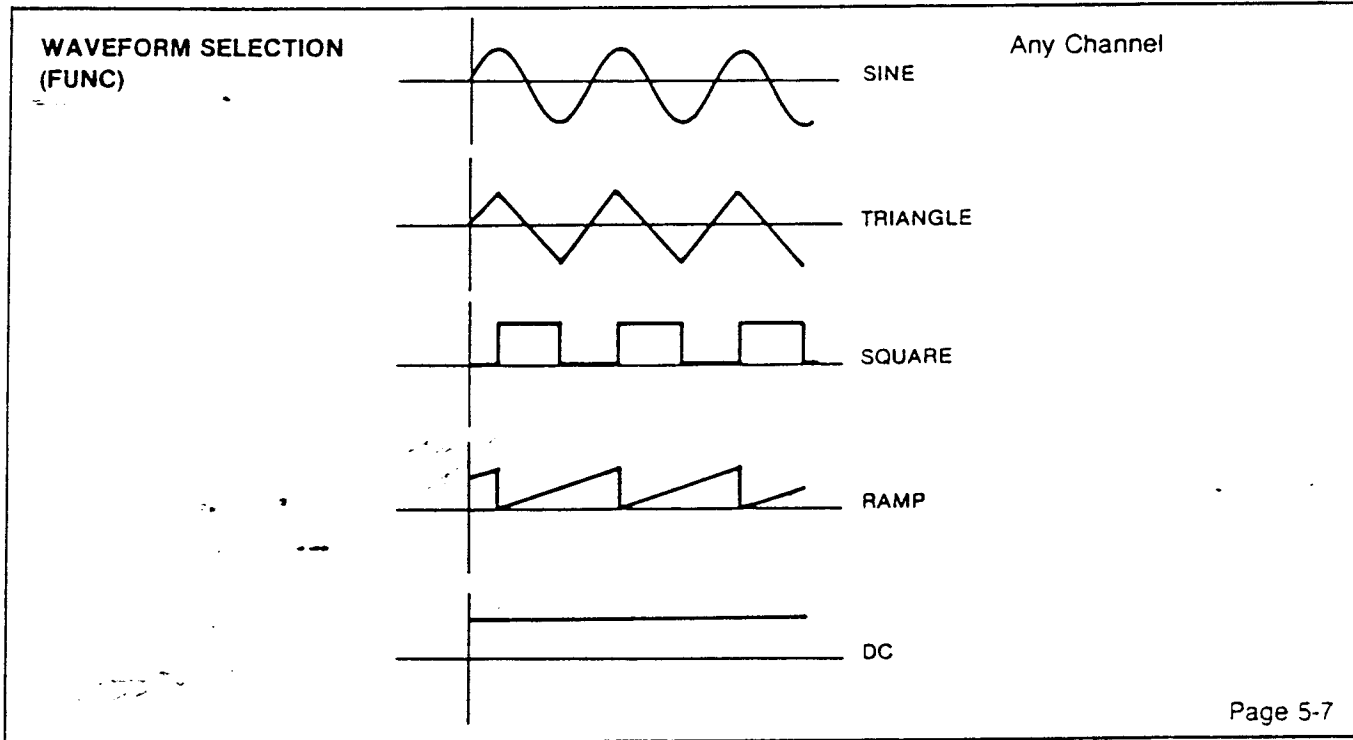

SQUARE WAVE DUTY CYCLE

Duty Cycle: 20 – 80%

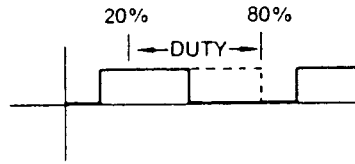

Page 5-7

RAMP DUTY CYCLE

Duty Cycle: 0 – 100%

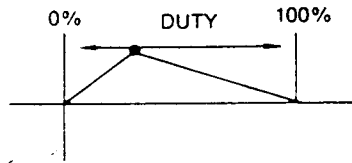

Page 5-7

PHASE

- 10⁶ to + 10⁶ degrees

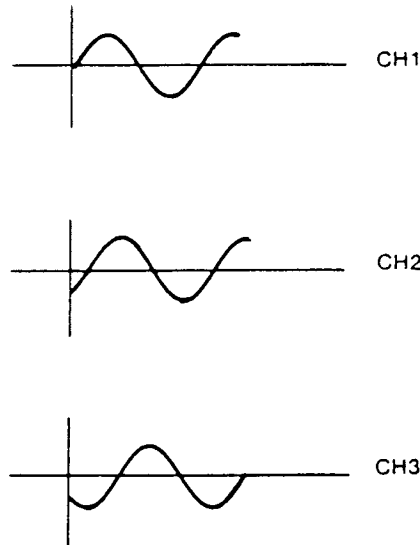

note:

Page 5-6

OUTPUT IMPEDANCE

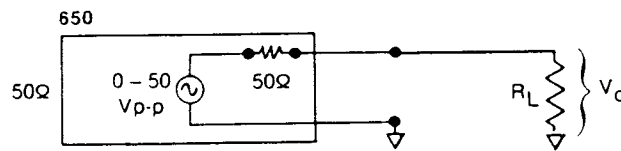
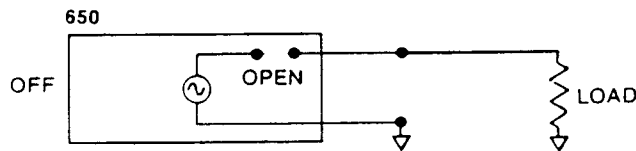

$V_o = 25 \text{ mV to } 25 \text{ Vp-p}$
 $R_L = 50\Omega$

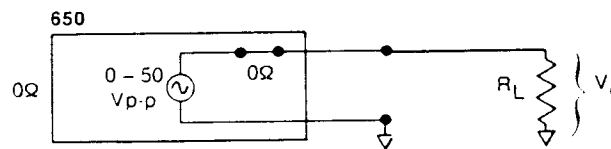

$V_o = 2.5\text{V to } 50\text{Vp-p}$
 $R_L \geq 50\Omega$

Page 5-6

AMPLITUDE MODULATION (AM)

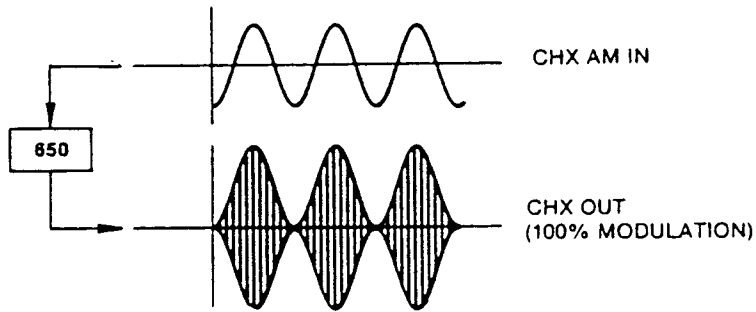

Page 5-47

SYNC OUT

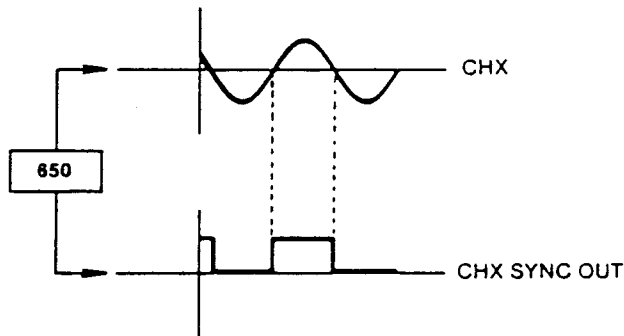

Page 4-4

DELTA FREQUENCY

$$1 < \text{RATIO} < 99$$

$$0.1 \text{ mHz} < \text{DLTA-F} < 1000 \text{ Hz}$$

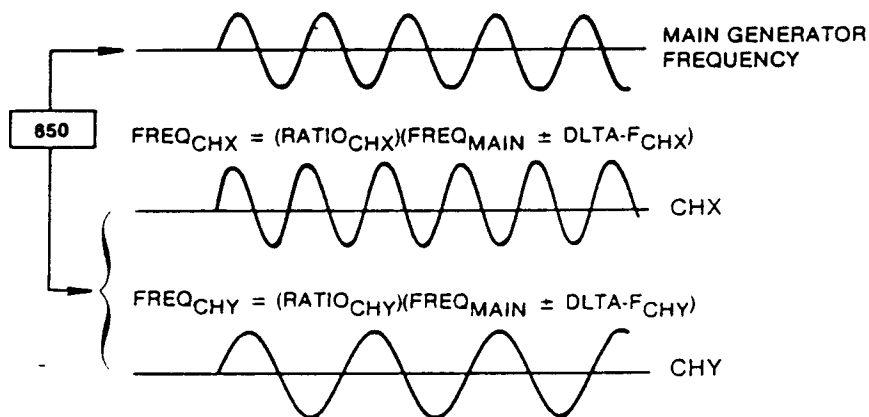

Page 5-35

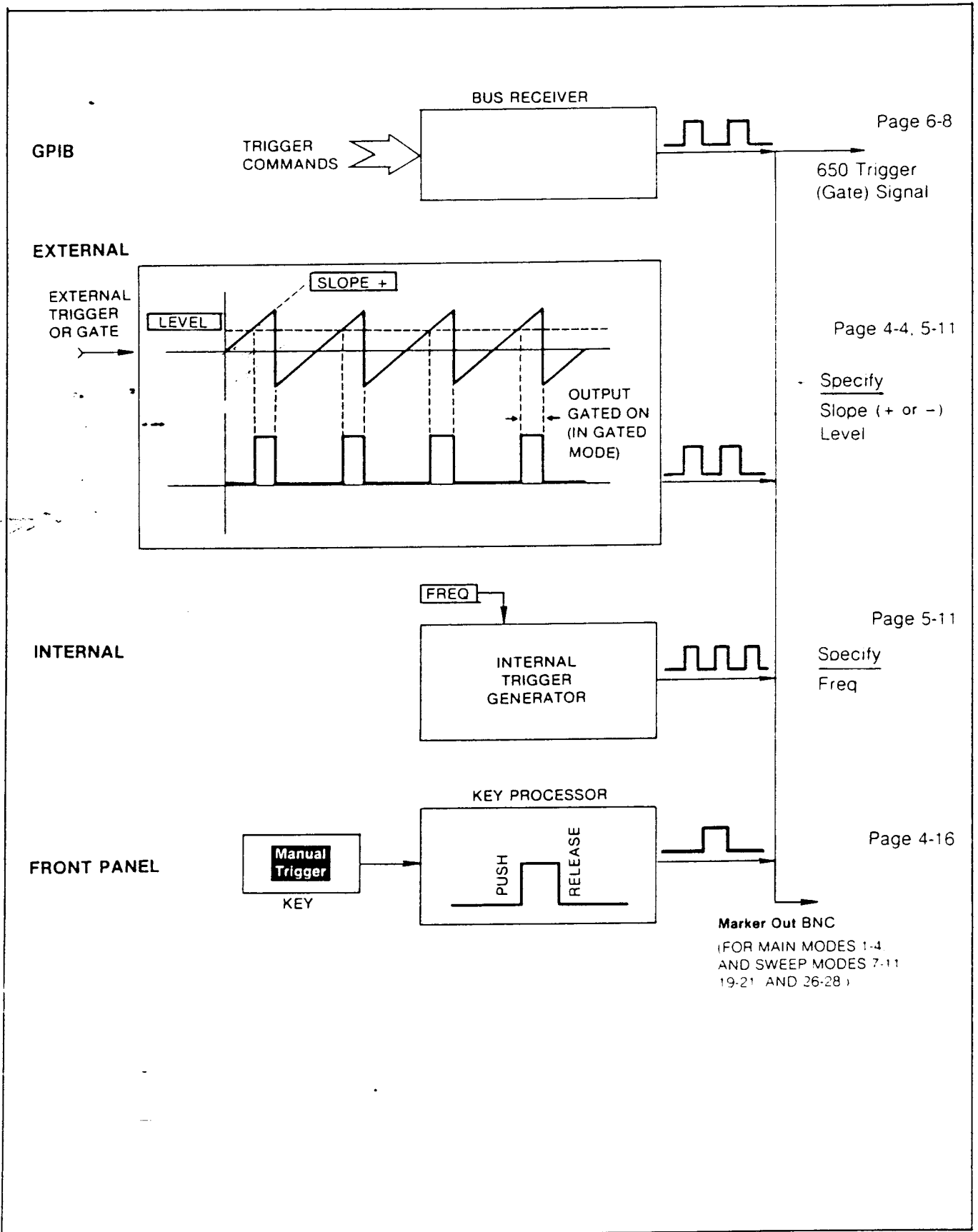

FREQUENCY MODULATION (FM)

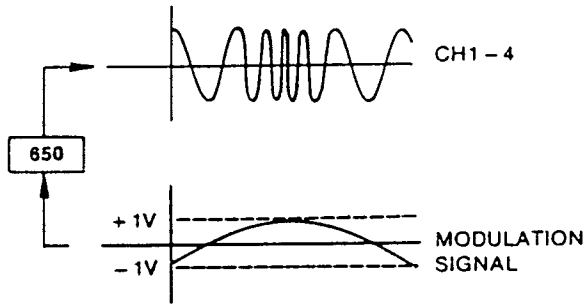

Select

Start Freq Limit (for -1V)
Stop Freq Limit (for +1V)

$\pm 1V = 100\%$ modulation
from start to stop
frequencies.

$F_{min} \geq 100 \mu\text{Hz}$

$F_{max} \leq 2 \text{ MHz}$

PHASE MODULATION (PM)

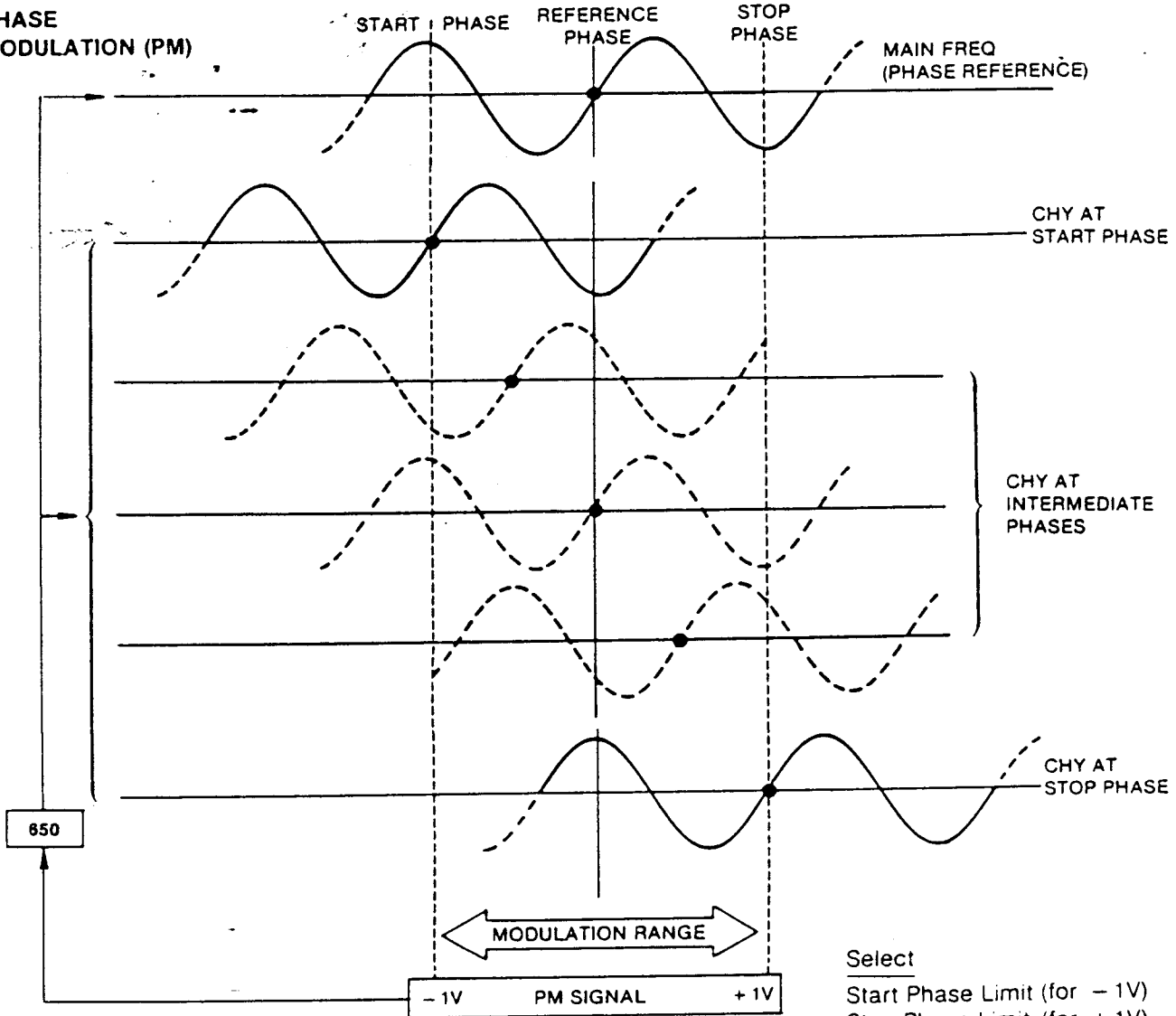

Select

Start Phase Limit (for -1V)
Stop Phase Limit (for +1V)

$\pm 1V = 100\%$ modulation
from start to stop phases.

The 650 permits non-symmetrical values such as
START = 95°
STOP = 520°

Illustration shows
START = $+270^\circ$
STOP = -270°

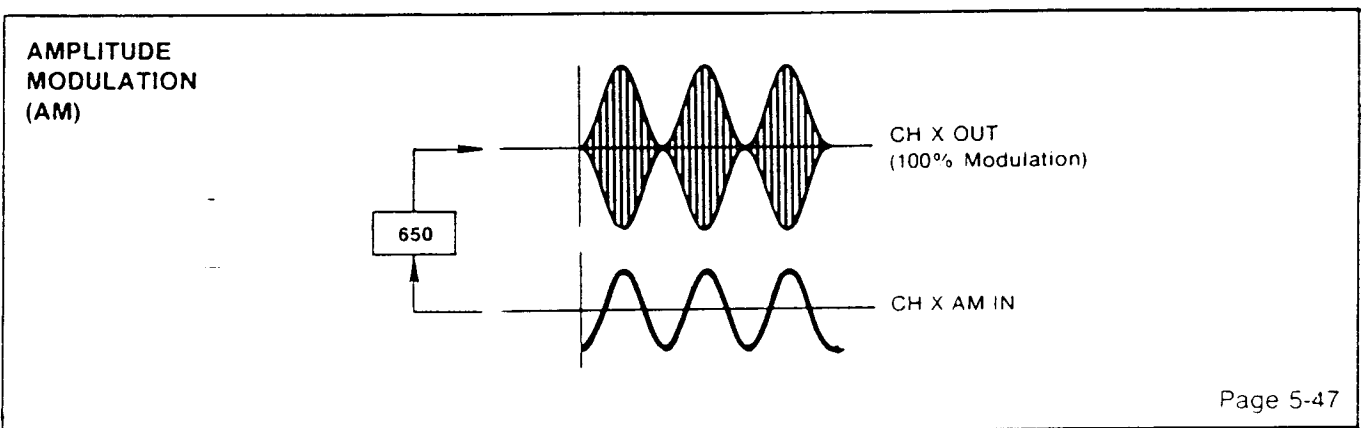
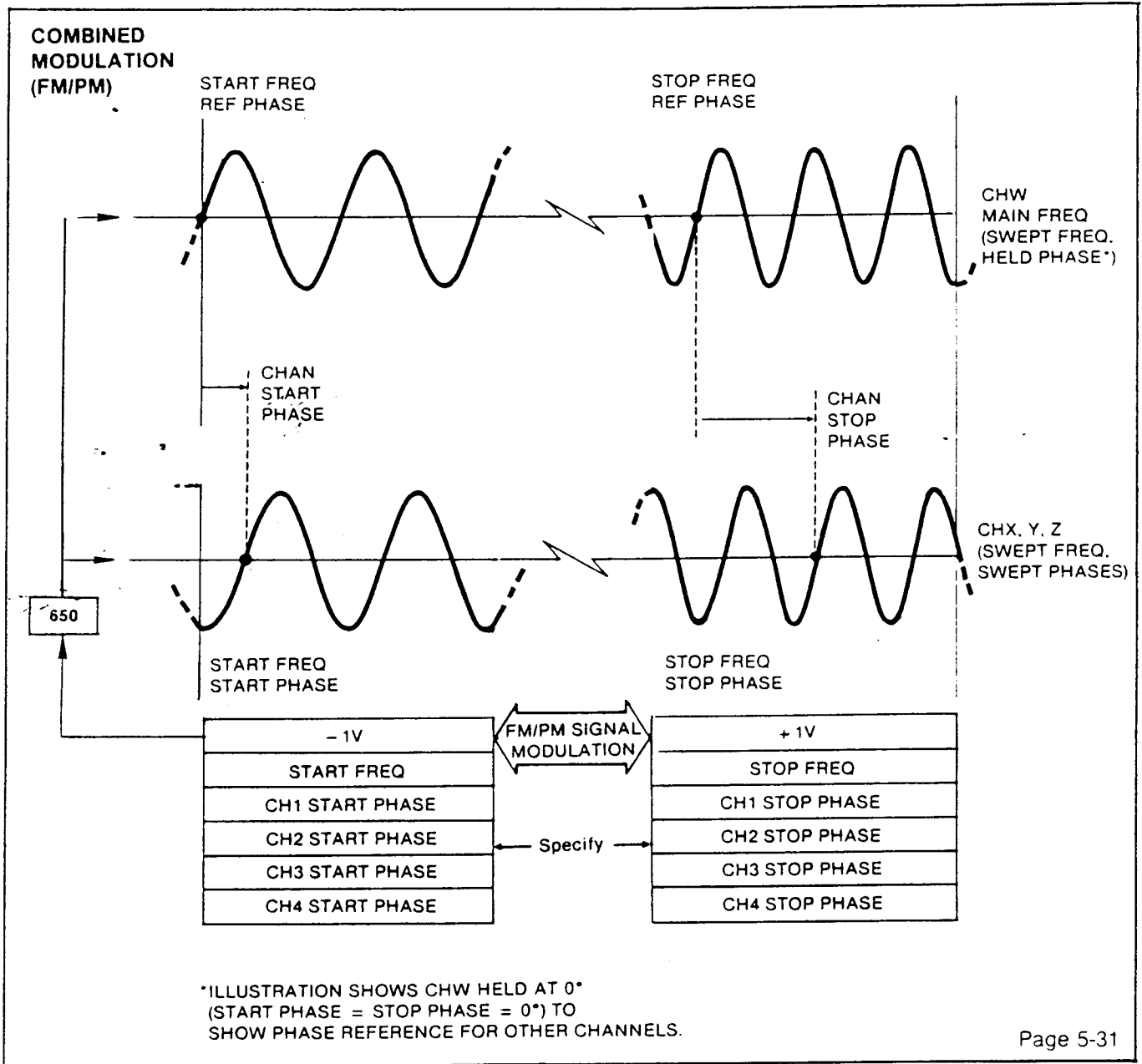

SYNCHRONOUS FREQUENCY SHIFT KEYING (S-FSK)

Select
Low freq
High freq

Page 5-26

ASYNCHRONOUS FREQUENCY SHIFT KEYING (A-FSK)

Select
Low freq
High freq

Page 5-26

ASYNCHRONOUS MULTIPLE FREQUENCY SHIFT KEYING

Sweep Mode 9 (Extr-Seq)

Select
Up to 99 frequencies in any order.

TRIGGER (POS OR NEG)

Page 5-29

ASYNCHRONOUS MULTIPLE PHASE SHIFT KEYING

Sweep Mode 19 (Extr-Seq)

Select
Up to 99 phases in any order.

TRIGGER (POS OR NEG)

Page 5-29

SCREEN SWEEP MONITOR

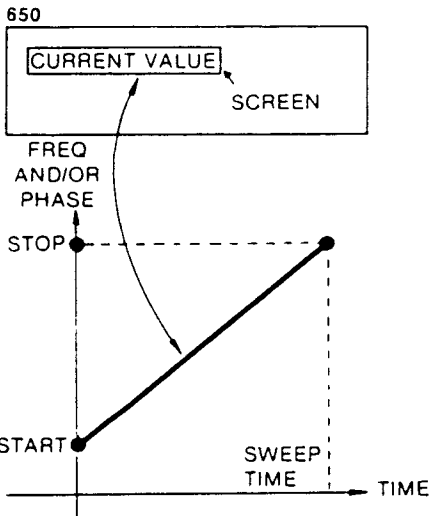

Specify
Monitor freq or phase.
If phase, specify channel.

SWEEP MARKER

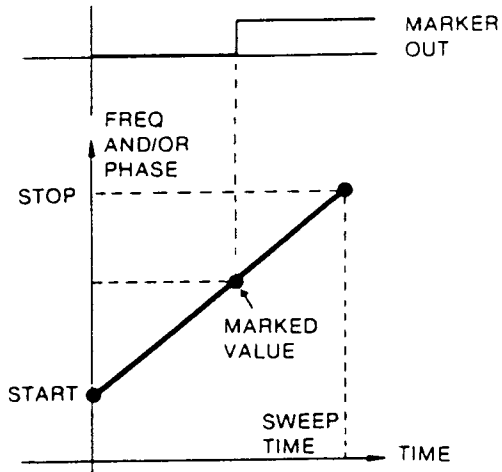

SWEEP	SPECIFY
Freq	Marker freq
Phase	Marker phase
Both	Marker freq

SWEEP HORIZONTAL OUT

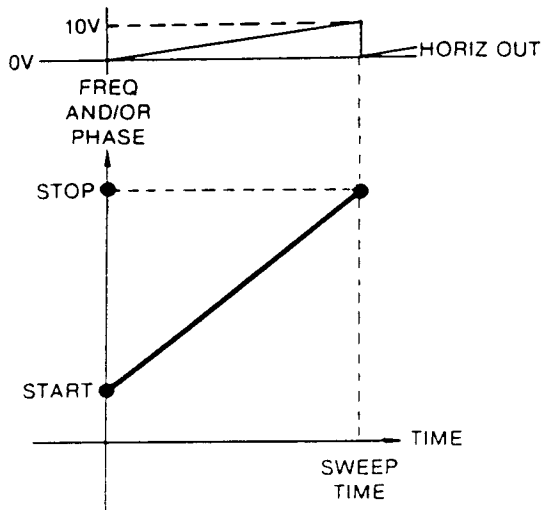

SECTION 4

OPERATION REFERENCE

4.1 INTRODUCTION

This section summarizes 650 operation. New operators should review this material to get an overview of

operation. Experienced operators should use it as a quick reference guide.

Contents	Function	Page
4.2 Front Panel	Locates and describes the front panel controls.	4-2
4.3 Rear Panel	Locates, describes, and electrically specifies the rear panel connectors and switches.	4-4
4.4 Operating Principles	Shows how the 650 produces coherent waveforms and how the primary menus relate to the production method.	4-6
4.5 Menu Keys	Shows the menu trees called by the menu keys, describes the soft keys in the menus, and provides general operating information.	4-8
4.6 Function Keys	Describes the function and operation of the non-menu keys.	4-16
4.7 Programming Charts (Examples)	Gives keystroke-by-keystroke examples that set up the six basic operating modes.	4-20

4.2 FRONT PANEL

This part briefly describes the functions of the menu keys, the function keys, the soft keys, the numeric keypad, and the cursor controls.

Menu Keys. Each menu key calls to the screen a single menu or the first menu in a tree of menus. See section 4.5 for the full structure of each menu tree. The text indicates menu key names with reversed type.

The **Main** menu tree (10 soft keys) determines the main frequency and the main operating mode (continuous, triggered, gated, burst, phase lock).

The **Channel** menu tree (17 soft keys, one tree per channel) controls each channel's waveform, amplitude, offset, phase delay, and output impedance.

The **Trigger** menu tree (6 soft keys) sets the internal trigger frequency and the voltage level and slope response to an external trigger signal.

The **Sweep** menu tree (79 soft keys) selects the mode and establishes limits, time, and monitoring for the 29 modes of frequency and phase sweeping.

The **Utility** menu tree (47 soft keys) controls display readability, back-lighting, beep tone, master/slave synchronization, calibration, self-test, and the function of the **Hold Input** connector.

The **GPIB** menu tree (6 soft keys) sets the GPIB address, displays the GPIB buffers and command set, generates service requests, and returns control to local operation.

The **Stored Settings** menu tree (4 soft keys) stores/recalls 25 instrument setups to eliminate manual reprogramming of frequently used setups.

The **Reset** menu tree (2 soft keys) resets the 650 to the power-up condition or restores the output after an overload disconnect.

Function Keys. Function keys perform when you press them; they do not call menus to the screen. See section 4.6 for a full description of each key's action. The text indicates function key names with reversed type.

The **Channel Number** function key selects a particular channel menu tree for programming. Press **Channel Number**, then the digit of the channel.

The **Manual Trigger** function key triggers or gates the 650 from the front panel.

The **Hold/Resume** function key holds sweeps from the front panel.

The **Quick Calibrate** function key calibrates the 650 for the current instrument settings. This calibration takes less than 5 seconds.

The **Exponent** key allows the exponential entry of large numeric values. For example, you can enter one million as 1000000 or as 1E6.

$$1E6 = 1E(\text{exponent})6 = 1 \times 10^6$$

The **Clear** key erases unexecuted numbers (see the **Clear** key description in section 4.6).

The **Execute** key tells the 650 to accept and use the just-keyed number and all pending parameters (see the **Execute** key description in section 4.6).

Soft Keys. The "soft" keys (F1 through F6) have changing functions determined by labels displayed in the current menu directly above the keys. The text indicates soft key names with all capital letters. Pressing a soft key either selects the current function or calls a new menu with a new set of functions. The menus display non-active functions in lower case and active functions in upper case. Section 4.5 shows the menus and their calling sequences.

Numeric Keypad. The numeric keypad allows you to key in positive or negative numbers directly or in scientific notation, to erase incorrect numbers, and to execute (enter) numbers.

The **0-9** keys allow the entry of fixed numbers (such as 5 or 14689.32). To continuously vary a parameter (for example, from 5 to 100), use the cursor knob or arrows.

The **.** (decimal) key inserts the decimal point in fractional numbers (such as 147.62).

The **±** key changes the sign of a numeric entry.

Cursor Controls. The cursor knob and direction arrows can vary parameter values continuously and step through numbered menu choices (called modes of operation). Both actions take effect (require no execution) as you make them.

Typical Operation. First, press a hard key, such as **Main**, to call the MAIN menu. Second, press a soft key (such as **FREQ**) to select a parameter from the menu. Third, enter a number (such as 1000) with the number keys. Finally, press **Execute** to make the 650 start generating a 1000 Hz main frequency. Optional: Rotate the cursor knob to dynamically vary the main frequency.

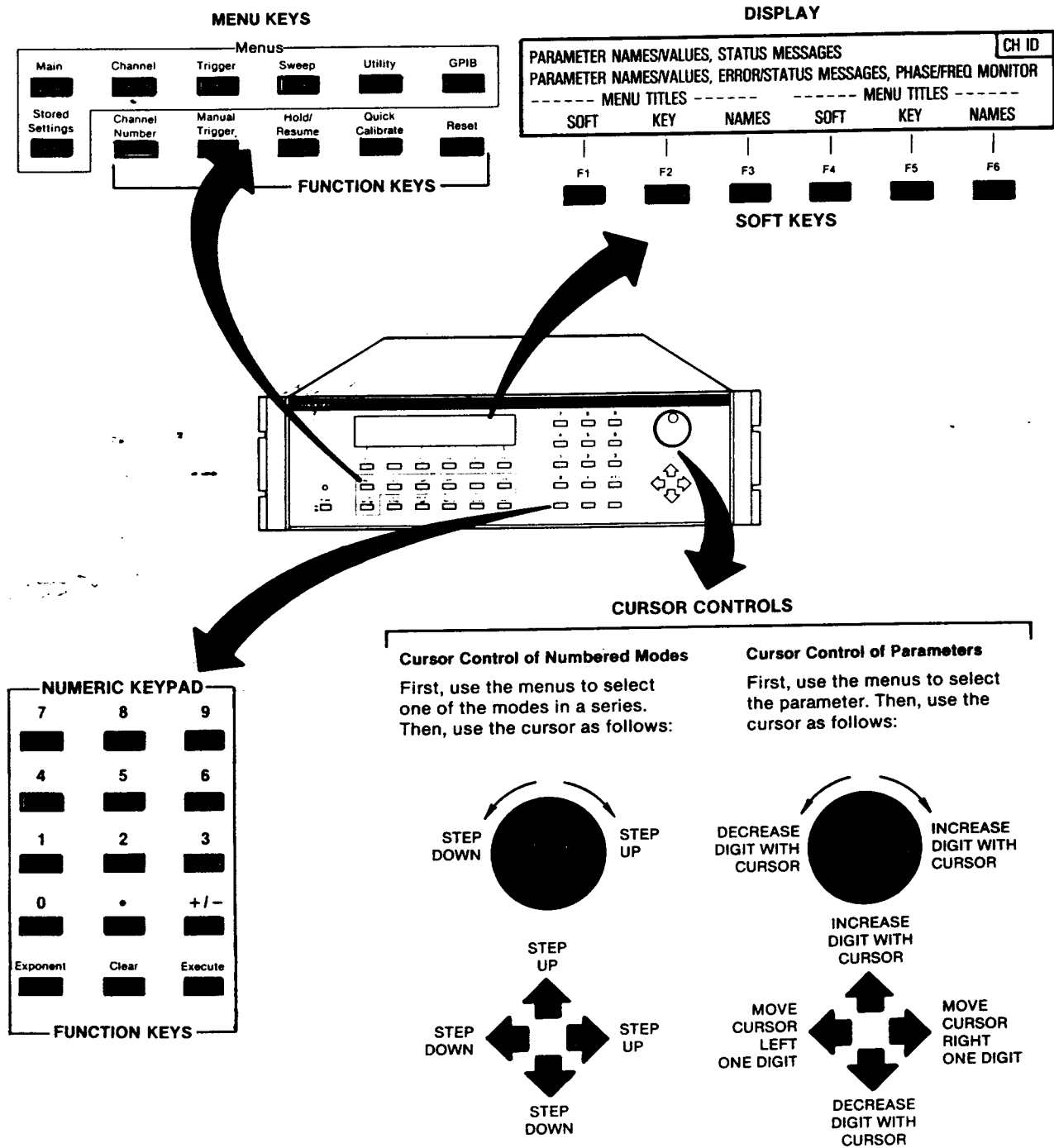

Figure 4-1. 650 Front Panel

4.3 REAR PANEL

This part describes the functions of, lists the

specifications for, and points to more information about the rear panel connectors.

Table 4-1. Connector Electrical Specifications

Label	Type	Voltage Limits	Impedance	Protection	Other Specifications
AM In	Input	0V to $\pm 5V$	$>10k\Omega$	$\pm 50Vdc$ momentary	
FM/PM In	Input	$-1V$ to $+1V$ full range	$>1M\Omega$	$\pm 50Vdc$	
Func Out	Output	$-25V$ to $+25V$	0Ω or 50Ω	$\pm 60Vdc$ 500 mA max	Current limit: 500mA
Hold Input	Input	TTL $<0.4V$, $>2.4V$	$1k\Omega$	$\pm 20Vdc$ momentary	TTL low applies hold
Horiz Out	Output	0V to $+10Vdc$	$1k\Omega$	$\pm 50Vdc$ momentary	Accuracy: 2% Resolution: 40mV
Marker Out	Output	TTL into 50Ω $<0.4V$, $>2.4V$	50Ω source	$\pm 20Vdc$ momentary	Output low when freq/phase $<$ marker
Phase Cal In	Input	40Vp-p max	$>300\Omega$	$\pm 100Vdc$	No overload protection when calibrating
Phase Clear	Bi-dir	TTL $<0.4V$, $>2.4V$	$<50\Omega$	None	Used in master/slave operation only
Phase Sync	Bi-dir	TTL $<0.4V$, $>2.4V$	$<50\Omega$	None	Used in master/slave operation only
Sync Out	Output	TTL into 50Ω $<0.4V$, $>2.4V$	50Ω source	$\pm 20Vdc$ momentary	In sync with zero crossing of channel signal
10 MHz Ref In	Input	$>500mVp-p$ $<50Vdc$	$>1k\Omega$, ac coupled	$\pm 50Vdc$ momentary	Input Freq: 10 MHz
10 MHz Ref Out	Output	TTL into 50Ω $<0.4V$, $>2.4V$	50Ω source	$\pm 5Vdc$ momentary	Output Freq: 10MHz $\pm 5ppm$ Fan Out: 10 units max
Trig In	Input	$>500mVp-p$ $<10Vdc$	$>5k\Omega$	$\pm 50Vdc$ momentary	Freq: 0 to $>200kHz$, 20 ns minimum
2.048V Out	Output	2.048V $\pm 5mV$	$1k\Omega$	$\pm 50Vdc$ momentary	

Table 4-2. Connector/Switch Functions and References

Label	Function	Page
AM In	Amplitude modulates the channel's output signal.	5-47
FM/PM In	a. Frequency modulates all channels. b. Phase modulates one selected channel. c. Simultaneously modulates frequency and phase of all channels.	5-31 5-31 5-31
Func Out	Supplies the main output signal of the channel.	5-7
Hold Input	a. Holds sweep. b. Holds waveform.	5-37 5-37
Horiz Out	Indicates % of elapsed sweep time.	3-17
IEEE-488	Accepts control commands from an external computer.	6-1
Marker Out	a. Changes level when sweep reaches a preset value. b. Supplies internal or external trigger signal.	5-20 5-16
Phase Cal In	Measures/corrects phase shift in external units/circuits.	7-16
Phase Clear	Synchronizes multiple units in master/slave operation.	7-13
Phase Sync	Synchronizes multiple units in master/slave operation.	7-13
Status Out	Applies to MATE interface (option 010).	—
Sync Out	Channel sync signal.	—
10 MHz Ref Out	Provides the master/slave frequency reference signal.	7-13
10 MHz Ref In	Accepts a local standard or the master/slave frequency reference signal.	7-13
Trig In	a. Triggers one cycle of output. b. Triggers a burst of output cycles. c. Gates the output on and off. d. Accepts frequency input in phase lock mode. e. Triggers sweep modes.	5-3 5-3 5-3 5-3 5-24.27
2.048V Out	Internal voltage reference output.	—
Address Selector	Determines GPIB address of instrument.	2-2
Time Meter	Applies to MATE interface (option 010).	—

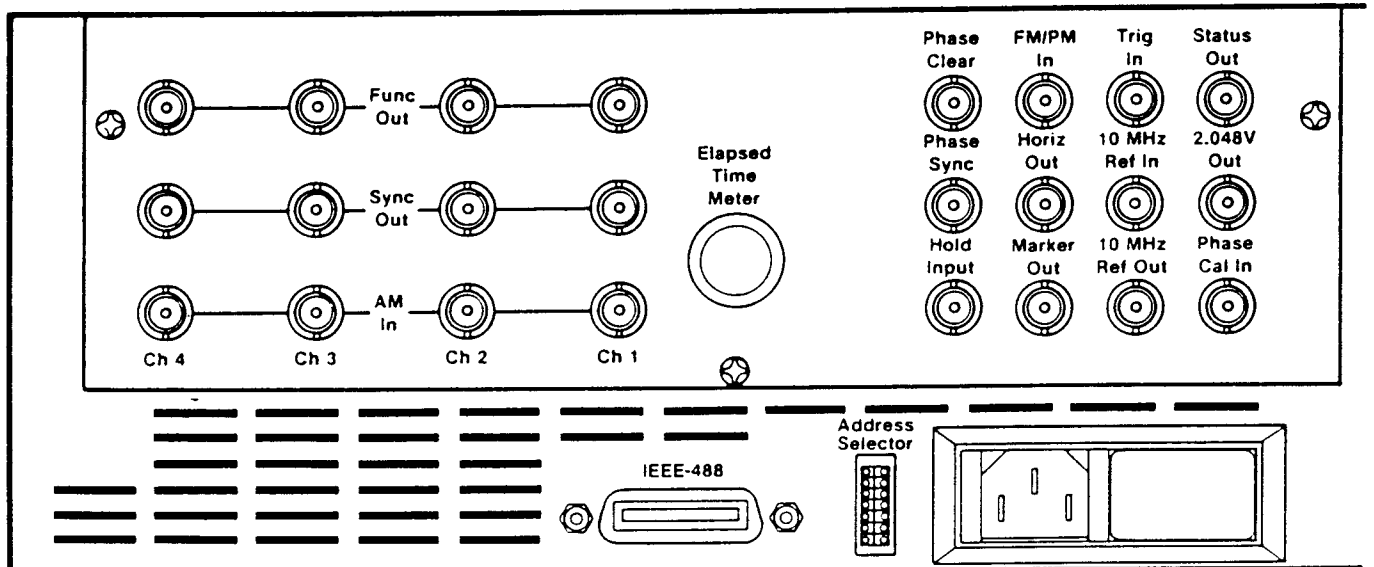

Figure 4-2. 650 Rear Panel

4.4 OPERATING PRINCIPLES

Basic Operating Principle. The 650 stores waveforms in RAM memory, then generates output signals by reading through the RAM addresses in order. The address-reading rate (10MHz) remains constant because the phase engine must, between readings, calculate and load the address register values for the next reading. Because the address-reading rate cannot change, the 650 produces frequency-swept and phase-swept waveforms by skipping intermediate addresses.

RAM Memory. For simplicity, figure 4-3 shows a sine wave stored as five points. In reality, the 650 stores the waveform as 8192 points. This resolution allows great latitude in skipping steps before the output signal suffers. Output resolution decreases only for extremely wide and fast sweeps.

Waveform Changes. To change a channel's output waveform, the 650 simply loads a new waveshape in the RAM. Each channel can produce a different waveform without affecting phase coherence between channels.

Equivalent Addresses. The "equivalent addresses" shown with the RAM make the example easy to follow. In actual operation, the phase engine loads the registers with adjusted values that produce real RAM addresses instead of the equivalent addresses shown.

DAC/Filter. The digital-to-analog converter converts the digital amplitude values emerging from the RAM into a stair-step waveform. The 2MHz output filter removes the 10MHz clock frequency and its harmonics to produce a smooth analog waveform.

Simple Examples. Follow the table for each example to see how the values loaded in the frequency and phase control registers produce the fixed frequency, swept frequency, and swept phase outputs shown.

Swept Phase Illustration. The swept phase illustration shows three snapshots in the leftward progression of a sine wave. The wave begins in the position shown in the top figure. The middle figure shows it after it jumps 90° to the left, and the bottom one shows it after another jump 90° to the left. In actual operation, these large jumps would consist of thousands of very small jumps that would produce a smooth sweep.

Realistic Example. The phase engine actually loads a phase value (such as 0.9°) into the frequency control register. The phase value accumulates in the summing register at the fixed clock rate (10MHz for the 650). This phase accumulation controls addressing of the RAM memory and therefore the frequency of the waveform. To see more realistically how this phase accumulator technique works, assume a phase value of 0.9° and a clock rate of 10MHz:

$$\frac{0.9^\circ}{\text{step}} \times \frac{10 \times 10^6 \text{ steps}}{1 \text{ second}} \times \frac{1 \text{ cycle}}{360^\circ} = \frac{9 \times 10^6 \text{ cycles}}{360 \text{ seconds}} = 25 \text{ kHz output}$$

$$\frac{360^\circ}{\text{cycle}} \times \frac{1 \text{ step}}{0.9^\circ} = 400 \text{ discrete steps in each cycle of a 25 kHz output.}$$

Next, assume a phase value of 9° and a clock rate of 10MHz:

$$\frac{9^\circ}{\text{step}} \times \frac{10 \times 10^6 \text{ steps}}{1 \text{ second}} \times \frac{1 \text{ cycle}}{360^\circ} = \frac{90 \times 10^6 \text{ cycles}}{360 \text{ seconds}} = 250 \text{ kHz output}$$

$$\frac{360^\circ}{\text{cycle}} \times \frac{1 \text{ step}}{9^\circ} = 40 \text{ discrete steps in each cycle of a 250 kHz output}$$

Main Menu. When you enter a frequency in the main menu, the 650 loads the non-changing phase value that will produce that fixed frequency into the frequency control register.

Sweep Menu. When you enter START and STOP frequencies in the sweep menu, the 650 converts these into the incrementing series of phase values that it loads successively into the frequency control register as the sweep progresses. All channels sweep frequency simultaneously. Similarly, when you enter different START and STOP phases for each channel in the sweep menu, the 650 converts these into a separate series of incrementing values for each channel, then loads these series successively into the phase control registers of the channels as the sweeps progress. Each channel sweeps phase independently.

Channel Menu. When you use the channel menu to select a waveform for a channel, the 650 loads that waveform into the channel's RAM. Similarly, when you enter an amplitude and voltage offset for the waveform, the 650 loads these values into the channel's amplitude and offset circuits. Finally, when you enter a fixed phase shift for a channel, the 650 loads the value that will produce that shift into the channel's phase control register.

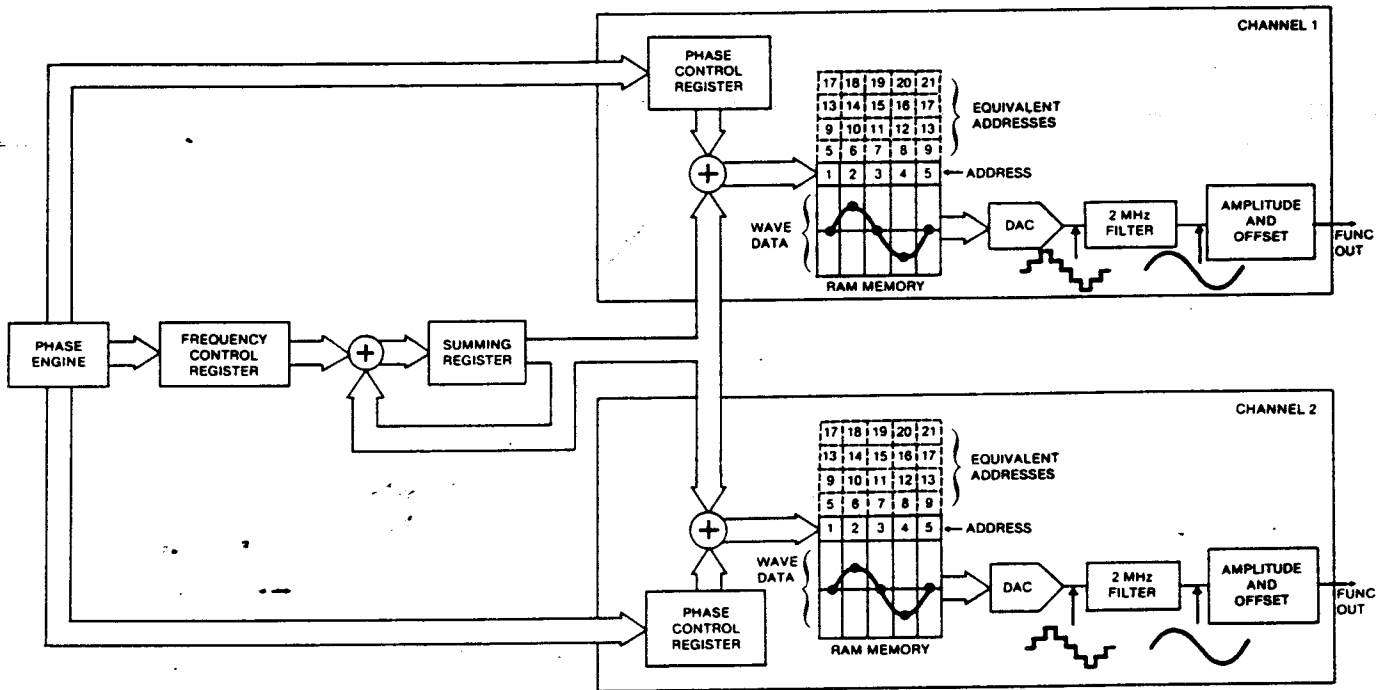

FIXED FREQUENCY, FIXED PHASE EXAMPLE

Freq Ctrl Reg		Sum Register			Phase Ctrl Reg	RAM ADR		Time
		Old	New					
1	+	0	= 1	+	1	= 2	at	T1
1	+	1	= 2	+	1	= 3	at	T2
1	+	2	= 3	+	1	= 4	at	T3
1	+	3	= 4	+	1	= 5	at	T4
1	+	4	= 5	+	1	= 6	at	T5
1	+	5	= 6	+	1	= 7	at	T6

↑ Fixed Frequency ↑ Fixed Phase (90°)

FIXED FREQUENCY

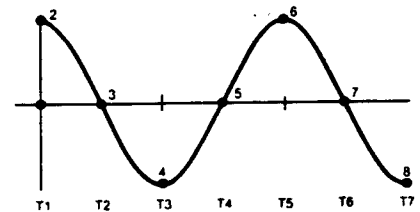

SWEPT FREQUENCY, FIXED PHASE EXAMPLE

Freq Ctrl Reg		Sum Register			Phase Ctrl Reg	RAM ADR		Time
		Old	New					
1	+	0	= 1	+	0	= 1	at	T1
2	+	1	= 3	+	0	= 3	at	T2
3	+	3	= 6	+	0	= 6	at	T3
4	+	6	= 10	+	0	= 10	at	T4
5	+	10	= 15	+	0	= 15	at	T5
6	+	15	= 21	+	0	= 21	at	T6

↑ Swept Frequency ↑ Fixed Phase (0°)

SWEPT FREQUENCY

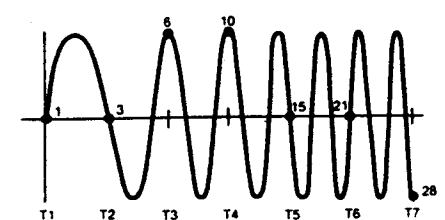

SWEPT PHASE, FIXED FREQUENCY EXAMPLE

Freq Ctrl Reg		Sum Register			Phase Ctrl Reg	RAM ADR		Time
		Old	New					
1	+	0	= 1	+	1	= 2	at	T1
1	+	1	= 2	+	2	= 4	at	T2
1	+	2	= 3	+	3	= 6	at	T3
1	+	3	= 4	+	4	= 8	at	T4
1	+	4	= 5	+	5	= 10	at	T5
1	+	5	= 6	+	6	= 12	at	T6

↑ Fixed Frequency ↑ Swept Phase

SWEPT PHASE

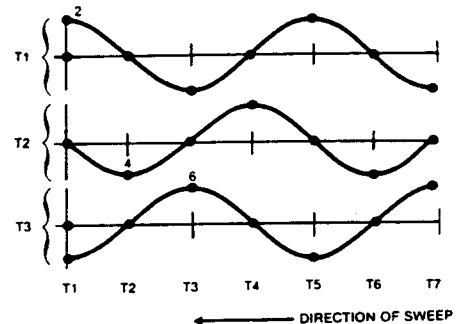
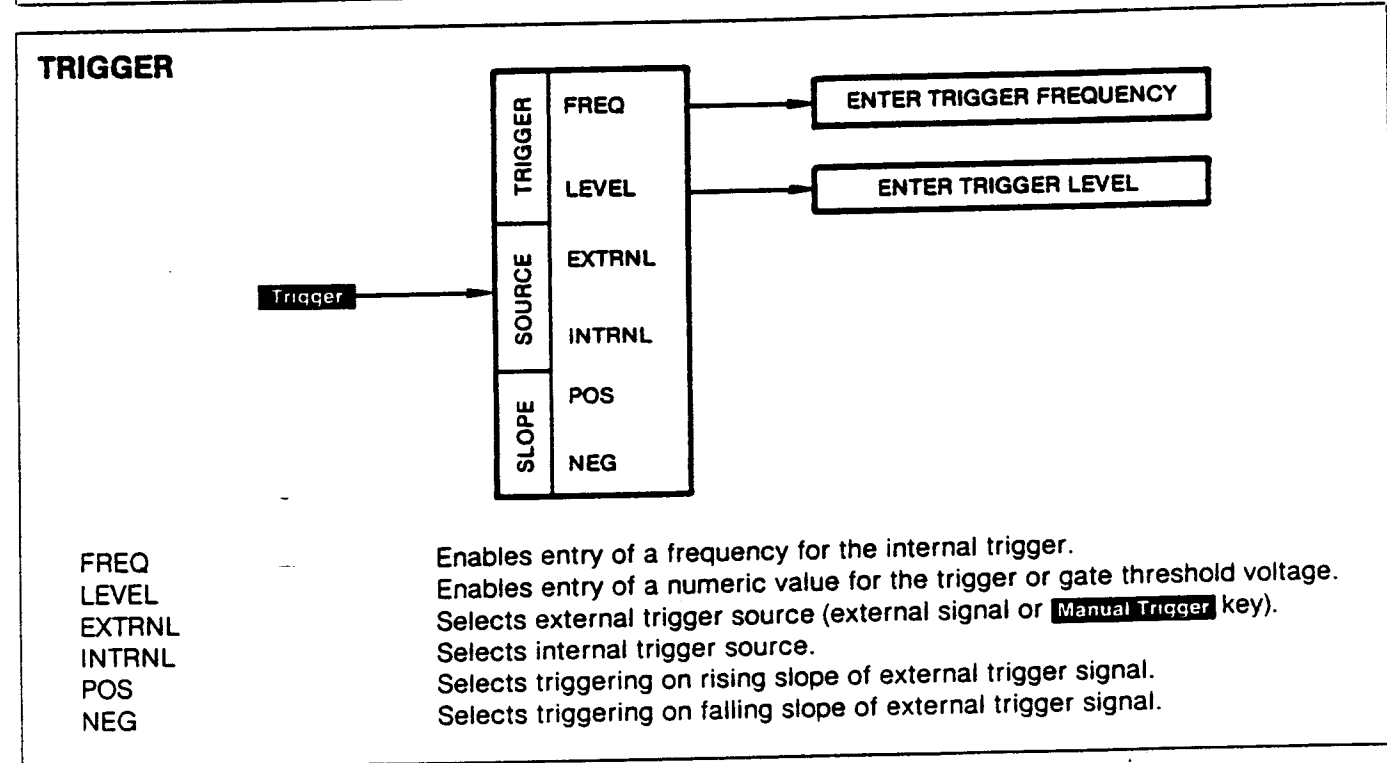
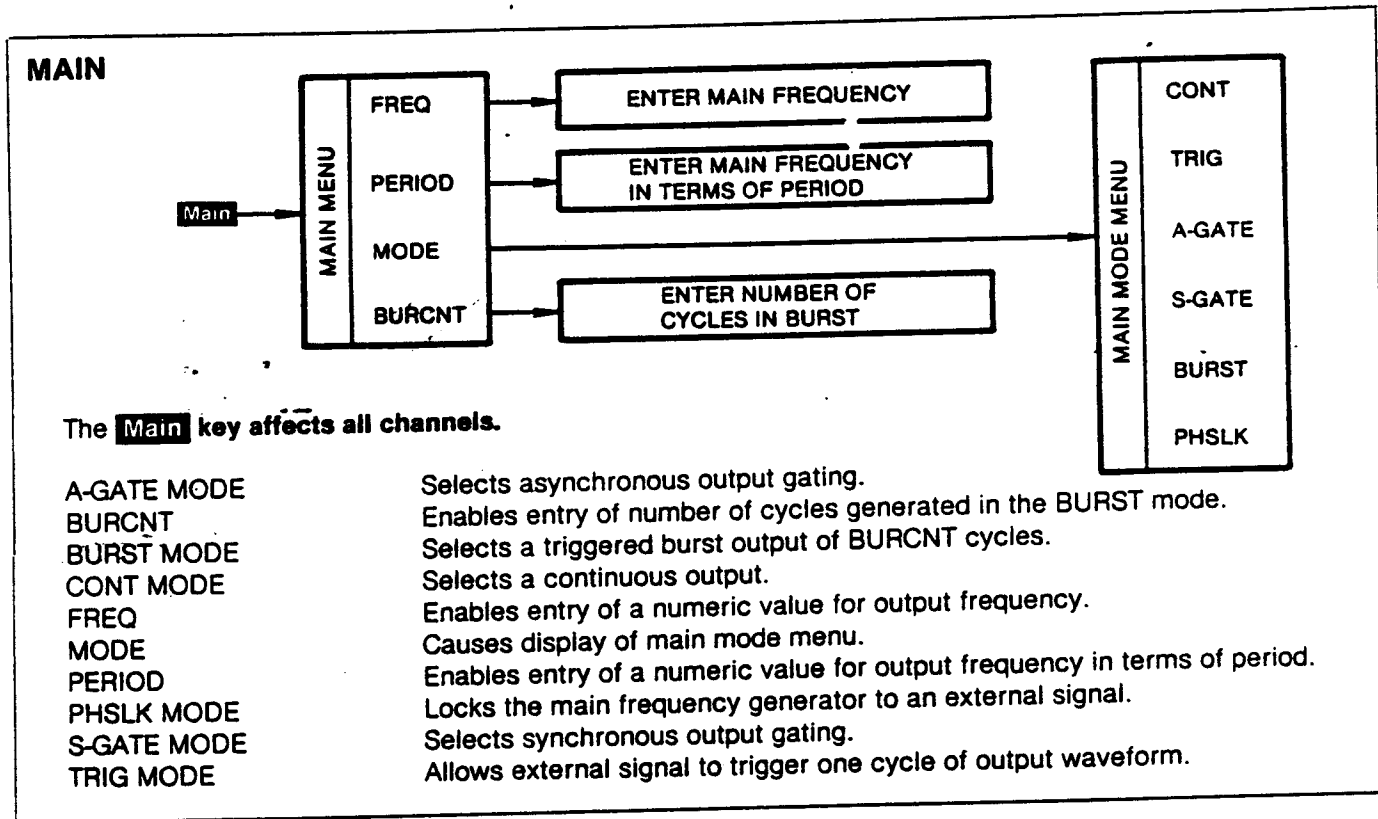

Figure 4-3. How the 650 Generates Phase-Coherent Waveforms

4.5 MENU KEYS

The 650 has eight menu keys. Each of these keys calls to the screen a single menu or the first menu in a tree

of menus. The following diagrams show the structure and define the terms of each of the menu trees. The diagrams appear in this order: **Main**, **Trigger**, **Channel**, **Sweep**, **Utility**, **GPIO**, **Stored Settings**, **Reset**.



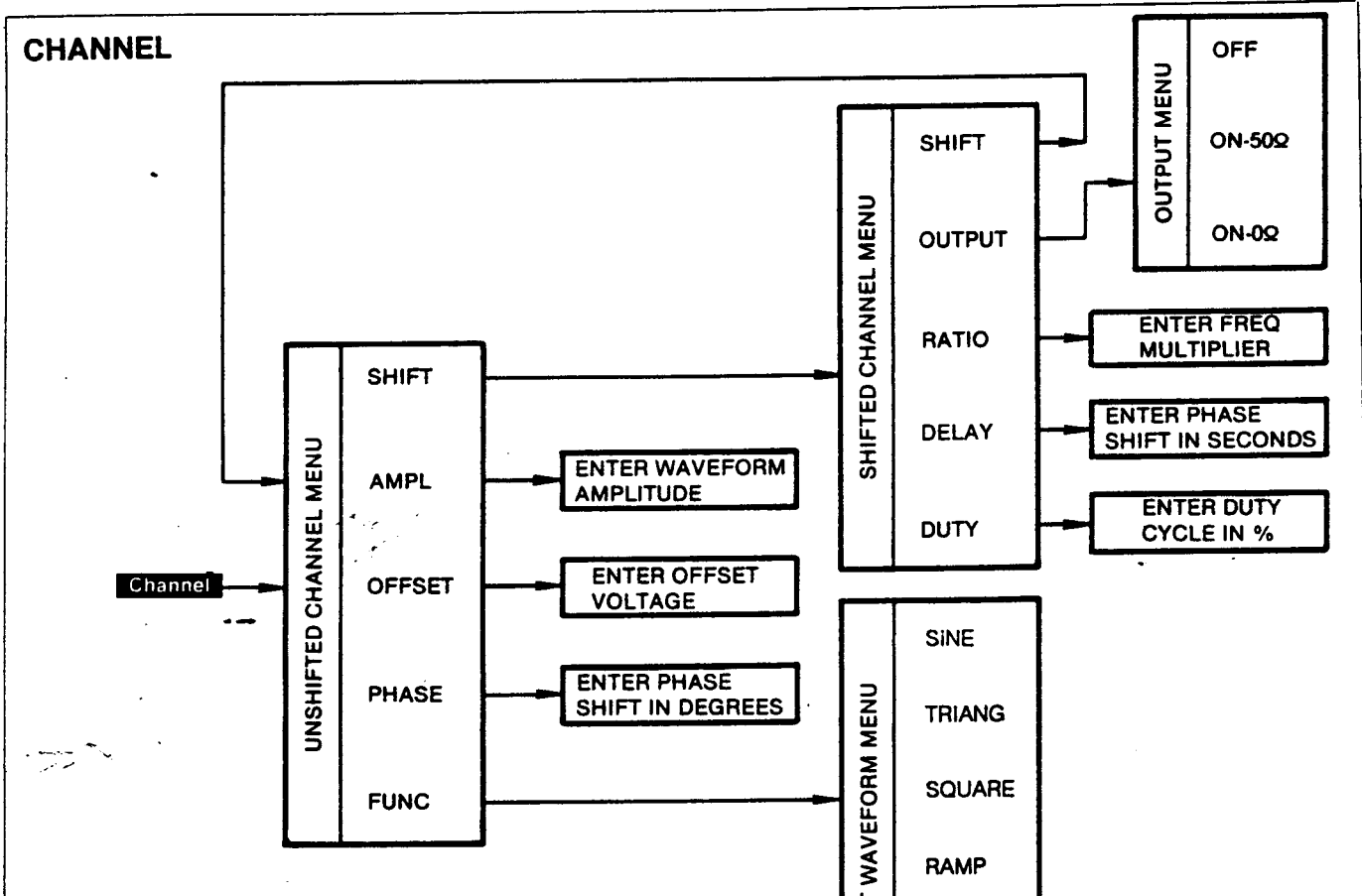

The **Channel** key controls the channel selected by the **Channel Number** key.

- AMPL Enables entry of a numeric value for amplitude in volts peak-to-peak. AMPL displays value in volts p-p and rms.
- DC Selects DC as the output waveform (voltage determined by OFFSET).
- DELAY Enables entry of a numeric value in seconds for waveform phase shift.
- DUTY Enables entry of a numeric value (in percent) for the duty cycle of square or ramp waveforms.
- FUNC (MENU) Causes display of the output waveform menu.
- OFF Opens the channel output relays.
- OFFSET Enables entry of numeric dc offset for the selected waveform.
- ON-0Ω Selects 0 ohm output impedance.
- ON-50Ω Selects 50 ohm output impedance.
- OUTPUT (MENU) Causes display of the output menu.
- PHASE Enables entry of a numeric value in degrees for the phase shift of the output.
- RAMP Selects ramp output waveform (DUTY determines duty cycle).
- RATIO Enables entry of a numeric integer from 1 to 99 that sets the frequency of the channel to a multiple of the MAIN frequency.
- SHIFT Selects the four active soft keys of the eight soft keys displayed in the menu.
- SINE Selects the sinusoidal output waveform.
- SQUARE Selects the square output waveform (DUTY determines duty cycle).
- TEST Produces a square wave of 4096 X the programmed frequency.
- TRIANG Selects the triangle output waveform.

SWEEP

HOW TO SET UP A SWEEP

- 1) Select a sweep mode from the List of Sweep Modes (below).
- 2) Find the mode's column in the Sweep Mode Parameters Chart (overleaf).
- 3) Read down the column to determine the parameters required by the mode.
- 4) Enter the parameters using the sweep menu tree for guidance.
- 5) Start the sweep by stepping through the menu tree to the sweep mode number.

LIST OF SWEEP MODES

Sweep Mode	—Mode Numbers—			Brief Description
	Freq	Phase	Both	
CONT-RESET	1	13	24	Continuous sweep with automatic reset.
CONT-REVERSE	2	14	—	Continuous sweep with automatic reverse.
TRIG-RESET	3	15	—	Triggered sweep with automatic reset.
TRIG-REVERSE	4	16	—	Triggered sweep with automatic reverse.
TRIG-HOLD-RESET	5	17	25	Triggered sweep/hold, triggered reset/hold.
TRIG-HOLD-REV	6	18	—	Triggered sweep/hold, triggered reverse/hold
SYNC-FSK	7	—	—	Frequency shifts on next zero crossing after trigger.
ASYNF-FSK	8	—	—	Frequency shifts immediately on trigger.
EXTR-SEQUENCE	9	19	26	Trigger causes jump to next step in sequence.
CONT-SEQUENCE	10	20	27	Continuous stepping through sequence.
TRIG-SEQUENCE	11	21	28	Trigger causes one pass through sequence.
EXTERNAL-FM	12	—	—	External signal frequency modulates output.
EXTERNAL-PM	—	23	—	External signal phase modulates output.
EXTERNAL-FM/PM	—	—	29	External signal frequency and phase modulates output.
DELTA-FREQ	—	22	—	Shifts frequency of one channel by DLTA-F.

FREQ modes sweep the frequency of all channels simultaneously.
 PHASE modes sweep the phase of one selected channel.
 BOTH modes sweep both frequency and phase of all channels.

SWEEP MENU TERMINOLOGY

- CENTER/SPAN** Enables entry of sweep limits in terms of CENTER/SPAN parameters.
- COMP** Selects compensation of amplitude and phase errors during sweep.
- DELTA** Shifts the output frequency of one channel by the amount DLTA-F.
- FUNC** Determines the sweep function: linear, log, random, sine.
- INDEX** Enables entry of a reference number for each phase or frequency step in a series of discrete phase or frequency steps.
- LIMIT** Enables entry of a number that specifies the highest index number programmed in a sequence of phase or frequency steps.
- LIMITS** Causes display of the sweep limits menu.
- MARKER** Enables entry of the phase or frequency value that will cause the **Marker Out** connector to change level.
- MODE** Causes display of the sweep mode menus. Each mode generates a specific sweep behavior. The 650 has 29 sweep modes (listed above).
- MONIT** Enables the display on-screen of the current value of the phase or frequency as a sweep progresses.
- START/STOP** Enables entry of the sweep limits in terms of START and STOP parameters (START can exceed STOP in value).
- TIME** Enables entry of a numeric value for sweep time for the continuous and triggered sweep modes. Determines, with LIMIT, the time per step in sequenced modes.

SWEEP

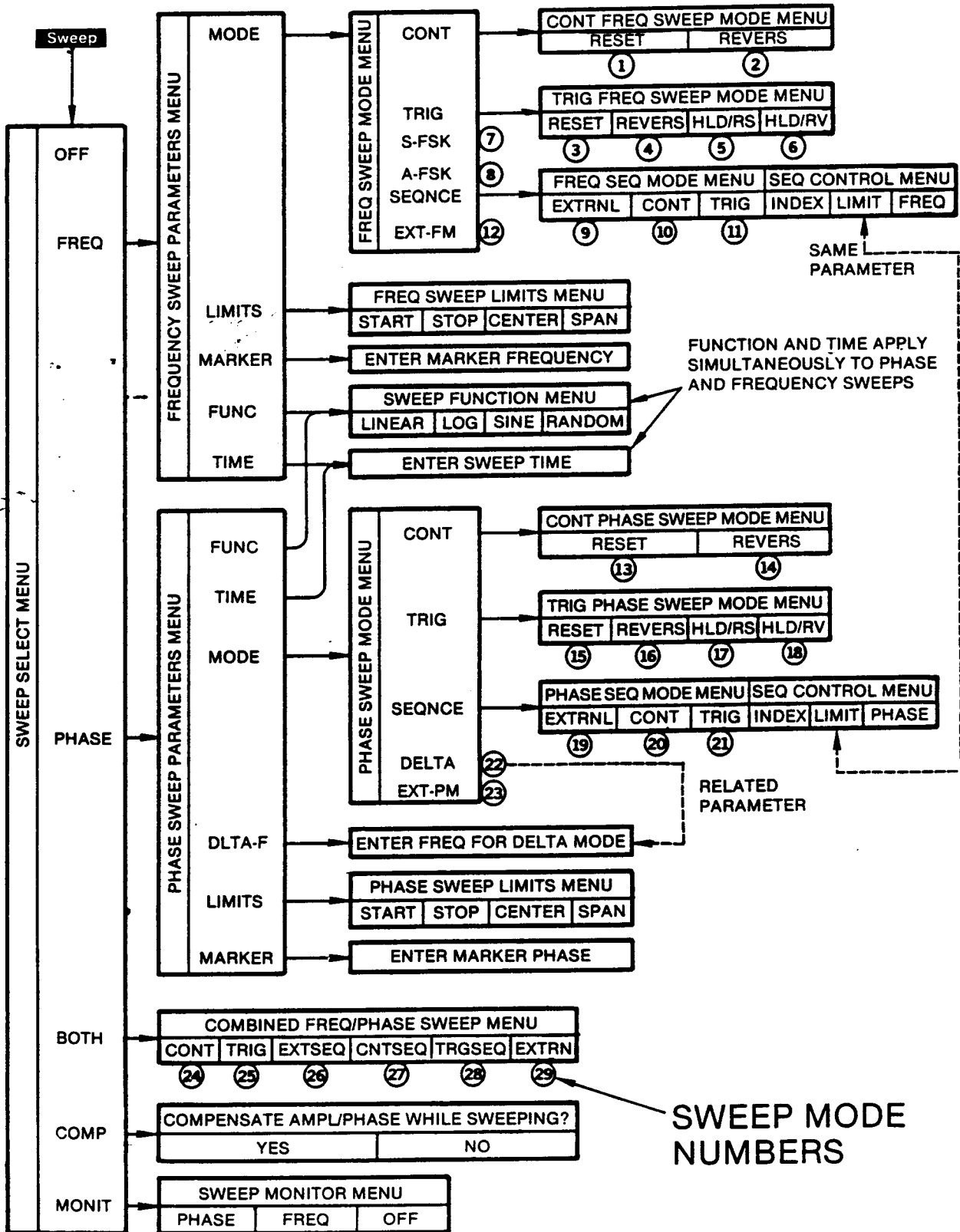

SWEEP**EXPLANATION OF THE SWEEP MODE PARAMETERS CHART**

Chart Function	1) Gives the parameters required to set up each sweep mode, and 2) Distinguishes between system and channel parameters.
Modes	Bullets (●) indicate each mode's required parameters. Deltas (Δ) indicate each mode's optional parameters.
Parameters	Each box represents one sweep mode parameter. Full-width-box parameters control all channels simultaneously. Narrow-width-box parameters control individual channels.
Example	The bullets in the column for modes 1-2 (CONT-F) tell you to enter a start frequency, a stop frequency, a sweep function, a sweep time, and optionally, a marker frequency and channel phases and delays.
FREQ Modes	ALL channels sweep frequency according to the active FREQ mode and the parameters entered for that mode in the system parameters table.
PHASE Modes	ONE channel (selected by the Channel Number key) sweeps phase according to the active PHASE mode and the parameters entered for that mode in the parameters table of the selected channel.
BOTH Modes	ALL channels simultaneously sweep frequency and ALL channels independently sweep phase according to the active BOTH mode. The frequency parameters entered in the system table define the frequency sweep, and the phase parameters entered in the separate channel tables define each channel's phase sweep. To hold the frequency fixed while sweeping phase in all channels, set both START FREQ and STOP FREQ to the desired frequency. To hold the phase fixed in a particular channel, set both START PHASE and STOP PHASE for the channel to the desired phase or, for sequenced modes, set each step of the sequence to the desired phase value.
Parameter	Keystrokes Required
Main Frequency	Main FREQ (Enter number)
Start Frequency	Sweep FREQ LIMITS START (Enter number)
Stop Frequency	Sweep FREQ LIMITS STOP (Enter number)
Sweep Function	Sweep FREQ/PHASE FUNC (Choose LINEAR, LOG, SINE, or RANDOM)
Sweep Time	Sweep FREQ/PHASE TIME (Enter number)
Index/Frequency	Sweep FREQ MODE SEQNCE INDEX/FREQ (Enter numbers)
Sequence Limit	Sweep FREQ/PHASE MODE SEQNCE LIMIT (Enter number)
Select Channel	Channel Number (Enter number)
Phase	Channel PHASE (Enter number)
Delay	Channel SHIFT DELAY (Enter number)
Start Phase	Sweep PHASE LIMITS START (Enter number)
Stop Phase	Sweep PHASE LIMITS STOP (Enter number)
Delta-F	Sweep PHASE DLTA-F (Enter number)
Index/Phase	Sweep PHASE MODE SEQNCE INDEX/PHASE (Enter numbers)
Frequency Modes	Sweep FREQ MODE (Choose mode)

SWEEP

SWEEP MODE PARAMETERS CHART

Modes															
Both				Phase				Freq							
EXT-FM/PM (29)	SEQB (26-28)	TRIG B (25)	CONT B (24)	EXT-PM (23)	DELTA (22)	SEQ-P (19-21)	TRIG-P (15-18)	CONT-P (13-14)	EXT-FM (12)	SEQ-F (9-11)	S/A-FSK (7-8)	TRIG-F (3-6)	CONT-F (1-2)	Parameters	
				●	●	●	●	●						Main Frequency	
●		●	●						●		●	●	●	Start Frequency	
●		●	●						●		●	●	●	Stop Frequency	
							●	●				●	●	Sweep Function	
	●	●	●			●	●	●		●		●	●	Sweep Time	
	●									●				Sequence Frequency Table	
	●					●				●				Sequence Limit	
Δ		Δ	Δ						Δ			Δ	Δ	Marker Frequency (Optional)	
● ¹	● ¹	● ¹	● ¹	● ²	● ²	● ²	● ²	● ²						Select Channel 1	Select Channel 2
				Δ ³	Δ ³	Δ ³	Δ ³	Δ ³	Δ	Δ		Δ	Δ	CH1 Phase (Optnl)	CH2 Phase (Optnl)
				Δ ³	Δ ³	Δ ³	Δ ³	Δ ³	Δ	Δ		Δ	Δ	CH1 Delay (Optnl)	CH2 Delay (Optnl)
●		●	●	●			●	●						CH1 Start Phase	CH2 Start Phase
●		●	●	●			●	●						CH1 Stop Phase	CH2 Stop Phase
					●									CH1 Dita-F	CH2 Dita-F
	●					●								CH1 Seq Phase Table	CH2 Seq Phase Table
				Δ ⁴	Δ ⁴	Δ ⁴	Δ ⁴							CH1 Phase Marker	CH2 Phase Marker
	● ⁵	●				● ⁵	●			● ⁵	●	●		← Trigger	
●				●					●					← Modulation Signal	

SYSTEM PARAMETERS TABLE

CHANNEL PARAMETERS TABLES

- Required parameter.
- Δ Optional parameter.
- ¹ Select and enter phase sweep parameters in all channels.
- ² Select and enter phase sweep parameters in one channel.
- Δ³ The channel selected to sweep phase will ignore PHASE and DELAY.
- Δ⁴ The channel selected to sweep phase will drive **Marker Out**.
- ⁵ All sequence modes except 10, 20, and 27 require triggering.

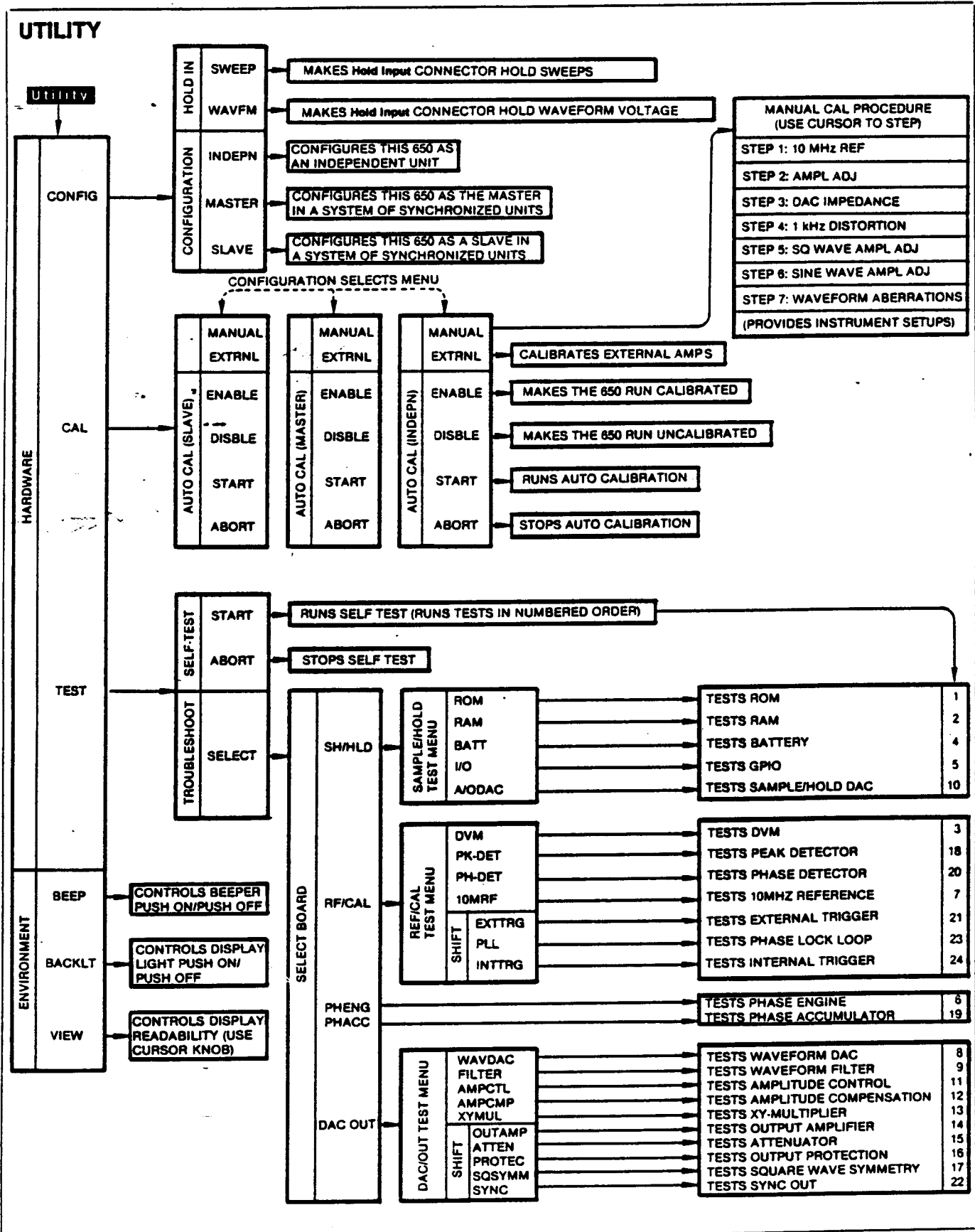

GPIB

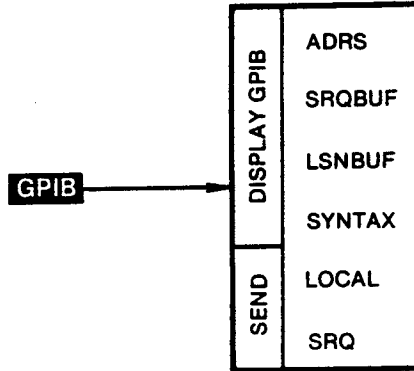

- ADRS Enables programming of GPIB instrument address from the front panel (power loss will cause reversion to rear-panel address).
- LOCAL Returns instrument control from GPIB bus to front panel.
- LSNBUF Causes scrolling display (use cursor knob) of all commands received.
- SRQ --Sends service request to instrument controller.
- SRQBUF Causes scrolling display (use cursor knob) of all SRQ messages generated by the 650.
- SYNTAX Displays complete list (use cursor knob) of all GPIB commands.

STORED SETTINGS

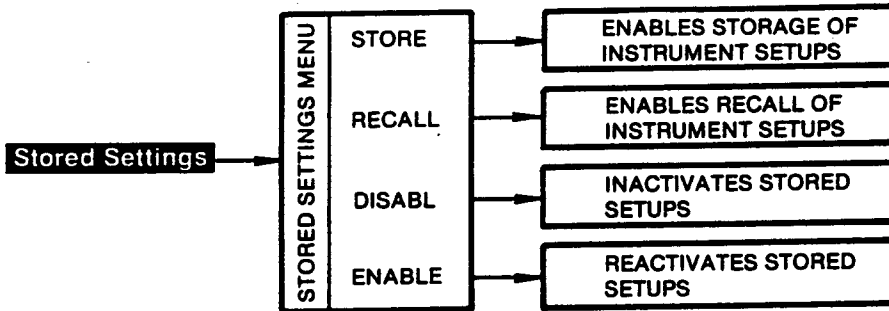

- STORE Enables storage of the current instrument setup in any one of the 25 setup storage locations.
- RECALL Enables recall of an instrument setup from any of the 25 storage locations and from the lost-power location.
- DISABL Enables inactivation of any storage location. Inactivation does not change the instrument setup stored in the location.
- ENABLE Enables reactivation of a storage location.

RESET

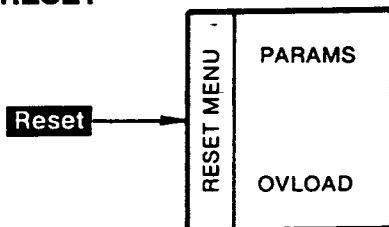

- PARAMS Resets all output parameters to power-up conditions.
- OVLOAD Closes any output relay opened by the overload detector.

4.6 FUNCTION KEYS

This section describes the function and keypad keys. Rather than calling menu trees, these keys perform

their functions when you press them. The key descriptions appear in front panel order.

Channel Number

Function: Selects one channel for programming or output generation.	
Operation: 1) Press Channel Number key. 2) Press channel digit (1, 2, 3, or 4). 3) Press Execute key or any other menu or soft key.	
Programming	Outputs
Select a channel before entering these parameters.	The channel you select will:
Channel Ampl Channel Offset Channel Phase Channel Func Channel Output Channel Ratio Channel Delay Channel Duty Sweep Phase Sequence Table Sweep Phase Dita-F Sweep Phase Limits Sweep Phase Marker	a) Display its channel number in the upper right corner of the screen. b) Sweep phase (if programmed to sweep in one of the phase sweep modes 13-23). c) Generate the signal for the Marker Out connector if programmed to sweep in one of the phase sweep modes 13-18 or 22-23. d) Display its phase offset or current phase on the screen if you have activated the phase monitor.

Manual Trigger

Function: Allows you to trigger or gate waveforms or sweeps from the front panel.
Operation: Set up the output you need, then press and release to generate a trigger, or press-hold-release to generate a gate.
Uses: Use the Manual Trigger key to: <ul style="list-style-type: none"> a) Trigger generation of one cycle of the main output frequency in the Main TRIG mode. b) Gate the main frequency generator on and off in the Main A-GATE and Main S-GATE modes. c) Trigger generation of BURCNT cycles of the main output frequency in the Main BURST mode. d) Trigger frequency sweeps in sweep modes 3-6. e) Trigger phase sweeps in sweep modes 15-18. f) Trigger both sweeps in sweep mode 25. g) Trigger each jump to the next step in frequency and/or phase in sequenced sweep modes 9, 19, and 26. h) Trigger one complete pass through the entire frequency and/or phase sequence in sequenced sweep modes 11, 21, and 28. i) Control the shift to the other frequency in FSK sweep modes 7 and 8.

Hold
Resume

Function: Allows you to hold frequency, phase, or both sweeps from the front panel.

Operation: Set up and start the the sweep. Press **Hold/Resume** to stop and hold the sweep at any intermediate value. Press again to resume the sweep.

Uses: Use the **Hold/Resume** key to:

- a) Hold frequency sweep modes 1-6.
- b) Hold phase sweep modes 13-18.
- c) Hold both sweep modes 24-25.

Quick
Calibrate

Function: Calibrates the current setup of the instrument to the highest possible accuracy.

Auto-Cal Method: Auto-Cal takes calibration readings at fixed frequencies between 0 to 2 MHz, then interpolates between them to arrive at continuous calibration curves for the instrument.

Quick-Cal Method: Quick-Cal calibrates the current setup of the instrument, rather than relying on interpolated values.

When: Use **Quick Calibrate** when you want to eliminate the errors caused by recent temperature changes and the possible minor errors caused by auto-calibration interpolation.

Exponent

Function: Allows you to enter numbers in scientific notation.

Scientific Notation: Scientific notation expresses a number in terms of its significant digits multiplied by ten to the appropriate power. For example, 23,340 Hertz converts to 2.334×10^4 .

Operation: The following keystrokes series show how to enter numbers into the 650 in scientific notation:

23,340 Hz:	Main FREQ 23340 Execute
	or Main FREQ 2.334 Exponent 4 Execute
Screen:	2.334E4
0.00004285 sec:	Main PERIOD .00004285 Execute
	or Main PERIOD 4.285 Exponent - 5 Execute
Screen:	4.285E-5

Clear

Function: Clears the currently displayed parameter from the screen and the pending registers.

Action: The action of **Clear** depends on the contents of the parameter's pending register and the state of the screen display. The following table uses **Main** **FREQ** to demonstrate **Clear** operation. **Execute** discusses active and pending registers.

A = active register, P = pending register, S = screen display.

Condition 1 Keystrokes: **Main** **FREQ** 1000 **Execute**.

Register Contents: A = 1000 P = Empty S = frequency: 1,000 Hz

Press **Clear**: A = 1000 P = Empty S = frequency: 1,000 Hz

Condition 2 Keystrokes: **Main** **FREQ** 1000 **Execute** **FREQ** 500.

Register Contents: A = 1000 P = Empty S = frequency: 500

Press **Clear**: A = 1000 P = Empty S = frequency: 1,000 Hz

Condition 3 Keystrokes: **Main** **FREQ** 1000 **Execute** **FREQ** 500 **FREQ**.

Register Contents: A = 1000 P = 500 S = frequency: 0,500 Hz
old: 1,000 Hz

Press **Clear**: A = 1000 P = Empty S = frequency: 1,000 Hz

Condition 4 Keystrokes: **Main** **FREQ** 1000 **Execute** **FREQ** 500 **FREQ** 100.

Register Contents: A = 1000 P = 500 S = frequency: 100

Press **Clear**: A = 1000 P = 500 S = frequency: 0,500 Hz
old: 1,000 Hz

Press **Clear** again A = 1000 P = Empty S = frequency: 1,000 Hz

Execute

Function: Controls parameter transfer into the active registers from the pending registers and the screen.

Parameter: Any numerical value, such as main frequency or channel amplitude.

Active Registers: Each parameter has a separate active register that contains the value currently controlling the output. For example, 1000 in the active main frequency register would make the main frequency generator run at 1000 Hz.

Pending Registers: Each parameter also has a pending register that contains a value for the parameter that will become active the next time you press the **Execute** key.

Screen: The screen display format of a parameter depends on the contents of the parameter's pending register. If the pending register contains no value, the screen will display the active value of the parameter. If the pending register contains a value, the screen will display both the pending value (frequency: 500 Hz) and the currently active value (old: 1,000 Hz). Both displays will disappear when you start keying in the new value for the parameter.

One-At-A-Time Loading: Press **Execute** immediately after keying in a new parameter value to load that new value directly into the parameter's active register.

Group Loading: Press any other menu key immediately after keying in a new parameter value to load that new value into the parameter's pending register. (For the other menu key, press the first keystroke in the series of keystrokes required to bring the next parameter to the screen.) After you finish loading your entire next setup into pending registers, press **Execute** to simultaneously transfer all the pending values into the active registers.

Automatic Execute. Selecting a mode of operation or a function will generate an automatic execute. For example, pressing **Main** MODE CONT, **Sweep** FREQ MODE CONT RESET, or **Channel** FUNC SINE will automatically transfer all your pending values into their active registers. This action follows the normal programming practice of first entering all of a mode's controlling parameters, then activating the mode.

Cursor Execute. The cursor controls automatically execute as they change the numerical value of a parameter or as they select new modes of operation.

4.7 PROGRAMMING CHARTS

Function. The programming charts provide step-by-step programming procedures for the six basic operating modes of the 650:

- Non-Sweep Operation
- Sweep Frequency
- Sweep Phase
- Sweep Frequency and Phase
- Sequence Frequency
- Sequence Phase

Major Components. Each programming chart has three parts: labeled chart, example, and GPIB example:

- The chart column gives the general keystrokes necessary to set up the mode and indicates where you must enter the numbers and choose the functions that will customize the output to suit your particular application.
- The example column gives every single keystroke necessary to generate a demonstration output signal. These keystrokes set up the mode, enter specific numbers, and choose specific functions.
- The GPIB example gives the programming commands necessary to produce the demonstration output.

Chart Uses. Use the programming charts for the following purposes:

- **For Training.** Connect an oscilloscope (see figure 4-4) and run through some of these charts to get familiar with machine operation. As you press keys, follow along in the appropriate menu trees (given in the menu keys overview section) to fix in your mind the tree structures. You will learn how the menus appear on the screen and gain a feeling for how the machine operates.
- **To Get the Big Picture.** Since these examples provide every single keystroke necessary to produce an output, they tie together all aspects of machine operation. To learn more about the functions of particular keystrokes, refer to the menu trees or to the detailed operation section.
- **Programming Check.** If you program a particular mode that won't work, refer to the appropriate chart to see if you left out any steps.

Chart Conventions. As you become more familiar with the 650, you will notice that the charts contain some redundant keystrokes that we included to fix in your mind the programming process. For example, **Reset** PARAMS just returns the 650 to a known starting point. **Execute** appears after every number in the chart because we want to put the numbers into effect immediately (read the **Execute** key description to see how to delay execution). Finally, we typically set up each channel parameter as follows: **Channel** AMPL 5 **Execute** **Channel** FUNC SINE. If a menu already displays the next parameter you need, you don't have to recall the menu: **Channel** AMPL 5 FUNC SINE.

The charts appear in the following order:

Paragraph	Chart
4.7.1	How to Use the Programming Charts
4.7.2	Non-Sweep Operation
4.7.3	Sweep Frequency Operation
4.7.4	Sweep Phase Operation
4.7.5	Combined Sweep (Frequency and Phase) Operation
4.7.6	Sequence Frequency Operation
4.7.7	Sequence Phase Operation

CAUTION

The 650 can generate enough power to damage the 5W feedthrough termination. Always keep the output signal levels within the power range of your load.

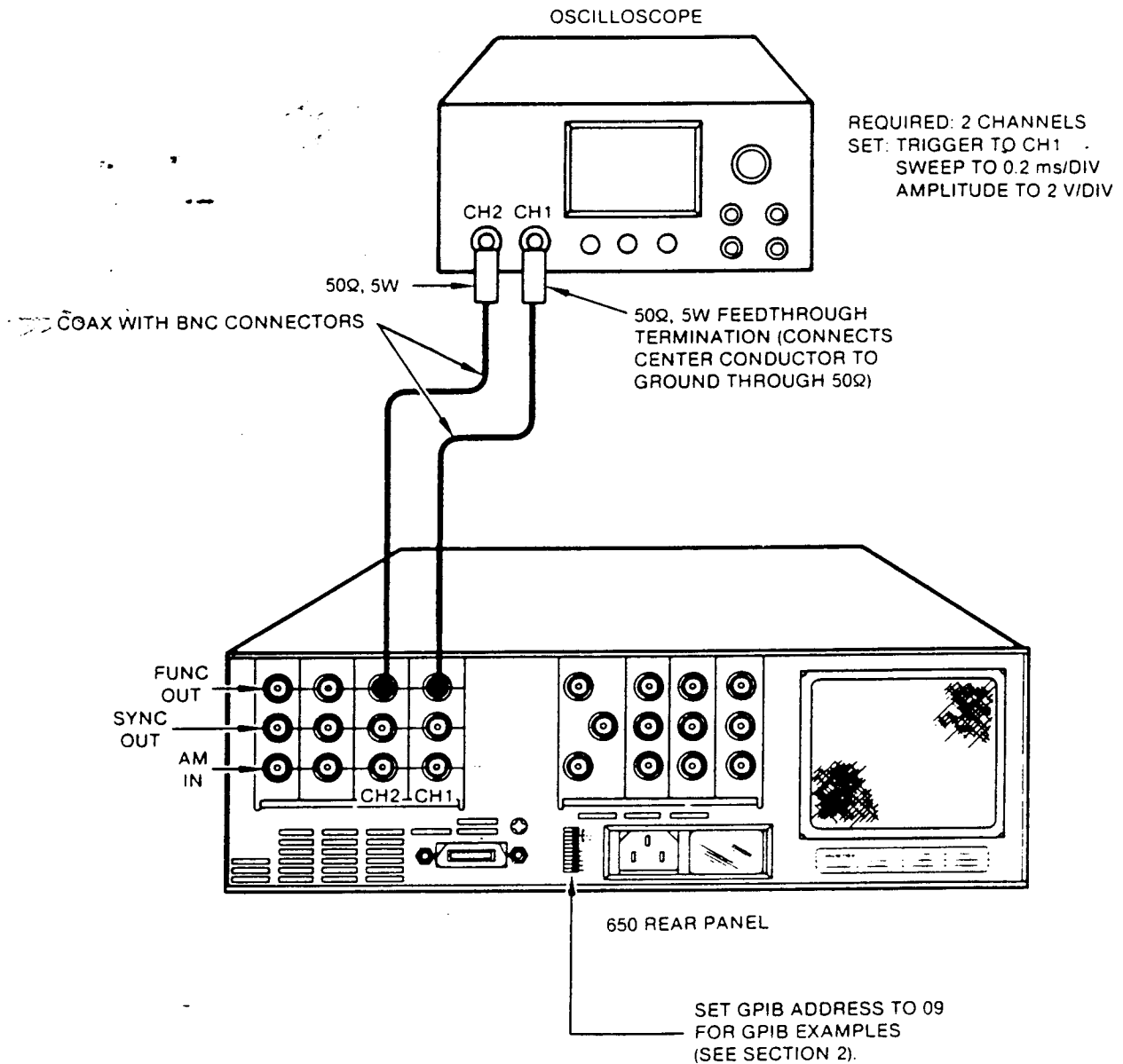
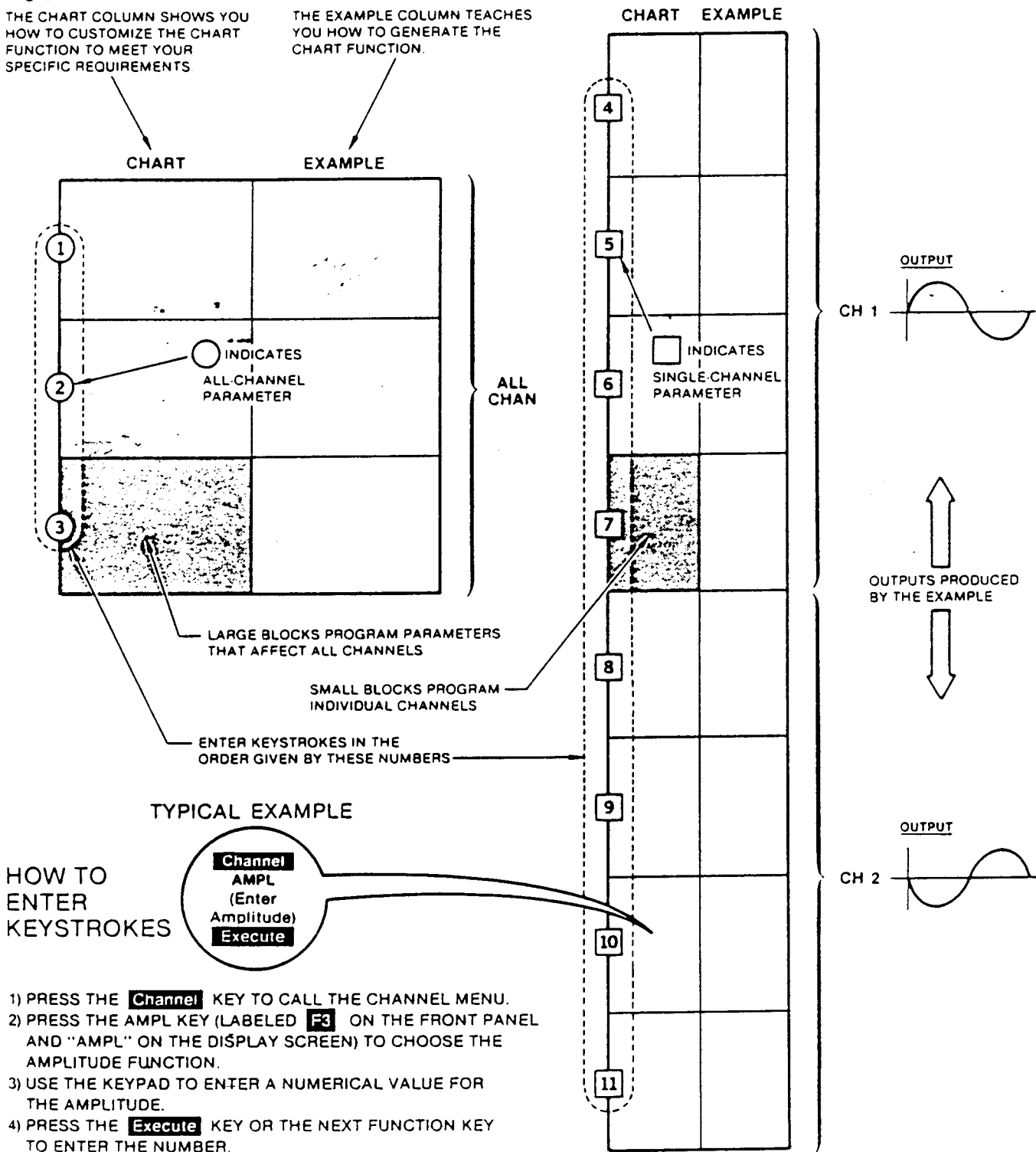

Figure 4-4. Oscilloscope Connection for Examples

4.7.1 How To Use The Programming Charts

This chart shows how to read and use the programming charts.



4.7.2 Non-Sweep Operation

This chart shows how to make the 650 produce phase-shifted non-sweeping outputs.

CHART	EXAMPLE	
1 Reset PARAMS	Reset PARAMS	} ALL CHAN
2 Main MODE (Choose mode)	Main MODE CONT	
3 Main FREQ (Enter frequency)	Main FREQ 1000 Execute	

GPIB EXAMPLE

```

STEP  COMMAND
1   RST 1
2   M 0
3   FR 1000
4   CH 1
5   OT 1
6   AM 5
7   FN 0
8   PH 0
9   CH 2
10  OT 1
11  AM 5
12  FN 0
13  PH 180

PROGRAM
WRITE@709:"RST 1 M 0 FR 1000 CH 1 OT 1
          AM 5 FN 0 PH 0 CH 2 EX"
    
```

SYMBOLS

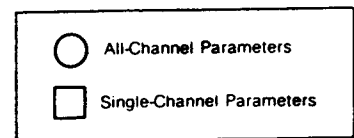
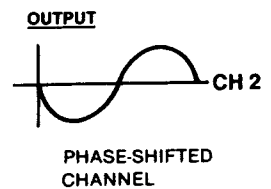
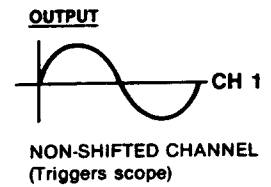

CHART	EXAMPLE	
4 Channel Number (Enter 1)	Channel Number Execute	} CH 1
5 Channel SHIFT OUTPUT (Choose output)	Channel SHIFT OUTPUT ON-500 (Look at scope)	
6 Channel AMPL (Enter amplitude)	Channel AMPL 5 Execute	
7 Channel FUNC (Choose function)	Channel FUNC SINE	
8 Channel PHASE (Enter phase shift)	Channel PHASE 0 Execute	

CHART	EXAMPLE	
9 Channel Number (Enter 2)	Channel Number 2 Execute	} CH 2
10 Channel SHIFT OUTPUT (Choose output)	Channel SHIFT OUTPUT ON-500 (Look at scope)	
11 Channel AMPL (Enter amplitude)	Channel AMPL 5 Execute	
12 Channel FUNC (Choose function)	Channel FUNC SINE	
13 Channel PHASE (Enter phase shift)	Channel PHASE 180 Execute (Look at scope)	



4.7.3 Sweep Frequency Operation

This chart shows how to make the 650 sweep frequency.

CHART	EXAMPLE
1 Reset PARAMS	Reset PARAMS
2 Main MODE CONT	Main MODE CONT
3 Sweep FREQ LIMITS (Enter START and STOP limits)	Sweep FREQ LIMITS START 1000 STOP 1 Exponent 4 Execute
4 Sweep FREQ TIME (Enter sweep time)	Sweep FREQ TIME 10 Execute
5 Sweep FREQ FUNC (Choose sweep function)	Sweep FREQ FUNC LINEAR
6 Sweep FREQ MODE (Choose sweep mode)	Sweep FREQ MODE CONT RESET

CHART	EXAMPLE
7 Channel Number (Enter 1)	Channel Number 1 Execute
8 Channel SHIFT OUTPUT (Choose output)	Channel SHIFT OUTPUT ON-500 (Look at scope)
9 Channel AMPL (Enter amplitude)	Channel AMPL 5 Execute
10 Channel FUNC (Choose function)	Channel FUNC SINE
11 Channel PHASE (Enter phase shift)	Channel PHASE 0 Execute

CHART	EXAMPLE
12 Channel Number (Enter 2)	Channel Number 2 Execute
13 Channel SHIFT OUTPUT (Choose output)	Channel SHIFT OUTPUT ON-500 (Look at scope)
14 Channel AMPL (Enter amplitude)	Channel AMPL 5 Execute
15 Channel FUNC (Choose function)	Channel FUNC SINE
16 Channel PHASE (Enter phase shift)	Channel PHASE 180 Execute (Look at scope)

ALL
CHAN

CH 1

CH 2

SYMBOLS

○	All-Channel Parameters
□	Single-Channel Parameters

GPIB EXAMPLE

STEP	COMMAND	STEP	COMMAND	STEP	COMMAND
1	RST 1	6	SMD 1	12	CH 2
2	M 0	7	CH 1	13	OT 1
3	STRTF 1E3 STOPF 1E4	8	OT 1	14	AM 5
4	STM 10	9	AM 5	15	FN 0
5	SFN 0	10	FN 0	16	PH 180
		11	PH 0		

PROGRAM

```
WRITE@709:"RST 1 M 0 STRTF 1E3 STOPF 1E4 STM 10 SFN 0 SMD 1 CH 1 OT 1
AM 5 FN 0 PH 0 CH 2 OT 1 AM 5 FN 0 PH 180 EX"
( Sets up 650 and selects sweep mode 1)
WRITE@709:"SMD 2 EX" (Selects sweep mode 2)
WRITE@709:"SMD 3 EX" (Selects sweep mode 3)
WRITE@709:"TRG EX" (Triggers sweep/auto-reset cycle)
WRITE@709:"SMD 4 EX" (Selects sweep mode 4)
WRITE@709:"TRG EX" (Triggers sweep/auto-reverse-sweep cycle)
WRITE@709:"SMD 5 EX" (Selects sweep mode 5)
WRITE@709:"TRG EX" (Triggers sweep)
WRITE@709:"TRG EX" (Triggers reset)
WRITE@709:"SMD 6 EX" (Selects sweep mode 6)
WRITE@709:"TRG EX" (Triggers sweep)
WRITE@709:"TRG EX" (Triggers reverse sweep)
```

CONTINUOUS MODE DEMONSTRATION

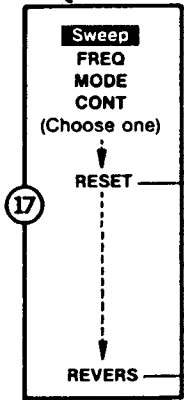

(Steps 17 and 18 change the mode you selected in step 6.)

OUTPUTS

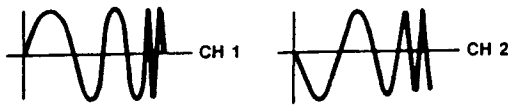

Steps 11 and 16 hold the frequency-sweeping waveforms 180° out of phase (CH1 = 0°, CH2 = 180°)

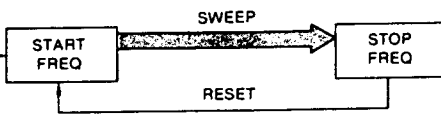

CONTINUOUS SWEEP WITH AUTO RESET (Mode 1)

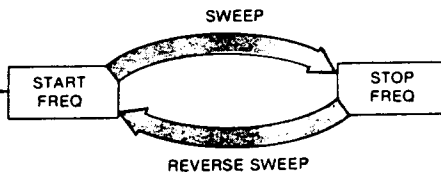

CONTINUOUS SWEEP WITH AUTO REVERSE (Mode 2)

TRIGGERED MODE DEMONSTRATION

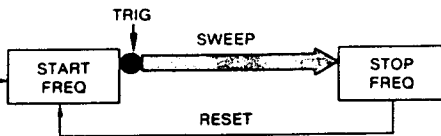
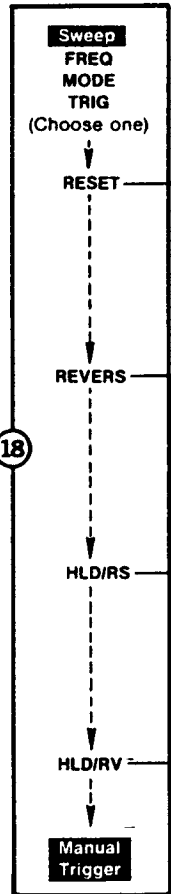

TRIGGERED SWEEP WITH AUTO RESET (Mode 3)

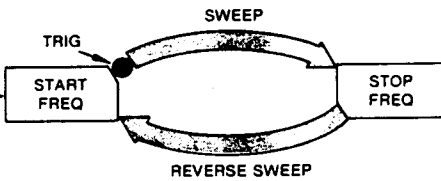

TRIGGERED SWEEP WITH AUTO REVERSE (Mode 4)

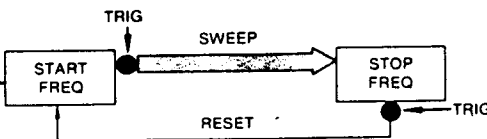

TRIGGERED SWEEP/HOLD WITH TRIG RESET/HOLD (Mode 5)

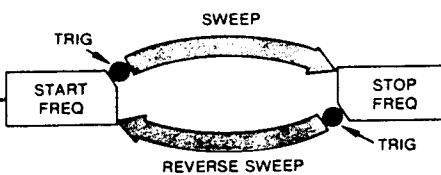

TRIGGERED SWEEP/HOLD WITH TRIG REVERSE/HOLD (Mode 6)

4.7.4 Sweep Phase Operation

This chart shows how to make the 650 sweep phase.

CHART	EXAMPLE
① Reset PARAMS	Reset PARAMS
② Main MODE CONT	Main MODE CONT
③ Main FREQ (Enter main frequency)	Main FREQ 1000 Execute
④ Channel Number (Enter number of channel to be phase swept)	Channel Number 2 Execute
⑤ Sweep PHASE LIMITS (Enter START and STOP limits of the phase sweep for the chosen channel)	Sweep PHASE LIMITS START 0 STOP 180 Execute
⑥ Sweep PHASE TIME (Enter sweep time)	Sweep PHASE TIME 2 Execute
⑦ Sweep PHASE FUNC (Choose function)	Sweep PHASE FUNC LINEAR
⑧ Sweep PHASE MODE (Choose mode)	Sweep PHASE MODE CONT RESET

CHART	EXAMPLE
⑨ Channel Number (Enter 1)	Channel Number 1 Execute
⑩ Channel SHIFT OUTPUT (Choose output)	Channel SHIFT OUTPUT ON-50Ω
⑪ Channel AMPL (Enter amplitude)	Channel AMPL 5 Execute
⑫ Channel FUNC (Choose function)	Channel FUNC SINE

CHART	EXAMPLE
⑬ Channel Number (Enter 2)	Channel Number 2 Execute
⑭ Channel SHIFT OUTPUT (Choose output)	Channel SHIFT OUTPUT ON-50Ω
⑮ Channel AMPL (Enter amplitude)	Channel AMPL 5 Execute
⑯ Channel FUNC (Choose function)	Channel FUNC SINE

ALL CHAN

CH 1

CH:

SYMBOLS

○ All-Channel Parameters □ Single-Channel Parameters

GPIB EXAMPLE

STEP	COMMAND	STEP	COMMAND
1	RST 1	9	CH 1
2	M 0	10	OT 1
3	FR 1000	11	AM 5
4	CH 2	12	FN 0
5	STRTP 0	13	CH 2
	STOPP 180	14	OT 1
6	STM 2	15	AM 5
7	SFN 0	16	FN 0
8	SMD 13		

PROGRAM

```

WRITE @709:"RST 1 M 0 FR 1000 CH 2 STRTP 0 STOPP 180 STM 2 SFN 0 SMD 13
CH 1 OT 1 AM 5 FN 0 CH 2 OT 1 AM 5 FN 0 EX"
( Sets up 650 and selects sweep mode 13 )
WRITE @709:"SMD 14 EX" (Selects sweep mode 14)
WRITE @709:"SMD 15 EX" (Selects sweep mode 15)
WRITE @709:"TRG EX" (Triggers sweep/auto-reset cycle)
WRITE @709:"SMD 16 EX" (Selects sweep mode 16)
WRITE @709:"TRG EX" (Triggers sweep/auto-reverse-sweep cycle)
WRITE @709:"SMD 17 EX" (Selects sweep mode 17)
WRITE @709:"TRG EX" (Triggers sweep)
WRITE @709:"TRG EX" (Triggers reset)
WRITE @709:"SMD 18 EX" (Selects sweep mode 18)
WRITE @709:"TRG EX" (Triggers sweep)
WRITE @709:"TRG EX" (Triggers reverse sweep)
    
```

CONTINUOUS MODE DEMONSTRATION

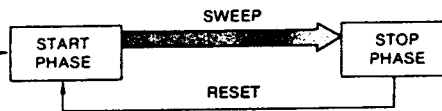
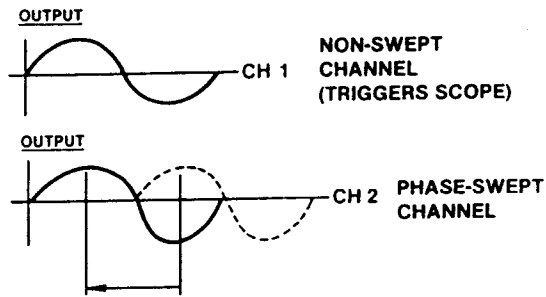
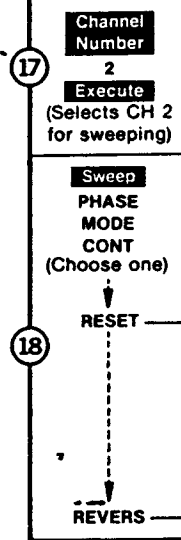

CONTINUOUS SWEEP WITH AUTO RESET (Mode 13)

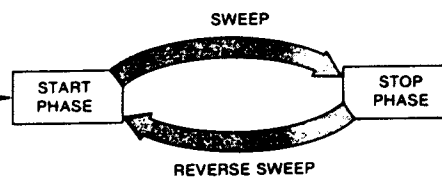

CONTINUOUS SWEEP WITH AUTO REVERSE (Mode 14)

(Normally, you select mode in step 8.)

TRIGGERED MODE DEMONSTRATION

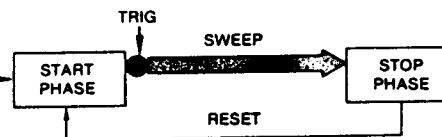
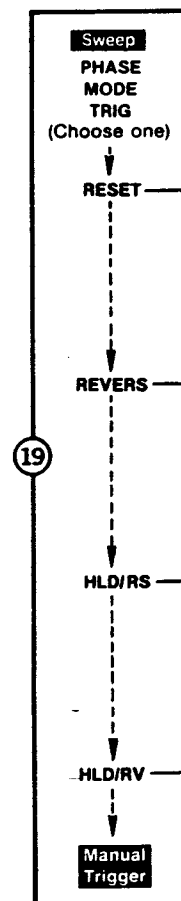

TRIGGERED SWEEP WITH AUTO RESET (Mode 15)

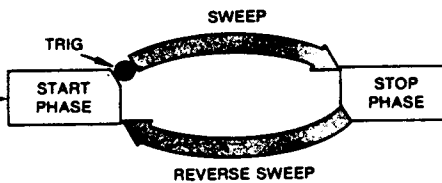

TRIGGERED SWEEP WITH AUTO REVERSE (Mode 16)

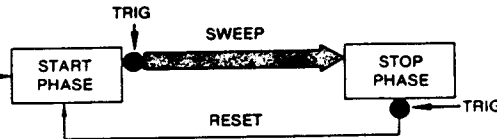

TRIGGERED SWEEP/HOLD WITH TRIG RESET/HOLD (Mode 17)

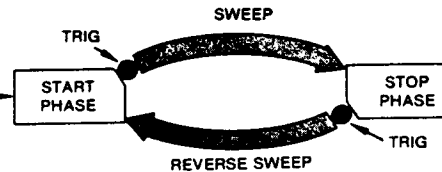

TRIGGERED SWEEP/HOLD WITH TRIG REVERSE/HOLD (Mode 18)

4.7.5 Combined Sweep Operation

This chart shows how to make the 650 simultaneously sweep frequency and phase and how to make it independently sweep phase in separate channels

EXAMPLE (A)
SIMULTANEOUS
FREQ/PHASE SWEEP

EXAMPLE (B)
MULTI-CHANNEL
PHASE SWEEP

EXAMPLE (A) EXAMPLE (B)

CHART	EXAMPLE (A) SIMULTANEOUS FREQ/PHASE SWEEP	EXAMPLE (B) MULTI-CHANNEL PHASE SWEEP
1	Reset PARAMS	Reset PARAMS
2	Main MODE CONT	Main MODE CONT
3	Sweep FREQ LIMITS (Enter START and STOP limits)	Sweep FREQ LIMITS START 1000 STOP 1 Exponent 4 Execute
4	Channel Number (Enter number of channel to be phase swept)	Channel Number 2 Execute
5	Sweep PHASE LIMITS Enter START and STOP limits of the phase sweep for the chosen channel)	Sweep PHASE LIMITS START 0 STOP 180 Execute
6	Repeat steps 4 and 5 for each channel requiring phase sweeping	Channel Number 2 Execute Sweep PHASE LIMITS START 0 STOP 360 Execute
7	Sweep FREQ (or PHASE) TIME (Enter sweep time applies to both sweeps)	Sweep FREQ (or PHASE) TIME 10 Execute
8	Sweep BOTH (Choose sweep mode)	Sweep BOTH CONT (Sweep mode 24)

ALL
CHAN

CHART	EXAMPLE (A)	EXAMPLE (B)
9	Channel Number (Enter 1)	Channel Number 1 Execute
10	Channel SHIFT OUTPUT (Choose output)	Channel SHIFT OUTPUT ON-50
11	Channel AMPL (Enter amplitude)	Channel AMPL 5 Execute
12	Channel FUNC (Choose function)	Channel FUNC SINE
13	Channel Number (Enter 2)	Channel Number 2 Execute
14	Channel SHIFT OUTPUT (Choose output)	Channel SHIFT OUTPUT ON-50Ω
15	Channel AMPL (Enter amplitude)	Channel AMPL 5 Execute
16	Channel FUNC (Choose function)	Channel FUNC SINE

CH 1

CH2

EXAMPLE (A) OUTPUTS

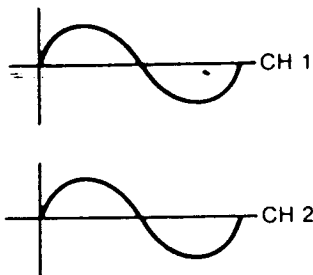

STARTING WAVEFORMS
(1 KHz and in phase)

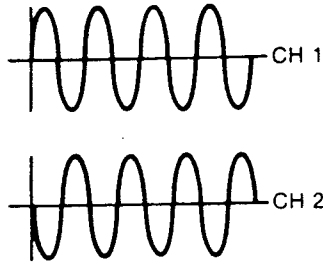

ENDING WAVEFORMS
(10 KHz and 180° out of phase)

Use the **Hold/Resume** key to make the phase shift easier to see as the sweep progresses.

EXAMPLE (B) OUTPUTS

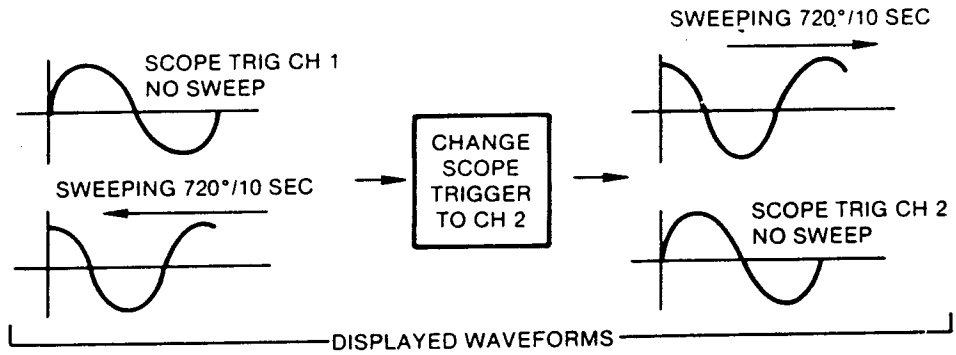
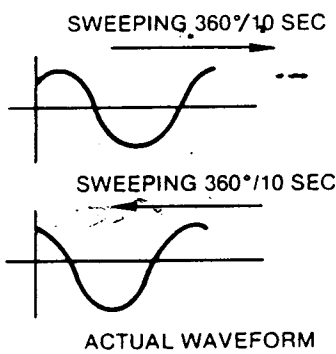

GPIB EXAMPLE (A)

SIMULTANEOUS FREQ/PHASE SWEEP

STEP COMMAND

- 1 RST 1
- 2 M 0
- 3 STRTF 1000
STOPF 1E4
- 4 CH 2
- 5 STRTP 0
STOPP 180
- 6 - none -
- 7 STM 10
- 8 SMD 24
- 9 CH 1
- 10 OT 1
- 11 AM 5
- 12 FN 0
- 13 CH 2
- 14 OT 1
- 15 AM 5
- 16 FN 0

PROGRAM

```
WRITE@709:"RST 1 M 0 STRTF 1000 STOPF 1E4 CH 2 STRTP 0
STOPP 180 STM 10 SMD 24 CH 1 OT 1 AM 5 FN 0
EX"
( Sets up 650 and selects sweep mode 24)
```

GPIB EXAMPLE (B)

MULTI-CHANNEL PHASE SWEEP

STEP COMMAND

- 1 RST 1
- 2 M 0
- 3 STRTF 1000
STOPF 1000
- 4 CH 1
- 5 STRTP 0
STOPP - 360
- 6 CH 2
STRTP 0
STOPP 360
- 7 STM 10
- 8 SMD 24
- 9 CH 1
- 10 OT 1
- 11 AM 5
- 12 FN 0
- 13 CH 2
- 14 OT 1
- 15 AM 5
- 16 FN 0

PROGRAM

```
WRITE@709:"RST 1 M 0 STRTF 1000 STOPF 1000 CH 1 STRTP 0
STOPP - 360 CH 2 STRTP 0 STOPP 360 STM 10 SMD 24
CH 1 OT 1 AM 5 FN 0 CH 2 OT 1 AM 5 FN 0 EX"
( Sets up 650 and selects sweep mode 24)
```

SYMBOLS

○ All-Channel Parameters □ Single-Channel Parameters

4.7.6 Sequence Frequency Operation

This chart shows how to make the 650 step through any sequence of frequencies.

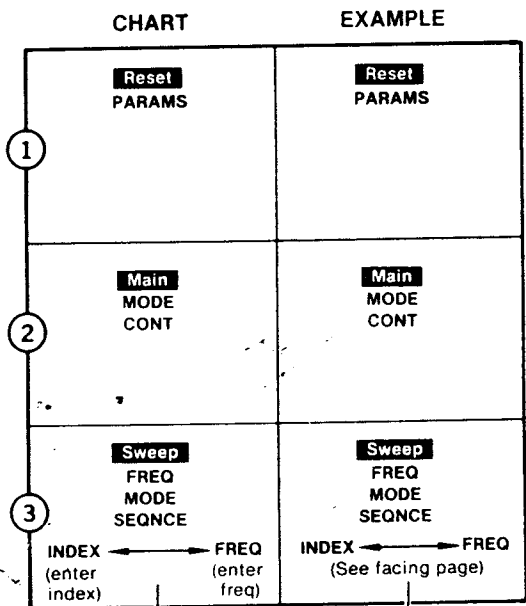

Enter a series of frequencies with INDEX and FREQ keys (99 steps maximum)

INDEX	FREQ
01	1000 Hz
02	2000 Hz
03	3000 Hz
04	4000 Hz

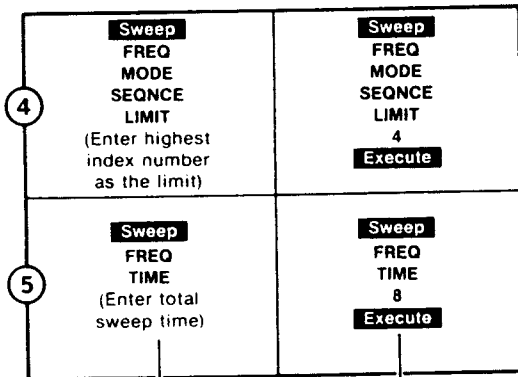

Time per step $T = \frac{\text{SWEEP TIME}}{\text{LIMIT}}$ $T = \frac{8 \text{ sec}}{4 \text{ steps}} = 2 \text{ sec/step}$

Skip Step 5 if you choose EXTRNL triggering in step 6.

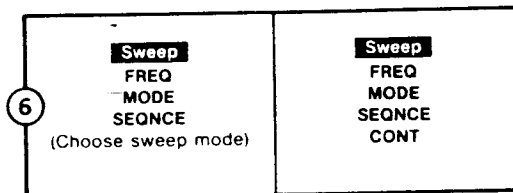

ALL CHAN

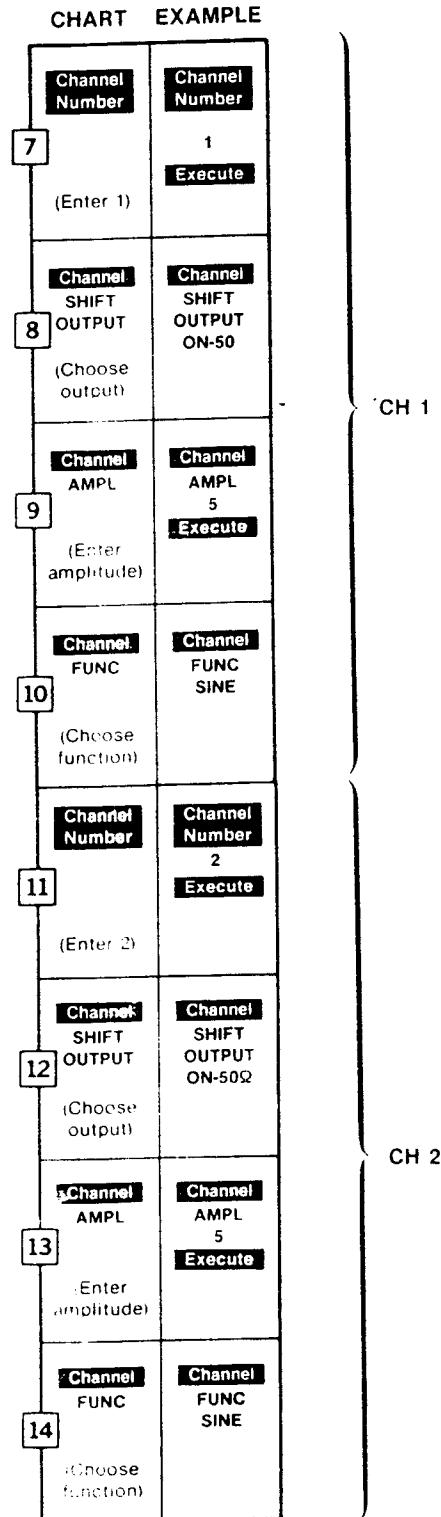

CH 1

CH 2

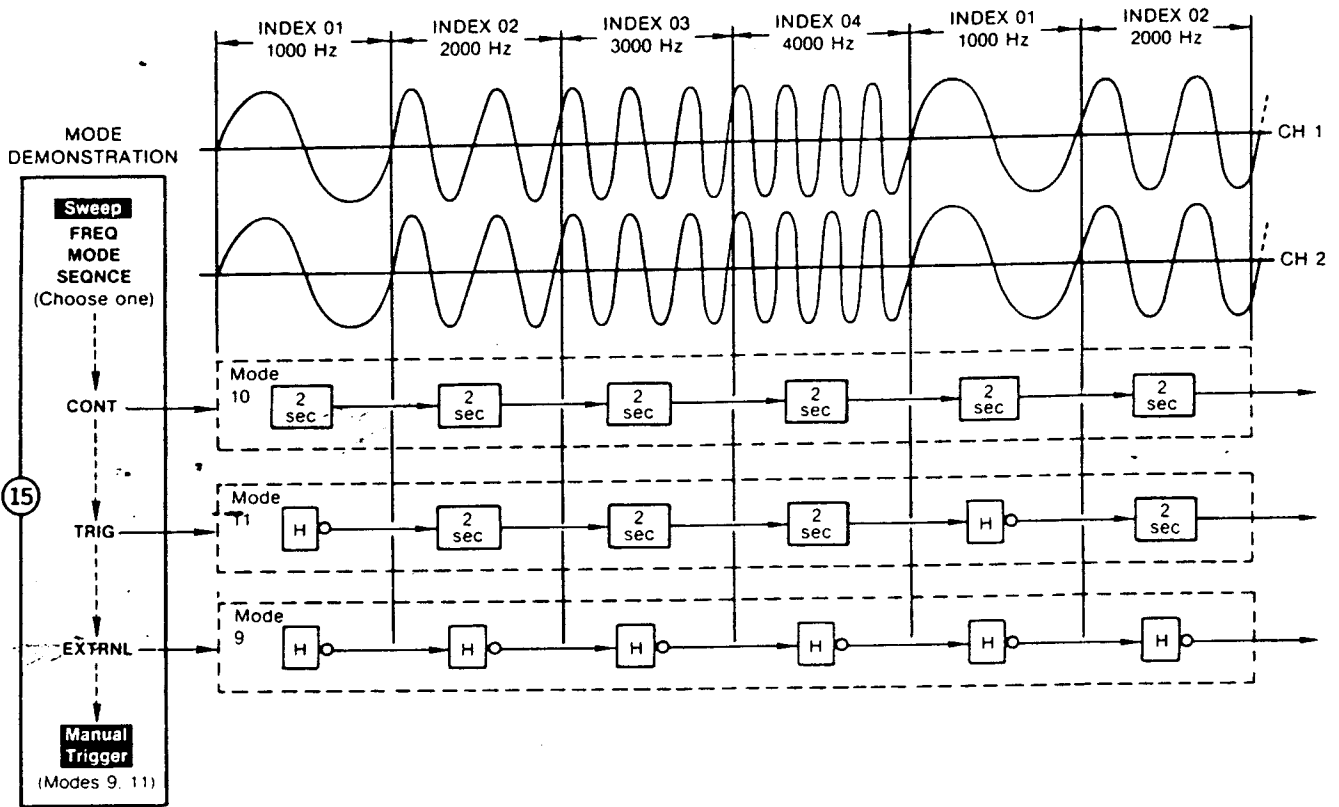

(Normally, you select mode in step 6.)

GPIB EXAMPLE

STEP	COMMAND	STEP	COMMAND
1	RST 0	5	STM 8
2	M 0	6	SMD 10
3	SQI 1	7	CH 1
	SQF 1000	8	OT 1
	SQI 2	9	AM 5
	SQF 2000	10	FN 0
	SQI 3	11	CH 2
	SQF 3000	12	OT 1
	SQI 4	13	AM 5
	SQF 4000	14	FN 0
4	SQL 4		

PROGRAM

```

WRITE #709:"RST 0 M 0 SQI 1 SQF 1000 SQI 2 SQF 2000
SQI 3 SQF 3000 SQI 4 SQF 4000 SQL 4
STM 8 SMD 10 CH 1 OT 1 AM 5 FN 0
CH 2 OT 1 AM 5 FN 0 EX"
(Sets up 650 and selects sweep mode 10)
WRITE #709:"SMD 11 EX"
(Selects sweep mode 11)
WRITE #709:"TRG EX"
(Triggers one pass through sequence)
WRITE #709:"SMD 9 EX"
(Selects sweep mode 9)
WRITE #709:"TRG EX"
(Triggers jump to next frequency
in sequence)
    
```

EXPANSION OF EXAMPLE STEP 3

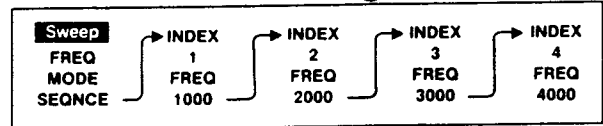

SYMBOLS

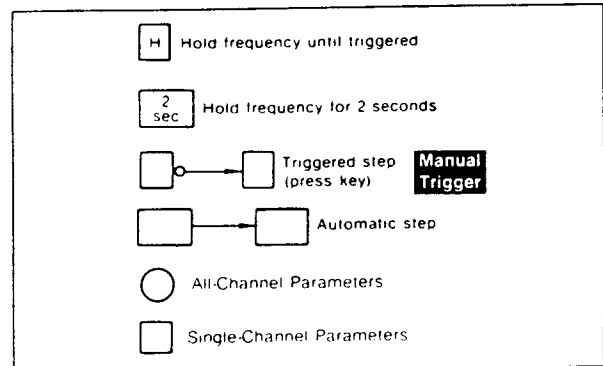

4.7.7 Sequence Phase Operation

This chart shows how to make the 650 step through any sequence of phases.

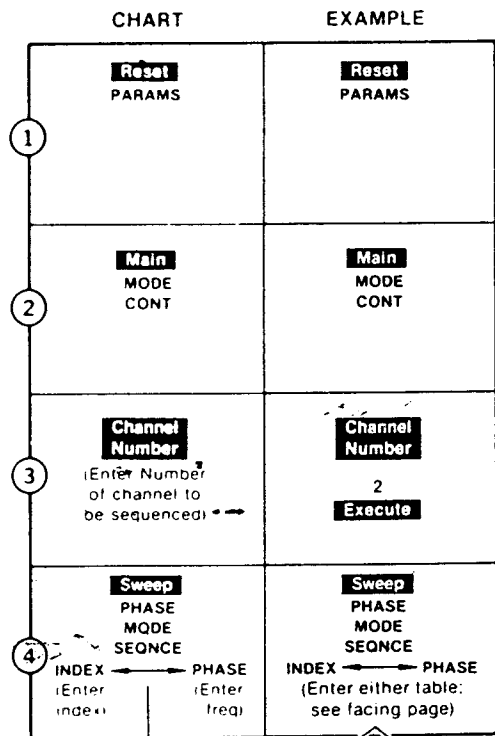

Enter a series of phases for the chosen channel with the INDEX and PHASE keys (99 steps maximum).

UNCONVERTED VALUES		CONVERTED VALUES	
INDEX	PHASE	INDEX	PHASE
1	0°	1	0°
2	-60°	2	-60°
3	-120°	3	-120°
4	-180°	4	-180°
5	-240°	5	+120°
6	-300°	6	+60°

AUTO CONVERSION
The 650 automatically converts any value outside the range -180.00 to +120.99 to an equivalent value inside the range.

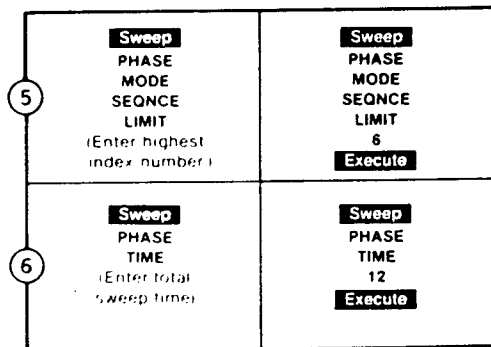

Time per step $T = \frac{\text{SWEEP TIME}}{99}$ $T = \frac{12}{99} = 2 \text{ sec/step}$

Skip step 5 if you choose EXTRNL triggering in step 16

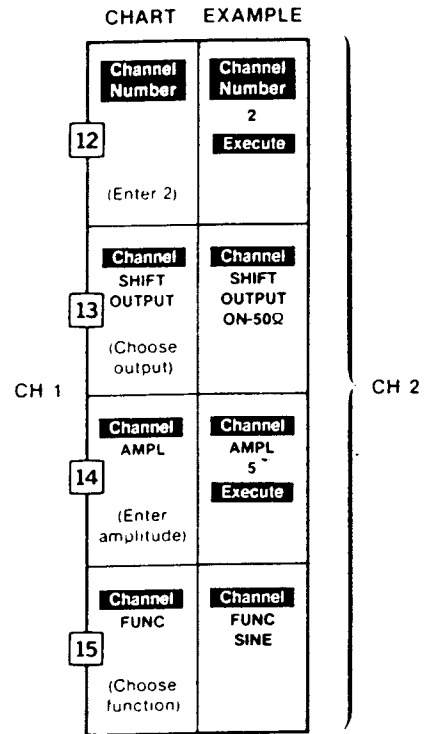
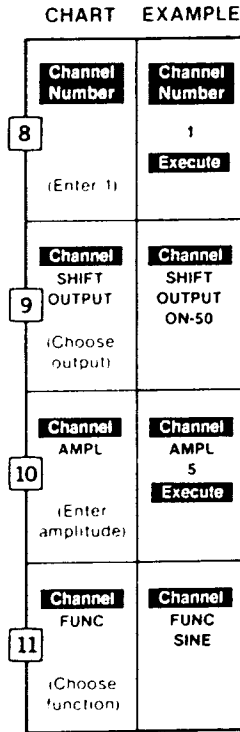
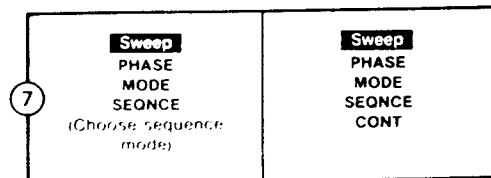

ALL CHAN

GPIB EXAMPLE
SEQUENCE PHASE

STEP	COMMAND	STEP	COMMAND
1	RST 1	6	SQL 6
2	M 0	7	SOP - 300
3	CH 1	8	SQL 6
4	SOI 1	9	STM 12
	SOP 0	10	SMD 20
	SOI 2	11	CH 1
	SOP - 60	12	OT 1
	SOI 3	13	AM 5
	SOP - 120	14	CH 2
	SOI 4	15	OT 1
	SOP - 180		AM 5
	SOI 5		FN 0
	SOP - 240		

PROGRAM

```

WRITE " 709" "RST 1 M 0 CH 1 SSOI 1 SOP 0 SOI 2 SOP
- 60 SOI 3 SOP - 120 SOI 4 SOP - 180 SOI
5 SOP - 240 SOI 6 SOP - 300 SQL 6 STM
12 SMD 20 CH 1 OT 1 AM 5 FN 0 CH 2 OT
1 AM 5 FN 0 EX"
( Sets up 650 and selects sweep mode 24 )
WRITE " 709" "CH 2 EX"
( Enables channel 2 as the sequencing
channel )
WRITE " 709" "SMD 21 EX"
( Selects sweep mode 21 )
WRITE " 709" "TRG EX"
( Triggers one pass through sequence )
WRITE " 709" "SMD 19 EX"
( Selects sweep mode 19 )
WRITE " 709" "TRG EX"
( Triggers jump to next phase in sequence )
    
```

EXPANSION OF EXAMPLE STEP ④

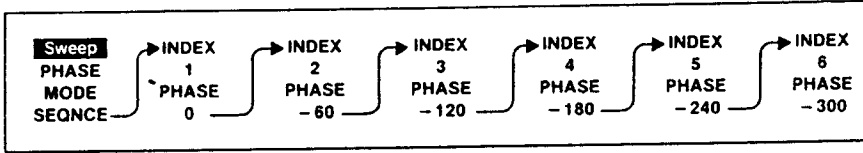

SYMBOLS

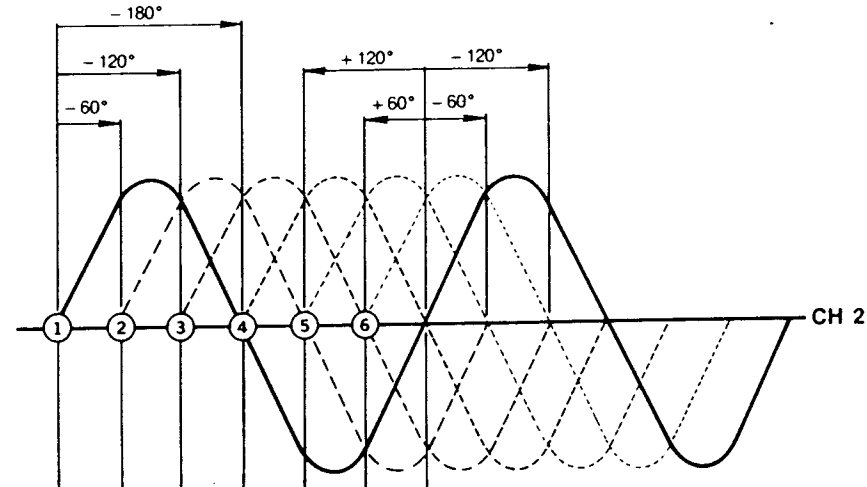
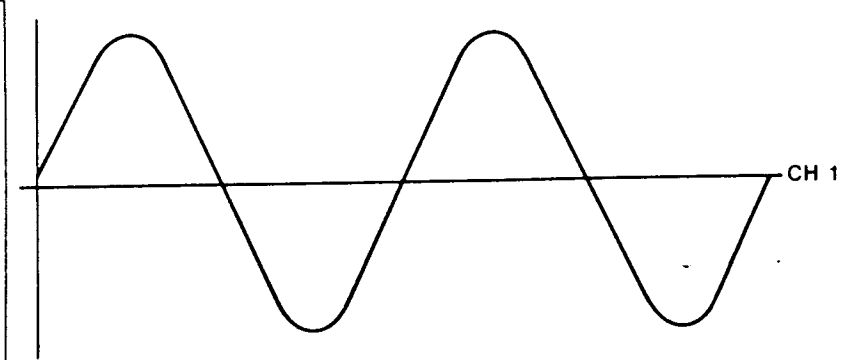
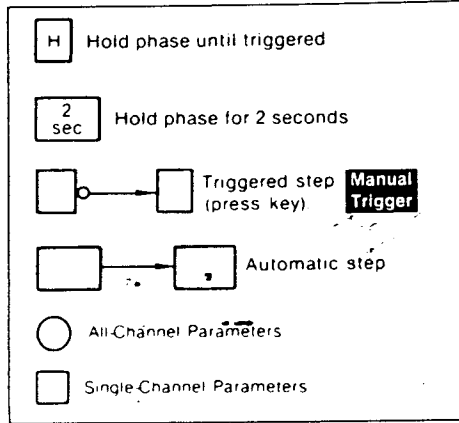

MODE DEMONSTRATION

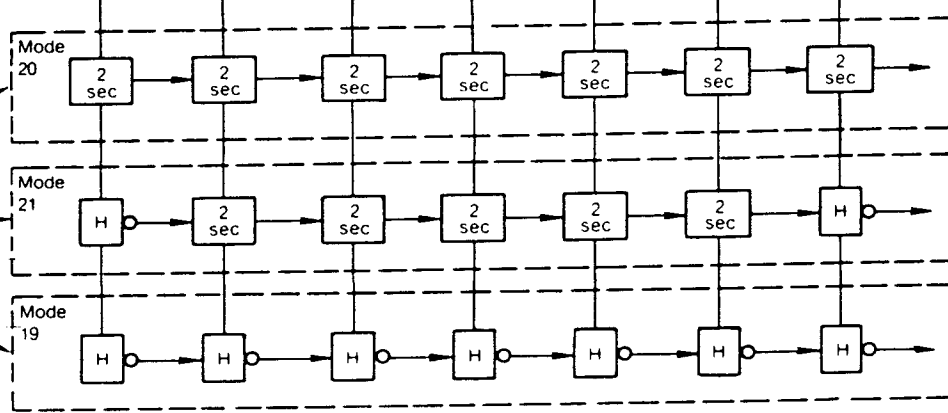
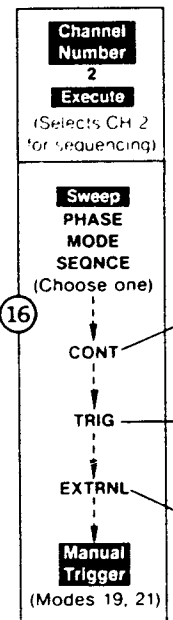

(Normally, you select mode in step 7.)

SECTION 5

DETAILED OPERATION

5.1 INTRODUCTION

This section provides detailed 650 operating information. The menu tree sections appear in front-panel order.

Section	Topics Covered	Page
5.2 Main Key Menu Tree	Overall Operation Soft Key Operation	5-3 5-3
5.3 Channel Key Menu Tree	Overall Operation Soft Key Operation	5-4 5-8
5.4 Trigger Key Menu Tree	Overall Operation Soft Key Operation	5-11 5-12
5.5 Sweep Key Menu Tree	Overall Operation Soft Key Operation Continuous Sweeps Triggered Sweeps FSK Sweeps Sequenced Sweeps FM and PM Sweeps Delta-Frequency Sweep	5-13 5-17 5-22 5-24 5-26 5-27 5-31 5-35
5.6 Utility Key Menu Tree	Configuration Menu Hold-In Menu Calibration Menus Self-Test Menu Troubleshoot Menu Environment Menu	5-37 5-37 5-38 5-38 5-42 5-42
5.7 GPIB Key Menu Tree	Overall Operation Soft Key Operation	5-42 5-42
5.8 Stored Settings Key Menu Tree	Overall Operation Soft Key Operation	5-44 5-45
5.9 Reset Key Menu Tree	Overload/Parameter Resets	5-47
5.10 Amplitude Modulation	Inputs/Operation	5-47

MAIN

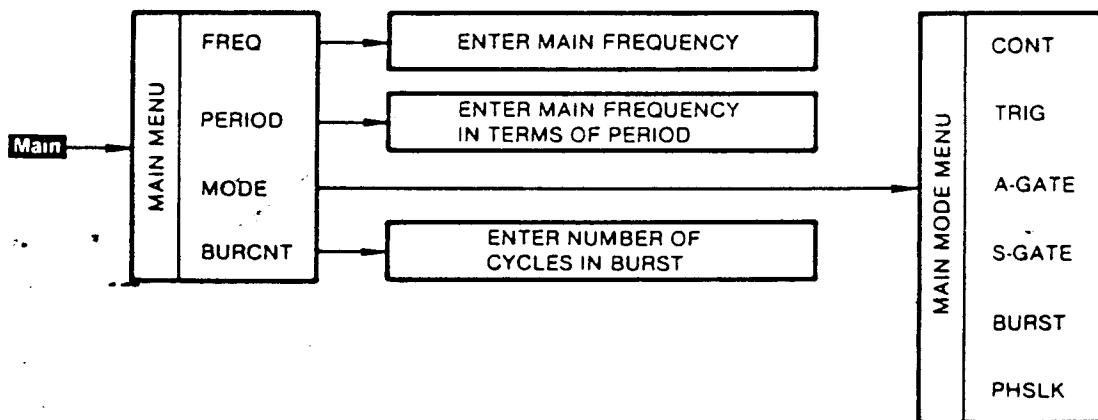

The **Main** key affects all channels.

A-GATE MODE	Selects asynchronous output gating.
BURCNT	Enables entry of number of cycles generated in the BURST mode.
BURST MODE	Selects a triggered burst output of BURCNT cycles.
CONT MODE	Selects a continuous output.
FREQ	Enables entry of a numeric value for output frequency.
MODE	Causes display of main mode menu.
PERIOD	Enables entry of a numeric value for output frequency in terms of period.
PHSLK MODE	Locks the main frequency generator to an external signal.
S-GATE MODE	Selects synchronous output gating.
TRIG MODE	Allows external signal to trigger one cycle of output waveform.

Figure 5-1. Main Key Menu Tree

5.2 Main KEY MENU TREE

This part provides detailed operating instructions for the Main menu tree (see figure 5-1).

5.2.1 Overall Operation

The Main menu sets the main frequency of the 650 and determines the non-sweep operating mode: continuous, triggered, asynchronous gated, synchronous gated, burst, and phase locked.

5.2.2 Soft Key Operation

FREQ AND PERIOD KEYS

Basic Frequency. In non-sweep operation, the FREQ and PERIOD keys determine the basic internal non-changing frequency of the 650. All the channels supply waveforms with this frequency, and all the channels relate their phase to it. You can enter the main frequency either as frequency or as period, where $Period = 1/Frequency$. For 1000 Hz, $Period = 1/1000 \text{ Hz} = 1 \text{ millisecond}$.

Frequency Modifications. You can: 1) shift the frequency of any channel away from the main frequency by $\leq 1000 \text{ Hz}$ (see sweep mode 22, delta-frequency), 2) make each channel supply an integer (non-fractional) multiple of the main frequency (see Channel-RATIO), or 3) lock the main frequency to an external signal (see Main-MODE-PHSLK).

MODE KEY

Function. The MODE key calls the main mode menu, from which you can select one of the six main operating modes discussed below.

Each of the main modes affects all channels simultaneously. Table 5-3 (in section 5.5.1) shows how each mode drives the Horiz Out connector, the Marker Out connector, the frequency monitor and the phase monitor. See the Trigger key description for more information about triggering these modes.

CONT The continuous mode produces a continuous waveform. Choose CONT for an uninterrupted output and for frequency or phase sweeping of the output.

TRIG The triggered mode generates one waveform cycle for each trigger. Any of these sources

can trigger the waveform: a) the front panel Manual Trigger button, b) an external signal applied to the rear panel Trig In connector, c) the internal trigger-generation oscillator, or d) a trigger command sent via the GPIB bus.

BURST The burst mode generates a fixed number (BURCNT) of waveform cycles for each trigger. Follow this sequence to set up the burst mode: First, press Main to bring up the main menu. Second, press BURCNT to enable entry of the burst count. Third, key in the number of cycles you want in the burst. Forth, press MODE to call to main mode menu. Fifth, press BURST to activate the burst mode. Finally, use any of the triggers described in the TRIG mode above to trigger the burst.

A-GATE The asynchronously gated mode turns the output waveforms on and off instantly. Opening the gate starts the waveform at its zero crossing; closing the gate cuts off the waveform at the current point of its cycle. You can gate three ways: 1) apply an external signal to the Trig In connector (L = gate closed; H = gate open), 2) send GATEON/GATEOFF commands over the GPIB bus, or 3) press/release the Manual Trigger key.

S-GATE The synchronously gated mode turns the output waveforms on and off in sync with the output waveform. Opening the gate starts the waveform at its zero crossing; closing the gate forces the waveform to stop at the waveform's next zero crossing. You can gate three ways: 1) apply an external signal to the Trig In connector (L = gate closed; H = gate open), 2) send GATEON/GATEOFF commands over the GPIB bus, or 3) press/release the Manual Trigger key.

PHSLK Phase locks the main generator frequency to an external signal (40 Hz to 2 MHz) applied to the Trig In connector. If the reference frequency changes more than $\pm 10\%$, PHSLK will reset the main generator to the new frequency. The initial lock takes less than 4 seconds; relocks after frequency changes take 100 periods plus 100ms.

Note: Trig level must be set within level of input signal

5.3 Channel KEY MENU TREE

This part provides detailed operating instructions for the Channel menu tree shown in figure 5-3.

5.3.1 Overall Operation

Function. The Channel menu tree controls the shape and electrical characteristics of a channel's output waveform. Figure 5-4 shows the eight channel parameters and the effect of each one on the output.

One Tree Per Channel. Each channel has a separate menu tree. Setting a parameter for one channel does not set or affect the corresponding parameter in another channel.

How to Select a Channel. Use the Channel Number key as follows to tell the 650 which channel you want to program: First, press Channel Number. Second, key in the

number of the channel you want to program. Third, press Execute. The number of the active channel will appear in the upper right corner of the screen. Once you select a channel, all the channel parameters that you set will apply only to that channel until you select another. You do not have to leave the channel menu to change to another channel.

How to Shift the Menu. In order to display all eight channel parameters in one menu, the screen displays four active parameters next to the soft keys, and four inactive parameters on the line above. The SHIFT key swaps these two rows. To use the channel menu, press the Channel key to make the menu appear as shown in the top part of figure 5-2, with amplitude, offset, phase, and function controlled by keys F3-F6. Press the SHIFT key to swap the rows and put output, ratio, delay, and duty under the control of keys F3-F6.

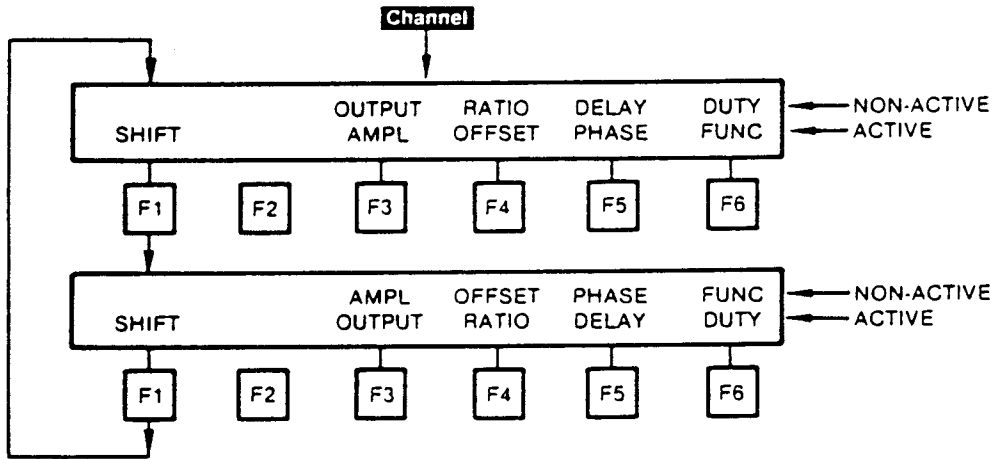
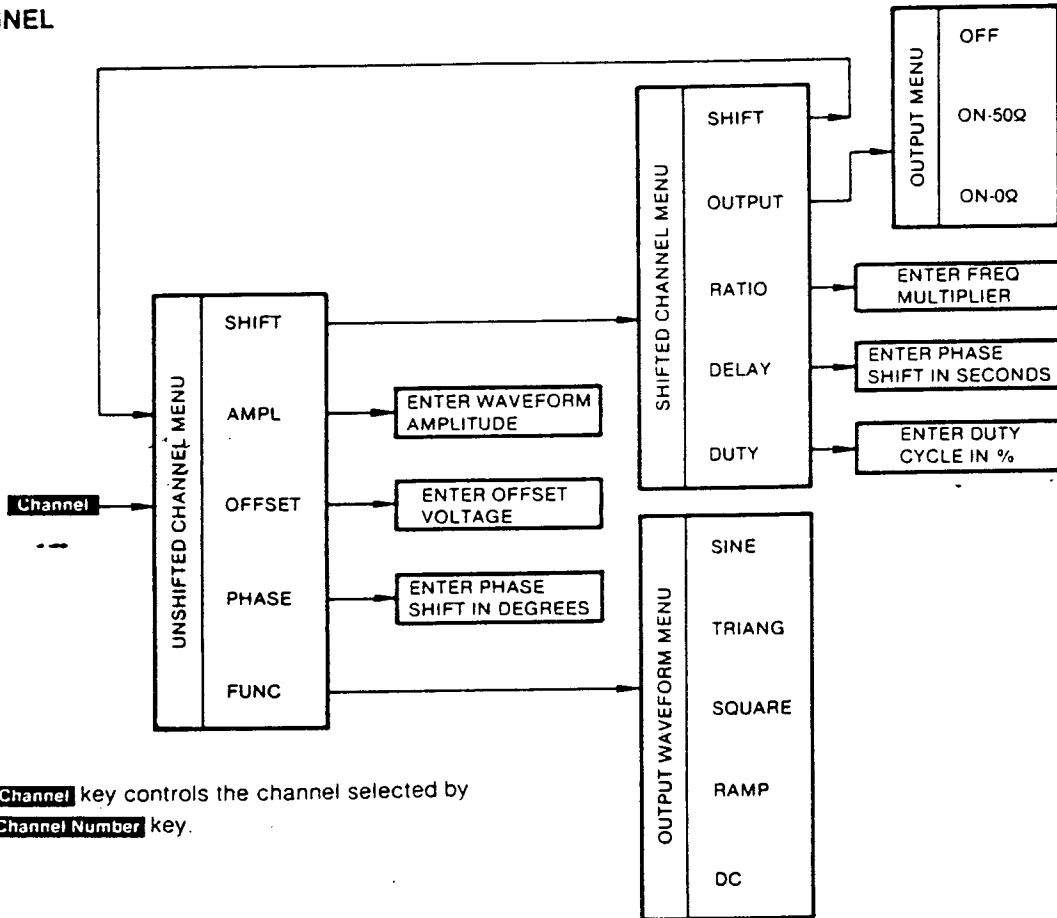

Figure 5-2. Channel Menu Shift Operation

CHANNEL



The **Channel** key controls the channel selected by the **Channel Number** key.

- AMPL Enables entry of a numeric value for amplitude in volts peak-to-peak. AMPL displays value in volts p-p and rms.
- DC Selects DC as the output waveform (voltage determined by OFFSET).
- DELAY Enables entry of a numeric value in seconds for waveform phase shift.
- DUTY Enables entry of a numeric value (in percent) for the duty cycle of square or ramp waveforms.
- FUNC (MENU) Causes display of the output waveform menu.
- OFF Opens the channel output relays.
- OFFSET Enables entry of numeric dc offset for the selected waveform.
- ON-0Ω Selects 0 ohm output impedance.
- ON-50Ω Selects 50 ohm output impedance.
- OUTPUT (MENU) Causes display of the output menu.
- PHASE Enables entry of a numeric value in degrees for the phase shift of the output.
- RAMP Selects ramp output waveform (DUTY determines duty cycle).
- RATIO Enables entry of a numeric integer from 1 to 99 that sets the frequency of the channel to a multiple of the MAIN frequency.
- SHIFT Selects the four active soft keys of the eight soft keys displayed in the menu.
- SINE Selects the sinusoidal output waveform.
- SQUARE Selects the square output waveform (DUTY determines duty cycle).
- TRIANG Selects the triangle output waveform.

Figure 5-3. **Channel** Key Menu Tree

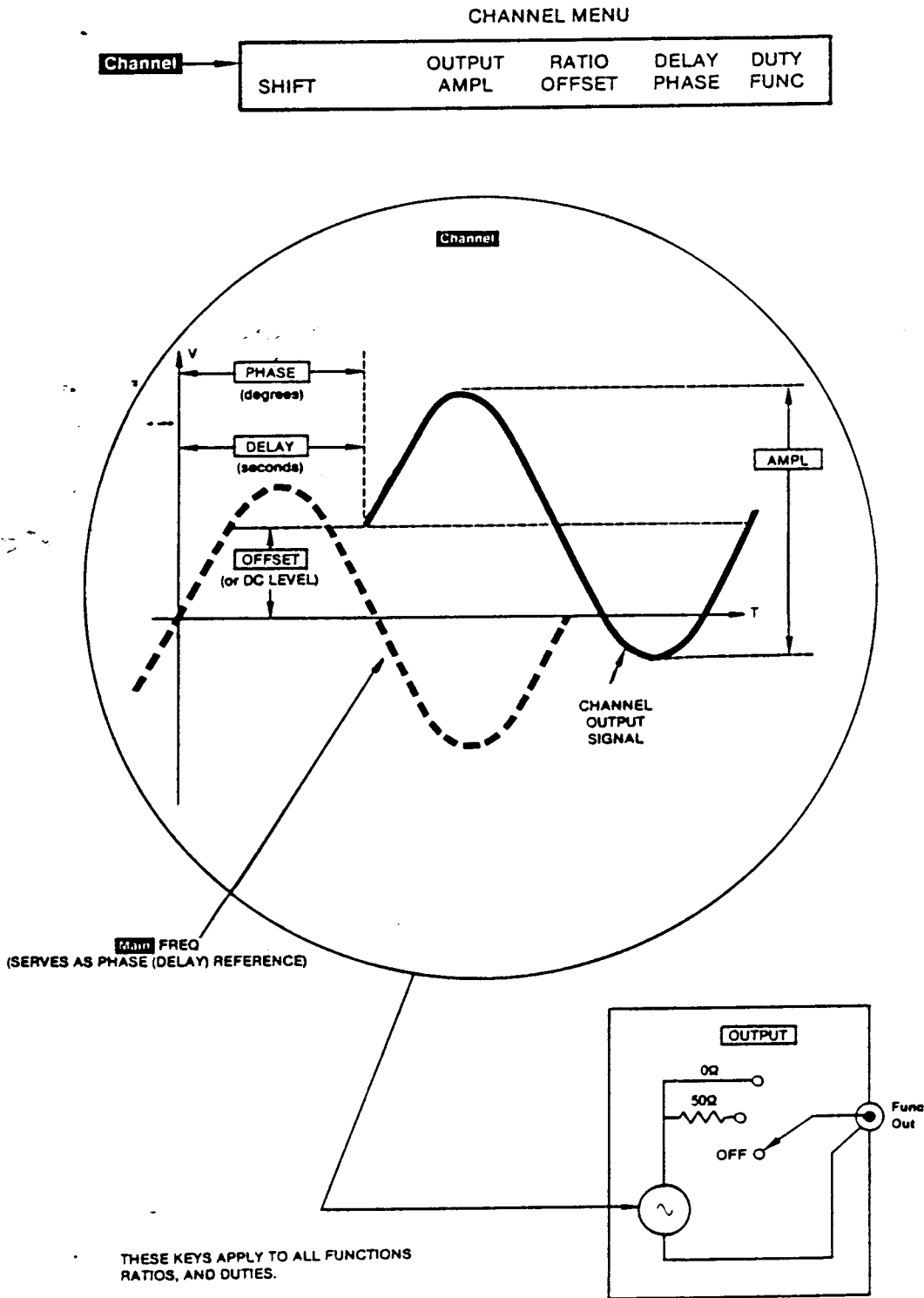
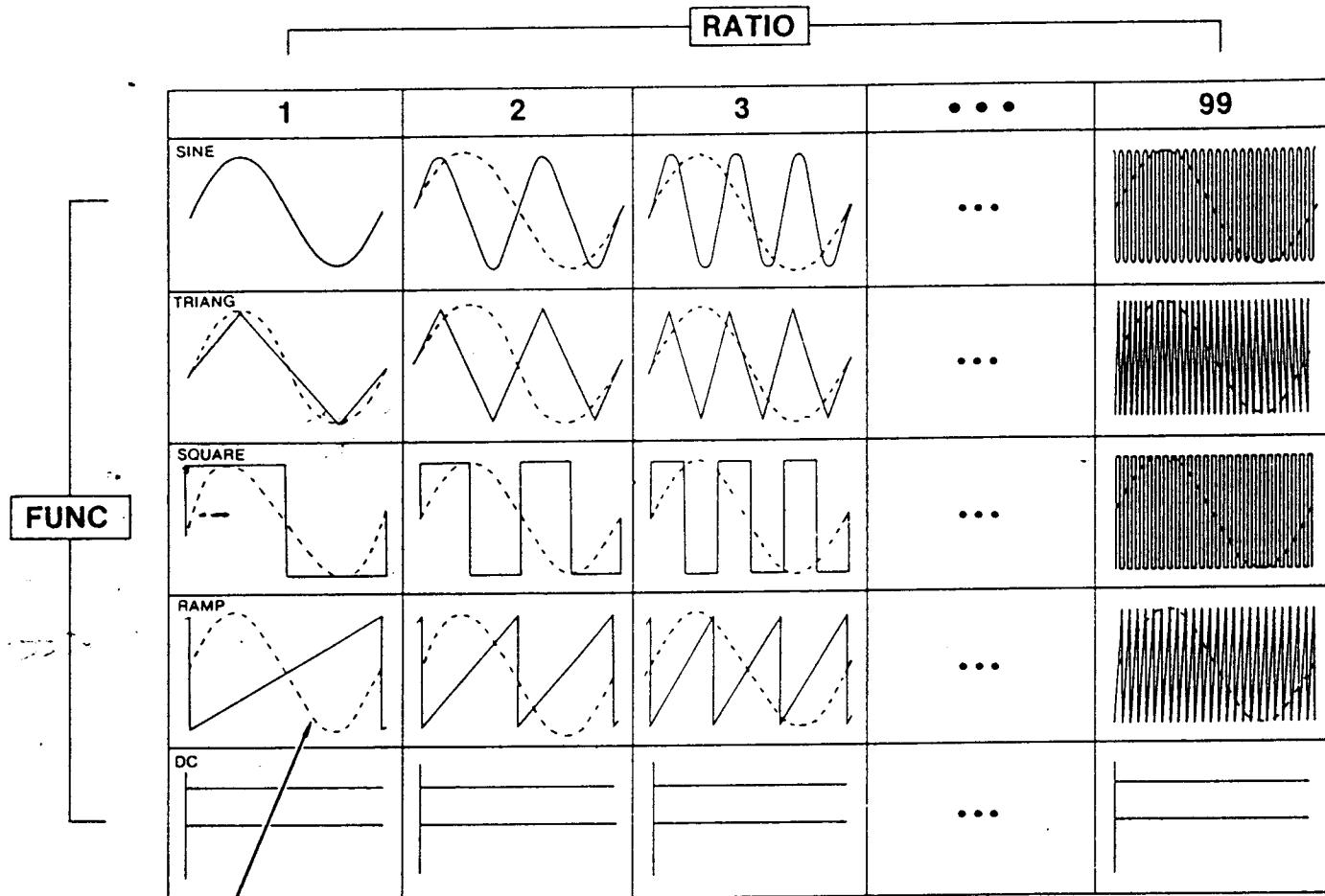
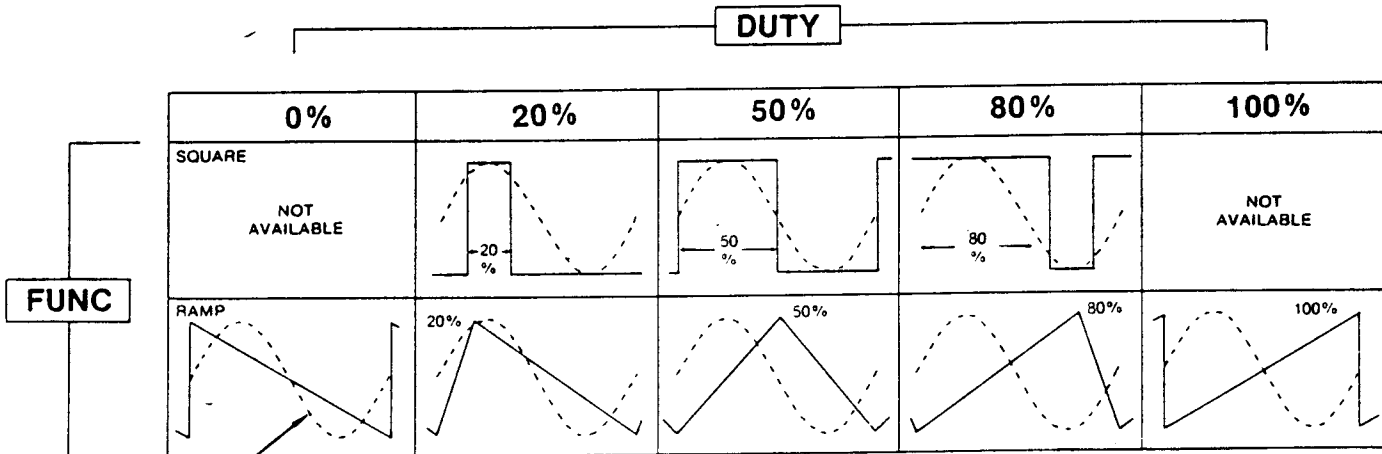

Figure 5-4. Channel Menu Functions



Main FREQ (SHOWN FOR PHASE REFERENCE)



Main FREQ (SHOWN FOR PHASE REFERENCE)

Figure 5-4. Channel Menu Functions

5.3.2 Soft Key Operation

AMPL Key

Function. AMPL sets the peak-to-peak amplitude of the sine, triangle, ramp, and square functions (see figures 5-4 and 5-5). It does not control the amplitude of the DC function (see OFFSET).

Limits. 0 to 50Vp-p (-25V to +25V) for 0Ω output impedance; 0 to 25Vp-p (-12.5V to +12.5V) for 50Ω output impedance. Figure 5-5 and the OFFSET and OUTPUT key descriptions explain the effects of offset and output on amplitude.

DELAY Key

See PHASE key.

DUTY Key

Function. DUTY (expressed in %) modifies the shape of the square and ramp waveforms as shown in figure 5-4. Duty cycle does not apply to the sine, triangle, or DC functions.

Limits: 20% to 80% for a square wave; 0% to 100% for a ramp. Entering less than 20% or more than 80% for a square wave will generate the error message *** duty cycle 20-80% in square ***.

FUNC Key

Function. The FUNC key selects sine, triangle, square, ramp, or DC as the channel's output waveform. See figure 5-4.

OFFSET Key

Function. OFFSET determines 1) the centerline DC offset voltage for the sine, triangle, square, and ramp waveforms or 2) the voltage of the DC waveform.

Maximum Peak Values of Amplitude Plus Offset: -25VDC and +25VDC for 0Ω output; -12.5VDC and +12.5VDC for 50Ω output (see figure 5-5). If you enter values slightly outside these limits, the 650 will clip the waveform and display the *** ampl/ofst clipping limit *** message. If you enter values too far outside the limits, the 650 will open the overloaded channel's output relay and display the *** OUTPUT OVERLOAD DETECTED *** message. You cannot reset the overload until you enter allowed values.

How to Determine the Correct Amplitude/Offset Values. Use the graph in figure 5-5 to determine the maximum amplitude allowed for any given offset.

OUTPUT Key

Function. OUTPUT applies signal to the FUNC OUT connectors by opening and closing the output relays as shown in figure 5-4. Choose OFF, ON-0Ω, or ON-50Ω.

OFF. The 650 powers up with the relays open. You can either close them immediately or wait until you have completely set up the signal before applying it to your circuit.

ON-0Ω. The 650 provides the 0Ω output impedance for phase-critical applications. The unavoidable capacitance found in coaxial cables combines with the output impedance of the 650 to form a phase-shifting RC circuit. Using the 0Ω output impedance makes the cable phase shift insignificant.

When you select the ON-0Ω output, the 650 will generate the exact voltage amplitude that you entered in the channel menu. Because the internal impedance equals 0, all the voltage will appear across your external circuit load. Figure 5-5 shows the combinations of amplitude and offset permitted by ON-0Ω.

ON-50Ω. The 50Ω output provides the correct impedance for standard 50Ω loads and 50Ω coaxial cable. Although signal degradation usually poses no problem in the relatively low-frequency 650, using the 50Ω output with a 50Ω load will produce the highest quality signal at higher frequencies. In addition, the internal 50Ω resistor helps protect the 650 against any adverse effects from the circuit under test.

When you select the ON-50Ω output, the 650 will generate twice the voltage AMPL that you entered in the channel menu. Half this voltage will appear across the internal 50Ω impedance and the other half will appear across the external 50Ω load. Figure 5-5 shows the combinations of amplitude and offset permitted by ON-50Ω.

Overload. If the output current exceeds 500ma, the output relay will open and this message will appear:

```

***OUTPUT OVERLOAD DETECTED***
USE OVERLOAD RESET TO RESTORE OUTPUTS
—reset menu—
params ovload
    
```

Correct the cause of the overload before using PARAMS or OVLOAD to reset.

NOTE

Failure to terminate the outputs will degrade the quality of high frequency and square wave signals.

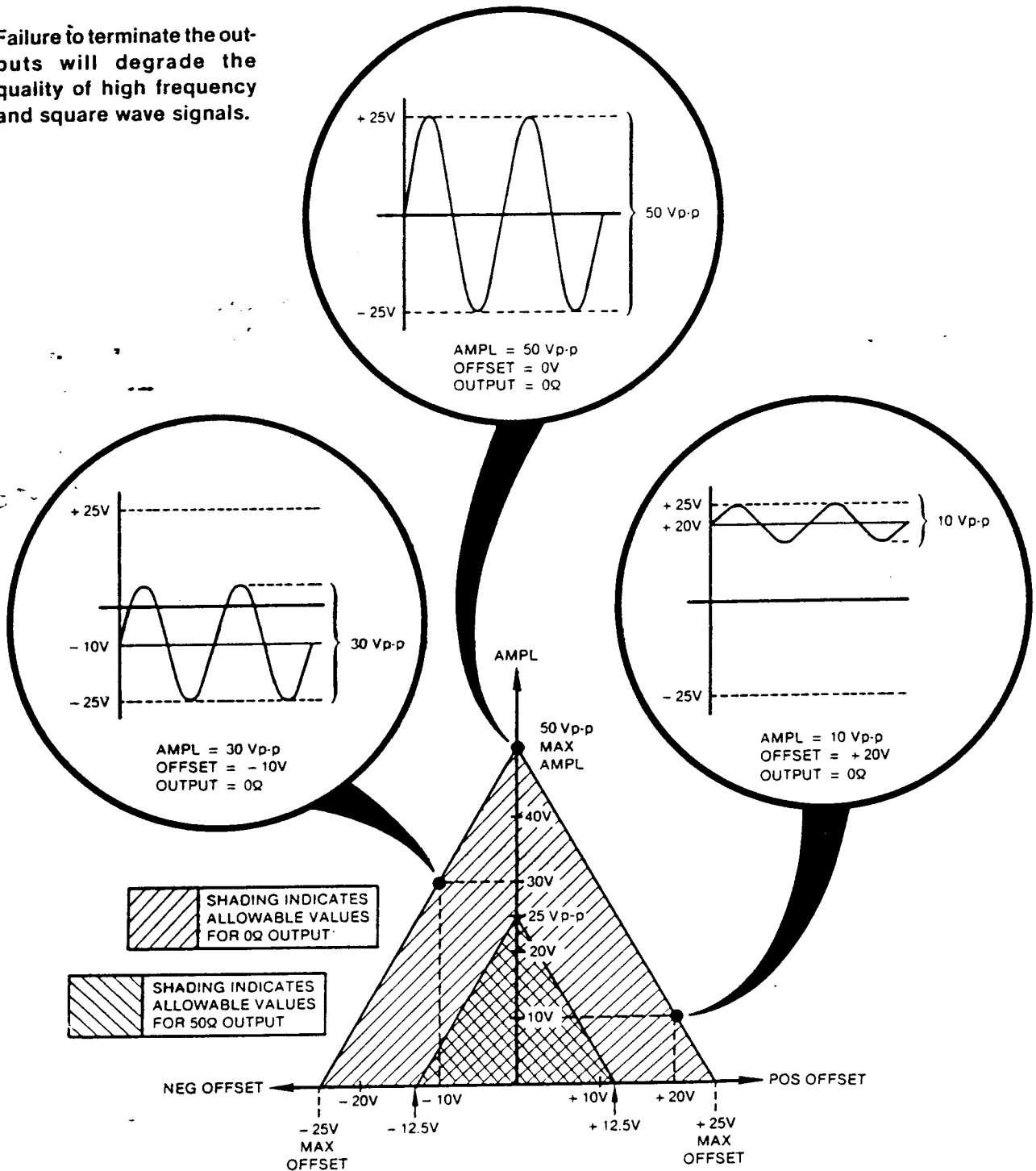

Figure 5-5. Allowable Combinations of Amplitude, Offset, and Output

PARAMS (parameters) reset leaves the output relay open and resets the other parameters (such as frequency and amplitude) to their default values.

OVLOAD (overload) reset closes the output relays but leaves your instrument setup unchanged. Always determine and correct the cause of the overload in your test setup before resetting the 650.

PHASE and DELAY Keys

Function. The PHASE and DELAY keys determine the phase of a channel in relation to the phase of the main frequency generator. To put a channel in phase with the main frequency generator, set its phase to zero degrees and its delay to zero seconds.

PHASE Key. The PHASE key sets and holds a fixed phase relationship (in degrees) between the channel and the main frequency generator. The 650 will hold the phase relationship regardless of the frequency.

DELAY Key. The DELAY key sets and holds a fixed time delay between the channel and the main frequency generator. If the frequency changes, the 650 will adjust the phase relationship as required to hold the time delay

constant (Phase = Delay × Frequency). Use DELAY to compensate for signal delays through external cables and circuits.

Phase/Delay Relationship. To arrive at the final phase relationship between the channel and the main frequency generator, the 650 first converts the menu delay value into a phase, then adds it to the menu phase value. The 650 separates delay and phase so you can correct for external cable/amplifier delay once, then forget it. If the 650 only accepted phase, you would have to recalculate the phase due to delay every time you changed the frequency.

Operating Restrictions. Although you can enter independent phase and delay values in each channel, the 650 will apply or ignore them depending on the operating mode and sweep compensation (on or off). Table 5-1 tells when the 650 applies PHASE and DELAY.

Parameter Limits. Phase: ± 10 million degrees. Delay: ± 2msec.

Sign Conventions. Figure 5-6 gives the phase shift sign conventions.

Table 5-1. PHASE and DELAY Application Conditions

Although you can enter different PHASE and DELAY parameters in each channel, the 650 will selectively apply or ignore these parameters, depending on sweep mode, sweep compensation, and active channel.

Sweep Mode	Channels Affected	Sweep Compensation On		Sweep Compensation Off	
		Phase Parameters	Delay Parameters	Phase Parameters	Delay Parameters
Mode 0 Sweep Off	All Channels	Applied	Applied	Applied	Applied
Modes 1-12 Frequency Sweeps	All Channels	Applied	Applied	Applied	Ignored
Modes 13-23 Phase Sweeps	Swept Channel	Ignored	Applied	Ignored	Ignored
	Other Channels	Applied	Applied	Applied	Ignored
Modes 24-29 Both Sweeps	All Channels	Ignored	Applied	Ignored	Ignored

RATIO Key

Function. The RATIO key makes the individual channel generate a whole-number (no fractions) multiple of the main generator frequency as shown in figure 5-4. The **Main** key determines the main generator frequency.

Parameter Limits. 1 to 99. Ratio cannot make the channel frequency exceed 2MHz.

Errors. An illegal ratio will generate one of these error messages:

*** ratio: limit error ***
 *** (freq × ratio) > 2-MHz***

SHIFT KEY

See section 5.3.1 above.

5.4 **Trigger** KEY MENU TREE

This part provides detailed operating instructions for the **Trigger** menu tree (see figure 5-7).

5.4.1 Overall Operation

Trigger Types. The 650 accepts four types of input triggers:

- Internal trigger (generated by the 650)
- External trigger (applied to the **Trig In** connector)
- Manual trigger (press the **Manual Trigger** key)
- GPIB trigger (sent over the GPIB bus; see section 6)

External Triggers. The following table shows the three types of external trigger signals accepted by the 650 and the modes that require them.

The Trig In connector accepts these signals	To control these modes
Trigger signal	Main TRIG and BURST modes All triggered sweep modes
Gate (key) signal	Main A-GATE and S-GATE modes Sweep S-FSK and A-FSK modes
Phase lock signal	Main PHSK mode

SHIFTED WAVEFORM
LEADS
REF WAVEFORM BY
+ 90 DEGREES OR
- 250 MICROSECONDS*

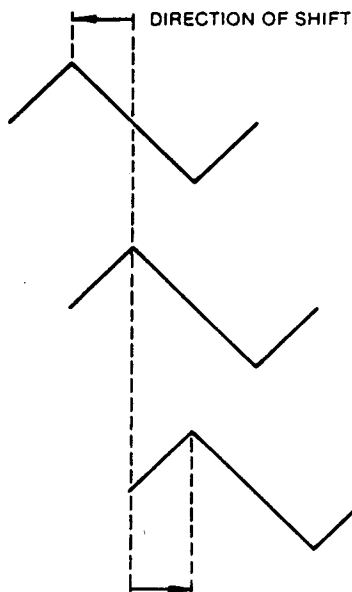

←
SHIFTED WAVEFORM

REFERENCE WAVEFORM

→
SHIFTED WAVEFORM

SHIFTED WAVEFORM
LAGS
REF WAVEFORM BY
- 90 DEGREES OR
+ 250 MICROSECONDS*

*Only for a 1KHz waveform

Figure 5-6. Phase Shift Sign Conventions

Output Trigger Signals. The 650 provides an output copy of the input trigger signal for triggering other instruments. This output trigger appears at the **Marker Out** connector and depends on the mode and the type of input trigger as shown below. The **Marker Out** trigger signal does not reflect the trigger menu slope setting.

The Marker Out connector provides these signals	As outputs from these modes
Internal or External Trigger Signal	Main modes 1-4 Frequency sweep modes 7-9 Phase sweep mode 19 Both sweep mode 26
Internal Trigger Signal	Frequency sweep modes 10-11 Phase sweep modes 20-21 Both sweep modes 27-28

5.4.2 Soft Key Operation

Action

Choose internal trigger
Set internal trigger frequency
Choose external trigger
Generate a front panel trigger
Specify trigger signal trip level
Specify trigger signal trip slope

Keystrokes

Trigger INTRNL
Trigger FREQ (enter frequency)
Trigger EXTRNL
Press the **Manual Trigger** key
Trigger LEVEL (enter voltage level)
Trigger, then POS (positive-going signal) or NEG (negative-going signal)

TRIGGER

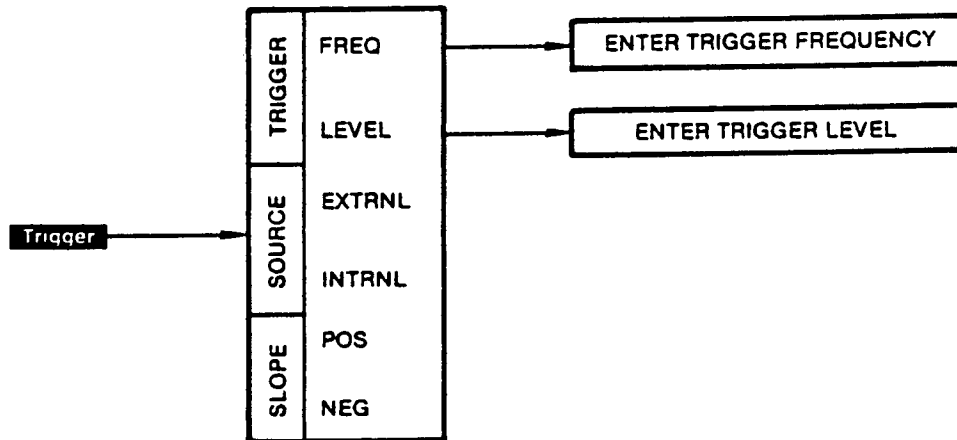

FREQ
LEVEL
EXTRNL
INTRNL
POS
NEG

Enables entry of a frequency for the internal trigger.
Enables entry of a numeric value for the trigger or gate threshold voltage.
Selects external trigger source (external signal or **Manual Trigger** key).
Selects internal trigger source.
Selects triggering on rising slope of external trigger signal.
Selects triggering on falling slope of external trigger signal.

Figure 5-7. **Trigger** Key Menu Tree

5.5 Sweep KEY MENU TREE

This section provides detailed operating instructions for the Sweep key menu tree.

Section	Function	Page
5.5.1 Overall Operation	Describes the aspects of sweep operation that affect several modes or keys. Shows the sweep menu tree, lists all the sweep modes, defines the menu terminology, and lists the mode-dependent output and monitor functions.	5-13
5.5.2 Soft Key Operation	Describes the CENTER/SPAN, START/STOP, COMP, FUNC, MARKER, and MONIT keys.	5-17
5.5.3 Continuous Sweeps	Describes the continuous sweep modes (1, 2, 13, 14, and 24).	5-22
5.5.4 Triggered Sweeps	Describes the triggered sweep modes (3-6, 15-18, and 25).	5-24
5.5.5 FSK Sweeps	Describes the frequency-shift-keyed sweep modes (7 and 8).	5-26
5.5.6 Sequenced Sweeps	Describes the sequenced sweep modes (9-11, 19-21, 26-28).	5-27
5.5.7 FM and PM Sweeps	Describes the frequency modulated and phase modulated sweep modes (12, 23, 29).	5-31
5.5.8 Delta-Freq Sweep	Describes the delta-frequency sweep mode (22).	5-35

5.5.1 Overall Operation

This section provides an overview of sweep operation and describes the aspects of sweep operation that affect several modes or keys. Figure 5-8 shows the Sweep key menu tree, while table 5-2 explains the sweep menu terminology and summarizes the 29 sweep modes.

Sweep Setup Procedure. See the Sweep key description in section 4 of this manual for the step-by-step procedure required to set up a sweep mode.

What Determines the Output Frequency? The frequency entered in the Main FREQ menu determines the output frequency of all channels in the main (non-sweep) and phase-sweep operating modes. The start and stop frequencies entered in the Sweep FREQ LIMITS menu determine the output frequency of all channels in the frequency-sweep and both-sweep modes.

How Does Sweeping Affect PHASE and DELAY? Some combinations of sweep mode and sweep compensation will not allow application of the Channel PHASE and DELAY parameters. Table 5-1 in section 5.3.2 tells when the 650 applies PHASE and DELAY.

How Does Sweeping Affect Outputs and Monitors? The sweep mode determines the specific outputs of the rear-panel Horiz Out and Marker Out connectors and the particular frequency and phase values displayed on-screen by the Sweep monitors. Table 5-3 lists the outputs and displays provided by each sweep mode.

How Do You Make the 650 Start Sweeping? After entering all the parameters for a sweep, start the sweep by stepping through the sweep menu tree to the sweep's mode number. When you press the last key in the series, the sweep will start. For triggered sweep modes, pressing the last key will make the sweep start accepting triggers. For example, suppose you want to start mode 14 (continuous phase sweep with automatic reverse). First, find mode number 14 in figure 5-8, the sweep menu tree. Next, enter the following keystroke series to step through the tree to mode number 14: Sweep PHASE MODE CONT REVERS.

How Do you Make the 650 Stop Sweeping? To stop one sweep, start another. To stop all sweeping, enter this keystroke series: Sweep OFF.

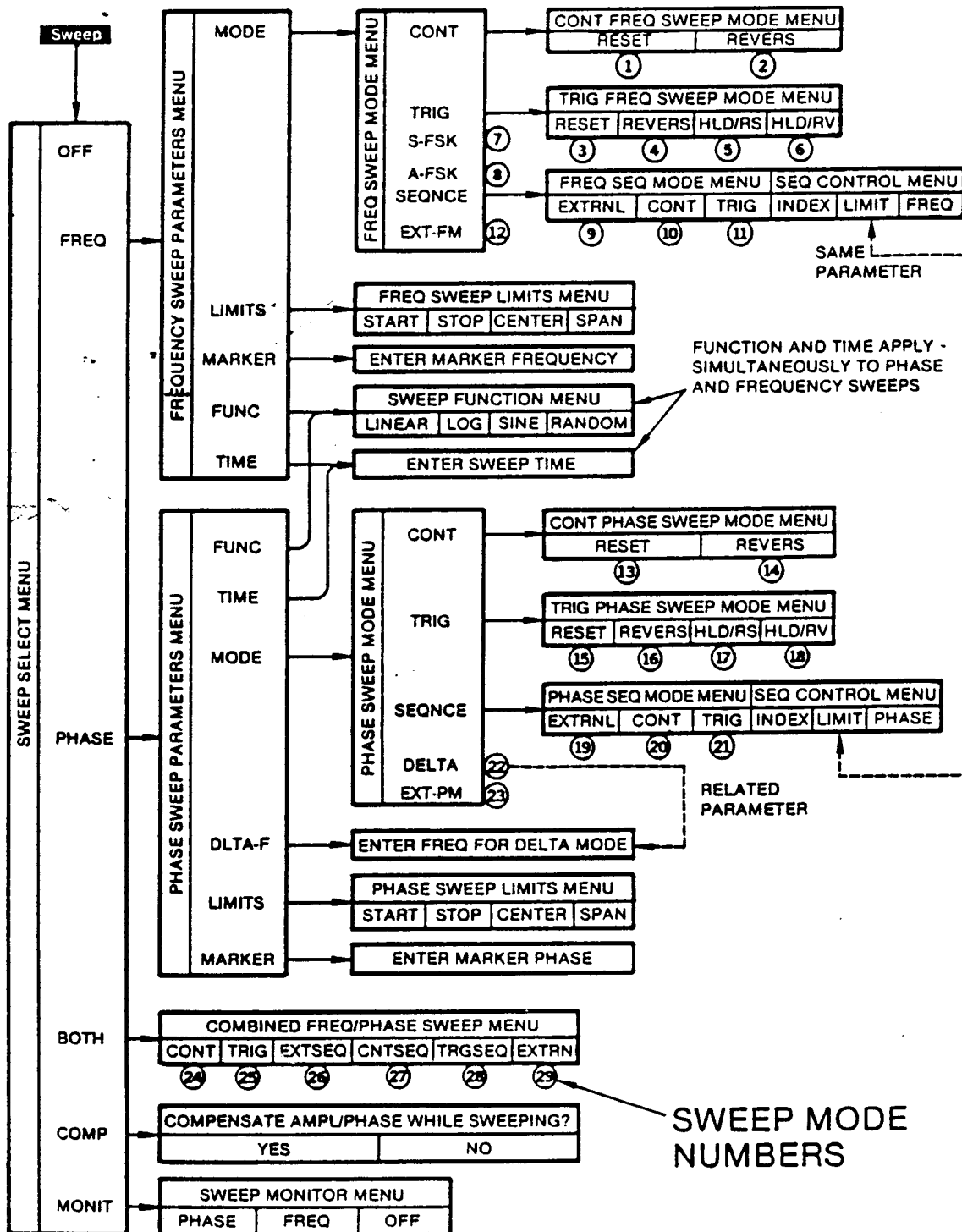

Figure 5-8. Sweep Key Menu Tree

Table 5-2. Sweep Menu Modes and Terminology

LIST OF SWEEP MODES

Sweep Mode	— Mode Numbers —			Brief Description
	Freq	Phase	Both	
CONT-RESET	1	13	24	Continuous sweep with automatic reset.
CONT-REVERSE	2	14	—	Continuous sweep with automatic reverse.
TRIG-RESET	3	15	—	Triggered sweep with automatic reset.
TRIG-REVERSE	4	16	—	Triggered sweep with automatic reverse.
TRIG-HOLD-RESET	5	17	25	Triggered sweep/hold, triggered reset/hold.
TRIG-HOLD-REV	6	18	—	Triggered sweep/hold, triggered reverse/hold
SYNC-FSK	7	—	—	Frequency shifts on next zero crossing after trigger.
ASYNCFSK	8	—	—	Frequency shifts immediately on trigger.
EXTR-SEQUENCE	9	19	26	Trigger causes jump to next step in sequence.
CONT-SEQUENCE	10	20	27	Continuous stepping through sequence.
TRIG-SEQUENCE	11	21	28	Trigger causes one pass through sequence.
EXTERNAL-FM	12	—	—	External signal frequency modulates output.
EXTERNAL-PM	—	23	—	External signal phase modulates output.
EXTERNAL-FM/PM	—	—	29	External signal frequency and phase modulates output.
DELTA-FREQ	—	22	—	Shifts frequency of one channel by DELTA-F

FREQ modes sweep the frequency of all channels simultaneously.
 PHASE modes sweep the phase of one selected channel.
 BOTH modes sweep both frequency and phase of all channels.

SWEEP MENU TERMINOLOGY

- CENTER/SPAN Enables entry of sweep limits in terms of CENTER/SPAN parameters.
- COMP Selects compensation of amplitude and phase errors during sweep.
- DELTA Shifts the output frequency of one channel by the amount DELTA-F.
- FUNC Determines the sweep function: linear, log, random, sine.
- INDEX Enables entry of a reference number for each phase or frequency step in a series of discrete phase or frequency steps.
- LIMIT Enables entry of a number that specifies the highest index number programmed in a sequence of phase or frequency steps.
- LIMITS Causes display of the sweep limits menu.
- MARKER Enables entry of the phase or frequency value that will cause the **Marker Out** connector to change level.
- MODE Causes display of the sweep mode menus. Each mode generates a specific sweep behavior. The 650 has 29 sweep modes (listed above).
- MONIT Enables the display on-screen of the current value of the phase or frequency as a sweep progresses.
- START/STOP Enables entry of the sweep limits in terms of START and STOP parameters (START can exceed STOP in value).
- TIME Enables entry of a numeric value for sweep time for the continuous and triggered sweep modes. Determines, with LIMIT, the time per step in sequenced modes.

Table 5-3. Mode-Dependent Output and Monitor Functions

Sweep Mode		Main Mode	Horiz Output	Marker Output	Frequency Monitor	Phase Monitor
Main Modes	0) Off	1) Continuous 5) Phase Locked	0 V	Low	Main Frequency	Phase Offset of Selected Channel
		1) Triggered 2) Async Gate 3) Sync Gate 4) Burst		Internal or External Trigger Signal ¹		
Frequency Sweep Modes	1) Cont-Reset 2) Cont-Reverse 3) Trig-Reset 4) Trig-Reverse 5) Trig-Hold-Rst 6) Trig-Hold-Rev	Don't Care	0 to 10 V ²	Low: $F < F_{Marker}$ High: $F > F_{Marker}$	Current Frequency	Phase Offset of Selected Channel
	7) Syn-Fsk 8) Asyn-Fsk		0 V	Internal or External Trigger Signal ¹	0 Hz	
	9) Extr-Seq			Internal Trigger ¹	Current Frequency	
	10) Cont-Seq 11) Trig-Seq		0 to 10 V ²	Low: $F < F_{Marker}$ High: $F > F_{Marker}$		
	12) External-FM					
Phase Sweep Modes	13) Cont-Reset 14) Cont-Reverse 15) Trig-Reset 16) Trig-Reverse 17) Trig-Hold-Rst 18) Trig-Hold-Rev	Don't Care	0 to 10 V ²	Low: $\downarrow < \uparrow_{Marker}$ High: $\uparrow > \downarrow_{Marker}$	Main Frequency	Current Phase of Selected Channel
	19) Extr-Seq		0 V	Int or Ext Trigger ¹		
	20) Cont-Seq 21) Trig-Seq			Internal Trigger ¹		
	22) Delta-Freq ³		0 to 10 V ²	Low: $\downarrow < \uparrow_{Marker}$ High: $\uparrow > \downarrow_{Marker}$		
	23) External-PM					
Both Sweep Modes	24) Cont-Reset 25) Trig-Hold-Rst	Don't Care	0 TO 10 V ²	Low: $F < F_{Marker}$ High: $F > F_{Marker}$	Current Frequency	Current Phase of Selected Channel
	26) Extr-Seq		0 V	Int or Ext Trigger ¹		
	27) Cont-Seq 28) Trig-Seq			Internal Trigger ¹		
	29) Ext-FM/PM		0 to 10 V ²	Low: $F < F_{Marker}$ High: $F > F_{Marker}$		

1) The Internal/External Trigger Signal at the marker output does not reflect the trigger's slope setting.
 2) 0 to 10 V for startparameter \leq stopparameter, 10 to 0 V for startparameter $>$ stopparameter.
 3) Delta frequency continuously sweeps phase over 360 degrees.

5.5.2 Soft Key Operation

This section describes the CENTER/SPAN, START/STOP, COMP, FUNC, MARKER, and MONIT keys.

CENTER/SPAN and START/STOP Keys

Function. These four keys provide two ways to set the sweep limits.

The CENTER and SPAN keys work together to set the center frequency (or phase) and span of a sweep. For example, a CENTER frequency of 5000 Hz and a SPAN of 2000 Hz would cause a sweep from 4000 Hz to 6000 Hz.

The START and STOP keys work together to set the start and stop frequencies (or phases) of a sweep. For example, a START frequency of 2000 Hz and a STOP frequency of 4000 Hz would cause a sweep from 2000 Hz to 4000 Hz. The START frequency can exceed the STOP frequency. For example, a START frequency of 8000 Hz and a STOP frequency of 5000 Hz would cause a sweep from 8000 Hz to 5000 Hz.

COMP Key

Function. The COMP key dynamically compensates for the channel-dependent and frequency-dependent amplitude and phase errors caused by each channel's low-pass filter and output amplifier.

Operation. The 650 powers up with compensation active. Use the COMP key to turn it off and on.

When Should You Compensate Sweeps? Amplitude and phase errors increase with frequency. The following table indicates how far the output amplitude and phase can deviate from the programmed values. Use this table to determine if your application requires compensation.

What Sweeps Require Compensation? Every sweep mode that changes frequency during the sweep may require compensation for frequency-dependent errors. Phase sweeps require compensation because you can change the MAIN frequency at any time during the sweep. Only the SYNC-FSK, ASYNC-FSK, and DELTA-FREQ sweeps (modes 7, 8, and 22) require no compensation.

How Does the 650 Generate Sweeps? The 650 does not continuously vary frequency or phase. Instead, it delivers a series of fixed frequencies or phases. This holds true for continuous, sequenced, and modulated sweeps.

Continuous Sweeps. To sweep continuously, the 650 delivers a series of frequencies or phases, each just slightly larger (or smaller) than the last one. For example, to sweep from 300 to 400 kHz in one second, the 650 would first deliver 300,000 Hz for 75 microseconds, then jump to 300,007.5 Hz for 75 microseconds, then jump to 300,015 Hz for 75 microseconds, and so forth through 13,333 steps to 400 KHz.

Sequence Sweeps. To sweep through a sequence of frequencies or phases, the 650 steps sequentially through a table of frequency or phase values entered by the operator. It holds each value in the table for T seconds, where T equals the total sweep time divided by the number of steps (the sequence limit).

Modulated Sweeps. To make the voltage level of an external signal control the output frequency or phase, the 650 samples that signal at a fixed rate. It converts the voltage of the signal at each sample into a corresponding frequency or phase, then delivers that frequency or phase until the next sample. The operator determines the correspondence by entering a START phase or frequency for - 1 volts and a STOP phase or frequency for + 1 volts.

Frequency	Amplitude		Phase	
	Uncompensated (Typical)	Compensated (Specified)	Uncompensated (Typical)	Compensated (Specified)
10kHz	± 1%	± 0.5%	± 0.1°	± 0.03°
100kHz	± 3%	± 0.5%	± 1°	± 0.1
1MHz	± 7%	± 1.5%	± 10°	± 0.5°
2MHz	± 10%	± 3.0%	± 20°	± 1.0°

Phase values assume equal channel amplitudes.

What Effect Does Compensation Have on Sweeps?

Compensation greatly reduces the number of steps in a sweep. Without compensation, the 650 just needs to determine the frequency or phase it must generate for the next step. With compensation, the 650 must 1) determine the frequency or phase, 2) perform a long series of compensation calculations, and 3) perform the channel DELAY calculations.

How Can You Determine the Exact Resolution of a Specific Sweep?

Table 5-4 gives the uncompensated and compensated step rates of all sweeps in terms of steps per second. The following examples show how to use the table to determine specific rates for specific sweeps.

EXAMPLE 1 Sweep Mode 1: Linear frequency sweep from 200kHz to 350kHz in 2 seconds.

Comp Off

$$\frac{350\text{kHz} - 200\text{kHz}}{(13,333 \text{ steps/sec})(2 \text{ sec})} = \frac{150\text{kHz}}{26666 \text{ steps}} = 5.6 \text{ Hz/step}$$

$$(1 \text{ second})/(13333 \text{ steps}) = 75 \text{ microseconds/step}$$

Comp On

$$\frac{350\text{kHz} - 200\text{kHz}}{(1143 \text{ steps/sec})(2 \text{ sec})} = \frac{150\text{kHz}}{2286 \text{ steps}} = 65.6 \text{ Hz/step}$$

$$(1 \text{ second})/(1143 \text{ steps}) = 875 \text{ microseconds/step}$$

EXAMPLE 2 Sweep Mode 14: Linear phase sweep from 60 to 180 degrees in 0.1 seconds.

Comp Off

$$\frac{180 - 60 \text{ degrees}}{(20000 \text{ steps/sec})(0.1 \text{ sec})} = \frac{120 \text{ degrees}}{2000 \text{ steps}} = 0.06 \text{ degrees/step}$$

$$(1 \text{ second})/(20000 \text{ steps}) = 50 \text{ microseconds/step}$$

Comp On

$$\frac{180 - 60 \text{ degrees}}{(1176 \text{ steps/sec})(0.1 \text{ sec})} = \frac{120 \text{ degrees}}{117.6 \text{ steps}} = 1.02 \text{ degrees/step}$$

$$(1 \text{ second})/(1176 \text{ steps}) = 850 \text{ microseconds/step}$$

EXAMPLE 3 Sweep Mode 11: Triggered sequence of frequencies. Upon receipt of a trigger, step through a sequence table of 50 frequencies in 0.02 seconds.

$$\text{Time/Step} = \frac{\text{SWEEP TIME}}{\text{SEQUENCE LIMIT}} = \frac{0.02 \text{ seconds}}{50 \text{ steps}}$$

$$= 400 \text{ microseconds/step}$$

Comp Off: (1 second)/(37000 steps) = 27 microseconds/step

Comp On: (1 second)/(1209 steps) = 827 microseconds/step

Because the compensation calculations take 827 microseconds/step while the sweep time and sequence limit allow only 400 microseconds per step, the 650 cannot compensate this sweep. If you turn compensation on, the error message ** swptime 50 msec min when comp on ** will appear. A sweep time of 50 milliseconds would yield 1000 microseconds/step and give enough time for the compensation calculations.

EXAMPLE 4 Sweep Mode 12: External-FM. Establish the output frequency range of the 650 by entering START and STOP frequency values. Sweep between these values by applying a 2V peak-to-peak modulation signal to the FM/PM In connector. What parameters will limit the maximum modulation frequency?

Comp ON sample rate: 1,179 times per second

Comp OFF sample rate: 20,800 times per second

The 650 repeatedly samples the input modulation signal and converts the voltage level at each sample into the next step in output frequency. +1V produces the start frequency, while -1V produces the stop frequency. Output frequency resolution therefore depends on the number of samples per cycle of the modulation signal, the spread between the start and stop frequencies, and the frequency of the modulation signal.

Compensation ON. Assume that an application requires at least 10 samples per cycle of a sinusoidal modulation signal. Therefore, the compensation ON sample rate limits the modulation frequency to less than 118 Hz. Because a sine wave changes from maximum amplitude to minimum amplitude in one-half cycle, a modulation signal of 118 Hz would make the 650 sweep from the start to the stop frequency in five steps.

Compensation OFF. If the application still requires at least 10 samples per cycle, then the compensation OFF sample rate would limit the maximum modulation frequency to less than 2080 Hz. A modulation frequency of 2080Hz would make the 650 output sweep from the start to the stop frequency in five steps.

Table 5-4. Step Rates of Compensated and Uncompensated Sweeps

	Method of Determining the Next Frequency or Phase					
	Linear	Log	Sine	Random	Seqnce	ExtMod
Mode	Comp Off/On	Comp Off/On	Comp Off/On	Comp Off/On	Comp Off/On	Comp Off/On
01 F:Cont-Reset	13333/1143	4167/962	6667/1053	15400/1156	—	—
02 F:Cont-Reverse	13333/1143	4167/962	6667/1053	15400/1156	—	—
03 F:Trig-Reset	13333/1143	4167/962	6667/1053	15400/1156	—	—
04 F:Trig-Reverse	13333/1143	4167/962	6667/1053	15400/1156	—	—
05 F:Trig-Hld-Rst	13333/1143	4167/962	6667/1053	15400/1156	—	—
06 F:Trig-Hld-Rev	13333/1143	4167/962	6667/1053	15400/1156	—	—
09 F:Extr-Sequence	—	—	—	—	42000/1214	—
10 F:Cont-Sequence	—	—	—	—	38000/1210	—
11 F:Trig-Sequence	—	—	—	—	37000/1209	—
12 F:External-FM	—	—	—	—	—	20800/1179
13 P:Cont-Reset	20000/1176	5263/1010	7143/1064	22200/1183	—	—
14 P:Cont-Reverse	20000/1176	5263/1010	7143/1064	22200/1183	—	—
15 P:Trig-Reset	20000/1176	5263/1010	7143/1064	22200/1183	—	—
16 P:Trig-Reverse	20000/1176	5263/1010	7143/1064	22200/1183	—	—
17 P:Trig-Hld-Rst	20000/1176	5263/1010	7143/1064	22200/1183	—	—
18 P:Trig-Hld-Rev	20000/1176	5263/1010	7143/1064	22200/1183	—	—
19 P:Extr-Sequence	—	—	—	—	70000/1228	—
20 P:Cont-Sequence	—	—	—	—	61000/1225	—
21 P:Trig-Sequence	—	—	—	—	58000/1224	—
23 P:External-PM	—	—	—	—	—	25000/1190
24 B:Cont-Reset	6667/1053	—	—	—	—	—
25 B:Trig-Hld-Rst	6667/1053	—	—	—	—	—
26 B:Extr-Sequence	—	—	—	—	24000/1188	—
27 B:Cont-Sequence	—	—	—	—	23000/1186	—
28 B:Trig-Sequence	—	—	—	—	22000/1183	—
29 B:Ext-FM/PM	—	—	—	—	—	5100/1004
Units	Steps/sec	Steps/sec	Steps/sec	Steps/sec	Steps/sec	Smples/sec

How Does Compensation Guarantee Accuracy?

Manual calibration, automatic calibration, and compensation work together as follows.

Manual Calibration. Manual calibration calibrates the 10 MHz reference oscillator and the reference voltage source. The 10 MHz oscillator determines the frequency and phase accuracy of the output signals; the reference voltage determines the amplitude accuracy. Manual calibration also brings the output amplitude and filter flatness of each channel into the range of automatic calibration.

Automatic Calibration. Auto calibration uses the internal voltmeter and phase detector to measure the amplitude and phase errors of each channel at 13 frequency points from 156kHz to 2MHz. It then calculates compensation values for these points and stores them in the compensation table.

Compensation. Power-up activates the compensation program. It remains active until you turn it off with the COMP key. When active, it interpolates the autocal compensation table to determine and apply separate amplitude and phase correction values to every channel for every step of a sweep.

FUNC KEY

The FUNC key determines the instantaneous rate of change (of frequency or phase) as the sweep progresses from start to finish. The linear, log, sine, and random rate-change functions apply only to the sweeps listed in table 5-5 and selectively to those sweeps as shown.

MARKER KEY

Function. The marker function tells you when a sweep has reached a particular value. For example, if your application calls for a sweep from 1,000 Hz to 12,000 Hz, you can ask the 650 to signal when the frequency reaches 11,507 Hz.

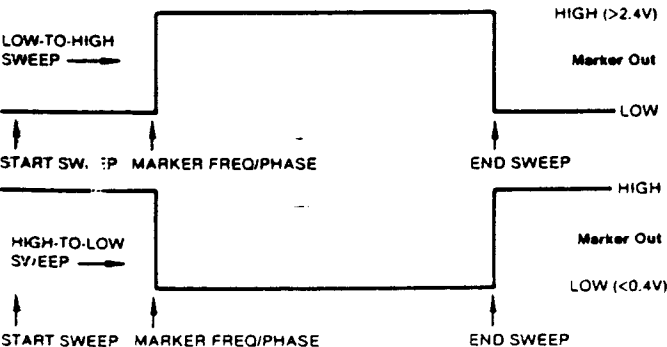

The marker function consists of the MARKER key and the **Marker Out** connector. The MARKER key determines the "marked" frequency or phase within the sweep range. The **Marker Out** connector on the rear panel will change voltage levels when the sweep reaches the marked frequency or phase.

Restrictions. The 650 provides the marker function for the following sweep modes. Table 5-3 shows the outputs of the **Marker Out** connector for the other modes.

- Modes 1-6 (continuous and triggered frequency sweeps)
- Mode 12 (external-FM)
- Modes 13-18 (continuous and triggered phase sweeps)
- Mode 22 (delta frequency)
- Mode 23 (external-PM)
- Mode 29 (external-FM/PM)

Operation. Set up the sweep as usual, then enter a marker frequency or phase with these keystrokes:

- Sweep** FREQ MARKER (enter marker frequency)
- Sweep** PHASE MARKER (enter marker phase)

MONIT KEY

Function. The monitor displays the instantaneous value of frequency or phase as sweeps progress. The monitor appears on the second line of the screen:

```
monitor freq: 000,000.0000 Hz
monitor phase: 0,000,000.000 Deg
```

Restrictions. The frequency monitor displays either the main frequency or the current frequency, depending on the active main or sweep mode. The phase monitor displays either the phase offset or the current phase of the selected channel, depending on the active main or sweep mode. (Select channels with the **Channel Number** key.) Table 5-3 shows the monitor display for each mode.

Operation. Turn the monitors on and off with these keystrokes:

- Freq Sweep Monitor On: **Sweep** MONIT FREQ
- Phase Sweep Monitor On: **Sweep** MONIT PHASE
- Either Monitor Off: **Sweep** MONIT OFF

Table 5-5. Sweep Functions Available for Each Sweep Mode

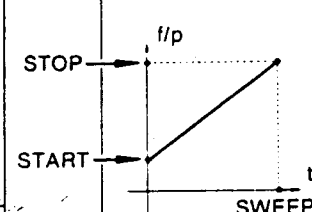
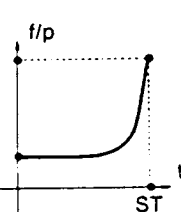
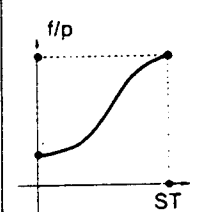
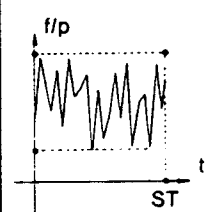
		Sweep Function			
		Linear	Log	Sine	Random
Mode	Name				
01	Freq:Cont-Reset	•	•	•	•
02	Freq:Cont-Reverse	•	•	•	•
03	Freq:Trig-Reset	•	•	•	•
04	Freq:Trig-Reverse	•	•	•	•
05	Freq:Trig-Hold-Reset	•	•	•	•
06	Freq:Trig-Hold-Reverse	•	•	•	•
13	Phase:Cont-Reset	•	•	•	•
14	Phase:Cont-Reverse	•	•	•	•
15	Phase:Trig-Reset	•	•	•	•
16	Phase:Trig-Reverse	•	•	•	•
17	Phase:Trig-Hold-Reset	•	•	•	•
18	Phase:Trig-Hold-Reverse	•	•	•	•
24	Both:Cont-Reset	•	N/A	N/A	N/A
25	Both:Trig-Hold-Reset	•	N/A	N/A	N/A

5.5.3 Continuous Sweeps

This section describes the continuous sweep modes.

Action. Continuous sweeps begin sweeping when you start them and run without stopping until you turn them off.

Modes. The 650 provides five continuous sweep modes:

Name	Mode Numbers			Description
	Freq	Phse	Both	
Cont-Reset	1	13	24	Continuous sweep with automatic reset.
Cont-Rev	2	14	—	Continuous sweep with automatic reverse.

Parameters. Enter continuous sweep parameters with the following keystrokes. STOP can exceed START (upsweep) or START can exceed STOP (downsweep).

- START Frequency **Sweep** FREQ LIMITS START (enter start frequency)
- STOP Frequency **Sweep** FREQ LIMITS STOP (enter stop frequency)
- START Phase **Channel Number** X **Sweep** PHASE LIMITS START (enter start phase)
- STOP Phase **Channel Number** X **Sweep** PHASE LIMITS STOP (enter stop phase)
- Sweep FUNC **Sweep** FREQ FUNC (choose linear, log, sine, or random)
- Main FREQ **Main** FREQ (enter main frequency)
- Sweep TIME **Sweep** FREQ (or PHASE) TIME (enter sweep time)

The following charts show the parameters required by each continuous sweep mode. The large blocks that span all channels identify parameters that control all channels simultaneously, while the channel-height blocks identify parameters that control individual channels.

Continuous Frequency Sweeps. Modes 1 and 2 simultaneously sweep all channels between the START and STOP frequency limits.

MODE 1-2 PARAMETERS

CH 1	START FREQ	STOP FREQ	SWEEP FUNC	SWEEP TIME
CH 2				
CH 3				
CH 4				

MODE 1: FREQUENCY-CONTINUOUS-RESET

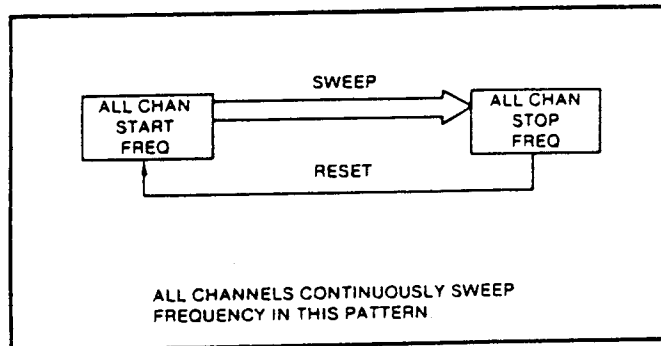

MODE 2: FREQUENCY-CONTINUOUS-REVERSE

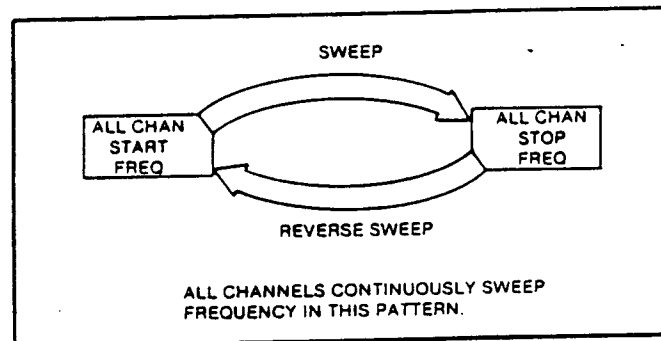

Continuous Phase Sweeps. Modes 13 and 14 sweep one selected channel between its START and STOP phase limits. You can enter START and STOP phase limits in the selected channel and sweep it, or you can enter limits in all the channels and select them as needed. Select channels with **Channel Number** X **Execute**.

MODE 13-14 PARAMETERS

CH 1	START PHASE	STOP PHASE	MAIN FREQ	SWEEP FUNC	SWEEP TIME
CH 2	START PHASE	STOP PHASE			
CH 3	START PHASE	STOP PHASE			
CH 4	START PHASE	STOP PHASE			

MODE 13: PHASE-CONTINUOUS-RESET

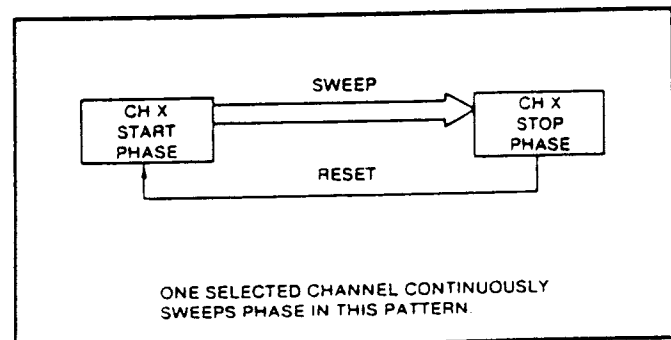

MODE 14: PHASE-CONTINUOUS-REVERSE

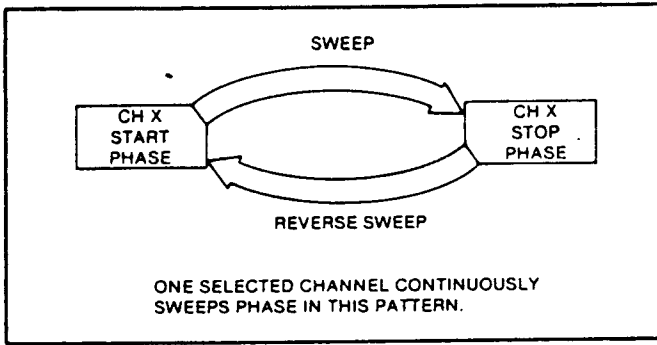

Continuous Both Sweep. Mode 24 simultaneously sweeps all channels between the START and STOP frequency limits and, at the same time, individually sweeps all channels between their respective START and STOP phase limits. You **must** enter START and STOP phase limits in every channel. Enter START = STOP = 0 (or some other value) to make a channel not sweep phase. For example, entering START = STOP = 120° would make a channel not sweep phase and give it a fixed phase of 120° with respect to the main frequency.

Starting the Sweep. After you have entered all the parameters for a continuous sweep, start the sweep by stepping through the sweep menus to the correct mode number as follows:

Mode Keystroke Series

- 1 Sweep FREQ MODE CONT RESET
- 2 Sweep FREQ MODE CONT REVERS
- 13 Sweep PHASE MODE CONT RESET
- 14 Sweep PHASE MODE CONT REVERS
- 24 Sweep BOTH CONT

Examples. Sections 4.7.3, 4.7.4, and 4.7.5 set up continuous sweeps step-by-step.

MODE 24 PARAMETERS

CH 1	START PHASE	STOP PHASE	START FREQ	STOP FREQ	SWEEP TIME
CH 2	START PHASE	STOP PHASE			
CH 3	START PHASE	STOP PHASE			
CH 4	START PHASE	STOP PHASE			

MODE 24: BOTH-CONTINUOUS-RESET

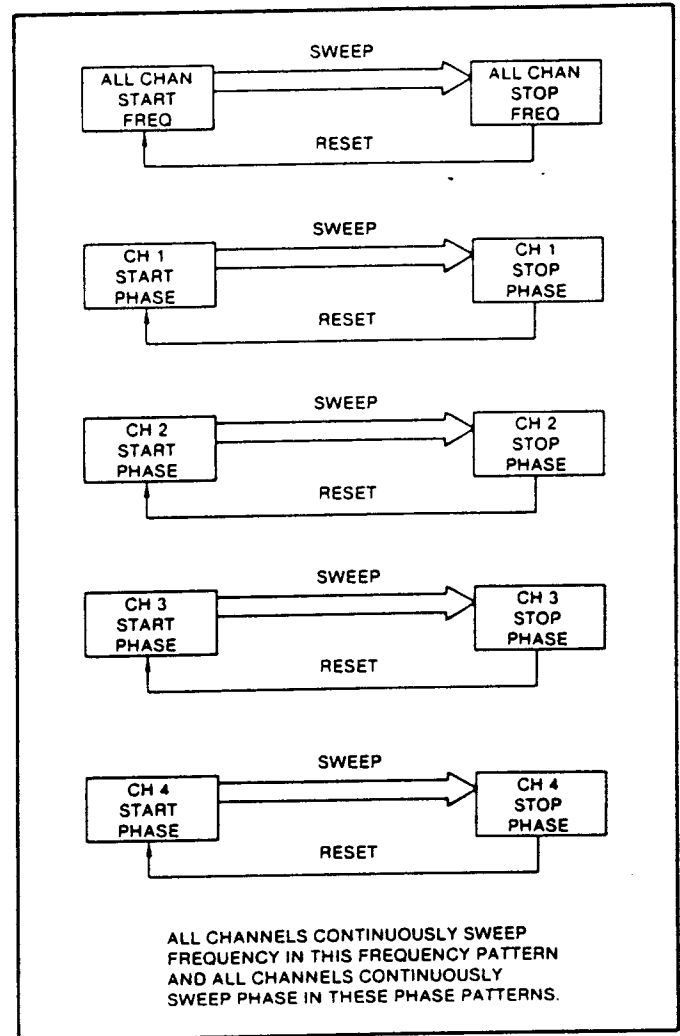

5.5.4 Triggered Sweeps

This section describes the triggered sweep modes.

Action. Triggered sweeps perform their sweep action when directed to by a trigger.

Allowable Triggers. The triggered sweeps accept front panel triggering (press the **Manual Trigger** key), external signal triggering (connect to the **Trig In** connector), and triggering over the GPIB bus. Because the same oscillator provides both the internal trigger and the sweep clock, you cannot internally trigger the triggered sweep modes.

Modes. The 650 provides nine triggered sweep modes:

Name	Mode Numbers			Description
	Freq	Phase	Both	
Trig-Reset	3	15	—	Triggered sweep with automatic reset.
Trig-Rev	4	16	—	Triggered sweep with automatic reverse.
Trig-Hold-Reset	5	17	25	Triggered sweep/hold, triggered reset/hold.
Trig-Hold-Rev	6	18	—	Triggered sweep/hold, triggered reverse/hold.

Parameters. Enter triggered sweep parameters with the following keystrokes. The 650 always sweeps from START to STOP. You can sweep up (set START less than STOP) or down (set START greater than STOP).

- START Frequency **Sweep** FREQ LIMITS START (enter start frequency)
- STOP Frequency **Sweep** FREQ LIMITS STOP (enter stop frequency)
- START Phase **Channel Number** X **Sweep** PHASE LIMITS START (enter start phase)
- STOP Phase **Channel Number** X **Sweep** PHASE LIMITS STOP (enter stop phase)
- Sweep FUNC **Sweep** FREQ FUNC (choose linear, log, sine, or random)
- Main FREQ **Main** FREQ (enter main frequency)
- Sweep TIME **Sweep** FREQ (or PHASE) TIME (enter sweep time)
- Trigger **Trigger** (enter trigger setup as required)
- or- **Manual Trigger** (press as required)

The following charts show the parameters required by each triggered sweep mode. The large blocks that span all channels identify parameters that control all channels simultaneously, while the channel-height blocks identify parameters that control individual channels.

Triggered Frequency Sweeps. When triggered, modes 3-6 simultaneously sweep all channels between the START and STOP frequency limits.

MODE 3-6 PARAMETERS

CH 1	START FREQ	STOP FREQ	SWEEP FUNC	SWEEP TIME	TRIGGER
CH 2					
CH 3					
CH 4					

MODE 3: FREQUENCY-TRIGGERED-RESET

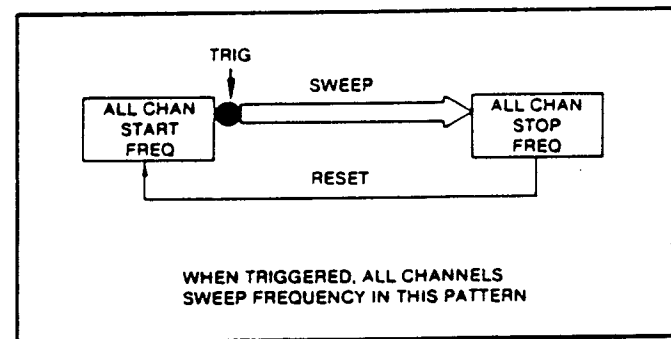

MODE 4: FREQUENCY-TRIGGERED-REVERSE

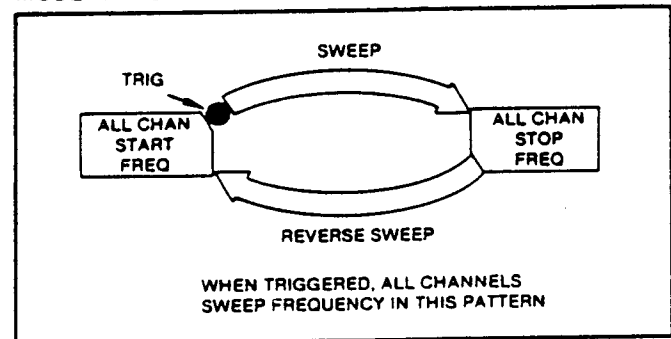

MODE 5: FREQUENCY-TRIGGERED-HOLD-RESET

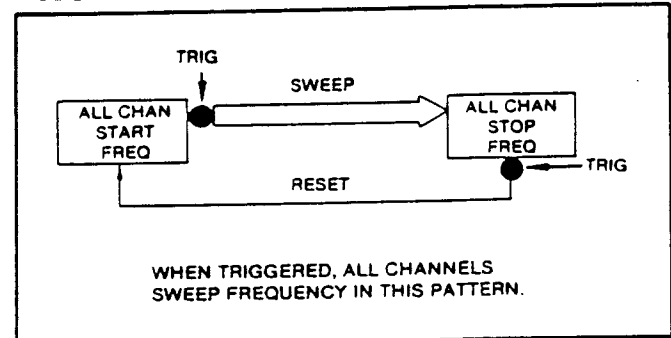

MODE 6: FREQUENCY-TRIGGERED-HOLD-REVERSE

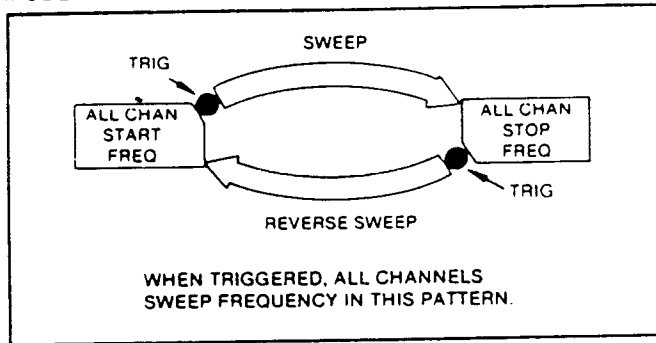

MODE 17: PHASE-TRIGGERED-HOLD-RESET

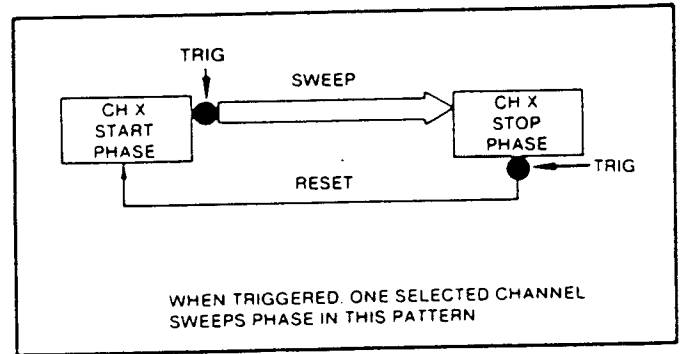

Triggered Phase Sweeps. When triggered, modes 15-18 sweep one selected channel between its START and STOP phase limits. You can enter START and STOP phase limits in the selected channel and trigger the sweep, or you can enter limits in all the channels and select and trigger them as needed. Select channels with **Channel Number X Execute**.

MODE 18: PHASE-TRIGGERED-HOLD-REVERSE

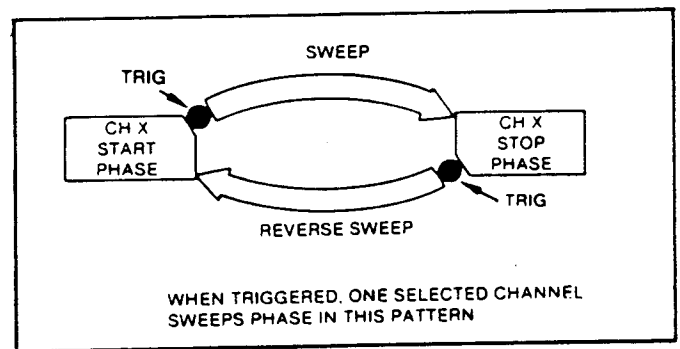

MODE 15-18 PARAMETERS

CH 1	START PHASE	STOP PHASE	MAIN FREQ	SWEEP FUNC	SWEEP TIME	TRIGGER (DRIVES ONLY CH X)
CH 2	START PHASE	STOP PHASE				
CH 3	START PHASE	STOP PHASE				
CH 4	START PHASE	STOP PHASE				

MODE 15: PHASE-TRIGGERED-RESET

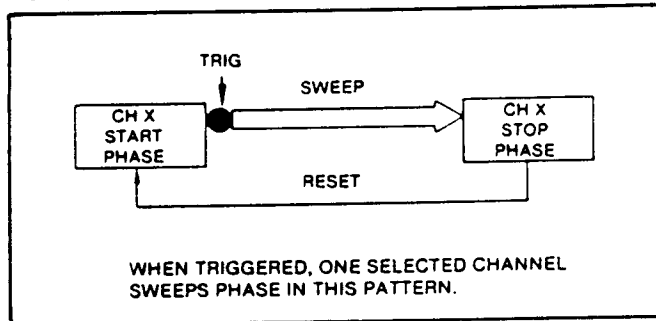

MODE 16: PHASE-TRIGGERED-REVERSE

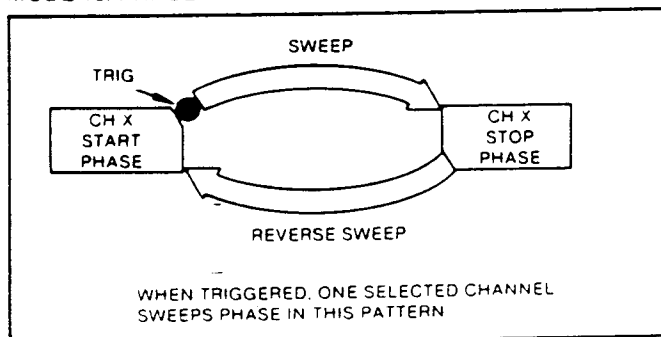

Triggered Both Sweep. When triggered, mode 25 simultaneously sweeps all channels between the START and STOP frequency limits and, at the same time, individually sweeps all channels between their respective START and STOP phase limits. You **must** enter START and STOP phase limits in every channel. Enter START = STOP = 0 (or some other value) to make a channel not sweep phase. For example, entering START = STOP = 120° would make a channel not sweep phase and give it a fixed phase of 120° with respect to the main frequency.

MODE 25 PARAMETERS

CH 1	START PHASE	STOP PHASE	START FREQ	STOP FREQ	SWEEP TIME	TRIGGER
CH 2	START PHASE	STOP PHASE				
CH 3	START PHASE	STOP PHASE				
CH 4	START PHASE	STOP PHASE				

MODE 25: BOTH-TRIGGERED-HOLD-RESET

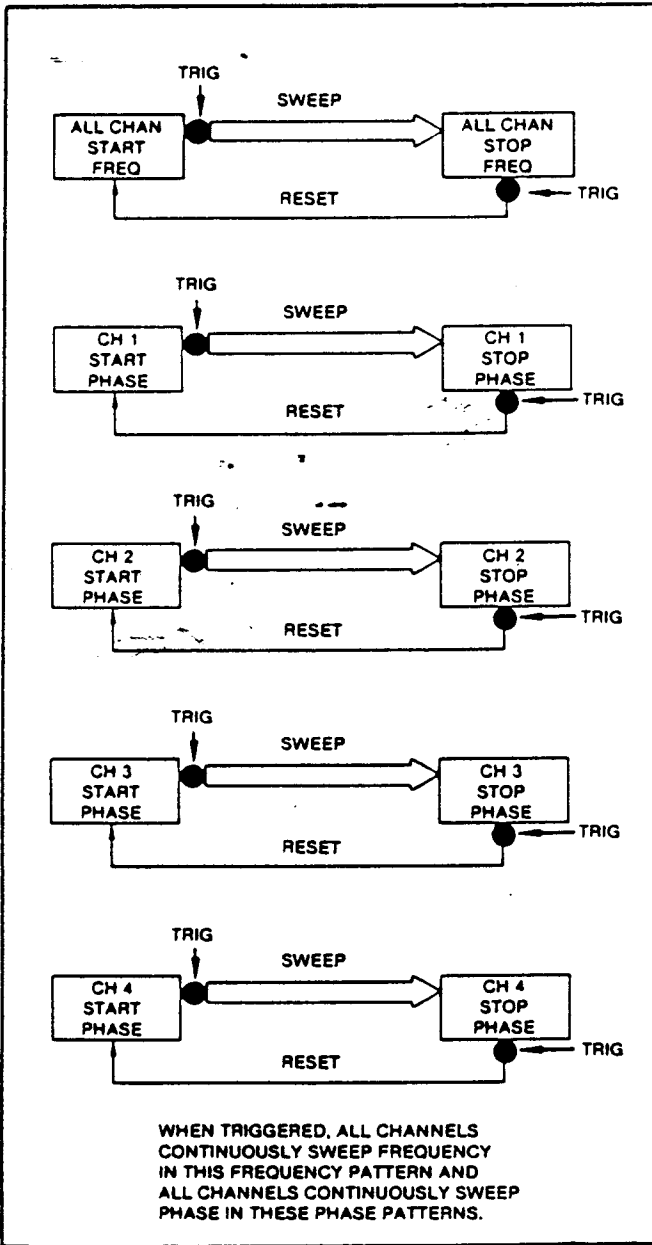

Starting the Sweep. After you have entered all the parameters for a triggered sweep, start the sweep by stepping through the sweep menus to the correct mode number as follows, then apply the triggers as required by each mode.

Mode Keystroke Series

- 3 Sweep FREQ MODE TRIG RESET
- 4 Sweep FREQ MODE TRIG REVERS
- 5 Sweep FREQ MODE TRIG HLD/RS
- 6 Sweep FREQ MODE TRIG HLD/RV
- 15 Sweep PHASE MODE TRIG RESET
- 16 Sweep PHASE MODE TRIG REVERS
- 17 Sweep PHASE MODE TRIG HLD/RS
- 18 Sweep PHASE MODE TRIG HLD/RV
- 25 Sweep BOTH TRIG

Examples. Sections 4.7.3 and 4.7.4 set up triggered sweeps step-by-step.

5.5.5 FSK Sweeps

This section describes the frequency-shift-keyed sweep modes.

Action. A key (trigger) signal makes all channels switch between two operator-defined frequencies.

Modes. The 650 provides synchronous (sweep mode 7) and asynchronous (sweep mode 8) frequency shift keying.

Synchronous Frequency Shift Keying. S-FSK holds the outputs at the START frequency until two events happen in this order: First, the key signal (trigger) must change levels. Second, the current waveform cycle must reach its end (360°). When the waveform cycle ends, the outputs will shift (jump) to the STOP frequency. S-FSK then holds the outputs at the STOP frequency until two events happen in this order: First, the key signal must return to the original level. Second, the current waveform cycle must reach its end (360°). When the waveform cycle ends, the outputs will shift back to the START frequency.

Asynchronous Frequency Shift Keying. When the key (trigger) signal changes levels, A-FSK immediately shifts the outputs from the START to the STOP frequency. When the key signal returns to the original level, A-FSK immediately shifts the outputs back to the START frequency.

Allowable Keys. The FSK sweeps accept internal oscillator keys (set up by the **Trigger** key), front panel keys (press the **Manual Trigger** key), and external signal keys (connect to the **Trig In** connector).

External Signal Keys. With external keys, the frequency of the outputs depends on three factors: START>STOP or START<STOP, the choice of trigger slope (POS/NEG) for the external signal, and the state of the key signal (HIGH/LOW). The following table shows the relationship of these parameters. The numbers in parentheses provide examples to make the table easier to understand.

Parameters. To specify the two frequencies of the FSK output signal, enter a start frequency and a stop frequency in the frequency sweep limits menu. The stop frequency **does not** have to exceed the start frequency. For example, an FSK sweep will accept either START = 4,000 Hz and STOP = 2,000 Hz or START = 2,000 Hz and STOP = 4,000 Hz.

START Frequency **Sweep** FREQ LIMITS START (enter start frequency)
 STOP Frequency **Sweep** FREQ LIMITS STOP (enter stop frequency)

Starting the Sweep. After you have entered all the parameters for an FSK sweep, start the sweep by stepping through the sweep menus to the correct mode number as follows:

Mode	Keystroke Series
7	Sweep FREQ MODE S-FSK
8	Sweep FREQ MODE A-FSK

5.5.6 Sequenced Sweeps

This section describes the sequenced sweep modes.

Action. Sequenced sweeps step through a series of frequencies or phases determined by the operator. Unlike continuous sweeping, sequenced sweeps jump instantaneously from value to value.

Modes. The 650 provides nine sequenced sweep modes:

Name	Mode Numbers			Description
	Freq	Phse	Both	
Extr-Seq	9	19	26	Trigger causes jump to next step in sequence.
Cont-Seq	10	20	27	Continuous stepping through sequence.
Trig-Seq	11	21	28	Trigger causes one pass through sequence.

Allowable Triggers. The external sequence and triggered sequence sweeps accept internal oscillator triggering (set up by the **Trigger** key), front panel triggering (press the **Manual Trigger** key), external signal triggering (connect to the **Trig In** connector), and triggering over the GPIB bus. The continuous sequence sweeps do not require triggering.

Parameters. To understand sequenced sweeps, you must first understand sequence tables, index numbers, the sequence limit, and time per step. The following paragraphs discuss these concepts in detail.

Sequence Tables. One frequency sequence table (for all channels) and up to four phase sequence tables (one per channel) control the sequenced sweeps. Figure 5-9 shows the tables for a two-channel 650. In the frequency and phase modes, the 650 steps through the appropriate sequence table, then resets to the start (index 01). In the "both" frequency/phase sequence modes, the 650 lock-steps (by index number) through all the tables simultaneously, then resets to the start.

INDEX Numbers. The index numbers determine the order the 650 will follow through a sequence. You must enter a frequency or phase for each index number up to the maximum in your series without skipping any numbers. If you fail to enter a phase or frequency for a particular index number, the 650 will use the default value stored in that space.

If:	START Freq < STOP Freq		START Freq > STOP Freq	
	(2kHz)	(4kHz)	(4kHz)	(2kHz)
And:	Trig = Pos	Trig = Neg	Trig = Pos	Trig = Neg
Then key high will cause:	STOP Freq (4kHz)	START Freq (2kHz)	STOP Freq (2kHz)	START Freq (4kHz)
And key low will cause:	START Freq (2kHz)	STOP Freq (4kHz)	START Freq (4kHz)	STOP Freq (2kHz)

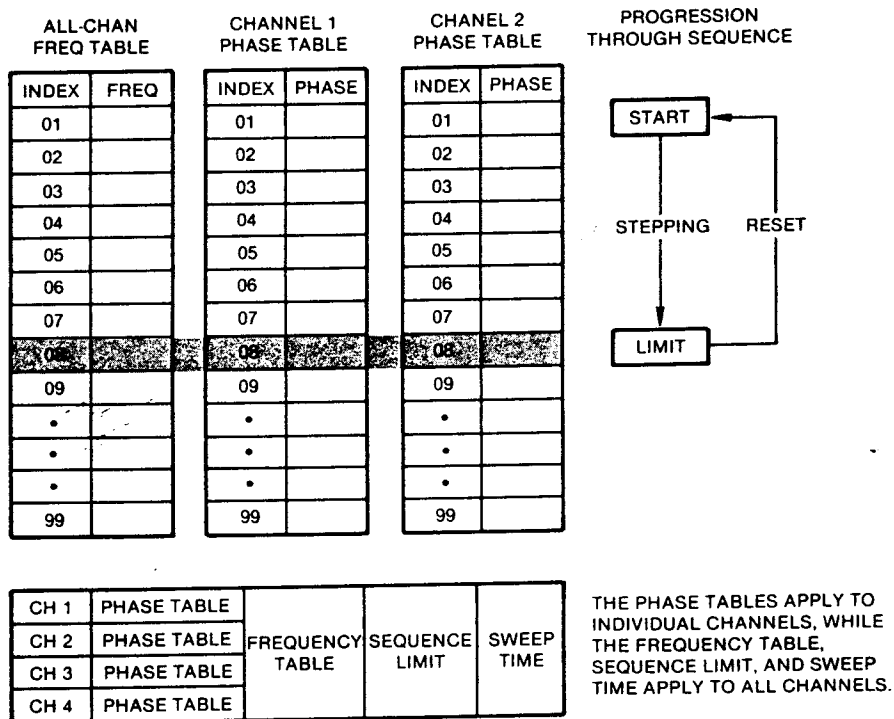

Figure 5-9. Sequence Tables

How to Enter Frequencies and Phases. To create a four-step sequence with frequencies of 3000, 4000, 2000, and 1000 Hz, use these keystrokes:

```
Sweep FREQ MODE SEQNCE INDEX 1 FREQ 3000
INDEX 2 FREQ 4000 INDEX 3 FREQ 2000 INDEX 4
FREQ 1000
```

To create a four-step sequence with phases of 10°, 20°, 30°, and 40° for channel X, use these keystrokes:

```
Channel Number X Sweep PHASE MODE SEQNCE
INDEX 1 PHASE 10 INDEX 2 PHASE 20 INDEX 3
PHASE 30 INDEX 4 PHASE 40
```

To review the contents of a frequency or phase table, use these keystrokes:

```
Sweep FREQ MODE SEQNCE INDEX, then use
cursor controls to step through table.
```

```
Channel Number X Sweep PHASE MODE SEQNCE
INDEX, then use cursor controls to step through table.
```

Entered vs. Actual Values. The 650 converts the entered phase values from decimal to binary for internal opera-

tion. The resolution of this process prevents exact conversion for all values, with the result that some phases will store a few millidegrees off from the value you entered. The 650 produces the stored, rather than the entered value; however, the phase accuracy remains within the instrument specifications. If you enter the 10° through 40° phase sequence given above, then review it with the cursor keys, the 650 will display these values:

Index	Entered Value	Actual Stored Value
01	10°	9.997 Deg
02	20°	20.000 Deg
03	30°	29.998 Deg
04	40°	40.001 Deg

Sequence LIMIT. Determine the maximum number of steps in your sequence by entering a sequence limit (see figure 5-9). This limit applies to all the sequence tables simultaneously. If you fail to enter a limit, the 650 will use the default limit of 10. Use either of the following two keystroke series to get to and enter LIMIT parameter.

```
Sweep FREQ MODE SEQNCE LIMIT → Enter limit
Sweep PHASE MODE SEQNCE LIMIT → Enter limit
```

Time Per Step. In the continuous sequence modes (10, 20, and 27) and in the triggered sequence modes (11, 21, and 28), the 650 will hold each step for T seconds, where

$$T = \frac{\text{Sweep FREQ (or PHASE) TIME}}{\text{Sweep FREQ (or PHASE) MODE SEQNCE LIMIT}}$$

Sequential Frequency Sweeps. Modes 9, 10, and 11 simultaneously step all channels through a table of frequencies.

MODE 9-11 PARAMETERS

CH 1	FREQUENCY TABLE	SEQUENCE LIMIT	SWEEP TIME (MODES 10, 11)
CH 2			
CH 3			
CH 4			

MODE 9: FREQUENCY-EXTERNAL-SEQUENCE

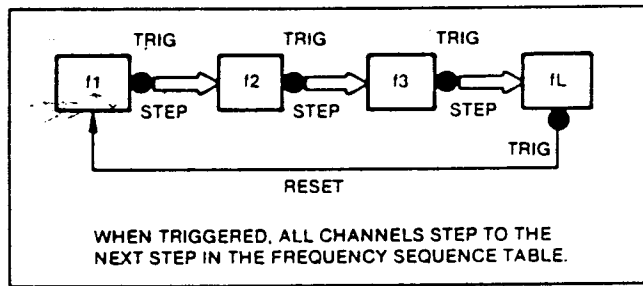

MODE 10: FREQUENCY-CONTINUOUS-SEQUENCE

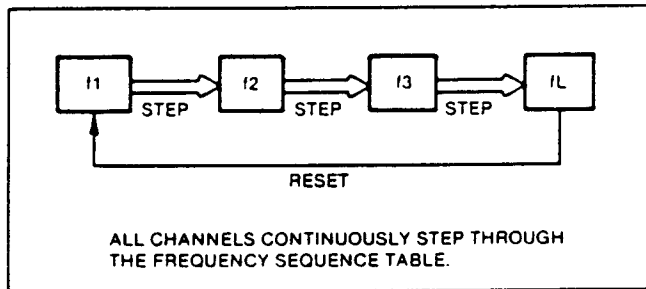

MODE 11: FREQUENCY-TRIGGERED-SEQUENCE

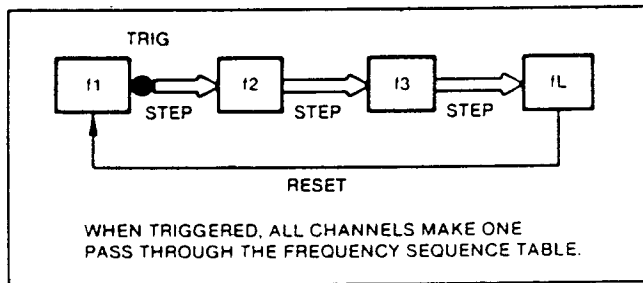

Sequential Phase Sweeps. Modes 19, 20, and 21 step one selected channel through its particular table of phases. You can fill out a table for just one channel and step it, or you can fill out tables for all the channels and step individual channels as needed. Select channels with

Channel Number X Execute.

MODE 19-21 PARAMETERS

CH 1	PHASE TABLE	SEQUENCE LIMIT	SWEEP TIME (MODES 20, 21)	MAIN FREQ
CH 2	PHASE TABLE			
CH 3	PHASE TABLE			
CH 4	PHASE TABLE			

MODE 19: PHASE-EXTERNAL-SEQUENCE

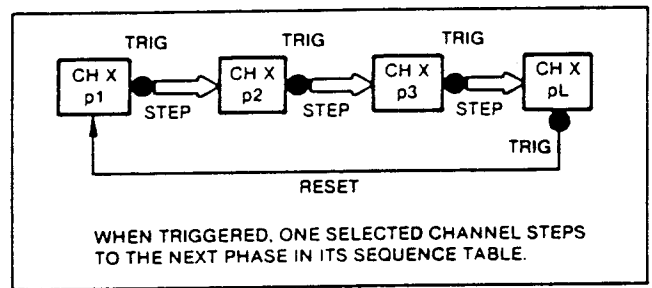

MODE 20: PHASE-CONTINUOUS-SEQUENCE

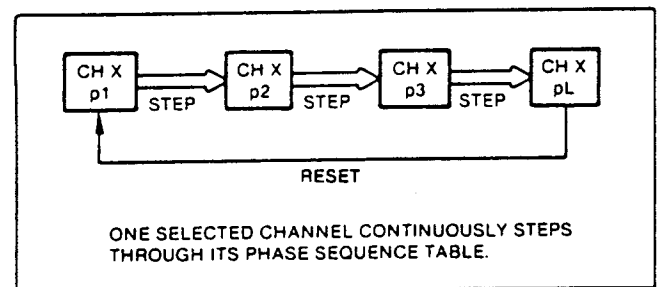

MODE 21: PHASE-TRIGGERED-SEQUENCE

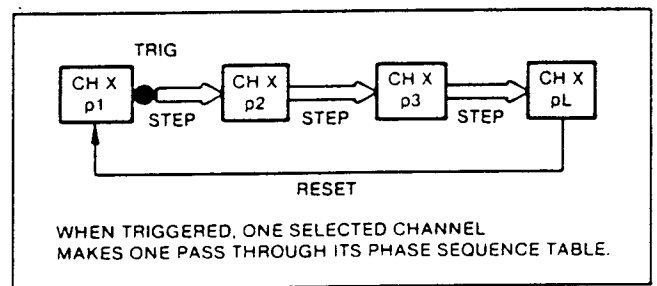

Sequential-Both Sweep. Each of the sequential-both sweep modes (26, 27, and 28) simultaneously steps all channels through the frequency sequence table and, at the same time, individually steps all channels through their respective phase sequence tables. You **must** fill out a phase sequence table for every channel. To make a channel not sweep phase, enter 0° (or some other value) for every index value up to the LIMIT. For example, entering 90° for every index number up to the LIMIT

would make a channel not sweep phase and give it a fixed phase of 90° with respect to the main frequency.

MODE PARAMETERS

CH 1	PHASE TABLE	FREQUENCY TABLE	SEQUENCE LIMIT	SWEEP TIME (MODES 27, 28)
CH 2	PHASE TABLE			
CH 3	PHASE TABLE			
CH 4	PHASE TABLE			

MODE 26: BOTH-EXTERNAL-SEQUENCE

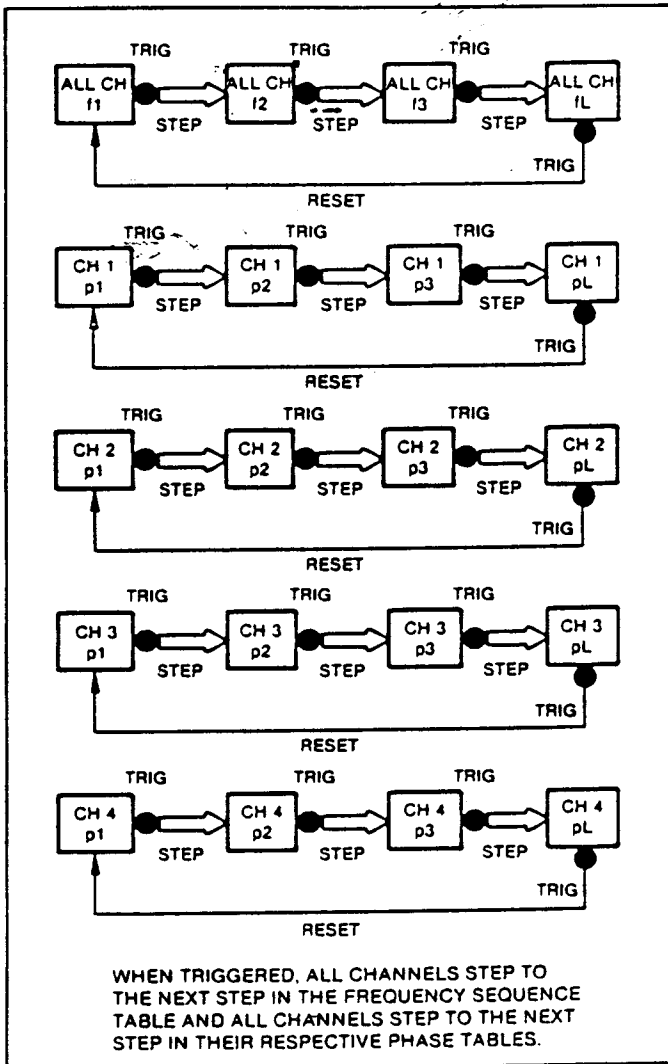

MODE 27: BOTH-CONTINUOUS-SEQUENCE

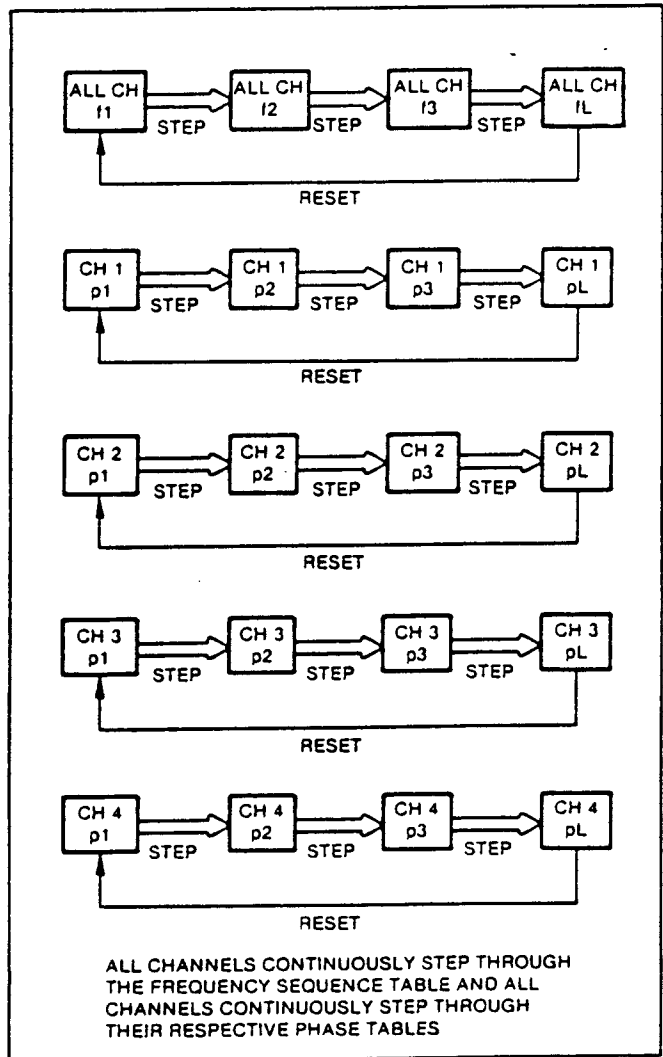

MODE 28: BOTH-TRIGGERED-SEQUENCE

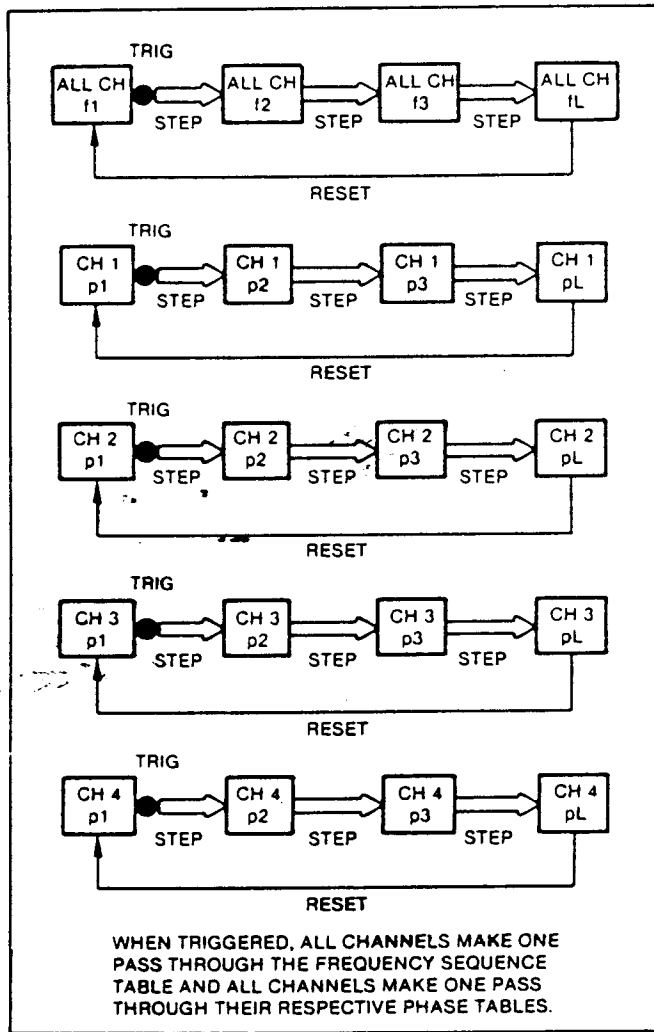

Starting the Sweep. After you have entered all the parameters for a sequence sweep, start the sweep by stepping through the sweep menus to the correct mode number as follows:

Mode	Keystroke Series
9	Sweep FREQ MODE SEQNCE EXTRNL
10	Sweep FREQ MODE SEQNCE CONT
11	Sweep FREQ MODE SEQNCE TRIG
19	Sweep PHASE MODE SEQNCE EXTRNL
20	Sweep PHASE MODE SEQNCE CONT
21	Sweep PHASE MODE SEQNCE TRIG
26	Sweep BOTH EXTSEQ
27	Sweep BOTH CNTSEQ
28	Sweep BOTH TRGSEQ

Examples. Sections 4.7.6 and 4.7.7 set up sequenced sweeps step-by-step.

5.5.7 FM and PM Sweeps

This section describes the frequency modulation and phase modulation sweeps.

Action. The voltage level of an external signal applied to the **FM/PM In** connector controls the frequency, phase, or both the frequency and phase of the output signals.

Modes. The 650 provides three modulated sweep modes:

- External-FM (mode 12) The external signal frequency sweeps all channels between the START and STOP frequency limits.
- External-PM (mode 23) The external signal phase sweeps the selected channel between its START and STOP phase limits.
- External-FM/PM (mode 29) The external signal frequency sweeps all channels between the START and STOP frequency limits and simultaneously phase sweeps all channels between their respective START and STOP phase limits.

Input Signal Specifications. The **FM/PM In** connector has an input impedance greater than 1MΩ, protection against overvoltages up to ±50Vdc, and a modulation range of -1V to +1V. A signal that exceeds either modulation limit will produce no further change in frequency or phase.

Output Functions. Table 5-3 gives the **Horiz Out**, **Marker Out**, frequency monitor, and phase monitor outputs for the modulation modes.

Parameters. The START and STOP frequency limits determine how far the modulation signal will sweep the frequency of all the channels. The separate START and STOP phase limits of each individual channel determine how far the modulation signal will sweep the phase of each channel. START can exceed STOP or STOP can exceed START. -1V always forces the outputs to the START frequency or phase and +1V always forces them to the STOP frequency or phase.

Enter the START and STOP parameters with these keystrokes:

- START Frequency **Sweep** FREQ LIMITS START (enter START frequency)
- STOP Frequency **Sweep** FREQ LIMITS STOP (enter STOP frequency)

START Phase **Channel Number** X **Sweep** PHASE LIMITS START (enter START phase)
 STOP Phase **Channel Number** X **Sweep** PHASE - LIMITS STOP (enter STOP phase)

Modulation Signal Processing. Figures 5-10 through 5-12 show how the external signal modulates frequency, phase, or both frequency and phase. In each case, you can't change the sample rate or the number of divisions between the START and the STOP limits.

Starting the Sweep. After you have entered the START and STOP limits and applied the modulation signal, start the sweep by stepping through the sweep menu to the correct mode number as follows:

Mode	Keystroke Series
12	Sweep FREQ MODE EXTFM
23	Sweep PHASE MODE EXT-PM
29	Sweep BOTH EXTRN

Example. Suppose a 1.4 volt peak-to-peak modulation signal must sweep the frequency between 10kHz and 20kHz.

Voltage Range	Known Values	Calculated Values
+ 1.0 V	STOP	22,143 kHz
+ 0.7 V	20 kHz	
0 V		15,000 kHz
- 0.7 V	10 kHz	
- 1.0 V	START	7,853 kHz

STOP Calculation

$$\frac{+0.7V - 0V}{+1.0V - 0V} = \frac{20\text{kHz} - 15\text{kHz}}{\text{STOP} - 15\text{kHz}}$$

$$\frac{7}{10} = \frac{5\text{kHz}}{\text{STOP} - 15\text{kHz}}$$

$$7\text{STOP} - 105\text{kHz} = 50\text{kHz}$$

$$7\text{STOP} = 155\text{kHz}$$

$$\text{STOP} = 22.143 \text{ kHz}$$

START Calculation

$$\frac{-0.7V - 0V}{-1.0V - 0V} = \frac{10\text{kHz} - 15\text{kHz}}{\text{START} - 15\text{kHz}}$$

$$\frac{7}{10} = \frac{-5\text{kHz}}{\text{START} - 15\text{kHz}}$$

$$7\text{START} - 105\text{kHz} = -50\text{kHz}$$

$$7\text{START} = +55\text{kHz}$$

$$\text{START} = 7.853 \text{ kHz}$$

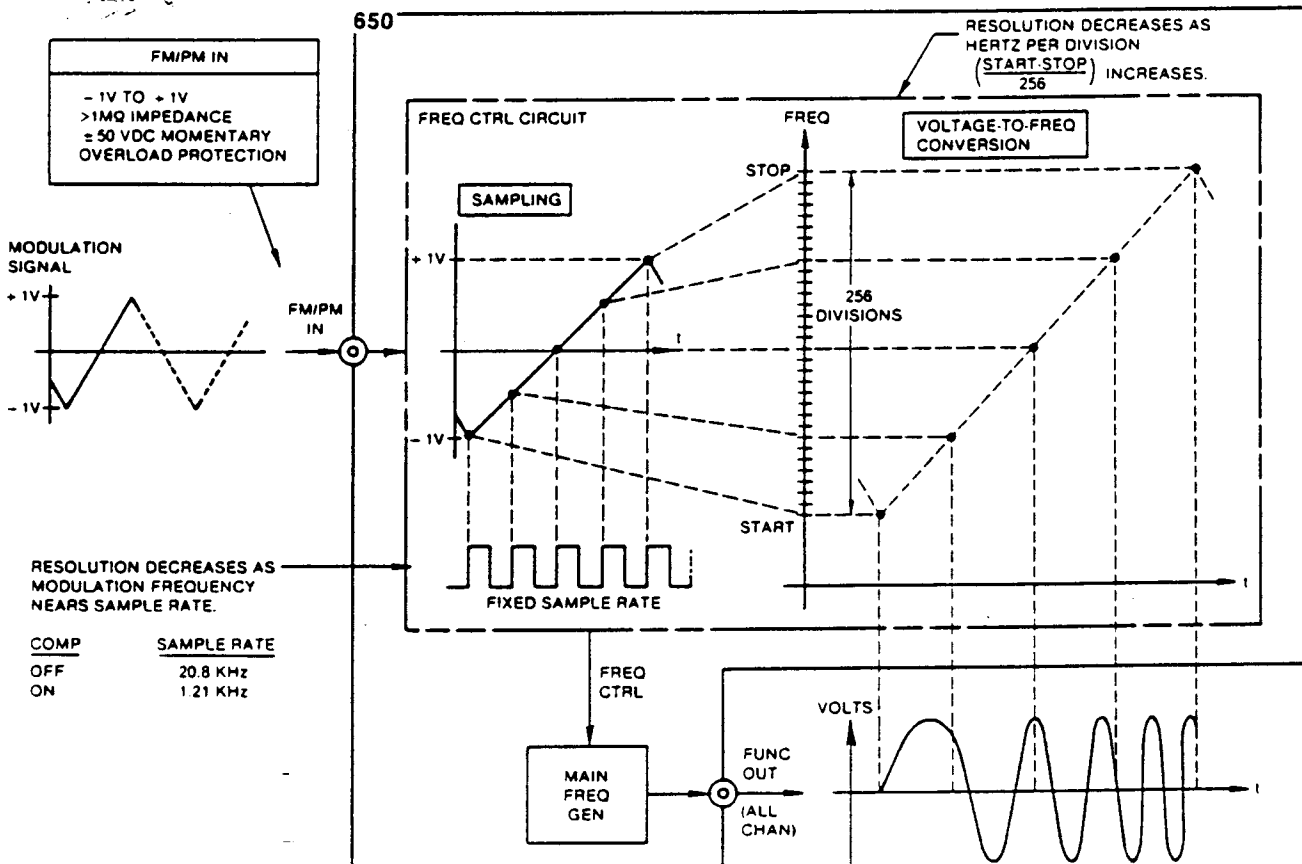
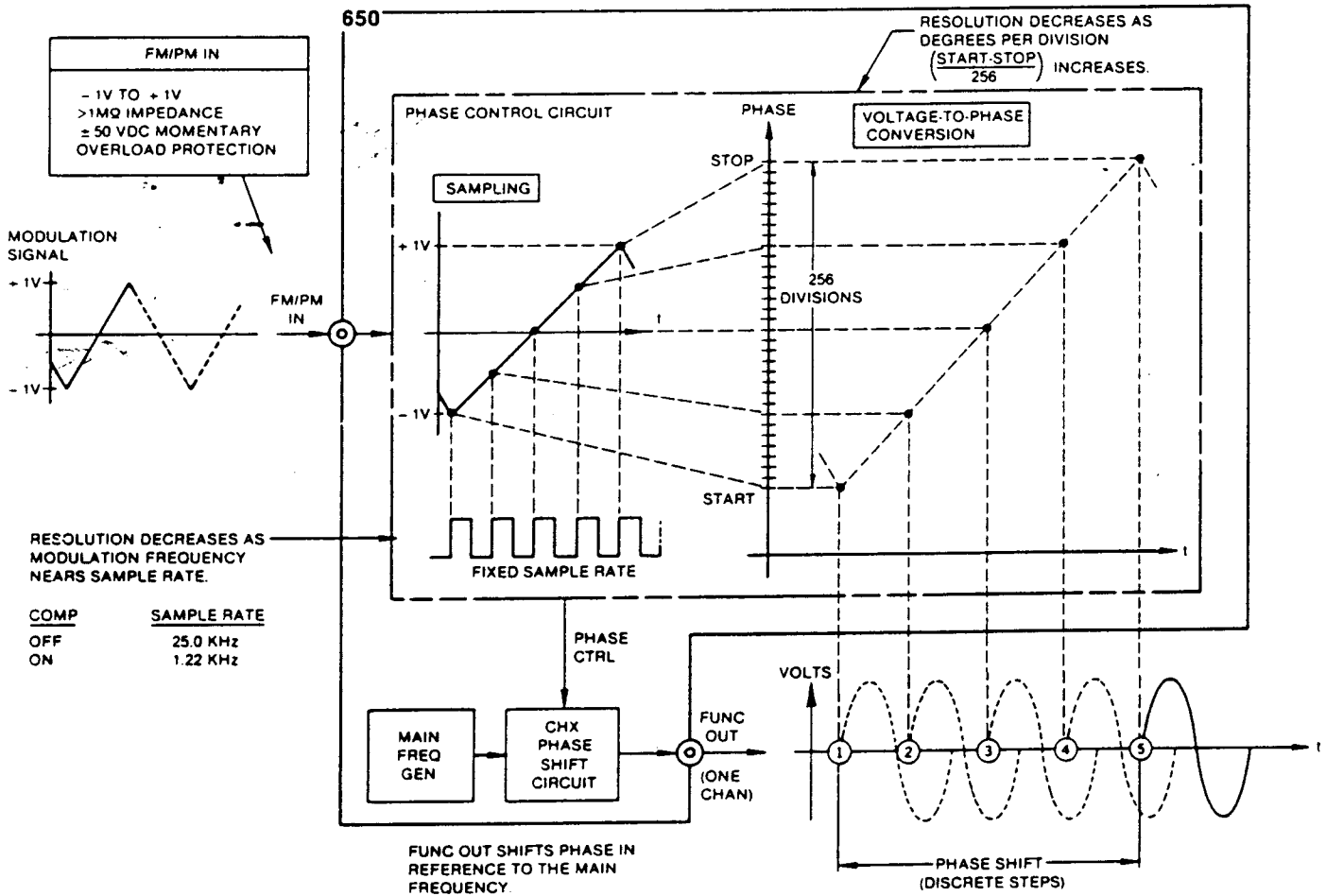

Figure 5-10. Frequency Modulation Signal Processing



M23

Figure 5-11. Phase Modulation Signal Processing

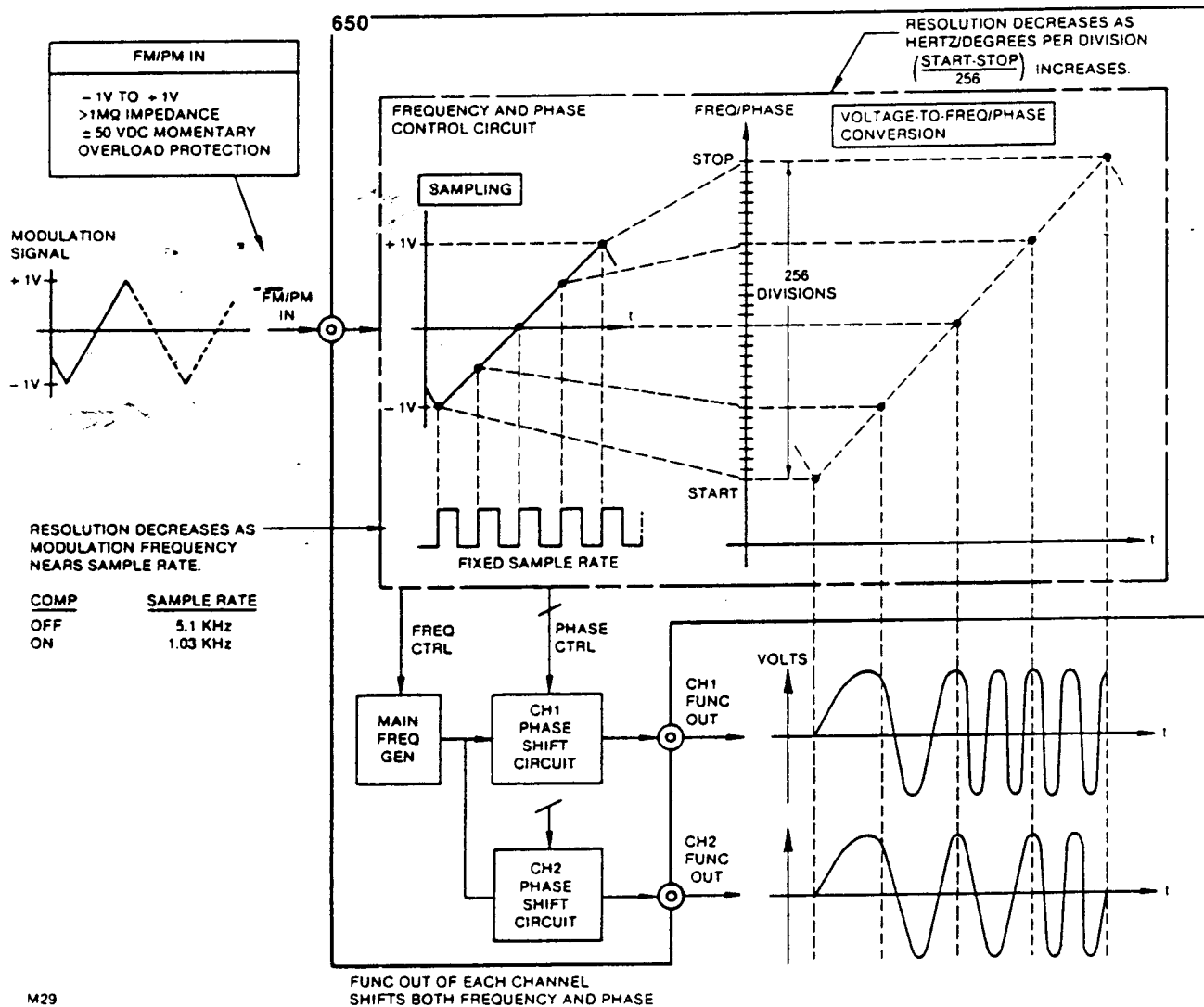

Figure 5-12. Simultaneous Frequency/Phase Modulation Signal Processing

5.5.8 Delta-Freq Sweep

This section describes the delta-frequency sweep mode (mode 22).

Action. The delta-frequency sweep shifts the frequency of one selected channel away from the main frequency by an amount DLTA-F.

Parameters. Because delta-frequency falls in the category of phase sweeps, it shifts the frequency of only the selected active channel. However, each channel can store a different DLTA-F. The 650 limits the DLTA-F range to ± 1000 Hz. In addition, you cannot enter a DLTA-F smaller than ± 0.1 mHz.

Effect of RATIO. Each channel's RATIO and DLTA-F parameters modify the main frequency (MF) as follows to determine the frequency of the channel:

$$FREQ_{CHX} = (RATIO_{CHX})(MF \pm DLTA-F_{CHX})$$

Entering DLTA-F. Follow these keystroke series to enter a DLTA-F value in each channel:

Channel Number 1 **Sweep** PHASE DLTA-F (enter channel 1 delta frequency)

Channel Number 2 **Sweep** PHASE DLTA-F (enter channel 2 delta frequency)

Channel Number 3 **Sweep** PHASE DLTA-F (enter channel 3 delta frequency)

Channel Number 4 **Sweep** PHASE DLTA-F (enter channel 4 delta frequency)

Starting the Sweep. Follow this path through the sweep menu tree to select the delta-frequency channel and start the sweep (shift the channel's frequency):

Channel Number X **Sweep** PHASE MODE DELTA

Setting Up a Single Channel. If you want to shift the frequency of just one channel, follow this keystroke series to select the channel, enter DLTA-F, and start the sweep:

Channel Number X **Sweep** PHASE DLTA-F
(enter delta frequency) MODE DELTA

Example. If you set the main frequency to 1000 Hz, enter a delta frequency of + 500 Hz into channel 2, and select channel 2, then channel 1 will deliver 1000 Hz and channel 2 will deliver 1500 Hz.

5.6 Utility KEY MENU TREE

This part provides detailed operating instructions for the **Utility** menu tree (see figure 5-13). The utility tree branches to six menus:

Section	Function	Page
5.6.1 Configuration Menu	Configures the 650 as a master, slave, or independent unit.	5-37
5.6.2 Hold-In Menu	Makes the Hold In connector hold sweeps or the waveform voltage.	5-37
5.6.3 Calibration Menus	Controls automatic and manual calibration.	5-38
5.6.4 Self-Test Menu	Runs the entire hardware diagnostic test series.	5-38
5.6.5 Troubleshoot Menu	Selects and runs individual hardware diagnostic tests.	5-42
5.6.6 Environment Menu	Controls the beep tone, screen light, and screen readability.	5-42

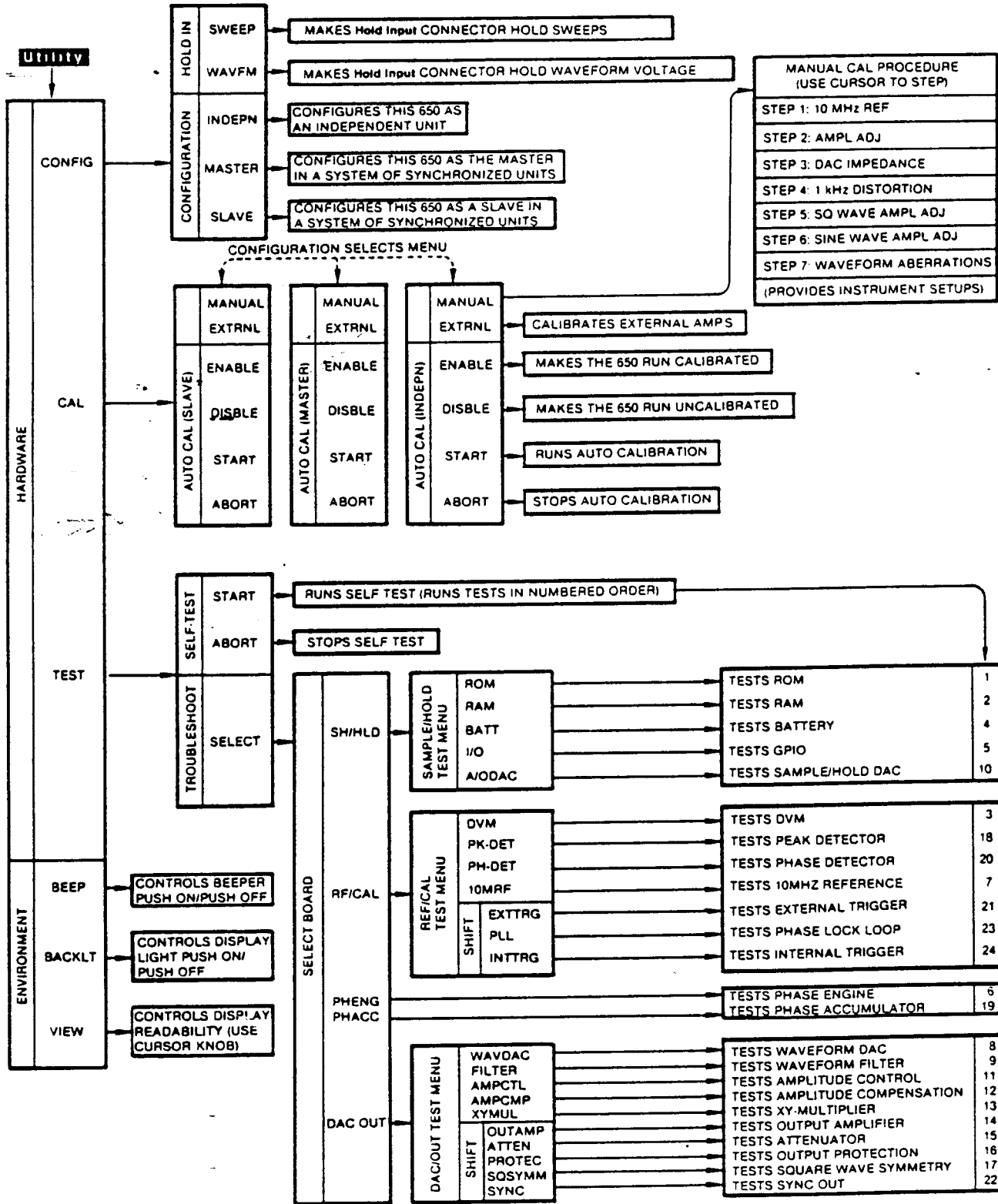

Figure 5-13. Utility Key Menu Tree

5.6.1 Configuration Menu

Function. The configuration menu makes the 650 act as an independent unit, as the master for a system of up to ten synchronized units, or as one of the slaves in the system. Section 2 (installation) tells how to connect the units together; section 7 (calibration) tells how to calibrate the system.

Synchronized Operation. Give all the units the same main frequency.

Key Descriptions.

INDEPN Makes the 650 into an independent unit. Because the 650 powers up as an independent, you will use INDEPN only to change the configuration back to independent from master or slave. INDEPN also makes the CAL key bring up the independent auto-cal menu.

MASTER Makes the 650 serve as the master phase reference for up to nine slave units. Make only one of the interconnected set into the master unit. MASTER also makes the CAL key bring up the master auto-cal menu.

SLAVE Makes the 650 phase-reference itself to the master unit. SLAVE also makes the CAL key bring up the slave auto-cal menu.

5.6.2 Hold-In Menu

Function. The hold-in menu makes the rear-panel **Hold Input** connector hold phase/frequency sweeps or the waveform voltage.

Operating Conditions. Frequency sweep holds and waveform voltage holds apply to all channels simultaneously. Phase sweep holds apply only to the active channel. A TTL low signal (<0.4V) applies the hold; a TTL high (>2.4V) releases it.

Hold/Resume Key. The setting of the hold-in menu has no effect on the action of the **Hold/Resume** key. The **Hold/Resume** key holds waveform sweeps, but not waveform voltages.

SWEEP Key. Makes the **Hold Input** connector hold frequency sweeps (see figure 5-14) and phase sweeps.

WAVFM Key. Makes the **Hold Input** connector hold the waveform voltage (see figure 5-15).

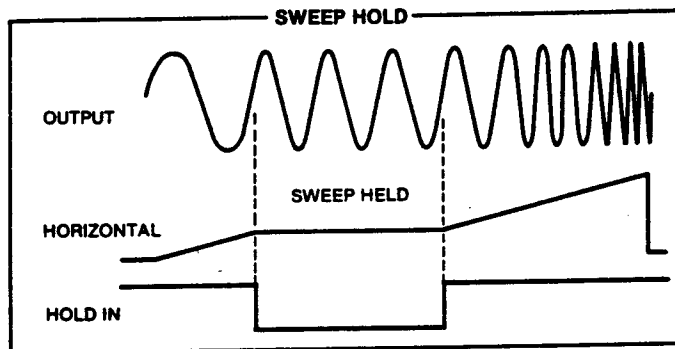

Figure 5-14. Frequency Sweep Hold

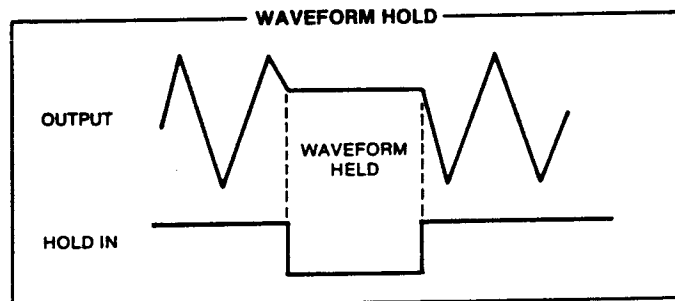

Figure 5-15. Waveform Voltage Hold

5.6.3 Calibration Menus

Function. The three configuration-dependent calibration menus control manual, automatic, and external calibration for the 650.

Why Does the 650 Have Three Calibration Menus? Calibration depends on configuration. Because the 650 has three configurations (independent, master, or slave) it has three separate calibration procedures. Each procedure has a separate menu. The configuration you choose in the configuration menu determines which calibration menu will appear when you press the CAL key.

The three calibration menus differ only slightly. In fact, only the function of the auto-cal START key varies from menu to menu; all the other keys perform configuration-independent functions. Furthermore, START differs only in the auto-cal process that it starts: independent auto-cal from the independent menu, master auto-cal from the master menu, and slave auto-cal from the slave menu.

All three auto-cal processes build compensation tables. The values in these tables compensate for amplitude-dependent amplitude and offset errors and for frequency-dependent gain and phase errors. The master and slave auto-cal procedures differ from the independent auto-cal procedure only in that they calibrate the phases of slave units to the reference phase of a master unit.

Key Descriptions. The following descriptions briefly describe the function of each calibration key. For complete, step-by-step operating instructions, see section 7 (calibration).

- MANUAL** Calls the seven-step manual-calibration procedure. Manual calibration requires test equipment and internal adjustments. Calling any step to the screen automatically sets the 650 to the parameters required for that step. Section 7 gives the manual calibration procedure.
- EXTRNL** Measures the delay of an external amplifier. Section 7 gives the full procedure.

- ENABLE** Enables the auto-cal correction tables and therefore makes the 650 run calibrated. The 650 powers up with the auto-cal correction tables enabled.
- DISBLE** Disables the auto-cal correction tables and therefore makes the 650 run uncalibrated.
- START** Depending on the configuration, makes the 650 run the independent, master, or slave auto-calibration procedure. Auto-cal takes one minute and constructs the tables of correction data that the 650 applies during all following operation. Section 7 gives the order of calibration for interconnected master/slave units.
- ABORT** Stops the auto-calibration procedure in mid-process. Stopping auto-cal puts defective data in the auto-cal correction tables. Always re-run auto-cal if you stop a run.

5.6.4 Self-Test Menu

Function. The self-test menu automatically runs, in circuit-dependent order, all 24 of the 650's built-in hardware diagnostic tests. The complete run takes 2 to 4 minutes, depending on the number of channels. Use self-test to verify hardware operation or to find defective circuits.

Operation. Figure 5-16 shows the operating flow chart for self-test. Table 5-6 lists, in order of performance, the progress, error, and suspect boards messages for each test. Self-test stops and displays an error message when it finds a defective circuit. You can't test past the message because defects make the following tests generate misleading error messages.

Setup. Disconnect all cables from the rear-panel connectors.

START Key. Starts self-test. If an error message appears, repair or replace the defective circuit, then restart the test.

ABORT Key. Stops self-test in mid-process. Expect a delay before the ***interrupt*** message appears.

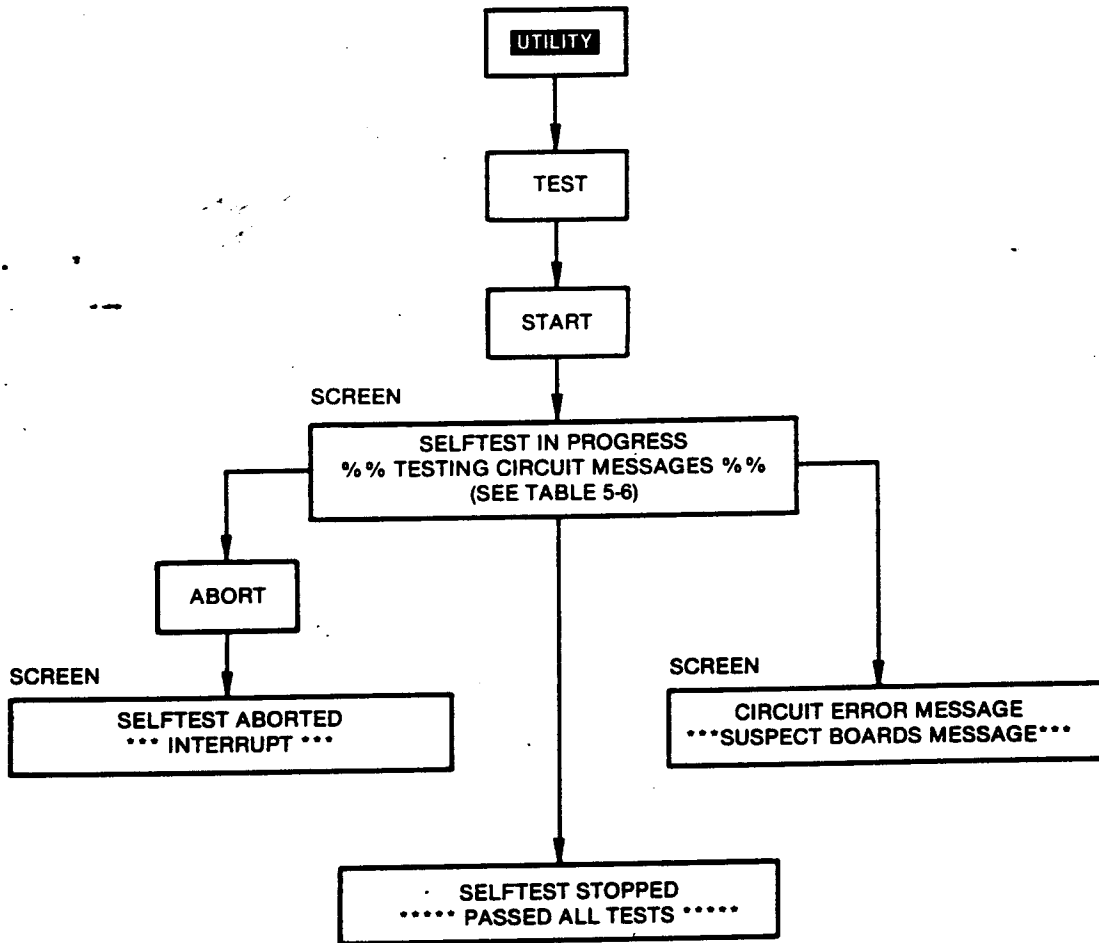

Figure 5-16. Self-Test Operating Flowchart

Table 5-6. Self-Test Messages

% TESTING CIRCUIT MESSAGE%	CIRCUIT ERROR MESSAGE	***SUSPECT BOARDS MESSAGE***
% TESTING ROM%	ROM ERROR	**SAMPLE AND HOLD BOARD ERR**
% TESTING RAM%	RAM ERROR	**SAMPLE AND HOLD BOARD ERR**
% TESTING DVM%	DVM ERROR	*****REF/CAL BOARD ERR*****
% TESTING BATTERY%	BATTERY ERROR	*****S/H, REF/CAL ERR*****
% TESTING GPIO%	GPIO ERROR	**SAMPLE AND HOLD BOARD ERR**
% TESTING PHASE ENGINE%	PHASE ENGINE ERROR	***PHASE ENGINE BOARD ERR***
% TESTING 10 MHZ REFERENCE%	10 MHZ REFERENCE ERROR	*****REF/CAL BOARD ERR*****
% TESTING WAVEFORM DAC%	WAVEFORM DAC ERROR	*****PE, RAM, DACOUT-N ERR*****
% TESTING WAVEFORM FILTER%	WAVEFORM FILTER ERROR	*****DAC OUTPUT-N ERR*****
% TESTING SAMPLE/HOLD DAC%	SAMPLE/HOLD DAC ERROR	*****S/H, DACOUT-N ERR*****
% TESTING AMPLITUDE CONTROL%	AMPLITUDE CONTROL ERROR	*****DAC OUTPUT-N ERR*****
% TESTING AMPLITUDE COMPENSATION%	AMPLITUDE COMPENSATION ERROR	*****PE, DACOUT-N ERR*****
% TESTING XY MULTIPLIER%	XY MULTIPLIER ERROR	*****DAC OUTPUT-N ERR*****
% TESTING OUTPUT AMPLIFIER%	OUTPUT AMPLIFIER ERROR	***DACOUT-N, +/- 38 V ERR***
% TESTING ATTENUATOR%	ATTENUATOR ERROR	*****DAC OUTPUT-N ERR*****
% TESTING OUTPUT PROTECTION%	OUTPUT PROTECTION ERROR	*****DAC OUTPUT-N ERR*****
% TESTING SQUARE WAVE SYMMETRY%	SQUARE WAVE SYMMETRY ERROR	*****DAC OUTPUT-N ERR*****
% TESTING PEAK DETECTOR%	PEAK DETECTOR ERROR	*****REF/CAL BOARD ERR*****
% TESTING PHASE ACCUMULATOR%	PHASE ACCUMULATOR ERROR	*PHASE ACCUMULATOR BOARD ERR*
% TESTING PHASE DETECTOR%	PHASE DETECTOR ERROR	*****REF/CAL, DACOUT-N ERR*****
% TESTING EXTERNAL TRIGGER%	EXT TRIG AND TRIG LEVEL ERROR	*****REF/CAL BOARD ERR*****
% TESTING SYNC OUT%	SYNC OUT ERROR	*****REF/CAL BOARD ERR*****
% TESTING PHASE LOCK LOOP%	EXTERNAL PLL ERROR	*****REF/CAL BOARD ERR*****
% TESTING INTERNAL TRIGGER%	INTERNAL TRIGGER ERROR	*****REF/CAL BOARD ERR*****

Figure 5-17 locates the circuit boards and power supplies.

Each message above lists one or more possibly defective boards. N indicates the DAC Output board channel number.

Note: The RAM ERROR message points to the RAM on the Sample and Hold board. The WAVEFORM DAC ERROR message points to the RAM boards.

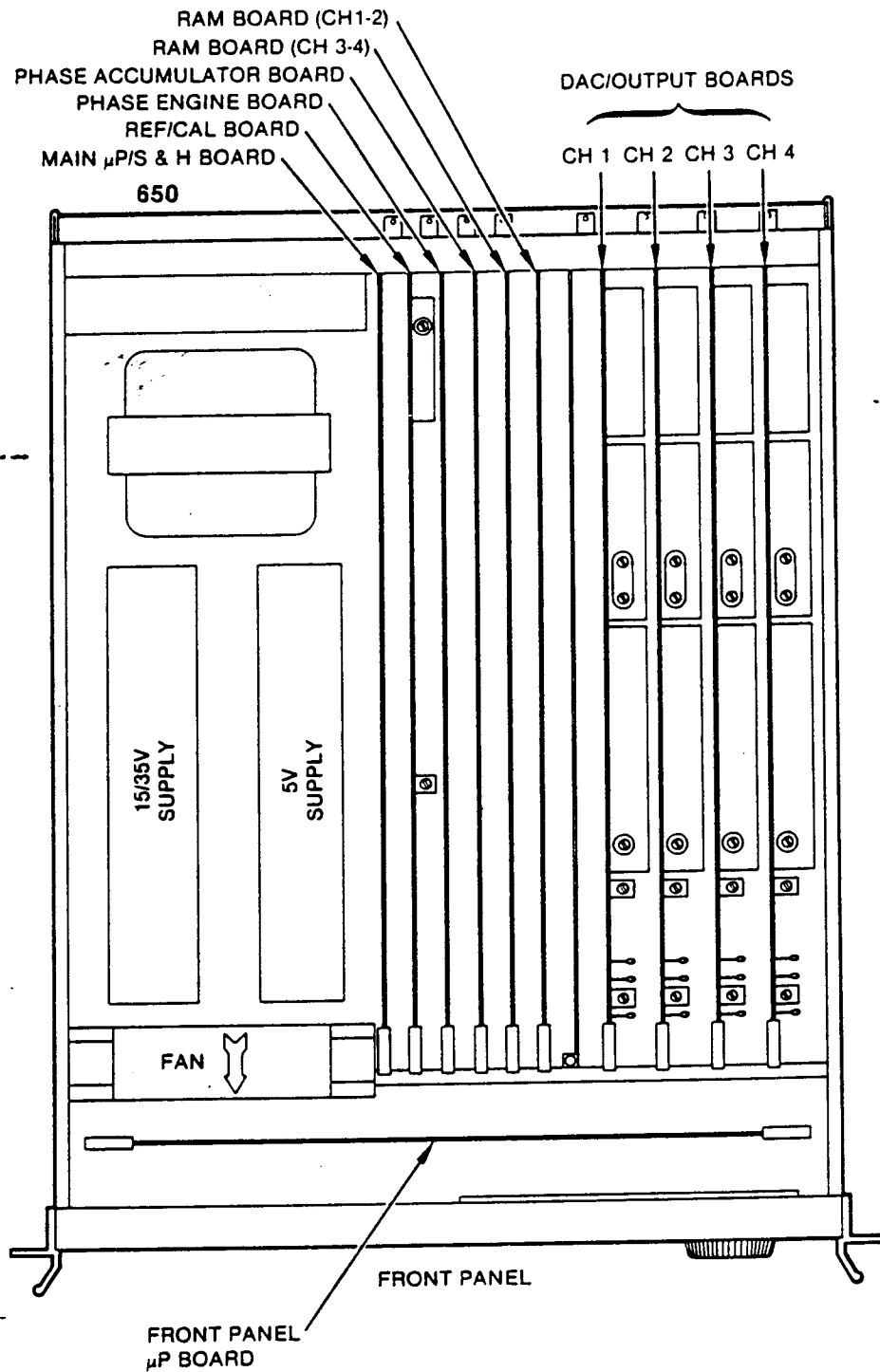

Figure 5-17. 650 Circuit Board and Power Supply Locations

5.6.5 Troubleshoot Menu

Function. The troubleshoot menu selects and repeats continuously any one of the hardware diagnostic tests. Continuous repetition permits test instrument isolation of defective components.

Setup. Disconnect all cables from the rear-panel connectors.

Operation. Press the soft keys as shown in the menu tree (figure 5-13) to run a specific test. The 650 will display the name of the test, but will not generate a pass or fail message. To stop one test and start another in the same test menu, just press the button for the next test. To return to the select-board menu from a test menu, press **Utility** TEST SELECT. If a repair passes an individual test, run self-test to verify all the hardware.

Key Descriptions. The following descriptions tell how to select and start the individual tests. Figure 5-17 locates the circuit boards.

- SELECT Calls the select-board menu. Each of the five keys either displays a test menu (for boards with several tests) or starts a test (for boards with one test).
- SH/HLD Calls the test menu for the sample and hold board. To start a test, press the appropriate key.
- RF/CAL Calls the test menu for the reference and calibration board. To start a test, press the appropriate key.
- PHENG Starts the phase engine test; retains the select board menu. To stop the test and select another board, press the key for that board.
- PHACC Starts the phase accumulator test; retains the select board menu. To stop the test and select another board, press the key for that board.
- DACOUT Calls the test menu for the DAC/Output boards. Any test you select from this menu will run simultaneously on all the DAC/Output boards. To start a test, press the appropriate key.

5.6.6 Environment Menu

Function. The environment menu controls the beep tone, screen light, and screen readability.

BEEP Key. Controls the tone that sounds when you press front panel buttons. Push on/push off.

BACKLT Key. Controls the display's backlight. Push on/push off.

VIEW Key. Controls the readability (viewing angle) of the display. To adjust the angle, first press VIEW, then rotate the cursor knob.

5.7 GPIB KEY MENU TREE

This part provides an operating overview of the **GPIB** menu tree shown in figure 5-18. Section 6 discusses GPIB operation in detail.

- 5.7.1 Overall Operation
- 5.7.2 Soft Key Operation

5.7.1 Overall Operation

Menu Overview. The **GPIB** key menu tree allows you to enter a GPIB address, regain control of the front panel from the remote controller, display the command receipt and error message buffers, send a "key-pressed" service request to the controller, and display a list of the 650 GPIB commands.

5.7.2 Soft Key Operation

ADRS KEY

Function. The ADRS key enables entry of an alternate GPIB address from the front panel.

GPIB Address. The GPIB bus address identifies the 650 to the controller. The rear-panel Address Selector switch determines the 650's power-up address, which also serves as the operating address until an address entered at the front panel (with the ADRS key) supercedes it. In the command string WRITE @709:"CH 1 OT 1 EX", the digits 09 specify the 650 address.

Operation. Press the ADRS key to display the current GPIB address on the top line of the display. Key in the new address on the number keypad, then press EXECUTE. The decimal and binary versions of the new address will appear on the display. If the 650 loses power, the address reverts to the rear panel address.

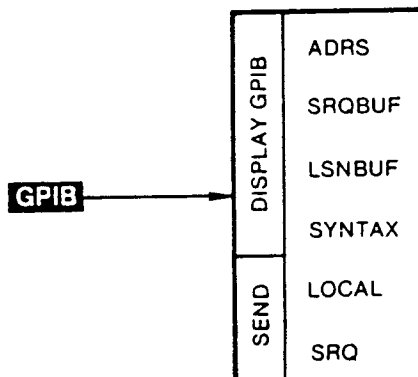

- ADRS Enables programming of GPIB instrument address from the front panel (power loss will cause reversion to rear-panel address).
- LOCAL Returns instrument control from GPIB bus to front panel.
- LSNBUF Causes scrolling display (use cursor knob) of all commands received
- SRQ Sends service request to instrument controller.
- SRQBUF Causes scrolling display (use cursor knob) of all SRQ messages generated by the 650.
- SYNTAX Displays complete list (use cursor knob) of all GPIB commands.

Figure 5-18. GPIB Key Menu Tree

LOCAL KEY

Function. The LOCAL key switches control of the 650 from the GPIB bus to the front panel.

GPIB vs Front Panel Control. Receipt of any GPIB command by the 650 disables the front panel to the extent that you can call menus and read parameter settings, but you cannot change modes or numbers. Pressing the LOCAL key returns full control to the front panel. The universal GPIB command LLO not only partially disables the front panel, but also disables the LOCAL key so you cannot return to full control. The FRONT PANEL command completely disables the front panel (no backlight, no menus, no beeps, and no return to full control with the LOCAL key).

Operation. Press the LOCAL key to return control of the 650 to the front panel.

LSNBUF KEY

Function. The LSNBUF key allows you to see all the commands received by the 650 over the GPIB bus.

Listen Buffer. The 256-character last-in-first-out listen buffer receives the commands from the GPIB bus and stores them until the controller stops transmitting. After the transmission ends, the 650 processes the commands in the listen buffer. If the buffer fills up dur-

ing transmission, it stops accepting commands, distributes its contents to the pending registers, then again accepts commands. The commands in the pending registers will not become effective until an EX command executes them. Old commands flow out the high end of the LSNBUF. New commands enter the low (000) end.

Operation. Press the LSNBUF key to call the listen buffer to the screen, then scroll through it with the cursor knob. The buffer contents appear on the top line of the display.

SRQ KEY

Function. The SRQ key allows the operator to send a "key-pressed" service request to the controller. For example, the controller could ask the operator to change the connections of the test setup, then press SRQ. When the controller services the request and finds the "key-pressed" message, it knows that the operator has completed the changes. See the detailed description of the SRQ? command and the SRQ Demonstration Program in section 6 for more information.

Pressing the SRQ key also displays the status byte.

SRQBUF KEY

Function. The SRQBUF key allows you to see all the service request messages generated by the 650.

Service Request Buffer. The last-in-first-out service request buffer holds messages for the controller. These messages describe programming errors, hardware failures in the 650, and the occurrence of events. Slashes (/) separate messages. If the SRQ buffer fills up, you will lose any new messages. Reading the buffer empties it. To avoid losing messages, make a practice of reading the buffer before it fills. See section 6.6 and figure 6-2 for more information.

Operation. Press the SRQBUF key to call the service request buffer to the screen, then scroll through it with the cursor knob. The buffer contents appear on the top line of the display.

SYNTAX KEY

Function. To help you program, the SYNTAX key calls a list of the GPIB commands to the 650's screen.

Other Sources of this Data. The HELP? command sends a complete list of the commands, arguments, and limits to the controller. Table 6-2 in this manual also lists all the commands, arguments, and limits and, in addition, gives a brief functional description of each one.

Operation. Press the SYNTAX key to call the GPIB command list, then scroll through it with the cursor knob. Get argument numbers from table 6-2 or call the enumerated function's menu to the 650 screen and read its number (in parentheses) from the top line of the display.

Display. SYNTAX displays commands as follows:
<full header>:<minimum form>

Examples: AMPLITUDE:AM
BURSTCOUNT:BR
CHANNEL:CH
RESET:RST

5.8 **Stored Settings** KEY MENU TREE

This part provides detailed operating instructions for the **Stored Settings** menu tree (see figure 5-19).

5.8.1 Overall Operation

The stored settings key allows you to store 25 complete instrument setups for fast recall. An internal battery saves the setups when you turn the instrument off. The **Reset** key does not erase stored setups.

Setup Contents. A setup includes all the settings of the **Main**, **Channel**, **Trigger**, and **Sweep** keys, but not those of the **GPIB** or **Utility** keys.

Setup Numbering. You store and recall setups by number. The 650 numbers the setups from 1 to 25.

Current Setup. The 650 protects against power loss by continuously storing the current instrument setup as setup number 0. You can recall, but not store, setup 0.

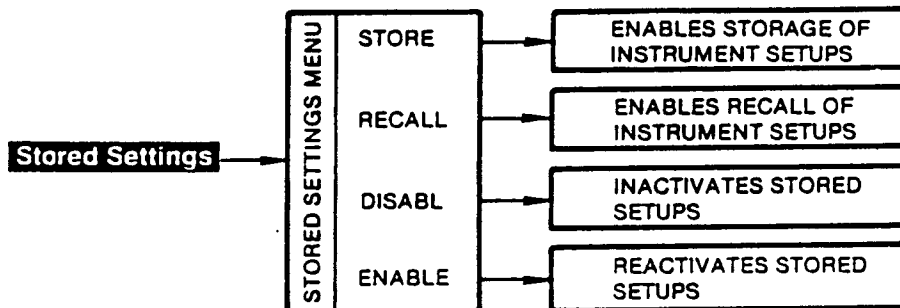

- STORE Enables storage of the current instrument setup in any one of the 25 setup storage locations.
- RECALL Enables recall of an instrument setup from any of the 25 storage locations and from the lost-power location.
- DISABL Enables inactivation of any storage location. Inactivation does not change the instrument setup stored in the location.
- ENABLE Enables reactivation of a storage location.

Figure 5-19. **Stored Settings** Key Menu Tree

5.8.2 Soft Key Operation

The following procedures use [brackets] to separate screen messages from the procedure text. The brackets do not appear on the screen.

How to Store a Setup. Follow this procedure to store a setup.

Step	Action	Response
1.	Set up the instrument.	
2.	Press Stored Settings key.	Screen: [—store setting menu—]
3.	Press the STORE key.	Screen: [setting XX last stored]
4.	Key in the number of the storage location. Allowable numbers: 1-25.	Screen: [store setting: 12]
5.	To store the setup, choose either step 5a or step 5b.	
5a.	Press any other menu key.	The 650 stores the setting, then displays the menu you selected.
5b.	Press the Execute key.	The 650 stores the setting. Screen: [setting 12 last stored]

How to Recall a Setup. Follow this procedure to recall a stored setup. If you try to recall a disabled setup, the screen will flash the message *** stored setting undefined ***.

Step	Action	Response
1.	Press Stored Settings key.	Screen: [—store setting menu—]
2.	Press the RECALL key.	Screen: [no settings recalled] or [setting XX last recalled]
3.	Key in the number of the storage location containing the required setup. Allowable numbers: 0 (lost power location) and 1 to 25.	Screen: [recall setting: 12]
4.	To recall the setup, choose either step 4a or step 4b.	
4a.	Press any other menu key.	The 650 recalls the setting, then displays the menu you selected.
4b.	Press the Execute key.	The 650 recalls the setting. Screen: [setting 12 last recalled]

How to Disable a Stored Setup. The 650 skips disabled setups when you step through the setups with the cursor controls. Follow this sequence to disable a stored setup:

Step	Action	Response
1.	Press Stored Settings key.	Screen: [—store setting menu—]
2.	Press the DISABL key.	Screen: [no settings deleted] or [setting XX last deleted]
3.	Key in the number of the storage location that you want to disable.	Screen: [delete setting: 12]
4.	To delete the setup, choose either step 4a or step 4b.	
4a.	Press any other menu key.	The 650 deletes the setting, then displays the menu you selected.
4b.	Press the Execute key.	The 650 deletes the setting. Screen: [setting 12 last deleted]

How to Enable a Stored Setup. Follow this sequence to enable a previously disabled setup:

Step	Action	Response
1.	Press Stored Settings key.	Screen: [—store setting menu—]
2.	Press the ENABLE key.	Screen: [no settings recovered] or [setting XX last recovered]
3.	Key in the number of the storage location that you want to enable.	Screen: [recover setting: 12]
4.	To enable the setup, choose either step 4a or step 4b.	
4a.	Press any other menu key.	The 650 enables the setting, then displays the menu you selected.
4b.	Press the Execute key.	The 650 enables the setting. Screen: [setting 12 last recovered]

How to Change a Stored Setup. First, RECALL the setup. Second, make the required changes in the instrument settings. Third, STORE the changed setup.

How to Step Through Stored Setups. Stepping through stored setups with the cursor arrows or knob allows you to perform repetitive multiple-step testing without time-consuming control changes between the steps. Disable undefined setups before you begin stepping. Cursor stepping returns to the beginning (excluding setup 0) when you pass beyond the last setup.

To step through stored setups, follow this sequence:

1. Press the **Stored Settings** key.
2. Press the RECALL key.
3. Key in the starting setup number.
4. Press **Execute**.
5. Use one of these incrementing methods to step:
 - UP CURSOR ARROW (steps through in increasing numerical order)
 - DOWN CURSOR ARROW (steps through in decreasing numerical order)
 - ROTATE CURSOR KNOB (clockwise increases, counterclockwise decreases)

5.9 **Reset KEY MENU TREE**

This part provides detailed operating instructions for the **Reset** menu tree (see figure 5-20).

Operation. Press the **Reset** key to display the reset menu. An overload (>500ma) will automatically display the reset menu below the two overload message lines:

```

***OUTPUT OVERLOAD DETECTED***
USE OVERLOAD RESET TO RESTORE OUTPUTS
-reset menu-
params ovload
    
```

OVLOAD Key. The OVLOAD (overload) key recloses the output relays after an output overload has opened them, but leaves your instrument setup unchanged. Always determine and correct the cause of the overload in your test setup before resetting the 650.

PARAMS Key. The PARAMS (parameters) key opens the output relays and resets the 650 parameters to the following power-up values.

Main Parameters: Frequency 1000, mode 0 (continuous), burst count 2, trigger source 0 (external), trigger slope 0 (positive), trigger level 1.4 volts, trigger frequency 200, sweep time 1, sweep mode 0, sweep function 0 (linear), start frequency 1000, stop frequency 10000, marker frequency 5000, sequence limit 10, configuration 0 (independent), hold input 0 (sweep).

Channel Parameters: Amplitude 5, offset 0, phase 0, function 0 (sine), output 0 (off), ratio 1, duty cycle 50, delay 0, start phase 0, stop phase 360, marker phase 180, delta frequency 0.

5.10 AMPLITUDE MODULATION

The 650 permits amplitude modulation of individual channels.

Inputs. The separate **AM In** connectors (one for each channel) have >10KΩ input impedance, ± 50Vdc protection, and an operating range of ± 5V.

Operation. Amplitude modulation has no menu controls. To amplitude modulate a channel, set the channel's amplitude to the value required for your application and connect the modulation signal to the channel's **AM In** connector. Figure 5-21 shows the relationship between channel amplitude and the modulation signal.

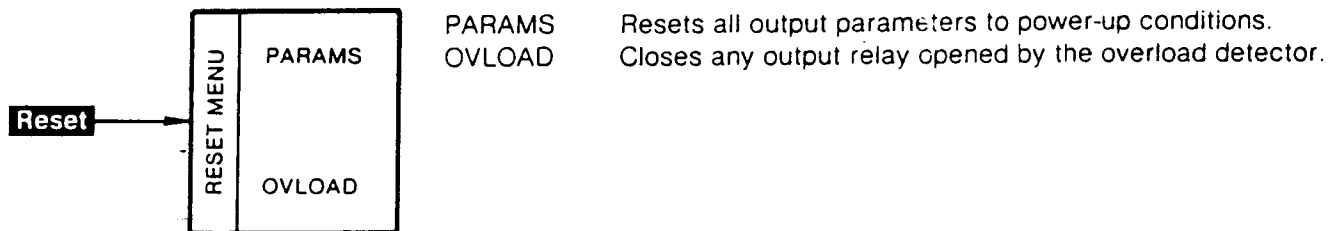
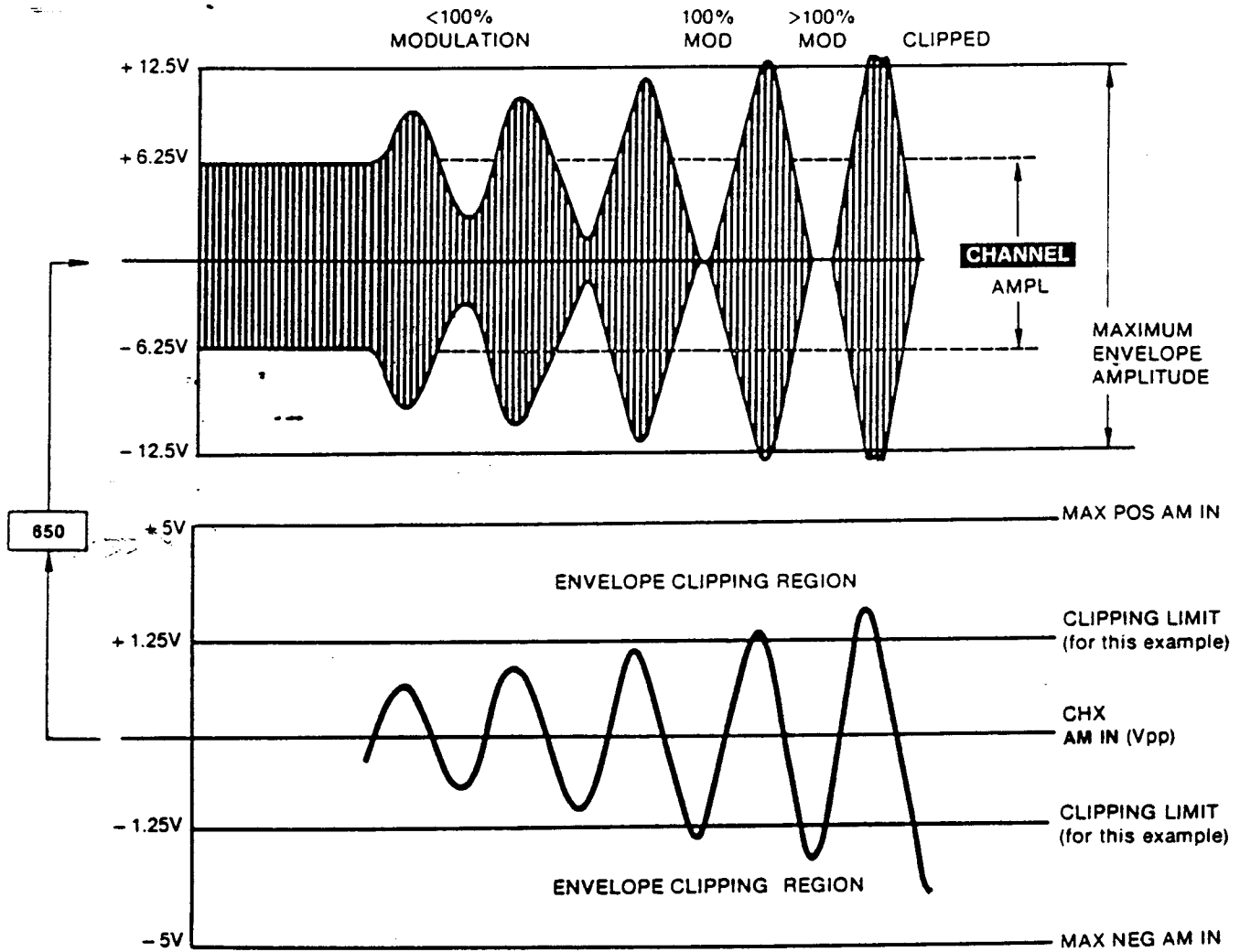

Figure 5-20. **Reset** Key Menu Tree



At 100% modulation, Maximum Envelope Amplitude = 2 (**Channel** AMPL)
 Fixed AM Gain = 10

This formula determines the signal level required for 100% modulation:

$$AM\ In\ (100\%) = \frac{Max\ Envl\ Ampl}{Fixed\ Gain} = \frac{2\ (\text{Channel}\ AMPL)}{10} = \frac{\text{Channel}\ AMPL}{5}$$

$$For\ the\ example\ above,\ AM\ In\ (100\%) = \frac{12.5\ Vpp}{5} = 2.5\ Vpp$$

Figure 5-21. Amplitude Modulation

SECTION 6

GPIB OPERATION

6.1 INTRODUCTION

This section tells how to control the 650 remotely over the GPIB bus.

Section	Page
6.2 General Procedure	6-1
6.3 650 Commands	6-1
6.4 Universal and Addressed Commands	6-9
6.5 Detailed Command Descriptions	6-9
6.6 Service Requests	6-13
6.7 Displaying Messages on the 650	6-18
6.8 GPIB Menu Keys	6-19
6.9 Demonstration Programs	6-21

6.2 GENERAL PROCEDURE

Follow these steps to control the 650 over the GPIB bus:

- 1) Connect the 650 to the GPIB system with the standard GPIB connector. If you plan to use a printer, connect it to the GPIB bus.
- 2) Set the 650's GPIB address to a unique identification number with either the rear panel switch (see section 2) or the front-panel GPIB key. The examples in this manual assume a 650 address of 09. If you have a printer, set its GPIB address.
- 3) Use your controller to write and execute a program for the 650.

6.3 650 COMMANDS

This part discusses the 650 commands and the rules you must follow to apply them.

- 6.3.1 Command Types
- 6.3.2 Command Syntax
- 6.3.3 Command List

6.3.1 Command Types

The 650 has four types of commands: parameter, enumerated, direct, and query.

The following text discusses each type of command separately. The examples terminate the commands with

semicolons (;) or closing quotes ("). See "terminators" in section 6.3.2 for more information.

Parameter Commands. Parameter commands specify a particular numerical value within a continuous range of values.

Format: <header>SPACE<value>TERMINATION

The header specifies the parameter and the value specifies the numerical value. Table 6-2 lists the parameter commands and their allowable value ranges.

Examples:

```
FREQUENCY 2E3;   Selects 2000 Hz frequency
PHASE 387;       Selects 387° phase
SWEETIME 2.39;   Selects 2.39 second sweep
                  time
TRIGGERLEVEL 5.1; Selects 5.1 volt trigger level
```

Enumerated Commands. Enumerated commands provide a list of distinct choices.

Format: <header>SPACE<argument>TERMINATION

The header specifies the parameter and the argument specifies the choice. You can use either a number or a descriptive character string for the argument. Table 6-2 lists the enumerated commands and their arguments.

<u>Example 1</u>	FUNC 3 or FUNC RAMP	Selects the ramp output function
Other	DC	4
Arguments	SINE SQUARE TRIANGLE	0 2 1

<u>Example 2</u>	MODE 4 or MODE BURST	Selects burst operation
Other	ASYNCGATE	2
Arguments	CONTINUOUS PHASELOCK SYNCGATE TRIGGERED	0 5 3 1

Direct Commands. Direct commands make the 650 perform an immediate action.

Format: <header>TERMINATION

The header specifies the action. Direct commands have no value or argument. Table 6-2 lists all the direct commands.

Examples:

- RESET'' Resets 650 parameters
- TRIGGER'' Triggers waveform or sweep
- EXECUTE'' Executes preceding commands in string

Query Commands. Query commands tell the 650 to send information to the controller.

The 650 will not send the information when it receives the command, but will wait until the controller subsequently addresses it as a talker. You can only send query commands one at a time. If you send two or more in a command string, the 650 will respond only to the last one.

Format: <header>?TERMINATION

The header specifies the type of information. Because all parameter command headers (and most enumerated command headers) can also serve as query headers, the question mark tells the 650 to send (rather than receive) the information. Certain other headers appear only in query commands. Table 6-2 lists all the query commands. See Query Commands in section 6.3.2 for a sample query program.

NOTE

When the 650 is asked to report its current phase setting, there may be a 0.001° difference from what was originally programmed. This is correct operation because the unit is externally programmed in decimal, but the internal phase is set in binary. There is, therefore, not always an exact one to one correlation.

Parameter Header Examples

- FREQUENCY?'' Returns current frequency
- PHASE?'' Returns current phase
- TRIGGERFREQ?'' Returns current trigger frequency

Enumerated Header Examples

- FUNCTION?'' Returns current output waveform
- MODE?'' Returns current operating mode
- OUTPUT?'' Returns current output setting

Query Header Examples

- MAINPARAMETERS?'' Returns main parameters
- SRQ?'' Returns contents of SRQ buffer
- STATUSBYTE?'' Returns status byte

6.3.2 650 Command Syntax

Commands sent by an instrument controller to the 650 must follow the syntax given in table 6-1. The following text discusses command operation, command processing, semicolons, minimum uniqueness, and ? commands.

Command String Operation. The command string at the top of the table (written to run on a Wavetek Model 6000 Instrumentation Controller) works as follows:

```
WRITE @709:"FR 2E4;CH 1;OT 1;FN RM;FR;EX"
FR 2E4 sets the main frequency to 20kHz,
CH 1 selects channel 1 for programming,
OT 1 selects ON-50 ohms as the output configuration of channel 1,
FN RM selects a ramp waveform for channel 1,
FR tells the 650 to display the frequency menu, and
EX makes the 650 convert all these commands to a signal output.
```

How Does the 650 Process Commands? The 256-character listen buffer receives the commands from the instrument controller. If it fills up before receiving an EXecute command, it will stop accepting commands, distribute its contents to the next-setup registers, then again accept commands. The commands in the next-setup registers will not take effect until the 650 receives an EXecute.

The listen buffer accepts all commands regardless of syntax errors. When the 650 processes the commands in the listen buffer, it copies the defective commands over into the SRQ buffer and labels them with PE:0 to indicate defective syntax. The parameters and functions that the defective commands would have changed retain their previous values. If a command appears in the SRQ buffer, the 650 ignored it. See figure 6-2.

Terminators. A terminator tells the 650 that it has reached the end of the current command. Although the 650 recognizes both semicolons (;) and spaces as terminators, semicolons greatly simplify debugging. If you use spaces, the 650 will copy (and ignore) all commands after the first defective command into the SRQ buffer. With semicolons, the 650 will accept all good commands and put only the defective ones in the SRQ buffer. Consider these two examples with and without semicolons (the defective command FR2E4 should read FR 2E4):

With Semicolons

```
WRITE @709:"FR2E4;CH 1;OT 1;FN RM;FR;EX"
Message: SRQ = /PE:0 FR2E4*/
```

Without Semicolons

```
WRITE @709:"FR2E4 CH 1 OT 1 FN RM FR EX"
Message: SRQ = /PE:0 FR2E4* CH 1 OT 1 FN RM
FR EX/
```

Minimum Uniqueness. The 650 will interpret the following three command lines exactly the same. String 1 uses the minimum character set each command requires, string 2 uses longer abbreviations that contain each command's minimum character set, while string 3 completely spells out each command. The expansion of the function command (FN 3, FUNC RMP, and FUNCTION RAMP) demonstrates the use of numbers and descriptive character strings in the argument of enumerated commands.

```
WRITE @709:
"FR 2E4;CH 1;OT 1;FN 3;FR;EX" (1)
WRITE @709:"FREQ 2E4;CHAN 1;OUTP 1;FUNC RMP;
FREQ;EXEC" (2)
WRITE @709:"FREQUENCY 2E4;CHANNEL 1;
OUTPUT 1;FUNCTION RAMP;FREQUENCY;
EXECUTE" (3)
```

Query Commands. Query commands (such as FR?) make the 650 return the current setting of the parameter as a string of characters and require a program to make the controller use the returned data. The following Wavetek 6000 program requests the data, accepts it, and writes it to the 6000's screen.

Program Statements	Explanation
10 CLEAR	Clear screen
20 WRITE @709:"FR?"	Write command to 650 (port 7, address 09)
30 DIM STRING\$*25	Dimension string to 25 characters
40 READ @709:STRING\$	Read returning string
50 PRINT STRING\$	Print string to screen
60 END	End program

6.3.3 650 Command List

Table 6-2 uses the following format to list and briefly describe the complete 650 GPIB command set. See the

detailed command descriptions section or the corresponding menu key description for more information about each command.

Command	Range/String	Function
FRrequency	100E-6 to 2E6	Sets main generator frequency
FRrequency?	FREQUENCY n	Returns main generator frequency n
FuNction	0 to 5	Selects channel output waveform
DC	4	DC output
RaMp	3	Ramp output
SiNe	0	Sine output
SQure	2	Square output
TeSt	5	Manufacturing test function
TRiangle	1	Triangle output

Command Column

- 1) Lists commands alphabetically by their full names
- 2) Indicates minimum uniqueness with capital letters
- 3) Indents command arguments

Range/String Column

- 1) Gives the value range for each parameter command
- 2) Gives the argument number range for each enumerated command
- 3) Lists the arguments (names and numbers) for each enumerated command
- 4) Gives the string returned in response to each query command

Function Column

- 1) States briefly the function of each command
- 2) Uses an asterisk (*) to indicate further explanation in the detailed command description section

Minimum Uniqueness. Capital letters (BuRstcount) indicate the minimum letter combination required by the 650. Use just the caps (BR), a longer abbreviation that contains all the caps (BURSTC), or the entire command (BURSTCOUNT).

Other Sources of this Data. The HELP? command and the SYNTAX key provide less complete forms of the data given in table 6-2. HELP? sends a list of all the commands, arguments, and ranges to the GPIB controller, while the SYNTAX key displays (on the 650 screen) the commands without the arguments or ranges.

Table 6-1. 650 Command Syntax

Typical Command Line: WRITE @709:"FR 2E4;CH 1;OT 1;FN RM;FR;EX"	
Syntax	Explanation
WRITE @709:	Varies depending on the controller. This format, for the Wavetek 6000, tells the controller to send the command string out port 7 (the GPIB port) to the 650 (at address 09 on the GPIB bus).
"_"" '_'	Enclose the command string in quotes. Either single or double quotes can serve as string delimiters.
:	Separate commands with semicolons. See "terminators" in the text for the reasons for this requirement.
E	Use exponent notation to avoid entering long strings of zeros. For example, enter 20000 as 2E4 and 0.0005 as 5E-4.
DL DLY DELAY	Use the minimum uniqueness version (DL), a longer version that contains the minimum uniqueness letters (DLY), or the full version (DELAY) of each command in your programming. Table 6-2 spells out the commands and indicates minimum uniqueness with capital letters (DeLay). The text gives examples of full, partial, and minimum uniqueness command strings.
FN 3 FN RM	Enumerated commands that select a function (such as FN, select channel output waveform) allow you to select the function either by number (3) or by name (RM, ramp waveform). Table 6-2 lists the enumerated commands and their arguments.
;CMD;	Drop the numerical value of a parameter command to make the 650 display that parameter's menu. For example, ;AM; will display the channel menu of the currently active channel. Use this feature in step-by-step operation to follow and verify program operation.
EX"	Place an EXecute command at the end of a command string to make the 650 put the commands into effect. The 650 will accept commands and put them in the pending setup registers, but it will not generate their output until you send an EX command. EX also puts the 650 in the "listen for more commands" mode; therefore, do not put EX after a query (?) command as it will prevent the 650 from returning the answer.
?	Replace the numerical value of a parameter command with a ? to make the 650 return the current setting of that parameter as a string of characters. Table 6-2 lists the query commands and shows the format of the returning strings. Query commands also make the 650 display the menu of the requested parameter. The text gives a short program that makes the controller accept and display the returning information. Do not use EX after a ? command.

Table 6-2. 650 Command Set

Command	Range/String	Function
AMplitude	25E-3 to 50	Sets channel output amplitude
AMplitude?	AMPLITUDE n	Returns channel output amplitude
AutoCal	—	Runs auto calibration
AutoCalOFF	—	Disables autocal correction table
AutoCalON	—	Enables autocal correction table
BackLight	0 to 1	Controls display backlight
OFF	0	Turns display backlight off
ON	1	Turns display backlight on
BeeP	—	Turns beep tone on/off
BuRstcount	1 to 65.535E3	Sets number of cycles in burst
BuRstcount?	BURSTCOUNT n	Returns number of cycles in burst
CenterFrequency	100E-6 to 2E6	Sets center frequency of sweep
CenterFrequency?	CENTERFREQUENCY n	Returns center frequency of sweep
CenterPhase	± 9999999.995	Sets center phase of sweep
CenterPhase?	CENTERPHASE n	Returns center phase of sweep
CHannel	1 to 4	Selects channel
CHannel?	CHANNEL n	Returns number of selected channel
CHnParameters?	CH n: parameters	Returns channel parameters*
CONFIGuration	0 to 2	Selects single/multi-unit operation
INdependent	0	Configuration for single unit
MaSter	1	Master phase reference unit
SLave	2	Slave unit
CONFIGuration?	CONFIGURATION n	Returns configuration
DeLay	-2E-3 to 2E-3	Sets waveform phase shift in seconds
DeLay?	DELAY n	Returns waveform phase shift
DeltaFrequency	-1E3 to 1E3	Sets delta frequency shift
DeltaFrequency?	DELTAFREQUENCY n	Returns delta frequency shift
DiSaBlesetting	1 to 25	Disables a stored instrument setup
DiSaBlesetting?	DISABLESETTING n	Returns disabled setup numbers
DuTycycle	0 to 100	Sets duty cycle of square/ramp waves
DuTycycle?	DUTYCYCLE n	Returns duty cycle
ENaBlesetting	1 to 25	Enables a stored instrument setup
ENaBlesetting?	ENABLESETTING n	Returns number of last enabled setup
EXecute	—	Executes command string
EXternalCal?	See detail text	Calculate cable phase delay of select channel*
FRequency	100E-6 to 2E6	Sets main generator frequency
FRequency?	FREQUENCY n	Returns main generator frequency
FRontPanel	0 to 1	Controls access to front panel*
OFF	0	Turns front panel off
ON	1	Turns front panel on
FuNction	0 to 5	Selects channel output waveform
DC	4	DC output
RaMp	3	Ramp output
SiNe	0	Sine output
SQUare	2	Square output
TeSt	5	Manufacturing test function*
TRiangle	1	Triangle output
FuNction?	FUNCTION n	Returns channel's output waveform

*Explained further in Detailed Command Descriptions section.

Table 6-2. 650 Command Set (Continued)

Command	Range/String	Function
GateoFf	—	Closes gate for A-GATE/S-GATE modes
GateoN	—	Opens gate for A-GATE/S-GATE modes
HELP?	See detail text	Sends command list to controller*
HoLD	—	Holds sweep or waveform (see RSM)
HoLDiNput	0 to 1	Selects function of HoLD command
SWeep	0	Makes BNC Hold Input hold sweep
WaVeform	1	Makes BNC hold waveform voltage
HoLDiNput?	HOLDINPUT n	Returns function of hold command
MainParameters?	See section 6.5.6	Returns all the main parameters*
ManualCal	0 to 7	Selects the 7 manual cal steps
ManualCal?	MANUALCAL n	Returns current manual cal step
ManualTrigger	—	Triggers waveforms and sweeps
MarkerFrequency	100E-6 to 2E6	Sets marker frequency
MarkerFrequency?	MARKERFREQUENCY n	Returns marker frequency
MarkerPhase	-10E6 to 10E6	Sets marker phase
MarkerPhase?	MARKERPHASE n	Returns marker phase
Mode	0 to 5	Selects main operating mode
AsyncGate	2	Asynchronous gating mode
BuRst	4	Burst mode
CoNtinuous	0	Continuous waveform mode
PhaseLock	5	Phaselock mode
SyncGate	3	Synchronous gating mode
TRiggered	1	Triggered (one cycle) mode
Mode?	MODE n	Returns main mode
MONitorFreq?	MONITOR FREQUENCY: n	Returns instantaneous frequency
MONitorPhase?	MONITOR PHASE: n	Returns instant phase of swept channel
OFFset	- 25 to 25	Sets waveform offset voltage
OFFset?	OFFSET n	Returns waveform offset voltage
OuTput	0 to 2	Sets channel output impedance
OFF	0	Opens channel output relay
ONfifty	1	Sets channel output impedance to 50 ohms
ONZero	2	Sets channel output impedance to 0 ohms
OuTput?	OUTPUT n	Returns channel output impedance
OVerloadreset	—	Closes output relays opened by overload
PeRiod	500E-9 to 10E3	Sets period of main frequency
PeRiod?	PERIOD n	Returns period of main frequency
PHase	± 9999999.995	Sets phase shift of current channel
PHase?	PHASE n	Returns phase shift of selector channel
QuiCkcal	—	Quick calibrates current setup
RaTio	1 to 99	Sets freq mult of current channel
RaTio?	RATIO n	Returns current channel's freq mult
ReCaLlsetting	0 to 25	Recalls specified stored setup
LaSt	—	Recal's last stored setup
NeXt	—	Recalls next stored setup
ReCaLlsetting?	RECALLSETTING n	Returns number of last called setup
ReSeT	—	Resets all parameters to default*
ReSuMe	—	Resumes sweep or waveform (see HLD)
SeIFTeST	See detail text	Tests hardware, identifies failures*

*Explained further in Detailed Command Descriptions section.

Table 6-2. 650 Command Set (Continued)

Command	Range/String	Function
SeQuenceFreq	100E-6 to 2E6	Sets freq of current index number
SeQuenceFreq?	SEQUENCEFREQ n	Returns freq of current index number
SeQuenceIndex	1 to 99	Selects index number for value entry
SeQuenceIndex?	SEQUENCEINDEX n	Returns current index number
SeQuenceLimit	1 to 99	Sets maximum sequence number
SeQuenceLimit?	SEQUENCELIMIT n	Returns current sequence number limit
SeQuencePhase	± 9999999.995	Sets phase of current index number
SeQuencePhase?	SEQUENCEPHASE n	Returns phase of current index number
SPANFrequency	100E-6 to 2E6	Sets frequency span of sweep
SPANFrequency?	SPANFREQUENCY n	Returns frequency span of sweep
SPANPhase	± 9999999.995	Sets phase span of sweep
SPANPhase?	SPANPHASE n	Returns phase span of sweep
SRQ?	SRQ = /messages/	Returns contents of SRQ buffer*
SRQMask	0 to 255	Selects permitted service requests*
SRQMask?	SRQMASK n	Returns current SRQ mask*
STaRTFrequency	100E-6 to 2E6	Sets start frequency of sweep
STaRTFrequency?	STARTFREQUENCY n	Returns start frequency of sweep
STaRTPhase	± 9999999.995	Sets start phase of sweep
STaRTPhase?	STARTPHASE n	Returns start phase of sweep
STATUS	Not 650 command	6000 serial poll status command*
STatusByte?	STB = n	Returns status byte*
STOPFrequency	100E-6 to 2E6	Sets stop frequency of sweep
STOPFrequency?	STOPFREQUENCY n	Returns stop frequency of sweep
STOPPhase	± 9999999.995	Sets stop phase of sweep
STOPPhase?	STOPPHASE n	Returns stop phase of sweep
SToResetting	1 to 25	Stores 650 setup (specify location)
SToResetting?	STORESETTING n	Returns location of last setup stored
SweepCoMp	0 to 1	Controls sweep error compensation
OFF	0	Turns error compensation on
ON	1	Turns error compensation off
SweepCoMp?	SWEEPCOMP n	Returns sweepcomp status: 0-off, 1-on
SweepFuNction	0 to 3	Selects type of sweep function
LiNear	0	Selects linear sweep function
LoG	1	Selects log sweep function
RaNdom	3	Selects random sweep function
SiNe	2	Selects sine sweep function
SweepFuNction?	SWEEPFUNCTION n	Returns current sweep function
SweepMoDe	0 to 29	Selects sweep mode (listed by number)
OFF	0	Turns sweeping off
FReQCoNTRST	1	Selects sweep mode 1
FReQCoNTREV	2	Selects sweep mode 2
FReQTRiGRST	3	Selects sweep mode 3
FReQTRiGREV	4	Selects sweep mode 4
FReQTRiGHoLDRST	5	Selects sweep mode 5
FReQTRiGHoLDREV	6	Selects sweep mode 6
FReQSYNCFSK	7	Selects sweep mode 7
FReQASYNCFSK	8	Selects sweep mode 8
FReQEXTSEQ	9	Selects sweep mode 9

*Explained further in Detailed Command Descriptions section.

Table 6-2. 650 Command Set (Continued)

Command	Range/String	Function
SweepMoDe (cont)	0-29	Selects sweep mode (listed by number)
FReQCoNTSEQ	10	Selects sweep mode 10
FReQTRiGSEQ	11	Selects sweep mode 11
FReQEXTMOD	12	Selects sweep mode 12
PHaSeCoNTRST	13	Selects sweep mode 13
PHaSeCoNTREV	14	Selects sweep mode 14
PHaSeTRiGRST	15	Selects sweep mode 15
PHaSeTRiGREV	16	Selects sweep mode 16
PHaSeTRiGHoLDRST	17	Selects sweep mode 17
PHaSeTRiGHoLDREV	18	Selects sweep mode 18
PHaSEeXTSEQ	19	Selects sweep mode 19
PHaSeCoNTSEQ	20	Selects sweep mode 20
PHaSeTRiGSEQ	21	Selects sweep mode 21
PHaSeDeLTaFReQ	22	Selects sweep mode 22
PHaSEeXTMOD	23	Selects sweep mode 23
BoTHCoNTRST	24	Selects sweep mode 24
BoTHTRiGHoLDRST	25	Selects sweep mode 25
BoTHEXTSEQ	26	Selects sweep mode 26
BoTHCoNTSEQ	27	Selects sweep mode 27
BoTHTRiGSEQ	28	Selects sweep mode 28
BoTHEXTMOD	29	Selects sweep mode 29
SweepMoDe?	SWEEPMODE n	Returns current sweep mode
SweepTiMe	10E-3 to 10E6	Sets sweep time
SweepTiMe?	SWEEPTIME n	Returns sweep time
TRiGger	—	Triggers waveform or sweep
TriggerFReQ	2.5E-3 to 200E3	Sets internal trigger frequency
TriggerFReQ?	TRIGGERFREQ n	Returns internal trigger frequency
TriggerLeVeL	-10 to 10	Sets response level to external trigger
TriggerLeVeL?	TRIGGERLEVEL n	Returns trigger response level
TriggerSLoPe	0 to 1	Selects response slope of external trigger
Negative	1	Respond to negative external trigger slope
Positive	0	Respond to positive external trigger slope
TriggerSLoPe?	TRIGGERSLOPE n	Returns selected trigger slope
TriggerSouRCe	0 to 1	Selects source of trigger
External	0	Selects external trigger source
Internal	1	Selects internal trigger generator
TriggerSouRCe?	TRIGGERSOURCE n	Returns selected trigger source
VeRSion?	See detail text	Returns 650 software version number*
ViewingAngle	0 to 45	Sets viewing angle of display
ViewingAngle?	VIEWINGANGLE n	Returns viewing angle of display

*Explained further in Detailed Command Descriptions section.

6.4 UNIVERSAL AND ADDRESSED COMMANDS

Universal and addressed (U/A) commands make most GPIB instruments perform generally accepted standard functions. Usually, universal commands control all the instruments on the GPIB bus, while addressed commands control individual instruments at specific addresses on the bus. The 650 accepts the following U/A commands:

Command	Type	Function
DCL	Universal	Device clear
GET	Addressed	Group execute trigger
GTL	Addressed	Go to local
LLO	Universal	Local lock out command
SDC	Addressed	Selected device clear

Section 6.5 (detailed command descriptions) discusses these U/A commands and selected 650 commands in detail.

U/A Syntax. This manual uses generic names to identify the universal and addressed commands and the functions they perform. Individual controllers will use differently named commands to perform these same functions. See the manual for your controller to determine the actual command names and the syntax they require.

6.5 DETAILED COMMAND DESCRIPTIONS

This section describes in detail the 650 commands that perform functions not performed by menu keys and the GPIB universal and addressed commands recognized by the 650. The text groups the commands into functionally related sections. Use the list in the next column to find the section that describes a specific command.

Command	Type	Section
CHnIParameters?	650	6.5.6
DCL	Univ	6.5.6
EXTeRnalCal?	650	6.5.1
FRontPanel	650	6.5.2
FuNction TeSt	650	6.5.3
GET	Addr	6.5.4
GTL	Addr	6.5.2
HELP?	650	6.5.5
LLO	Univ	6.5.2
MaInParameters?	650	6.5.6
ReSeT	650	6.5.6
SDC	Addr	6.5.6
SeIFTeST	650	6.5.7
SRQ?	650	6.6.2
SRQMask	650	6.6.2
SRQMask?	650	6.6.2
STATUS	6000	6.6.2
STatusByte?	650	6.6.2
VeRSion?	650	6.5.8

6.5.1 EXTERNALCAL? Command

The EXTERNALCAL? command measures the signal delay through an external amplifier. Section 7.6, external calibration, explains the process in detail. With the proper amplifier setup, EXTERNALCAL? will return the following string over the GPIB bus:

EXTERNAL PHASE: W DEG AT X HZ
(CHY DELAY Z SEC FROM CH1)

The returned variables W degrees, X Hz, channel Y, and Z seconds depend on your test setup and the amplifier under test.

6.5.2 FRONT PANEL, LLO, and GTL Commands

The 650 limits the operator's use of the front panel with three levels of increasing restriction as shown below:

IF YOU LIMIT FRONT PANEL OPERATION WITH→		NOTHING	GPIB CONTROL	LLO COMMAND	FP COMMAND
THEN, CAN THE OPERATOR:	SEE THE SCREEN DISPLAY?	YES	YES	YES	NO
	DISPLAY MENUS AND PARAMETERS?	YES	YES	YES	NO
	TAKE CONTROL BACK FROM THE GPIB?	YES	YES	NO	NO
	CHANGE PARAMETERS?	YES	NO	NO	NO

GPIB Control. The 650 switches to GPIB control when the controller asserts the GPIB REN (remote enable) line and sends the 650 its listen address. The Wavetek 6000 controller command string WRITE @709:"-command string-" automatically performs these two actions. GPIB control restricts further front panel operation as described in the above table. The 650 will remain under GPIB control until the operator presses the **GPIB LOCAL** key sequence.

LLO Command. All instruments on the bus recognize the universal command LLO; you cannot direct it to just one instrument. LLO restricts operation of the 650 front panel as described in the above table. For the Wavetek 6000 controller, LLO has the format LLO @7, where 7 specifies the GPIB bus port of the controller. The 650 will not make the local lock out effective until it receives another command. The following program demonstrates LLO use:

**Program Statements
(Explanation)**

```
10 LLO @7
   (Sends the LLO to all instruments on the GPIB bus)
20 WRITE @709:"EX"
   (Makes the 650 apply the LLO (any other command
   will also make the 650 apply the LLO))
30 END
   (Ends the program)
```

GTL Command. GTL cancels the LLO command and returns the 650's front panel to full operator control. All instruments on the bus recognize the addressed command GTL; however, you must send it to each instrument individually. The Wavetek 6000 instrument controller uses the LCL command to issue GTL commands. LCL @7 sends GTL commands to all the instruments on the bus, while LCL @709 sends the GTL to just the specified instrument. In these command formats, 7 specifies the GPIB bus port of the controller and 09 the address of a particular instrument on the bus. LCL becomes effective on receipt; the 650 does not require that you follow it with another command.

FRONTPANEL Command. The 650 FP command turns the front panel completely off: no display of menus or parameters, no keys active (except the power switch), no display backlight, no key beeps, no return to local control. Send the FP command to the 650 as follows (FP requires no EXECUTE command):

**Program Statements
(Explanation)**

```
WRITE @709:"FRONTPANEL 0"
   (Turns the front panel off)
WRITE @709:"FRONTPANEL OFF"
   (Turns the front panel off)
WRITE @709:"FRONTPANEL 1"
   (Turns the front panel on)
WRITE @709:"FRONTPANEL ON"
   (Turns the front panel on)
```

6.5.3 FUNCTION TEST Command

The FN command selects the output waveshape for the currently selected channel. Except for TEST, all the menu names (DC, RAMP, SINE, SQUARE, TRIANGLE) describe their waveform. TEST produces a square wave with a frequency of 4096 times the main frequency. We use TEST at the factory to calibrate the lower frequency ranges.

6.5.4 GET Command

The GET command triggers whatever trigger function you have set up within the 650. All instruments on the bus recognize the GPIB addressed command GET (group execute trigger); however, you can send it to just one instrument at a time. For the Wavetek 6000 controller, the TRG command sends the group execute trigger to individual instruments on the GPIB bus. TRG has the format TRG @709, where 7 specifies the GPIB bus port of the controller and 09 the address of a particular instrument on the bus. The 650 triggers the selected function immediately on receipt of the TRG command.

6.5.5 HELP? Command

The HELP? command makes the 650 return a list of the 650's primary and secondary commands and their limits as a string to the controller. HELP? requires you to write a program to make the controller accept and print the returned list. The following Wavetek 6000 program requests the list, accepts it, and sends it to a printer connected to the GPIB bus. To make this program work, set the address switches of your printer to 04. Table 6-2 provides the same information as the list this program prints.

**Program Statements
(Explanation)**

```
10 CLEAR
   (Clear screen)
```

```

20 DIM HELP$*255
   (Dimension string to 255 characters)
30 PRINTER IS @704
   (Print to address 04 on GPIB bus [port 7])
40 WRITE @709:"HELP?"
   (Write HELP? to 650 [port 7, address 09])
50 FOR INDEX = 1 to 200
   (Repeat lines 50-80 200 times)
60 READ @709:HELP$
   (Read string to next carriage return)
70 PRINT HELP$
   (Send line to printer buffer)
80 NEXT INDEX
   (End of index loop)
90 PRINTER IS @0
   (Return printing to controller screen)
100 PRINT "HELP PRINT COMPLETE"
   (Display message on controller screen)
110 END
   (End program)
    
```

Running the above program will produce the following printout. A "HELP PRINT COMPLETE" message will appear on the 6000's screen when the controller finishes sending the HELP file to the printer's buffer and not when the printer finishes printing. The zeros appearing at the end of the printout complete 200 cycles through the INDEX loop.

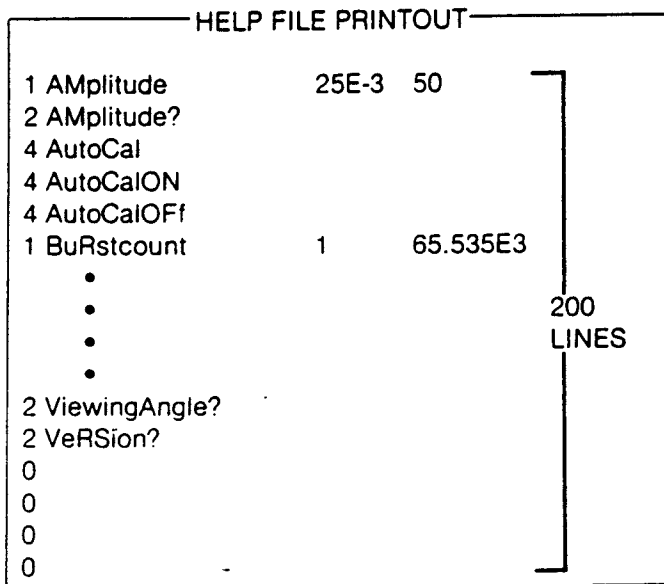

6.5.6 MAINPARAMETERS?, CHNLPARAMETERS?, DCL, SDC, and RESET Commands

The following text explains the parameter and reset commands, then uses the parameter commands to display the power-up conditions of the 650.

MAINPARAMETERS? Command. The MNP? command makes the 650 return the current setting of the 650's main parameters as a string to the controller.

CHNLPARAMETERS? Command. The CHP? command makes the 650 return the parameters of the currently selected channel as a string to the controller.

The MNP? and CHP? commands make the 650 send a valid command string to the controller. The controller can save this string, then send it back to the 650 at a later time to restore the parameters to their previous values.

DCL and SDC Commands. The DCL and SDC commands reset the 650 to the power-up conditions, but leave it in the remote (GPIB-controlled) mode. All instruments on the bus recognize the GPIB universal command DCL (device clear). Individual instruments recognize the GPIB addressed command SDC (selected device clear). For the Wavetek 6000 controller, the DCL command issues DCL and SDC. To reset everything on the bus, use DCL @7, where 7 specifies the GPIB bus port of the controller. To reset just one instrument, use DCL @709, where 09 specifies the instrument address. The 650 resets itself immediately when it receives either command.

RESET Command. The RST command resets the 650 to the power-up conditions.

Demonstration Program. Both MAINPARAMETERS? and CHNLPARAMETERS? require a program to make the controller use the returned data. The following Wavetek 6000 program first resets the 650 to the power-up conditions, then requests, accepts, and writes both the main parameters and the channel parameters to the 6000's screen.

Program Statements (Explanation)

```

100 CLEAR
   (Clear screen)
110 DIM STRING$*255
   (Dimension string to 255 characters)
120 WRITE @709:"RST;EX"
   (Write RESET to 650 [at address 709])
130 WRITE @709:"MNP?"
   (Write MAINPARAMETERS? to 650 [at address 709])
140 READ @709:STRING$
   (Read string returning from address 709)
150 PRINT STRING$
   (Print string [main parameters] to screen)
160 PRINT
   (Separate data strings with a blank line)
170 WRITE @709:"CH 1"
   (Select channel 1 for parameters inquiry)
    
```

```

180 WRITE @ 709:"CHP?"
      (Write CHNLPARAMETERS? to 650 [at address 709])
190 READ @ 709:STRING$
      (Read string returning from address 709)
200 PRINT STRING$
      (Print string (CH1 parameters) to screen)
210 PRINT
      (Separate data strings with a blank line)
220 WRITE @ 709:"CH 2"
      (Select channel 2 for parameters inquiry)
230 WRITE @ 709:"CHP?"
      (Write CHNLPARAMETERS? to 650 [at address 709])
240 READ @ 709:STRING$
      (Read string returning from address 709)
250 PRINT STRING$
      (Print string [CH2 parameters] to screen)
260 END
      (End program)

```

Running the above program will produce the following display:

```

FR 1E3,M 0,BR 2,TSRC 0,TSLP 0,TLVL 1.4,TFRQ
200,STM 1,SMD 0, SFN 0,STRTF 1E3,STOPF
10E3,MF 5E3,SQL 10,CONFIG 0,HLDN 0

CH 1: AM 5,OF 0,PH 0,FN 0,OT 0,RT 1,DT 50,DL
0,STRTP 0, STOPP 360,MP 180,DF 0

CH 2: AM 5,OF 0,PH 0,FN 0,OT 0,RT 1,DT 50,DL
0,STRTP 0, STOPP 360,MP 180,DF 0

```

By using table 6-2, we can expand the abbreviations above into the full parameter names as follows:

```

FREQUENCY 1000, MODE 0 (CONTINUOUS),
BURSTCOUNT 2, TRIGGERSOURCE 0 (EXTERNAL),
TRIGGERSLOPE 0 (POSITIVE), TRIGGERLEVEL 1.4
(VOLTS), TRIGGERFREQ 200, SWEEPTIME 1,
SWEEPMODE 0, SWEEPFUNCTION 0 (LINEAR),
STARTFREQUENCY 1000, STOPFREQUENCY
10000, MARKERFREQUENCY 5000, SEQUENCE-
LIMIT 10, CONFIGURATION 0 (INDEPENDENT),
HOLDINPUT 0 (SWEEP)

```

```

CHANNEL 1: AMPLITUDE 5, OFFSET 0, PHASE 0,
FUNCTION 0 (SINE), OUTPUT 0 (OFF), RATIO 1,
DUTYCYCLE 50, DELAY 0, STARTPHASE 0, STOP-
PHASE 360, MARKERPHASE 180, DELTAFRE-
QUENCY 0

```

```

CHANNEL 2: AMPLITUDE 5, OFFSET 0, PHASE 0,
FUNCTION 0 (SINE), OUTPUT 0 (OFF), RATIO 1,
DUTYCYCLE 50, DELAY 0, STARTPHASE 0, STOP-
PHASE 360, MARKERPHASE 180, DELTAFRE-
QUENCY 0

```

6.5.7 SELFTEST Command

The SELFTEST command tests the circuitry of the 650. It allows a controller to test the 650 at the beginning of the week, at the start of each day, just before an extended operating cycle, or at any other time, then continue or not, depending on the results of the test.

The SELFTEST command performs the same series of 24 hardware tests as the self-test function of the utility menu tree. Testing proceeds until a test fails or all tests pass. A test failure aborts all following tests. SELFTEST reports only the first error. It does not report all errors.

The 650 will report the results of SELFTEST to the controller only if you have enabled EV (event) messages with the SRQMASK command. SELFTEST reports to the controller by generating an SRQ (service request) and loading one of 25 possible messages in the SRQ buffer. The message EV:6:0 indicates that all tests passed. The message EV:6:## indicates a failure (## identifies the failing test). The controller determines the results of SELFTEST by reading the SRQ buffer. Table 6-5, SRQ Event Messages, gives the complete list of SELFTEST messages.

6.5.8 VERSION? Command

The VRS? command makes the 650 return the software version of the 650 as a string of characters. VRS? requires a program to make the controller use the returned string. The following Wavetek 6000 program requests the version, accepts it, and writes it to the 6000's screen.

Program Statements (Explanation)

```

10 CLEAR
      (Clear screen)
20 WRITE @ 709:"VRS?"
      (Write VERSION? to 650 [port 7, address 09])
30 DIM VERSION$*50
      (Dimension string to 50 characters)
40 READ @ 709:VERSION$
      (Read returning string)
50 PRINT VERSION$
      (Print string to screen)
60 END
      (End program)

```

Running the above program will produce the following display:

```

WAVETEK MODEL 650 (Vx.y) (z CHANNELS)

```

In this display, x gives the version number, y gives the revision number, and z gives the number of installed channels.

6.6 SERVICE REQUESTS

This part discusses the concepts of service requests, describes the commands associated with them, then lists the service request messages the 650 generates. See section 6.9 for a program that demonstrates the principles discussed in this part.

6.6.1 SRQ Concepts

The following text discusses the service request, the status byte, the SRQ buffer, and the SRQ key.

What Does the Service Request Tell the Controller? The 650 service request tells the controller that the 650 wants attention. The 650 makes the request by asserting the SRQ line of the GPIB bus. Because any instrument on the bus can assert this line, the controller must read the status byte of each instrument in turn to determine which one requested attention.

What Does the 650 Status Byte Tell the Controller? The 650 uses four of the eight bits in its status byte. One tells the controller if the 650 requested service. The others indicate the type or types of messages (programming error, hardware error, or event complete) the 650 wants to send. Figure 6-1 shows the format of the 650 status byte. If the controller wants to know the specific message within the category, it must read the 650's SRQ buffer.

What Does the 650's SRQ Buffer Tell the Controller? The 650's SRQ buffer stores the programming error messages, hardware error messages, and event complete messages until the controller can read them. Tables 6-3, 6-4, and 6-5 list all the SRQ messages.

SRQ Key. The SRQ key (displayed as menu key F6 when you press the **GPIB** front panel key) allows the operator to send a service request to the controller from the front panel. For example, the controller could ask the operator to change the connections of the test setup, then press SRQ.

6.6.2 SRQ Commands

The following text discusses the commands related to the service request mask, the status byte, and the service request messages.

SRQMASK Command. The SRQM command makes the 650 selectively ignore one or more of the three types of conditions that make it produce service requests. For example, if you masked out programming errors, the 650 would not load messages for specific programming

errors into the SRQ buffer and it would not set the PE and service request bits in the status byte. Figure 6-1 shows the bit positions and the corresponding decimal mask values required to block out PE, HE, and EV messages.

SRQMASK? Command. The SRQM? command makes the 650 return the current mask setting to the controller. The 650 sends the SRQ mask setting as the character string SRQMASK #, where # gives the decimal equivalent of the binary mask bits. To use SRQMASK?, write a program that first asks the 650 to send the mask, then tells the controller how to receive and process the returning string.

STATUS Command. STATUS (a command of the Wavetek 6000 controller) enables the 6000 to determine what instrument on the GPIB bus requested service (other controllers may or may not have an equivalent command). STATUS has the format STATUS @709:STATUSBYTE, where 7 specifies the GPIB port of the 6000, 09 specifies the setting of the address switches of a specific instrument, and STATUSBYTE specifies an arbitrary name for the storage location where the controller will store the status number. A typical program will use a series of STATUS commands (one for each instrument on the bus) to conduct a serial poll to determine which instrument requested service. STATUS reads, **then resets**, the status byte of the 650. In response to the STATUS command, the 650 sends the decimal equivalent of its status byte. To use STATUS, you must write a program that first asks the 650 to send the status byte, then tells the controller how to receive and process the returning numerical value.

STATUSBYTE? Command. The STB? command makes the 650 send its current status byte to the controller over the GPIB bus. The 650 sends its status byte as a string of characters with the format STB = ##, where ## gives the decimal equivalent of the status byte. STATUSBYTE? reads, **but does not reset**, the status byte of the 650. To use STATUSBYTE?, you must write a program that first asks the 650 to send the status byte, then tells the controller how to receive and process the returning string.

SRQ? Command. The SRQ? command makes the 650 send the contents of the SRQ buffer to the controller over the GPIB bus. The 650 sends its SRQ buffer contents as a string of characters with the format SRQ = MESSAGES, where MESSAGES represents a string of messages. Reading the SRQ buffer empties it. To use SRQ?, you must write a program that first asks the 650 to send the SRQ buffer messages, then tells the controller how to receive and process them.

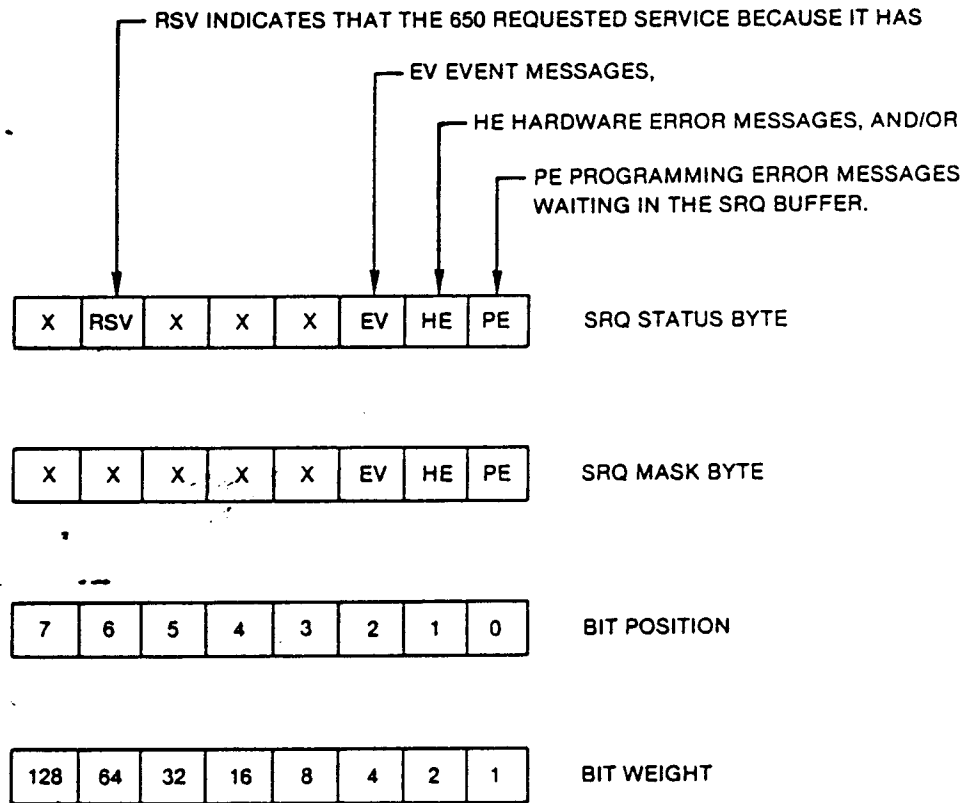

PERMISSABLE SRQ MASK BYTES								COMMAND	ENABLES
0	0	0	0	0	0	0	0	SRQMASK 0	NOTHING
0	0	0	0	0	0	0	1	SRQMASK 1	PE
0	0	0	0	0	0	1	0	SRQMASK 2	HE
0	0	0	0	0	0	1	1	SRQMASK 3	HE-PE
0	0	0	0	0	1	0	0	SRQMASK 4	EV
0	0	0	0	0	1	0	1	SRQMASK 5	EV-PE
0	0	0	0	0	1	1	0	SRQMASK 6	EV-HE
0	0	0	0	0	1	1	1	SRQMASK 7	EV-HE-PE

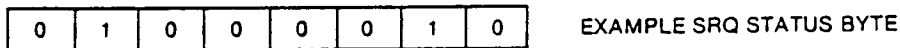

The above status byte tells the controller that the 650 requested service because of a hardware error.

Figure 6-1. 650 Status Byte and SRQ Mask

6.6.3 SRQ Messages

SRQ Message Format. The 650 puts messages in the SRQ buffer in this general format:

SRQ = /PE:n Description//HE:n Description//
EV:n Description/

Slashes (/) enclose each message. PE identifies a programming error message, HE a hardware error message, and EV an event complete message. "n" identifies a specific message within the type. This fixed-format header allows a computer to easily parse (decode) the message. "Description" describes the error in English for the benefit of human readers. Table 6-3 lists all the SRQ programming error messages, table 6-4 lists all the SRQ hardware error messages, and table 6-5 lists all the SRQ event messages.

After sending an SRQ event message command, the instrument will return the correct message and other true messages not related to the request. Notice that all event messages are preceded by the characters "EV:" followed by a number indicating the message type. Example: "EV:5" is the autocal complete message.

For event messages, search for the "EV:" and the message following. Ignore all other parts of the string.

The selftest command generates an "execute complete" message and a "selftest complete" message during execution. Although this is not specified, it is normal operation. Only one "execute complete" message is generated during a selftest.

Table 6-3 (Part 1). SRQ Programming Error Messages

FORMAT: SRQ = /PE:0 SYNTAX//PE:1 LIMIT//PE:2:n CONFLICT//PE:3 STORED SETTING/

PE:0 SYNTAX	/PE:0 defective command string/	
PE:1 LIMIT	/PE:1 AMPLITUDE ERROR/ /PE:1 BURSTCOUNT ERROR/ /PE:1 CENTERFREQUENCY ERROR/ /PE:1 CENTERPHASE ERROR/ /PE:1 CHANNEL ERROR/ /PE:1 CONFIGURATION ERROR/ /PE:1 DELAY ERROR/ /PE:1 DELTAFREQUENCY ERROR/ /PE:1 DISABLESETTING ERROR/ /PE:1 DUTYCYCLE ERROR/ /PE:1 ENABLESETTING ERROR/ /PE:1 FREQUENCY ERROR/ /PE:1 FUNCTION ERROR/ /PE:1 HOLDINPUT ERROR/ /PE:1 MANUALCAL ERROR/ /PE:1 MARKERFREQUENCY ERROR/ /PE:1 MARKERPHASE ERROR/ /PE:1 MODE ERROR/ /PE:1 OFFSET ERROR/ /PE:1 OUTPUT ERROR/ /PE:1 PERIOD ERROR/ /PE:1 PHASE ERROR/ /PE:1 RATIO ERROR/	/PE:1 RECALLSETTING ERROR/ /PE:1 SEQUENCEFREQ ERROR/ /PE:1 SEQUENCEINDEX ERROR/ /PE:1 SEQUENCELIMIT ERROR/ /PE:1 SEQUENCEPHASE ERROR/ /PE:1 SPANFREQUENCY ERROR/ /PE:1 SPANPHASE ERROR/ /PE:1 SRQMASK ERROR/ /PE:1 STARTFREQUENCY ERROR/ /PE:1 STARTPHASE ERROR/ /PE:1 STOPFREQUENCY ERROR/ /PE:1 STOPPHASE ERROR/ /PE:1 STORESETTING ERROR/ /PE:1 SWEEPCOMP ERROR/ /PE:1 SWEEPFUNCTION ERROR/ /PE:1 SWEEPMODE ERROR/ /PE:1 SWEPTIME ERROR/ /PE:1 TRIGGERFREQ ERROR/ /PE:1 TRIGGERLEVEL ERROR/ /PE:1 TRIGGERSLOPE ERROR/ /PE:1 TRIGGERSOURCE ERROR/ /PE:1 VIEWINGANGLE ERROR/

Table 6-3 (Part 2). SRQ Programming Error Messages

<p>PE:2 CONFLICT</p>	<p>/PE:2:0 *** ampl/ofst ratio warning ***/ /PE:2:1 *** ampl/ofst clipping limit ***/ /PE:2:2 *** min ampl 0.25v in zero ohm ***/ /PE:2:3 *** 200 KHz max in trig mode ***/ /PE:2:4 *** 200 KHz max in tri/ramp ***/ /PE:2:5 *** duty cycle 20-80% in square ***/ /PE:2:6 *** (freq x ratio) > 2 MHz ***/ /PE:2:7 *** int trig not allowed ***/ /PE:2:8 *** cannot sweep in phase lock ***/ /PE:2:9 *** CH1-DC not allowed in PLL ***/ /PE:2:10 *** time .2 sec min in nonlinear ***/ /PE:2:11 ** swptime 50 msec min when comp on **/ /PE:2:12 ** int trig not allowed in sweep mode **/ /PE:2:13 ** sweep cntr/span phase conflict **/ (with phase start) /PE:2:14 ** sweep cntr/span freq conflict **/ (with freq start) /PE:2:15 ** sweep cntr/span phase conflict **/ (with phase stop) /PE:2:16 ** sweep cntr/span freq conflict **/ (with freq stop)</p> <p>13-16: Converting your center/span parameters into start/stop values resulted in a start or stop that exceeds the 650's limits.</p>
<p>PE:3 STORED SETTING</p>	<p>/PE:3 STORED SETTING ERROR/ (indicates faulty data or an attempt to recall a disabled or empty setting)</p>

Table 6-4. SRQ Hardware Error Messages

FORMAT: SRQ = /HE:n MESSAGE/

<p>HE:n HARDWARE</p>	<p>/HE:0 OUTPUT PROTECTION ACTIVATED/ /HE:1 PLL NOT LOCKED/ /HE:2 LOW BATTERY = X.X V/</p> <p>3.0V to 2.4V Good battery. Normal voltage operating range. 2.4V to 2.0V Failing battery. Data remains protected, but the 650 will generate low-battery warning messages. The battery will decline from 2.4 to 2.0 volts in 10 to 100 hours. 2.0V to 0V Dead battery. Data loss.</p> <p>/HE:3 AUTO CAL DATA ERROR/ (Checksum error detected in stored auto cal data at power up. Rerun autocalibration.)</p>
---------------------------------	--

Table 6-5 (Part 1). SRQ Event Messages

FORMAT: SRQ = /EV:n MESSAGE/

<p>EV:n GENERAL EVENTS</p>	<p>/EV:0 BURST COMPLETE/ /EV:1 SWEEP COMPLETE/ /EV:2:00 QUICK CAL COMPLETED/ (no errors in any channel) /EV:2:n1 QUICK CAL COMPLETED/ (channel n amplitude error) /EV:2:n2 QUICK CAL COMPLETED/ (channel n offset error) /EV:2:n3 QUICK CAL COMPLETED/ (channel n phase error) /EV:3 EXECUTE COMPLETE/ (command string executed) /EV:4 FRONT PANEL/ (operator pressed GPIB SRQ button)</p>																																																																																																																																																																																																																																																																																																																			
<p>EV:5 AUTO CAL</p>	<p>/EV:5: HHHHHHHH AUTO CAL COMPLETE 00000000 No errors in any channel. HH----- CH1 Auto Cal Hexadecimal Error Number --HH---- CH2 Auto Cal Hexadecimal Error Number ----HH-- CH3 Auto Cal Hexadecimal Error Number -----HH CH4 Auto Cal Hexadecimal Error Number</p>																																																																																																																																																																																																																																																																																																																			
	<p style="text-align: center;">BINARY EQUIVALENT</p> <table border="1" style="width: 100%; text-align: center;"> <thead> <tr> <th>HH</th> <th>X</th> <th>X</th> <th>X</th> <th>F</th> <th>P</th> <th>S</th> <th>O</th> <th>A</th> </tr> </thead> <tbody> <tr><td>00</td><td>0</td><td>0</td><td>0</td><td>0</td><td>0</td><td>0</td><td>0</td><td>0</td></tr> <tr><td>01</td><td>0</td><td>0</td><td>0</td><td>0</td><td>0</td><td>0</td><td>0</td><td>1</td></tr> <tr><td>02</td><td>0</td><td>0</td><td>0</td><td>0</td><td>0</td><td>0</td><td>1</td><td>0</td></tr> <tr><td>03</td><td>0</td><td>0</td><td>0</td><td>0</td><td>0</td><td>0</td><td>1</td><td>1</td></tr> <tr><td>04</td><td>0</td><td>0</td><td>0</td><td>0</td><td>0</td><td>1</td><td>0</td><td>0</td></tr> <tr><td>05</td><td>0</td><td>0</td><td>0</td><td>0</td><td>0</td><td>1</td><td>0</td><td>1</td></tr> <tr><td>06</td><td>0</td><td>0</td><td>0</td><td>0</td><td>0</td><td>1</td><td>1</td><td>0</td></tr> <tr><td>07</td><td>0</td><td>0</td><td>0</td><td>0</td><td>0</td><td>1</td><td>1</td><td>1</td></tr> <tr><td>08</td><td>0</td><td>0</td><td>0</td><td>0</td><td>1</td><td>0</td><td>0</td><td>0</td></tr> <tr><td>09</td><td>0</td><td>0</td><td>0</td><td>0</td><td>1</td><td>0</td><td>0</td><td>1</td></tr> <tr><td>0A</td><td>0</td><td>0</td><td>0</td><td>0</td><td>1</td><td>0</td><td>1</td><td>0</td></tr> <tr><td>0B</td><td>0</td><td>0</td><td>0</td><td>0</td><td>1</td><td>0</td><td>1</td><td>1</td></tr> <tr><td>0C</td><td>0</td><td>0</td><td>0</td><td>0</td><td>1</td><td>1</td><td>0</td><td>0</td></tr> <tr><td>0D</td><td>0</td><td>0</td><td>0</td><td>0</td><td>1</td><td>1</td><td>0</td><td>1</td></tr> <tr><td>0E</td><td>0</td><td>0</td><td>0</td><td>0</td><td>1</td><td>1</td><td>1</td><td>0</td></tr> <tr><td>0F</td><td>0</td><td>0</td><td>0</td><td>0</td><td>1</td><td>1</td><td>1</td><td>1</td></tr> </tbody> </table>	HH	X	X	X	F	P	S	O	A	00	0	0	0	0	0	0	0	0	01	0	0	0	0	0	0	0	1	02	0	0	0	0	0	0	1	0	03	0	0	0	0	0	0	1	1	04	0	0	0	0	0	1	0	0	05	0	0	0	0	0	1	0	1	06	0	0	0	0	0	1	1	0	07	0	0	0	0	0	1	1	1	08	0	0	0	0	1	0	0	0	09	0	0	0	0	1	0	0	1	0A	0	0	0	0	1	0	1	0	0B	0	0	0	0	1	0	1	1	0C	0	0	0	0	1	1	0	0	0D	0	0	0	0	1	1	0	1	0E	0	0	0	0	1	1	1	0	0F	0	0	0	0	1	1	1	1	<p style="text-align: center;">BINARY EQUIVALENT</p> <table border="1" style="width: 100%; text-align: center;"> <thead> <tr> <th>HH</th> <th>X</th> <th>X</th> <th>X</th> <th>F</th> <th>P</th> <th>S</th> <th>O</th> <th>A</th> </tr> </thead> <tbody> <tr><td>10</td><td>0</td><td>0</td><td>0</td><td>1</td><td>0</td><td>0</td><td>0</td><td>0</td></tr> <tr><td>11</td><td>0</td><td>0</td><td>0</td><td>1</td><td>0</td><td>0</td><td>0</td><td>1</td></tr> <tr><td>12</td><td>0</td><td>0</td><td>0</td><td>1</td><td>0</td><td>0</td><td>1</td><td>0</td></tr> <tr><td>13</td><td>0</td><td>0</td><td>0</td><td>1</td><td>0</td><td>0</td><td>1</td><td>1</td></tr> <tr><td>14</td><td>0</td><td>0</td><td>0</td><td>1</td><td>0</td><td>1</td><td>0</td><td>0</td></tr> <tr><td>15</td><td>0</td><td>0</td><td>0</td><td>1</td><td>0</td><td>1</td><td>0</td><td>1</td></tr> <tr><td>16</td><td>0</td><td>0</td><td>0</td><td>1</td><td>0</td><td>1</td><td>1</td><td>0</td></tr> <tr><td>17</td><td>0</td><td>0</td><td>0</td><td>1</td><td>0</td><td>1</td><td>1</td><td>1</td></tr> <tr><td>18</td><td>0</td><td>0</td><td>0</td><td>1</td><td>1</td><td>0</td><td>0</td><td>0</td></tr> <tr><td>19</td><td>0</td><td>0</td><td>0</td><td>1</td><td>1</td><td>0</td><td>0</td><td>1</td></tr> <tr><td>1A</td><td>0</td><td>0</td><td>0</td><td>1</td><td>1</td><td>0</td><td>1</td><td>0</td></tr> <tr><td>1B</td><td>0</td><td>0</td><td>0</td><td>1</td><td>1</td><td>0</td><td>1</td><td>1</td></tr> <tr><td>1C</td><td>0</td><td>0</td><td>0</td><td>1</td><td>1</td><td>1</td><td>0</td><td>0</td></tr> <tr><td>1D</td><td>0</td><td>0</td><td>0</td><td>1</td><td>1</td><td>1</td><td>0</td><td>1</td></tr> <tr><td>1E</td><td>0</td><td>0</td><td>0</td><td>1</td><td>1</td><td>1</td><td>1</td><td>0</td></tr> <tr><td>1F</td><td>0</td><td>0</td><td>0</td><td>1</td><td>1</td><td>1</td><td>1</td><td>1</td></tr> </tbody> </table>	HH	X	X	X	F	P	S	O	A	10	0	0	0	1	0	0	0	0	11	0	0	0	1	0	0	0	1	12	0	0	0	1	0	0	1	0	13	0	0	0	1	0	0	1	1	14	0	0	0	1	0	1	0	0	15	0	0	0	1	0	1	0	1	16	0	0	0	1	0	1	1	0	17	0	0	0	1	0	1	1	1	18	0	0	0	1	1	0	0	0	19	0	0	0	1	1	0	0	1	1A	0	0	0	1	1	0	1	0	1B	0	0	0	1	1	0	1	1	1C	0	0	0	1	1	1	0	0	1D	0	0	0	1	1	1	0	1	1E	0	0	0	1	1	1	1	0	1F	0	0	0	1	1	1	1	1
HH	X	X	X	F	P	S	O	A																																																																																																																																																																																																																																																																																																												
00	0	0	0	0	0	0	0	0																																																																																																																																																																																																																																																																																																												
01	0	0	0	0	0	0	0	1																																																																																																																																																																																																																																																																																																												
02	0	0	0	0	0	0	1	0																																																																																																																																																																																																																																																																																																												
03	0	0	0	0	0	0	1	1																																																																																																																																																																																																																																																																																																												
04	0	0	0	0	0	1	0	0																																																																																																																																																																																																																																																																																																												
05	0	0	0	0	0	1	0	1																																																																																																																																																																																																																																																																																																												
06	0	0	0	0	0	1	1	0																																																																																																																																																																																																																																																																																																												
07	0	0	0	0	0	1	1	1																																																																																																																																																																																																																																																																																																												
08	0	0	0	0	1	0	0	0																																																																																																																																																																																																																																																																																																												
09	0	0	0	0	1	0	0	1																																																																																																																																																																																																																																																																																																												
0A	0	0	0	0	1	0	1	0																																																																																																																																																																																																																																																																																																												
0B	0	0	0	0	1	0	1	1																																																																																																																																																																																																																																																																																																												
0C	0	0	0	0	1	1	0	0																																																																																																																																																																																																																																																																																																												
0D	0	0	0	0	1	1	0	1																																																																																																																																																																																																																																																																																																												
0E	0	0	0	0	1	1	1	0																																																																																																																																																																																																																																																																																																												
0F	0	0	0	0	1	1	1	1																																																																																																																																																																																																																																																																																																												
HH	X	X	X	F	P	S	O	A																																																																																																																																																																																																																																																																																																												
10	0	0	0	1	0	0	0	0																																																																																																																																																																																																																																																																																																												
11	0	0	0	1	0	0	0	1																																																																																																																																																																																																																																																																																																												
12	0	0	0	1	0	0	1	0																																																																																																																																																																																																																																																																																																												
13	0	0	0	1	0	0	1	1																																																																																																																																																																																																																																																																																																												
14	0	0	0	1	0	1	0	0																																																																																																																																																																																																																																																																																																												
15	0	0	0	1	0	1	0	1																																																																																																																																																																																																																																																																																																												
16	0	0	0	1	0	1	1	0																																																																																																																																																																																																																																																																																																												
17	0	0	0	1	0	1	1	1																																																																																																																																																																																																																																																																																																												
18	0	0	0	1	1	0	0	0																																																																																																																																																																																																																																																																																																												
19	0	0	0	1	1	0	0	1																																																																																																																																																																																																																																																																																																												
1A	0	0	0	1	1	0	1	0																																																																																																																																																																																																																																																																																																												
1B	0	0	0	1	1	0	1	1																																																																																																																																																																																																																																																																																																												
1C	0	0	0	1	1	1	0	0																																																																																																																																																																																																																																																																																																												
1D	0	0	0	1	1	1	0	1																																																																																																																																																																																																																																																																																																												
1E	0	0	0	1	1	1	1	0																																																																																																																																																																																																																																																																																																												
1F	0	0	0	1	1	1	1	1																																																																																																																																																																																																																																																																																																												
	<p>A = Amplitude compensation error P = Phase compensation error F = Filter compensation error S = Symmetry compensation error O = Offset compensation error X = Not used</p>																																																																																																																																																																																																																																																																																																																			
	<p>Example: 001A0000 indicates filter, phase, and offset compensation errors in channel 2.</p>																																																																																																																																																																																																																																																																																																																			

Table 6-5 (Part 2). SRQ Event Messages

FORMAT: SRQ = /EV:n MESSAGE/

<p>EV:6 SELFTEST EVENTS</p>	<p>/EV:6:0 SELF TEST COMPLETE, PASSED ALL TESTS/ /EV:6:n SELF TEST COMPLETE, TEST FAILED/</p> <ul style="list-style-type: none"> 1 ROM Test 2 RAM Test 3 DVM Test 4 Battery Test 5 GPIO Test 6 Phase Engine Test 7 10 MHz Ref Test 8 DACOUT Test (Waveform DAC) 9 6-Pole Filter Test (Waveform Filter) 10 Sample/Hold DAC Ampl/Ofst Test 11 Amplitude Test on DACOUT Board (Amplitude Control) 12 Amplitude Compensation Test 13 XY-Multiplier Test 14 High-Voltage Amp Test (Output Amplifier) 15 Attenuator Test 16 Output Protection Test 17 SQW Symmetry DAC Test (Square Wave Symmetry) 18 Peak Detector Test 19 Phase Accumulator Test 20 Phase Detector Test 21 TRLV and EXT TRIG Test (External Trigger) 22 Channel 1 Sync Out Test (Sync Out) 23 Phase Lock VCO Test (Phase Lock Loop) 24 Internal Trigger 25 End of Test Table
<p>EV:7 EXTERNAL PHASE CAL EVENTS</p>	<p>/EV:7 EXTERNAL PHASE CAL COMPLETE/</p>

6.7 DISPLAYING MESSAGES ON THE 650 SCREEN

The 650 can accept messages from the GPIB bus and display them on the screen. Use this feature to give instructions to an operator or display information.

Command Format. Send messages in this format:

WRITE @709: " 'LINE1/LINE2/LINE3/LINE4' "

The standard double quotes (") identify the command string.

The single quotes (') identify the contents as a message rather than commands.

The slashes (/) indicate new lines.

Messages do not require an EXecute command.

Although the 650 accepts either single or double quotes as string delimiters, the Wavetek 6000 interprets the double quotes as its own program string delimiters. This restricts you to single quotes for 650 display strings when using the 6000. Other controllers might reverse this situation.

Message Size. The screen will allow a maximum message size of four lines of 40 characters per line. The 650 will ignore any lines or characters beyond these limits.

Erasing. Press any menu key or send another GPIB command string to return to normal 650 displays. To erase the previous message, send a new message.

Example 1. The following message command will create the display shown. The periods (.) indicate blank spaces.

```
WRITE @ 709: " FRONT PANEL LINE 1/FRONT PANEL
LINE 2/..FRONT PANEL LINE 3/...FRONT PANEL
LINE 4' "
```

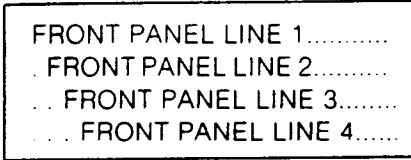

(4 lines,
40 characters/line)

Example 2. The following message command will create a completely blank screen.

```
WRITE @ 709: " '////' "
```

6.8 GPIB MENU KEYS

This part describes the operation of the six keys in the GPIB menu. Press the **GPIB** key to bring the GPIB menu to the screen.

6.8.1 ADRS Key

Function. The ADRS key enables entry of an alternate GPIB address from the front panel.

GPIB Address. The GPIB bus address identifies the 650 to the controller. The rear-panel Address Selector switch determines the 650's power-up address, which also serves as the operating address until an address entered at the front panel (with the ADRS key) supercedes it. The Front Panel Enable toggle on the Address Selector switch can enable and disable front panel address entry. In the command string `WRITE @ 709: "CH 1 OT 1 EX"`, the digits 09 specify the 650 address.

Operation. Press the ADRS key to display the current GPIB address on the top line of the display. Key in the new address on the number keypad, then press **Execute**. The decimal and binary versions of the new address will appear on the display. If the 650 loses power, the address reverts to the rear panel address.

6.8.2 LOCAL Key

Function. The LOCAL key switches control of the 650 from the GPIB bus to the front panel.

GPIB vs Front Panel Control. Receipt of any GPIB command (if the controller simultaneously asserts the REN line of the GPIB) by the 650 disables the front panel to the extent that you can call menus and read parameter settings, but you cannot change modes or numbers. Pressing the LOCAL key returns full control to the front panel. The universal GPIB command LLO not only partially disables the front panel, but also disables the

LOCAL key so you cannot return to full control. The FRONT PANEL command completely disables the front panel (no backlight, no menus, no beeps, and no return to full control with the LOCAL key).

Operation. Press the LOCAL key to return control of the 650 to the front panel.

6.8.3 LSNBUF Key

Function. The LSNBUF key allows you to see all the commands received by the 650 over the GPIB bus.

Listen Buffer. The 256-character last-in-first-out listen buffer receives the commands from the GPIB bus and stores them until the controller stops transmitting. After the transmission ends, the 650 processes the commands in the listen buffer. If the buffer fills up during transmission, it stops accepting commands, distributes its contents to the pending registers, then again accepts commands. The commands in the pending registers will not become effective until an EX command executes them. Old commands flow out the high end of the LSNBUF. New commands enter the low (000) end.

Operation. Press the LSNBUF key to call the listen buffer to the screen, then scroll through it with the cursor knob. The buffer contents appear on the top line of the display in the format shown in figure 6-2.

Non-Printing Character. Non-Printing characters in the listen buffer appear as follows on the 650 screen.

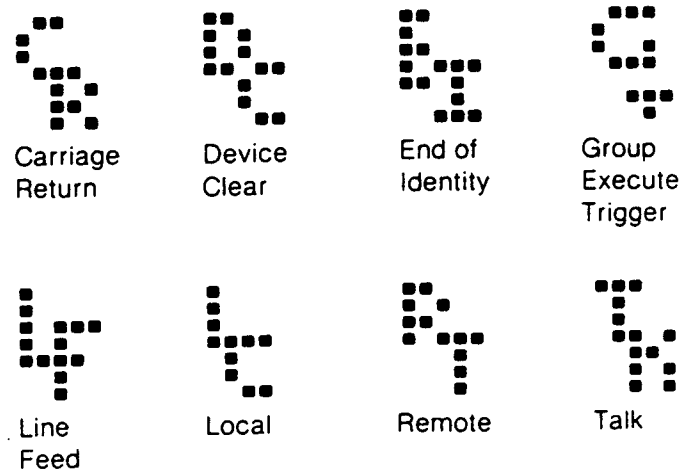

6.8.4 SRQ Key

Function. The SRQ key allows the operator to send a "key-pressed" service request to the controller. It also displays the status byte (see section 6.6, service requests).

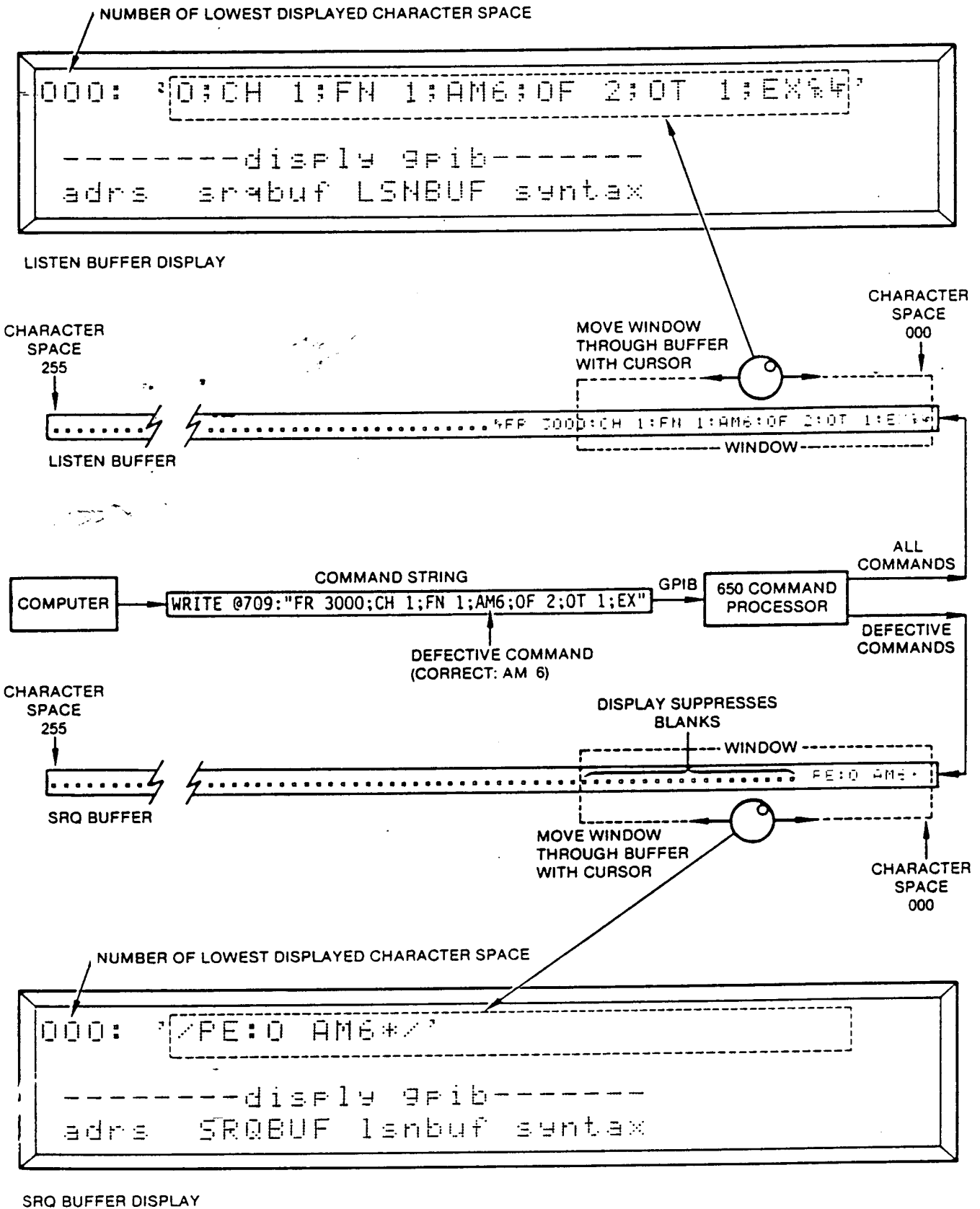

Figure 6-2. How the 650 Displays the Listen and SRQ Buffers

Typical Application. Occasionally, automatic testing must stop while the operator changes the test setup. In such a case, the controller could ask the operator to make the changes, then press SRQ. When the controller services the resulting request and finds the "key-pressed" message, it knows that the operator has finished. See the detailed description of the SRQ? command and the SRQ Demonstration Program for more information.

6.8.5 SRQBUF Key

Function. The SRQBUF key allows you to see all the service request messages generated by the 650.

Service Request Buffer. The last-in-first-out service request buffer holds messages for the controller. These messages describe programming errors, hardware failures in the 650, and the occurrence of events. Slashes (/) separate messages. If the SRQ buffer fills up, you will lose any new messages. Reading the buffer empties it. To avoid losing messages, make a practice of reading the buffer before it fills up. See section 6.6 and tables 6-3, 6-4, and 6-5 (SRQ Messages) for more information.

Operation. Press the SRQBUF key to call the service request buffer to the screen, then scroll through it with the cursor knob. The buffer contents appear on the top line of the display in the format shown in figure 6-2.

6.8.6 SYNTAX Key

Function. To help you program, the SYNTAX key calls a list of the primary GPIB commands to the 650's screen.

Other Sources of this Data. The HELP? command sends a complete list of the commands, arguments, and limits to the controller. Table 6-2 in this manual also lists all the commands, arguments, and limits and, in addition, gives a brief functional description of each one.

Operation. Press the SYNTAX key to call the GPIB command list, then scroll through it with the cursor knob. Get argument numbers from table 6-2 or call the enumerated function's menu to the 650 screen and read its number (in parentheses) from the top line of the display.

SYNTAX Format: <full header>:<minimum form>

Examples: AMPLITUDE:AM
 BURSTCOUNT:BR
 CHANNEL:CH
 RESET:RST

6.9 DEMONSTRATION PROGRAMS

The following programs demonstrate operation of the 650 over the GPIB bus.

Section	Title	Page
6.9.1	Triggered Frequency Sweep GPIB Demonstration Program (Wavetek 6000)	6-21
6.9.2	Triggered Frequency Sweep GPIB Demonstration Program (IBM PC/National)	6-22
6.9.3	SRQ GPIB Demonstration Program (Wavetek 6000)	6-23

6.9.1 Triggered Frequency Sweep Demonstration Program (Wavetek 6000)

Function. This program uses a Wavetek 6000 Instrumentation Computer to make the 650 produce a triggered frequency sweep. Section 6.9.2 shows how to produce the same triggered sweep with an IBM PC.

Program Conventions. In the following program, the number 709 tells the Wavetek 6000 two things: 1) to read and write through port 7 (the 6000's GPIB port) and 2) to write to and read from the instrument (the 650) at address 09 on the GPIB bus. Set the GPIB address of the 650 to 09 with its rear panel switches or with the **GPIB** ADRS key.

Code. The following code lines appear as you should write them on a Wavetek 6000 to produce a triggered frequency sweep.

```
10 WRITE @709:"MODE 0;STRTFREQ 1E3;
   STOPFREQ 1E4;SWEPTIME 10;
   SWEEPFUNCTION 0;SWEEPMODE 3"
20 WRITE @709:"CH 1;OUTPUT 1;AMPL 5;FUNC 0;
   PHASE 0;EXECUTE"
30 WRITE @709:"TRIGGER"
40 END
```

Explanation of Code. The following text explains the code line-by-line. The indented description below each command states in English the task the command orders the computer to perform.

```
10 WRITE @709:"MODE 0;STRTFREQ 1E3;
   STOPFREQ 1E4;SWEPTIME 10;
   SWEEPFUNCTION 0; SWEEPMODE 3"
```

Send the series of commands enclosed in quotes over the GPIB bus (port 7 of the 6000) to the instrument that has its address switches set to 09 (in this case, the 650). The commands in the string give the 650 the following operating parameters:

MODE 0: Continuous output waveform.
 STRTFREQ 1E3: Start the sweep at 1000 Hz.
 STOPFREQ 1E4: Stop the sweep at 10,000 Hz.
 SWEEPTIME 10: Sweep time of 10 seconds.
 SWEEPFUNCTION 0: Linear sweep function.
 SWEEPMODE 3: Sweep mode 3 (triggered frequency sweep with automatic reset).

20 WRITE @709: "CH 1;OUTPUT 1;AMPL 5;FUNC 0; PHASE 0;EXECUTE"

Send the series of commands enclosed in quotes to the 650. The program requires this second line of commands because of the 6000's limit on string lengths. The commands in the string give the 650 the following operating parameters:

CH 1: Give the following parameters to channel 1.
 OUTPUT 1: 50 ohm output impedance.
 AMPL 5: 5 volts peak-to-peak amplitude.
 FUNC 0: Sine wave output.
 PHASE 0: 0° phase shift.
 EXECUTE: Make all the conditions from both WRITE lines take effect.

30 WRITE @709: "TRIGGER"

Send a trigger command to the 650.

40 END

End execution of the program.

Operation. Enter the above program into a 6000 controller, turn on the 650, then press the 6000's RUN key.

6.9.2 Triggered Frequency Sweep Demonstration Program (IBM-PC/National)

Function. This program uses an IBM PC fitted with a National Instruments GPIB card to make the 650 produce a triggered frequency sweep. Section 6.9.1 shows how to produce the same triggered sweep with a Wavetek 6000 Instrumentation Controller.

GPIB Card. National Instruments of Austin, Texas manufactures the GPIB-PC2A circuit card and the software that supports it.

Program Conventions. This example (written in BASICA) assumes that you have installed the National card in your IBM PC according to their instructions. Your choice of options during National's installation procedure can vary the code. For example, we did not change National's default device names. Hence, the code uses DEV9 to reach the instrument (the 650) at address 09 on the GPIB bus. Set the GPIB address of the 650 to 09 with its rear panel switches or with the GPIB ADRS key.

Code. The following code lines appear as you should write them on the IBM-PC/National to produce a triggered frequency sweep.

```
(Lines 1-99: File DECL.BAS)
100 BDNAMES$ = "DEV9"
200 CALL IBFIND (BDNAMES$,DEV9%)
300 IF DEV9% < 0 THEN GOTO 800
400 WRT$ = "MODE 0;STRTFREQ 1E3;
      STOPFREQ 1E4;SWEEPTIME 10;
      SWEEPFUNCTION 0;SWEEPMODE 3;CH 1;
      OUTPUT 1;AMPL 5;FUNC 0;PHASE 0;EXECUTE"
500 CALL IBWRT (DEV9%,WRT$)
600 CALL IBTRG (DEV9%)
700 STOP
800 PRINT "IBFIND ERROR"
900 STOP
```

Explanation of Code. The following text explains the code line-by-line. The indented description below each command states in English the task the command orders the computer to perform.

(Lines 1-99: File DECL.BAS)

National requires that programs begin with 99 lines of initialization code. They supply the code as file DECL.BAS on their software diskette. Their instructions tell you how to modify the code to suit your system.

100 BDNAMES\$ = "DEV9"

Assign the name DEV9 to the instrument (in this case, the 650) at address 09 on the GPIB bus.

200 CALL IBFIND (BDNAMES\$,DEV9%)

Open DEV9 and return the number that the system will use internally to identify the instrument.

300 IF DEV9% < 0 THEN GOTO 800

Check the returning instrument identity number. A number less than 0 indicates an error.

```
400 WRT$ = "MODE 0;STRTFREQ 1E3;
      STOPFREQ 1E4;SWEEPTIME 10;
      SWEEPFUNCTION 0;SWEEPMODE 3;CH 1;
      OUTPUT 1;AMPL 5;FUNC 0;PHASE 0;EXECUTE"
```

Assign to the string WRT\$ the 650 commands enclosed in quotes. String WRT\$, when sent, will give the 650 the following operating parameters:

MODE 0: Continuous output waveform.
 STRTFREQ 1E3: Start the sweep at 1000 Hz.
 STOPFREQ 1E4: Stop the sweep at 10,000 Hz.
 SWEEPTIME 10: Sweep time of 10 seconds.

SWEEPFUNCTION 0: Linear sweep function.
 SWEEPMODE 3: Sweep mode 3 (triggered frequency sweep with auto reset).
 CH 1: Give the following parameters to channel 1.
 OUTPUT 1: 50 ohm output impedance.
 AMPL 5: 5 volts peak-to-peak amplitude.
 FUNC 0: Sine wave output.
 PHASE 0: 0° phase shift.
 EXECUTE: Make all the above conditions take effect.

500 CALL IBWRT (DEV9%,WRT\$)

Send the string WRT\$ over the GPIB bus to the instrument that has its address switches set to 09 (in this case, the 650). When the 650 receives the EXECUTE command, it will make all the commands in the string take effect.

600 CALL IBTRG (DEV9%)

Trigger DEV9.

700 STOP

Stop execution of the program.

800 PRINT "IBFIND ERROR"

Print the message in quotes if directed to by line 300.

900 STOP

Stop execution of the program.

Operation. Enter the above program into the IBM-PC/National, turn on the 650, then press the IBM RUN key.

6.9.3 SRQ GPIB Demonstration Program (Wavetek 6000)

Function. This program demonstrates operation of the service request, the status byte, the SRQ buffer, the SRQ key, and the SRQ?, SRQMASK, SRQMASK?, and STATUS commands.

Program Conventions. In the following program, (written for the Wavetek 6000 Instrumentation Computer) the number 709 tells the 6000 two things: 1) to read and write through port 7 (the 6000's GPIB port) and 2) to write to and read from the instrument (the 650) at address 09 on the GPIB bus. Modify the program commands as required to suit your controller's conventions. Set the GPIB address of the 650 to 09 with its rear panel switches or with the **GPIB** ADRS key.

Structure. The four parts of the SRQ program perform the specific functions listed below:

Part 1: Set and read SRQMASK

- Demonstrates SRQMask (set mask) command

- Demonstrates SRQMask? (read mask) command
- Extracts the mask number from the text label sent with it
- Converts the mask number into binary form

Part 2: Read initial status and SRQ

- Demonstrates the STATUSBYTE? (read status) command
- Demonstrates the STATUS (serial poll status) command
- Converts the status byte into binary form
- Demonstrates the SRQ? (read SRQ buffer) command

Part 3: Reread above after format error command

- Sends a defective 650 string, then repeats the steps of part 2:
 - Reads new status byte with STATUSBYTE? command
 - Reads new status byte with STATUS command
 - Converts new status byte into binary form
 - Reads new contents of SRQ buffer
 - Rereads status byte to show that reading it with STATUS reset it
 - Rereads SRQ buffer to show that reading it with SRQ reset it

Part 4: Demonstrate SRQ and SRQ button

- Sets up SRQ handling
- Waits for SRQ (caused by operator pressing SRQ button)
- Reads SRQ buffer, then searches for the "button pressed" message
- Prints "Button Pressed" to screen if search finds the button message
- Demonstrates how to handle other (non-button) messages

Code. The following code lines appear exactly as you should write them on a Wavetek 6000 to produce an operating program.

```
100 CLEAR
110 PRINT "SRQ DEMONSTRATION PROGRAM"
120 PRINT
130 !
140 PRINT "PART 1: SET AND READ SRQMASK"
150 WRITE @709:"SRQMASK 7"
160 WRITE @709:"SRQMASK?"
170 READ @709:SRQMASK$
180 PRINT SRQMASK$
190 LET LENGTH = LEN(SRQMASK$)
200 LET MNUMBER$ = SRQMASK$(9:LENGTH)
210 LET MNUMBER = VAL(MNUMBER$)
```

```

220 PRINT "BINARY SRQMASK";
    BSTR$(MNUMBER,8)
230 PRINT
240 !
250 PRINT "PART 2: READ INITIAL STATUS AND
    SRQ"
260 WRITE @709:"STATUSBYTE?"
270 READ @709:STATUSBYTE$
280 PRINT STATUSBYTE$
290 STATUS @709:STATUSBYTE
300 PRINT "DECIMAL STATUSBYTE ";STATUSBYTE
310 PRINT "BINARY EQUIVALENT ";
    BSTR$(STATUSBYTE,8)
320 DIM SRQMESSAGES$*255
330 WRITE @709:"SRQ?"
340 READ @709:SRQMESSAGES$
350 PRINT SRQMESSAGES$
360 PRINT
370 !
380 PRINT "PART 3: REREAD ABOVE AFTER
    FORMAT ERROR COMMAND"
390 WRITE @709:"CH 1;PH180;EX"
400 WAIT DELAY .1
410 WRITE @709:"STATUSBYTE?"
420 READ @709:STATUSBYTE$
430 PRINT STATUSBYTE$
440 STATUS @709:STATUSBYTE
450 PRINT "DECIMAL STATUSBYTE ";STATUSBYTE
460 PRINT "BINARY EQUIVALENT ";
    BSTR$(STATUSBYTE,8)
470 WRITE @709:"SRQ?"
480 READ @709:SRQMESSAGES$
490 PRINT SRQMESSAGES$
500 WRITE @709:"STATUSBYTE?"
510 READ @709:STATUSBYTE$
520 PRINT STATUSBYTE$
530 WRITE @709:"SRQ?"
540 READ @709:SRQMESSAGES$
550 PRINT SRQMESSAGES$
560 PRINT
570 !
580 PRINT "PART 4: DEMONSTRATE SRQ AND
    SRQ BUTTON"
590 PRINT "WAITING FOR OPERATOR TO PRESS
    SRQ BUTTON"
600 STATUS @709:DUMMY
610 PROCESS EVENT SRQ" @07.02"
620 CONNECT EVENT SRQ
630 !WRITE @709:"CH 1;PH180;EX"
640 WAIT EVENT SRQ
650 WRITE @709:"SRQ?"
660 READ @709:SRQMESSAGES$
670 PRINT SRQMESSAGES$

```

```

680 LET EVENTPOSITION = POS
    (SRQMESSAGES$,"EV:4",1)
690 IF EVENTPOSITION>0 THEN
700 PRINT "OPERATOR HAS PRESSED SRQ
    BUTTON"
710 END IF
720 IF EVENTPOSITION = 0 THEN
730 PRINT "OTHER SRQ MESSAGE RECEIVED"
740 END IF
750 STATUS @709:DUMMY
760 END

```

Explanation of Code. The following text explains the code line-by-line. The indented description below each command states in English the task the command orders the computer to perform.

```

100 CLEAR
    Clear the screen of the controller.

110 PRINT "SRQ DEMONSTRATION PROGRAM"
    Print the message in quotes on the first line of the
    controller screen.

120 PRINT
    Print a blank line on the second line of the screen.

130 !
    Ignore this comment line (blank comment lines
    visually separate the major parts of the code).

140 PRINT "PART 1: SET AND READ SRQMASK"
    Print the message in quotes on screen as the title
    for part 1 of the program.

150 WRITE @709:"SRQMASK 7"
    Send the command SRQMASK 7 over the GPIB bus
    (port 7 of the 6000) to the instrument that has its
    address switches set to 09 (in this case, the 650).
    The command SRQMASK 7 tells the 650 to set all
    three lower bits of its status mask to 1 to permit
    transmission of all error categories (see figure 6-1).

160 WRITE @709:"SRQMASK?"
    Send the command SRQMASK? to the 650.
    SRQMASK? makes the 650 send back the current
    setting of its SRQ mask as a string of characters with
    this format: SRQMASK #, where # gives the decimal
    value of the current setting.

```

170 READ @709:SRQMASK\$

Store the string sent back by instrument 09 in string location SRQMASK\$.

180 PRINT SRQMASK\$

Print on screen the contents of string location SRQMASK\$.

190 LET LENGTH = LEN(SRQMASK\$)

Set the value of the numerical variable LENGTH to the length of the SRQMASK\$ string. For the string "SRQMASK 7", LENGTH would equal 9. (This and the next two commands extract the SRQ mask number from the SRQ mask string.)

200 LET MNUMBER\$ = SRQMASK\$(9:LENGTH)

Extract from the string stored in string location SRQMASK\$ the substring beginning at location 9 and ending at location LENGTH. Store this substring in string location MNUMBER\$. For the string "SRQMASK 7", MNUMBER\$ would get the string "7".

210 LET MNUMBER = VAL(MNUMBER\$)

Convert the string stored in location MNUMBER\$ into the numeric value it represents.

220 PRINT "BINARY SRQMASK";BSTR\$(MNUMBER,8)

Print the heading BINARY SRQMASK on the controller screen, then print after it on the same line in an 8-bit string format the binary equivalent of the number stored in location MNUMBER.

230 PRINT

Print a blank line on the screen.

240 !

Ignore this comment line (blank comment lines visually separate the major parts of the code).

250 PRINT "PART 2: READ INITIAL STATUS AND SRQ"

Print the message in quotes on screen as the title for part 2 of the program.

260 WRITE @709:"STATUSBYTE?"

Send the command STATUSBYTE? to the 650. The command STATUSBYTE? makes the 650 send back its status byte as a string of characters with this format: STB = ##, where ## gives the decimal equivalent of the status byte.

270 READ @709:STATUSBYTE\$

Store the string sent back by the 650 in string location STATUSBYTE\$.

280 PRINT STATUSBYTE\$

Print on screen the contents of string location STATUSBYTE\$.

290 STATUS @709:STATUSBYTE

Make the 650 send the numerical value of its status byte back to the controller. Store the value in numeric location STATUSBYTE. Reset the 650's status byte to zero.

300 PRINT "DECIMAL STATUSBYTE ";STATUSBYTE

Print the heading DECIMAL STATUSBYTE on the controller screen, then print after it on the same line the number stored in location STATUSBYTE.

310 PRINT "BINARY EQUIVALENT ";
BSTR\$(STATUSBYTE,8)

Print the heading BINARY EQUIVALENT on the controller screen, then print after it on the same line in an 8-bit string format the binary equivalent of the number stored in location STATUSBYTE.

320 DIM SRQMESSAGES\$*255

Assign a length of 255 characters to the string location SRQMESSAGES\$. (This location will receive the contents of the SRQ buffer, which can hold a maximum of 255 characters.)

330 WRITE @709:"SRQ?"

Send the command SRQ? to the 650. The command SRQ? makes the 650 send back the contents of its SRQ buffer as a string of characters with this format: SRQ = MESSAGES. In operation, the alphanumeric string of message numbers and their translations will replace the word MESSAGES.

340 READ @709:SRQMESSAGES\$

Store the string sent back by the 650 in string location SRQMESSAGES\$.

350 PRINT SRQMESSAGES\$

Print on screen the contents of string location SRQMESSAGES\$.

360 PRINT

Print a blank line on the screen.

370 !

Ignore this comment line (blank comment lines visually separate the major parts of the code).

380 PRINT "PART 3: REREAD ABOVE AFTER FORMAT ERROR COMMAND"

Print the message in quotes on screen as the title for part 3 of the program.

390 WRITE @709:"CH 1;PH180;EX"

Send the format error command string enclosed between the quotation marks to the 650. The command CH 1 (ok) tells the 650 that the following commands in the string apply to channel 1. The format error command PH180 (correct version: PH 180) tells the 650 to set the phase shift of channel 1 to 180 degrees. The command EX tells the 650 to execute the command string (change the outputs to the settings given).

400 WAIT DELAY .1

Wait for one tenth of a second before going to the next command. This delay gives the 650 enough time to receive the command string, set the status byte, and load the SRQ buffer. Normal programs would handle service requests with an SRQ handling routine and would not require this delay command.

410 WRITE @709:"STATUSBYTE?"

420 READ @709:STATUSBYTES

430 PRINT STATUSBYTES

440 STATUS @709:STATUSBYTE

450 PRINT "DECIMAL STATUSBYTE ";STATUSBYTE

460 PRINT "BINARY EQUIVALENT ";

BSTR\$(STATUSBYTE,8)

470 WRITE @709:"SRQ?"

480 READ @709:SRQMESSAGES\$

490 PRINT SRQMESSAGES\$

Read and print the status byte and SRQ buffer to show the effect of the defective command string. These commands duplicate commands 260 through 350 in part 2.

500 WRITE @709:"STATUSBYTE?"

510 READ @709:STATUSBYTES

520 PRINT STATUSBYTES

Reread and display the status byte. This shows that the STATUS command in line 440 reset the status byte.

530 WRITE @709:"SRQ?"

540 READ @709:SRQMESSAGES\$

550 PRINT SRQMESSAGES\$

Reread and display the SRQ buffer. This shows that the SRQ? command in line 470 emptied the SRQ buffer.

560 PRINT

Print a blank line on the screen.

570 !

Ignore this comment line (blank comment lines visually separate the major parts of the code).

580 PRINT "PART 4: DEMONSTRATE SRQ AND SRQ BUTTON"

Print the message in quotes on screen as the title for part 4 of the program.

590 PRINT "WAITING FOR OPERATOR TO PRESS SRQ BUTTON"

Print the message in quotes on the screen.

600 STATUS @709:DUMMY

Reset the 650's status byte to 0. The non-used storage location DUMMY completes the format requirements of the STATUS command.

610 PROCESS EVENT SRQ"@07.02"

The PROCESS EVENT command defines an external event which will interrupt and control some part of the program's operation. This particular command assigns the event name SRQ to the setting of bit 02 of interface 07 (the GPIB port of the 6000). Bit two corresponds to a service request by an instrument on the bus.

620 CONNECT EVENT SRQ

Enable the controller to report to the program when EVENT SRQ occurs (the PROCESS EVENT command defined this event).

630 !WRITE @709:"CH 1;PH180;EX"

Ignore this command because the exclamation point that precedes it makes it into a comment line. (Later, the operator will remove the exclamation point to show how the following code handles unexpected SRQ messages.)

640 WAIT EVENT SRQ

Stop execution of the program until event SRQ occurs. In this case, wait for the operator to press the front panel SRQ key. Go to the next step when the event occurs.

```
650 WRITE @709:"SRQ?"
660 READ @709:SRQMESSAGES$
670 PRINT SRQMESSAGES$
```

Read and display the messages in the 650's SRQ buffer.

```
680 LET EVENTPOSITION = POS(SRQMESSAGES$,
"EV:4",1)
```

Search through the string stored in string location SRQMESSAGES\$ for the substring contained in quotations ("EV:4"). Begin searching at the first character of the string. Store the numerical value of the substring's starting position in numeric location EVENTPOSITION. If no EV:4 exists, store 0 in EVENTPOSITION. EV:4 in the SRQ buffer's messages indicates that the operator pressed the front panel SRQ button. Search for EV:4 to make sure that some other unexpected problem did not cause the 650 to send a service request to the controller.

```
690 IF EVENTPOSITION > 0 THEN
700 PRINT "OPERATOR HAS PRESSED SRQ
BUTTON"
710 END IF
```

If the variable EVENTPOSITION exceeds zero, the substring EV:4 appears in the SRQ buffer messages. Therefore, display the message OPERATOR HAS PRESSED SRQ BUTTON on the screen.

```
720 IF EVENTPOSITION = 0 THEN
730 PRINT "OTHER SRQ MESSAGE RECEIVED"
740 END IF
```

If the variable EVENTPOSITION equals zero, the substring EV:4 does not appear in the SRQ buffer messages. Therefore, display the message OTHER SRQ MESSAGE RECEIVED.

```
750 STATUS @709:DUMMY
```

Reset the 650's status byte to 0. The non-used storage location DUMMY completes the format requirements of the STATUS command.

```
760 END
```

Stop execution of the program.

Operation. Enter the above program into a 6000 controller, turn on the 650, then press the 6000's RUN key. The following screen display will appear:

```
SRQ DEMONSTRATION PROGRAM      1
                                2
PART 1: SET AND READ SRQMASK   3
```

```
SRQMASK 7                      4
BINARY SRQMASK 00000111       5
```

```
PART 2: READ INITIAL STATUS AND SRQ 7
STB = 0                          8
DECIMAL STATUSBYTE 0            9
BINARY EQUIVALENT 00000000     10
SRQ =                            11
```

```
PART 3: REREAD ABOVE AFTER FORMAT 13
ERROR COMMAND
STB = 69                          14
DECIMAL STATUSBYTE 69          15
BINARY EQUIVALENT 01000101     16
SRQ = /PE:0 PH180*//EV:3 EXECUTE COMPLETE/ 17
STB = 0                          18
SRQ =                            19
```

```
PART 4: DEMONSTRATE SRQ AND SRQ 21
BUTTON
WAITING FOR OPERATOR TO PRESS SRQ 22
BUTTON
```

To continue, press the **GPIB** key on the 650, then press the SRQ key. The following lines will appear:

```
SRQ = /EV:4 FRONT PANEL/      23
OPERATOR HAS PRESSED SRQ BUTTON 24
```

Next, follow these steps:

Step	Action	Response
1)	Press the 650's SRQ button three more times.	No response on the 6000's screen.
2)	Press the 6000's RUN key to rerun the program.	Display lines 1-22 will reappear with lines 7-11 changed as follows:

```
PART 2: READ INITIAL STATUS AND SRQ 7
STB = 68                          8
DECIMAL STATUSBYTE 68            9
BINARY EQUIVALENT 01000100     10
SRQ = /EV:4 FRONT PANEL//EV:4 FRONT 11
PANEL//EV:4 FRONT PANEL/
```

```
PART 3: REREAD ABOVE AFTER FORMAT 13
ERROR COMMAND
STB = 69                          14
DECIMAL STATUSBYTE 69          15
BINARY EQUIVALENT 01000101     16
SRQ = /PE:0 PH180*//EV:3 EXECUTE COMPLETE/ 17
STB = 0                          18
SRQ =                            19
```

The initial status has changed because you pressed the SRQ button three times before running the program the second time. Lines 13-19 read the same as they did for the first run of the program because reading the status for display line 9 reset the status byte and reading the error messages for display line 11 emptied the SRQ buffer.

Next, we will demonstrate how the program handles unexpected SRQ messages as it waits for the operator to press the SRQ button. First, call up the program listing on the 6000 controller. Go to code line 630 and remove the ! to change 630 from a comment line to an active line:

```
630 !WRITE @709:"CH 1;PH180;EX" (Before)
630 WRITE @709:"CH 1;PH180;EX" (After)
```

Press the 6000's RUN key to run the program. Code line 630 will now force part 4 of the code to process the PE:0 (programming error) and EV:3 (event) messages rather than the EV:4 message it expects. All the display lines on the 6000 screen will appear as shown above for the first time you ran the program, with the exception of lines 23 and 24:

PART 4: DEMONSTRATE SRQ AND SRQ	21
BUTTON	
WAITING FOR OPERATOR TO PRESS SRQ	22
BUTTON	
SRQ = /PE:0 PH180*//EV:3 EXECUTE COMPLETE/	23
OTHER SRQ MESSAGE RECEIVED	24

SECTION 7

CALIBRATION

7.1 INTRODUCTION

The 650 has five types of calibration. This introduction shows how they relate to one another; the sections give step-by-step procedures for each one. The detailed **Unity** key description in section 5 describes the calibration menus.

Section	Page
7.2 Manual Calibration	7-2
7.3 Auto Calibration	7-10
7.4 Quick Calibration	7-11
7.5 System Calibration	7-12
7.6 External Calibration	7-15

Manual Calibration. Manual calibration performs three major functions.

- It calibrates the 650's 10 MHz reference oscillator and built-in digital voltmeter. The 10MHz oscillator determines the frequency accuracy of the 650, while the digital voltmeter enables auto-cal and quick-cal to calibrate the 650.
- It adjusts the purity of each channel's output waveforms. Purity adjustments minimize distortion in the sine wave output and aberration in the square wave output.
- It brings the channels into the range of auto calibration by flattening each channel's frequency response and calibrating each channel's output at one amplitude and one frequency.

Manual calibration requires external test equipment and the adjustment of internal controls.

Auto Calibration. To complete 650 calibration, automatic calibration performs two functions on each channel.

- It measures and stores (in amplitude correction tables) each channel's offset and amplitude corrections at fixed points along the amplitude and offset ranges.
- It measures and stores (in gain and phase correction tables) corrections for each channel at discrete frequencies from 156kHz to 2MHz.

During operation, the 650 interpolates between the values in the tables and applies the results to keep the output within specification regardless of the amplitude, offset, and frequency settings. Auto calibration automatically corrects for temperature changes and component aging.

Auto calibration requires no test equipment and takes less than 2 minutes.

Quick Calibration. Quick calibration gives the highest possible accuracy by measuring the errors and calculating corrections for the exact amplitude, offset, and frequency settings of the 650, rather than interpolating between auto calibration's measured values. This method eliminates any minor interpolation errors and corrects for very recent temperature changes. Calibration reverts to the auto-cal values if you change any setting. Quick-cal requires no external equipment and takes less than 5 seconds.

System Calibration. Up to ten Model 650 units can interconnect to provide up to 40 channels of synchronized signals. Each individual 650 requires a standard manual calibration, then the interconnected system of units requires a special auto calibration procedure.

External Calibration. In many applications, the 650 must drive equipment through external amplifiers. Such amplifiers can add unacceptable phase delay to the signals. External calibration allows you to measure and compensate for these delays.

Frequency. Run manual, auto, quick, and system calibration as follows:

Calibration	Frequency
Manual	Check every 6 months, calibrate if required
Auto	Every 6 months or less as required
Quick	As required for highest possible accuracy
System	Same as manual and auto calibration

NOTE

*The calibration procedures return the 650 to correct alignment. **CALIBRATION LIMITS AND TOLERANCES ARE NOT INSTRUMENT SPECIFICATIONS.** Section 1 gives the instrument specifications.*

7.2 MANUAL CALIBRATION

This section first provides an overview of manual calibration, then gives the step-by-procedure.

7.2.1 Overview

Manual calibration consists of the seven major adjustment steps given in table 7-1. Steps 3, 5, and 6 bring the 650 into the range of auto calibration, which then finishes the calibration.

Table 7-1. Manual Calibration Major Adjustment Steps

Step	Function	Required
1. 10MHz Ref	Frequency Ref	Once for all channels
2. Quick Cal Ampl Adjust	DVM Reference	Once for all channels
3. DAC Impedance (filter flatness)	Auto-cal setup	Once per channel
4. 1kHz Distortion	Waveform purity	Once per channel
5. Square Wave Amplitude Adjust	Auto-cal setup	Once per channel
6. Sine Wave Amplitude Adjust	Auto-cal setup	Once per channel
7. Waveform Abberations @ 10Vp-p	Waveform purity	Once per channel

Step 1: 10 MHz Ref. This step calibrates the 10 MHz reference oscillator. The frequency accuracy of the 650's output waveforms depends on this oscillator.

Step 2: Quick Cal Ampl Adjust. This step calibrates the 650's reference voltage source. The built-in DVM derives its accuracy from this source. The auto-cal and quick-cal procedures use the DVM to calibrate the 650.

Step 3: DAC Impedance. This step flattens the gain vs frequency response of each channel's low-pass filter. This filter converts the stepped sine waves emerging from the digital-to-analog converter into smooth sine waves. Flattening the frequency response across the output frequency range of the 650 (0 to 2MHz) reduces the amount of correction auto-cal must apply at each frequency.

Step 4: 1 KHz Distortion. This step minimizes the spurs and harmonic distortion in each channel by adjusting the DAC threshold voltage for a 1kHz sine wave.

Step 5: Square Wave Amplitude Adjust. This step sets the amplitude of each channel for a 1kHz square wave to 10 volts. Auto calibration uses this starting point to build correction curves for other amplitudes and other frequencies.

Step 6: Sine Wave Amplitude Adjust. This step sets the output amplitude of each channel for a 1kHz sine wave to 10 volts. Auto calibration uses this starting point to build correction curves for other amplitudes and other frequencies.

Step 7: Waveform Abberations @10vpp. This step adjusts each channel's square wave to the optimum balance between rise time and overshoot.

Who Should Run Manual Calibration? If your application requires traceability of calibration, only the person in charge of maintaining the calibration records should run manual calibration.

When Should You Run Manual Calibration?

- Every six months. Check manual calibration every six months. If all the adjustments fall within limits, change nothing. If any exceed their limits, run the entire procedure and adjust all of them to the center of their ranges.
- After installing a new channel, a new circuit board, or an individual component. Run the entire procedure whenever you change the hardware.
- If auto-cal fails. In some cases, defective manual calibration can cause auto-cal to fail. Check manual calibration if auto-cal displays an error message.

Equipment Required. Manual calibration requires the following test equipment:

Instrument	Specifications
Frequency Counter	100 MHz, 9 digits, 1 ppm
Digital Voltmeter	Ohms and true RMS AC ± 0.05%
Distortion Analyzer	1kHz, 80dB dynamic range (recommended: HP339A)
Oscilloscope	100MHz, 50Vpp
Plastic Adjusting Tool	3/32 inch blade
Coaxial cable with BNC connectors	Length as required
Alligator-clip DVM test leads	

Time Required. Approximately one hour (after a 20 minute warm-up).

Menu Operation. Figure 7-1 shows how to call the manual calibration menu and display each step on the screen. Displaying a step automatically sets the 650 operating parameters to those required by the step.

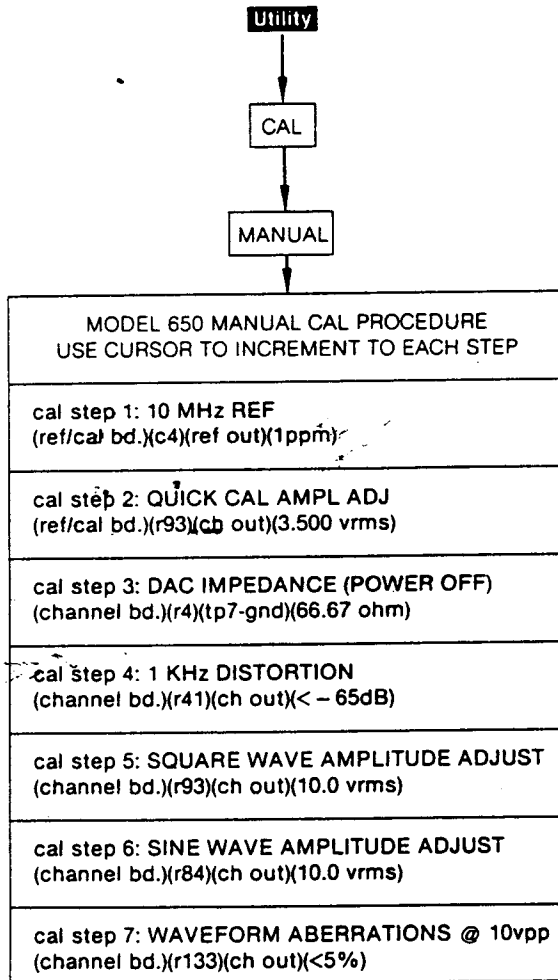

Figure 7-1. Calling the Manual Calibration Menu

Procedure Overview. Figure 7-2 summarizes the detailed step-by-step manual calibration procedure given in table 7-2.

Procedure Order. Run the procedure in either of the two orders given below.

Order Used in Table 7-2

Step	Manual Cal Step	Board
1	1. 10 MHz Reference	Ref/Cal
2	2. Amplifier Adjust	Ref/Cal
3	3. DAC Impedance	Ch 1
4	4. 1KHz Distort	Ch 1
5	5. Square Wave Amplifier	Ch 1
6	6. Sine Wave Amplifier	Ch 1
7	7. Waveform Aberration	Ch 1
8	3. DAC Impedance	Ch 2

Order Used in Table 7-2 (Continued)

Step	Manual Cal Step	Board
9	4. 1KHz Distort	Ch 2
10	5. Square Wave Amplifier	Ch 2
11	6. Sine Wave Amplifier	Ch 2
12	7. Waveform Aberration	Ch 2
13	3. DAC Impedance	Ch 3
14	4. 1KHz Distort	Ch 3
15	5. Square Wave Amplifier	Ch 3
16	6. Sine Wave Amplifier	Ch 3
17	7. Waveform Aberration	Ch 3
18	3. DAC Impedance	Ch 4
19	4. 1KHz Distort	Ch 4
20	5. Square Wave Amplifier	Ch 4
21	6. Sine Wave Amplifier	Ch 4
22	7. Waveform Aberration	Ch 4

Alternate Order

Step	Manual Cal Step	Board
1	1. 10 MHz Reference	Ref/Cal
2	2. Amplifier Adjust	Ref/Cal
3	3. DAC Impedance	Ch 1
4	3. DAC Impedance	Ch 2
5	3. DAC Impedance	Ch 3
6	3. DAC Impedance	Ch 4
7	4. 1KHz Distort	Ch 1
8	4. 1KHz Distort	Ch 2
9	4. 1KHz Distort	Ch 3
10	4. 1KHz Distort	Ch 4
11	5. Square Wave Amplifier	Ch 1
12	5. Square Wave Amplifier	Ch 2
13	5. Square Wave Amplifier	Ch 3
14	5. Square Wave Amplifier	Ch 4
15	6. Sine Wave Amplifier	Ch 1
16	6. Sine Wave Amplifier	Ch 2
17	6. Sine Wave Amplifier	Ch 3
18	6. Sine Wave Amplifier	Ch 4
19	7. Waveform Aberration	Ch 4
20	7. Waveform Aberration	Ch 4
21	7. Waveform Aberration	Ch 4
22	7. Waveform Aberration	Ch 4

7.2.2 Step-by-Step Procedure

Follow the procedure given in table 7-2 to manually calibrate the 650. The manual-cal menu steps automatically make the 650 produce the appropriate output for each calibration.

For best results, keep the internal temperature of the 650 constant. Remove the top cover only to make an adjustment, and replace it immediately after each adjustment.

Step	Board	Ins	Connection	Adj	Value
1. 10 MHz Ref	Ref/Cal	FC	10 MHz Ref Out	C4	10 MHz \pm 10 Hz
2. Ampl Adjust	Ref/Cal	DVM	CH Func Out	R93	3.500 Vrms \pm 0.002 Vrms
3. DAC Impdnce	Channel	DVM	TP7 and GND	R4	66.67 \pm 0.05
4. 1 KHz Distorf	Channel	DA	CH Func Out	R41	Min distortion. Typ: < - 65dB
5. Sq Wave Ampl	Channel	DVM	CH Func Out	R93	10.0 Vrms \pm 0.1V (1.0%)
6. Sine Wv Ampl	Channel	DVM	CH Func Out	R84	10.0 Vrms \pm 0.1V (1.0%)
7. Wvfrm Aberr	Channel	OSC	CH Func Out	R133	Abr: <5% (<3% typical) Rise/Fall: 45—60 nseconds

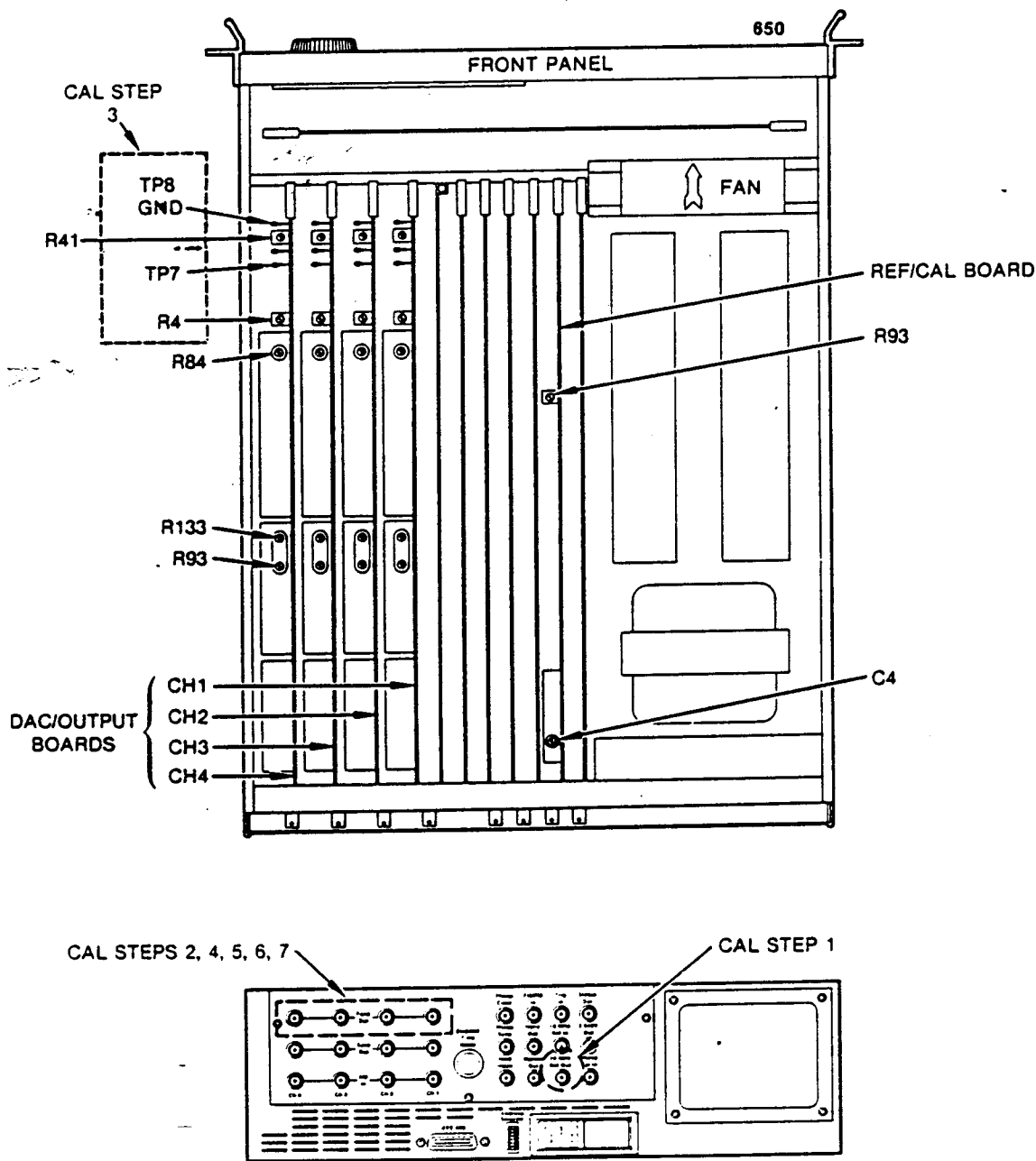

Figure 7-2. Summary of Manual Calibration

Table 7-2. Manual Calibration Procedure

Step	Action	Response
Set-Up Steps		
S-1	Turn on the 650 and wait for 20 minutes.	Unit will reach the operating temperature.
S-2	Remove the three screws at the back of the top cover of the 650, but leave the cover in place.	Leaving the cover in place maintains the internal temperature.
S-3	Press the Utility key.	The utility menu will appear.
S-4	Press the CAL key.	The calibration menu will appear.
S-5	Press the MANUAL key.	MODEL 650 MANUAL CAL PROCEDURE USE CURSOR TO INCREMENT TO EACH STEP
Step 1: 10MHz Rerence		
1-1	Use the CURSOR UP arrow to step to calibration step 1.	cal step 1: 10 MHz REF (ref/cal bd)(c4)(ref out)(1ppm)
1-2	Connect 10MHz Ref Out BNC on rear panel to the frequency counter (if the counter does not have a 50 ohm input, use a 50 ohm load).	
1-3	Remove the top cover and adjust C4 on the Ref/Cal board until the counter reads 10MHz \pm 10 Hz.	Figure 7-2 locates C4.
1-4	Replace the top cover, wait two minutes, then verify the frequency reading.	
1-5	Disconnect BNC cable from the 650 and the frequency counter.	
Step 2: Quick Cal Amplitude Adjust		
2-1	Use the CURSOR UP arrow to step to calibration step 2.	cal step 2: QUICK CAL AMPL ADJ (ref/cal bd)(r93)(ch out)(3.5vrms) (Step 2 makes the 650 generate a 3.5Vrms 1kHz sine wave output).
2-2	Set the digital voltmeter to read AC rms voltage.	
2-3	Connect the Ch1 Func Out BNC to the digital voltmeter.	
2-4	Press the Quick Calibrate key.	The message *** quick cal *** will flash on the screen.
2-5	Remove the top cover and adjust R93 on the Ref/Cal card to 3.500Vrms \pm 0.001Vrms.	Figure 7-2 locates R93.
<p style="text-align: center;"><i>Note</i></p> <p><i>Don't accidentally adjust R93 on one of the DAC/Output boards.</i></p>		

Table 7-2. Manual Calibration Procedure (Continued)

Step	Action	Response
2-6	Press the Quick Calibrate key.	The message *** quick cal *** will flash on the screen.
2-7	Re-adjust R93 on the Ref/Cal card to 3.500Vrms \pm 0.001Vrms.	
2-8	Repeat steps 2-6 and 2-7 until the output reads exactly 3.500Vrms. If you cannot meet this ideal, repeat the steps until this output reads 3.500Vrms \pm 0.001Vrms.	Consult the factory if you cannot set the output to 3.500Vrms \pm 0.001Vrms.
2-9	Replace the top cover.	
2-10	Connect the DVM to the Ch 2 Func Out BNC connector and read the output voltage.	Ch 2 must have an output voltage of 3.500Vrms \pm 0.005Vrms. Consult the factory if it does not.
2-11	Repeat step 2-10 for channels 3 and 4.	
2-12	Disconnect the BNC cable from the DVM and the 650.	Consult the factory if any channel does not meet the specification.

Step	Action
	Step 3: Filter Flatness and Rolloff
3-1	Connect the channel under calibration to the DVM.
3-2	Set the DVM to read Vrms.
3-3	Press UTILITY, CAL (F5), MANUAL (F1), 5, EXECUTE.
3-4	Adjust R93 on the DAC/OUTPUT board for 10.000 Vrms.
3-5	Press the Cursor Up arrow to advance to MANUAL CAL step 6.
3-6	Adjust R84 on the DAC/OUTPUT board for 10.000 Vrms.
3-7	Press the START (F5) key to start AutoCal. Wait for AutoCal to finish before proceeding with the next step.
3-8	<p>Press the following key sequence in exact order to set the channel under test to sweep from 20 kHz to 2.5 MHz. In case of entry error, press RESET, PARAMS and start over. The software programmable keys are indicated in parentheses.</p> <p>RESET, PARAMS (F1), CHANNEL NUMBER, (number of channel being calibrated: 1-4), CHANNEL, 10, SHIFT (F1), RATIO (F4), 2, OUTPUT (F3), ON-50Ω (F2), SWEEP, FREQ, (F2), MARKER (F4), 1E6, LIMITS (F2), START (F1), 1E4, STOP (F2), 1.25E6, SWEEP, FREQ (F2), TIME (F3), 0.1, MODE (F1), CONT (F1), RESET (F1), EXECUTE.</p>
3-9	Connect the 650 FUNCTION OUT of the channel being calibrated to the oscilloscope channel 1 input.
3-10	Set termination to 50 Ω and vertical sensitivity to 0.5 V/div.

Table 7-2. Manual Calibration Procedure (Continued)

Step	Action
3-11	Adjust the vertical position control to place the left side of the positive edge of the sweep envelope at the center of the screen.
3-12	Connect the 650 MARKER OUT to the oscilloscope channel 2 input.
3-13	Set the channel 2 vertical sensitivity to 2V/div and horizontal time/div to 10 ms.
3-14	Connect the 650 HORIZ OUT to the oscilloscope external trigger input.
3-15	Set trigger mode to EXTERNAL and trigger slope to NEGATIVE.
3-16	Adjust gain and centering controls to place the marker edge on the 8th vertical grid line (2.00 MHz). Channel 2 may now be turned off to give a better sweep display.
3-17	Adjust R4 and R84 for the flattest response over the left 8 divisions of the display while keeping the left side of the display at the original center point. The right 2 divisions should show a sharp rolloff at the filter corner frequency. The horizontal scale factor is 0.25 MHz/div.

Step	Action	Response
Step 4: 1kHz Distortion		
4-1	Use the CURSOR UP arrow to calibration step 4.	step cal step 4: 1kHz DISTORTION to calibration step 4. (chan bd)(r41)(ch out)(<-65dB) (Step 4 makes the 650 generate a 1kHz 5Vpp sine wave.)
4-2	Set the distortion analyzer to measure the distortion in a 1kHz 5Vpp signal. If the analyzer has low and high-pass filtering, set the low pass to 100kHz and the high pass to 400Hz.	
4-3	Connect the Ch 1 (or 2, 3, or 4) Func Out BNC to the distortion analyzer.	
4-4	Remove the cover.	
4-5	Adjust R41 on the channel 1 (or 2, 3, or 4) Dac/Output board to the minimum possible distortion. You must set the distortion to less than -65dB. Typically, it will fall between -65dB and -75dB.	
4-6	Replace the cover and wait two minutes.	
4-7	Disconnect the BNC cable from the distortion analyzer.	

Table 7-2. Manual Calibration Procedure (Continued)

Step	Action	Response
Step 5: Square Wave Amplitude Adjust		
5-1	Use the CURSOR UP arrow to step to calibration step 5.	cal step 5: SQ WAVE AMPL ADJUST (chan bd)(r93)(ch out)(10.0 Vrms) Figure 7-2 locates R93.
5-2	Set the DVM to read AC volts rms	
5-3	Connect the Ch1 or (2, 3, or 4) Func Out BNC to the DVM..	
5-4	Remove the cover.	
5-5	Adjust R93 on the channel 1 (or 2, 3, or 4) DAC/Output board to deliver a square wave amplitude of 10.0 Vrms \pm 0.1 Vrms.	
<i>Note</i> <i>Don't accidentally adjust R93 on the Ref/Cal board.</i>		
5-6	Replac the cover and wait two minutes.	
5-7	Leave Ch1 Func Out connected to the DVM.	
Step 6: Sine Wave Amplitude Adjust		
6-1	Use the CURSOR UP arrow to step to calibration step 6.	cal step 6: SINE WAVE AMPL ADJUST (chan bd)(r 84)(ch out)(10.0 Vrms) Figure 7-2 locates R84.
6-2	Leave the DVM set to read volts rms.	
6-3	Verify that the Ch1 (or 2, 3, or 4) Func Out BNC connects to the DVM'	
6-4	Remove the cover.	
6-5	Adjust R84 on the channel 1 (or 2, 3, or 4) DAC/Output board to deliver a sine wave amplitude of 10.0 \pm 0.1 Vrms.	
6-6	Replace the cover.	
6-7	Disconnect the 650 from the DVM.	

Table 7-2. Manual Calibration Procedure (Continued)

Step	Action	Response
Step 7: Waveform Aberrations		
7-1	Use the CURSOR UP arrow to step to calibration step 7.	cal step7: WAVEFORM ABBERATIONS (channel bd) (r133)(ch out)(<5%) (Step 7 makes the 650 generate a 1MHz 10 Vpp square wave output.)
7-2	Connect the Ch1.(or 2, 3, or 4) Func Out BNC to the oscilloscope.	
7-3	Set oscilloscope to display a 1MHz 10 Vpp square wave.	
7-4	Remove the cover.	
7-5	Adjust R133 on the channel 1 (or 2, 3, or 4) DAC/Output board to make the waveform aberrations $\leq 5\%$ ($\leq 3\%$ typical) and the rise/fall time < 100 nanoseconds.	
7-6	Replace the cover.	
7-7	Remove the BNC cable from the 650 and the oscilloscope.	
Calibration of Remaining Channels		
Repeat steps 3-1 through 7-7 for channels 2, 3, and 4.		
Concluding Steps		
C-1	Replace the top cover and wait 10 minutes.	The internal temperature of the 650 will stabilize.
C-2	Run auto calibration to complete calibration of the 650.	Section 7.3 gives the auto-cal procedure.

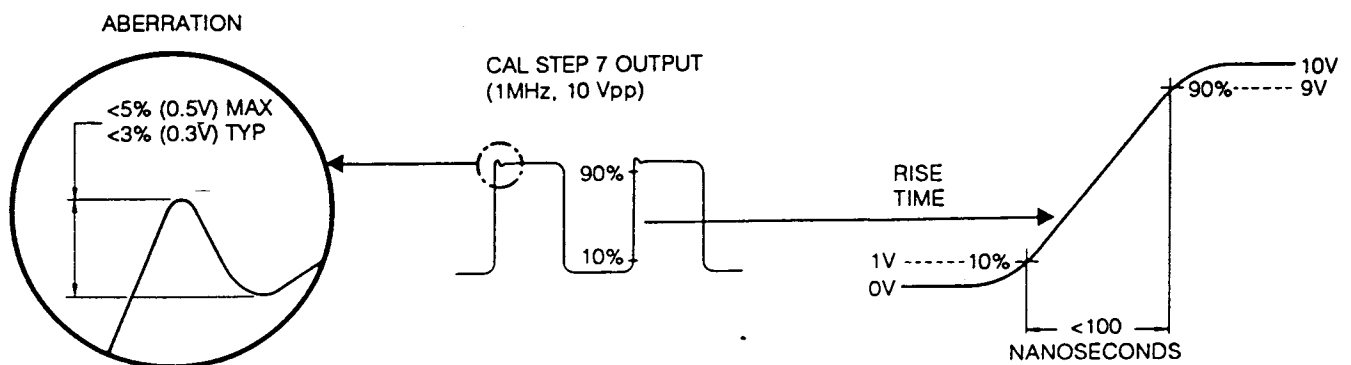

Figure 7-3. Manual Calibration Aberration and Rise Time

7.3 AUTO CALIBRATION

This section first provides an overview of auto calibration, then gives the step-by-step procedure.

7.3.1 Overview

Auto calibration in the 650 corresponds to a full laboratory calibration. It automatically corrects for temperature changes and component aging. You can run it from the front panel or you can program a system computer to run it over the GPIB bus.

Auto-cal measures the errors listed below, calculates compensation values for them, then stores these values in tables in battery-protected memory. During operation, it applies these values (or values derived by interpolating between them) to deliver precise outputs at all frequencies, amplitudes, and offsets. Channel 1 serves as the phase reference for calibrating channels 2 through 4.

Amplitude Errors Zero amplitude error. Amplitude-dependent amplitude scale errors for nonsquare waveforms at 10, 20, 30, 40, and 50 Vpp output amplitudes. Absolute amplitude scale error for the square waveform.

Offset Errors Amplitude-dependent offset errors for nonsquare waveforms at 0, 10, 20, 30, 40, and 50 Vpp output amplitudes. Amplitude-dependent offset errors for the square waveform at 0, 10, 20, 30, 40, and 50 Vpp output amplitudes. Absolute offset scale error.

Square Duty Cycle Errors Duty cycle scale error. Duty cycled offset error.

Frequency Dependent Gain Errors Frequency-dependent gain errors at 13 frequency points from 156.25kHz to 2.03125MHz. Frequency-dependent phase errors at 13 frequency points from 156.25kHz to 2.03125MHz.

Who Should Run Auto Calibration? Anyone can run auto calibration.

When Should You Run Auto Calibration?

- After a manual calibration. If you change any of the manual calibration settings, you *must* run auto calibration immediately to complete the calibration.
- Only after a 20 minute warm-up in the operating environment.
- Minimum: Every six months.
- Good Practice: Weekly.
- Maximum: As frequently as your application requires.

Auto-Calibration Failures. An auto-cal error message indicates one of three problems: 1) you have not disconnected your input signals and loads from the 650's inputs and outputs, 2) a defective manual calibration, or 3) a hardware failure. To eliminate the error, first disconnect all cables and loads, then re-run auto cal. If the failure remains, check manual calibration and correct it if necessary. Finally, run the diagnostics to find the defective hardware. Table 7-3 deciphers the auto-cal error messages.

Equipment Required. None.

Time Required. Less than two minutes (after a 20-minute warm-up).

Menu Operation. Figure 7-4 shows how to call the auto calibration menu.

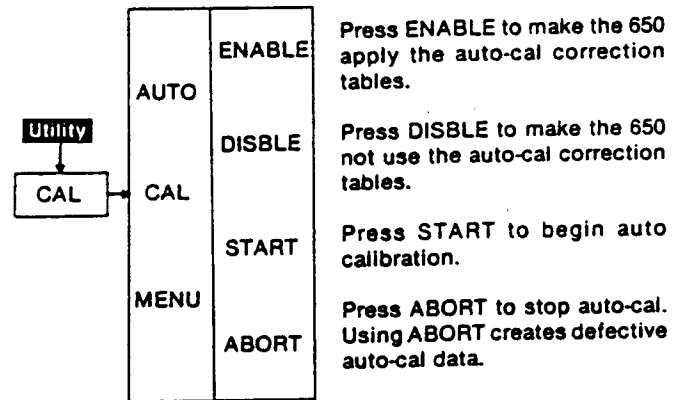

Figure 7-4. Calling the Auto-Cal Menu

DISABLE and ENABLE serve as troubleshooting aids for the auto-cal hardware. For example, if the 650 produces abnormal outputs with the auto-cal correction tables enabled and more reasonable (but uncalibrated) outputs with the auto-cal tables disabled, then the auto-cal hardware has delivered defective measurements to the auto-cal software.

ABORT allows you to stop auto-cal in mid-process (for example, you might notice that you forgot to disconnect the input cables). Stopping auto-cal creates defective auto-cal data. Always re-run auto-cal to completion if you abort a run.

7.3.2 Step-by-Step Procedure

Follow this procedure to run auto calibration.

1. Disconnect all input signals and loads.
2. Press the **UTILITY** key.
3. Press the CAL key.
4. Press the START key.
5. Wait for AUTO CALIBRATION COMPLETED message to appear.

Table 7-3. Auto Calibration Error Messages

AUTO CALIBRATION COMPLETED
 *** HHHHHHHH ***

← Screen message

00000000 No errors in any channel.
 HH----- CH1 Auto Cal Hexadecimal Error Number
 --HH---- CH2 Auto Cal Hexadecimal Error Number
HH-- CH3 Auto Cal Hexadecimal Error Number
 -----HH CH4 Auto Cal Hexadecimal Error Number

BINARY EQUIVALENT								BINARY EQUIVALENT									
HH	X	X	X	F	P	S	O	A	HH	X	X	X	F	P	S	O	A
00	0	0	0	0	0	0	0	0	10	0	0	0	1	0	0	0	0
01	0	0	0	0	0	0	0	1	11	0	0	0	1	0	0	0	1
02	0	0	0	0	0	0	1	0	12	0	0	0	1	0	0	1	0
03	0	0	0	0	0	0	1	1	13	0	0	0	1	0	0	1	1
04	0	0	0	0	0	1	0	0	14	0	0	0	1	0	1	0	0
05	0	0	0	0	0	1	0	1	15	0	0	0	1	0	1	0	1
06	0	0	0	0	0	1	1	0	16	0	0	0	1	0	1	1	0
07	0	0	0	0	0	1	1	1	17	0	0	0	1	0	1	1	1
08	0	0	0	0	1	0	0	0	18	0	0	0	1	1	0	0	0
09	0	0	0	0	1	0	0	1	19	0	0	0	1	1	0	0	1
0A	0	0	0	0	1	0	1	0	1A	0	0	0	1	1	0	1	0
0B	0	0	0	0	1	0	1	1	1B	0	0	0	1	1	0	1	1
0C	0	0	0	0	1	1	0	0	1C	0	0	0	1	1	1	0	0
0D	0	0	0	0	1	1	0	1	1D	0	0	0	1	1	1	0	1
0E	0	0	0	0	1	1	1	0	1E	0	0	0	1	1	1	1	0
0F	0	0	0	0	1	1	1	1	1F	0	0	0	1	1	1	1	1

A = Amplitude compensation error P = Phase compensation error
 F = Filter compensation error S = Symmetry compensation error
 O = Offset compensation error X = Not used

Example: 001A0000 indicates filter, phase, and offset compensation errors in channel 2.

7.4 QUICK CALIBRATION

This section first provides an overview of quick calibration, then gives the step-by-step procedure.

7.4.1 Overview

Quick calibration gives the highest possible accuracy by measuring the errors and calculating amplitude, offset, and phase corrections for the exact current settings of the 650, rather than interpolating between auto calibration's measured values. This method eliminates

any minor interpolation errors and corrects for recent temperature changes.

Quick calibration reverts to the auto-cal values if you change any setting, including powering down.

Who Should Run Quick Calibration? Anyone who needs the highest possible accuracy.

Restrictions. Quick-cal always corrects amplitude and offset errors. (more→)

Quick-cal only corrects phase errors when:

- You choose an output frequency greater than 5kHz. Frequencies less than 5kHz have insignificant phase errors.
- You select Ch 2, 3, or 4 with the **Channel Number** key. Since Ch 1 serves as the phase reference, calibrating it against itself serves no purpose.
- You make both channel 1 and the channel under calibration produce sine functions at ratios of 1.
- You choose non-sweep operation. You can't quick-cal during a phase or frequency sweep. The auto-cal data base calibrates the sweep modes.

Equipment Required: None.

Time Required. Less than 5 seconds.

7.4.2 Step-by-Step Procedure

Follow these steps to quick calibrate an instrument setup:

1. Disconnect any signals connected to the **AM In** connectors.
2. Press the **Quick Calibrate** key.
3. Wait for the message ***** quick cal ***** to flash.

7.5 SYSTEM CALIBRATION

This section tells how to calibrate a system of interconnected synchronized 650 units. First, it provides an overview of system calibration, then it gives the step-by-step procedure.

7.5.1 Overview

You can interconnect up to ten 650 units, each with four channels, to form a system that provides up to 40 phase-coherent, phase-controlled signals. One unit, called the master, serves as the phase reference for the other units, called slaves. Figure 7-5 shows how the units interconnect.

System Operation. You must run all units at the same frequency. Changing the frequency of any unit (master or slave) will disrupt the other units. If you need to temporarily run one 650 at a different frequency, set it to INDEPN.

Calibration. System calibration first manually calibrates the individual units, then auto calibrates the system.

System auto calibration auto calibrates the master, then references the phase of channel 1 of each slave to channel 1 of the master, then auto calibrates the individual slaves.

Who Should Manually Calibrate a System? If your application requires traceability of calibration, only the person in charge of maintaining the calibration records should manually calibrate the individual units.

When Should You Manually Calibrate a System? Manually calibrate each 650 in a multi-unit system according to the schedule given in part 7.2 above.

Who Should Auto Calibrate a System? Anyone can run system auto calibration.

When Should You Auto Calibrate a System?

- Always after a manual calibration.
- Only after a 20 minute warm-up in the operating environment.
- Minimum: Every six months.
- Good practice: Weekly.
- Maximum: As frequently as your application requires.

Equipment Required. Part 7.2 lists the equipment required for manual calibration. System auto calibration requires a set of coaxial cables with BNC connectors and BNC "T" connectors as shown in figure 7-5.

Time Required. Approximately one-half hour.

Procedure Overview.

1. Manually calibrate all individual units.
2. Auto calibrate the master.
3. Phase calibrate the system.
4. Auto calibrate the slaves.

7.5.2 Step-by-Step Procedure

Follow the procedure given in table 7-4 to auto-calibrate a 650 system. The procedure uses [brackets] to separate screen messages from the procedure text. The brackets do not appear on the screen. To avoid confusion, attach a MASTER or SLAVE label to each 650.

Conditions: All units manually calibrated.

All units set to the same main frequency.

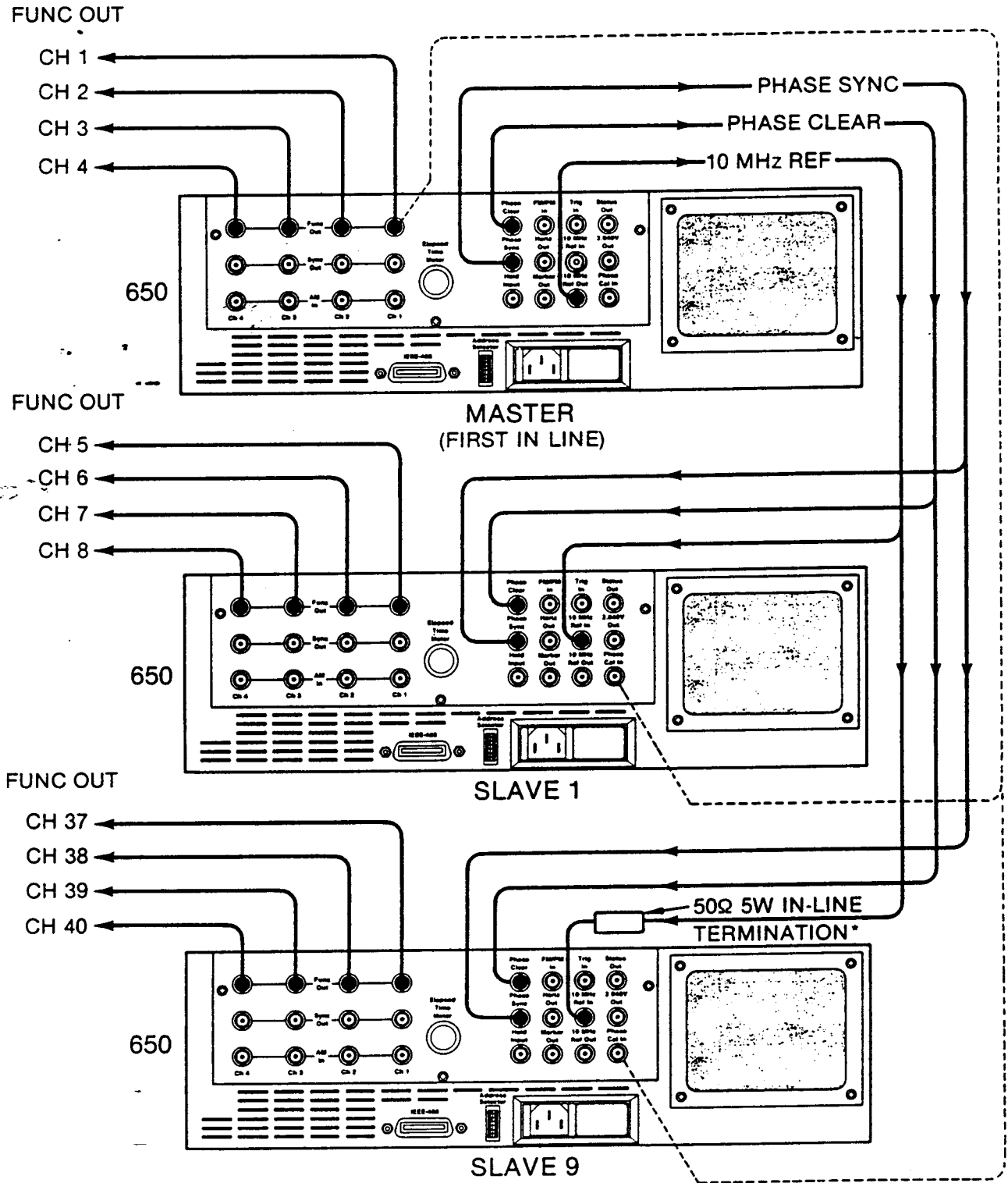

*Attach termination directly to 10 MHz Ref In BNC of the last 650 in line.
 Solid Lines: Permanent connections.
 Dashed Lines: Install only during calibration.

Figure 7-5. Interconnection of Multiple 650 Units

Table 7-4. System Auto Calibration Procedure

Step	Action	Response
1	Turn on all units and wait for 20 minutes.	The system reaches operating temperature.
2	Connect Ch 1 Func Out of the master to Phase Cal In of each slave as shown in figure 7-5.	
3	Press these keys on the master: Utility CONFIG INDEPN	The master screen displays: [configuration: INDEPENDENT] Master switches to independent status.
4	Press these keys on the master: Utility CAL DISABLE	The master screen displays: [AUTO CAL DISABLED]. This action disables the existing correction factors table.
5	Press this key on the master: START	The master screen displays: START [AUTO CALIBRATION IN PROGRESS]. Sound: Relays clicking. The master now builds an amplitude, offset, and phase correction factors table for itself. Because you disabled the previous table, independent calibration gives channel 1 a phase correction factor of 0° before calculating the rest of the new table. The phase calculations give channels factors that shift their outputs into phase with channel 1.
6	Wait until the calibration completes.	The master screen displays: [AUTO CALIBRATION COMPLETED] [*** 00000000 ***]
7	Verify that the error number contains all zeros.	Table 7-3 deciphers non-zero error messages.
8	Press these keys on the master: Utility CONFIG MASTER	The master screen displays: [configuration: MASTER]. Master switches to master status.
9	Press these keys on each slave: Utility CONFIG SLAVE	Each slave screen displays: [configuration: SLAVE] Slaves switch to slave status.
10	Press these keys on each slave: Utility CAL START	Each slave screen displays: [***AUTO CAL IN PROGRESS***]. Sound: Silence. The system phase calibration does not start.
11	Press these keys on the master: Utility CAL START	The master screen displays: [***AUTO CAL IN PROGRESS***]. Sound: Relays clicking in all units. Each slave now works with the master to calculate and store in the slave a correction factor that shifts channel 1 of the slave into phase with channel 1 of the master.

Table 7-4. System Auto Calibration Procedure (Cont)

Step	Action	Response
12	Wait until the system calibration completes.	The master and all the slaves display: [AUTO CALIBRATION COMPLETED] [*** 00000000 ***]
13	Verify that the error number of each 650 (master and all slaves) contains all zeros.	Table 7-3 deciphers non-zero error messages.
14	Press these keys on each slave: Utility CONFIG INDEPN	Each slave screen displays: [configuration: INDEPENDENT] Slaves switch to independent status.
15	Press these keys on each slave: Utility CAL START	Each slave screen displays: [*** AUTO CAL IN PROGRESS ***]. Sound: Relays clicking. Each slave now builds an amplitude, offset, and phase correction factors table for itself. Because you did not disable the previous table, independent calibration does not erase channel 1's master/slave phase correction factor (see step 11) before calculating the rest of the new table. Furthermore, the phase calculations combine this factor with the separate channel factors to produce overall factors that shift channels 2-4 into phase with channel 1 of the master.
16	Wait until all slaves complete calibrating.	All slave screens display: [AUTO CALIBRATION COMPLETED] [*** 00000000 ***]
17	Verify that the error number of each slave contains all zeros.	Table 7-3 deciphers non-zero error messages.
18	Press these keys on the master: Utility CONFIG MASTER	The master screen displays: [configuration: MASTER]
19	Press these keys on each slave: Utility CONFIG SLAVE	The slave screens display: [configuration: SLAVE].
20	Remove the cables that connect Ch 1 Func Out of the master to Phase Cal In of each slave.	
21	Use the system.	

7.6 EXTERNAL CALIBRATION

This section tells how to calibrate (measure the delay of) an external amplifier. It first provides an overview of external calibration, then gives a detailed procedure.

7.6.1 Overview

Reason for External Calibration. Occasionally, external equipment requires voltage or current that exceeds the 50Vp-p 0.5A capabilities of the 650. In these cases, the 650 must drive the equipment through external amplifiers. Such amplifiers can add unacceptable delays to the signals. External calibration allows you to measure and compensate for these delays. It cannot measure delays larger than ± 20 degrees.

External Calibration Procedure. External calibration involves two steps. First, you use the 650 as a measurement instrument to determine the delay of the external amplifier. Second, you add a compensating delay to the 650 channel that will drive the amplifier. If the 650 must drive several amplifiers, you separately calibrate each one, then add the appropriate delay to each 650 channel.

Two Methods of Compensation. After you determine an amplifier's delay or phase value, you can negate it by entering either a compensating delay (in seconds) or a compensating phase (in degrees) in the driving channel's menu. Typically, most amplifiers have a constant delay in μ seconds. This constant time delay converts to different phase angle delays at different frequencies. For example, a 2.6 μ second delay equates to 1.872° at 2kHz and 0.936° at 1kHz.

Entering compensation as delay simplifies operation. If you change the frequency, the 650 automatically converts the delay into a phase angle that maintains that delay. Furthermore, the 650 also automatically adds to this phase value any additional phase value you may have entered in the channel's menu for other reasons.

Entering compensation as phase value complicates operation. You will have to calculate and enter a new phase value each time you change the frequency. In addition, if you need to add phase for other reasons, you will have to first manually add the additional phase to the amplifier phase, then enter the total.

To assure that your amplifier does have a constant time delay, repeat external phase calibration at several frequencies across your operating range. If you measure different delays at different frequencies, program the 650 accordingly.

7.6.2 Detailed Procedure

External calibration has two parts:

- 1) calibrate the amplifier
- 2) compensate the channel.

Calibrate the Amplifier. Follow these steps to calibrate an amplifier.

1. Connect the amplifier as shown in figure 7-6. The optional 50 Ω resistor eliminates reflections and standing waves.
2. Set the amplifier gain to 5 or add an attenuator to reduce the gain to 5. External calibration *always* delivers a 4Vpp sine wave out the **Func Out** connector of channels 2, 3, or 4, and *must* have a 20Vp-p (± 1 Vp-p) signal returned to the **Phase Cal In** connector.
3. Set the 650 controls. Set the **Main** FREQ to any frequency greater than 2kHz and set **Channel Number** to the number of the channel providing the calibration signal. You can use any channel except 1. You do not have to use the channel that will eventually drive the amplifier.
4. Press **Utility**, then CAL, then EXTRNL. The 650 will close the output relays (0 Ω output impedance), deliver the calibration signal, measure the delay of the returned signal with reference to channel 1, then display the results on the 650 screen as follows:

```
EXTERNAL PHASE: -XXXX degrees
ch X delay XXXX sec from ch 1 at XXXX Hz
```

Compensate the Channel. To compensate a channel for an amplifier's delay, first select the channel with the **Channel Number** key, then press **Channel**, then SHIFT, then DELAY, then enter the external delay with a reversed sign. For example, if external calibration displayed the message [ch X delay 2.6 μ sec], you would enter - 2.6 μ sec in the channel menu.

If necessary, you can also compensate by entering the phase value of the amplifier, as discussed above.

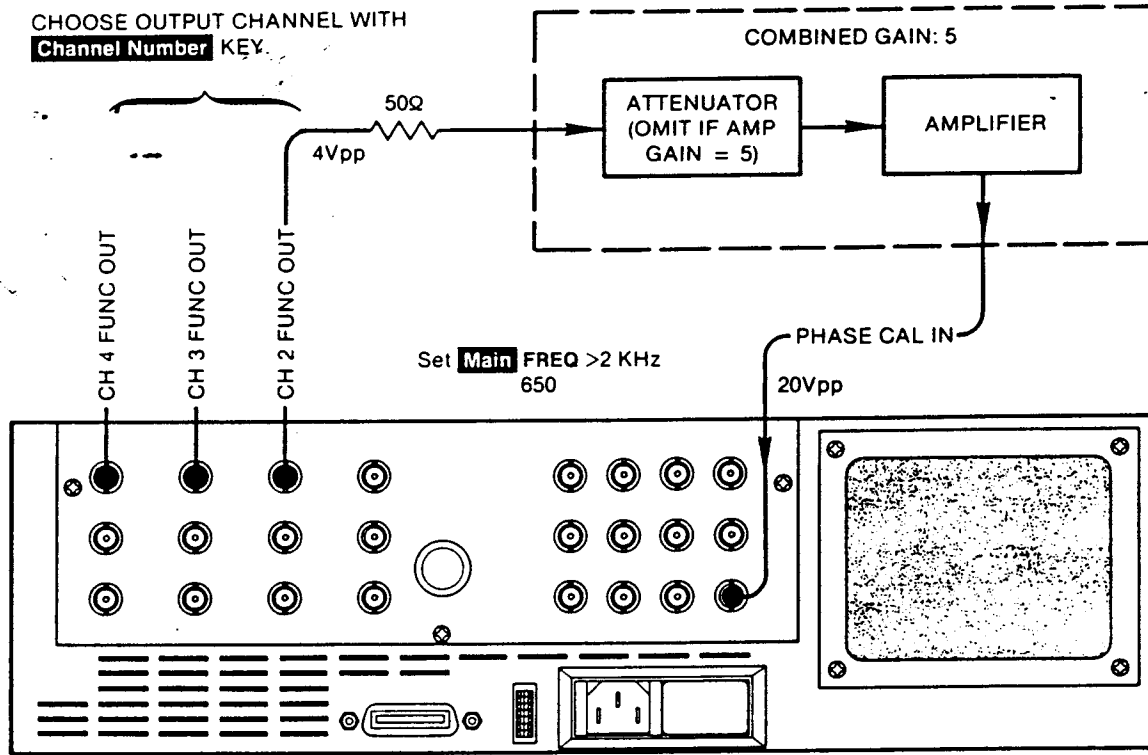

Notes: EXTRNL calibration delivers 0Ω output impedance
The optional 50Ω resistor eliminates reflections and standing waves.

Figure 7-6. External Calibration Test Setup

SECTION 8

APPLICATION: PHASE METER CALIBRATION

8.1 INTRODUCTION

This section shows how to calibrate a phase meter with the 650. Specifically, it shows how to determine if a given meter can measure phase with sufficient accuracy for a specific application.

Section	Page
8.2 Test Description	8-1
8.3 Quick Test	8-1
8.4 Sweep Tests	8-3
8.5 Wavetek 740 Example	8-10

8.2 TEST DESCRIPTION

Problem: How accurately can a given phase meter measure the phase between two 11.8 Vrms sinusoidal signals over the frequency range 300Hz to 3kHz?

Solution. Use the 650 to generate a known phase angle over the frequency range in question. With an X-Y recorder, plot the phase measured by the phase meter against frequency. The graph will show any deviation from the known phase delivered by the 650.

The following specifications enable the 650 to serve as the phase reference for this calibration:

Phase accuracy from 300 to 3000 Hz: $\pm 0.01^\circ$ (typical)

Output voltage: 0 to 50Vp-p (17.677Vrms)

Output signal: Five choices (including sine)

The following additional capabilities of the 650 simplify calibration:

Horiz Out The 650 provides an output voltage that corresponds to elapsed sweep

time. This output drives the X axis of the recorder.

Vp-p/Vrms The 650 displays the output waveform amplitude in both volts peak-to-peak and in volts rms. This feature confirms that the waveform delivers the correct rms voltage.

Sweep Modes The 650 sweep mode assortment includes a triggered one-shot frequency sweep. This mode enables you to set up the X-Y recorder, lower the pen, then trigger one sweep through the frequency range.

8.3 QUICK TEST

The quick test checks the phase meter accuracy at a fixed frequency. If the meter doesn't pass, you can skip the more complicated frequency sweep calibration.

Procedure. Follow the procedure in table 8-1 to run the quick test. [Brackets] separate screen messages from the procedure text. The brackets do not appear on the screen.

Voltage Calculation. The application requires a sine wave signal amplitude of 11.8Vrms. To determine the equivalent peak-to-peak voltage, multiply by the conversion factor: $2.828 \times 11.8\text{Vrms} = 33.370\text{Vp-p}$.

Waveform Choice. The 650 powers up delivering sine wave outputs. Therefore, this procedure does not contain steps to choose an output waveshape.

Table 8-1. Quick Test

Step	Action	Response
1-1	Turn on the 650.	The power-up screen will appear.
1-2	Turn on the phase meter and set it to measure the phase of two 33.376Vp-p signals.	
1-3	Allow both instruments to warm up (20 minutes for the 650).	The instruments will reach their operating temperatures.
1-4	Connect Ch1 Func Out of the 650 to the A input of the phase meter and Ch2 Func Out of the 650 to the B input of the phase meter.	Note: The 650 powers up with the outputs off.
1-5	Press this key sequence to set the output frequency of both channels: Main FREQ 300 Execute	[frequency: 000,300.0000 Hz]
1-6	Press this key sequence to give channel 1 an amplitude of 33.37Vp-p (the text above explains the derivation of this number) and a phase of 0°: Channel AMPL 33.37 PHASE 0 Execute	[phase: 0,000,000.000 Deg] Note: You can eliminate the PHASE 0 keystrokes. The 650 gives each channel a default phase of 0°.
1-7	Press AMPL to display the amplitude of channel 1.	[amplitude: 33.370 Vpp] 11.798 Vrms]
1-8	Enter a series of slightly higher amplitudes until the Vrms output reads exactly 11.800 Vrms. The following key sequence enters the required Vp-p: 33.376 Execute	[amplitude: 33.376 Vpp] 11.800 Vrms]
1-9	Press these keys to change the active channel to channel 2: Channel Number 2 Execute	The upper-right corner of the screen will display: [CH2]
1-10	Press these keys to give channel 2 an amplitude of 33.376Vp-p and a phase of 90°: Channel AMPL 33.376 PHASE 90 Execute	[phase: 0,000,090.000 Deg]
1-11	Press this key sequence to turn on the output of channel 2: SHIFT OUTPUT ON-0Ω	Voltages above 25Vp-p require the 0Ω output impedance.
1-12	Press this key sequence to change the active channel to channel 1: Channel Number 1 Execute	The upper-right corner of the screen will display: [CH1]
1-13	Press the ON-0Ω key to turn on the output of channel 1.	Voltages above 25Vp-p require the 0Ω output impedance.
1-14	Read the phase of the two signals.	If the reading meets your accuracy requirement, go to the next part.

8.4 SWEEP TESTS

The sweep tests plot measured phase (at 90°, 120°, and 240°) vs. frequency to determine the accuracy of the phase meter over the required frequency range. The resulting plots show if the meter's response contains any perturbations.

Procedure. Follow in order the procedures in tables 8-2 (for 90°), 8-3 (for 120°), and 8-4 (for 240°) to run the sweep tests. [Brackets] separate screen messages from the procedure text. The brackets do not appear on the screen.

Sweep Range. Use the **Horiz Out** connector of the 650 to drive the X axis of the X-Y recorder (**Horiz Out** delivers a voltage that corresponds to elapsed sweep time). To simplify calibrating the X-Y recorder, make the 650 sweep from 300Hz to 3.3kHz, a difference of 3kHz. Since

Horiz Out ranges from 0 volts at the start of the sweep to 10 volts at the end, the 3kHz sweep corresponds to 300 Hz/V along the X axis.

Sweep Time. To allow time for the phase meter's phase detection circuit to settle, make the 650 sweep from 300Hz to 3.3kHz in 60 seconds, or 50Hz per second. If any perturbations appear in the graph, slow the sweep even more.

Sweep Mode. Use sweep mode 5. This triggered-sweep, triggered-reset mode enables you to set up the recorder, lower the pen, then trigger one sweep through the frequency range.

X-Y Recorder. If necessary, modify the procedures to suit the capabilities and requirements of your particular X-Y recorder.

Table 8-2. 90° Sweep Test

This table tests the meter's ability to measure a 90° phase from 300-3300Hz.

Note: Run steps 1 to 14 in table 8-1 to set up the equipment for this test.

Step	Action	Response
2-1	Leave Ch1 Func Out and Ch2 Func Out of the 650 connected to the A and B inputs of the phase meter.	
2-2	Turn on the X-Y recorder and set both the X and Y controls for variable gain.	
2-3	Reduce the X and Y gains of the recorder to avoid excessive pen motion in the following steps.	
2-4	Connect Horiz Out of the 650 to the X axis input of the X-Y recorder as shown in figure 8-1. Do not connect the phase meter to the recorder.	
2-5	Press this key sequence to set the start sweep frequency to 300Hz: Sweep FREQ LIMITS START 300	[strt freq: 300]
2-6	Press this key sequence to set the stop sweep frequency to 3300Hz: STOP 3300 Execute	[stop freq: 003,300.0000 Hz] [strt freq: 000,300.0000 Hz]
2-7	Press this key sequence to set the sweep time to 1 second: Sweep FREQ TIME 1 Execute	[sweep time: 1.00 Sec]

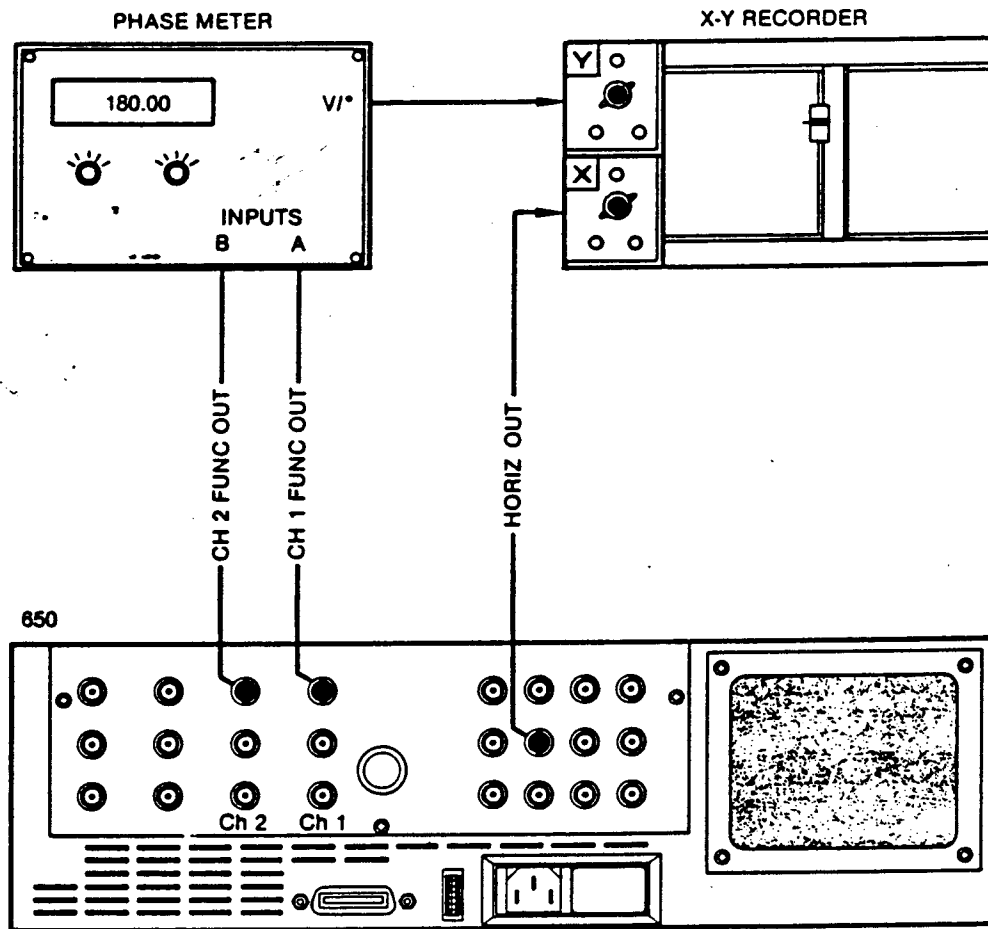

Figure 8-1. Electrical Connections for the Sweep Tests

Table 8-2. 90° Sweep Test (Continued)

Step	Action	Response
2-8	Press this key sequence to put the 650 in sweep mode 5: Sweep FREQ MODE TRIG HLD/RS	Horiz Out will deliver 0 volts.
2-9	Load in a chart that has 10 divisions within the X range of the recorder.	
2-10	Adjust the X zero control of the recorder to position the pen tip above the zero line of the X axis.	The zero line corresponds to 300Hz.
2-11	Lower, then raise, the pen.	The pen will make a dot on the zero line of the X axis.
2-12	Press the Manual Trigger key.	The 650 will sweep to 3300Hz and the chart pen will move to the 10V position as determined by the reduced setting of the X gain control.
2-13	Adjust the X gain of the recorder to position the pen tip above the 10th line of the X axis.	The 10th line corresponds to 3,300Hz. Each intermediate line represents an increase of 300Hz.
2-14	Lower, then raise the pen.	The pen will make a dot on the 10th line of the X axis.
2-15	Press the Manual Trigger key.	The 650 will reset to 300Hz and the recorder pen will return to the 0 line of the X axis.
2-16	If the pen did not stop exactly on the 0 line, re-position it at 0 with the X zero control.	
2-17	Lower, then raise, the pen.	The pen will make a new dot on the 0 line.
2-18	Press the Manual Trigger key.	The 650 will sweep to 3300Hz and the chart pen will move to the 10th chart line.
2-19	If the pen did not stop exactly on the 10th line, re-position it at 10 with the X gain control.	
2-20	Lower, then raise, the pen.	The pen will make a new dot on the 10th line.
2-21	Press the Manual Trigger key.	The 650 will reset to 300Hz and the chart pen will move to the 0 line.
2-22	Repeat steps 16-21 until the pen sweeps correctly between the two lines.	

Table 8-2. 90° Sweep Test (Continued)

Step	Action	Response
2-23	The current test setup has the phase meter measuring 90° (see step 1-10 in table 8-1). Offset the V/° output of the phase meter (which represents the 90° measurement) to 0V. To offset the V/° output, 1) adjust the offset controls of the meter, 2) adjust the offset controls of the chart recorder, or 3) connect an offset circuit between the meter and the recorder.	
2-24	Connect the V/° output of the phase meter to the Y axis of recorder.	The chart pen will assume the 0V (90°) position (as determined by the reduced setting of the Y gain control).
2-25	Adjust the Y zero control to place the pen near the center of the graph.	
2-26	Enter this key sequence to set the phase of channel 2 to 89°: Channel Number 2 Channel PHASE 89 Execute	The pen will move to the 89° position (as determined by the current setting of the Y gain control).
2-27	Adjust the Y gain control to establish (or modify) the spread on the graph between the 89° and 91° limits.	The first adjustment of Y gain should move the pen to a major division line about 5 divisions away from the starting position of the pen. Subsequent adjustments (described in later steps) will modify the spread to fit the divisions exactly.
2-28	If necessary, adjust the Y zero control to place the pen exactly on the division line.	This zero adjustment aligns the 89° and 91° endpoints of the pen's range with the lines of the graph paper.
2-29	Lower, then raise, the pen.	The pen will make a dot on the 89° line.
2-30	Enter this key sequence to set the phase of channel 2 to 91°: 91 Execute	The pen will move to the 91° position.
2-31	Lower, then raise, the pen.	The pen will make a dot on the 91° line.
2-32	If the 91° pen dot does not fall on a decimal line (for example, if it falls on a line 7 instead of 10 divisions away from the 89° dot), or if it does not fall exactly on the correct line then go back and repeat steps 26-32 as many times as necessary to make the 89° and 91° positions of the pen coincide with the proper lines of the graph paper.	The 89° and 91° dots should lie far enough apart to give the graph good resolution and should have a decimal number of chart divisions between them (5, 10, or 20 divisions instead of 3, 6, or 7).
2-33	Enter this key sequence to set the phase of channel 2 to 90°: 90 Execute	The pen should travel to a division line half way between the 89° and 90° dots.

Table 8-2. 90° Sweep Test (Continued)

Step	Action	Response
2-34	Enter this key sequence to set the sweep time to 60 seconds: Sweep FREQ TIME 60 Execute	
2-35	Lower the pen.	
2-36	Press the Manual Trigger key.	The 650 will sweep from 300 to 3300Hz in 60 seconds and the recorder will draw the meter's version of the constant 90° phase angle between the two signals.
2-37	Raise the pen.	
2-38	Press the Manual Trigger key.	The 650 will reset to 300Hz and the pen will return to the 0 line.
2-39	Remove the graph.	

Table 8-3. 120° Sweep Test

This table tests the meter's ability to measure a 120° phase from 300-3300Hz.

Note: Run the procedures in Tables 8-1 and 8-2 before you run this procedure.

Step	Action	Response
3-1	Load another sheet of graph paper in the recorder.	
3-2	Either put the recorder in standby or disconnect the V/° output of the phase meter from the Y input of the recorder.	
3-3	Press this key sequence to give channel 2 a phase of 120°: Channel Number 2 Channel PHASE 120 Execute	Channel 2 will assume a phase of 120° relative to channel 1. The phase meter will measure 120°.
3-4	Offset the V/° output of the phase meter to 0V (see step 2-23 in table 8-2 for details).	
3-5	Either take the recorder off standby or re-connect the V/° output of the phase meter to the Y input of the recorder.	The pen will move to the 0V (120°) position.
3-6	Adjust the X zero control to place the pen directly above the 0 line of the X axis.	Use the same zero line as you used for the 90° graph.

Table 8-3. 120° Sweep Test (Continued)

Step	Action	Response
3-7	Adjust the Y zero control to place the pen directly above a Y axis division line near the center of the graph.	This line will represent 120°.
3-8	Lower, then raise the pen.	The pen will make a dot at 120° on the Y-axis and 300Hz on the X-axis.
3-9	Press the left or right cursor arrows as required to move the cursor (<u>underline</u>) to the zero in 120° in the phase display.	[phase 0,000,120.000 Deg]
3-10	Press the up cursor arrow once to change the phase to 121°.	[phase 0,000,121.000 Deg] The pen will move to the 121° division line.
3-11	Lower, then raise the pen.	The pen will make a dot at 121° on the Y-axis and 300Hz on the X-axis.
3-12	Press the down cursor arrow twice to change the phase to 119°.	[phase 0,000,119.000 Deg] The pen will move to the 119° division line.
3-13	Lower, then raise the pen.	The pen will make a dot at 119° on the Y-axis and 300Hz on the X-axis.
3-14	Press the up cursor arrow once to change the phase to 120°.	[phase 0,000,120.000 Deg] The pen will move to the 120° division line.
3-15	Lower the pen.	
3-16	Press the Manual Trigger key.	The 650 will sweep from 300 to 3300Hz in 60 seconds and the recorder will draw the meter's version of the constant 120° phase angle between the two signals.
3-17	Raise the pen.	
3-18	Press the Manual Trigger key.	The 650 will reset to 300Hz and the pen will return to the 0 line.
3-19	Remove the graph.	

Table 8-4. 240° Sweep Test

This table tests the meter's ability to measure a 240° phase from 300-3300Hz.

Note: Run the procedures in tables 8-1 through 8-3 before you run this procedure.

Step	Action	Response
4-1	Load another sheet of graph paper in the recorder.	
4-2	Either put the recorder in standby or disconnect the V/° output of the phase meter from the Y input of the recorder.	
4-3	Press this key sequence to give channel 2 a phase of 240°: Channel Number 2 Channel PHASE 240° Execute	Channel 2 will assume a phase of 240° relative to channel 1. The phase meter will measure 240°.
4-4	Offset the V/° output of the phase meter to 0V (see step 2-23 in table 8-2 for details).	
4-5	Either take the recorder off standby or re-connect the V/° output of the phase meter to the Y input of the recorder.	The pen will move to the 0V (240°) position.
4-6	Adjust the X zero control to place the pen directly above the 0 line of the X axis.	Use the same zero line as you used for the 90° graph.
4-7	Adjust the Y zero control to place the pen directly above a Y axis division line near the center of the graph.	This line will represent 240°.
4-8	Lower, then raise the pen.	The pen will make a dot at 240° on the Y-axis and 300Hz on the X-axis.
4-9	Press the left or right cursor arrows as required to move the cursor (underline) to the zero in 240° in the phase display.	[phase 0,000,240.000 Deg]
4-10	Press the up cursor arrow once to change the phase to 241°.	[phase 0,000,241.000 Deg] The pen will move to the 241° division line.
4-11	Lower, then raise the pen.	The pen will make a dot at 241° on the Y-axis and 300Hz on the X-axis.
4-12	Press the down cursor arrow twice to change the phase to 239°.	[phase 0,000,239.000 Deg] The pen will move to the 239° division line.
4-13	Lower, then raise the pen.	The pen will make a dot at 239° on the Y-axis and 300Hz on the X-axis.

Table 8-4. 240° Sweep Test (Continued)

Step	Action	Response
4-14	Press the up cursor arrow once to change the phase to 240°.	[phase 0,000,240.000 Deg] The pen will move to the 240° division line.
4-15	Lower the pen.	
4-16	Press the Manual Trigger key.	The 650 will sweep from 300 to 3300Hz in 60 seconds and the recorder will draw the meter's version of the constant 240° phase angle between the two signals.
4-17	Raise the pen.	
4-18	Press the Manual Trigger key.	The 650 will reset to 300Hz and the pen will return to the 0 line.
4-19	Remove the graph.	

8.5 WAVETEK 740 EXAMPLE

Figure 8-2 shows 90°, 120°, and 240° measured-phase vs frequency graphs for the no-longer-manufactured Wavetek 740 Phase Meter.

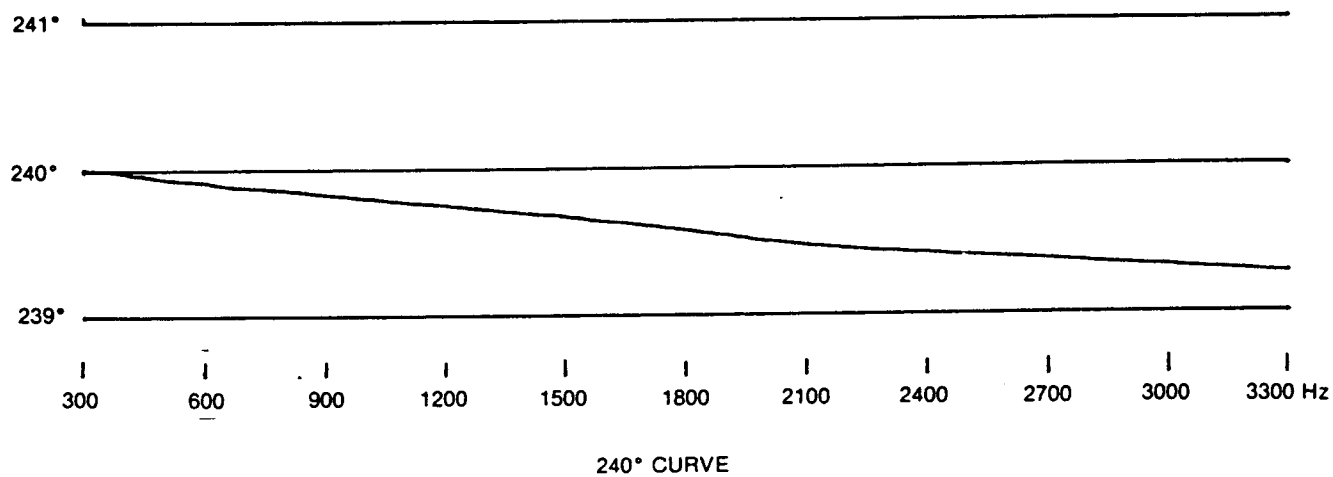
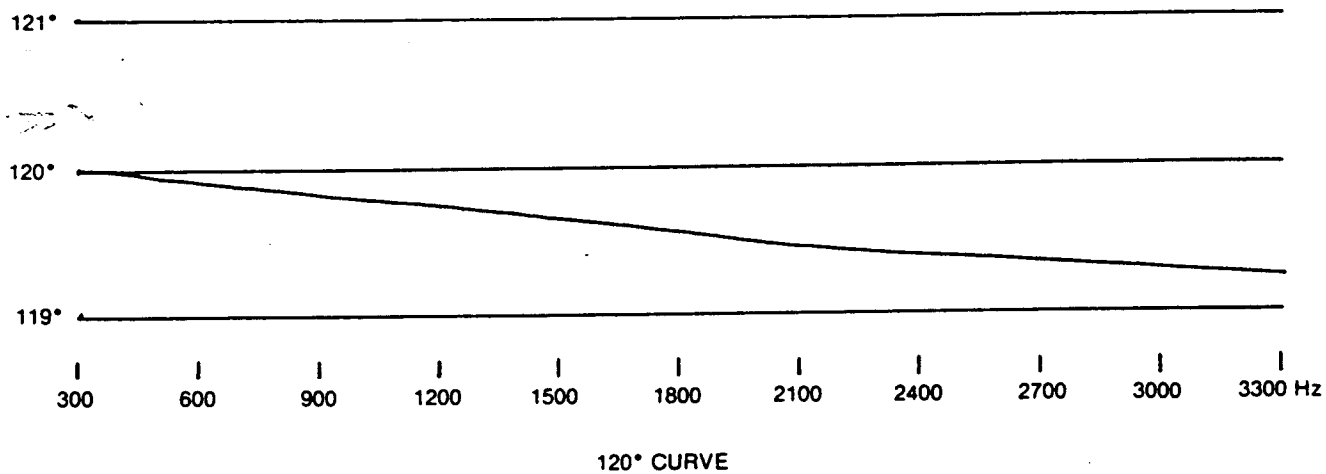
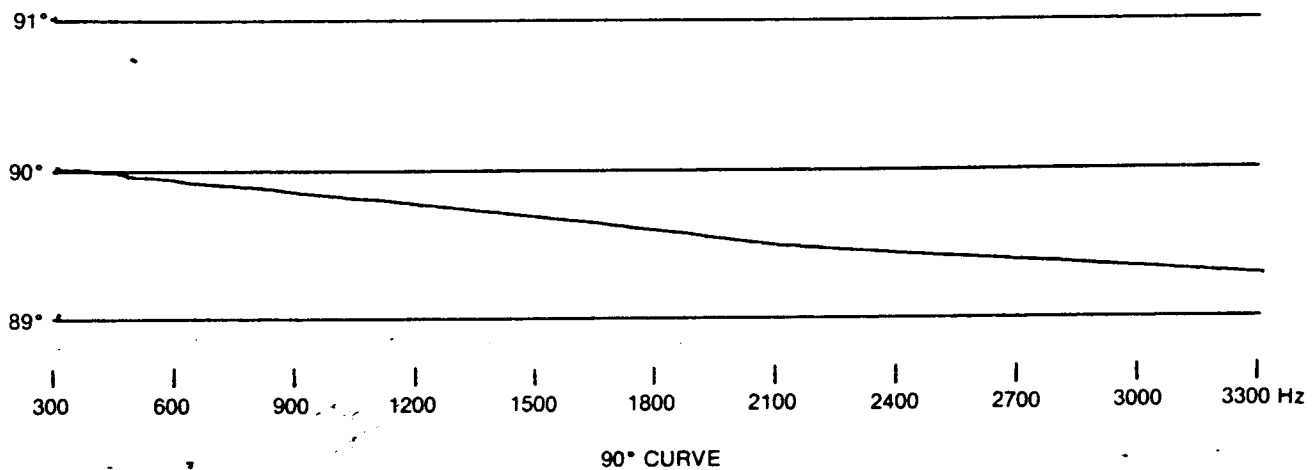

Figure 8-2. Wavetek 740 Measured-Phase vs Frequency Graphs

APPENDIX A

ERROR/STATUS MESSAGES

The following list contains both front panel and GPIB messages. A suggested correction follows each message. For more information, look up the descriptions of the keys that correct the problem.

200KHZ MAX IN TRI/RAMP Either set **Channel** FUNC to SINE, SQUARE, or DC, or set **Main** FREQ to 200kHz or less.

200KHZ MAX IN TRIG MODE Either take **Main** MODE out of TRIG or set **Main** FREQ to 200kHz or less.

3V BATTERY IS LOW: XX V Replace internal lithium battery.

AMPL/OFST CLIPPING LIMIT Set **Channel** AMPL and **Channel** OFFSET to values that stay within the output voltage limits of +25V and -25V.

AMPL/OFST RATIO WARNING Set **Channel** AMPL and **Channel** OFFSET to values that stay within the output voltage limits of +25V and -25V.

AMPLITUDE ERROR Set **Channel** AMPL to less than 50V.

AUTO CAL COMPLETE 00000000 The auto calibration program (started by the GPIB AUTOCAL command) ran auto calibration, found no errors, and put this message in the SRQ message buffer.

AUTO CAL COMPLETE HHHHHHHH The auto calibration program (started by the GPIB AUTOCAL command) ran auto calibration, found an error, and put this message in the SRQ message buffer. See GPIB SRQ messages for an explanation of the hex error number.

AUTO CAL DATA ERROR The power-up program detected a checksum error in the stored auto cal data. Press **Utility** CAL START.

AUTO CALIBRATION COMPLETED 00000000 The auto calibration program (started by **Utility** CAL START) ran auto calibration and found no errors.

AUTO CALIBRATION COMPLETED HHHHHHHH The auto calibration program (started by **Utility** CAL START) ran auto calibration and found this error. The auto calibration section decodes the error message numbers.

BURST COMPLETE The burst set up with **Main** BURCNT and **Main** MODE BURST has finished.

BURSTCOUNT ERROR Set **Main** BURCNT to less than 65535.

CANNOT CAL AMPL ON CHNL N The **Quick Calibrate** procedure cannot correct an amplitude error in channel N.

CANNOT CAL OFST ON CHNL N The **Quick Calibrate** procedure cannot correct an offset error in channel N.

CANNOT CAL PHSE ON CHNL N The **Quick Calibrate** procedure cannot correct a phase error in channel N.

CANNOT SWEEP IN PHASE LOCK If you want to sweep, press **Main** MODE CONT. If you want to lock phase, press **Sweep** OFF.

CENTERFREQUENCY ERROR Set **Sweep** FREQ LIMITS CENTER to more than 0.0001Hz or less than 2MHz.

CENTERPHASE ERROR Set **Sweep** PHASE LIMITS CENTER to less than 9,999,999.995°.

CH1-DC NOT ALLOWED IN PLL Either press **Channel Number** 1 **Channel** FUNC SINE, or press **Main** MODE, then select a mode other than PHSK.

CHANNEL ERROR Set **Channel Number** to 1, 2, 3, or 4 for four channel units or to 1 or 2 for two channel units.

COMMUNICATIONS FAILURE Press any key, then press **Stored Settings** RECALL 0 **Execute** to recall the current instrument setup.

CONFIGURATION ERROR When selecting instrument configuration by number, set **Utility** CONFIG to 0 for INDEPN, 1 for MASTER, or 2 for SLAVE.

DELAY ERROR Set **Channel** SHIFT DELAY to more than -2.000msec or less than +2.000msec.

DELTA FREQUENCY ERROR Set **Sweep** PHASE DLTA-F to more than -1000Hz or less than +1000Hz.

DISABLE SETTING ERROR Set **Stored Settings** DISABL to any number from 1 to 25.

DUTY CYCLE 20-80% IN-SQUARE Set **Channel** SHIFT DUTY between 20% and 80%.

DUTY CYCLE ERROR Set **Channel** SHIFT DUTY between 20% and 80%.

ENABLE SETTING ERROR Set **Stored Settings** ENABLE to any number from 1 to 25.

EXECUTE COMPLETE The 650 executed the command string just sent to it over the GPIB bus.

EXTERNAL PHASE CAL COMPLETE N The external calibration program (started by the GPIB command EXTERNALCAL?) measured the phase of an external amplifier, found a delay of n degrees, and put this message in the SRQ message buffer.

EXTERNAL PHASE: -XXXX DEGREES The external calibration program (started by **Utility** CAL EXTRNL) measured the phase of an external amplifier and found a delay of XXXX degrees.

(FREQ X RATIO) > 2MHZ Set **Channel** SHIFT RATIO to any whole number (from 1 through 99) that keeps the channel output frequency less than 2MHz.

FREQUENCY ERROR Set **Main** FREQ between 0.0001Hz and 2MHz.

FRONT PANEL The 650 puts this message in its SRQ buffer if the operator presses the **GPIB** SRQ button.

FUNCTION ERROR When selecting waveform shape by number, set **Channel** FUNC to 0 for SINE, 1 for TRIANG, 2 for SQUARE, 3 for RAMP, 4 for DC, or 5 for TEST.

HOLD INPUT ERROR When selecting function of **Hold Input** connector by number, set **Utility** CONFIG to 0 for SWEEP hold or to 1 for WAVFM hold.

INT TRIG NOT ALLOWED Either set **Sweep** to mode 0-2, 7-9, 11-14, 19, 21-23, 24, 26, 28, or 29, or set **Trigger** to EXTRNL.

LCD VIEWING ANGLE ERROR Set **Utility** VIEW to any number from 0° to +45°.

LOW BATTERY = XX V Replace internal lithium battery.

MANUAL CAL ERROR When selecting manual calibration steps by number, set **Utility** CAL MANUAL to 0 through 7.

MARKER FREQUENCY ERROR Set **Sweep** FREQ MARKER to 0.0001Hz through 2MHz.

MARKER PHASE ERROR Set **Sweep** PHASE MARKER between -9,999,999.999 and +9,999,999.999.

MIN AMPL 0.25V IN ZERO OHM Either set **Channel** AMPL to 0.25v or greater, or set **Channel** SHIFT OUTPUT to ON-50 ohms.

MODE ERROR When selecting main mode by number, set **Main** MODE to 0 for CONT, 1 for TRIG, 2 for A-GATE, 3 for S-GATE, 4 for BURST, or 5 for PHSCLK.

OFFSET ERROR Set **Channel** OFFSET between +25V and -25V.

OUTPUT ERROR When selecting output impedance by number, set **Channel** SHIFT OUTPUT to 0 for OFF, 1 for ON-50 ohms, or 2 for ON-0 ohms.

OUTPUT PROTECTION ACTIVATED The output protection circuit opened the output relay. Remove the cause of the overload, then press **Reset** OVLOAD.

PERIOD ERROR Set **Main** PERIOD to 500nsec through 10,000 seconds.

PHASE ENGINE RESPONSE ERROR Communications error between the main microprocessor and the phase engine microprocessor. Press any key, then press **Stored Settings** RECALL 0 **Execute** to recall the current instrument setup.

PHASE ERROR Set **Channel** PHASE to -9,999,999.995° through +9,999,999.995°.

PLL NOT LOCKED Phase lock not locked. Check signal connected to the **Trig In** connector.

QUICK CAL COMPLETED (CE) The quick calibrate program (started with the GPIB QUICKCAL command) finished and placed this message in the SRQ buffer. CE = 00 for no errors. For errors, C = channel number and E = 1 for an amplitude error, 2 for an offset error, or 3 for a phase error.

RATIO ERROR Set **Channel** SHIFT RATIO to any whole number (from 1 through 99) that keeps the channel output frequency less than 2MHz.

RECALLSETTING LIMIT ERROR Set **Stored Settings** RECALL to any positive number (memory location) from 0 through 25.

SELFTEST IN PROGRESS The self test program (started by **Utility** TEST START) is testing the 650. Press ABORT to stop the test.

SELFTEST STOPPED PASSED ALL TESTS The self test program, started by **Utility** TEST START, tested the 650 and found no errors.

SEQUENCEFREQ ERROR Set **Sweep** FREQ MODE SEQNCE FREQ to any number from 0.0001Hz to 2MHz.

SEQUENCEINDEX ERROR Set **Sweep** FREQ/PHASE MODE SEQNCE INDEX to any number from 1 to 99.

SEQUENCELIMIT ERROR Set **Sweep** FREQ/PHASE MODE SEQNCE LIMIT to any number from 1 to 99.

SEQUENCEPHASE ERROR Set **Sweep** PHASE MODE SEQNCE PHASE above $-9,999,999.999^\circ$ and below $+9,999,999.999^\circ$.

SERIAL COMMUNICATIONS ERROR Communications error between the front panel microprocessor and the main microprocessor. Press any key, then press **Stored Settings** RECALL 0 **Execute** to recall the current instrument setup.

SPANFREQUENCY ERROR Set **Sweep** FREQ LIMITS SPAN to less than 2MHz.

SPANPHASE ERROR Set **Sweep** PHASE LIMITS SPAN to less than $19,999,999.98^\circ$.

SRQMASK ERROR Send an SRQMASK command within the range SRQMASK 0 to SRQMASK 7.

STARTFREQUENCY ERROR Set **Sweep** FREQ LIMITS START to more than 0.0001Hz (or less than 2MHz for reverse sweeps).

STARTPHASE ERROR Set **Sweep** PHASE LIMITS START to more than $-9,999,999.990^\circ$ (or less than $9,999,999.990^\circ$ for reverse sweeps).

STOPFREQUENCY ERROR Set **Sweep** FREQ LIMITS STOP to less than 2MHz (or more than 0.0001Hz for reverse sweeps).

STOPPHASE ERROR Set **Sweep** PHASE LIMITS STOP to less than $9,999,999.990^\circ$ (or more than $-9,999,999.990^\circ$ for reverse sweeps).

STORED SETTING ERROR Stored setting memory location ## contains faulty data. Recreate the instrument setup, then press **Stored Settings** STORE ## **Execute**.

STORED SETTING UNDEFINED Three possible corrections: Set **Stored Settings** STORE/RECALL to: 1) a whole number (no fractions), 2) to the number of a non-empty memory location, or 3) to the number of a non-disabled memory location. To enable a location, press **Stored Settings** ENABLE ## **Execute**.

STORESETTING LIMIT ERROR Set **Stored Settings** STORE to any positive number (memory location) from 1 through 25.

SWEEP CNTR/SPAN FREQ CONFLICT Set **Sweep** FREQ LIMITS CENTER and **Sweep** FREQ LIMITS SPAN to keep the sweep end points above 0.0001Hz and below 2MHz.

SWEEP CNTR/SPAN PHASE CONFLICT Set **Sweep** PHASE LIMITS CENTER and **Sweep** PHASE LIMITS SPAN to keep the sweep end points within $\pm 9,999,999.990^\circ$.

SWEEPCOMP ERROR When setting sweep compensation by number, set **Sweep** COMP to 0 for NO or to 1 for YES.

SWEEPFUNCTION ERROR When setting sweep function by number, set **Sweep** FREQ/PHASE FUNC to 0 for LINEAR, 1 for LOG, 2 for SINE, or 3 for RANDOM.

SWEEPMODE ERROR When selecting **Sweep** modes by number, use 0 through 29.

SWEPTIME ERROR Set **Sweep** FREQ/PHASE TIME inside limits. **Sweep** COMP NO limits minimum sweep-time to 10ms or more. **Sweep** COMP YES limits minimum sweep-time to 50ms or more. Maximum sweep time: 10 million seconds.

SWPTIME 50ms MIN WHEN COMP ON Set **Sweep** COMP NO to make sweep-time limit 10ms.

TIME 0.2 SEC MIN IN NONLINEAR Either set **Sweep** **FREQ/PHASE TIME** to 0.2 seconds or more, or set **Sweep** **FREQ/PHASE FUNC** to LINEAR.

TRIGGERFREQ ERROR Set **Trigger** **FREQ** to any number from 2.50mHz to 200kHz.

TRIGGERLEVEL ERROR Set **Trigger** **LEVEL** from -10.0V to +10.0V.

TRIGGERSLOPE ERROR When setting trigger slope by number, set **Trigger** **SLOPE** to 0 for POS or 1 for NEG.

TRIGGERSOURCE ERROR When setting trigger source by number, set **Trigger** to 0 for EXTRNL or 1 for INTRNL.

VIEWINGANGLE ERROR Set **Unity** **VIEW** to any positive number from 0° to 45°.