

**STEPNOSKI**

77501-M

**ORIEL**  
CORPORATION

250 Long Beach Boulevard  
Stratford, CT 06497-0872  
Phone: (203) 377-8282  
Fax: (203) 378-2457

**DC REGULATED BROAD BAND  
QUARTZ HALOGEN SOURCE  
MODEL 77501  
OPERATING PROCEDURES**

Please read these instructions completely before  
operating this equipment.

If there are any questions or problems regarding  
the use of this equipment, please contact:

ORIEL CORPORATION

- or -

L.O.T. - ORIEL  
9 Avenue De Laponie  
Z.A. De Courtabœuf  
91951 Les Ulis Cedex  
France  
Phone: 01-69-07-20-20  
Fax: 01-69-07-23-57

L.O.T. - ORIEL  
Im Tiefen See 58  
D-6100 Darmstadt  
Federal Republic of Germany  
Phone: (06151) 88060  
Fax: (06151) 84173  
Tlx: 2627 17 6151 999  
(Teletext)

L.O.T. - ORIEL  
1 Mole Business Park  
Leatherhead  
Surrey KT22 7AU  
England  
Phone: 0372-378822  
Fax: 0372-375-353

- or -

The representative from whom this equipment was purchased.

900126  
WPNO.5

## TABLE OF CONTENTS

SECTION I	HAZARDS .....	3
SECTION II	INTRODUCTION .....	3
SECTION III	OPERATION .....	4
SECTION IV	SPECIFICATIONS .....	5
SECTION V	LAMP INSTALLATION .....	7
SECTION VI	CIRCUIT DESCRIPTION .....	8
SECTION VII	TROUBLESHOOTING .....	9
SECTION VIII	DRAWINGS .....	10
	WARRANTY AND RETURNS	

## SECTION I - HAZARDS

There are two hazards connected with the operation of this Quartz Halogen Illuminator:

### HAZARDS DUE TO LIGHT OR RADIATION

Do not look directly into output beam of the illuminator even for short periods of time. The UV radiation can permanently damage the retina of the eye causing blindness.

### ELECTRICAL SHOCK HAZARD

Keep personnel clear of all exposed terminals.

Before re-lamping or working on the system, disconnect input power.

## SECTION II - INTRODUCTION

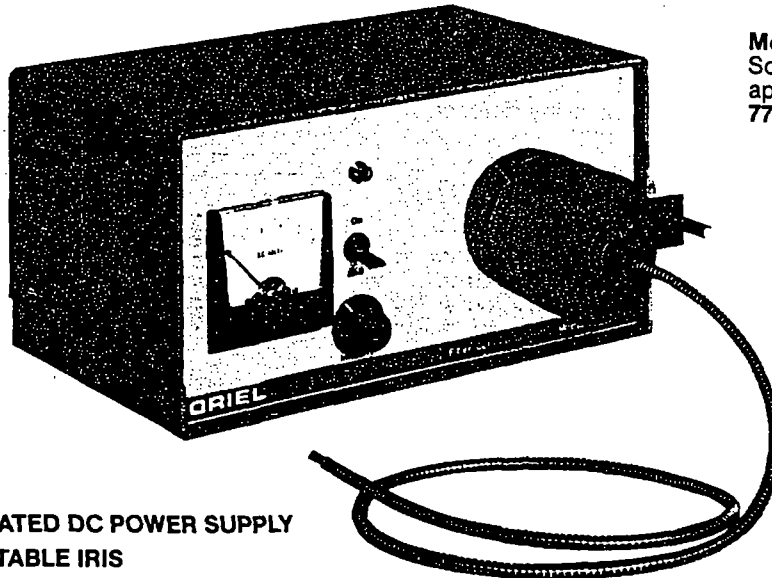

Model 77501 Fiber Optics Source for radiometric application shown with 77525 fiber optics cable.

- Model 77501 ■ REGULATED DC POWER SUPPLY  
■ ADJUSTABLE IRIS  
■ MANUAL SHUTTER  
■ 100 WATT QUARTZ HALOGEN LAMP  
■ BUILT-IN FILTER HOLDER  
■ ON-OFF SWITCH  
■ VOLTMETER

The Model 77501 features a 100 watt Quartz Halogen Lamp powered by a built-in regulated DC power supply. An iris adjusts light intensity without changing the color temperature of the lamp while a shutter allows **zero checking** when used in conjunction with a radiometer. A built-in filter holder accepts 25.4 mm (one inch diameter) filters up to 9.5 mm (.375 inch) thick (i.e., up to three mm thick or three 1/8 inch thick filters or any similar combination). A voltmeter allows reproducing voltage set points. The Model 77501 is useful for radiometric, spectroscopic or other high stability applications.

### SECTION III - OPERATION

Any of the fiber bundles listed in the Fiber Optics Catalog (except the 8 mm liquid light guide) can be used with this illuminator.

#### Initial Set-up

1. Connect the line cord to the back of the illuminator and to an electric outlet (115 VAC, 60 Hz).
2. Insert the fiber with an 11 mm (.436 inch) ferrule adapter into the snout at the front of the illuminator.
3. Turn down the intensity control and turn the power switch **ON**. Turn up the intensity control until the panel meter reads 12 volts.
4. Shine the light output from the fiber at a surface and slide the 11 mm ferrule back and forth in the illuminator snout until the light output is maximized.
5. Adjust the two screws on the front of the illuminator snout in X and Y motion to further maximize the light output.

See drawing next page

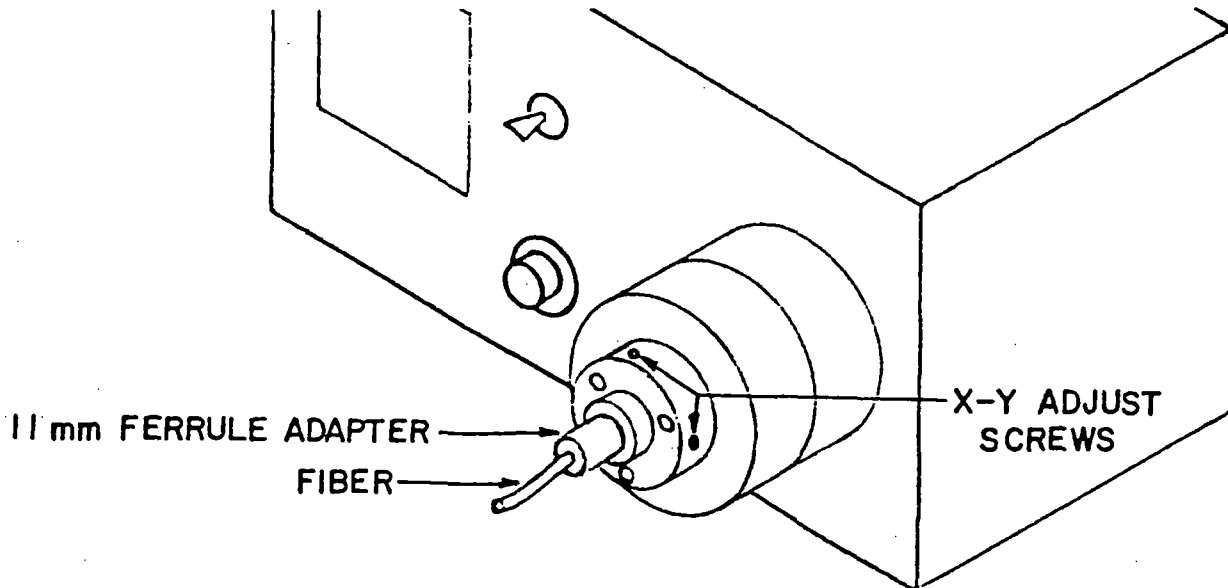

#### Filter Holder

1. Slide the cylindrical cover either clockwise or counter-clockwise until the filter compartment is exposed.
2. Grasp the two knurled handles on the filter holder between the thumb and forefinger and pull up and to the left.
3. Back off the nylon wheels and insert the required 1" diameter filters. Tighten the nylon wheels to hold the filters in place.
4. Replace the filter holder and close the cover.

### Intensity Adjustment; Lamp Life vs. Voltage

An increase of 6% in voltage reduces the operating rated life by 50%. A reduction in voltage will increase rated life but a reduction of operating voltage by more than 10% may drastically shorten life by disturbing the halogen cycle of the lamp. Therefore, the operating voltage should be kept between 11 and 12 volts for maximum life, and no higher than 13 volts if higher light output is required.

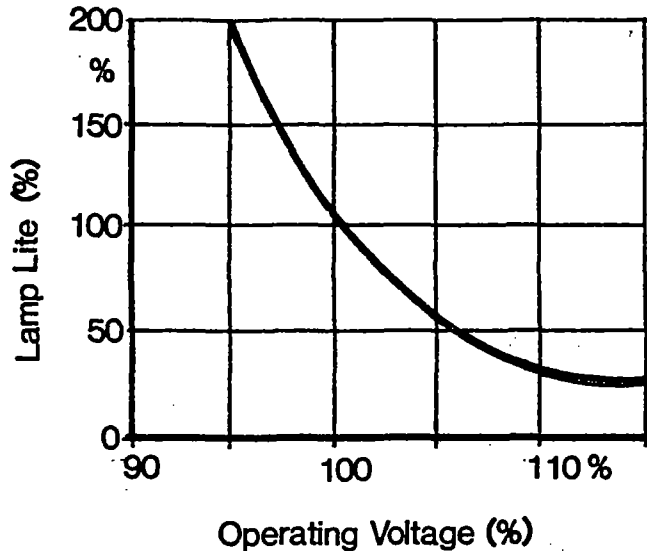

### SECTION IV - SPECIFICATIONS

Output power in mw/nm vs. wavelength can be estimated as follows:

Using the spectral irradiance curve for the 100 watt Quartz Halogen Lamp, read the value of the irradiance at the desired wavelength. Disregarding the irradiance units, multiply the value by .4. Multiply this result by the transmission of the fiber given in the fiber transmission curve. The fiber transmission curve is for a 3.2 mm (.125 inch) diameter, 0.9 mm (36 inch) long glass fiber Model 77525. The total integrated output through the fiber is approximately 200 mw.

## SECTION V - LAMP INSTALLATION

1. Turn the ON-OFF switch to **OFF** or unplug the cord from the electrical outlet.
2. Remove quick disconnect screws and remove top cover. Remove old lamp.
3. Mount the lamp in the socket adapter by carefully lining up the two pins of the lamp with the socket and push in slowly without excessive rocking back and forth.

**SPECTRAL IRRADIANCE:** The curve below shows spectral irradiance for the 100 watt operated at 3200°K.

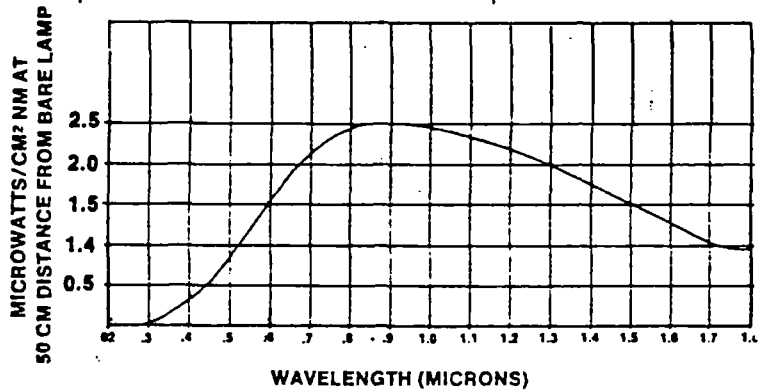

GLASS FIBER OPTIC 3.2 mm (.125 in.) diameter  
0.91 m (36 in.) long

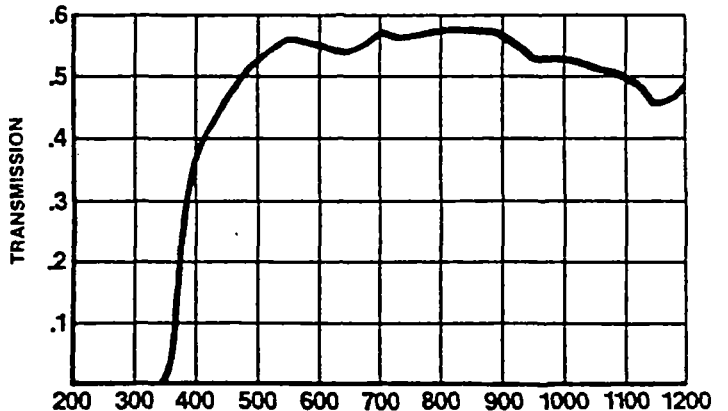

**THESE LAMPS ARE VERY DELICATE AND SHOULD NOT BE  
SUBJECTED TO EXCESSIVE STRAIN OR THEY MAY BREAK.**

Do not touch the lamp with your fingers. Use the clear envelope in which the lamp was packaged or a clean dry cloth to prevent putting fingerprints on the lamp. If fingerprints are accidentally transferred to the lamp, remove them. After lamp is in position, clean the envelope with alcohol and lint-free tissue. Fingerprints left on the lamp when lit may cause the lamp to break or explode damaging other illuminator parts.

4. Replace the cover and operate normally.
5. The lamp socket will experience wear during normal usage, especially from lamp changing. Replacement of the lamp socket is recommended after 500 hours of operation.

## SECTION VI - CIRCUIT DESCRIPTION

Refer to Oriol Schematic 77501-2-1101.

The DC regulated fiber optic power supply is a modular unit having the following specifications:

Input	105-125 VAC, 50-420 Hz (230 VAC OPT)
Regulation:	
Line	0.005% or 2mv minimum (10 volt change)
Load	0.050% or 10mv minimum (full load change)
Ripple	Less than 50 mv
Temperature:	
Operating	0 - 70°C
Storage	-25 to 85°C
Coefficient	0.01% / °C max.
Current Limiting	Fixed fold-back, set 125-130% of rated current, automatic recovery



## SECTION VII - TROUBLESHOOTING

### Theory of Operation of Unit

The DC Power Supply is an all-silicon, regulated supply with 0.005% line regulation, 0.05% load regulation, 500 microvolts maximum ripple, foldback current limiting and minimum size and weight.

Transformer T1 isolates the AC line from the supply and furnishes an AC voltage to auxiliary supply diode CR1 and main supply diodes CR2 and CR3. Diode CR1 rectifies the auxiliary voltage, furnishing 10 volts to filter capacitor C1. The DC voltage from C1 is applied to voltage regulator U1 through R4 and to the overcurrent through R5.

Main power diodes CR2 and CR3 rectify the AC voltage which is then filtered by C2 and provided to the collectors of pass transistors Q1 and Q2.

The output voltage is controlled by voltage regulator U1. This regulator consists of a temperature-compensated reference amplifier, error amplifier, seriespass transistor and current-limiting circuitry. A portion of the output voltage from R14 (dual supply R12) is fed into U1 and compared against the internal voltage reference. The amplified error signal is fed to Q2 causing it to turn on or off. Q1 follows Q2 and keeps the output voltage constant.

When a predetermined voltage is developed from excessive load current across R8 (dual supply - R3), the current limiting circuitry in the regulator turns on causing the output voltage and current to drop to a small value, thereby protecting the supply. Upon removal of the excess load, the supply returns to normal operation.

If the sense terminals (+S and -S) are not used on the single units, the sense terminals must be jumpered to their respective output terminals. The amplifier will then regulate the voltage appearing at the output terminals. For regulation of the voltage at loads a remote distance from the supply, the sense terminals may be used. The remote load should be connected to the + and - terminals with additional light duty leads from the +S and -S terminals. The amplifier will then obtain the error signal directly from the load and regulate accordingly, compensating for voltage drops in the leads to the + and - terminals.

Operating Notes

Always remove AC power to the supply after operation of the overvoltage circuit. Also, the voltage control potentiometer R14 (dual supply - R12) should be turned counter-clockwise and the fuse replaced if necessary.

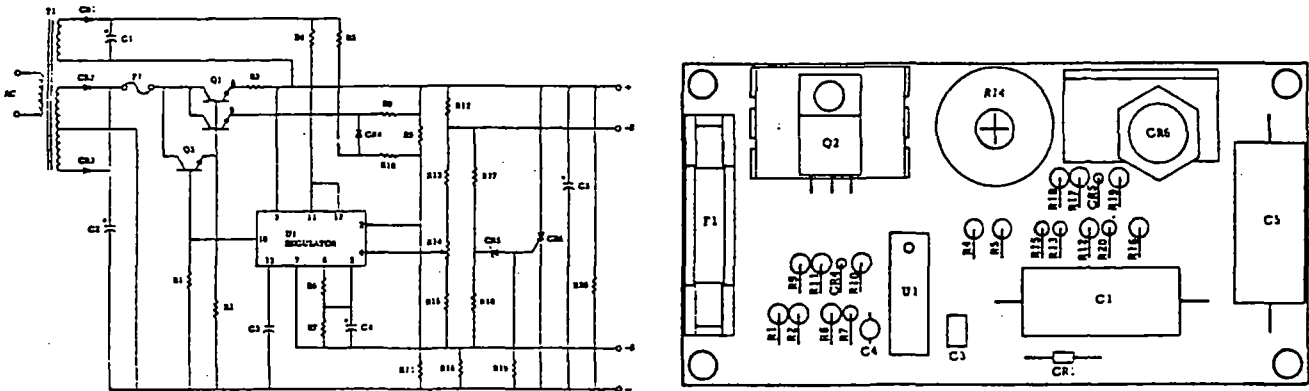

R1	10K	R14	500 POT	CR2, CR3	VTA200/T (VARO)
R6	910	R19	1K	CR6	2N681
R9	510	C1	500 mfd, 15v	Q1A, Q1B	2N3055
R10	150	C3	1000 mmfd	U1	723C
R12, R16	10	C4	4.7 mfd, 10v	C2	14,000 mfd, 40v
R2	720	CR1, CR4	1N4002	C5	500 mfd, 15v
R3, R8	0.1 BWH	R13	430	CR5	1N4742A
R4	390	R15	750	Q2	2N5296
R5	1K	R17	47	F1	AGC10
R7	OMITTED	R18	720		
R11	4.3K	R20	820		

SECTION VIII - DRAWINGS

Included in this manual are the following drawings:

- |              |   |
|--------------|---|
| 77501-2-1001 | Schematic, D.C. Fiber Optic Illuminator |
| 77500-2-1200 | Filter Assembly                         |

REV	DESCRIPTION	DATE	BY
A	ERR NO. 2645	11-16-82	FM

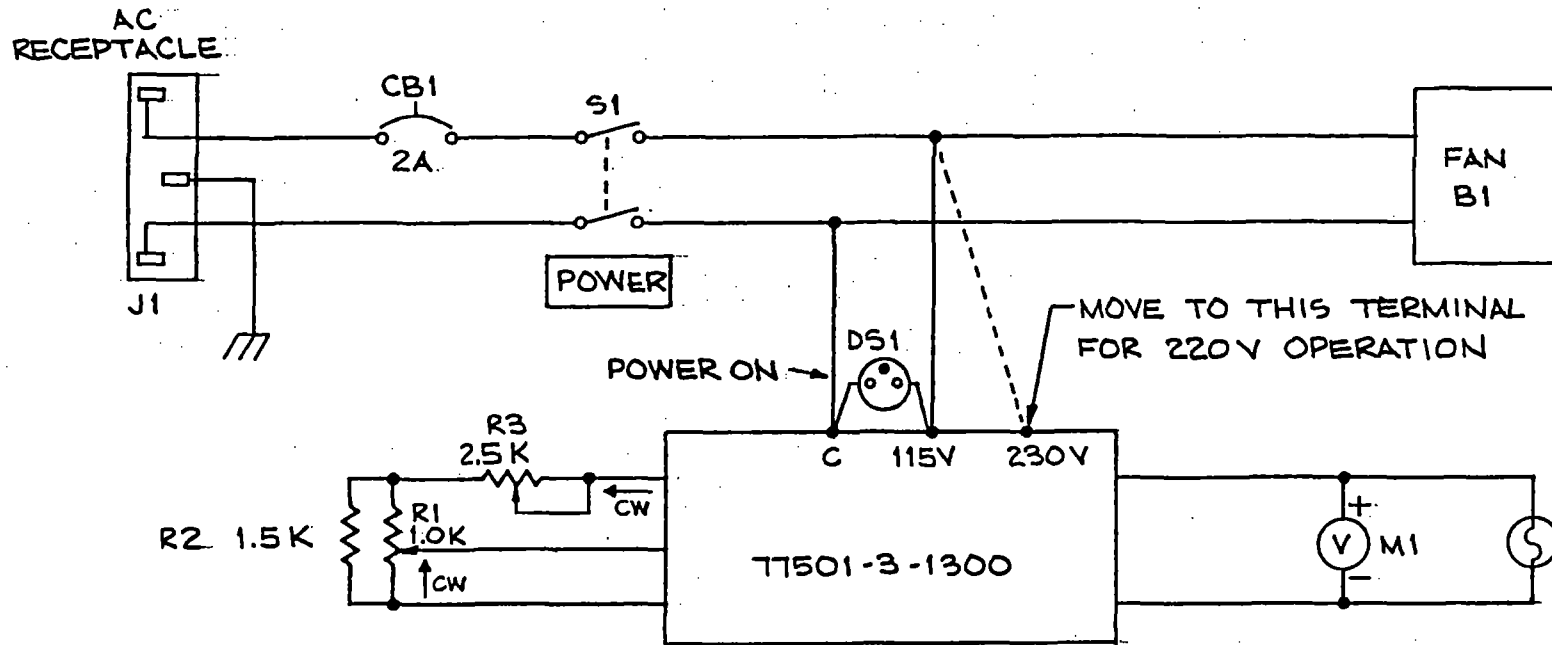

MATERIAL	DATE DRAWN 8.12.82	<b>ORIEL</b> CORPORATION STAMFORD, CONNECTICUT
FINISH	DRAWN BY MERGLIANO	
DO NOT SCALE DRAWING	CHECKED	TITLE
✓ SURFACES TO BE _____ ✓ RMS	A. BUNOVSKY	SCHMATIC, D.C. FIBER OPTIC ILLUMINATOR
UNLESS OTHERWISE SPECIFIED DIMENSIONS ARE IN INCHES FRACTIONS - 2 PLACE 3 PLACE ANGLES		DRAWING NO. 77501-2-1001
SHARP CORNERS TO BE .008" MAX. RADIUS CHAMFERS NOT DIMENSIONED TO BE .0145" ANY 2 DIAS. CONCENTRIC WITHIN .008 TR	SCALE	

REV	DESCRIPTION	DATE	BY

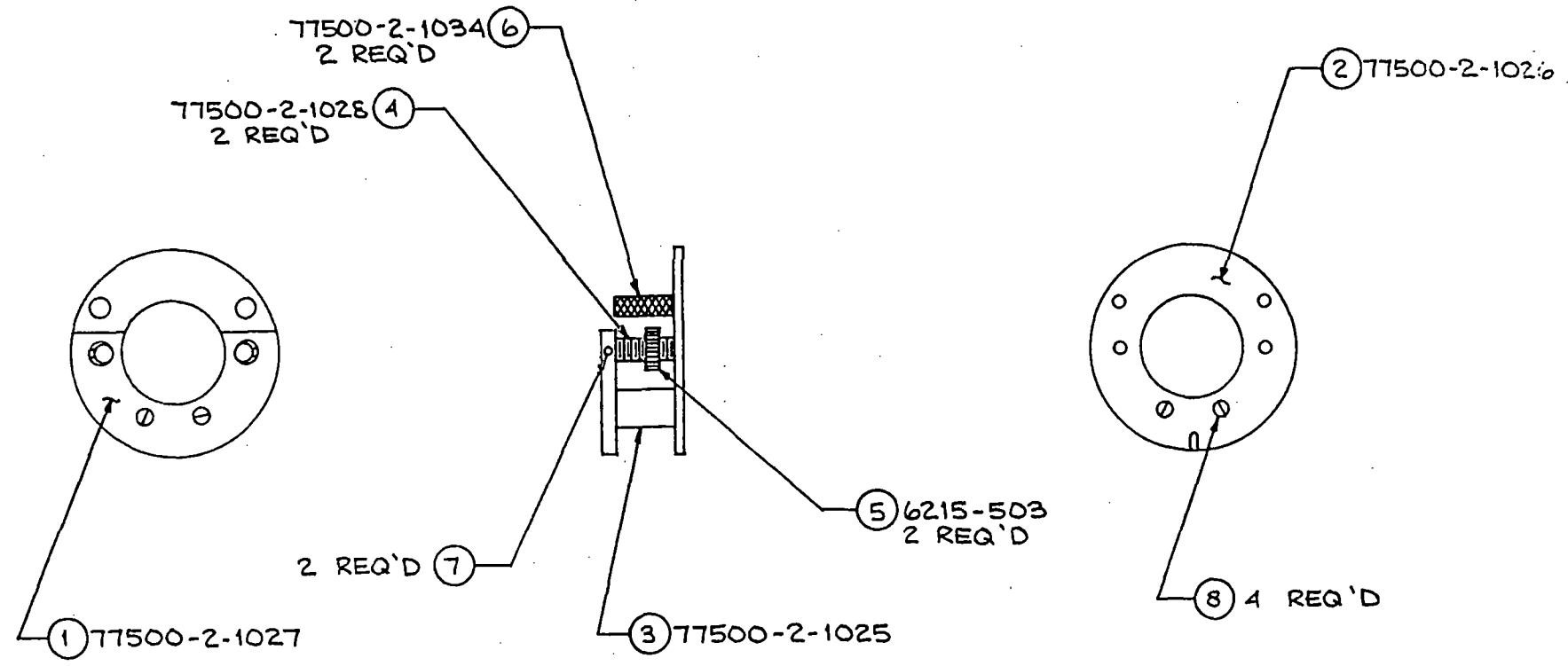

MATERIAL	DATE DRAWN 7-28-82	<b>ORIEL</b> CORPORATION STAMFORD, CONNECTICUT
FINISH	DRAWN BY MERIGLIANO	
DO NOT SCALE DRAWING	CHECKED	TITLE FILTER ASSY
✓ SURFACES TO BE _____ ✓ RMS UNLESS OTHERWISE SPECIFIED DIMENSIONS ARE IN INCHES FRACTIONS 2 PLACE 3 PLACE ANGLES		DRAWING NO. 77500-2-1200
SHARP CORNERS TO BE 005" MAX. RADIUS CHAMFERS NOT DIMENSIONED TO BE 03/45" ANT 2 DIAS CONCENTRIC WITHIN .004 TH	SCALE	

# WARRANTY AND RETURNS

## WARRANTY

Oriel Corporation warrants that all goods described in this manual (except consumables such as lamps, bulbs, filters, ellipses, etc.) shall be free from defects in material and workmanship. Such defects must become apparent within the following period:

1. All products described here, except spare parts: one (1) year or 3000 hours of operation, whichever comes first, after delivery of the goods to buyer.
2. Spare parts: ninety (90) days after delivery of goods to buyer.

Oriel Corporation's liability under this warranty is limited to the adjustment, repair and/or replacement of the defective part(s). During the above listed warranty period, Oriel Corporation shall provide all materials to accomplish the repaired adjustment, repair or replacement. Oriel Corporation shall provide the labor required during the above listed warranty period to adjust, repair and/or replace the defective goods at no cost to the buyer ONLY IF the defective goods are returned, freight prepaid, to an Oriel Corporation designated facility. If goods are not returned to Oriel Corporation, and user chooses to have repairs made at their premises, Oriel Corporation shall provide labor for field adjustment, repair and/or replacement at prevailing rates for field service, on a portal-to-portal basis.

Oriel Corporation shall be relieved of all obligations and liability under this warranty if:

1. The user operates the device with any accessory, equipment or part not specifically approved or manufactured or specified by Oriel Corporation unless buyer furnishes reasonable evidence that such installations were not a cause of the defect. This provision shall not apply to any accessory, equipment or part which does not affect the safe operation of the device.
2. The goods are not operated or maintained in accordance with Oriel's instructions and specifications.
3. The goods have been repaired, altered or modified by other than Oriel authorized personnel.
4. Buyer does not return the defective goods, freight prepaid, to Oriel repair facility within the applicable warranty period.

IT IS EXPRESSLY AGREED THAT THIS WARRANTY SHALL REPLACE ALL WARRANTIES OF FITNESS AND MERCHANTABILITY. BUYER HEREBY WAIVES ALL OTHER WARRANTIES, GUARANTIES, CONDITIONS OR LIABILITIES, EXPRESSED OR IMPLIED, ARISING BY LAW OR OTHERWISE, WHETHER OR NOT OCCASIONED BY ORIEL'S NEGLIGENCE.

This warranty shall not be extended, altered or varied except by a written document signed by both parties. If any portion of this agreement is invalidated, the remainder of the agreement shall remain in full force and effect.

## CONSEQUENTIAL DAMAGES -

Oriel Corporation shall not be responsible for consequential damages resulting from misfunctions or malfunctions of the goods described in this manual. Oriel's total responsibility is limited to repairing or replacing the malfunctioning or malfunctioning goods under the terms and conditions of the above described warranty.

## INSURANCE -

Persons receiving goods for demonstrations, demo loan, temporary use or in any manner in which title is not transferred from Oriel, shall assume full responsibility for any and all damage while in their care, custody and control. If damage occurs, unrelated to the proper and warranted use and performance of the goods, recipient of the goods accepts full responsibility for restoring the goods to their condition upon original delivery, and for assuming all costs and charges.

## RETURNS

Before returning equipment to Oriel for repair, please call the Customer Service Department at (203) 377-8282. Have your purchase order number available before calling Oriel. The Customer Service Representative will give you a Return Material Authorization number (RMA). Having an RMA will shorten the time required for the repair, because it ensures that your equipment will be properly processed. Write the RMA on the returned equipment's box. Equipment returned without a RMA may be rejected by the Oriel Receiving Department. Equipment returned under warranty will be returned with no charge for the repair or shipping. Oriel will notify you of repairs not covered by warranty, with the cost of the repair, before starting the work.

Please return equipment in the original (or equivalent) packaging. You will be responsible for damage incurred from inadequate packaging, if the original packaging is not used.

Include the cables, connector caps and antistatic materials sent and/or used with the equipment, so that Oriel can verify correct operation of these accessories.

# THE ORIEL 3 VOLUME CATALOG

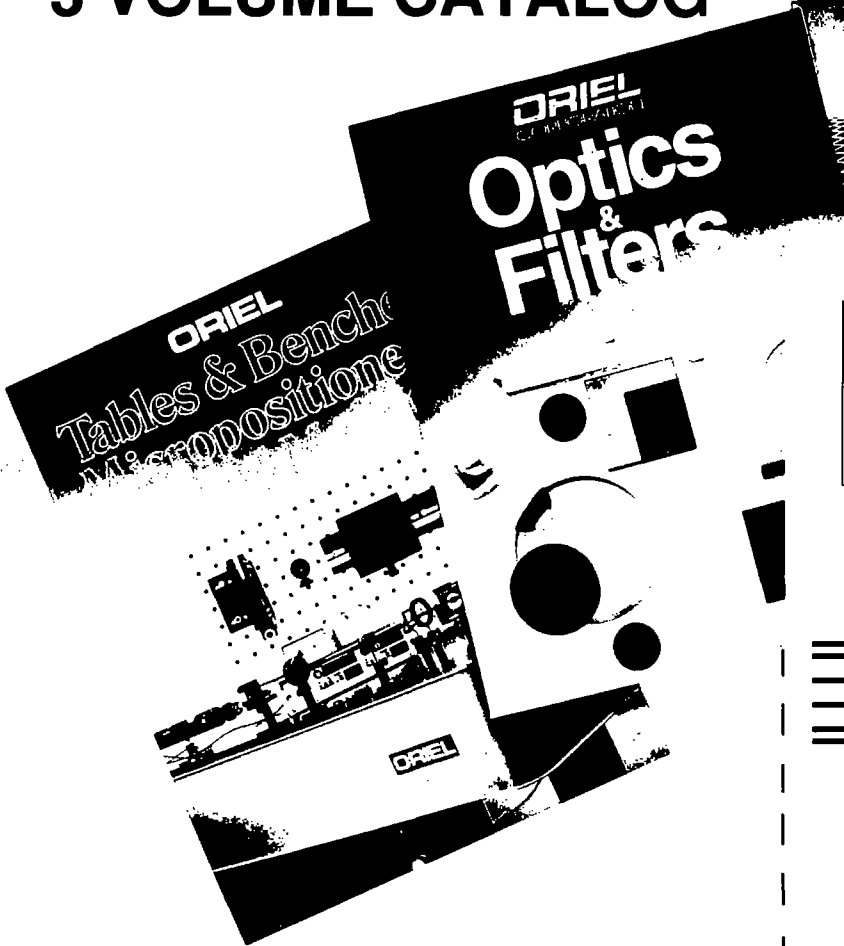

## DON'T BE WITHOUT IT!

The three volume set of catalogs contain over 800 pages of products and technical reference material for the electro optical research industry. In order to ensure that you continue to receive our most recent set as well as the latest updates on new products, please fill out and mail us the enclosed postage paid reply card.

### VOL I

This 250 page volume is the reference source for your hardware needs. Optical tables, benches, mounts, and precision positioning equipment are described in full detail.

### VOL II

This catalog contains over 400 pages of technical data, applications, and descriptions on light sources including HeNe and Diode lasers, monochromators and spectrographs, detection systems, computer controlled data acquisition systems, fiber optics, and other research products.

### VOL III

This volume is dedicated to optical components. It contains a comprehensive line of lenses, filters, mirrors, windows, beam splitters, prisms, polarizers, retardation plates, and coatings.

**Don't Delay...**  
**Fill out reply card & mail today!**

NO POSTAGE  
NECESSARY  
IF MAILED  
IN THE  
UNITED STATES



**BUSINESS REPLY MAIL**

FIRST CLASS PERMIT NO. 26 STRATFORD, CT

POSTAGE WILL BE PAID BY ADDRESSEE

ORIEL CORPORATION  
P.O. Box 872  
Stratford, CT 06497-9988

MA

**YES — I do need  
the NEW Oriel Catalogs!  
Please fill my  
request now!**

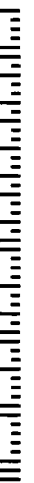

**Please send me the following:**

- 109  **Oriel 3 Volume Catalog Set**
- Vol I** Tables, Benches, Optical Mounts, Micropositioners
- Vol II** Light Sources, Monochromators, Detectors, Spectroscopic Systems
- Vol III** Optical Filters and Components
- 110  Exposure Equipment for Photolithography
- 113  Solar Simulator Catalog

**I work in these areas:**

- 20  Astronomy
- 23  Holography
- 26  Optical communications
- 29  Integrated optics
- 32  Laser system development
- 51  Optical Metrology
- 52  Laser Machining
- 35  Spectroscopy
- 38  Photobiology
- 41  Photochemistry
- 44  Solar simulation
- 47  Microscopy

- 50  Machine vision/robotics
- 53  Development or manufacture of semiconductor, thin/thick film circuitry microwave devices
- 56  UV curing
- 59  Graphic Arts
- 60  Other: \_\_\_\_\_

**I work at these wavelengths:**

- 86  100-190 nm
- 89  190-320 nm
- 92  320-400 nm
- 95  400-700 nm
- 98  0.7-1.2  $\mu$
- 101  1.2-3  $\mu$
- 104  3-15  $\mu$
- 107  over 15  $\mu$

**I use or may use:**

- 54  Fiber Sensors
- 59  Optical tables/benches
- 61  Optical mounts
- 62  Micropositioners
- 68  Precision motorized drives
- 71  Lasers
- 74  Arc lamp sources
- 77  Monochromators/Spectroscopy
- 78  Detectors
- 80  Fiber optics—bundles
- 83  Fiber optics—single fibers
- 84  Filters, lenses, mirrors

**My application is:**     IMMEDIATE     WITHIN 90 DAYS     FUTURE

NAME \_\_\_\_\_ TITLE \_\_\_\_\_

ORGANIZATION \_\_\_\_\_ MAIL DROP \_\_\_\_\_

ADDRESS \_\_\_\_\_

CITY/STATE/ZIP \_\_\_\_\_ TEL [    ] \_\_\_\_\_ FAX [    ] \_\_\_\_\_

**Please fill out in full. Thanks!**