

Silicon Graphics® Zx10 6U  
Rackmount/Deskside Owner's Guide

Document Number 007-4329-002

---

## Contributors

Written by Bryan Cobb, with engineering contributions by James Bullington, Jamey Dobbins, Johnnie Erskine, Ron Headley, Jimmy Mason, Ronnie Sams, and Mike Weesner.

---

## Copyright

© 2000 Silicon Graphics, Inc. All rights reserved; provided portions may be copyright in third parties, as indicated elsewhere herein. No permission is granted to copy, distribute, or create derivative works from the contents of this electronic documentation in any manner, in whole or in part, without the prior written permission of Silicon Graphics, Inc.

---

## Limited Rights Legend

The electronic (software) version of this document was developed at private expense; if acquired under an agreement with the USA government or any contractor thereto, it is acquired as "commercial computer software" subject to the provisions of its applicable license agreement, as specified in (a) 48 CFR 12.212 of the FAR; or, if acquired for Department of Defense units, (b) 48 CFR 227-7202 of the DoD FAR Supplement; or sections succeeding thereto. Contractor/manufacturer is Silicon Graphics, Inc., 1600 Amphitheatre Pkwy 2E, Mountain View, CA 94043-1351.

---

## Notice

Information in this document is subject to change without notice and should not be considered a commitment by Silicon Graphics, Inc. Silicon Graphics, Inc. shall not be liable for technical or editorial errors in, or omissions from, this document. Silicon Graphics, Inc. shall not be liable for incidental or consequential damages resulting from the furnishing or use of this document.

---

## Trademarks

Silicon Graphics is a registered trademark, and SGI and the SGI logo are trademarks, of Silicon Graphics, Inc. Intel and Pentium are registered trademarks of Intel Corporation. ServerSet is a trademark of ServerWorks Corporation. Microsoft, Windows, and Windows NT are registered trademarks of Microsoft Corporation. Other brands and product names are trademarks of their respective owners.

---

## FCC/DOC Compliance

This equipment has been tested and found to comply with the limits for a Class A digital device, pursuant to part 15 of the FCC Rules. These limits are designed to provide reasonable protection against harmful interference when the equipment is operated in a residential installation. This equipment generates, uses, and can radiate radio frequency energy. If the equipment is not installed and used in accordance with the instructions, it may cause harmful interference to radio communications. Operation of this equipment in a residential area is likely to cause harmful interference, in which case the user will be required to correct the interference at his own expense.

For additional regulatory information, see the label attached to the back of the equipment.

This Class A digital apparatus meets all requirements of the Canadian Interference-Causing Equipment Regulations. Cet appareil numérique de la classe A respecte toutes les exigences du Règlement sur le matériel brouilleur du Canada.

---

## Safety Notices

This is a user-serviceable system. However, there are no user-serviceable parts in the power supply. Please return the power supply to the manufacturer for repair.

Service and upgrade tasks should be performed by users who can follow instructions in a manual to service equipment, and can do so without harm to themselves or damage to the equipment.

The AC power cord for this unit is the service disconnect. Ensure the AC power outlet to which the system's power cord connects is close to the system and is easily accessible. For protection against electrical shock and energy hazards, unplug the system's power cord from its AC power outlet before opening or servicing the system.

If the AC voltage selection switch on the power supply is not set correctly, serious equipment damage may occur when power to the system is turned on.

To reduce the risk of electrical shock and energy hazards, do not attempt to open the equipment unless instructed, and do not use a tool for purposes other than instructed.

Internal components may be at high temperatures. Allow time for them to cool before handling them.

Internal components can be damaged by static electricity. Use an antistatic wrist strap connected to the bare metal of the system's chassis to protect against electrostatic discharge.

If a modem card used in the system receives ground from the system, ensure the system is connected to an earth-grounded AC power outlet.

---

#### Notes

Changes or modifications made to the system that are not approved by the party responsible for compliance could void the user's authority to operate the equipment.

Procedures in this document assume familiarity with the general terminology associated with personal computers, and with the safety practices and regulatory compliance required for using and modifying electronic equipment.

Read all operating instructions before using this device. Keep these instructions for future reference. Follow all warnings on the device or in the operating instructions.

To comply with the limits for an FCC Class B computing device, always use shielded cables and the power cord supplied with the system.



---

## Record of Revision

<b>Version</b>	<b>Description</b>
002	September 2000 Initial Rev





Finishing Software Setup . . . . .	29
Installing the Network Controller Driver . . . . .	29
Creating an Emergency Repair Disk. . . . .	30
Installing Driver Software . . . . .	30
Installing QFE Software . . . . .	30
What's Next? . . . . .	31
<b>3. Configuring the System . . . . .</b>	<b>33</b>
Configuring the Video Display . . . . .	33
Resetting the Video Display Resolution. . . . .	33
Changing the Default Video Display Driver . . . . .	34
Correcting Initial Video Display Problems . . . . .	34
Configuring System Audio . . . . .	35
Configuring Networking . . . . .	35
Configuring Peripheral Devices . . . . .	36
Configuring RAID Disk Drives . . . . .	36
Changing Drive Letters . . . . .	38
Changing Virtual Memory Settings . . . . .	39
Configuring the SCSI Controller . . . . .	39
Creating or Updating an Emergency Repair Disk . . . . .	40
Configuring the BIOS . . . . .	40
What's Next? . . . . .	41
<b>4. Operating the System . . . . .</b>	<b>43</b>
Controlling System Power. . . . .	43
Reading System LEDs . . . . .	45
Using Automatic Shutdown . . . . .	45
Starting and Stopping the Operating System . . . . .	46
Observing Operating Precautions . . . . .	47
Using the Keyboard . . . . .	48
Using the Mouse . . . . .	50
Using the Floppy Disk Drive . . . . .	51
Using the CD-ROM Drive . . . . .	52
Reading Removable Disk Drive LEDs . . . . .	53



	Responding to a Power Supply Alarm . . . . .	55
	Using System Management Software . . . . .	56
	Learning About the Operating System . . . . .	57
	Using Hardware Security Features . . . . .	57
	Cleaning System Components . . . . .	58
<b>5.</b>	<b>Troubleshooting Operational Problems . . . . .</b>	<b>59</b>
	Getting Started . . . . .	59
	System Power . . . . .	60
	System Boot . . . . .	61
	Video . . . . .	64
	Audio . . . . .	64
	Network . . . . .	65
	Peripheral Drive Errors . . . . .	65
	Miscellaneous Hardware . . . . .	66
<b>6.</b>	<b>Reinstalling the Operating System. . . . .</b>	<b>69</b>
	Before You Begin . . . . .	69
	Finding Driver Software . . . . .	69
	Installing the Operating System . . . . .	70
	Updating the Operating System . . . . .	71
<b>7.</b>	<b>Gaining Access to System Components . . . . .</b>	<b>73</b>
	Before You Begin . . . . .	73
	Avoiding Electrostatic Discharge . . . . .	74
	Access Points . . . . .	74
	Removing and Replacing the Top Cover . . . . .	76
	Removing and Replacing the Front Panel . . . . .	77
	Internal System Components. . . . .	78
<b>8.</b>	<b>Upgrading the System . . . . .</b>	<b>81</b>
	Before You Begin . . . . .	81

Adding Expansion Cards . . . . .	. 82
Identifying Expansion Card Slots . . . . .	. 83
Installing an Expansion Card. . . . .	. 84
Assigning System Resources . . . . .	. 85
Disabling On-Board Controllers . . . . .	. 85
Adding External SCSI Peripheral Devices . . . . .	. 85
Choosing SCSI Cables. . . . .	. 86
Choosing SCSI IDs. . . . .	. 87
Terminating SCSI Devices . . . . .	. 87
Connecting SCSI Devices . . . . .	. 87
Changing SCSI Controller or Device Settings . . . . .	. 88
Adding Internal Peripheral Devices . . . . .	. 89
Adding Memory . . . . .	. 90
Upgrading Processors . . . . .	. 91
<b>9. Servicing the System . . . . .</b>	<b>. 93</b>
Before You Begin . . . . .	. 93
Removable Disk Drive. . . . .	. 94
JBOD Disk Drive Device Cage . . . . .	. 95
Peripheral Device Cage . . . . .	. 98
Expansion Card. . . . .	102
Memory Module . . . . .	104
Processor Bus Terminator . . . . .	105
Processor Module . . . . .	106
RAID Disk Drive Cage. . . . .	106
RAID SAF-TE Card. . . . .	109
Power Supply . . . . .	111
Cooling Fans . . . . .	114
System Board . . . . .	117
CMOS/Clock Lithium Battery . . . . .	119
Intrusion Alert Switch . . . . .	119
Power Keyswitch and LEDs . . . . .	121

<b>10.</b>	<b>System Hardware and Specifications</b>	. . . . .	.125
	Functional Diagram	. . . . .	.125
	Internal Peripheral Cabling	. . . . .	.126
	EIDE Cabling	. . . . .	.127
	SCSI Cabling for RAID Systems.	. . . . .	.128
	SCSI Cabling for JBOD Systems.	. . . . .	.129
	Floppy Disk Drive Cable.	. . . . .	.130
	EIDE Peripheral Device Cage Cable	. . . . .	.130
	RAID SCSI External Port Cable	. . . . .	.131
	RAID SCSI Peripheral Device Cage Cable	. . . . .	.131
	RAID SCSI Disk Drive Cage Cable	. . . . .	.132
	JBOD SCSI Peripheral Device Cage/External Port Cable	. . . . .	.132
	JBOD SCSI Disk Drive Cage Cable	. . . . .	.133
	Power Supply and Cables	. . . . .	.133
	Cooling Fans	. . . . .	.135
	Hardware Monitoring and Power Management	. . . . .	.135
	System Configuration Summary.	. . . . .	.136
	System Specifications	. . . . .	.137
<b>A.</b>	<b>Ergonomics Guide</b>	. . . . .	.139
	Setting Your Work Habits	. . . . .	.139
	Getting Started	. . . . .	.139
	Arms	. . . . .	.139
	Wrists	. . . . .	.140
	Head and Eyes	. . . . .	.140
	Back	. . . . .	.140
	Legs.	. . . . .	.141
	Setting Your Environment	. . . . .	.141
	Reducing the Risk of Injury	. . . . .	.142
	Changing Posture.	. . . . .	.142
	Taking Rest Breaks	. . . . .	.142
	Taking Care of Your Body	. . . . .	.143
	Getting Help	. . . . .	.143



---

# Figures

<b>Figure 1-1</b>	Deskside and Rackmount Systems . . . . .	1
<b>Figure 1-2</b>	Tinnerman Nut Installation . . . . .	5
<b>Figure 1-3</b>	Handle Bracket . . . . .	6
<b>Figure 1-4</b>	Rail Guide . . . . .	7
<b>Figure 1-5</b>	Bracket on Rail . . . . .	8
<b>Figure 1-6</b>	Rail Secured to Front Mounting Rail on Equipment Rack . . . . .	9
<b>Figure 1-7</b>	Installing the Tinnerman Nuts . . . . .	9
<b>Figure 1-8</b>	Rail Secured to Rear Mounting Rail on Equipment Rack . . . . .	10
<b>Figure 1-9</b>	Rail on Rail Guide . . . . .	11
<b>Figure 1-10</b>	The Back of the Base Unit . . . . .	13
<b>Figure 1-11</b>	The I/O Panel . . . . .	14
<b>Figure 1-12</b>	Expansion Slots . . . . .	15
<b>Figure 1-13</b>	Removable RAID Disk Drive Cage, Door Closed . . . . .	17
<b>Figure 1-14</b>	Interior of Disk Drive Cage . . . . .	17
<b>Figure 1-15</b>	SCSI Disk Drive Labels . . . . .	18
<b>Figure 1-16</b>	SCSI Port . . . . .	19
<b>Figure 1-17</b>	Power Supplies . . . . .	21
<b>Figure 1-18</b>	System Power Keyswitch . . . . .	23
<b>Figure 2-1</b>	System Power Keyswitch . . . . .	28
<b>Figure 3-1</b>	Disk Drive Label . . . . .	37
<b>Figure 4-1</b>	System Power Keyswitch . . . . .	44
<b>Figure 4-2</b>	The Keyboard . . . . .	48
<b>Figure 4-3</b>	The Mouse . . . . .	50
<b>Figure 4-4</b>	The Floppy Disk Drive. . . . .	51
<b>Figure 4-5</b>	The CD-ROM Drive . . . . .	52
<b>Figure 4-6</b>	Removable Disk Drive LEDs (Behind Door) . . . . .	53
<b>Figure 4-7</b>	The Power Supply . . . . .	56

<b>Figure 7-1</b>	Front Panel Access Points . . . . .	. 75
<b>Figure 7-2</b>	Rear Panel Access Points . . . . .	. 75
<b>Figure 7-3</b>	Internal System Components . . . . .	. 79
<b>Figure 8-1</b>	Expansion Card Slots . . . . .	. 83
<b>Figure 8-2</b>	Expansion Slot Locations . . . . .	. 84
<b>Figure 9-1</b>	Interior of the Disk Drive Cage . . . . .	. 94
<b>Figure 9-2</b>	JBOD Disk Drive Cage Installed . . . . .	. 96
<b>Figure 9-3</b>	JBOD Disk Drive Cage . . . . .	. 97
<b>Figure 9-4</b>	Peripheral Device Cage Installed . . . . .	. 98
<b>Figure 9-5</b>	Removing or Replacing Peripheral Device Cage . . . . .	. 99
<b>Figure 9-6</b>	Device Tray . . . . .	100
<b>Figure 9-7</b>	Mounting Brackets . . . . .	102
<b>Figure 9-8</b>	Expansion Cards . . . . .	103
<b>Figure 9-9</b>	Dual Inline Memory Module (DIMM) . . . . .	104
<b>Figure 9-10</b>	Interior of RAID Disk Drive Cage. . . . .	107
<b>Figure 9-11</b>	Removing or Replacing the RAID Disk Drive Cage. . . . .	108
<b>Figure 9-12</b>	The SAF-TE Card . . . . .	110
<b>Figure 9-13</b>	Mounting Clips for SAF-TE Card . . . . .	110
<b>Figure 9-14</b>	The Power Supply . . . . .	112
<b>Figure 9-15</b>	Removing or Replacing the Power Supply . . . . .	113
<b>Figure 9-16</b>	The Cooling Fans . . . . .	115
<b>Figure 9-17</b>	Processor Area Cooling Fan . . . . .	116
<b>Figure 9-18</b>	The System Board . . . . .	117
<b>Figure 9-19</b>	CMOS/CLock Lithium Batter . . . . .	119
<b>Figure 9-20</b>	Front Intrusion Alert Switch . . . . .	120
<b>Figure 9-21</b>	Top Intrusion Alert Switch. . . . .	120
<b>Figure 9-22</b>	Removing the Keyswitch . . . . .	122
<b>Figure 9-23</b>	Pushing Out the LEDs . . . . .	123
<b>Figure 10-1</b>	Functional Diagram. . . . .	126
<b>Figure 10-2</b>	EIDE Cabling . . . . .	127
<b>Figure 10-3</b>	SCSI Cabling for RAID Systems . . . . .	128
<b>Figure 10-4</b>	SCSI Cabling for JBOD Systems . . . . .	129
<b>Figure 10-5</b>	Floppy Disk Drive Cable . . . . .	130

<b>Figure 10-6</b>	EIDE Peripheral Device Cage Cable . . . . .	.130
<b>Figure 10-7</b>	RAID SCSI External Port Cable . . . . .	.131
<b>Figure 10-8</b>	RAID SCSI Peripheral Device Cage Cable . . . . .	.131
<b>Figure 10-9</b>	RAID SCSI Disk Drive Cage Cable . . . . .	.132
<b>Figure 10-10</b>	JBOD SCSI Peripheral Device Cage/External Port Cable . . . . .	.132
<b>Figure 10-11</b>	JBOD SCSI Disk Drive Cage Cable . . . . .	.133





---

# Tables

<b>Table 1-1</b>	Expansion Slots and Cards . . . . .	16
<b>Table 3-1</b>	RAID Disk Drives . . . . .	37
<b>Table 4-1</b>	The Power Button . . . . .	44
<b>Table 4-2</b>	Reading the Power LED . . . . .	45
<b>Table 4-3</b>	Reading the Disk LED . . . . .	45
<b>Table 4-4</b>	Special Keyboard Functions . . . . .	49
<b>Table 4-5</b>	Key Combinations . . . . .	49
<b>Table 4-6</b>	Mouse Actions . . . . .	50
<b>Table 4-7</b>	Reading Removable Disk Drive LED . . . . .	55
<b>Table 4-8</b>	Cleaning System Components . . . . .	58
<b>Table 5-1</b>	Fails to power on . . . . .	60
<b>Table 5-2</b>	Does not boot from the expected boot device . . . . .	61
<b>Table 5-3</b>	Series of beeps and error messages display . . . . .	61
<b>Table 5-4</b>	Does not boot from drive A (floppy disk drive) or other expected boot device . . . . .	62
<b>Table 5-5</b>	Floppy disk drive is not recognized . . . . .	62
<b>Table 5-6</b>	System hard disk drive is not recognized . . . . .	63
<b>Table 5-7</b>	CD-ROM drive is not recognized. . . . .	63
<b>Table 5-8</b>	Total amount of memory does not display . . . . .	63
<b>Table 5-9</b>	I/O Card parity error message displays. . . . .	63
<b>Table 5-10</b>	System is powered on, but screen remains blank . . . . .	64
<b>Table 5-11</b>	No sound can be heard . . . . .	64
<b>Table 5-12</b>	Cannot connect to other systems on LAN . . . . .	65
<b>Table 5-13</b>	Cannot plot to network printer or plotter on LAN. . . . .	65
<b>Table 5-14</b>	CD-ROM drive LED does not light when system power is on . . . . .	65
<b>Table 5-15</b>	Floppy disk drive LED does not light when system power is on . . . . .	66
<b>Table 5-16</b>	“Battery voltage low” message displays. . . . .	66

<b>Table 5-17</b>	System loses BIOS configuration information . . . . .	66
<b>Table 5-18</b>	DMA bus timeout message displays . . . . .	66
<b>Table 5-19</b>	“Invalid configuration information for SLOT XX” message displays .	67
<b>Table 8-1</b>	Maximum SCSI bus length. . . . .	86
<b>Table 8-2</b>	Peripheral Device Bays . . . . .	89
<b>Table 10-1</b>	Floppy Disk Drive Cable . . . . .	130
<b>Table 10-2</b>	EIDE Peripheral Device Cage Cables . . . . .	130
<b>Table 10-3</b>	RAID SCSI External Port Cable . . . . .	131
<b>Table 10-4</b>	RAID SCSI Peripheral Device Cage Cable . . . . .	131
<b>Table 10-5</b>	RAID SCSI Disk Drive Cage Cable . . . . .	132
<b>Table 10-6</b>	JBOD SCSI Peripheral Device Cage/External Port Cable . . . . .	132
<b>Table 10-7</b>	JBOD SCSI Disk Drive Cage Cable . . . . .	133
<b>Table 10-8</b>	Power Supply DC Output Specifications. . . . .	133
<b>Table 10-9</b>	P1 Connector Pinout . . . . .	134
<b>Table 10-10</b>	P11 Connector Pinout . . . . .	134
<b>Table 10-11</b>	P12 through P15 Connector Pinout . . . . .	134
<b>Table 10-12</b>	System Configuration Summary . . . . .	136
<b>Table 10-13</b>	System Specifications . . . . .	137

---

## About This Guide

This *Owner's Guide* describes how to set up and configure your SGI Zx10 6U rackmount/deskside system. The *Owner's Guide* also provides information on operating, servicing, and upgrading your Zx10 6U system.

The *Owner's Guide* is organized as follows:

- Chapter 1, “Setting Up the Hardware” describes how to set up the system’s hardware.
- Chapter 2, “Setting Up the Software” describes how to set up the operating system and associated system software.
- Chapter 3, “Configuring the System” describes how to configure the system for use.
- Chapter 4, “Operating the System” describes how to use essential features and provides other basic information on operating the system.
- Chapter 5, “Troubleshooting Operational Problems” describes how to resolve basic problems you may encounter when using the system.
- Chapter 6, “Reinstalling the Operating System” describes how to reinstall the operating system and associated system software, if required.
- Chapter 7, “Gaining Access to System Components” describes how to open the system and gain access to major internal components.
- Chapter 8, “Upgrading the System” provides information on adding and upgrading major system components.
- Chapter 9, “Servicing the System” describes how to remove and replace major components.
- Chapter 10, “System Hardware and Specifications” provides technical reference information and system specifications.
- Appendix A, “Ergonomics Guide” contains valuable information on ways to minimize repetitive stress injuries when working with a computer.

## More Information

For additions or changes to information in this document, see the *Release Notes* (if delivered with the system).

For more detailed information on the operating system, see the printed and online Microsoft documentation delivered with the system.

For detailed information on the system board, system board components, and basic input/output system (BIOS), see the *System Board Guide* delivered with the workstation.

## Getting Support

When you need software support or hardware maintenance:

- Visit Supportfolio Online on the World Wide Web at <http://support.sgi.com>.
- Visit SGI Global Services on the World Wide Web at <http://www.sgi.com/support>.
- Contact an SGI Customer Support Center (listed on the SGI Global Services Web pages).

For more information, see the *Support Guide* delivered with your system.

## Getting Documents

To obtain SGI documents, go to the SGI Technical Publications Library pages on the World Wide Web at <http://techpubs.sgi.com>.

## Reader Comments

If you have comments about the technical accuracy, content, or organization of this document, please tell us. Be sure to include the title and document number of the manual with your comments. (Online, the document number is located in the front matter of the manual. In printed manuals, the document number can be found on the back cover.)

You can contact us in any of the following ways:

- Send e-mail to **techpubs@sgi.com**.
- Use the Feedback option on the Technical Publications Library pages on the World Wide Web at **<http://techpubs.sgi.com>**.
- Contact your customer service representative and ask that an incident be filed in the SGI incident tracking system.
- Send mail to the following address:  
Technical Publications  
SGI  
1600 Amphitheatre Parkway, M/S 535  
Mountain View, California 94043-1351
- Send a fax to the attention of “Technical Publications” at +1 650 932 0801.

We value your comments and will respond to them promptly.



## Setting Up the Hardware

This chapter describes how to set up the hardware for your system.

### Deskside and Rackmount Systems

Your system was delivered with a deskside base unit or a rackmount base unit, as shown in the following figure.

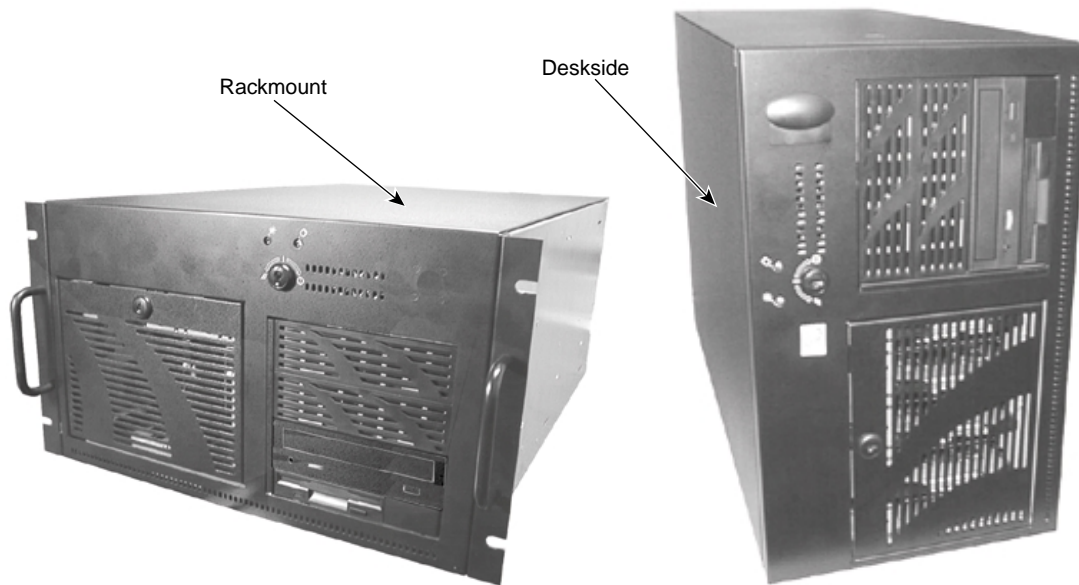

**Figure 1-1** Deskside and Rackmount Systems

The deskside base unit is designed for office environments. The base unit can sit beside a desk or on another sturdy surface close to the user. Access to the inside of the base unit is through the left side panel (as seen from the front of the system).

The rackmount base unit is designed for back-office environments such as server farms or equipment rooms. The base unit mounts in a standard 19-inch equipment rack in use at your site. Access to the inside of the base unit is through the top cover.

## Unpacking the System

---

**Warning:** The base unit is heavy! To avoid personal injury or damage to equipment, use two persons to move the base unit.

---

---

**Caution:** Remove and move items carefully. Do not drop items on a hard surface, or damage to internal components may result. You may need help to move heavy items.

---

Remove everything from the shipping cartons and verify you have (at a minimum) these items:

- System base unit and power cord
- Rack-mounting hardware (rackmount system only)
- Keyboard and mouse
- Operating system software CD, diskettes, and documentation
- Driver software CD
- Monitor, power cord, and video cable (if purchased)
- System documentation, including an *Owner's Guide*, a *System Board Guide*, and *Release Notes* (if provided)

Save the packaging materials. If you need to return equipment for repair, it must be in its original packaging for you to get warranty service.

## Placing System Components

When placing system components, keep these guidelines in mind:



- A deskside system should be placed on the floor or on a surface capable of supporting the full weight of the system.
- A rackmount system should be mounted in a 19-inch equipment rack in use at your site.
- Place the system in an area where air can circulate freely around it.
- Do not expose the system to high levels of dust, smoke, or moisture.
- Maintain a temperature range of 50 °F to 90 °F (10 °C to 32 °C); the optimum operating temperature is 70 °F (21 °C).
- Maintain a humidity range of 20 percent to 80 percent non-condensing; the optimum humidity is 50 percent non-condensing.

## Installing Rails for Rack Mounting

Your system was shipped with the base unit's top and side panels in place. If you purchased the optional rack mounting kit, you must remove the one-piece top-and-right-side panel (as seen from the front of the deskside base unit) before you can install rack-mount rails. To remove this panel, remove the screws that secure it to the back of the chassis, and then pull the panel back and away from the chassis.

## Before Mounting a Rackmount System

Before mounting a system in an equipment rack in use at your site, prevent the rack from moving by engaging its stabilizers. If the rack is not equipped with stabilizers, refer to the rack documentation for stabilizing instructions.

Observe the following safety precautions when mounting the base unit in a rack in use at your site or when using the rackmount system:

- Extend only one slide rail set at a time. Push an extended slide rail set back into the rack before extending another.

---

**Warning:** Extending more than one slide rail set could cause the rack to fall forward, causing damage to equipment and injury to anyone in front of the rack.

---

- Do not push on or lean against the rack. Always engage the stabilizers. The adjustable feet should be lowered securely against the floor.
- If the rack contains an AC distribution box or an uninterruptible power supply (UPS), do not connect its the power cord to the wall outlet until instructed to do.
- Set up the system completely before you start it.

---

**Warning:** Do not move the rack with equipment mounted or powered on, or damage to internal components may occur. Shut down the system, unplug the system power cords from their AC power outlets, remove all equipment, and then move the rack.

---

## Understanding Rackmount Vertical Units

A vertical unit (U) is an industry-standard measurement for rackmount equipment. Small markers on the rack mounting rails usually indicate each vertical unit. For more information, see the documentation for the racks in use at your site.

You should determine the vertical mounting space within a rack enclosure taken up by each device you want to install. For example, an AC distribution box may require 1U or 2U of mounting space, while the system's base unit requires 5U of mounting space.

Note the following about vertical units:

- A vertical unit (U) equals 1.75 in (4.45 cm) and consists of three mounting holes.
- The mounting hole diameter is 7.1 mm (industry standard).
- Mounting holes are counted upward after locating the first mounting hole within the range of vertical units required to install the equipment.

The following figure shows the typical installation of a tinnerman nut to mounting hole 3 of a vertical unit.

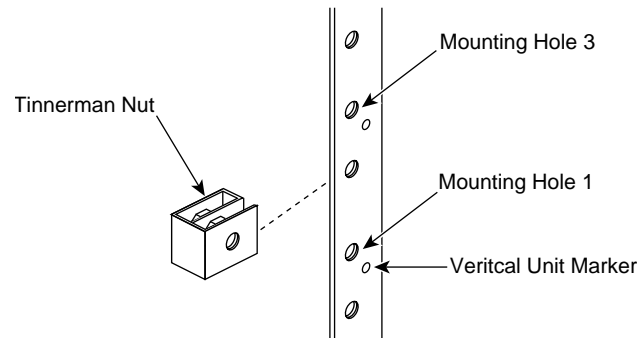

**Figure 1-2** Tinnerman Nut Installation

## Mounting the Base Unit in a Rack

The following procedure describes how to mount a rackmount system's base unit in a typical 19-inch equipment rack. For detailed information on mounting equipment in a rack, see the documentation for the equipment racks in use at your site.

---

**Warning:** The base unit is heavy! To avoid personal injury or damage to equipment, use two persons to mount the base unit in an equipment rack.

---

To mount the base unit in an equipment rack:

1. Remove the screws securing each side of the front panel to the base unit. Holding each handle bracket in place, replace the screws through each bracket and the front panel into the base unit.

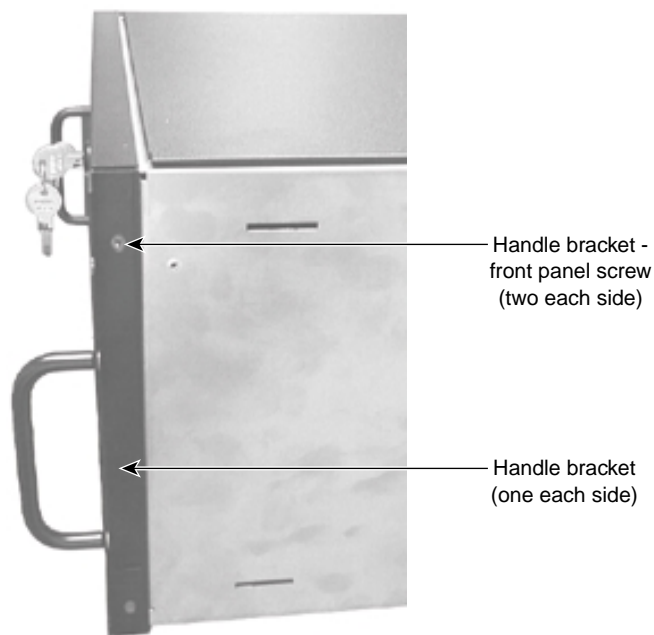

**Figure 1-3** Handle Bracket

2. Remove the guide from each of the two rails. The guide is the innermost-sliding piece of the rails, and has a flexible tab at one end.
3. Attach a guide to each side of the base unit using the flat-head screws provided, making sure the flexible tab on the guide is toward the back of the base unit. Align each guide with the lower set of three screw holes in each side of the base unit.

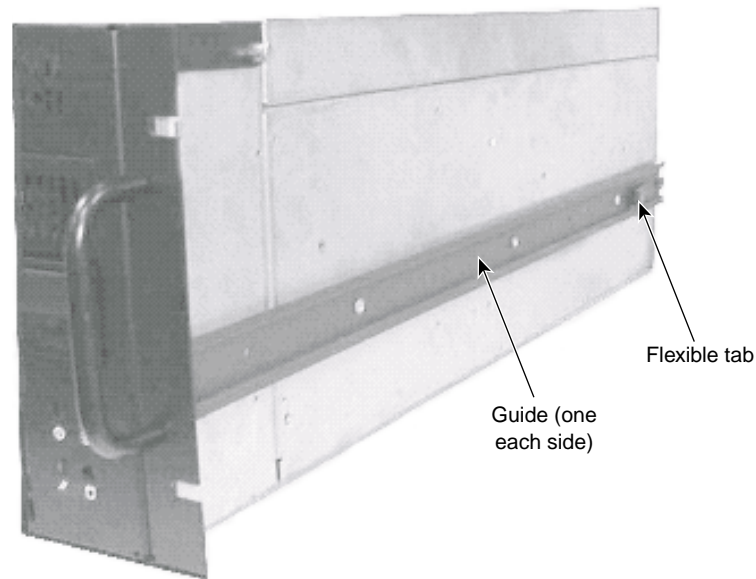

**Figure 1-4** Rail Guide

4. Use the button-head screws and bolts provided to loosely secure a bracket to each rail. The bracket has the teeth needed to secure the rail to the equipment rack. Install the button-head screws and bolts loosely so you can adjust the back teeth positions later.

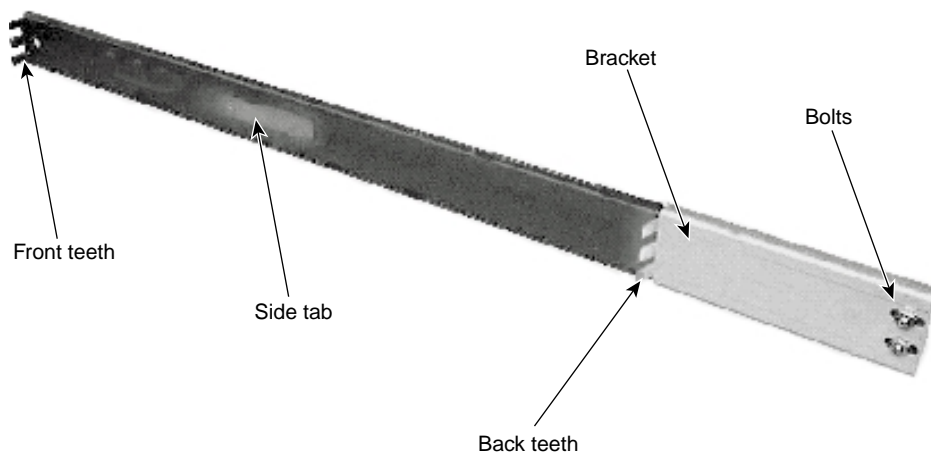

**Figure 1-5** Bracket on Rail

5. The rackmount base unit requires 6U (10.5 in or 26.7 cm) of mounting space. Choose the five vertical units you need and, on the equipment rack mounting rails, mark the fifth and sixth mounting holes from the bottom of this 6U space.
6. Use the flat-head screws and bar nuts to secure the front teeth on both rails to the front mounting rails of the equipment rack.

With the flat side of each bar nut facing the screws, loosely install two flat-head screws to each bar nut, through the fifth and sixth mounting holes from the bottom of the 6U space. Slide the front teeth over the screws and tighten. Ensure the front teeth are between the bar nuts and the mounting holes.

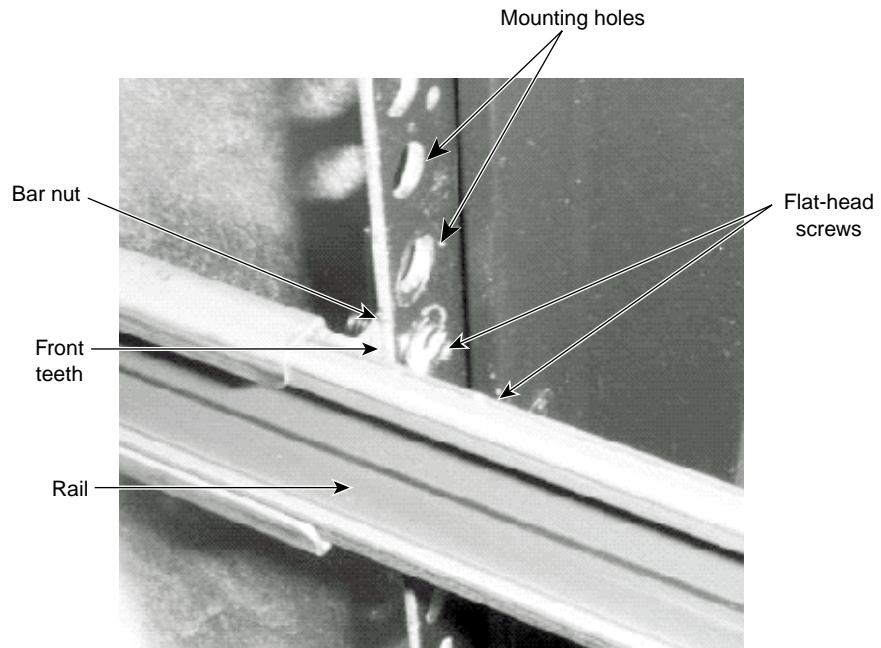

**Figure 1-6** Rail Secured to Front Mounting Rail on Equipment Rack

7. On the front mounting rails on the equipment rack, slide tinnerman nuts over the third and thirteenth mounting holes from the bottom of the 6U space. The tinnerman nuts will be used when you secure the handle brackets on the front of the base unit to the front mounting rails of the equipment rack.

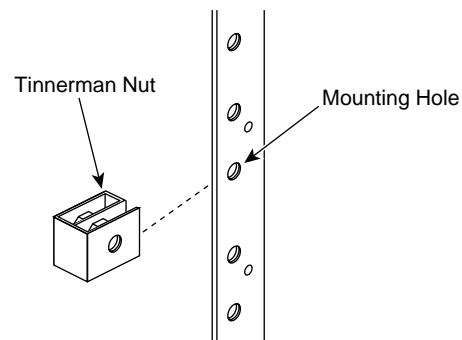

**Figure 1-7** Installing the Tinnerman Nuts

8. Use the button-head screws and bar nuts provided to secure the back rail teeth to the back mounting rails of the equipment rack.

With the flat side of each bar nut facing the screws, loosely install two button-head screws to the bar nut, through the fifth and sixth mounting holes from the bottom of the 6U space. Slide the back teeth over the screws and tighten. Ensure the back teeth are between the bar nuts and the mounting holes.

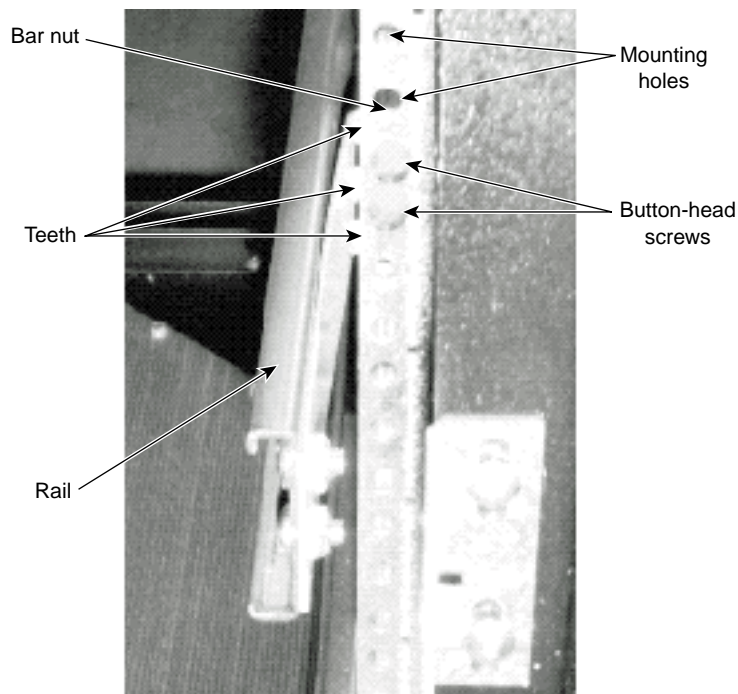
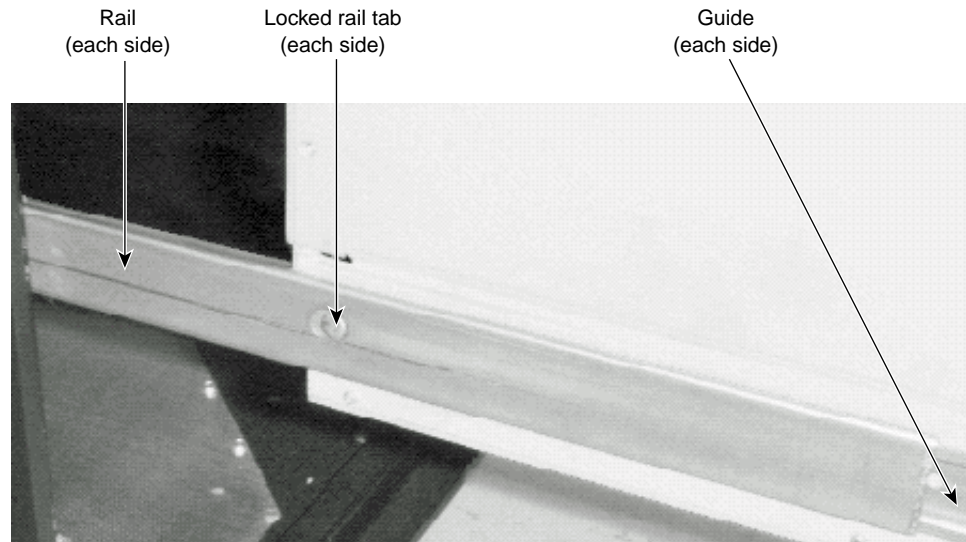

**Figure 1-8** Rail Secured to Rear Mounting Rail on Equipment Rack

9. At the back of the equipment rack, tighten the screws and bolts on the brackets of each rail.
10. Extend the rails from the equipment rack until they lock.
11. With a person on each side, lift the base unit and align the rails with the guides attached to the sides of the base unit. Slide the base unit into the rails until you hear a click.



12. Press the locked rail tabs and slide the base unit completely back into the equipment rack. After the base unit slides back a few inches, the base unit and rails slide together as a unit into the equipment rack. See Figure 1-9.



**Figure 1-9** Rail on Rail Guide

13. Install the black screws through the handle brackets and the tinnerman nuts you installed previously to secure the base unit to the front mounting rails of the equipment rack.

## Connecting System Components

---

**Caution:** If you do not use the cables delivered with the system, use shielded cables to prevent excessive electromagnetic interference (EMI). The cables delivered with the system reduce the amount of EMI produced by the system.

---

---

**Note:** You should disconnect the cables from the base unit before extending it from the rack, but if needed, you can extend the base unit without disconnecting the cables. Be sure there is enough cable to allow the base unit to fully extend from the rack. Use caution not to pinch the cables while extending or retracting the base unit.

---

After placing the system components, connect them together using the included cables. The base unit and other system components have keyed and labeled ports, to make it easier to connect them together with the right cables. If you cannot connect a cable easily, ensure that you are aligning the cable connector correctly with the port.

Figure 1-10 and Figure 1-11 illustrate the back of the base unit. Most ports on the back of the base unit are colored and labeled with icons for easy reference. Locations of expansion cards and their ports may differ from those shown.

---

**Note:** On a desktide system, the SCSI port is at the top and the expansion ports are at the bottom (as seen when facing the back of the base unit).

---

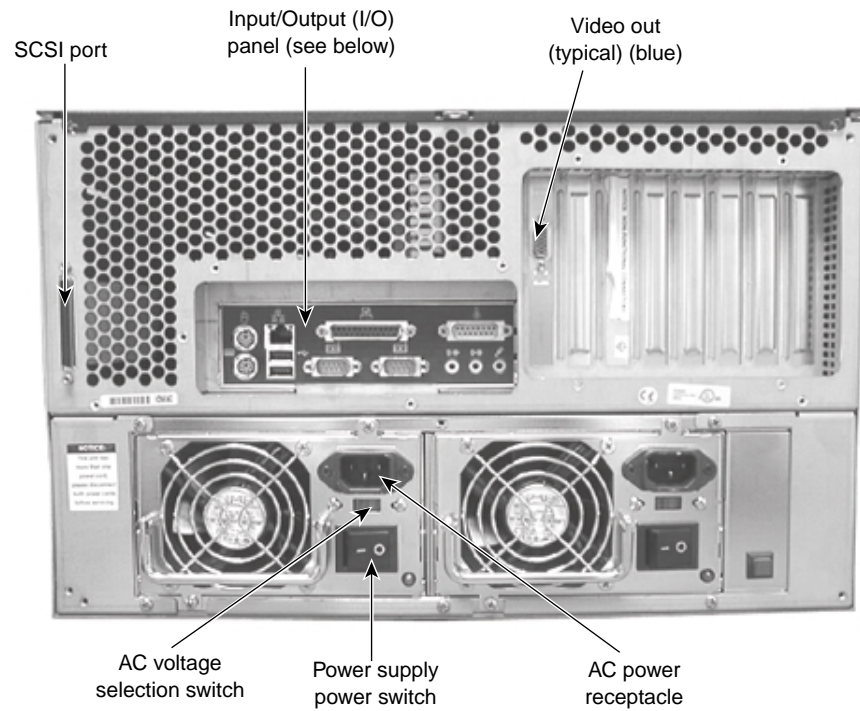

**Figure 1-10** The Back of the Base Unit

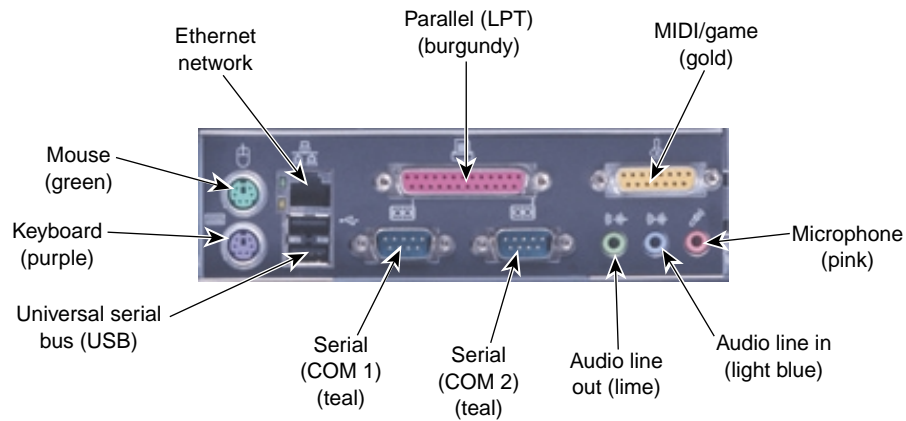

**Figure 1-11** The I/O Panel

To connect the system components:

1. Connect a video cable from the monitor to the video out port on the graphics controller card. See the graphics controller documentation for more information.
2. Connect cables from the keyboard and the mouse to their ports.
3. Connect a cable from your site's Ethernet network to the Ethernet port.
4. Connect a cable from a parallel peripheral device to the parallel port.
5. Connect cables from any serial peripheral devices to the serial ports.
6. Connect cables from any USB peripheral devices to the USB ports.
7. Connect the cable from any external SCSI peripheral devices, or a SCSI terminator module, to the SCSI port. See "Connecting External SCSI Devices" on page 18 in this chapter.

---

**Caution:** If you do not connect an external SCSI peripheral device to the SCSI port, connect a terminator module to the port.

---

8. Connect cables to ports on any other installed expansion cards as required. See the expansion card documentation for more information.
9. Install removable disk drives in the disk drive cage. See "Installing Removable RAID Disk Drives" on page 16 in this chapter for more information.

---

**Caution:** Do not connect the system power cord to the base unit or to an AC power outlet at this time. See “Connecting to AC Power” on page 20 later in this chapter for more information.

---

## Locating Expansion Cards

Expansion cards are installed as needed in the Accelerated Graphics Port (AGP), Peripheral Component Interconnect (PCI), and Industry Standard Architecture (ISA) expansion slots.

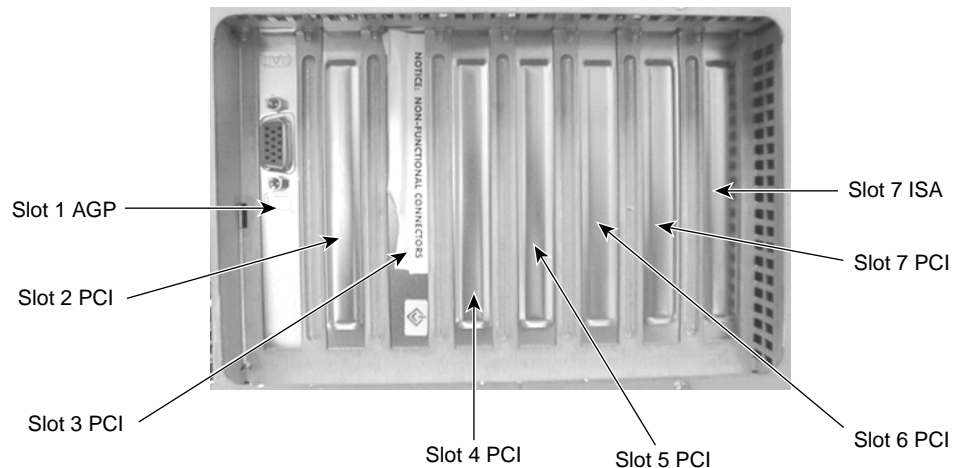

**Figure 1-12** Expansion Slots

---

**Caution:** The following table describes the expansion slots and any typically installed expansion cards. Note that Slot 7 is a shared PCI/ISA slot; you can install a PCI expansion card or an ISA expansion card in this slot, but not both.

---

**Table 1-1** Expansion Slots and Cards

Slot	Type	Typical Expansion Cards Installed
1 (Left or top)	AGP	Graphics controller
2	PCI (64-bit/33 MHz)	Varies by system
3	PCI (64-bit/33 MHz)	RAID controller
4	PCI (64-bit/33 MHz)	Varies by system
5	PCI (64-bit/66 MHz)	Varies by system
6	PCI (64-bit/66 MHz)	Varies by system
7	PCI (64-bit/33 MHz)	Varies by system
7 (Right or bottom)	ISA	Varies by system

---

**Caution:** If a modem card used in the system receives ground from the system, ensure the system is connected to an earth-grounded AC power outlet.

---

For information on installing or connecting to expansion cards, see Chapter 8, “Upgrading the System” and the expansion card documentation delivered with the system.

## Installing Removable RAID Disk Drives

In a RAID system, the base unit’s disk drive cage may contain up to four removable low-voltage differential (LVD) SCSI disk drives. An installed RAID controller card manages these disk drives and provides RAID capabilities to the system.

These SCSI disk drives can be accessed through a door on the front panel. On a rackmount system, the door is to the right (as seen when facing the front of the system). On a deskside system, the disk drive cage door is at the bottom (as seen when facing the front of the system). A key (delivered with the system) locks and unlocks the disk drive door.

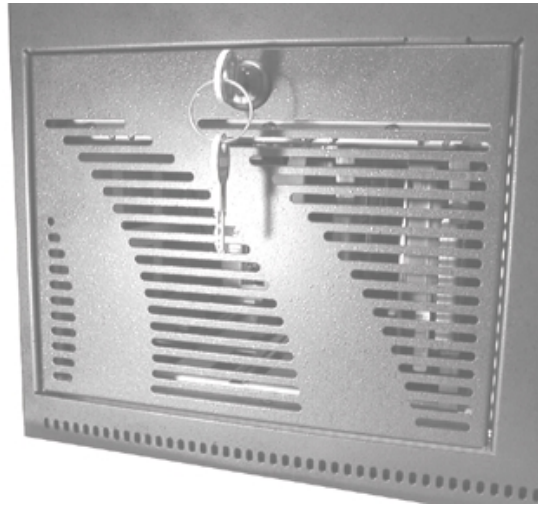

**Figure 1-13** Removable RAID Disk Drive Cage, Door Closed

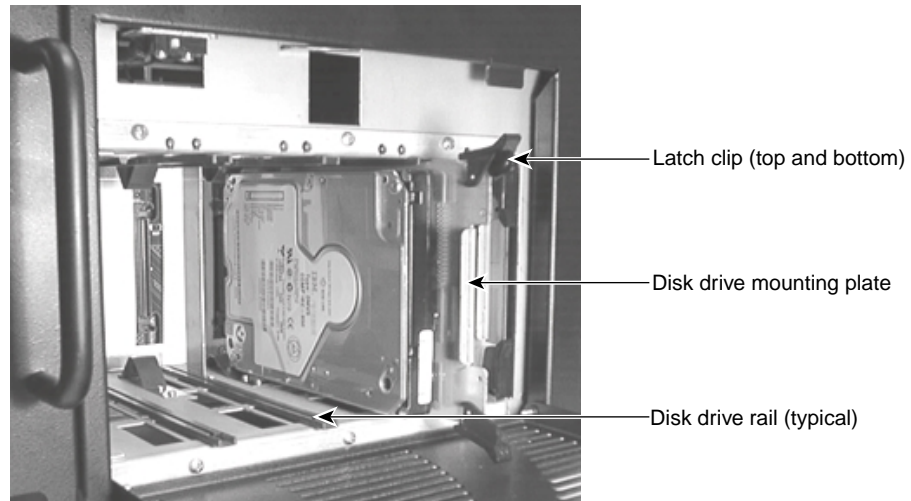

**Figure 1-14** Interior of Disk Drive Cage

Each SCSI disk drive installed in the disk drive cage has a label affixed to the front. The left side of the disk drive label identifies the disk drive size (in GB). The label has blank

spaces for the numbers to indicate the adapter (ADP), the channel (CH), and the identification number (ID). Standard disk drives include values for the adapter, channel, and identification number filled in. Additional disk drives have a blank label (supplied) that you must complete after installation.



**Figure 1-15** SCSI Disk Drive Labels

To install removable drives:

1. Open the disk drive cage door on the front of the base unit.
2. Carefully remove the disk drives from their carton and place them on an antistatic surface. Open the antistatic bags and remove the disk drives. Note the ID number on the disk drives.
3. Extend the latch clips on Drive 0 and align the upper and lower edges of the disk drive's mounting plate with the disk drive rails at the right end or top end of the disk drive cage. For a rackmount system, the mounting plate faces to the right; for a deskside system, the mounting plate faces up.
4. Push the disk drive at the center between the latch clips until it slides all the way onto the rails and firmly engages its connector. The latch clips rotate closed as you push the disk drive onto the rails.
5. Repeat steps 3 and 4 to install each remaining disk drive, moving to the left or down as you install each new disk drive. Do not leave empty rails between disk drives.

## Connecting External SCSI Devices

The system has a dual-channel low-voltage differential (LVD) SCSI controller integrated on the system board. You can connect external Ultra, Ultra2, or Ultra3 SCSI devices to this controller through the SCSI port on the back of the base unit.



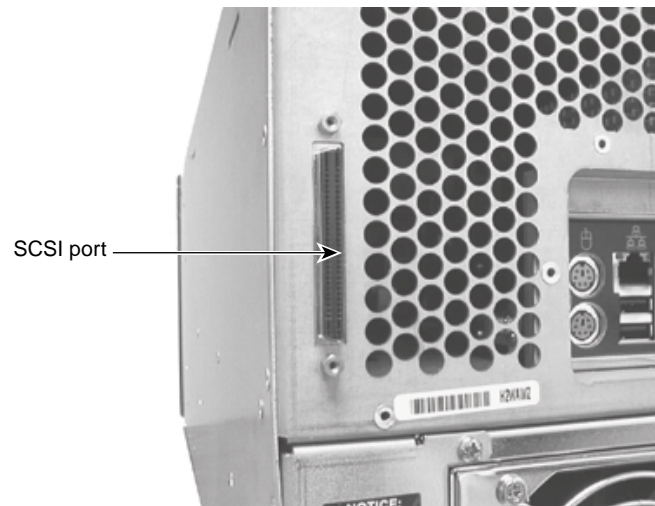

**Figure 1-16** SCSI Port

---

**Caution:** On a RAID system, do not connect external SCSI peripheral devices to the non-functional SCSI port on the RAID controller card.

---

---

**Caution:** On a JBOD system, if you do not connect an external SCSI peripheral device to the SCSI port, connect a terminator module to the port.

---

---

**Note:** On a deskside system, the SCSI port is at the top when facing the back of the base unit.

---

To ensure data integrity and promote optimum performance:

- Use the shortest cables possible to connect SCSI peripheral devices.
- Use high-quality SCSI cables to ensure adequate shielding (impedance of 110 to 135 ohms).

To connect external SCSI devices:

1. If the system is connected to AC power and operating, shut down the system and unplug the system power cord from its AC power outlet.
2. If a terminator module is connected to the SCSI port on the system, remove it.
3. Connect one end of a SCSI cable to the SCSI port on the system.
4. Connect the other end of the SCSI cable to a SCSI peripheral device.
5. Connect a SCSI cable between SCSI ports on any additional SCSI peripheral devices.
6. Set the SCSI ID of **each** peripheral device to a **unique** SCSI ID number. Do not use any SCSI ID numbers already used by the system.
7. For each SCSI peripheral device connected to the port, if the device is:
  - The last or only device on the SCSI chain, **install** or **enable** SCSI termination
  - **Not** the last or only device on the SCSI chain, **disable** or **remove** SCSI termination
8. Ensure that the power switch on each peripheral device is in the off position; then connect the power cord from each peripheral device to an AC power outlet.
9. Turn on power to all connected SCSI peripheral devices, and then start the system.
10. If necessary, install software drivers and configure the peripheral devices according to the vendor's instructions.

See Chapter 8, "Upgrading the System" for additional details on installing external SCSI peripheral devices.

## Connecting to AC Power

---

**Caution:** The power switches on the unit's two power supplies are the service disconnect. To remove AC power from the system, you must turn the power switch on **both** power supplies to the off (o) position.

---

---

**Caution:** Ensure the AC power outlet to which the system's power cords connect are close to the system and are easily accessible.

---

The system has two power supplies. Both must be connected to AC power for the system to operate correctly. However, if one power supply fails, you can replace it without shutting down the other power supply. This hot-swap capability lets you handle a power supply failure without shutting down and powering down the entire system.

When you connect the system's base unit to AC power and turn the Power switches on ( | ) position, auxiliary power is applied to the system. Auxiliary power ensures that system components power up quickly when needed. See Chapter 4, "Operating the System" for more information on controlling system power.

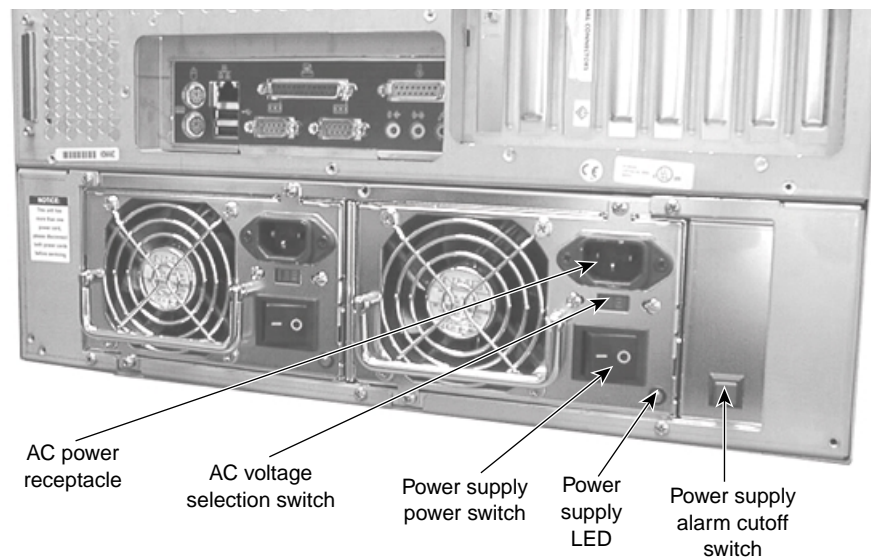

**Figure 1-17** Power Supplies

To connect the system to AC power:

1. Make sure the AC voltage selection switches on **both** power supplies (on the back of the base unit) are set to the proper line voltage for your location.
  - If your location uses 90 to 135 volts, the number **115** must be visible.
  - If your location uses 180 to 264 volts, the number **230** must be visible.

---

**Warning:** If you do not set the AC voltage selection switches on the power supplies correctly, equipment damage may occur when you connect the system to AC power.

---

2. Make sure the Power switches on **both** power supplies are set to the off ( O ) position.
3. Connect the system's power cords to the AC power receptacles on **both** power supplies.
4. Connect the power cords from the monitor, base unit, and any external peripheral devices to properly grounded three-prong AC power outlets.
5. Turn the Power switches on **both** power supplies to the on ( | ) position. This applies auxiliary power to the system. The power supply light-emitting diodes (LEDs) light when the power supplies are operating.

## Starting the System

---

**Caution:** If you start the system, and then turn it off before completing the instructions in Chapter 2, "Setting Up the Software" you will have to reinstall the operating system and associated system software. See "What's Next?" on page 23 for more information.

---

---

**Caution:** Before starting the system for the first time, you may want to learn more about system power, startup, and shutdown. See Chapter 4, "Operating the System" for more information.

---

To start (apply full power to) the system, turn the Power keyswitch shown in the following figure to the right (clockwise), and then release it.

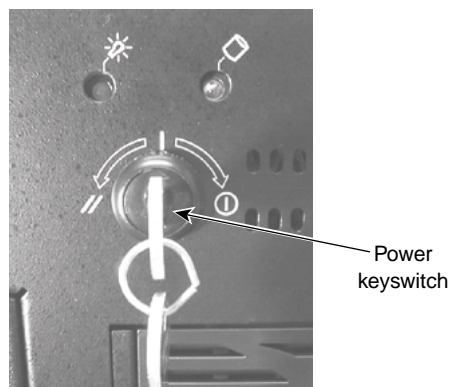

**Figure 1-18** System Power Keyswitch

If your system does not have a Power keyswitch on the front panel, you will find Power and Reset buttons behind the door on the front panel, above the disk drives. To start (apply full power to) the system, press the Power switch momentarily and then release it.

## What's Next?

You can do the following to prepare your system for use:

- If you want to get going with the default setup, go to Chapter 2, “Setting Up the Software” to start the system and go through operating system Setup. **If you start the system and then turn it off before completing operating system Setup, you will have to reinstall the operating system and associated system software.**
- The operating system is already installed through the first phase of the Setup process. If you want to reload the operating system and associated system software instead of completing Setup, see Chapter 6, “Reinstalling the Operating System”.
- On a RAID system, the default RAID setup is disk drives striped to RAID level 5, with a write-through write policy. The default setup is described in more detail in Chapter 3, “Configuring the System”.



## Setting Up the Software

This chapter describes how to set up the operating system and associated system software for your system.

### Preparing for Setup

Your workstation's primary hard disk drive was formatted and partitioned before shipment. In Explorer or My Computer, you can right-click a disk drive and click Properties to display the drive's partition size and file system format. If you purchased other disk drives, you may have to format and partition them for use. See the operating system documentation and Help for more information on formatting, partitioning, and administering disk drives.

The operating system and associated system software is installed on the system's primary hard disk drive. Installed system software includes:

- Driver software for the SCSI controller, graphics controller, audio controller, and mouse
- Driver software for peripheral devices and expansion cards installed at the factory (including the RAID controller in a RAID system)
- Core networking software
- The latest certified operating system Service Pack software, if needed
- Quick-Fix Engineering (QFE) software, if needed
- System management software

The operating system is installed through the first phase of the Setup process. You must follow the Setup process to prepare the operating system for use.

Before you go through operating system Setup, have the following documents available:

- Microsoft's operating system documentation

- Documentation for the system's graphics controller and any other installed expansion cards

Get and record the following information:

Your name, and the name of your company or organization:

---

The Product Identification Number from Microsoft's documentation, Certificate of Authenticity, or registration card:

---

A user name for a user account:

---

If the system is connected to a network, get and record the following information for your system from your network administrator:

Computer name:

---

Workgroup name (if the system will be part of a workgroup):

---

Domain name (if the system will be part of a domain):

---

If the system will be a server, get and record the following information for your system from your network administrator:

Security role for your server in the domain: primary domain controller, backup domain controller, or stand-alone server:

---

If your server will be acting as a backup domain controller or a stand-alone server, user name and password of an authorized domain administrator account:

---

---

**Note:** Determine the security role for your server before beginning system configuration. You cannot change a stand-alone server to a domain controller without reinstalling the operating system. A domain controller maintains security policy and performs user



authentication for a domain. Stand-alone servers may be part of a domain, but they do not have to participate in the domain. See the operating system documentation for more information.

---

If the system is connected to a network that uses the Transmission Control Protocol/Internet Protocol (TCP/IP), get and record the appropriate TCP/IP information for your system from your network administrator:

Internet Protocol (IP) address:

---

IP subnet mask:

---

IP domain name for your network:

---

IP address for your network's default gateway:

---

IP addresses for Domain Name System (DNS) servers, if any:

---

IP addresses for Windows Internet Name Service (WINS) servers, if any:

---

The operating system delivery media contain software and drivers for both Reduced Instruction Set Computing (RISC)- and Intel-based systems. When installing operating system software, make sure you install it from the \i386 directory on the delivery media.

## Going Through Setup

---

**Caution:** If you start the system and then turn it off before completing operating system Setup, you will have to reinstall the operating system and associated system software.

---

---

**Caution:** Before starting the system for the first time, you may want to learn more about system power, startup, and shutdown. See Chapter 4, "Operating the System" for this information.

---

To start (apply full power to) the system, turn the Power keyswitch on the front of the base unit to the right (clockwise) and then release it.

If your system does not have a Power keyswitch on the front panel, you will find the Power and Reset buttons behind the door on the front panel, above the disk drives. To start (apply full power to) the system, press the power switch momentarily and then release it.

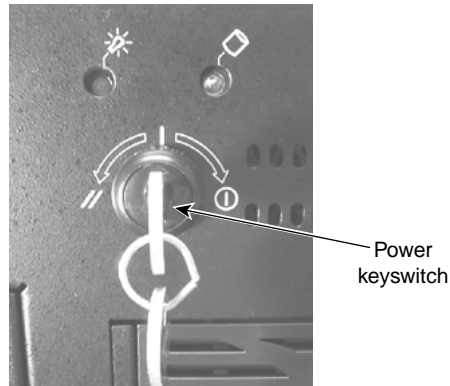

**Figure 2-1** System Power Keyswitch

The first time you start the system, it boots to a Microsoft End User License Agreement (EULA). After reading and accepting the terms of the agreement, follow the instructions to continue operating system Setup. Take the default settings provided by Setup, except as noted in the following text. You can set up a user account and join a workgroup or domain after you configure the system.

To start the computer and go through Setup:

1. Turn on power to the monitor.
2. Turn on power to the base unit. The system starts and the EULA displays.
3. Read the terms of the EULA and then follow the instructions displayed to complete the Setup process. When prompted, enter the Product Identification Number.

---

**Note:** You must enter the Product Identification Number before you can continue Setup. You cannot complete Setup if you do not enter this number.

---

When going through Setup:

- Install the SCSI controller driver software from diskette. You cannot install the SCSI controller driver from the system's driver CD.
- **Do not let Setup auto-detect the system's network controller.** After completing Setup, install the network controller driver software from diskette. See "Finishing Software Setup" on page 29 for instructions.
- If prompted to create an Emergency Repair Disk, do so.
- If prompted to enter a password for the Administrator account, do so.
- If you do not create a user account during Setup, press `enter` or select OK at the logon dialog to log on to the operating system.
- You can use the `C:\i386` directory when prompted for the location of the operating system's Setup files. If you delete the `i386` directory from the system's hard disk, you must have access to an operating system CD to use the operating system's Setup files.

After you complete Setup and restart the system, you can set up a user account and join a workgroup or domain if needed. See the operating system documentation and operating system Help for more information on Setup, creating a user account, and joining a workgroup or domain.

## Finishing Software Setup

After completing operating system Setup, you must take some additional steps to finish setting up the system software.

### Installing the Network Controller Driver

Setup completed without auto-detecting the system's network controller. To enable networking, you must manually install the network controller driver software from diskette.

The network controller driver software is in a folder on the system's driver CD. First see the `readme.txt` file for information on creating a driver diskette using the `makems.bat` program. Then see the `ms.txt` file for information on installing the driver software using Network in the operating system Control Panel. Keep the driver diskette for use if you have to reinstall the operating system.

### Creating an Emergency Repair Disk

If you did not create an Emergency Repair Disk during Setup, you should do so after completing Setup and configuring the system. See the operating system documentation and Help for information on creating an Emergency Repair Disk.

You can use the files on the Emergency Repair Disk to restore the contents of the operating system registry and the standard operating system driver software. You should update the Emergency Repair Disk frequently, especially after adding or changing system hardware or software.

### Installing Driver Software

Driver software (or *drivers*) for most system components and peripheral devices was installed before shipment. You received a CD with your system that contains these drivers. Keep the driver CD in case you have to reinstall the operating system or drivers later.

Because of production timing, drivers for your system may have been revised after your system shipped from the factory. You should check SGI's online services for the latest versions of your system's drivers. If a later version of a driver is available, you can download it and install it on your system; keep it on diskette in case you need to reinstall it later. See the `readme` file delivered with a driver for installation instructions.

### Installing QFE Software

Quick-Fix Engineering (QFE) software contains fixes for operating system problems or limitations; these fixes are required for proper operation of your system. QFE software, when required, is delivered on the system's driver CD, and additional QFE software may be delivered on diskette. If you received QFE software with your system, it was installed before shipment. Keep the QFE software in case you have to reinstall it or the operating system later.

Because of production timing, the QFE software for your system may have been revised after your system shipped from the factory. You should check SGI's online services for the latest version of the QFE software for your system. If a later version is available, you can download it and install it on your system; keep it on diskette in case you need to reinstall it later. See the `readme` file delivered with the QFE software for installation instructions.

## What's Next?

See Chapter 3, “Configuring the System” to configure the system for use.

See Chapter 4, “Operating the System” for information on operating the system.

See Chapter 6, “Reinstalling the Operating System” if you need to reinstall the operating system and associated system software.



## Configuring the System

This chapter describes how to configure basic components of your system for use.

### Configuring the Video Display

The first time you start the system, your monitor displays a resolution of 1024 x 768. For the system to use the installed graphics controller at other display resolutions, you must configure the video display driver as described in this section.

Go to Display in the operating system's Control Panel to configure the video display driver, or right-click an open space on the operating system desktop and click Properties in the pop-up menu. You can change the settings for color depth, desktop size, font size, refresh rate, and display type of the system's video display. You can also determine which type of graphics controller is installed on your system.

See the graphics controller documentation delivered with the system, and any README files delivered with the video display driver, for detailed configuration instructions. For more information on configuring the video display, see the operating system documentation and Help.

### Resetting the Video Display Resolution

If the monitor connected to your system does not support a resolution of 1024 x 768, you can reset the video display to another resolution.

To reset the video display resolution:

1. Restart the system.
2. At the boot screen, select the VGA mode option, and then log on to the operating system.
3. Go to Display in the operating system's Control Panel.

4. Select a resolution appropriate for your system's monitor.
5. If prompted to restart the system, do so.

## Changing the Default Video Display Driver

After configuring the video display and restarting the system, you may need to configure the system to use the installed video display driver by default.

To change the default video display driver:

1. Go to System in the operating system's Control Panel.
2. Under Startup/Shutdown, select the appropriate non-VGA option from the Startup list.

## Correcting Initial Video Display Problems

If the system's video display is black, not synchronized, or distorted after you restart the system, you may have a video configuration problem. Do not press `ctrl-alt-del` to log on. Instead, try to correct the problem by using the Last Known Good option to return the system to the last known good configuration recorded by the operating system.

To use the Last Known Good option:

1. Power down and restart the system.
2. Press the space bar when prompted to display the Last Known Good menu.

If using the Last Known Good option fails to correct the video display problems, you can obtain a functional video resolution by restarting the system in VGA mode.

To restart the system in VGA mode:

1. Power down and restart the system.
2. At the boot screen, select the VGA mode option.

After logging on in VGA mode, check for the following common problems and solutions:

- A multi-sync monitor is selected, but a graphics display device with different video timings is connected to the system. Select a different monitor type.



- The monitor selection is incorrect. Select a different monitor type.
- There is not enough video display memory to support the selected resolution and color depth. Install and reconfigure the video display to use a lower resolution and color depth.

Restart the system and, when the boot screen displays, select the appropriate non-VGA version of the operating system to use the reconfigured video display driver. If problems persist, contact the Customer Response Center for help.

## Configuring System Audio

The system has a PCI audio controller integrated on the system board. The required driver software was installed before shipment.

If you connect a microphone and speakers to their ports on the I/O panel, you can use the audio mixer software to control the speaker volume, the microphone input level, and other system audio features. The audio mixer is available from the operating system's taskbar tray. You can also configure audio levels by using the operating system's Volume Control and audio control programs. The Volume Control is available from the operating system's taskbar tray.

For more information on using the audio control programs, see the operating system documentation and Help. For more information on the audio controller, see the *System Board Guide*.

## Configuring Networking

The system has a 10 Mbit/100 Mbit Ethernet network controller integrated on the system board. The network controller features remote management and Wake-On-LAN capabilities. The required driver software was installed before shipment.

Before you configure networking, ensure that the system is connected to the network. Then go to Network in the operating system's Control Panel to configure networking. Follow the instructions provided to set up the system to connect to and communicate over a network. Be sure to set up the appropriate network protocols, such as TCP/IP, for the network to which you are connecting the system.

After installing network protocols, you may need to reinstall the appropriate operating system Service Pack software as recommended by Microsoft. See the Service Pack documentation delivered with the system for more information.

See the operating system documentation and Help for more information on setting up the operating system to use a network. For more information on the network controller, see the *System Board Guide*.

## Configuring Peripheral Devices

If you install additional peripheral devices in the system, you will have to install and configure the associated driver software. You may also have to install or configure any associated application software to use the devices.

You can use the default backup tools provided with the operating system to run a tape drive. Go to Backup on the Administrative Tools program menu. See the operating system documentation and Help for more information.

See the documentation delivered with the peripheral devices for information on installing and configuring driver software and associated application software. See the operating system documentation and Help for information on using peripheral devices with the operating system.

## Configuring RAID Disk Drives

In a RAID system, up to four removable low-voltage differential (LVD) SCSI disk drives are installed in the system's disk drive cage. An installed RAID controller card manages these disk drives. The RAID controller provides the system with RAID capabilities such as disk striping, mirroring, and redundancy for the removable disk drives.

The disk drive locations in the disk drive cage are numbered from 0 to 3, starting with the right-most or top-most location. Each location also has a corresponding SCSI ID number, which is determined by the hardware configuration of the disk drive cage and the RAID controller to which it is connected.

4 GB	0	0	1
	ADP	CH	ID

**Figure 3-1** Disk Drive Label

Each installed removable disk drive has a label to identify it. The spaces above ADP, CH, and ID are filled in before shipment to identify the drives.

- ADP identifies the RAID controller connected to the disk drive cage.
- CH identifies the RAID controller's SCSI bus channel.
- ID identifies the disk drive's SCSI ID.

Up to four removable disk drives may be installed and configured with the RAID controller software at the factory. These disk drives are configured to appear as one logical disk drive in Window NT Disk Administrator. The logical disk drive has a 2 GB NTFS system disk partition. The rest of the logical disk drive is formatted as one NTFS partition, for a total of two partitions.

The default configuration for factory-installed RAID disk drives is as follows:

- RAID level 5
- Write-through write policy
- Two disk drives spin up every twelve seconds

You can use the RAID controller software to manage the RAID disk drives.

The following table shows the correlation between the disk drive locations in the disk drive cage, the disk drive SCSI IDs, and disk drive IDs in the RAID controller BIOS and the RAID controller software.

**Table 3-1** RAID Disk Drives

Disk Drive Location	Disk Drive SCSI ID	Disk Drive Label	RAID Controller Target ID
0 (right or top)	0	ADP 0, CH 0, ID 0	1
1	1	ADP 0, CH 0, ID 1	2

**Table 3-1** RAID Disk Drives

Disk Drive Location	Disk Drive SCSI ID	Disk Drive Label	RAID Controller Target ID
2	2	ADP 0, CH 0, ID 2	4
3 (left or bottom)	4	ADP 0, CH 0, ID 4	5

---

**Note:** SCSI ID 3 and RAID controller target ID 3 are reserved for the SAF-TE card on the disk drive cage.

---

For more information on configuring and managing the RAID disk drives and using the RAID controller software, see the RAID controller documentation delivered with the system.

## Changing Drive Letters

If you have more than one hard disk drive or CD-ROM drive, you may need to reassign system drive letters. See the operating system Help for more information.

To change drive letters:

1. Exit all applications currently running on your system.
2. Go to Disk Administrator in the Administrative Tools program menu.
3. Select a hard disk drive or the CD-ROM drive.
4. From the Tools menu, click Assign Drive Letter.

---

**Note:** If you select the current drive or an otherwise locked drive, you must restart the system to complete the drive letter reassignment.

---

5. Select a new drive letter to assign to the drive from the list. Click OK, and then click Yes to continue.
6. If necessary, click OK, and then click Yes.
7. Repeat steps 2 through 6 for each drive letter assignment that you want to change.

8. Click Partition, then click Exit. If necessary, restart the system to complete the drive letter reassignments.

## Changing Virtual Memory Settings

If you have more than one hard disk drive, you may need to change size and location of your virtual memory page file. See operating system Help for more information.

Consider the following before changing page file settings:

- The size of the page file. If your system is equipped with a large amount of RAM, Setup might create a page file that is unnecessarily large.
- Drive letter reassignments. If you reassigned your drive letters, you may find it necessary to adjust your page file settings.

To change the size and location of the virtual memory page file:

1. Go to System in the operating system's Control Panel.
2. Under Performance, click Change.
3. Click a drive letter in the list, and then type new values in the Initial Size and Maximum Size text boxes.
4. Click Set.
5. Repeat steps 3 and 4 for any additional drives in the list.
6. Click Close, and then click OK.
7. When prompted, click Yes to restart the system with the new settings, or click No to continue with other tasks and use the new settings the next time you restart the system.

## Configuring the SCSI Controller

The system has a dual-channel SCSI controller integrated on the system board. Depending on your system's hardware configuration, this low-voltage differential (LVD) controller manages internal and external Ultra, Ultra2, and Ultra3 SCSI peripheral devices. You may need to use the SCSI Configuration Utility to configure the operation of SCSI peripherals connected to the controller.

You may need to change SCSI controller parameters for a single SCSI peripheral device:

- If you are advised to do so by technical support or by the vendor documentation.
- If the SCSI device does not negotiate properly with the controller.
- If you exceed the maximum cable length for connecting SCSI devices to the system. See Chapter 8, “Upgrading the System” for more information.
- If you connect non-Ultra SCSI peripheral devices to the system.

To run the SCSI Configuration Utility:

Press `ctrl+c` when prompted during system boot.

To get online help in the SCSI Configuration Utility:

Press `f1` to see information on the item currently highlighted on screen.

## Creating or Updating an Emergency Repair Disk

If you did not create an Emergency Repair Disk during Setup, you should do so after completing Setup and configuring the system. See the operating system documentation and Help for information on creating an Emergency Repair Disk.

You can use the files on the Emergency Repair Disk to restore the contents of the operating system registry and the standard operating system driver software. You should update the Emergency Repair Disk frequently, especially after adding or changing system hardware or software.

## Configuring the BIOS

The system’s basic input/output system (BIOS) records basic system operating parameters, such as the amount of memory, the boot sequence, and the type of video display. The BIOS is stored in flash-programmable memory, and reads the system parameters in the system’s complementary metal-oxide semiconductor (CMOS) memory. When you power off the system, a battery provides power to CMOS memory to retain the system parameters. Each time you power on the system, the BIOS uses these stored parameters to configure the system for operation.

The BIOS Setup program, which is also stored in flash-programmable memory, allows you to manually change the system operating parameters. You can run the BIOS Setup program as the system boots, during the system's power-on self-test (POST). For more information on the BIOS Setup program and how to use it to configure the BIOS, see the *System Board Guide*.

## What's Next?

See Chapter 4, "Operating the System" for basic information on operating the system.

See Chapter 8, "Upgrading the System" if you need to reinstall the operating system and associated system software.





## Operating the System

This chapter contains important, basic information on operating your system.

### Controlling System Power

---

**Caution:** The Power switches on the unit's two power supplies are the service disconnect. Simply turning the Power keyswitch, or pressing the Power or Reset buttons, can cause data configuration or loss.

---

When you connect the system's base unit to AC power and turn the Power switches on **both** power supplies to the on ( | ) position, auxiliary power is applied to the system. Auxiliary power ensures that system components power up quickly when needed.

The Power keyswitch is a momentary contact switch, changing system states when the switch is turned. Depending on the system's current power state, you can use the Power keyswitch to start, shut down, and power down the system.

If your system does not have a Power keyswitch on the front panel, you will find Power and Reset buttons behind the door on the front panel, above the disk drives. The Power button is a momentary contact switch that changes system power states. Depending on the current power state, you can use the Power button to start, shut down, and power down the system. The Reset button causes a system reset that is identical to a power-on reset.

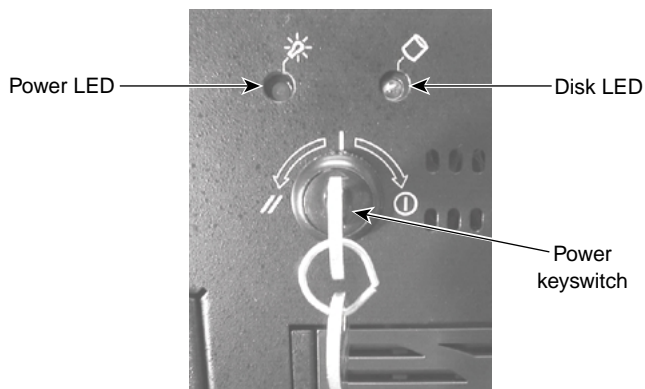

**Figure 4-1** System Power Keyswitch

---

**Caution:** Shut down the operating system before powering down the system. Simply turning the Power keyswitch can cause data corruption or loss. Simply turning the Power keyswitch, or pressing the Power or Reset buttons, can cause data corruption or loss. See this and following sections for more information..

---

**Table 4-1** The Power Button

Turn Power keyswitch right, or press the Power button...	To...
Momentarily (less than 1 second)	Bring the system to full power from a powered-down state and start the operating system
Momentarily (less than 1 second)	Start the selected automatic shutdown option.
And hold it for at least 4 seconds	Power down the system without using the selected automatic shutdown option or after using the operating system's shutdown function.

---

See "Using Automatic Shutdown" on page 45 for more information on controlling system power.

## Reading System LEDs

The LEDs on the faceplate describe the current operational state of the system.

**Table 4-2** Reading the Power LED

If the Power LED is...	Then...
Unlit	Auxiliary power is off (fans are not running) or there is a system failure (fans are running)
Amber	Auxiliary power is on; power consumption is reduced
Blinking green	Auxiliary power is on; the system is in an ACPI-compliant power conservation state managed by the operating system; power consumption is reduced
Steady green	Full power is on; power conservation is per device

**Table 4-3** Reading the Disk LED

If the Disk LED is...	Then...
Unlit	The system's disk drives are not active
Lit and blinking	The system's disk drives are active
Lit and unblinking	There may be a problem with one or more disk drives

## Using Automatic Shutdown

The Shutdown Utility lets you configure various automatic shutdown options for your system. This utility provides shutdown options beyond those available from the operating system Start menu.

The Shutdown Utility displays an Automatic System Shutdown dialogSettings. You can use this dialog to select from several automatic shutdown options. You can also use this dialog to set how long the system waits to execute the selected automatic shutdown option.

To run the Shutdown Utility:

- From the operating system Start menu, go to Programs » Shutdown » Shutdown Program.
- Double-click the Shutdown icon in the operating system's taskbar tray, or
- While the system is running, press the Power button momentarily (less than 1 second).

When you run the Shutdown Utility, the Automatic System Shutdown dialog displays. To configure an automatic shutdown, select an option in the dialog and click Apply. When you have finished configuring the utility, click Start Shutdown to start an automatic shutdown immediately. After you start the system again, the utility will use the settings you selected.

By default, an automatic shutdown is set for a 10-second delay. You can set a delay of up to 30 seconds. You should set a delay greater than 5 seconds to ensure that you have time to stop an automatic shutdown if needed.

---

**Caution:** When configuring an automatic shutdown, use Power Down the Computer to power down the system. If you use Shutdown the Computer, you must press and hold the Power button for 4 seconds to power down the system. You may “suspend” the system if you hold the Power button for less than 4 seconds. If the operating system does not support a Suspend mode, you must then power down the computer before you can restart the system.

---

See Shutdown Utility Help for more information on this utility.

## Starting and Stopping the Operating System

To start the operating system:

1. With the system connected to AC power and **both** power supplies turned on, turn the Power keyswitch to the right (clockwise) or push the Power button momentarily to bring the system to full power.
2. At the boot menu, select the appropriate operating system option, and then press `enter`.

To log on to the operating system:

1. If the logon dialog does not display, press `ctrl+alt+delete` to display it.
2. If user accounts have been set up, type a user name and a password into the appropriate fields.
3. If appropriate, type a domain name into the appropriate field.
4. Select OK or press `enter`.

To log off, restart, shut down, or power down the system:

1. Turn the Power keyswitch right or press the Power button, momentarily (less than 1 second). Automatic Shutdown runs and the shutdown timer begins counting down.
2. Select a shutdown option and click Start Shutdown.
3. When prompted that it is safe to shut down the system, turn the Power keyswitch to the left (counter-clockwise), or push the Power button for at least 4 seconds, to bring the system down to auxiliary power.

---

**Caution:** The Power switches on the unit's two power supplies are the service disconnect. To remove AC power from the system, you must turn the Power switch on **both** power supplies to the OFF ( O ) position.

---

For more information on starting and stopping the operating system, see the operating system documentation and Help.

## Observing Operating Precautions

Observe the following precautions when operating the system:

- When restarting the system, use the operating system controls instead of turning the power switch off and on. Use the power switch only when instructed, or as the last alternative for restarting the system.
- Never turn off power to the base unit when the disk access LED is lit.

- After turning off power to the base unit, wait at least 30 seconds before turning the power on again. This allows the power supply to stabilize and the disk drives to stop spinning.

## Using the Keyboard

The system's PS/2-compatible keyboard includes the following features:

- 104 standard keys, including special application function keys (f1 through f12), arrow keys for moving the cursor, and numeric keys in a keypad.
- Special keys for use with Windows operating systems. Pressing the left or right Windows key (on either side of the space bar) displays the operating system Start menu and Taskbar. Pressing the Application key (to the right of the space bar) displays an application-specific pop-up menu.

Your keyboard may differ from the one shown in Figure 4-2.

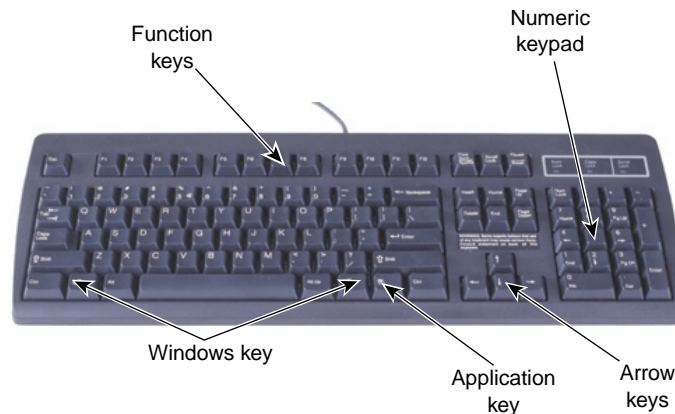

**Figure 4-2** The Keyboard

Some keyboard keys have special functions:

**Table 4-4** Special Keyboard Functions

<b>Key</b>	<b>Function</b>
<code>esc</code>	Usually assigned to an application-specific function; often used to exit.
<code>print scrn</code>	Depending on the application in use, prints the displayed screen to a printer.
<code>scroll lock</code>	Prevents the screen from scrolling.
<code>pause</code>	Temporarily suspends screen scrolling or some operations.
<code>caps lock</code>	Types all letters as capitals.
<code>num lock</code>	Activates the numeric keypad.
<code>ctrl</code>	Used with another key for application-specific functions.
<code>alt</code>	Used with another key for application-specific functions.
<code>delete</code>	Deletes characters.

You can use the Windows keys with other keys to perform certain operating system functions:

**Table 4-5** Key Combinations

<b>Key Combination</b>	<b>Action</b>
<code>Windows - f1</code>	Display a pop-up menu for the selected object
<code>Windows - tab</code>	Activate the next button on the taskbar
<code>Windows - e</code>	Run Explorer
<code>Windows - f</code>	Run Find Document
<code>Windows - ctrl - f</code>	Run Find Computer
<code>Windows - x</code>	Minimize all windows
<code>shift - Windows - x</code>	Restore all windows
<code>Windows - r</code>	Display the Run dialog

## Using the Mouse

The system's PS/2-compatible mouse is a tracking device that controls the movement and positioning of the pointer (or cursor) displayed on the screen in a graphical display environment.

Your mouse may differ from the one shown in Figure 4-3.

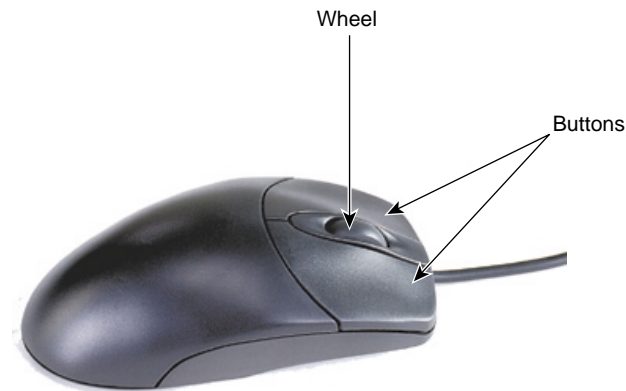

**Figure 4-3** The Mouse

To use the mouse, ensure it is connected to the system. Place the mouse on a clean, flat surface, such as a desktop or a mouse pad. Rest your hand on the mouse, with a finger on each button and the thumb to the side. Move the mouse across the flat surface to move the pointer on screen.

You can use the mouse to perform several actions:

**Table 4-6** Mouse Actions

Action	Description
Point	Move the mouse to point to your selection on the screen.
Click	Press and release the left mouse button once.
Double-click	Press and release the left mouse button twice.
Drag	Press and hold the left mouse button, then move the mouse. Release the button when you finish dragging your selection to a new location.



**Table 4-6** Mouse Actions

Action	Description
Right-click	Press and release the right mouse button once.
Scroll	On a wheel mouse, move the wheel back and forth to scroll in an application.

You can find more information on using the wheel mouse by right-clicking the mouse icon in the taskbar tray, or by going to Start/Settings/Control Panel/Mouse and clicking Help in the toolbar.

## Using the Floppy Disk Drive

The system's floppy disk drive occupies a 3.5-inch external peripheral device bay, and is accessible through a 3.5-inch slot on the front of the base unit. The drive accepts standard 3.5-inch 720 KB and 1.44 MB diskettes.

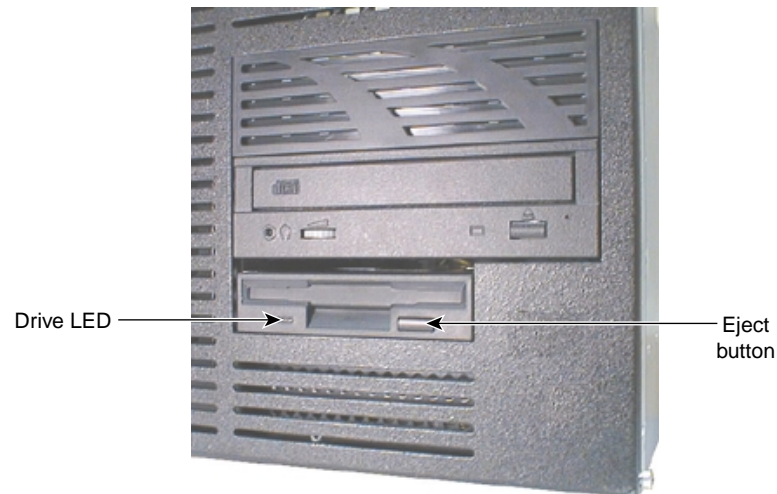
**Figure 4-4** The Floppy Disk Drive

Follow these guidelines to use the floppy disk drive:

- To insert a diskette, slide the diskette with the arrow facing up into the slot. Push the diskette in until it clicks into place and the eject button pops out.
- Before removing a diskette, ensure the drive LED is not lit.
- To remove a diskette, push the eject button and pull the diskette out of the slot.
- To protect the data on a diskette from being overwritten or erased, slide the write-protect tab on the diskette toward the diskette edge until it snaps into place.

## Using the CD-ROM Drive

The system's CD-ROM drive occupies a 5.25-inch external peripheral device bay, and is accessible through a tray or a slot at the front of the base unit. The drive supports software ejection of discs and has an external amplified headphone jack.



**Figure 4-5** The CD-ROM Drive

To use the CD-ROM drive:

- To insert a CD, press the eject button to extend the tray. Place the disc, printed side up, in the tray and press the eject button again to retract the tray.

- To remove a CD, press the eject button, and remove the disc after the tray extends. Then press the eject button again to retract the tray.
- The media player programs included with the operating system allow you to listen to audio compact discs. Insert an audio CD, printed side up, into the drive and start the media player application. Adjust the volume using the operating system's sound control programs.
- Adjust the volume control on the drive for headphones connected to the drive.

## Reading Removable Disk Drive LEDs

In a RAID system, LEDs visible through the disk drive cage door (or when the door is open) help you determine the activity and status of removable disk drives. There are two LEDs for each disk drive:

- The right (green) LED above each disk drive flashes to show disk activity.
- The left (amber) LED above each disk drive indicates RAID activity and is controlled by the SCSI Activity Fault-Tolerant Enclosure (SAF-TE) card on the disk drive cage and the installed RAID controller card.

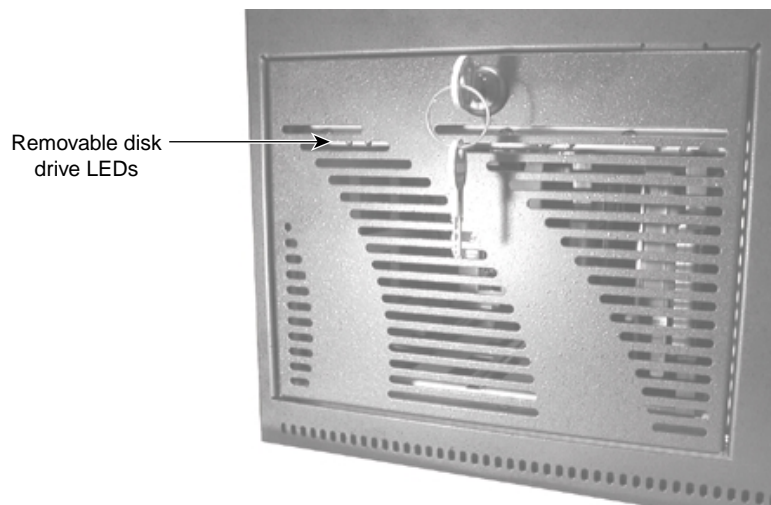

**Figure 4-6** Removable Disk Drive LEDs (Behind Door)

The SAF-TE card causes the left (amber) LED above each disk drive to indicate the RAID status of each disk drive as follows:

**Table 4-7** Reading Removable Disk Drive LED

Left (Amber) LED Activity	Disk Drive Status
Off	No error
Steady on	Disk drive rebuild stopped or disk drive is faulty
Steady blink (1 per second)	Disk drive rebuild in progress
Fast steady blink (3 per second)	Disk drive identification in progress
4 fast blinks, pause (repeats)	Disk drive experienced a predicted fault
2 fast blinks, pause (repeats)	Disk drive is a hot spare

To manage the RAID disk drives and the SAF-TE card, use the RAID configuration software and utilities described in the RAID controller documentation delivered with the system.

## Responding to a Power Supply Alarm

Each of the system's two power supplies has an LED that lights when the power supply is on. If a power supply encounters a problem or fails, its LED flashes and an audible alarm sounds. To cut off the audible alarm, press the power supply alarm cutoff switch on the back of the base unit.

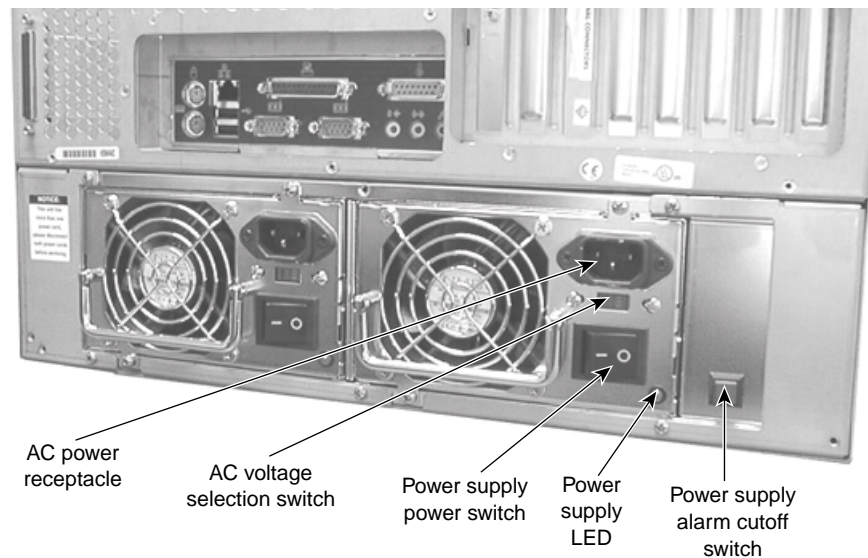

**Figure 4-7** The Power Supply

If a power supply alarm sounds:

- Look for the flashing LED to determine which power supply has a problem.
- Make sure the power supply is fully seated in the base unit.
- Make sure the power supply's AC power cord is fully inserted into its AC power receptacle.
- Make sure the power supply's AC voltage selection switch is properly set.
- Make sure the power supply's power switch is in the on ( | ) position.

See Chapter 9, "Servicing the System" for information on replacing a power supply.

## Using System Management Software

Your system shipped with the following system management software installed:

- Hardware Monitor is an interface to instrumentation data measured by sensors inside the computer. Event information is reported to the Event Log and displayed graphically.

- DMI Console gives easy access to the system's status and configuration information. DMI Console works with the Desktop Management Interface (DMI), a technology standard that enables the effective management of computers.
- ECC Monitor monitors the system's error correcting code (ECC) memory and reports any problems.
- SMART Disk Driver (SMARTDRV) is a kernel-level driver that supports self-monitoring, analysis, and reporting technology (SMART) for disk drives.

You can find these programs by going to Programs on the operating system's Start menu. See the online Help for each program for more information on how to use it.

## Learning About the Operating System

Documentation delivered with your system describes the basic functions of its operating system. Refer to this documentation if you are unfamiliar with the operating system interface and features. You can also refer to extensive online Help; from the operating system Start menu, go to Help.

## Using Hardware Security Features

The system has security features to help prevent unauthorized tampering with internal components.

- An intrusion alert switch notifies Hardware Monitor and the Windows NT Event Log if the left side panel (as viewed from the front of the base unit) is removed.
- A hasp for locking the left side panel (as viewed from the back) is available on the back of the base unit.

## Cleaning System Components

Follow these guidelines for cleaning system components:

**Table 4-8**      Cleaning System Components

Item	How to Clean
Exterior Surfaces	Wipe exterior surfaces of the base unit and the monitor screen with a soft cloth lightly moistened with a <b>mild</b> cleaning agent.
Keyboard	Dust the keys and the keyboard surface with a soft, dry cloth. Use an aerosol cleaner to remove dust and debris from between the keys. Never use liquid to clean the keyboard.
Mouse	Remove the retaining ring and the tracking ball from the bottom of the mouse. Blow gently into the opening. Wipe the tracking ball and the rollers in the opening with a cotton swab moistened with alcohol. Replace the tracking ball and the retaining ring.



## Troubleshooting Operational Problems

Use this chapter to identify and resolve some common basic system problems.

### Getting Started

If your system is not functioning properly, first do the following:

- Verify the system's power state and ensure the system is properly connected to AC power. See Chapter 1, "Setting Up the Hardware" and Chapter 4, "Operating the System".
- Ensure the data and power cables are properly connected to any external peripheral devices.
- Ensure the data and power cables are properly connected to all internal peripheral devices.
- Refer to accessory documentation for troubleshooting help if there are problems with RAID disk drives, the RAID controller, or connected peripheral devices.

If you cannot resolve the problem or if the instructions in the following sections direct you to do so, contact SGI for further help. Refer to the documentation delivered with various peripheral devices for troubleshooting help if there are problems these devices.

The following chapters in this document contain information and instructions that may be helpful when carrying out troubleshooting procedures and attempting to apply solutions.

## System Power

**Table 5-1** Fails to power on

Reason	Solution
System is not at full power (Power LED lights amber).	Press the Power button to attempt to apply full power. The Power LED lights green when the system is at full power.
System will not awaken from "suspend" state.	Verify that the Shutdown Utility ( <code>shutdown</code> ) is installed. If not, turn system power off and then on again. If so, use the Power Down the Computer option. See Chapter 4 and Chapter 6.
Power cord is not connected.	Verify the power cord is connected to the power receptacle.
Power is not available at the AC power outlet.	Verify power is available at the AC power outlet. Test the outlet with a known working device.
Internal power cables are not connected.	Open the base unit and ensure all power cables are connected.
Power cord is faulty.	Replace power cord.
Power supply is faulty	Replace power supply.

## System Boot

**Table 5-2** Does not boot from the expected boot device

Reason	Solution
Boot sequence is not correctly set.	Change the boot sequence. See the <i>System Board Guide</i> for information on running BIOS Setup and changing the boot sequence.
BIOS attempts to boot from wrong hard disk drive.	Ensure SCSI controller for primary system disk drive is installed lower in slot order than any other SCSI controllers.
Operating system is not on the system drive.	Reinstall the operating system.

**Table 5-3** Series of beeps and error messages display

Message	Explanation and Solution
Refresh Failure	Bad memory refresh circuitry on the system board. Remove and reinstall DIMM(s). If error persists, replace the DIMM(s).
Parity Error	Parity error in the first 64 KB block of memory. Remove and reinstall DIMM(s). If error persists, replace DIMM(s).
Base 64 KB Memory Error	Memory failure in the first 64 KB. Remove and reinstall the DIMM(s). If error persists, replace the DIMM(s).
Timer Not Operational	Memory failure in the first 64 KB, or Timer 1 on the system board is not functioning. Contact SGI for support.
Processor Error	The CPU on the system board generated an error. Contact SGI for support.
8042 - Gate A20 Failure	The BIOS cannot switch to protected mode. Contact SGI for support.
Processor Exception Interrupt	The CPU generated an exception interrupt. Contact SGI for support.

**Table 5-3 (continued)** Series of beeps and error messages display

Message	Explanation and Solution
Display Memory Read/Write Error	The sound controller is faulty. Contact SGI for support.
ROM Checksum Error	The ROM checksum value does not match the value encoded in the BIOS. Contact SGI for support.
CMOS Shutdown Register Read/Write Error	The shutdown register for CMOS RAM failed. Contact SGI for support.
Cache Error/External Cache Bad	The external cache is faulty. Contact SGI for support.

**Table 5-4** Does not boot from drive A (floppy disk drive) or other expected boot device

Reason	Solution
Boot disk is corrupt or does not have the correct boot utilities.	Replace the bootable diskette with a known working diskette.
Boot sequence may be set to C, A, in which case the machine will not boot from A if there is an operating system on C.	Change the boot sequence. See the <i>System Board Guide</i> for information on running BIOS Setup and changing the boot sequence.
BIOS is corrupted.	Load a new BIOS to the system's flash memory. See the <i>System Board Guide</i> .

**Table 5-5** Floppy disk drive is not recognized

Reason	Solution
BIOS is not configured properly.	Reconfigure the floppy disk drive parameters in BIOS Setup. See the <i>System Board Guide</i> for information on running BIOS Setup and changing the boot sequence.
Power cable or data cable is not connected.	Open the base unit and ensure the power cable and data cable are connected.

**Table 5-6** System hard disk drive is not recognized

Reason	Solution
Power cable or data cable is not connected.	Open the base unit and ensure the power cable and data cable are connected.
SCSI termination is enabled on the hard disk drive you installed.	Disable SCSI termination. See the documentation delivered with the hard disk drive.
Some viruses cause the system to not recognize hard disk drives.	Run a virus scan program that checks the Master Boot Record. Clear any viruses detected by the program.

**Table 5-7** CD-ROM drive is not recognized

Reason	Solution
Power cable or data cable is not connected.	Open the base unit and ensure the power cable and data cable are connected.

**Table 5-8** Total amount of memory does not display

Reason	Solution
One or more memory modules are faulty.	Identify faulty memory modules by swapping modules until the faulty one is found.
Memory modules are not properly seated in their sockets.	Reseat memory modules in their sockets.

**Table 5-9** I/O Card parity error message displays

Reason	Solution
Faulty card is installed in the ISA slot.	Remove the ISA card and then restart the system.

## Video

**Table 5-10** System is powered on, but screen remains blank

Reason	Solution
Monitor is not powered on.	Turn on power to the monitor.
Power cord is not connected.	Verify the power cord is connected to the power receptacle.
Video cable is not properly connected.	Verify the video cable is connected to the monitor and to the system's video out connector.
Graphics card is not properly seated in its socket.	Open the base unit and reseal the graphics card.
Selected resolution is not supported by the monitor.	Select a supported resolution. See the graphics card documentation for more information.
An improper video display driver is installed.	Install a valid video display driver. See the graphics card documentation for more information.

## Audio

**Table 5-11** No sound can be heard

Reason	Solution
Speaker volume is low or off.	Adjust speaker volume up.
Speaker cable is not properly connected.	Verify speaker cables are connected to the system's line out port.
Volume is turned off in the software volume control or mixer program.	Open the software volume control or mixer program and turn up the volume.
Headphones are plugged into the system.	Unplug the headphones.

## Network

**Table 5-12** Cannot connect to other systems on LAN

Reason	Solution
Ethernet cable is disconnected.	Verify the Ethernet cable is connected. If the cable is properly connected, notify your network administrator.
Networking software is configured incorrectly.	Review the network settings in the operating system, and/or notify your network administrator.

**Table 5-13** Cannot plot to network printer or plotter on LAN

Reason	Solution
Network cable is disconnected.	Verify the network cable is connected.
Printer or plotter is not added to your system.	Add the printer using the operating system tools, and/or notify your network administrator.
Plot node does not recognize your system.	Notify your network administrator.

## Peripheral Drive Errors

**Table 5-14** CD-ROM drive LED does not light when system power is on

Reason	Solution
Power cable or data cable is not connected.	Open the base unit and ensure the power cable and data cable are properly connected.

**Table 5-15** Floppy disk drive LED does not light when system power is on

Reason	Solution
Power cable or data cable is not connected.	Open the base unit and ensure the power cable and data cable are properly connected.

## Miscellaneous Hardware

**Table 5-16** "Battery voltage low" message displays

Reason	Solution
Lithium battery voltage on the system board is low.	Replace the lithium battery on the system board.

**Table 5-17** System loses BIOS configuration information

Reason	Solution
Lithium battery voltage on the system board is low. The system also displays a "battery voltage low" message during the system boot.	Replace the lithium battery on the system board.

**Table 5-18** DMA bus timeout message displays

Reason	Solution
Failure in DMA bus logic has occurred.	Contact SGI for support.



**Table 5-19** “Invalid configuration information for SLOT XX” message displays

Reason	Solution
System is not properly configured to recognize the new ISA card.	Use BIOS Setup to reserve system resources for the ISA card. See the <i>System Board Guide</i> .



# Reinstalling the Operating System

This chapter provides basic instructions for reinstalling the operating system and associated system software on your system. Before you attempt to reinstall the system software, read and understand the entire chapter.

## Before You Begin

Before you attempt to reinstall the operating system, have the following items available:

- Information about your system that you recorded in Chapter 2, “Setting Up the Software”.
- Microsoft’s operating system CD, Setup diskettes, and documentation
- Microsoft’s Service Pack CD (if provided)
- Your system’s driver CD, QFE diskette (if provided), and documentation
- Software diskettes, software CDs, and documentation delivered with any expansion cards or additional peripheral devices

## Finding Driver Software

Your system’s driver CD contains driver software (or *drivers*) installed on the system before it shipped from the factory. Use the driver CD as the initial source for most drivers when reinstalling the operating system. (Exceptions include the network controller driver and the SCSI controller driver, which you must install from diskette.)

If updated versions of any drivers have been installed since you received the system, you should first reinstall the operating system using the default drivers from the driver CD. You can then reinstall any updated drivers after ensuring the system is operating correctly.

If a driver you want to install is not available from the driver CD, it may be available from the operating system CD. A driver from your system's driver CD is usually more current than the same driver from the operating system CD.

If expansion cards or peripheral devices have been installed since you received the system, you can get drivers from diskettes or CDs provided with these devices. See the documentation provided with these devices for installation instructions.

You can check SGI's online services for the latest versions of your system's drivers. If a later version of a driver is available, you can download it and install it on your system; keep it on diskette in case you need to reinstall it later. See the `readme` file delivered with a driver for installation instructions.

## Installing the Operating System

To install the operating system, follow the instructions in the operating system documentation. See the following text for information you may need to complete operating system Setup.

Do the following **during** installation of the operating system:

- When prompted for the location of the SCSI controller driver and the network controller driver, put their driver diskettes in the system's floppy disk drive, and then direct Setup to find the driver on the diskette. You may have to select the specific folder on the diskette that contains the driver you want to install.
- When prompted for the location of other drivers, put the system's driver CD in the system's CD-ROM drive, and then direct Setup to find the driver on the CD. You may have to select the specific folder on the CD that contains the driver you want to install.
- When prompted, create an Emergency Repair Disk.

Do the following **after** installation of the operating system:

- Install any drivers that were not installed during Setup (from the driver CD, diskettes, or other software CDs). See the `readme` files delivered with these drivers for installation instructions.
- Be sure to reinstall the Shutdown Utility from the driver CD. If you do not, pressing the system's Power button momentarily will put the system in a "suspend" state

from which it may not awaken. You will have to turn system power off and on to return to normal operation.

- Configure the system as described in Chapter 3, “Configuring the System”.
- If your system was running an operating system Service Pack, install this software **after** installing drivers and other system software, and **after** installing application software products.

Do the following **after** you install Service Pack software:

- If you have QFE software for your system, or have downloaded an updated version of the QFE software for your system, install the QFE software. QFE software, when required, is delivered on the system’s driver CD, and additional QFE software may be delivered on diskette. See the `readme` file delivered with the QFE software for installation instructions.
- On a system with Pentium III processors, install Intel’s Streaming SIMD Extension Driver, delivered on your system’s driver CD or as part of the latest Windows NT Service Pack software. This driver increases system performance for drivers and applications designed to take advantage of it. See the `readme` file delivered with the driver for more information.

## Updating the Operating System

Microsoft Service Packs and Service Releases contain the latest improvements and system fixes for Microsoft operating systems. Service Packs and Releases are created by Microsoft for post-release support. You can obtain them from Microsoft’s online services free of charge.

---

**Caution:** If a Service Pack is posted to SGI’s online services, it has been certified for use as described in the announcement of its availability. If you obtain a Service Pack from any other source, be aware that it may not be certified against your hardware.

---



## Gaining Access to System Components

This chapter describes how to gain access to major internal components so you can upgrade and service your system.

---

**Warning:** This is a user-serviceable system. Service and upgrade tasks should be performed by users who can follow instructions in a manual to service equipment, and can do so without harm to themselves or damage to the equipment.

---

### Before You Begin

---

**Warning:** The system is always on when connected to AC power and the power supplies are switched on. Before opening the system, switch off both power supplies. Internal components may be at high temperatures. Allow time for them to cool before handling them.

---

---

**Warning:** Internal components can be damaged by static electricity. Use an antistatic wrist strap connected to the bare metal of the system's chassis to protect against electrostatic discharge.

---

---

**Note:** "Right side" and "left side" are as seen from the **front** of the system.

---

## Avoiding Electrostatic Discharge

Sensitive components inside the base unit can be damaged by static electricity. To protect against electrostatic discharge, take the following precautions:

- Disconnect the base unit from AC power before opening the base unit.
- Touch the bare metal of the base unit chassis before touching any internal components.
- Handle all printed circuit boards as little as possible and only by the edges. Do not touch any gold contacts on a circuit board.
- Leave new parts in their protective packaging until you install them.
- Use a disposable or reusable antistatic wrist strap when servicing or upgrading the system. Once you use a disposable wrist strap, you cannot use it again.
- Attach an antistatic wrist strap to any bare metal part of the base unit chassis. The metal conductor in the elastic sleeve of a reusable antistatic strap must contact bare skin.

## Access Points

Figure 7-1 and Figure 7-2 show the access points for major internal components.



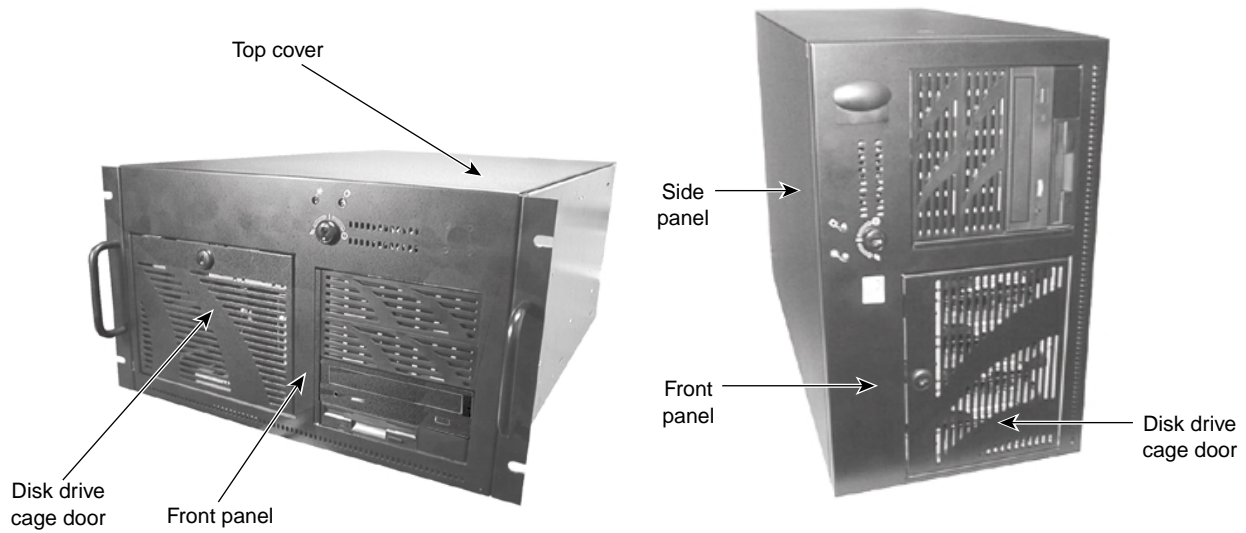

**Figure 7-1** Front Panel Access Points

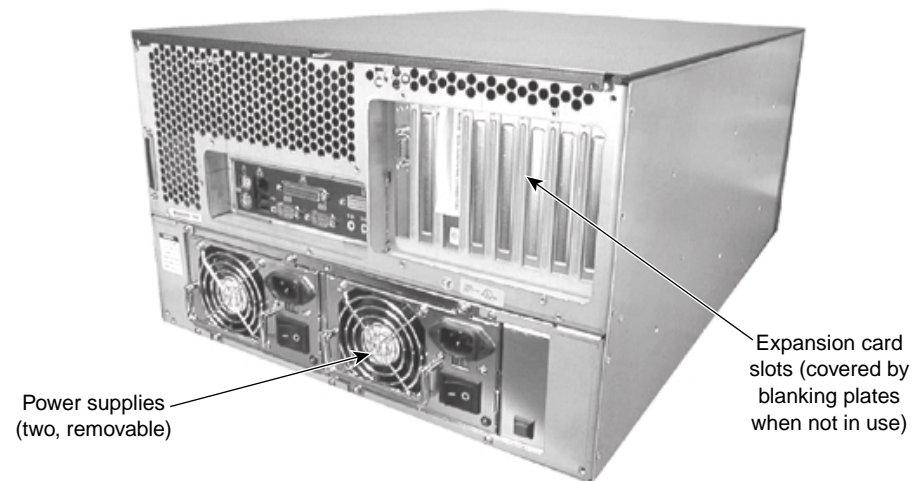

**Figure 7-2** Rear Panel Access Points

## Removing and Replacing the Top Cover

---

**Warning:** The system is always on when connected to AC power and the power supplies are switched on. Before opening the system, switch off both power supplies.

---

---

**Warning:** Replace the top cover/side panel before operating the system. This ensures proper airflow for cooling and reduces electromagnetic interference (EMI) emissions.

---

---

**Caution:** Ensure the stabilizers for the equipment rack are fully extended.

---

The top cover (rackmount system) or side panel (deskside system) allows access to most of the internal components.

To remove the top cover/side panel:

1. On a deskside system, lay the base unit on its right side.
2. On a rackmount system, disconnect all cables from the back of the unit.
3. On a rackmount system, at the front of the base unit, remove the screws that secure the handle brackets to the equipment rack mounting rails.
4. On a rackmount system, slide the base unit out of the equipment rack until it locks in the extended position.
5. At the back of the base unit, remove the screws that secure the top cover/side panel to the base unit.
6. Slide the top cover/side panel back and lift it off the base unit.

To replace the top cover/side panel:

1. Replace the top cover/side panel on the base unit and slide it forward until it is firmly seated.
2. On a rackmount system, slide the base unit into the equipment rack until it locks in the retracted position.

3. On a rackmount system, secure the handle brackets to the equipment rack mounting rails with the screws removed previously.
4. Secure the top cover to the base unit with the screws removed previously.
5. On a rackmount system, reconnect all cables to the back of the system.
6. On a deskside system, return the base unit to its upright position.

## Removing and Replacing the Front Panel

---

**Warning:** The system is always on when connected to AC power and the power supplies are switched on. Before opening the system, switch off both power supplies.

---

---

**Warning:** Replace the front panel before operating the system. This ensures proper airflow for cooling.

---

To remove the front panel:

1. On a rackmount system, disconnect all cables from the back of the unit.
2. On a rackmount system, at the front of the base unit, remove the screws that secure the handle brackets to the equipment rack mounting rails.
3. On a rackmount system, pull the base unit out of the equipment rack until it locks in the extended position.
4. Open the disk drive cage door.
5. Remove the screws that secure the handle brackets (on a rackmount system) and the front panel to the sides of the base unit, and then remove the handle brackets.
6. Pull the front panel away from the base unit.

---

**Caution:** Make sure you have slack in the wires connected to the Power keyswitch before pulling the front panel away from the base unit.

---

To replace the front panel:

1. With the disk drive cage door open, push the front panel onto the base unit.

---

**Caution:** Make sure you do not catch or crimp the wires connected to the Power switch and the LEDs when pushing the front panel onto the base unit.

---

2. Close the disk drive cage door.
3. On a rackmount system, holding the handle brackets in place, secure the brackets and the front panel to the sides of the base unit with the screws removed previously.
4. On a deskside system, secure the front panel to the sides of the base unit with the screws removed previously.
5. On a rackmount system, push the base unit into the equipment rack until it locks in the retracted position.
6. On a rackmount system, secure the base unit handle brackets to the equipment rack mounting rails with the screws removed previously.
7. On a rackmount system, reconnect all cables to the back of the system.

## Internal System Components

Figure 7-3 shows the system's major internal components.

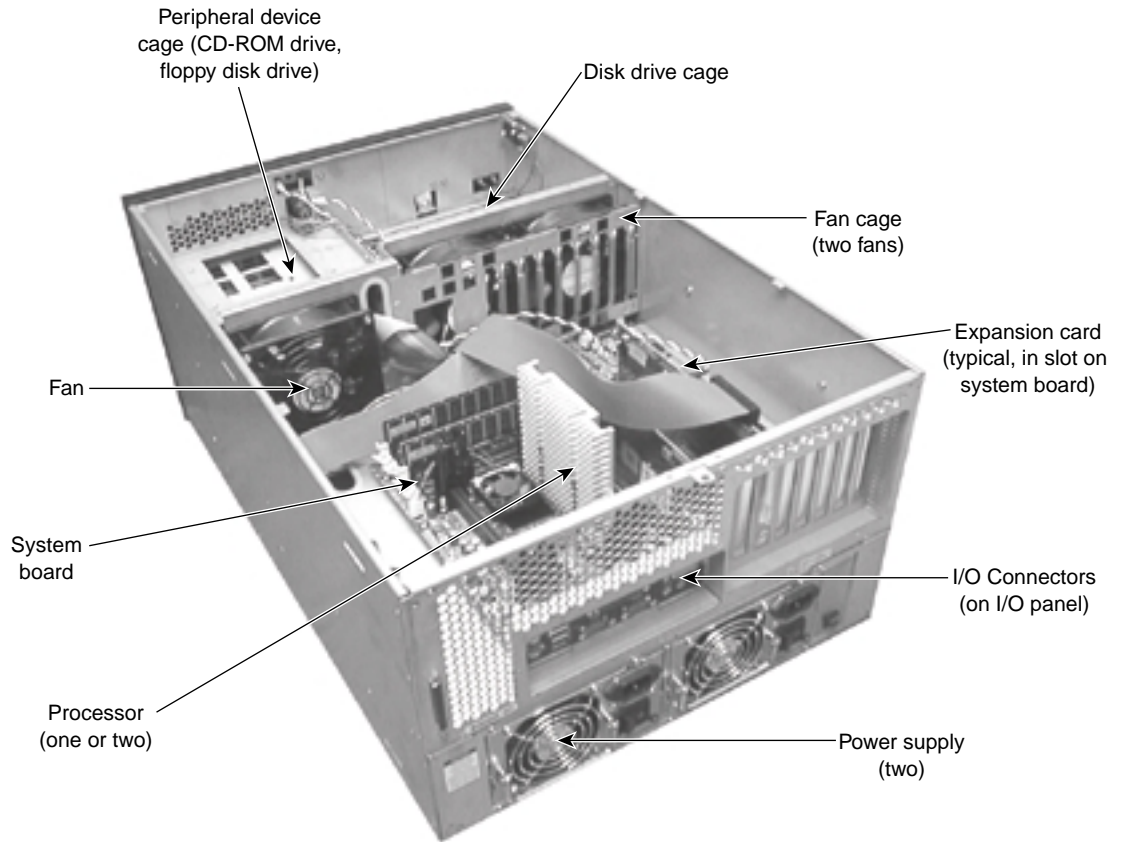

**Figure 7-3** Internal System Components



## Upgrading the System

This chapter describes how to upgrade your system by adding or replacing system components.

---

**Warning:** This is a user-serviceable system. Service and upgrade tasks should be performed by users who can follow instructions in a manual to service equipment, and can do so without harm to themselves or damage to the equipment.

---

### Before You Begin

---

**Warning:** The system is always on when connected to AC power and the power supplies are switched on. Before opening the system, switch off both power supplies

---

---

**Warning:** Internal components may be at high temperatures. Allow time for them to cool before handling them.

---

---

**Warning:** Internal components can be damaged by static electricity. Use an antistatic wrist strap connected to the bare metal of the system's chassis to protect against electrostatic discharge.

---

---

**Note:** “Right side” and “left side” are as seen from the front of the system.

---

See Chapter 7, “Gaining Access to System Components” for details on opening the system and protecting against electrostatic discharge.

## Adding Expansion Cards

You can install Accelerated Graphics Port (AGP), Peripheral Component Interconnect (PCI), non-compliant PCI, Industry Standard Architecture (ISA), and Plug-n-Play (PnP) expansion cards in the system. See below for a general description of these types of cards.

- AGP cards are graphics controllers that use the dedicated AGP interface for graphics acceleration. AGP cards contain configuration registers that define resource information to the system during startup. AGP cards do not require manual system configuration when installing the card. The system's BIOS detects the board's presence during startup and reads information from the board's configuration registers to assign the necessary system resources.
- PCI cards contain configuration registers that define resource information to the system during startup. PCI cards do not require manual system configuration when installing the card. The system's BIOS detects the board's presence during startup and reads information from the board's configuration registers to assign the necessary system resources.
- Non-compliant PCI cards do not contain configuration registers that allow the system to automatically assign the necessary resources. These cards install in PCI slots, but you must configure the system's BIOS to assign system resources before installing the card.
- Non-PnP ISA cards do not contain registers that define the resource information to the system during startup. Therefore, you must configure the system's BIOS to define the card to the system before installing the ISA card. This reserves system resources for the card.
- PnP cards are ISA cards that contain configuration registers like PCI cards. During startup, the system's BIOS automatically detects the installed card and assigns the necessary system resources. Since a PnP card is ISA-based, you install it in an ISA slot.

Each installed PCI card must draw less than 25 watts of power. The total allowable maximum wattage for PCI cards is 150 watts.



## Identifying Expansion Card Slots

The system board has seven expansion card slots, located at the lower-left corner of the system board. Slot 7 is a shared slot; you can install a PCI card or an ISA card in this slot, but not both.

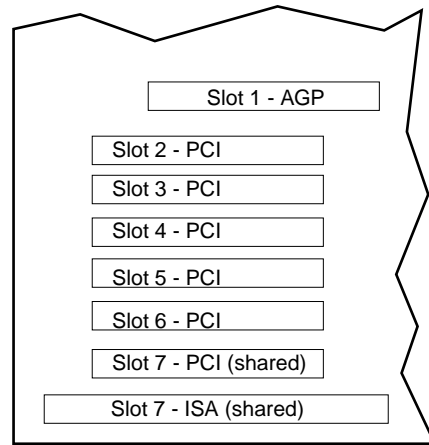

**Figure 8-1** Expansion Card Slots

Note the following:

- Slot 1 is for AGP Pro expansion cards.
- Slots 2, 3, 4, and 7 are for 33 MHz (5 V or Universal) PCI expansion cards.
- Slots 5 and 6 are for 66 MHz (3.3 V or Universal) PCI expansion cards. These slots can be used for 33 MHz PCI expansion cards if needed.
- Slot 7 is a shared PCI/ISA slot. This slot can hold either an ISA expansion card or a 33 MHz (5 V or Universal) PCI expansion card.

See the *System Board Guide* for detailed information on the system board's expansion slots.

## Installing an Expansion Card

See the documentation that came with the card for details on installation, configuration, cable connections, and operation.

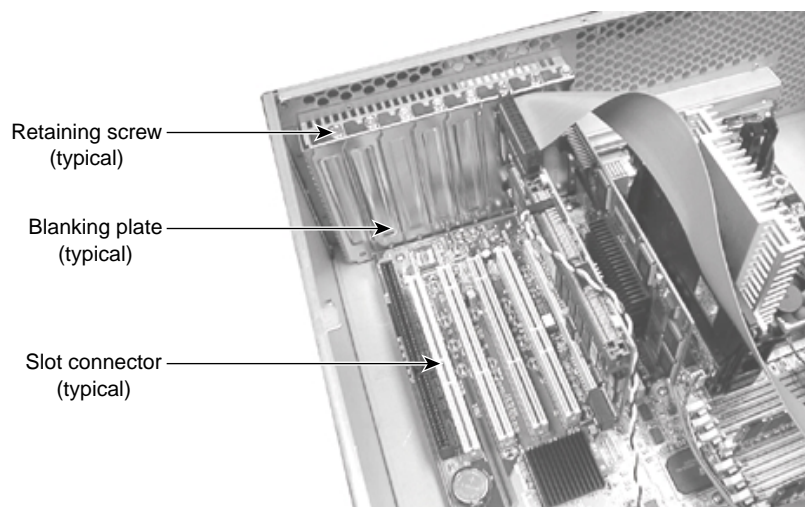

**Figure 8-2** Expansion Slot Locations

To install an expansion card:

---

**Warning:** The system is always on when connected to AC power and the power supplies are switched on. Before opening the system, switch off both power supplies.

---

1. Remove the top cover/side panel. See Chapter 7, “Gaining Access to System Components”.
2. Remove the blanking plate from an open slot on the back of the base unit. If there are no open slots and you want to replace an existing expansion card, see Chapter 9, “Servicing the System” for instructions.

---

**Caution:** Ensure that you cover an open slot with a blanking plate to ensure proper airflow for cooling and to reduce electromagnetic interference (EMI) emissions.

---

3. Slide the expansion card carefully into the card guides. Ensure that the connectors on the board's edge are aligned properly with the socket.
4. Push the card into the socket firmly and evenly until it is fully seated.
5. Secure the card to the card guide with a retaining screw (6-32 x 0.25 hex head).
6. Attach any required cables to internal or external connectors.
7. Replace the top cover/side panel. See Chapter 7, "Gaining Access to System Components".

## Assigning System Resources

Some expansion cards include a configuration diskette that you can use to reserve the system resources required for the card. Other expansion cards do not include a diskette, but require that you manually program the BIOS with the configuration information.

See the *System Board Guide* for details on using BIOS Setup to assign system resources and configure the BIOS for expansion cards.

## Disabling On-Board Controllers

You may need to disable the on-board audio, networking, or SCSI controllers to use an expansion card for these functions. You can disable these on-board functions using the BIOS Setup program.

See the *System Board Guide* for details on using BIOS Setup to disable the on-board controllers.

## Adding External SCSI Peripheral Devices

The system has a dual-channel low-voltage differential (LVD) SCSI controller integrated on the system board. Depending on your system configuration, you can connect Ultra, Ultra2, or Ultra3 SCSI peripheral devices to the SCSI port on the back of the base unit, and these devices will operate at their respective transfer rates. The SCSI port connects to Channel A of the SCSI controller. See Chapter 1, "Setting Up the Hardware" to locate the SCSI port.

---

**Caution:** On a JBOD system, if no external SCSI peripheral devices are connected to the SCSI port, connect a terminator module to the port.

---

## Choosing SCSI Cables

For each SCSI bus, the type of bus and the data clock speed of the fastest device on that bus determines its maximum length. Knowing this, you can determine the maximum cable length you can use to connect external SCSI devices to the system.

The following table provides a guide to maximum SCSI bus length. Note that bus width (for example, Narrow versus Wide) does not affect the maximum bus length.

**Table 8-1** Maximum SCSI bus length

SCSI Bus	Single-Ended Bus	Differential Bus	LVD Bus
Ultra (8 bits, 20 MB/sec)	4.9 ft / 1.5 m	39.4 ft / 12 m	39.4 ft / 12 m
Wide Ultra (16 bits, 40 MB/sec)	Not recommended	Not specified	39.4 ft / 12 m
Ultra2 (16 bits, 80 MB/sec)	Not recommended	Not specified	39.4 ft / 12 m
Ultra3 (16 bits, 160 MB/sec)	Not recommended	Not specified	39.4 ft / 12 m

The total cable length on the system's SCSI bus is the sum of the following:

- RAID system internal SCSI cables – 113 in (287 cm)
- JBOD system internal SCSI cables – 112 in (284 cm)
- SCSI cable between the system and the first external device
- SCSI cables between additional external devices
- SCSI cable inside each device connected to the cable – typically 8 inches (0.2 meters) or less

To ensure data integrity and optimum performance, do the following:

- Use the shortest cables possible to connect SCSI devices to the system and to each other.

- Use high-quality SCSI cables to ensure adequate shielding (impedance of 110 to 135 ohms).

---

**Caution:** When handling cables, flex them as little as possible. Ensure that cables do not contact sharp metal surfaces or become excessively bent or twisted. In particular, SCSI cables should not have any creased bends.

---

## Choosing SCSI IDs

To determine the ID of each SCSI device on the system, restart the system. When the BIOS screen displays, look for a list of SCSI devices and write down the ID for each device.

By default, some SCSI IDs are already used by system devices:

- The primary system disk drive uses SCSI ID 0
- The SCSI controller uses SCSI ID 7

See the vendor documentation for details on setting a device's SCSI ID.

## Terminating SCSI Devices

When connecting devices to the SCSI port:

- **Enable** termination on the last external device on the SCSI cable chain. Use an active terminator.
- **Disable** termination on all other external devices on the SCSI cable chain.

## Connecting SCSI Devices

To connect external SCSI devices:

1. If the system is connected to AC power and operating, shut down the system and unplug the system power cord from its AC power outlet.
2. If a terminator module is connected to the SCSI port on the system, remove it.

3. Connect one end of a SCSI cable to the SCSI port on the system.
4. Connect the other end of the SCSI cable to a SCSI peripheral device.
5. Connect a SCSI cable between SCSI ports on any additional SCSI peripheral devices.
6. Set the SCSI ID of **each** peripheral device to a **unique** SCSI ID number. Do not use any SCSI ID numbers already used by the system on that port or channel.
7. For each SCSI peripheral device connected to the port, if the device is:
  - The last or only device on the SCSI chain, **enable** SCSI termination
  - **Not** the last or only device on the SCSI chain, **disable** or **remove** SCSI termination
8. Ensure that the power switch on each peripheral device is in the off position; then connect the power cord from each peripheral device to an AC power outlet.
9. Turn on power to all connected SCSI peripheral devices, and then start the system.
10. If necessary, install software drivers and configure the peripheral devices according to the vendor's instructions.

## Changing SCSI Controller or Device Settings

You may need to use the SCSI Configuration Utility to configure the operation of SCSI peripheral devices connected to the integrated SCSI controller. This utility enables you to configure SCSI controller, perform a low-level format on a SCSI hard disk drive, select boot order, and verify media.

You may need to change SCSI controller parameters for a device under the following conditions:

- If you are advised to do so by technical support or instructed to do so by the vendor documentation supplied with the SCSI device.
- If the SCSI device does not negotiate properly with the controller.
- If you exceed the recommended total cable length for connecting SCSI devices to the system.
- If you connect non-Ultra SCSI external devices to the system.

For information on using the SCSI Configuration Utility, see Chapter 3, "Configuring the System".

## Adding Internal Peripheral Devices

A CD-ROM drive and a floppy disk drive are installed in the peripheral device cage at the front of the base unit. The cage can hold up to two additional EIDE or SCSI peripheral devices. In some systems, a bracket above the peripheral device cage can hold a SCSI disk drive. The following table describes the devices in and above the peripheral device cage:

**Table 8-2** Peripheral Device Bays

Location	Access	Device	Device Size	Bus
Bay 1 (Top)	Internal, External	Various	5.25-in x 1.6-in or 3.5-in x 1.0 in	EIDE (Either) or SCSI
Bay 2	Internal, External	Various	5.25-in x 1.6-in or 3.5-in x 1.0 in	EIDE (Either) or SCSI
Bay 3	External	CD-ROM drive	5.25-in x 1.6-in	EIDE (Primary)
Bay 4 (Bottom)	External	Floppy disk drive	3.50-in x 1.0-in	N/A
Above the cage	Internal	Disk drive	3.50-in x 1.0-in	SCSI

In a RAID system, up to four removable low-voltage differential (LVD) SCSI disk drives may be installed in slots in the disk drive cage at the front of the base unit. One of these disk drives (Drive 0) is the system's primary system disk drive. A RAID controller card manages these disk drives.

In a JBOD ("just a bunch of disks") system, up to four LVD SCSI disk drives may be installed in bays in the disk drive cage at the front of the base unit. A dual-channel LVD SCSI controller on the system board manages these disk drives.

The EIDE controller on the system board manages internal EIDE peripheral devices. Two EIDE devices can connect to each of the primary and secondary EIDE channels. The CD-ROM drive connects to the primary EIDE channel as a master device. The cable for the CD-ROM drive can connect to a second (slave) EIDE device in the peripheral device cage. Another cable can be used to connect to a third EIDE device in the peripheral device cage.

The SCSI controller on the system board manages internal and external SCSI peripheral devices. External SCSI devices connect to SCSI Channel A via the SCSI port on the back of the base unit. Internal devices connect to SCSI Channel A and/or SCSI Channel B,

depending on system configuration. Ultra, Ultra2, and Ultra3 SCSI peripheral devices operate at their respective transfer rates.

For more information:

- On how to replace or add an internal peripheral device, see Chapter 9, “Servicing the System”.
- On internal cabling for peripheral devices, see Chapter 10, “System Hardware and Specifications”.
- On SCSI IDs, termination, buses, and the SCSI controller, see “Adding External SCSI Peripheral Devices” on page 85 in this chapter.
- On device power and data connections to the system board, see the *System Board Guide*.

Have the vendor’s documentation available to follow instructions for setting the SCSI ID, enabling or disabling termination, installing device drivers when required, and configuring other device attributes.

If you are installing an internal peripheral device that connects to an expansion card, see the vendor’s documentation for information on installing the expansion card and any required cables.

## Adding Memory

You can add system memory by installing or replacing dual inline memory modules (DIMMs) in the system board’s DIMM sockets. For more information:

- On how to add or replace a DIMM, see Chapter 9, “Servicing the System”.
- On DIMMs, DIMM socket locations, and system memory configurations, see the *System Board Guide*.



## Upgrading Processors

You can upgrade a single-processor system by installing another processor. As higher-speed processors become available, you can upgrade one- or two-processor systems by replacing the existing processors with faster processors. For more information:

- On how to add or replace a processor, see Chapter 9, “Servicing the System”
- On processors and processor socket locations, see the *System Board Guide*.



## Servicing the System

This chapter describes how to replace the major components of your system.

---

**Warning:** This is a user-serviceable system. Service and upgrade tasks should be performed by users who can follow instructions in a manual to service equipment, and can do so without harm to themselves or damage to the equipment.

---

### Before You Begin

---

**Warning:** The system is always on when connected to AC power and the power supplies are switched on. Before opening the system, switch off both power supplies.

---

---

**Warning:** Internal components may be at high temperatures. Allow time for them to cool before handling them.

---

---

**Warning:** Internal components can be damaged by static electricity. Use an antistatic wrist strap connected to the bare metal of the system's chassis to protect against electrostatic discharge.

---

---

**Note:** “Right side” and “left side” are as seen from the front of the system.

---

See Chapter 7, “Gaining Access to System Components” for details on opening the system and protecting against electrostatic discharge.

## Removable Disk Drive

In a RAID system, up to four removable SCA SCSI disk drives may be installed in slots in the disk drive cage at the front of the base unit. The disk drives slide into and out of the disk drive cage, and each disk drive is secured with two latch clips.

To replace a removable disk drive:

---

**Warning:** The system is always on when connected to AC power and the power supplies are switched on. Before opening the system, switch off both power supplies.

---

---

**Warning:** Mishandling a removed disk drive can cause the heads to crash! Subsequent failures may not be noticeable for three to six months. Handle disk drives carefully to avoid damage.

---

1. Open the disk drive cage door.
2. Flip the disk drive's latch clips outward to disengage the disk drive. Wait 30 seconds for the disk drive to spin down and park its heads.

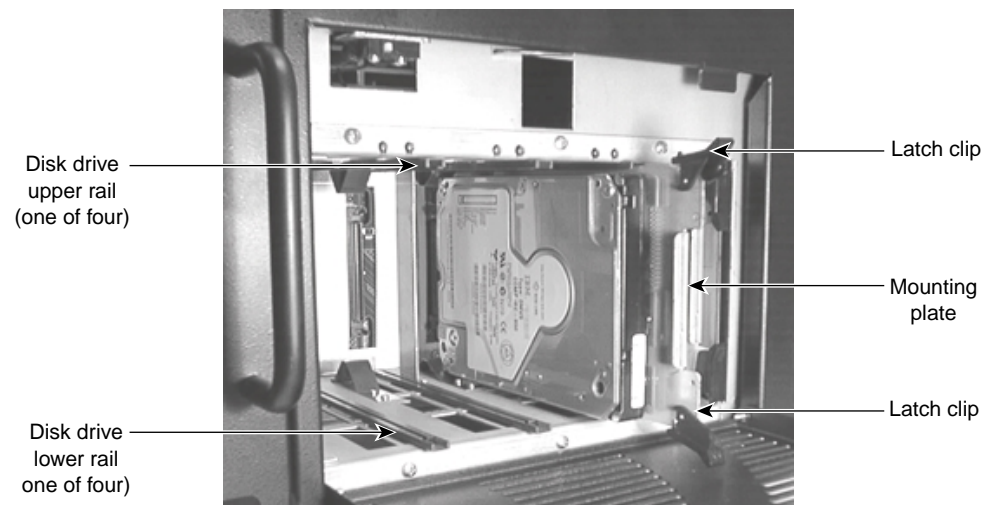

**Figure 9-1** Interior of the Disk Drive Cage

3. Carefully pull the disk drive out of the disk drive cage.
4. Label the new disk drive with the same ADP, CH, and ID numbers used on the replaced drive, as appropriate.
5. If the new disk drive does not have a mounting plate with latch clips, remove the mounting plate from the removed disk drive. Secure the mounting plate to the bottom (circuit board side) of the new disk drive with the screws you removed previously.

---

**Warning:** Removing and attaching the drive mounting plate requires careful handling to avoid contact with the delicate, electrostatic-sensitive parts on the circuit board of the disk drive. Handle disk drives carefully to prevent failure and voiding the warranty for the drives.

---

6. Extend the latch clips on the new disk drive and align the edges of the drive mounting plate with the upper and lower rails from which you removed the previous disk drive. The drive mounting plate faces left.
7. Push the mounting plate at the center between the latch clips until the disk drive slides all the way onto the rails and firmly engages its connector. The latch clips rotate closed as you push the disk drive onto the rails.
8. Close the disk drive cage door.

## JBOD Disk Drive Device Cage

In a JBOD ("just a bunch of disks") system, up to four 3.5-inch x 1.0-inch SCSI disk drives may be installed in bays in the disk drive cage at the front of the base unit. To add, remove, or replace disk drives, you must first remove the disk drive cage.

To add, remove, or replace a disk drive in the disk drive cage:

---

**Warning:** The system is always on when connected to AC power. Before performing this task, disconnect the system's power cord from its AC power outlet.

---

**Warning:** Mishandling a disk drive can cause the heads to crash! Subsequent failures may not be noticeable for three to six months. Handle disk drives carefully to avoid damage.

---

1. Remove the top cover/side panel. See Chapter 7, “Gaining Access to System Components”.
2. Open the disk drive cage door on the front panel.
3. Remove the screws securing the disk drive cage to the base unit. Use a screwdriver with a long, thin shaft to reach the bottom screws. See the following figure.

**Caution:** Do not drop the screws into the chassis, as they may be difficult to retrieve.

---

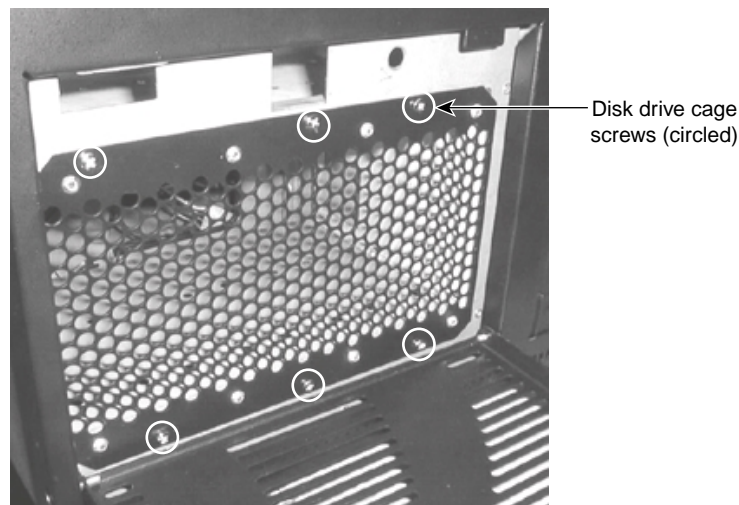

**Figure 9-2** JBOD Disk Drive Cage Installed

4. Pull the cage halfway out the front of the base unit.
5. Remove the power cables and data cables from any installed disk drives. Note the location of each set of cables so you can replace them later.
6. Pull the cage completely out the front of the base unit.

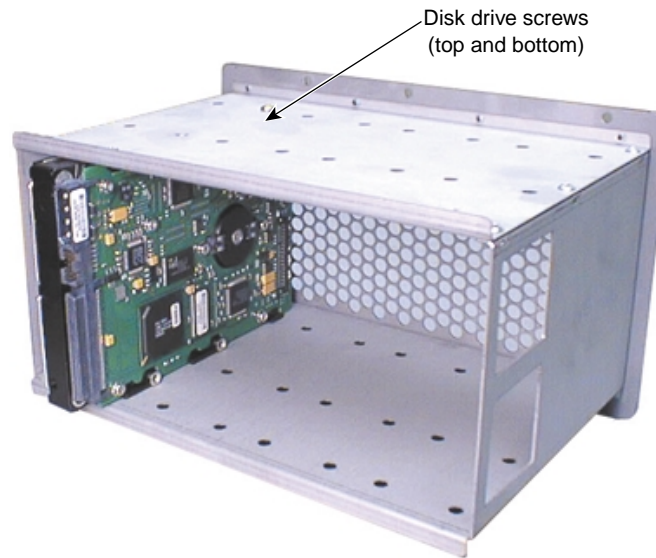
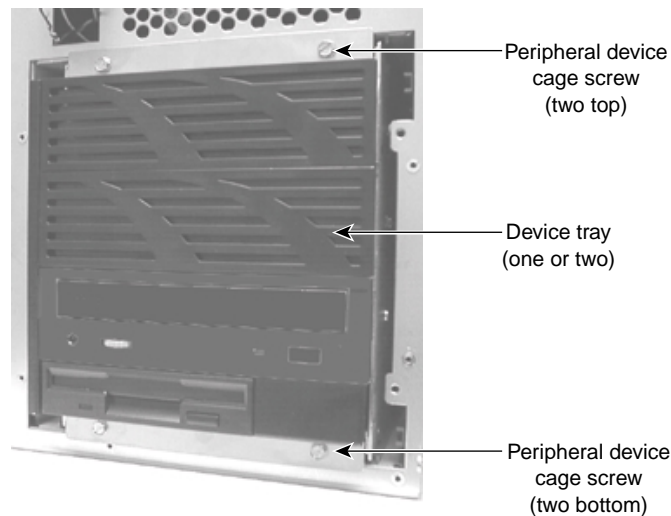

**Figure 9-3** JBOD Disk Drive Cage

7. If removing or replacing a disk drive, remove the screws securing the drive to the cage, and then remove the drive from the cage.
8. If adding or replacing a disk drive, insert the drive in the cage and secure it with screws on both top and bottom. Make sure the drive's power and data connections face the open side of the cage.
9. Set device IDs and other settings as needed on the new drive. See the label on the drive for more information.
10. Replace the cage halfway into the base unit.
11. Connect the power cables and data cables to any installed disk drives.
12. Replace the cage completely in the base unit.
13. Secure the cage to the base unit with the screws removed previously.
14. Close the disk drive cage door on the front panel.
15. Replace the top cover/side panel. See Chapter 7, "Gaining Access to System Components".

## Peripheral Device Cage

The CD-ROM drive, the floppy disk drive, and (optionally) two EIDE or SCSI peripheral devices are located in the peripheral device cage at the front of the base unit. On some systems, a SCSI device (3.5-inch x 1.0-inch or 3.5-inch x 1.6-inch) is mounted above the peripheral device cage. You can remove and replace these devices, and add a device if a bay is open, in the same way.



**Figure 9-4** Peripheral Device Cage Installed

To add or replace a device in the peripheral device cage:

---

**Warning:** The system is always on when connected to AC power and the power supplies are switched on. Before opening the system, switch off both power supplies.

---

---

**Warning:** The CD-ROM drive contains a laser and is classified as a Class 1 Laser Product. To prevent direct exposure to the laser beam and to avoid hazardous radiation exposure, do not try to open the CD-ROM drive enclosure. Return the drive to the manufacturer for repair.

---



---

**Warning:** Mishandling a removed disk drive can cause the heads to crash! Subsequent failures may not be noticeable for three to six months. Handle disk drives carefully to avoid damage.

---

1. Remove the top cover/side panel and the front panel. See Chapter 7, “Gaining Access to System Components”.
2. Remove the screws securing the peripheral device cage to the base unit.
3. Disconnect the power cables and data cables from the devices in the cage. You cannot reach the cables for the floppy disk drive.
4. Pull the cage out of the base unit, carefully guiding the floppy disk drive cables through the bulkhead opening behind the cage.

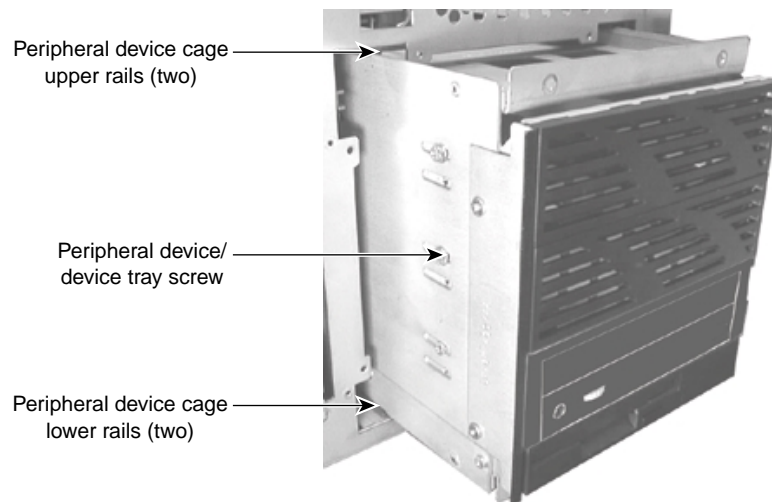

**Figure 9-5** Removing or Replacing Peripheral Device Cage

5. Disconnect the power cable and data cable from the floppy disk drive.

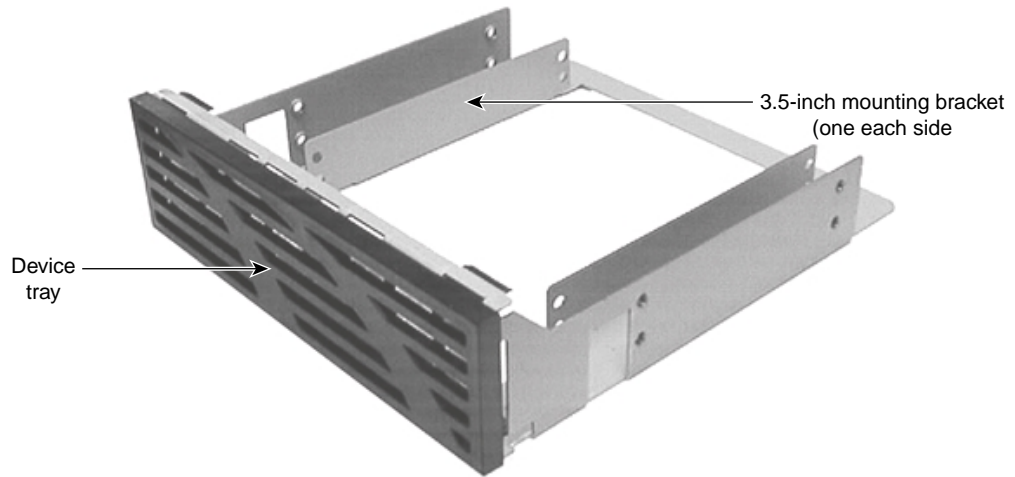

**Figure 9-6** Device Tray

6. To remove a device:
  - For a 3.5-inch x 1.0-inch device, remove the screws securing the device tray to the cage and pull the tray out of the cage. Then remove the screws securing the device to the tray and remove the device from the tray.
  - For a 5.25-inch x 1.6-inch device or the floppy disk drive, remove the screws securing the device to the cage and pull the device out of the cage. (Two of the screws for the floppy disk drive are on the bottom of the cage.)
7. When adding or replacing a device, set the device ID and other jumper settings as needed on the new device. When replacing a device, match the jumper settings on the new device to those on the replaced device. See the label on the device and Chapter 8, “Upgrading the System” for more information on bus identification and jumper settings.
8. To add or replace a device:
  - For a new 3.5-inch x 1.0-inch device, remove the screws securing a device tray to the cage and pull the tray out of the cage.
  - For a 3.5-inch x 1.0-inch device, secure the device to the mounting brackets in the tray with screws on each side. Make sure the device’s power and data connections face the open side of the tray. Then replace the tray in the cage and secure the tray to the cage with screws on each side.

- For a 5.25-inch x 1.6-inch device or the floppy disk drive, place the device in the cage and secure the device to the cage with screws on each side.
9. Connect the power cable and data cable to the floppy disk drive.
  10. Align the top and bottom of the cage with the upper and lower rails in the base unit, and push the cage into the base unit, carefully guiding the floppy disk drive cables through the bulkhead opening behind the cage.
  11. Connect the power cables and data cables to the other devices in the cage.
  12. Secure the peripheral device cage to the base unit with the screws removed previously.
  13. Replace the front panel and the top cover/side panel. See Chapter 7, “Gaining Access to System Components”.

To add or replace a device above the peripheral device cage:

---

**Warning:** The system is always on when connected to AC power and the power supplies are switched on. Before opening the system, switch off both power supplies.

---

1. Remove the top cover/side panel. See Chapter 7, “Gaining Access to System Components”.
2. When replacing a device, disconnect the power cable and SCSI cable from the device.
3. When replacing a device, remove the screws from each side of the device and lift the device out of the base unit. See the following figure.
4. When replacing a device, remove the mounting brackets from the device.

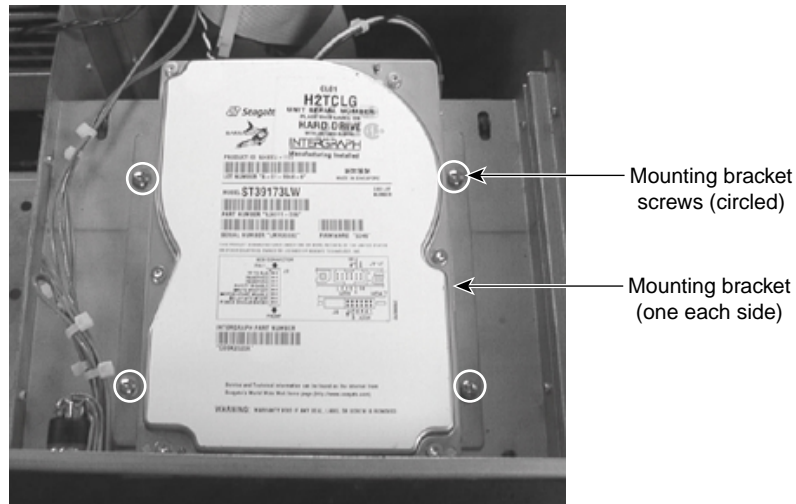

**Figure 9-7** Mounting Brackets

5. Secure the mounting brackets to the new device.
6. Replace the new device in the base unit and secure it with the screws removed previously.
7. Connect the power cable and SCSI cable to the new device.
8. Replace the top cover/side panel. See Chapter 7, “Gaining Access to System Components”.

## Expansion Card

The system board contains sockets in which expansion cards (such as the graphics controller card) are installed. See Chapter 8, “Upgrading the System” and the *System Board Guide* for more information on expansion cards and their sockets.

To avoid damaging an expansion card and voiding its warranty, take the following precautions:

- Handle the expansion card only by the edges. Do not touch the metallic finger contacts.
- Do not bend, twist, drop, or otherwise handle the expansion card carelessly.

- Do not expose the expansion card to moisture or extreme temperatures.
- Do not remove the expansion card from its antistatic package until you are ready to install it.

To replace an expansion card:

---

**Warning:** The system is always on when connected to AC power and the power supplies are switched on. Before opening the system, switch off both power supplies.

---

1. Remove the top cover/side panel. See Chapter 7, “Gaining Access to System Components”.
2. Disconnect any external and internal cables from the expansion card.

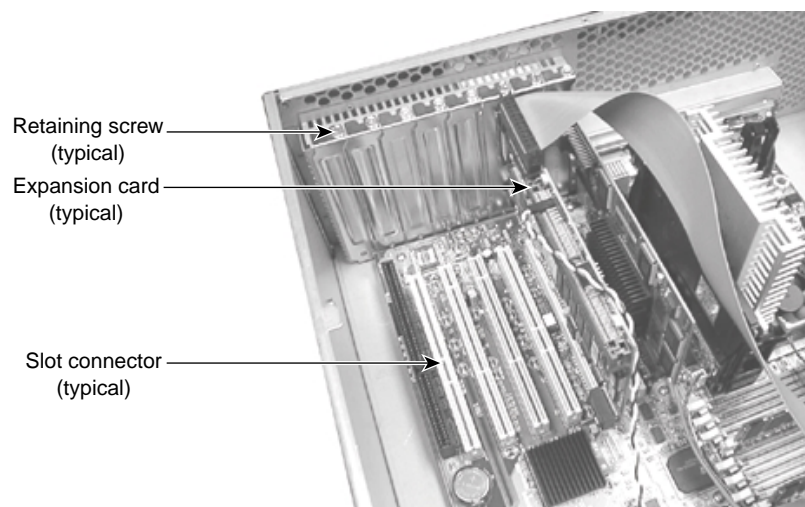

**Figure 9-8** Expansion Cards

3. Remove and retain the screw that secures the card to the left card guide.
4. Pull the card straight out of its socket, and place the card on an antistatic surface.
5. Remove the new card from its antistatic package and slide it into the socket from which you removed the old card. Push the new card into the socket until it is firmly seated.

6. Secure the new card to the card guide with the retaining screw (6-32 x 0.25 hex head) removed previously.
7. Connect any internal and external cables to the new card.
8. Replace the top cover/side panel. See Chapter 7, “Gaining Access to System Components”.

## Memory Module

The system board contains sockets for eight dual inline memory modules (DIMMs).

To avoid damaging a DIMM and voiding its warranty, take the following precautions:

- Do not touch the metallic finger contacts.
- Do not bend, twist, drop, or otherwise handle the DIMM carelessly.
- Do not expose the DIMM to moisture or extreme temperatures.
- Do not remove the DIMM from its antistatic package until you are ready to install it.

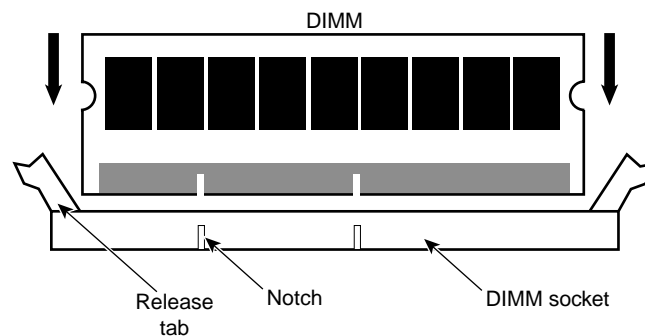

**Figure 9-9** Dual Inline Memory Module (DIMM)

To replace a DIMM:

---

**Warning:** The system is always on when connected to AC power and the power supplies are switched on. Before opening the system, switch off **both** power supplies.

---

1. Remove the top cover/side panel. See Chapter 7, “Gaining Access to System Components”.
2. If replacing a DIMM, press the DIMM socket release tabs outward, away from each other; then grasp the top edge of the DIMM and pull it out of the socket.
3. Remove the new DIMM from its antistatic package. Verify the DIMM has gold-plated fingers that match the gold-plated socket contacts, and the slot keys on the DIMM match the slot keys in the DIMM socket.
4. Orient the DIMM so that the notches match the keys in the socket.
5. Push gently straight down until the release tabs snap into place.
6. Restart the system for the BIOS to detect the new memory.
7. Replace the top cover/side panel. See Chapter 7, “Gaining Access to System Components”.

For more information on DIMMs, DIMM sockets, and system memory configurations, see the *System Board Guide*.

## Processor Bus Terminator

On a system with only one processor, a processor bus terminator occupies the other processor slot on the system board. This module ensures proper termination for the processor bus; without it, the system will not function. When you add a second processor, you must remove this module and replace it with the new processor.

---

**Warning:** The system is always on when connected to AC power and the power supplies are switched on. Before opening the system, switch off both power supplies.

---

1. Remove the top cover/side panel. See Chapter 7, “Gaining Access to System Components”.
2. Carefully pull the terminator card out of the processor slot.
3. Replace the top cover/side panel. See Chapter 7, “Gaining Access to System Components”.

For more information on the processor bus terminator, see the *System Board Guide*.

## Processor Module

The system board contains sockets for two processor modules. Each processor module is secured to the system board with retention clips.

To replace a processor module:

---

**Warning:** The system is always on when connected to AC power and the power supplies are switched on. Before opening the system, switch off both power supplies.

---

1. Pull the locking tabs on the retention clips outward, and slide the processor module out of the retention clips and its slot.
2. Remove the new processor from its antistatic package, and align the processor module over the retention clips and the slot. The processor module is keyed and fits only one way.
3. Press the processor module down until it seats in the slot and the locking tabs on the retention clips click into place.

For more information on processors and processor socket locations, see the *System Board Guide*.

## RAID Disk Drive Cage

The RAID disk drive cage is located at the front of the base unit, behind a lockable door. The cage assembly is replaced as a single unit.

To replace the RAID disk drive cage:

---

**Warning:** The system is always on when connected to AC power and the power supplies are switched on. Before opening the system, switch off both power supplies.

---

1. Open the disk drive cage door.
2. Remove all disk drives from the disk drive cage as described previously. Note the original location of each disk drive to ensure their correct replacement later.



3. Remove the top cover/side panel and the front panel. See Chapter 7, “Gaining Access to System Components”.
4. Remove the screws that attach the front of the cage to the base unit. Support the cage as the last screw is removed. See Figure 9-10.

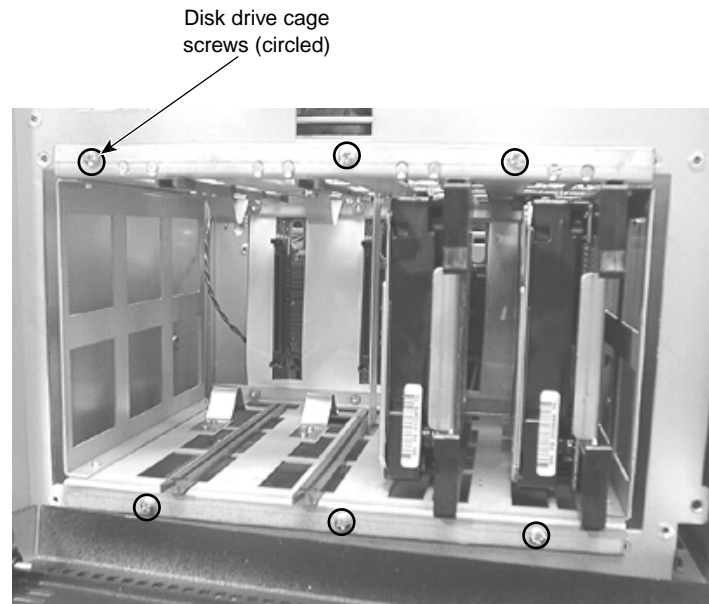

**Figure 9-10** Interior of RAID Disk Drive Cage

5. Gently pull the cage forward until it is partially out of the base unit.
6. Note the location of the SCSI cable and disconnect the SCSI cable from the back of the cage.
7. Disconnect the power cables attached to the cage, as shown in the following figure.

---

**Caution:** Do not pull on the wires of the power cables to remove them from their connectors, or damage to the cables will result.

---

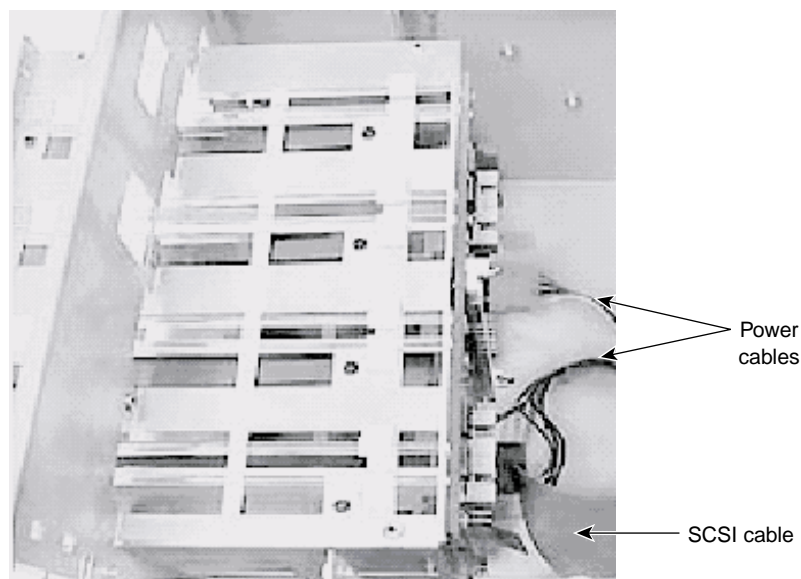

**Figure 9-11** Removing or Replacing the RAID Disk Drive Cage

8. Pull the cage the rest of the way out of the base unit.

---

**Caution:** Take care not to damage the printed circuit board on the back of the cage as you remove it from the base unit.

---

9. Verify that the jumper settings on the back of the new cage match those on the cage being replaced.

---

**Note:** When the cage is connected to a Mylex RAID controller, jumper connectors JP2 and JP3 must **not** have any jumpers installed.

---

10. If the cage being replaced has a SAF-TE card (as described in the next section), remove it from the cage being replaced and install it in the same location on the new cage.
11. Insert the new cage partially into the base unit.

12. Reconnect the SCSI cable and the power cables in the same positions from which you disconnected them previously.
13. Insert the new cage the rest of the way into the base unit.
14. Secure the cage to the base unit with the screws removed previously.
15. Replace the disk drives in the disk drive cage. Be sure to install the drives in the same locations from which you removed them.
16. Replace the front panel and the top cover/side panel. See Chapter 7, “Gaining Access to System Components”.

## RAID SAF-TE Card

The SCSI Activity Fault-Tolerant Enclosure (SAF-TE) card for the RAID disk drives is located on the back of the RAID disk drive cage.

To remove or replace the SAF-TE card:

1. Remove the disk drive cage as described previously.
2. Locate the SAF-TE card in the center of the back of the disk drive cage. See Figure 9-12.

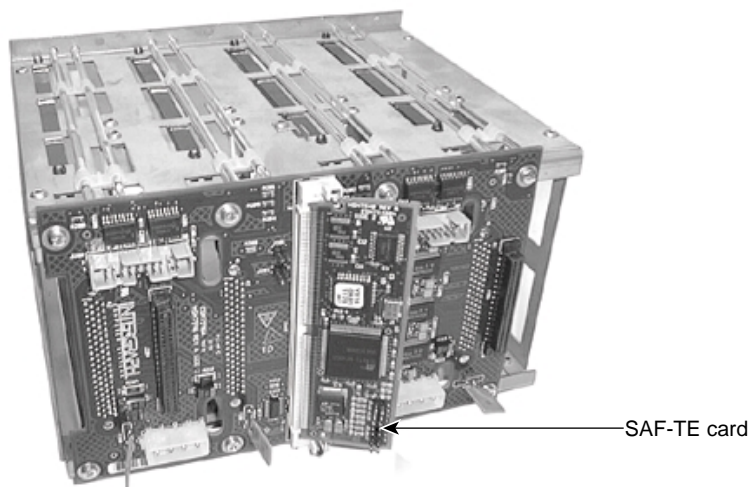

**Figure 9-12** The SAF-TE Card

3. Press the two mounting clips on the outside of the SAF-TE card mounting slot away from each other, and rotate the card to a vertical position and remove it from its slot.

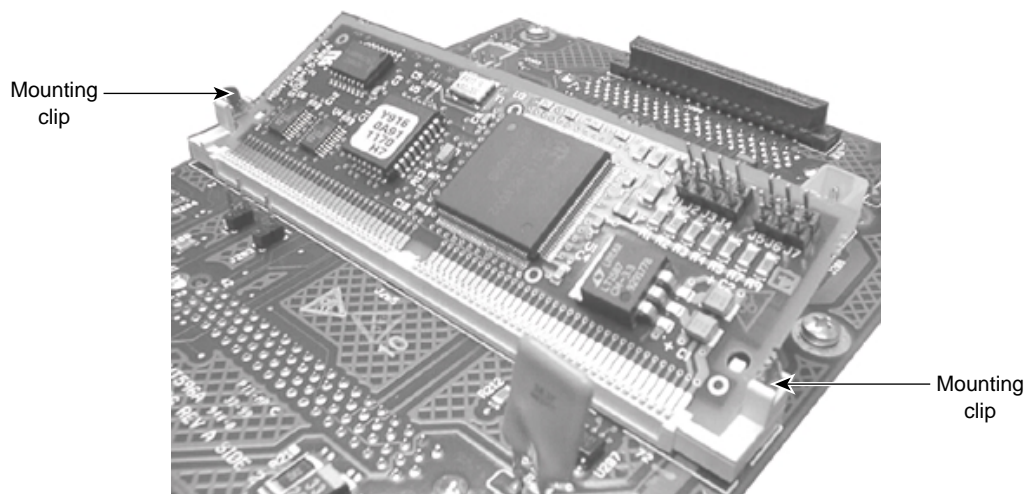

**Figure 9-13** Mounting Clips for SAF-TE Card

4. Place the new SAF-TE card vertically in its slot, and rotate the card toward the mounting clips until it snaps into place.

---

**Caution:** Do not apply much force when installing the SAF-TE card, or damage to the SAF-TE card or the disk drive cage may result.

---

5. Replace the disk drive cage as described previously.

## Power Supply

---

**Warning:** There are no user-serviceable parts in the power supply. Return the power supply to the manufacturer for repair.

---

---

**Caution:** The Power switches on the unit's two power supplies are the service disconnect. To remove AC power from the system, you must turn the Power switch on **both** power supplies to the `off (O)` position.

---

The system has two power supplies. Both must be connected to AC power for the system to operate correctly. However, if one power supply fails, you can replace it without shutting down the other power supply. This hot-swap capability lets you handle a power supply failure without shutting down and powering down the entire system.

When you connect the system's base unit to AC power and turn the Power switches on **both** power supplies to the `ON (|)` position, auxiliary power is applied to the system. Auxiliary power ensures that system components power up quickly when needed.

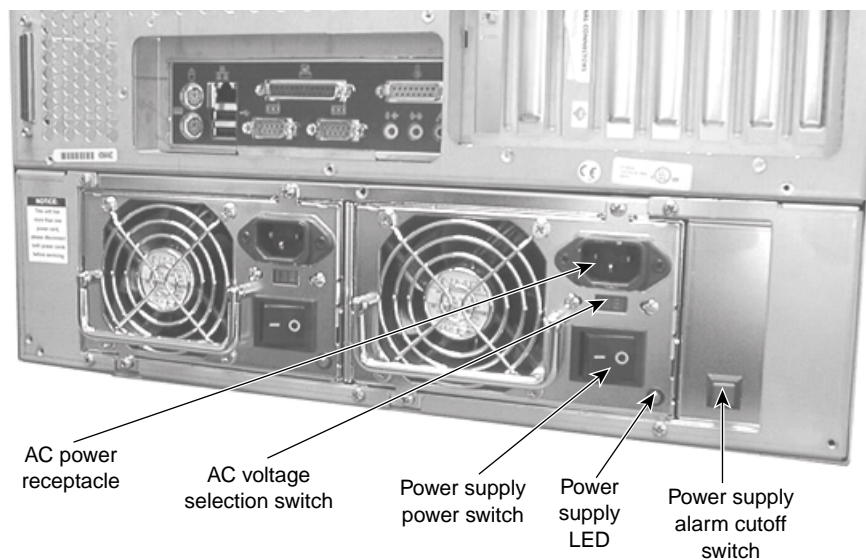

**Figure 9-14** The Power Supply

To replace a power supply:

---

**Warning:** The system is always on when connected to AC power and the power supplies are switched on. Before opening the system, switch off both power supplies.

---

1. Set the Power switches on **both** power supplies to the OFF ( O ) position.
2. Disconnect the AC power cords from the AC power receptacles of **both** power supplies.
3. Remove the screws securing the power supply to the back of the base unit.
4. Grasp the handle and pull the power supply out of the base unit.



**Figure 9-15** Removing or Replacing the Power Supply

---

**Caution:** Support the power supply as you remove it from the base unit. Do not let the power supply fall or damage to equipment may result.

---

5. Push the new power supply into the base unit until it seats in its connector.

---

**Caution:** Support the power supply as you replace it in the base unit. Do not let the power supply fall or damage to equipment may result.

---

6. Secure the power supply to the base unit with the screws removed previously.
7. Make sure the AC voltage selection switches on **both** power supplies are set to the proper line voltage for your location.
  - If your location uses 90 to 135 volts, the number **115** must be visible.
  - If your location uses 180 to 264 volts, the number **230** must be visible.

---

**Warning:** If you do not set the AC voltage selection switches on **both** power supplies correctly, equipment damage may occur when you connect the system to AC power.

---

8. Make sure the Power switches on **both** power supplies are set to the OFF ( O ) position.
9. Connect the system's power cords to the AC power receptacles on **both** power supplies.
10. Turn the Power switches on **both** power supplies to the ON ( | ) position. This applies auxiliary power to the system. The power supply LEDs light when the power supplies are operating.

For more information:

- On controlling system power, see Chapter 4, "Operating the System".
- On the power supply, see Chapter 10, "System Hardware and Specifications".

## Cooling Fans

A fan mounted behind the peripheral device cage and two fans mounted behind the disk drive cage provide airflow to cool system components in the base unit.

---

**Caution:** To maintain proper airflow to cool system components, make sure you install a new fan with the label on the fan motor facing toward the **back** of the base unit.

---



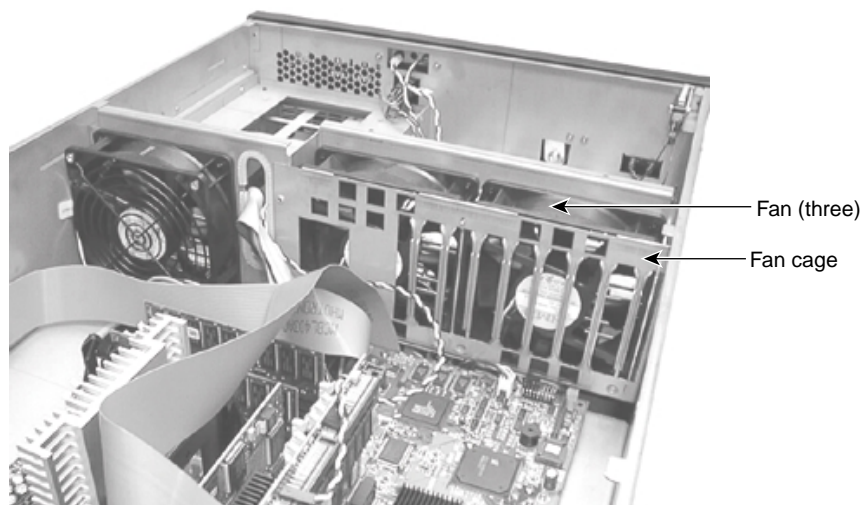

**Figure 9-16** The Cooling Fans

To replace a cooling fan:

---

**Warning:** The system is always on when connected to AC power and the power supplies are switched on. Before opening the system, switch off both power supplies.

---

1. Remove the top cover/side panel. See Chapter 7, “Gaining Access to System Components”.
2. Disconnect the fan’s cable from its connector on the system board.
3. Remove the snap rivets holding the fan to its bulkhead.
4. Remove the fan from the fan cage or from its bulkhead, carefully guiding the fan’s cable clear.
5. If replacing one of the fans in the fan cage, route the fan’s cable through the bottom of the cage and lower the fan into the cage. If replacing the other fan, route the fan’s cable under the fan and hold the fan against its bulkhead.
6. Replace the snap rivets removed previously to secure the new fan to its bulkhead.
7. Connect the fan’s cable to its connector on the system board.

8. Replace the top cover/side panel. See Chapter 7, “Gaining Access to System Components”.

A small fan mounted between the two processors provides additional cooling for components on this area of the system board.

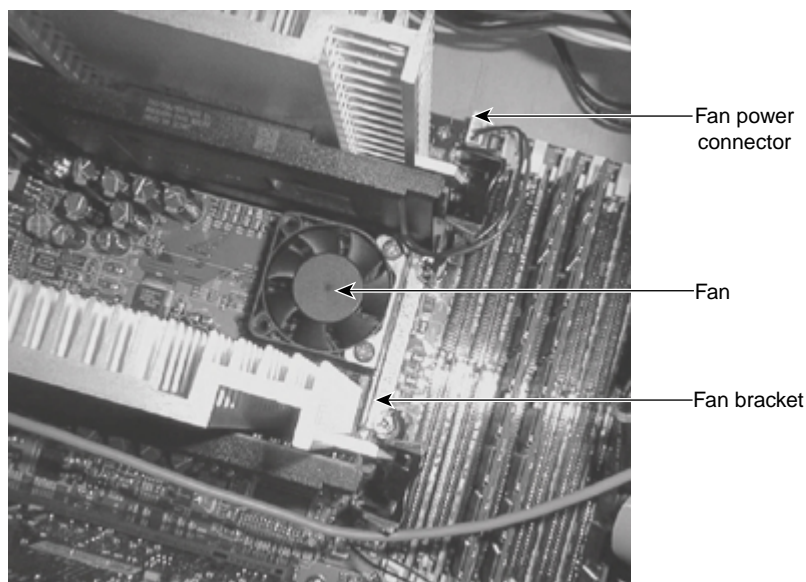

**Figure 9-17** Processor Area Cooling Fan

To replace the processor area cooling fan:

1. Remove the top cover/side panel. See Chapter 7, “Gaining Access to System Components”.
2. Disconnect the fan’s cable from its connector on the system board.
3. Remove the screws securing the fan to the fan bracket, and remove the fan.
4. Secure the new fan to the fan bracket using the screws removed previously.
5. Connect the fan’s cable to its connector on the system board.
6. Replace the top cover/side panel. See Chapter 7, “Gaining Access to System Components”.

**Caution:** The fan bracket is secured to the two processor retention clips with the nuts used to secure the retention clips to the system board. If you remove the fan bracket, make sure to remount it between the retention clips and the nuts, not between the retention clips and the system board.

---

## System Board

See previous procedures in this chapter when necessary. See the *System Board Guide* for connector and socket locations.

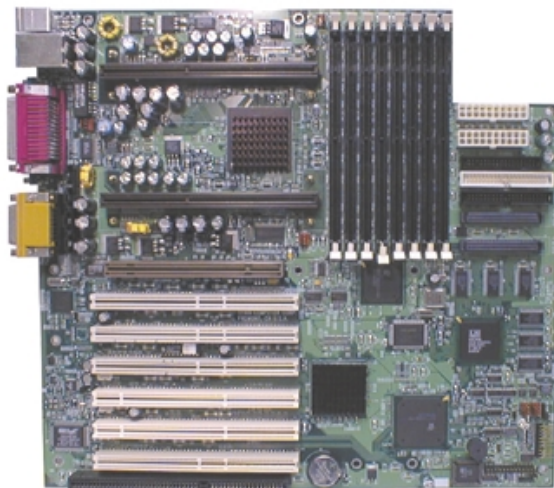

**Figure 9-18** The System Board

To remove the existing system board:

---

**Warning:** The system is always on when connected to AC power. Before performing this task, disconnect the system's power cord from its AC power outlet.

---

1. Remove the top cover. See Chapter 7, “Gaining Access to System Components”.
2. Note where all cables are connected to the system board, and then disconnect them from the system board.
3. Note where expansion cards are installed, and then remove them, placing them on an antistatic surface.
4. Remove the DIMMs, the processor modules, and the processor bus terminator (if installed), and place them on an antistatic surface.
5. Remove the nuts from the processor retention clips, and then remove the clips from the system board.
6. Remove the 13 screws from the system board.
7. Lift the system board out of the base unit and place it on an antistatic surface.

To install a new system board:

---

**Warning:** The system is always on when connected to AC power. Before performing this task, disconnect the system’s power cord from its AC power outlet.

---

1. Connect the power switch/LED cable to connector J24 **before** installing the new system board.
2. Place the new system board into the base unit front edge first, and then lower the back edge into the base unit. Slide the system board toward the back of the base unit until all mounting holes are aligned with their standoffs.
3. Secure the new system board to the base unit using the 13 screws removed previously.
4. Secure the processor retention clips to the system board with the nuts removed previously.
5. Replace the DIMMs, the processors, and the processor bus terminator (if needed) in the appropriate sockets.
6. Replace the expansion cards in the appropriate expansion card sockets.
7. Reconnect the remaining cables to the system board.
8. Replace the top cover. See Chapter 7, “Gaining Access to System Components”.

## CMOS/Clock Lithium Battery

The CMOS/clock lithium battery is located at the bottom of the system board, next to the lowest expansion card slots. The battery may be hidden under installed expansion cards.

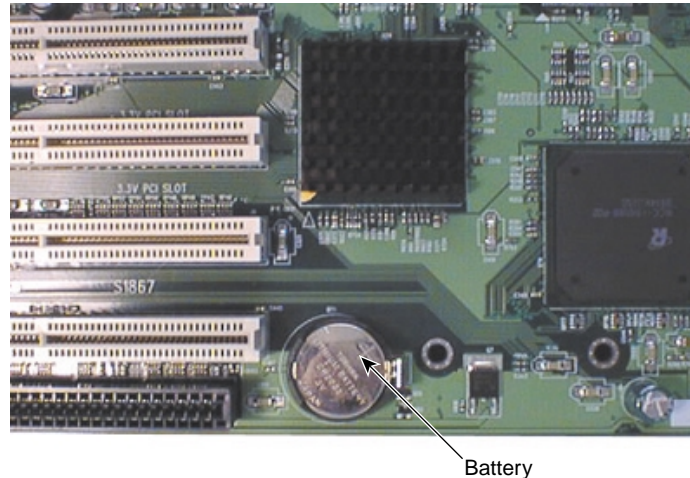

**Figure 9-19** CMOS/Clock Lithium Battery

If you must replace the battery, the system will lose its operating parameters stored in CMOS memory. As a result, the system BIOS parameter settings are lost. After you replace the battery, you must reset the date and time and reconfigure the BIOS.

See the *System Board Guide* for detailed information on replacing the battery and on using BIOS Setup to configure the BIOS.

## Intrusion Alert Switch

The base unit has two intrusion alert switches: one for the top cover/side panel, and one for the front panel. You must replace both switches at the same time.

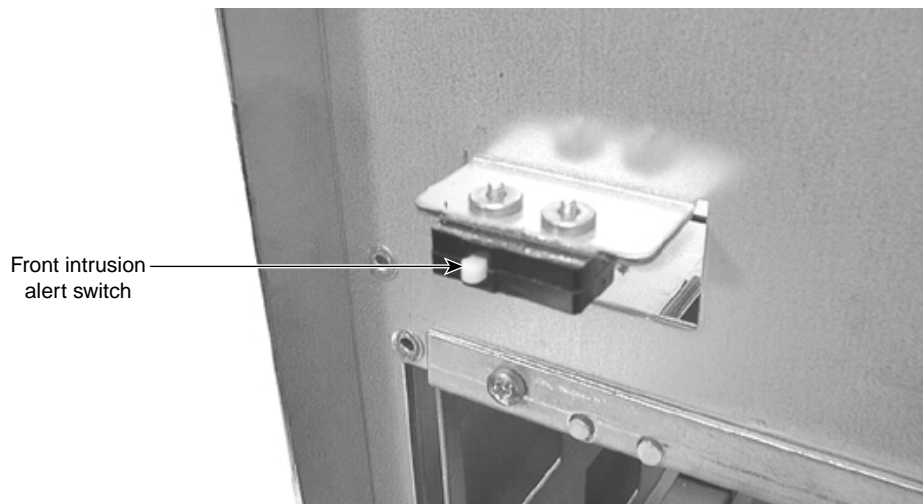

**Figure 9-20** Front Intrusion Alert Switch

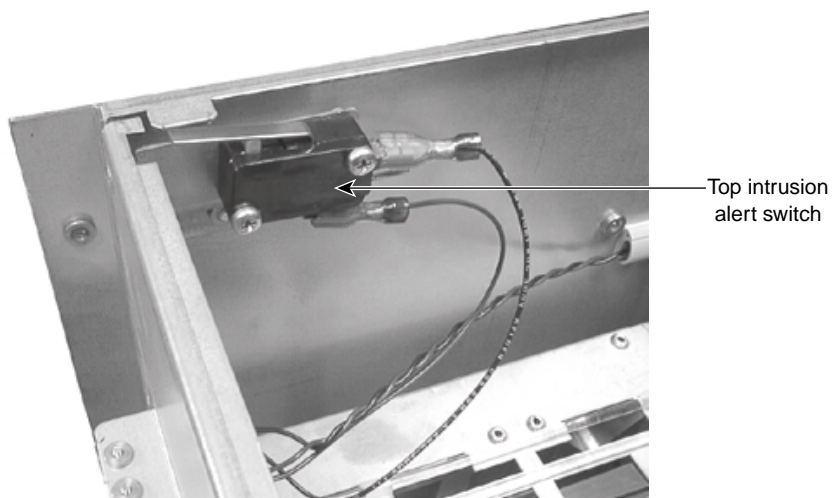

**Figure 9-21** Top Intrusion Alert Switch

To replace the intrusion alert switches:

1. Remove the top cover/side panel and the front panel. See Chapter 7, “Gaining Access to System Components”.
2. Disconnect the intrusion alert switch cable from its connector on the system board.
3. Remove the screws securing the switches from the base unit and remove the switches, guiding the cable out through the bulkhead opening behind the disk drive cage.
4. Secure the new switches to the base unit, using the screws removed previously.
5. Route the intrusion alert switch cable through the bulkhead opening behind the disk drive cage and connect the cable to its connector on the system board.
6. Remove the top cover/side panel and the front panel. See Chapter 7, “Gaining Access to System Components”.

## Power Keyswitch and LEDs

The Power keyswitch is mounted to the back of the front panel. The Power and Disk LEDs are mounted to a bracket on the base unit behind the front panel. You must replace the keyswitch and Power LED at the same time. See the *System Board Guide* for connector and socket locations.

To replace the Power keyswitch and LEDs:

---

**Warning:** The system is always on when connected to AC power and the power supplies are switched on. Before opening the system, switch off both power supplies.

---

1. Remove the front panel. See Chapter 7, “Gaining Access to System Components”.
2. Disconnect the Power keyswitch/LED cable set from its connector on the system board, and carefully guide the cables out through the bulkhead opening behind the disk drive cage.
3. Disconnect the Disk LED cable from its connector on the RAID controller card, and carefully guide the cable out through the bulkhead opening behind the peripheral device cage.

4. Remove the nut securing the keyswitch to the front panel and remove the keyswitch from the panel. See Figure 9-22.

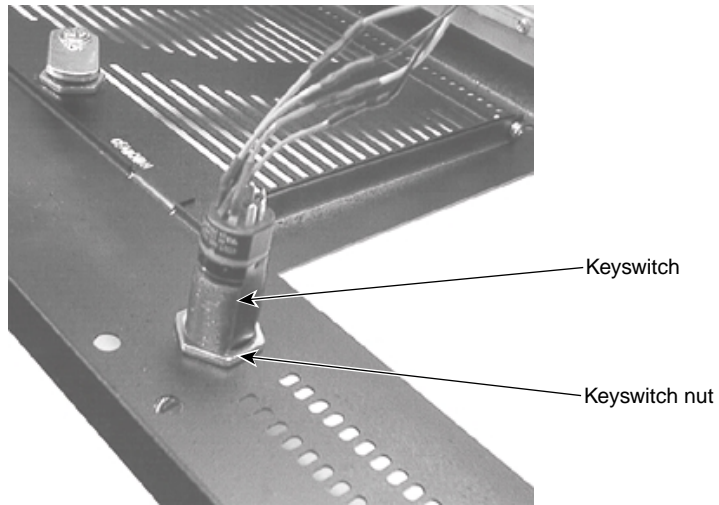

**Figure 9-22** Removing the Keyswitch

5. Push the LEDs out of the LED bracket.



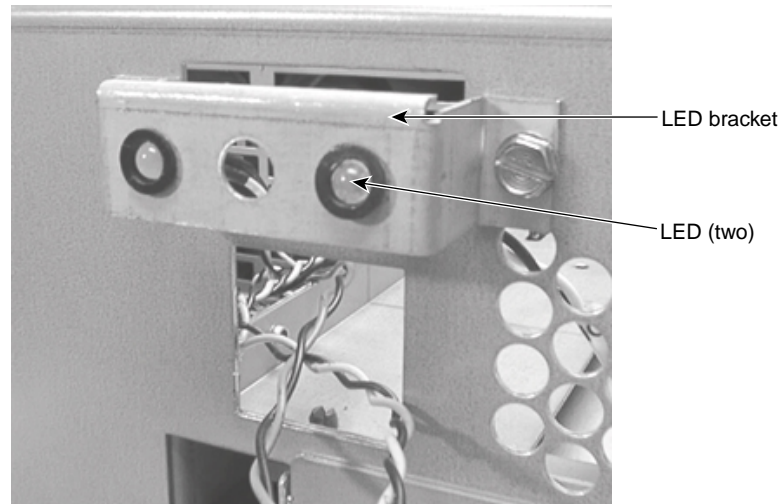

**Figure 9-23** Pushing Out the LEDs

6. Remove the keyswitch, LEDs, and cable assembly from the base unit.
7. Push the new LEDs into the LED bracket.
8. Insert the new keyswitch into the front panel and secure it with the nut removed previously.
9. Carefully guide the Power keyswitch/LED cable set through the bulkhead opening behind the disk drive cage, and connect the cable to its connector on the system board.
10. Carefully guide the Disk LED cable through the bulkhead opening behind the peripheral device cage, and connect the cable to its connector on the RAID controller card.
11. Replace the front panel. See Chapter 7, “Gaining Access to System Components”.



## System Hardware and Specifications

This chapter contains information about hardware and specifications for your system.

This chapter does not contain detailed information on the system board. See the *System Board Guide* delivered with your system for detailed information on the system board and its components, BIOS, memory, slots and sockets, jumpers and connectors, and ports.

### Functional Diagram

Figure 10-1 shows the power and data signals of the base unit components.

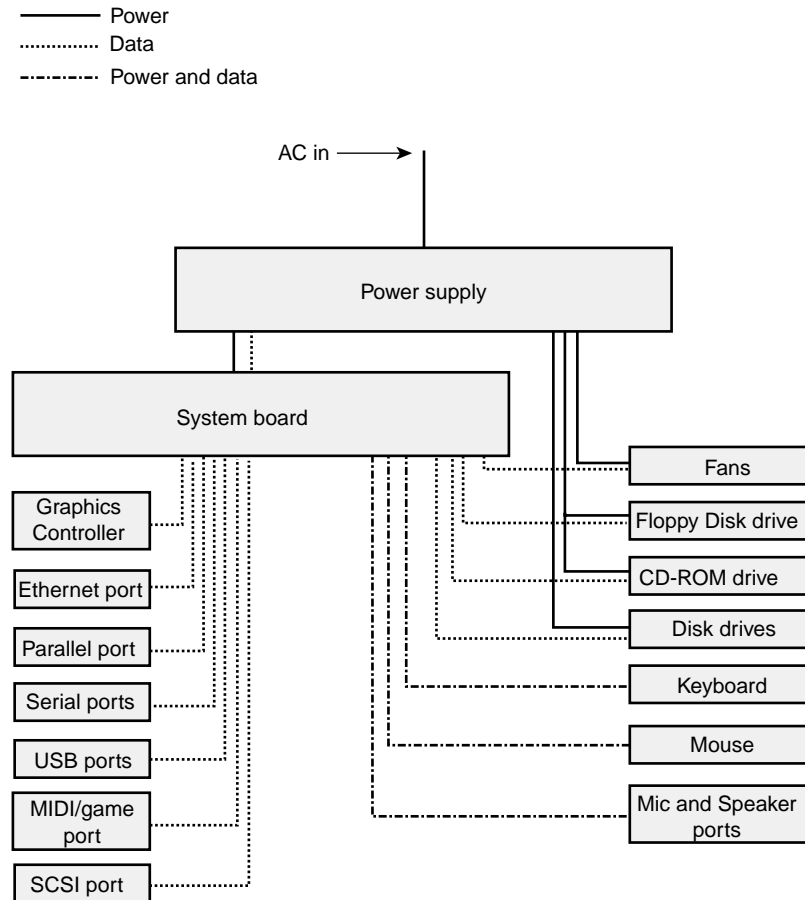

**Figure 10-1** Functional Diagram

## Internal Peripheral Cabling

The following sections show EIDE and SCSI cable routings and connections to internal peripheral devices, and depicts standard and optional cables used in the system. For detailed information and location of bus connectors on the system board, see the *System Board Guide*.

**Caution:** When handling cables, flex them as little as possible. Ensure that cables do not contact sharp metal surfaces or become excessively bent or twisted. In particular, SCSI cables should not have any creased bends.

## EIDE Cabling

One EIDE cable connects the primary EIDE channel to the CD-ROM drive and (optionally) to another device in the peripheral device cage. Another EIDE cable can connect the secondary EIDE channel to one or two devices in the peripheral device cage.

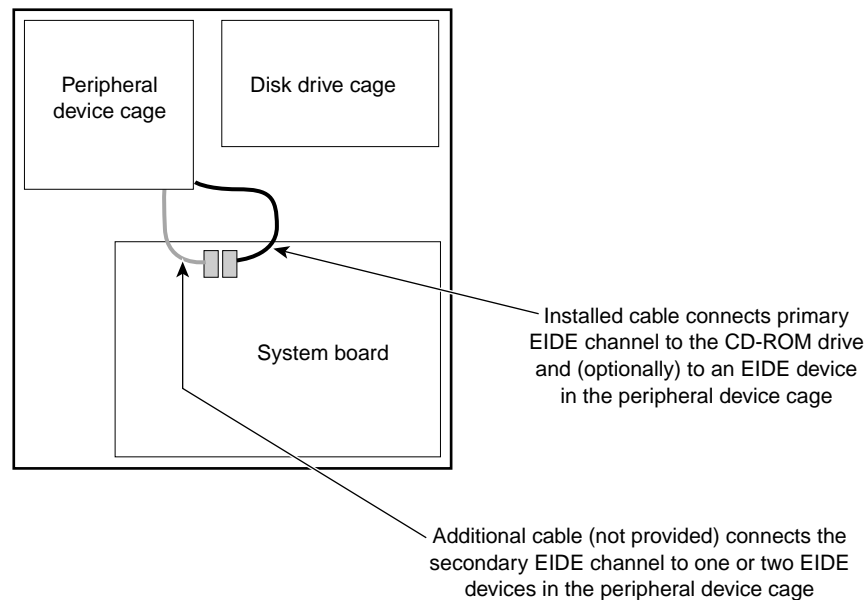

**Figure 10-2** EIDE Cabling

## SCSI Cabling for RAID Systems

In a RAID system:

- A SCSI cable connects Channel A of the on-board SCSI controller to the SCSI port on the back of the base unit.

---

**Warning:** For continued protection against fire and energy hazards, do not connect an external SCSI port to SCSI Channel B. Connect an external SCSI port only to SCSI Channel A.

---

- On some systems, a SCSI cable connects Channel B of the on-board SCSI controller to SCSI devices in and above the peripheral device cage.
- A SCSI cable connects the SCSI connector on the RAID controller card to a SCSI connector on the back of the RAID disk drive cage.

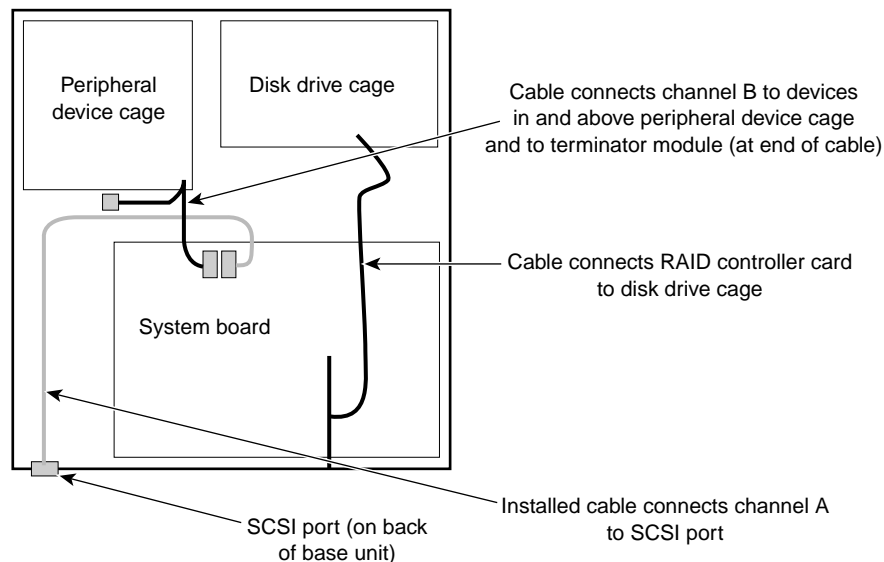

**Figure 10-3** SCSI Cabling for RAID Systems

## SCSI Cabling for JBOD Systems

In a JBOD ("just a bunch of disks") system:

- A SCSI cable connects Channel A of the on-board SCSI controller to SCSI devices in and above the peripheral device cage and to the SCSI port on the back of the base unit.

---

**Warning:** For continued protection against fire and energy hazards, do not connect an external SCSI port to SCSI Channel B. Connect an external SCSI port only to SCSI Channel A.

---

- A SCSI cable connects Channel B of the on-board SCSI controller to disk drives in the JBOD disk drive cage.

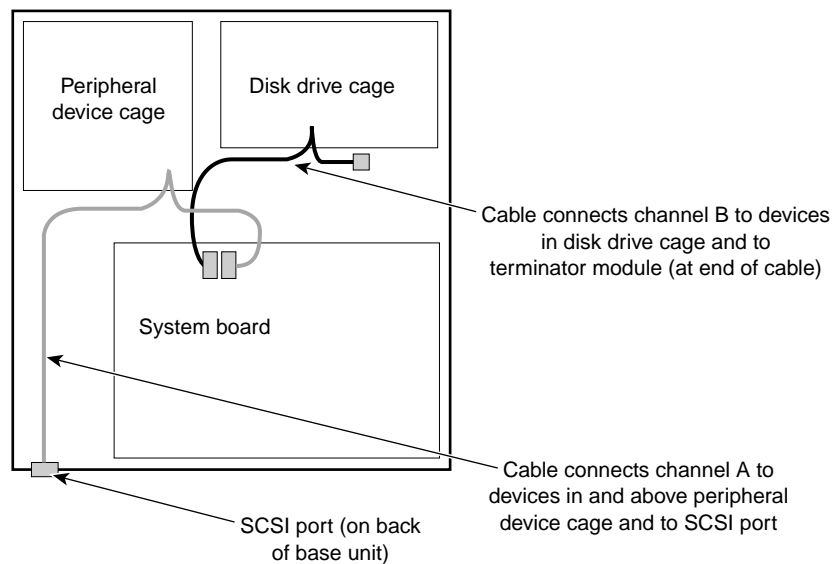

**Figure 10-4** SCSI Cabling for JBOD Systems

## Floppy Disk Drive Cable

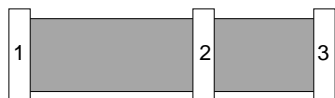

**Figure 10-5** Floppy Disk Drive Cable

**Table 10-1** Floppy Disk Drive Cable

Connector	Connects To
1	Floppy disk drive controller on system board
2	Floppy disk drive

## EIDE Peripheral Device Cage Cable



**Figure 10-6** EIDE Peripheral Device Cage Cable

**Table 10-2** EIDE Peripheral Device Cage Cables

Connector	Connects To
1	EIDE connector on system board
2	EIDE CD-ROM drive
3	EIDE device (optional)



## RAID SCSI External Port Cable



**Figure 10-7** RAID SCSI External Port Cable

**Table 10-3** RAID SCSI External Port Cable

Connector	Connects To
1	SCSI Channel A connector on system board
2	SCSI port on back of base unit

## RAID SCSI Peripheral Device Cage Cable



**Figure 10-8** RAID SCSI Peripheral Device Cage Cable

**Table 10-4** RAID SCSI Peripheral Device Cage Cable

Connector	Connects To
1	SCSI Channel B connector on system board
2, 3, 4, 5	SCSI devices in or above peripheral device cage
6	SCSI terminator module

## RAID SCSI Disk Drive Cage Cable

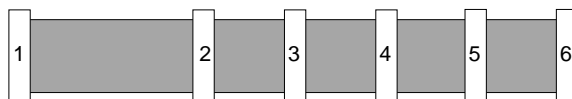

**Figure 10-9** RAID SCSI Disk Drive Cage Cable

**Table 10-5** RAID SCSI Disk Drive Cage Cable

Connector	Connects To
1	SCSI connector on RAID controller card
2	SCSI connector on back of disk drive cage

## JBOD SCSI Peripheral Device Cage/External Port Cable

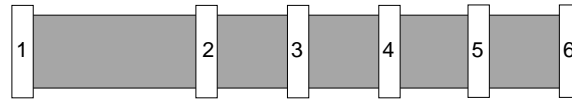

**Figure 10-10** JBOD SCSI Peripheral Device Cage/External Port Cable

**Table 10-6** JBOD SCSI Peripheral Device Cage/External Port Cable

Connector	Connects To
1	SCSI Channel A connector on system board
2, 3, 4, 5	SCSI devices in or above peripheral device cage
6	SCSI port on back of base unit

## JBOD SCSI Disk Drive Cage Cable



**Figure 10-11** JBOD SCSI Disk Drive Cage Cable

**Table 10-7** JBOD SCSI Disk Drive Cage Cable

Connector	Connects To
1	SCSI Channel A connector on system board
2, 3, 4, 5	SCSI disk drives in disk drive cage
6	SCSI terminator module

## Power Supply and Cables

The system has two power supplies for increased power supply reliability. Both must be connected to AC power for the system to operate correctly. However, if one power supply fails, you can replace it without shutting down the other power supply. This hot-swap capability lets you handle a power supply failure without shutting down and powering down the entire system.

Both power supplies provide 350 Watts of power to the system. Each power supply has a manual switch for selecting either 115 V AC (90-132 V AC) range or 230 V AC (180-264 V AC) range for domestic or international locations. The input frequency is 47-63 Hz, single phase. Input current is 6.0 A for the 115 V AC range and 3.5 A for the 230 V AC range. The typical efficiency is 70 percent at maximum output load.

The combined power supplies have the following DC output specifications. .

**Table 10-8** Power Supply DC Output Specifications

Outputs →	1	2	3	4	5	6 <sup>1</sup>
Nominal Output Voltages (VDC)	+5.0 <sup>2</sup>	+3.3 <sup>2</sup>	+12.0	-12.0	-5.0	+5.0
Maximum Current Rating (ADC)	30	15	12	0.5	0.5	1

1. Standby +5.0 VDC output voltage is always on.
2. Maximum +5.0 V and +3.3 V combined power is 150W.

The combined power supplies have a single power cable, P1 that connects to an ATX power connector on the system board.

The combined power supplies have four peripheral device power cables and one floppy disk drive power cable. Three of the cables have two peripheral device power connectors (P14 and P15) each. The fourth cable has two peripheral device power connectors (P12 and P13) and a floppy disk drive power connector (P11)..

**Table 10-9** P1 Connector Pinout

Pin	Signal	Pin	Signal	Pin	Signal	Pin	Signal
1	+3.3V	6	+5.0 V	11	+3.3 V *	16	Ground
2	+3.3V	7	Ground	12	-12.0 V	17	Ground
3	Ground	8	Power Good	13	Ground	18	-5.0 V
4	+5.0V	9	5.0 V Standby	14	Remote On	19	+5.0 V
5	Ground	10	+12.0 V	15	Ground	20	+5.0 V

\* + Sense

**Table 10-10** P11 Connector Pinout

Pin	Signal	Pin	Signal
1	+5.0 V	3	Ground
2	Ground	4	+12.0 V

**Table 10-11** P12 through P15 Connector Pinout

Pin	Signal	Pin	Signal
1	+12.0 V	3	Ground
2	Ground	4	+5.0 V

## Cooling Fans

The system has three 12 V DC cooling fans that are controlled by circuitry on the system board. A 120 mm (77 cfm) fan mounted behind the peripheral device cage and two 120 mm (77 cfm) fans mounted behind the disk drive cage ensure proper airflow to cool system components in the base unit. These fans bring cool air into the base unit to force out warm air. Another, smaller fan cools an area of the system board between the processors.

The cooling fans are field replaceable. See Chapter 9, “Servicing the System” for details on replacing the cooling fans.

---

**Caution:** To maintain proper airflow to cool system components, make sure you install a new fan with the label on the fan motor facing toward the **back** of the base unit.

---

Each power supply contains its own cooling fan. The power supply fans are not field replaceable. If a power supply fan requires replacement, you must replace the power supply. See Chapter 9, “Servicing the System” for details on replacing a power supply.

## Hardware Monitoring and Power Management

The system features advanced hardware monitoring and power management capabilities. These features help save energy, prolong system life, and provide for functionality such as remote system wakeup.

When used with Hardware Monitor software, these features enable you to keep track of such things as system voltages, component and chassis temperatures, and fan presence and operation. For more information on the items that can be monitored on your system, see the *System Board Guide* and Hardware Monitor Help.

## System Configuration Summary

See the *System Board Guide* for detailed information on the system board and its components.

**Table 10-12** System Configuration Summary

Feature	Description
Processors	One or two Intel SC242 (Slot 1)
Processor Bus	133 MHz, 64 bits
Memory Modules	Dual inline memory modules (DIMMs)
Memory Style	168-pin DIMMs, 10 ns, 3.3V, registered/buffered, 72-bit (ECC)
Memory Type	Synchronous Dynamic Random Access Memory (SDRAM)
Memory Bus	133 MHz, 128 bits
Memory Size	256 MB minimum, 6 GB maximum
Memory Expansion	256 MB, 512 MB, or 1,024 MB increments
Graphics	AGP or PCI expansion card
Audio	Creative AudioPCI controller, on system board
SCSI	LSI dual-channel LVD Ultra3 SCSI controller, on system board Mylex RAID controller card for internal SCSI devices (RAID systems)
Network	Intel 10/100 Mbps Ethernet adapter, on system board
Disk Drives	LVD Ultra3 SCSI
CD-ROM drive	40X or higher EIDE ATAPI-compatible
Keyboard	Windows 95/98 compatible PS/2
Mouse	Two-button wheel mouse
Expansion Slots	One full-length AGP Pro Two fast-and wide PCI (66 MHz, 64 bits, 3.3 V/Universal) Four wide PCI (33 MHz, 64 bits, 5 V/Universal) One full-length ISA (card space shared with one wide PCI slot)

**Table 10-12 (continued)** System Configuration Summary

Feature	Description
Peripheral Device Cage	One 5.25-in x 1.6-in external bay for CD-ROM drive One 3.5-in x 1.0-in external bay for floppy disk drive Two internal/external bays for other peripheral devices; each bay accommodates one 5.25-in x 1.6-in device or one 3.5-in x 1.0-in device One 3.5-inch disk drive bracket above cage (some systems)
Disk Drive Cage	Four slots for removable SCA LVD SCSI disk drives (RAID system) or four bays for LVD SCSI disk drives (JBOD system)
I/O Ports	One PS/2 mouse and one PS/2 keyboard – 6-pin mini-DIN One parallel (LPT) – EPP/ECP, 25-pin DB25 Two serial (COM) – 9-pin DB9 Two Universal Serial Bus (USB) – 12 MB/sec One SCSI – Ultra3 Video – SVGA; others vary by controller Audio – Microphone, line in, line out, MIDI/game Network – Ethernet
Power Supply	350 Watts, manual-ranging Two supplies per system with hot-swap capability

## System Specifications

**Table 10-13** System Specifications

Item	Specifications
Dimensions	10.5 in high x 16.7 in wide x 25.1 in deep (26.7 cm wide x 42.5 cm wide x 63.8 cm deep)
Weight	55 lb (25 kg) fully configured
Equipment rack space required	6U – 10.5 in (26.7 cm)
Maintenance clearance	36 inches (91.4 cm) front and back

**Table 10-13 (continued)** System Specifications

---

<b>Item</b>	<b>Specifications</b>
AC line voltage (US)	90 – 132 VAC, 47 – 63 Hz, 1 phase, 15A/125 V receptacle
AC line voltage (International)	180 – 264 VAC, 47 – 63 Hz, 1 phase, 15A/250 V receptacle
Power consumption	324 W; 2.7 A at 120 VAC maximum configuration
Recommended room temperature	50° to 90° F (10° to 32° C); optimum 70° F (21° C)
Recommended room humidity	20% to 80% (non-condensing); optimum 50%
Heat dissipation	1,195 BTU/hr

---



## Ergonomics Guide

This appendix gives you information to help you develop proper work habits, establish a proper work environment, and reduce the risk of injury. Review the information in this appendix before using your computer. Follow these guidelines as you use your computer.

### Setting Your Work Habits

Take the following steps to evaluate and adjust the way you work at the computer.

#### Getting Started

1. If you can adjust the work surface or the keyboard support, adjust the chair to rest your feet flat on the floor and to firmly support your thighs with the seat base. Leave the chair at this adjusted position as you go through the following steps.
2. If you cannot adjust the work surface or the keyboard support, adjust your seating position as described in the following steps.

#### Arms

1. Rest your fingers on the keyboard.
2. Relax your upper arms; they should be nearly vertical at your sides. Your forearms should bend nearly at right angles to your upper arms.
3. If your upper arms are not vertical, adjust the distance between the chair and the keyboard until they are.
4. If your forearms are not at right angles to your upper arm, adjust the height of the keyboard or the chair until they are.
5. If your elbows rest on the chair's armrests, do not let this cause you to raise your shoulders from their relaxed position.

## Wrists

1. Rest your fingers on the keyboard. Your wrists should be straight with your forearms.
2. If your wrists bend upward or downward, adjust the height of the keyboard or chair to align your wrists properly with your forearms.
3. If your wrists bend inward or outward, adjust the position of your hands to align your wrists properly with your forearms.

You may find it helpful to use a wrist support for short periods of rest.

## Head and Eyes

1. Place the monitor screen between 18 inches (45.1 centimeters) and 31 inches (78.7 centimeters) from your eyes (*Humanscale*, MIT Press).
2. Angle your head downward slightly when you look at the center of the monitor screen.
3. If the monitor is too high or too low, use a suitable support to place it at a comfortable height. Do not assume that using the computer's base unit as a support places the monitor at the correct height.
4. If you continually refer to a document while working at the computer, place the document at the same height and angle as the monitor screen.

## Back

The chair you use when working at the computer should firmly support your back when you sit up straight, and your thighs should be at right angles to your torso. The chair should also support the lumbar curve of your back.

1. If you can adjust the chair's backrest angle, make sure your thighs and your torso are nearly at right angles when your feet rest on the floor.
2. If you can adjust the chair's backrest tension, make sure it is firm enough to support your back while working. It should only tilt back under force.
3. If the chair's backrest does not provide lumbar support, use a pad or pillow to provide lumbar support.

## Legs

When working at the computer, your lower legs should be at right angles to your thighs. Your upper legs should be positioned so the knees are slightly above the hip joint. Your feet should rest flat on the floor.

1. If your lower legs are not at right angles to your thighs, adjust the chair to be higher.
2. If your feet do not rest flat on the floor, adjust the chair to be higher. You may need to use a footrest to support your feet and maintain the correct position relative to the keyboard.
3. If your thighs are compressed on the seat pan, the chair is too high. Some chairs offer a seat pan tilt adjustment for a greater range of lift.

## Setting Your Environment

Adjust the room lighting and the position of the monitor screen to minimize screen glare and reflections:

- Do not work in an over- or under-illuminated room; an average illumination of 50 foot-candles is usually sufficient. Below this level, you should provide task lighting for documents.
- Older individuals may require higher average illumination, up to 100 foot-candles.

Do not work in a cold room. The American Society of Heating, Refrigeration, and Air Conditioning Engineers (ASHRAE) recommends the following office climate for the average clothed individual:

- Temperature between 73.0 and 79.0 degrees Fahrenheit (22.7 and 26.1 degrees Celsius) during the summer.
- Temperature between 68.0 and 74.5 degrees Fahrenheit (20.0 and 23.6 degrees Celsius) during the winter.
- Relative humidity between 30 and 60 percent all year.

## Reducing the Risk of Injury

There are several things you can do to reduce the risk of injury while working with a computer.

### Changing Posture

Do not hold any posture for an extended period of time. If possible, change your working posture several times a day. If you can, work part of the day sitting and part of it standing.

### Taking Rest Breaks

Take periodic rest breaks during the day. A study sponsored by the National Institute for Occupational Safety and Health (NIOSH; R. Henning, University of Connecticut, 1992) found that adding distributed rest breaks to the traditional work schedule “forestall(ed) the development of discomfort in repetitive VDT work.”

Try using this recommended minimum rest break schedule:

- 30 seconds after each 10 minutes of work.
- 3 minutes after each 50 minutes of work.
- 15 minutes at mid-morning.
- 30 to 45 minutes at lunch.
- 15 minutes at mid-afternoon.

During each rest break, gently and slowly stretch your hands and arms. During longer rest breaks, get up, walk around, and gently stretch as much of your body as you can. Set a schedule of rest breaks and take them. It is easy to focus on your work and forget to take rest breaks; use a timer or a software reminder program to help you remember.

During each rest break, focus on something far away to relax your eye muscles. Avoid close focus activities like reading during a rest break to allow your eyes to rest.

## **Taking Care of Your Body**

Keep your hands and arms warm. Warm up and gently stretch your hands before you start working. You may find it helpful to wear warm, fingerless gloves.

Keep a straight, or “neutral,” wrist position. Use wrist rests and other supports during pauses to help you keep a comfortable wrist position.

Use the minimum force necessary to activate switches (of any type, on any device). Many people use far more force than is required; this is frequently true for point-and-drag operations using a mouse. Excess force puts unnecessary strain on tendons, joints, and soft tissues. You may have to teach yourself to use minimum force.

Be aware that home and hobby activities can contribute to any discomfort or pain you may experience at work.

Maintain good overall muscle tone with a sensible exercise program. See a physician for recommendations, or before starting any exercise program.

## **Getting Help**

If you experience any discomfort or pain, evaluate your work habits, your work environment, and your personal activities. Consult a physician if the discomfort or pain persists.

Seek professional medical attention if you experience a problem. Take an active part in alleviating the problem. Do not rely on self-diagnosis.