



**CXFS™ 6 Administration Guide for  
SGI® InfiniteStorage**

007-5618-001

---

## COPYRIGHT

© 2010 SGI. All rights reserved; provided portions may be copyright in third parties, as indicated elsewhere herein. No permission is granted to copy, distribute, or create derivative works from the contents of this electronic documentation in any manner, in whole or in part, without the prior written permission of SGI.

The following copyright notice applies to the LZF algorithm:

Copyright (c) 2000-2005 Marc Alexander Lehmann <schmorp@schmorp.de> Redistribution and use in source and binary forms, with or without modification, are permitted provided that the following conditions are met:

1. Redistributions of source code must retain the above copyright notice, this list of conditions and the following disclaimer.
2. Redistributions in binary form must reproduce the above copyright notice, this list of conditions and the following disclaimer in the documentation and/or other materials provided with the distribution.
3. The name of the author may not be used to endorse or promote products derived from this software without specific prior written permission.

THIS SOFTWARE IS PROVIDED BY THE AUTHOR "AS IS" AND ANY EXPRESS OR IMPLIED WARRANTIES, INCLUDING, BUT NOT LIMITED TO, THE IMPLIED WARRANTIES OF MERCHANTABILITY AND FITNESS FOR A PARTICULAR PURPOSE ARE DISCLAIMED. IN NO EVENT SHALL THE AUTHOR BE LIABLE FOR ANY DIRECT, INDIRECT, INCIDENTAL, SPECIAL, EXEMPLARY, OR CONSEQUENTIAL DAMAGES (INCLUDING, BUT NOT LIMITED TO, PROCUREMENT OF SUBSTITUTE GOODS OR SERVICES; LOSS OF USE, DATA, OR PROFITS; OR BUSINESS INTERRUPTION) HOWEVER CAUSED AND ON ANY THEORY OF LIABILITY, WHETHER IN CONTRACT, STRICT LIABILITY, OR TORT (INCLUDING NEGLIGENCE OR OTHERWISE) ARISING IN ANY WAY OUT OF THE USE OF THIS SOFTWARE, EVEN IF ADVISED OF THE POSSIBILITY OF SUCH DAMAGE.

---

## LIMITED RIGHTS LEGEND

The software described in this document is "commercial computer software" provided with restricted rights (except as to included open/free source) as specified in the FAR 52.227-19 and/or the DFAR 227.7202, or successive sections. Use beyond license provisions is a violation of worldwide intellectual property laws, treaties and conventions. This document is provided with limited rights as defined in 52.227-14.

---

## TRADEMARKS AND ATTRIBUTIONS

Altix, CXFS, FDDIXPress, IRIX, NUMALink, Octane, Performance Co-Pilot, SGI, SGI ProPack, the SGI logo, Silicon Graphics Prism, Silicon Graphics, Supportfolio, and XFS are trademarks or registered trademarks of Silicon Graphics International Corp. or its subsidiaries in the United States and other countries.

AIX and IBM are registered trademarks of IBM Corporation. Brocade is a trademark of Brocade Communication Systems, Inc. Digi is a trademark of Digi International, Inc. Java, Solaris, and Sun are trademarks or registered trademarks of Sun Microsystems, Inc. or its subsidiaries in the United States and other countries. Linux is a registered trademark of Linus Torvalds in several countries. Legato NetWorker is a registered trademark of Legato Systems, Inc. Mac OS is a registered trademark of Apple Computer, Inc. QLogic is a registered trademark of QLogic Corporation. Red Hat and all Red Hat-based trademarks are trademarks or registered trademarks of Red Hat, Inc. in the United States and other countries. UNIX is a registered trademark of The Open Group in the United States and other countries. NetBackup, Symantec, and Veritas are trademarks or registered trademarks of Symantec Corporation or its affiliates in the U.S. and other countries. Microsoft, Windows, Windows NT, and Windows Vista are either registered trademarks or trademarks of Microsoft Corporation in the United States and/or other countries. X/Open is a registered trademark of X/Open Company Ltd. All other trademarks mentioned herein are the property of their respective owners.

---

## New Features in This Guide

---

**Note:** Be sure to read the release notes for the SGI InfiniteStorage Software Platform, your specific CXFS platforms, and the late-breaking caveats pages on Supportfolio to learn about any changes to the installation and configuration procedures.

---

This guide supersedes *CXFS 5 Administration Guide for SGI InfiniteStorage* (007-4016-030) for the CXFS 6 series. (The CXFS 5 guide remains available on the SGI Technical Publications Library.)

This new guide contains the following:

- Support for SLES 11 on server-capable administration nodes
- New client-only support:
  - Mac OS X Snow Leopard 10.6
  - RHEL 5.4
  - SLES 10 SP3 (added in ISSP 1.9)
- Support for CXFS 6.0 and XVM 6.0 licenses. Upgrading customers must obtain new licenses; contact your SGI support person.
- Support for the following changes to `cxfs_admin`:
  - Support for entering read-only mode by default, requiring you to actively enter `lock` mode before making changes to the cluster database or performing administrative actions (assuming you are running `cxfs_admin` from a server-capable administration node or a node that has been given `admin` permission). You can override this default behavior by entering the `-A` (for *Admin write mode*) option on the command line, by changing options in the `$HOME/.cxfs_admin` file, or setting the `CXFS_ADMIN_WRITE_MODE` environment variable. See:
    - "Setting `cxfs_admin` Defaults" on page 227
    - "Setting `cxfs_admin` Access Permissions" on page 230
  - Support for the following new capabilities:
    - "Control and Contact a Node with `cxfs_admin`" on page 255

- "Query Fence Status" on page 278
- "Raise a Fence" on page 278
- "Lower a Fence" on page 278

---

**Note:** The `cmgr` command is no longer supported. If you still require information about `cmgr`, see "Appendix F. Reference to `cmgr` Tasks" in *CXFS 5 Administration Guide for SGI InfiniteStorage* (007-4016-030) posted on the SGI Technical Publications Library:

[http://techpubs.sgi.com/library/manuals/4000/007-4016-029/sgi\\_html/apf.html](http://techpubs.sgi.com/library/manuals/4000/007-4016-029/sgi_html/apf.html)

---

- Support for external log filesystems. See "Supported XFS Features" on page 5.
- Removal of information about the AIX, IRIX, and Solaris client-only platforms and associated system controllers.

---

**Note:** AIX, IRIX, and Solaris clients are not supported in ISSP 2.0 and 2.X releases going forward.

The AIX, IRIX, and Solaris clients are still fully supported in the CXFS 5.X series in ISSP 1.X.

---

---

## Record of Revision

<b>Version</b>	<b>Description</b>
001	January 2010 Supports the CXFS 6.0 product in SGI InfiniteStorage Software Platform (ISSP) 2.0 release.



---

# Contents

<b>About This Guide</b>	<b>xxxv</b>
Related Publications	xxxv
Obtaining Publications	.xxxvii
Conventions	.xxxvii
Reader Comments	.xxxix
<b>1. Introduction to CXFS</b>	<b>1</b>
What is CXFS?	1
Comparison of XFS and CXFS	3
Differences in Filesystem Mounting and Management	4
Supported XFS Features	5
When to Use CXFS	6
Performance Considerations	6
Comparison of Network and CXFS Filesystems	7
Network Filesystems	7
CXFS Filesystems	8
CXFS Features	8
CXFS Restrictions	9
Cluster Environment Concepts	10
Metadata	11
Node	11
RAID	11
LUN	11
Cluster	11
Pool	12

Node Types, Node Functions, and the Cluster Database . . . . .	13
Membership . . . . .	23
Private Network . . . . .	23
Data Integrity Protection . . . . .	25
CXFS Tiebreaker . . . . .	26
Relocation . . . . .	26
Recovery . . . . .	27
CXFS Services . . . . .	29
CXFS Interoperability With Other Products and Features . . . . .	29
Data Migration Facility (DMF) . . . . .	30
Highly Available Services . . . . .	30
GPT Labels Overview . . . . .	31
Guaranteed-Rate I/O (GRIO) Version 2 Overview . . . . .	31
Storage Management . . . . .	32
Storage Backup Differences . . . . .	32
NFS Differences . . . . .	33
Quotas Differences . . . . .	33
Samba Differences . . . . .	33
Volume Management with XVM . . . . .	34
XVM Failover Version 2 Overview . . . . .	35
Hardware and Software Requirements for Server-Capable Administration Nodes . . . . .	35
CXFS Software Products Installed on Server-Capable Administration Nodes . . . . .	37
CXFS Tools . . . . .	38
Configuration Commands . . . . .	38
CXFS GUI Overview . . . . .	39
cxfs_admin Command-Line Configuration Tool Overview . . . . .	42
Cluster Administration Daemons . . . . .	43
CXFS Control Daemons . . . . .	44



Other Commonly Used Administrative Commands . . . . .	44
<b>2. Best Practices . . . . .</b>	<b>47</b>
Configuration Best Practices . . . . .	47
Fix Network Issues First . . . . .	48
Save the Current Configuration Before Making Changes . . . . .	49
Save the CXFS Configuration . . . . .	49
Save the XVM Configuration . . . . .	49
Use a Private Network . . . . .	49
Take Care When Using YaST for Configuration . . . . .	50
Use the Same Architecture for All Server-Capable Administration Nodes . . . . .	50
Provide Enough Memory . . . . .	50
Use CXFS Configuration Tools Appropriately . . . . .	51
Ensure Cluster Database Membership Quorum Stability . . . . .	51
Be Consistent in Configuration . . . . .	52
Use the Correct Mix of Software Releases . . . . .	52
Dedicate Server-Capable Administration Nodes to CXFS Work . . . . .	53
Use an Odd Number of Server-Capable Administration Nodes . . . . .	53
Create an Initial Cluster of All Server-Capable Administration Nodes . . . . .	54
Unmount Filesystems Before Adding or Deleting Server-Capable Administration Nodes . . . . .	54
Make Most Nodes Client-Only . . . . .	54
Use a Client-Only Tiebreaker . . . . .	55
Protect Data Integrity on All Nodes . . . . .	56
System Reset . . . . .	56
I/O Fencing . . . . .	57
Shutdown . . . . .	61
Avoid Split Clusters . . . . .	62

Fail Policies . . . . .	64
Use a Separate L2 for Each Node . . . . .	66
Avoid CXFS Kernel Heartbeat Issues on Large SGI Altix Systems . . . . .	66
Minimize the Number of Switches . . . . .	68
Configure Filesystems Properly . . . . .	69
Enable Forced Unmount When Appropriate . . . . .	69
Use the Appropriate CXFS Kernel Heartbeat Monitoring . . . . .	70
Verify the Configuration . . . . .	70
Use the Recovery Timeout Mechanism . . . . .	71
Use Proper Storage Management Procedures . . . . .	71
Run Samba Appropriately . . . . .	72
Install <code>ipmitool</code> on Altix XE Reset Nodes . . . . .	72
Use the LSI Drivers that Ship with the Linux OS . . . . .	72
Administration Best Practices . . . . .	72
Back Up the Cluster Database . . . . .	74
Change the Brocade Password when Prompted . . . . .	74
Do Not Run User Jobs on Server-Capable Administration Nodes . . . . .	74
Do Not Run Backups on a Client Node . . . . .	74
Use <code>cron</code> Jobs Properly . . . . .	74
Repair Filesystems with Care . . . . .	75
Defragment Filesystems with Care . . . . .	75
Use Relocation and Recovery Properly . . . . .	76
Shut Down Nodes Unobtrusively . . . . .	76
Remove Unused Cluster Components . . . . .	77
Use <code>fam</code> Properly . . . . .	77
Upgrade the Software Properly . . . . .	77
Use Fast Copying for Large CXFS Files . . . . .	78

Do Not Change Log File Names . . . . .	78
Rotate Log Files . . . . .	79
Use System Capacity Wisely . . . . .	79
Reboot Before Changing Node ID or Cluster ID . . . . .	79
Reboot a Removed Node Before Returning it to the Cluster Definition . . . . .	80
Restart CXFS on a Node after an Administrative CXFS Stop . . . . .	80
Restart the Cluster In an Orderly Fashion . . . . .	81
Disable Nodes that Affect Membership Before Maintenance . . . . .	81
Disable Reset If You Remove Reset Capability . . . . .	81
Avoid Performance Problems with Unwritten Extent Tracking . . . . .	82
Avoid Performance Problems with Exclusive Write Tokens . . . . .	82
Use Disk Layout Optimization for Approved Media Customers . . . . .	82
Set System Tunable Parameters Appropriately . . . . .	83
Keep the telnet Port Open on the Switch . . . . .	84
Solve Problems Efficiently . . . . .	84
Do Not Overfill CXFS Filesystems . . . . .	84
Use a Time Synchronization Application . . . . .	84
Turn Off Local XVM on Linux Nodes if Unused . . . . .	84
Avoid Memory-Mapped I/O for DMF Filesystems . . . . .	85
Do Not Use Both dmi and filestreams Mount Options . . . . .	85
After Restart, Verify that All Nodes Use the Preferred XVM Path . . . . .	86
Use Improved mkfs Options . . . . .	87
<b>3. SGI RAID for CXFS Clusters . . . . .</b>	<b>89</b>
RAID Hardware . . . . .	89
RAID Firmware . . . . .	90
Number of LUNs Supported . . . . .	91

RAID Verification . . . . .	93
<b>4. Switches . . . . .</b>	<b>95</b>
Brocade Switch . . . . .	95
Brocade Firmware . . . . .	95
Verifying the Brocade Switch Firmware Version . . . . .	96
Verifying the Brocade License . . . . .	97
Limiting telnet Sessions . . . . .	97
Brocade 12000/24000/48000 and telnet . . . . .	97
Other Brocade Models and telnet . . . . .	98
Changing the Brocade FC Cable Connections . . . . .	99
QLogic Fibre Channel Switch . . . . .	99
<b>5. CXFS Licensing . . . . .</b>	<b>103</b>
Server-Side Licensing Overview . . . . .	103
Licensing Requirements . . . . .	104
Server-Side Client License Keys . . . . .	105
License Key Replication on Server Nodes . . . . .	106
Cumulative Client License Keys . . . . .	106
Examples of License Keys Required for Cluster Changes . . . . .	106
Gathering the Host Information . . . . .	110
Obtaining the License Keys from SGI . . . . .	110
Installing the License Keys . . . . .	110
Verifying the License Keys . . . . .	111
Verifying the License Keys with <code>lk_verify</code> . . . . .	111
Verifying the License Keys with <code>cxfslicense</code> After Installing CXFS . . . . .	113
Displaying the License Keys with <code>cxfs_admin</code> After Installing CXFS . . . . .	114
For More Information About Licensing . . . . .	116

<b>6. Preinstallation Steps</b>	<b>117</b>
Hostname Resolution and Network Configuration Rules	117
Adding a Private Network	118
Verifying the Private and Public Networks	121
Modifications Required for CXFS GUI Connectivity Diagnostics	122
Configuring <code>SuSEfirewall2</code>	122
<b>7. Server-Capable Administration Node Installation</b>	<b>123</b>
Limitations and Considerations for Server-Capable Administration Nodes	123
Installation Overview for Server-Capable Administration Nodes	125
Installation Verification	126
Modifications for CXFS Connectivity Diagnostics	126
<b>8. Postinstallation Steps</b>	<b>129</b>
Configuring <code>/etc/exports</code> on All Nodes	129
Configuring Server-Capable Administration Node System Files	130
<code>/etc/services</code> on Server-Capable Administration Nodes	130
<code>cad.options</code> on Server-Capable Administration Nodes	130
<code>fs2d.options</code> on Server-Capable Administration Nodes	131
<code>fs2d.options</code> Example 1	133
<code>fs2d.options</code> Example 2	134
<code>clconfd.options</code> on Server-Capable Administration Nodes	134
Enabling GRIOV2 ( <i>Optional</i> )	136
Enabling GRIOV2 After Reboot	136
Enabling GRIOV2 for the Current Session	136
Disabling GRIOV2 After Reboot	136
Disabling GRIOV2 for the Current Session	137

<b>9. Initial Setup of the Cluster</b>	<b>139</b>
Preliminary Cluster Configuration Steps	140
Verify the License	140
Verify that the <code>chkconfig</code> Arguments are On	140
Verify that the Cluster Daemons are Running	141
Gather the Required Information	142
Configure for <code>nsd</code> Use ( <i>Optional</i> )	142
Initial Setup	142
Initial Setup with the CXFS GUI	143
Start the GUI	143
Set Up a New Cluster with the GUI	145
Set Up a New CXFS Filesystem with the GUI	147
Initial Setup with the <code>cxfs_admin</code> Command	148
Configuring a Large Cluster	152
Testing the System	153
Private Network Interface	154
System Reset Connection for Server-Capable Administration Nodes	154
Testing Serial Connectivity for the L2 on Altix 350 Systems	155
<b>10. CXFS GUI</b>	<b>157</b>
GUI Overview	157
Starting the GUI	158
Running the Web-based Version	159
Summary of GUI Platforms	161
Logging In	161
Making Changes Safely	162
GUI Windows	162

GUI Features . . . . .	164
GUI Window Layout . . . . .	165
File Menu . . . . .	166
Edit Menu . . . . .	166
Tasks Menu . . . . .	166
Help Menu . . . . .	167
Shortcuts Using Command Buttons . . . . .	167
View Menu . . . . .	169
Selecting Items to View or Modify . . . . .	169
Viewing Component Details . . . . .	169
Performing Tasks . . . . .	170
Using Drag-and-Drop . . . . .	171
Structuring Volume Topologies . . . . .	171
Configuring Disks . . . . .	172
Displaying State . . . . .	172
Getting More Information . . . . .	173
Important GUI and <code>xvm</code> Command Differences . . . . .	173
Key to Icons and States . . . . .	174
Guided Configuration Tasks . . . . .	177
Make Changes to Existing Cluster . . . . .	178
Fix or Upgrade Cluster Nodes . . . . .	178
Node Tasks with the GUI . . . . .	179
Define a Node with the GUI . . . . .	179
Examples of Defining a Node with the GUI . . . . .	185
Add or Remove Nodes in the Cluster with the GUI . . . . .	188
Reset a Node with the GUI . . . . .	189
Modify a Node Definition with the GUI . . . . .	189
Delete a Node with the GUI . . . . .	192

Test Node Connectivity with the GUI . . . . .	193
Display a Node with the GUI . . . . .	193
Cluster Tasks with the GUI . . . . .	194
Define a Cluster with the GUI . . . . .	194
Modify a Cluster Definition with the GUI . . . . .	195
Delete a Cluster with the GUI . . . . .	196
Display a Cluster with the GUI . . . . .	196
Cluster Services Tasks with the GUI . . . . .	196
Start CXFS Services with the GUI . . . . .	197
Stop CXFS Services with the GUI . . . . .	197
Set Tiebreaker Node with the GUI . . . . .	198
Set Log Configuration with the GUI . . . . .	198
Display Log Group Definitions with the GUI . . . . .	199
Configure Log Groups with the GUI . . . . .	200
Revoke Membership of the Local Node with the GUI . . . . .	201
Allow Membership of the Local Node with the GUI . . . . .	201
Switches and I/O Fencing Tasks with the GUI . . . . .	202
Define a Switch with the GUI . . . . .	202
Modify a Switch Definition with the GUI . . . . .	205
Update Switch Port Information with the GUI . . . . .	205
Delete a Switch Definition with the GUI . . . . .	205
Raise the I/O Fence for a Node with the GUI . . . . .	206
Lower the I/O Fence for a Node with the GUI . . . . .	206
Filesystem Tasks with the GUI . . . . .	207
Make Filesystems with the GUI . . . . .	207
Grow a Filesystem with the GUI . . . . .	209
Define CXFS Filesystems with the GUI . . . . .	210
Modify a CXFS Filesystem with the GUI . . . . .	213



Mount CXFS Filesystems with the GUI . . . . .	214
Unmount CXFS Filesystems with the GUI . . . . .	215
Mount a Filesystem Locally . . . . .	215
Unmount a Local Filesystem . . . . .	216
Delete a CXFS Filesystem with the GUI . . . . .	216
Remove Filesystem Mount Information . . . . .	216
Relocate a Metadata Server for a CXFS Filesystem with the GUI . . . . .	217
Privileges Tasks with the GUI . . . . .	218
Grant Task Access to a User or Users . . . . .	218
Granting Access to a Few Tasks . . . . .	219
Granting Access to Most Tasks . . . . .	220
Revoke Task Access from a User or Users . . . . .	221
<b>11. cxfs_admin Command . . . . .</b>	<b>223</b>
cxfs_admin Overview . . . . .	223
Starting cxfs_admin . . . . .	224
Syntax of Commands within cxfs_admin . . . . .	225
Setting cxfs_admin Defaults . . . . .	227
Making Changes Safely . . . . .	229
Read-Only Mode by Default . . . . .	229
Making Changes Requires Both Write Mode and admin Permission . . . . .	229
Stealing the Lock . . . . .	230
Giving Up the Lock . . . . .	230
Setting cxfs_admin Access Permissions . . . . .	230
Accessing the Correct Cluster at a Multiple-Cluster Site . . . . .	232
Getting Help . . . . .	232
Basic and Advanced Mode . . . . .	234

Using Prompting Mode . . . . .	236
Command History . . . . .	237
Waiting for Commands to Complete . . . . .	237
Entering <code>cxfs_admin</code> Commands on the Command Line . . . . .	238
Using <code>cxfs_admin</code> Script Files . . . . .	238
Exiting from <code>cxfs_admin</code> . . . . .	239
Node Tasks with <code>cxfs_admin</code> . . . . .	239
Automatically Configure a Client-Only Node . . . . .	239
Create or Modify a Node with <code>cxfs_admin</code> . . . . .	242
Delete a Node with <code>cxfs_admin</code> . . . . .	250
Enable a Node with <code>cxfs_admin</code> . . . . .	251
Disable a Node with <code>cxfs_admin</code> . . . . .	251
Show Node Information with <code>cxfs_admin</code> . . . . .	251
Enable or Disable CXFS Kernel Membership ( <code>cmsd</code> ) for the Local Node . . . . .	255
Control and Contact a Node with <code>cxfs_admin</code> . . . . .	255
Reset a Node with <code>cxfs_admin</code> . . . . .	256
Power-Cycle a Node with <code>cxfs_admin</code> . . . . .	256
NMI a Node with <code>cxfs_admin</code> . . . . .	256
Ping a Node System Controller with <code>cxfs_admin</code> . . . . .	257
Cluster Tasks with <code>cxfs_admin</code> . . . . .	257
Create a Cluster with <code>cxfs_admin</code> . . . . .	258
Modify a Cluster with <code>cxfs_admin</code> . . . . .	259
Specify a Tiebreaker with <code>cxfs_admin</code> . . . . .	260
Delete a Cluster with <code>cxfs_admin</code> . . . . .	261
Display a Cluster with <code>cxfs_admin</code> . . . . .	261
Show License Information with <code>cxfs_admin</code> . . . . .	262
CXFS Filesystem Tasks with <code>cxfs_admin</code> . . . . .	263

Create or Modify a CXFS Filesystem with <code>cxfs_admin</code> . . . . .	263
Mount a CXFS Filesystem with <code>cxfs_admin</code> . . . . .	268
Unmount a CXFS Filesystem with <code>cxfs_admin</code> . . . . .	269
Relocate the Metadata Server for a Filesystem with <code>cxfs_admin</code> . . . . .	269
Delete a CXFS Filesystem with <code>cxfs_admin</code> . . . . .	270
Show a CXFS Filesystem . . . . .	270
Network Failover Tasks with <code>cxfs_admin</code> . . . . .	271
Switch Tasks with <code>cxfs_admin</code> . . . . .	272
Create a Switch with <code>cxfs_admin</code> . . . . .	273
Delete a Switch Definition with <code>cxfs_admin</code> . . . . .	275
Show Switches with <code>cxfs_admin</code> . . . . .	275
Fencing Tasks with <code>cxfs_admin</code> . . . . .	277
Query Fence Status . . . . .	278
Raise a Fence . . . . .	278
Lower a Fence . . . . .	278
Saving and Recreating the Current Configuration with <code>cxfs_admin</code> . . . . .	279
Creating <code>cxfs_admin</code> Scripts . . . . .	279
Recreating the Cluster Using <code>cxfs_admin</code> Scripts . . . . .	280
<b>12. Administration and Maintenance . . . . .</b>	<b>281</b>
Administrative Tasks . . . . .	282
Precedence of Configuration Options . . . . .	282
CXFS Release Versions and Rolling Upgrades . . . . .	283
Upgrading Licenses . . . . .	284
General Upgrade Procedure . . . . .	285
Example Upgrade Process . . . . .	287
CXFS Relocation Capability . . . . .	291
CXFS and Cluster Administration Initialization Commands . . . . .	291

Using hafence . . . . .	292
Firewalls and CXFS Port Usage . . . . .	295
chkconfig Arguments . . . . .	296
Granting Task Execution Privileges for Users . . . . .	297
Transforming a Server-Capable Administration Node into a Client-Only Node . . . . .	297
CXFS Mount Scripts . . . . .	298
Using the Data Migration Facility (DMF) . . . . .	299
Discovering the Active Metadata Server . . . . .	301
CXFS GUI and the Active Metadata Server . . . . .	301
cxfs_admin and the Active Metadata Server . . . . .	302
clconf_info and the Active Metadata Server . . . . .	303
Shutdown of the Database and CXFS . . . . .	304
Cluster Database Shutdown . . . . .	304
Node Status and Cluster Database Shutdown . . . . .	305
Restart the Cluster Database . . . . .	305
Normal CXFS Shutdown: Stop CXFS Services or Disable the Node . . . . .	305
When You Should Not Perform Stop CXFS Services . . . . .	306
Rejoining the Cluster after Stopping CXFS Services . . . . .	307
Forced CXFS Shutdown: Revoke Membership of Local Node . . . . .	307
Node Status and Forced CXFS Shutdown . . . . .	308
Rejoining the Cluster after a Forced CXFS Shutdown . . . . .	308
Reset Capability and a Forced CXFS Shutdown . . . . .	309
Avoiding a CXFS Restart at Reboot . . . . .	309
Log File Management . . . . .	310
Filesystem Maintenance . . . . .	310
Mounting Filesystems . . . . .	311
Unmounting Filesystems . . . . .	311

Growing Filesystems . . . . .	312
Dump and Restore . . . . .	312
Hardware Changes and I/O Fencing . . . . .	313
Private Network Failover . . . . .	314
Cluster Member Removal and Restoration . . . . .	315
Manually Starting/Stopping CXFS . . . . .	316
Removing a Metadata Server from the Cluster Membership . . . . .	316
Restoring a Server-Capable Administration Node to the Cluster Membership . . . . .	318
Adding a New Server-Capable Administration Node to an Existing Cluster . . . . .	318
Add Server: Low Cell ID Number is Available . . . . .	319
Add Server: No Low Cell ID Number is Available . . . . .	321
Adjusting the Cell ID Numbers . . . . .	323
Adjust Cell ID: Low Number is Available . . . . .	324
Adjust Cell ID: No Low Number is Available . . . . .	326
Removing a Single Client-Only Node from the Cluster . . . . .	329
Restoring a Single Client-Only Node to the Cluster . . . . .	330
Stopping CXFS for the Entire Cluster . . . . .	331
Restarting the Entire Cluster . . . . .	332
XVM Volume Mapping to Storage Targets . . . . .	332
XVM Failover V2 . . . . .	333
XVM Failover Concepts . . . . .	333
failover2.conf File Concepts . . . . .	334
Generating a failover2.conf File . . . . .	336
Failover V2 Examples . . . . .	336
Example Using Two Affinities . . . . .	337
Example for Two RAID Controllers . . . . .	338
XVM Commands Related to Failover V2 . . . . .	338

RAID Units and XVM Failover V2 . . . . .	338
TP9100, RM610/660, and Failover V2 . . . . .	339
TP9300, TP9500, TP9700, and S330 and Failover V2 . . . . .	339
Generation of Streaming Workload for Video Streams . . . . .	339
Frame Files Defragmentation and Analysis . . . . .	340
Disk Layout Optimization for Approved Media Customers . . . . .	341
Ideal Frame Layout . . . . .	341
Multiple Streams of Real-Time Applications . . . . .	342
The <code>filestreams</code> Mount Option . . . . .	344
Creating a Case-Insensitive CXFS Filesystem . . . . .	346
<b>13. Cluster Database Management . . . . .</b>	<b>349</b>
Performing Cluster Database Backup and Restoration . . . . .	349
Restoring a Deleted Database from Another Node . . . . .	350
Using <code>cdbBackup</code> and <code>cdbRestore</code> for the Cluster Database and Logging Information . . . . .	351
Backing Up the Cluster Database with <code>cdbBackup</code> . . . . .	351
Restoring the Cluster Database with <code>cdbRestore</code> . . . . .	352
Validating the Cluster Configuration with <code>cxfs-config</code> . . . . .	354
<b>14. Monitoring Status . . . . .</b>	<b>363</b>
Methods to View System Status . . . . .	363
Status in Log Files . . . . .	364
Cluster, Node, and CXFS Filesystem Status . . . . .	365
CXFS GUI and Status . . . . .	365
<code>cxfs_admin</code> and Status . . . . .	366
<code>cxfs_info</code> and Status . . . . .	368
<code>clconf_info</code> and Status . . . . .	369
I/O Fencing Status . . . . .	371

XVM Statistics . . . . .	373
<b>15. Troubleshooting . . . . .</b>	<b>375</b>
Troubleshooting Strategy . . . . .	375
Know the Troubleshooting Tools . . . . .	376
Physical Storage Tools . . . . .	376
Cluster Configuration Tools . . . . .	379
Cluster Control Tools . . . . .	380
Networking Tools . . . . .	381
Cluster/Node Status Tools . . . . .	381
Performance Monitoring Tools . . . . .	382
System Dump Analysis Tool (SLES 11 on x86-64) . . . . .	383
System Dump Analysis Tool (SLES 11 on ia64) . . . . .	385
Log Files . . . . .	387
Gather Cluster Configuration with <code>cxfsdump</code> . . . . .	387
Identify the Cluster Status . . . . .	388
Eliminate a Residual Cluster . . . . .	389
Determine If a Node Is Fenced . . . . .	389
Determine the Quorum Master . . . . .	390
Locate the Problem . . . . .	390
Redirect Switch Logs . . . . .	391
Common Problems . . . . .	391
Client Membership Loss . . . . .	393
Node is Permanently Fenced . . . . .	395
GUI Connection Error . . . . .	396
Cannot Access Filesystem . . . . .	396
Log Files Consume Too Much Disk Space . . . . .	396
Unable to Define a Node . . . . .	397

System is Hung . . . . .	397
Node is Detected but Never Joins Membership . . . . .	397
Cell ID Count and Membership delivered Messages . . . . .	397
Cannot Log In . . . . .	398
I/O Error in Filesystem . . . . .	399
Cannot Mount Filesystems . . . . .	399
GUI Displays Invalid Filesystems . . . . .	400
Multiple client_timeout Values . . . . .	400
No HBA WWPNs are Detected . . . . .	400
XFS Internal Errors in System Log File . . . . .	402
Multiple Ethernet Interfaces on Altix Systems . . . . .	403
Clients Unable to Remount Filesystems . . . . .	403
Forced Filesystem Shutdown Messages and XFS File Corruption . . . . .	403
GUI Will Not Run . . . . .	405
IPMI Issues . . . . .	405
BMC Does Not Respond to a ping Command . . . . .	406
ipmitool Command Fails . . . . .	406
Node is Not Reset . . . . .	407
cxfs_admin Output is Not Current . . . . .	408
clconfd Is Not Running . . . . .	408
Inappropriate Node Membership Loss . . . . .	408
Slow Access to Files . . . . .	409
CXFS Cannot Access the Switch . . . . .	410
Altix NMI System Reset Hangs . . . . .	410
Metadata Server Panics After Reboot . . . . .	410
Portmapper Issues . . . . .	411
Brocade telnet Session is Hung . . . . .	411



Clients Cannot Join the Cluster After Relocation . . . . .	411
df Display Problems for NFSv4-Exported Filesystems . . . . .	412
mkinitrd Fails . . . . .	412
Understanding Error Messages . . . . .	412
Normal Messages . . . . .	413
Relocation Error . . . . .	416
Shutdown Failure . . . . .	416
Controller Disable Messages . . . . .	417
CMS Error Messages . . . . .	417
clconfd Daemon Death . . . . .	417
Out of Logical Swap Space . . . . .	418
Lost CXFS Membership . . . . .	418
License Key Error . . . . .	419
IP Address Error . . . . .	420
System Log File Errors . . . . .	421
General System Log File Messages . . . . .	423
cli System Log File Error Messages . . . . .	424
clconfd System Log File Error Messages . . . . .	425
crsd System Log File Error Messages . . . . .	429
cmond System Log File Error Messages . . . . .	430
cxfslicense System Log File Error Message . . . . .	431
fs2d System Log File Error Messages . . . . .	432
Log File Error Messages . . . . .	433
cad Log File Error Messages . . . . .	434
cli Log File Error Messages . . . . .	436
crsd Log File Error Messages . . . . .	437
fs2d Log File Error Messages . . . . .	438

cdbreinit Error Messages . . . . .	438
cxfs_admin Errors . . . . .	439
Mount Errors . . . . .	440
Authorization Errors . . . . .	440
Connection Error . . . . .	440
node is downrev Error . . . . .	441
EXTENT Errors . . . . .	442
GRIOv2 Errors . . . . .	442
Corrective Actions . . . . .	442
Restarting CXFS Services . . . . .	443
Clearing the Cluster Database . . . . .	444
Rebooting . . . . .	445
Rebooting without Rejoining the Cluster . . . . .	445
Recovering a Cluster with Two Server-Capable Administration Nodes . . . . .	446
Stopping and Restarting Cluster Administration Daemons . . . . .	447
Recreating the Cluster Database . . . . .	448
Verifying Connectivity in a Multicast Environment . . . . .	448
Power-Cycling a Node . . . . .	450
Resetting a Node . . . . .	450
Using SGI Knowledgebase . . . . .	451
Reporting Problems to SGI . . . . .	451
<b>Appendix A. CXFS Software Architecture . . . . .</b>	<b>453</b>
Kernel Threads . . . . .	453
Communication Paths . . . . .	455
Flow of Metadata for Reads and Writes . . . . .	459
<b>Appendix B. Path Summary . . . . .</b>	<b>463</b>

<b>Appendix C. System Reset Configuration</b>	<b>465</b>
BMC System Controller	465
L2 System Controller	472
<b>Appendix D. System Tunable Parameters</b>	<b>479</b>
Static Parameters that are Site-Configurable	480
mtcp_hb_local_options	480
mtcp_hb_period	480
mtcp_hb_watchdog	481
mtcp_nodelay	481
mtcp_rpc_thread	482
rhelpd_max	482
rhelpd_min	482
Dynamic Parameters that are Site-Configurable	483
cms_local_fail_action	483
cxfs_client_push_period	483
cxfs_dcvn_timeout	484
cxfs_extents_delta	484
cxfs_punch_hole_restrict	484
cxfs_relocation_ok	485
cxfs_server_push_period	485
cxfsd_max	486
cxfsd_min	486
mtcp_mesg_validate	487
Dynamic Parameters for Debugging Purposes Only	487
cxfs_client_range_age_max	487
cxfs_recovery_slowdown	488
cxfs_recovery_timeout_panic	488

cxfs_recovery_timeout_period . . . . .	488
cxfs_recovery_timeout_stalled . . . . .	489
cxfs_recovery_timeout_start . . . . .	489
cxfs_server_range_age_max . . . . .	489
<b>Appendix E. Migration from cmgr to cxfs_admin . . . . .</b>	<b>491</b>
<b>Appendix F. Migration from a Cluster with IRIX Server-Capable Administration Nodes . . . . .</b>	<b>493</b>
Differences Between IRIX and Linux System Administration . . . . .	493
Caveats for Migrating from IRIX . . . . .	494
Changing SGIRDAC Mode to SGIAVT Mode for SGI RAID . . . . .	494
Recreating Filesystems with the Appropriate Naming Version . . . . .	495
Recreating Filesystems with Large Block Sizes . . . . .	497
Using Project Quotas . . . . .	497
Migration Procedure . . . . .	497
Migration Troubleshooting . . . . .	501
Filesystems Will Not Mount . . . . .	501
DMF Filesystems Will Not Mount . . . . .	501
Do Not Use extlog or rdfs Filesystems . . . . .	502
<b>Appendix G. Filesystem Specifications . . . . .</b>	<b>503</b>
<b>Appendix H. Deprecated Commands . . . . .</b>	<b>505</b>
<b>Appendix I. Initial Configuration Checklist . . . . .</b>	<b>507</b>
<b>Appendix J. Summary of New Features from Previous Releases . . . . .</b>	<b>509</b>
CXFS Version 1: Original Implementation . . . . .	509
IRIX 6.5.6f . . . . .	509

IRIX 6.5.6f Update . . . . .	509
IRIX 6.5.7f . . . . .	509
IRIX 6.5.8f . . . . .	510
IRIX 6.5.9f . . . . .	510
IRIX 6.5.10f . . . . .	510
IRIX 6.5.11f . . . . .	511
CXFS Version 2: MultiOS Cluster . . . . .	511
IRIX 6.5.12f . . . . .	511
IRIX 6.5.13f . . . . .	512
IRIX 6.5.14f . . . . .	513
IRIX 6.5.15f . . . . .	514
IRIX 6.5.16f . . . . .	515
IRIX 6.5.17f . . . . .	516
IRIX 6.5.18f . . . . .	517
IRIX 6.5.19f . . . . .	518
IRIX 6.5.20f . . . . .	520
CXFS Version 3: IRIX or SGI ProPack (Linux 2.4 Kernel) Servers . . . . .	521
CXFS 3.0 . . . . .	521
CXFS 3.1 . . . . .	522
CXFS 3.2 . . . . .	523
CXFS 3.2 Update . . . . .	523
CXFS 3.3 . . . . .	524
CXFS 3.4 . . . . .	525
CXFS Version 4: IRIX or SGI ProPack (Linux 2.6 Kernel) Servers . . . . .	525
CXFS 4.0 . . . . .	525
CXFS 4.1 . . . . .	527
CXFS 4.2 . . . . .	529
CXFS Version 5: Linux Servers . . . . .	530
CXFS 5.0 . . . . .	530
CXFS 5.2 . . . . .	532

Contents

---

CXFS 5.4	. . . . .	532
CXFS 5.6	. . . . .	533
<b>Glossary</b>	. . . . .	<b>535</b>
<b>Index</b>	. . . . .	<b>551</b>

---

## Figures

<b>Figure 1-1</b>	Pool and Cluster Concepts . . . . .	13
<b>Figure 1-2</b>	Installation Differences . . . . .	17
<b>Figure 1-3</b>	One Metadata Server (No Relocation or Recovery) . . . . .	18
<b>Figure 1-4</b>	Two Metadata Servers for Two Filesystems . . . . .	20
<b>Figure 1-5</b>	Three Metadata Servers for Four Filesystems . . . . .	22
<b>Figure 1-6</b>	Relocation versus Recovery . . . . .	28
<b>Figure 1-7</b>	CXFS Manager GUI . . . . .	41
<b>Figure 2-1</b>	I/O Fencing . . . . .	59
<b>Figure 5-1</b>	Server-Side License Keys . . . . .	107
<b>Figure 5-2</b>	Server-Side License Keys: Adding a New Client-Only Node . . . . .	108
<b>Figure 9-1</b>	CXFS Manager . . . . .	144
<b>Figure 10-1</b>	CXFS Manager GUI Showing Details for a Node . . . . .	163
<b>Figure 10-2</b>	Pop-up Menu that Appears After Clicking the Right Mouse Button . . . . .	164
<b>Figure 10-3</b>	Example Node Definition . . . . .	186
<b>Figure 10-4</b>	Example System Reset Settings . . . . .	187
<b>Figure 10-5</b>	Bit Mask Representation for I/O Fencing . . . . .	204
<b>Figure 10-6</b>	Task Privileges for a Specific User . . . . .	220
<b>Figure 12-1</b>	Precedence of Configuration Options . . . . .	283
<b>Figure 12-2</b>	Example Rolling Upgrade Procedure (part 1) . . . . .	288
<b>Figure 12-3</b>	Example Rolling Upgrade Procedure (part 2) . . . . .	289
<b>Figure 12-4</b>	Example Rolling Upgrade Procedure (part 3) . . . . .	290
<b>Figure 12-5</b>	GUI Window Showing the Metadata Server . . . . .	302
<b>Figure 12-6</b>	Disk Paths . . . . .	334

<b>Figure 12-7</b>	Ideal Frame Layout . . . . .	341
<b>Figure 12-8</b>	Ideal Frame Layout with RAID Prefetch . . . . .	342
<b>Figure 12-9</b>	Multiple Streams of Real-Time Applications . . . . .	343
<b>Figure 12-10</b>	Poor Cache Utilization . . . . .	344
<b>Figure 12-11</b>	Excellent Cache Utilization . . . . .	346
<b>Figure 14-1</b>	pmchart . . . . .	374
<b>Figure A-1</b>	Communication Within One Server-Capable Administration Node . . . . .	455
<b>Figure A-2</b>	Daemon Communication Within One Server-Capable Administration Node . . . . .	456
<b>Figure A-3</b>	Communication Among Nodes in the Pool . . . . .	457
<b>Figure A-4</b>	Communication for a Server-Capable Administration Node Not in a Cluster . . . . .	458
<b>Figure A-5</b>	Communication Among Nodes . . . . .	459
<b>Figure A-6</b>	Metadata Flow on a Write . . . . .	460
<b>Figure A-7</b>	Metadata Flow on a Read on Client B Following a Write on Client A . . . . .	461
<b>Figure A-8</b>	Metadata Flow on a Read on Client B Following a Read on Client A . . . . .	462
<b>Figure C-1</b>	L2 Access via the Ethernet Port on an A450 . . . . .	473
<b>Figure C-2</b>	SGI Altix 450 System Control Network . . . . .	474
<b>Figure C-3</b>	Altix 350 Rear Panel . . . . .	475
<b>Figure C-4</b>	L2 Rear Panel . . . . .	475
<b>Figure C-5</b>	IX-brick Rear Panel . . . . .	476
<b>Figure C-6</b>	Altix 3000 Connections . . . . .	477



---

## Tables

<b>Table 1-1</b>	Configuration Commands . . . . .	39
<b>Table 1-2</b>	Cluster Administration Daemons . . . . .	43
<b>Table 1-3</b>	CXFS Control Daemons . . . . .	44
<b>Table 1-4</b>	Other Administrative Commands . . . . .	45
<b>Table 3-1</b>	Number of LUNs Supported . . . . .	92
<b>Table 5-1</b>	Examples of License Keys Required for Cluster Changes . . . . .	109
<b>Table 8-1</b>	<code>fs2d.options</code> File Options . . . . .	132
<b>Table 8-2</b>	<code>clconfd.options</code> File Options . . . . .	134
<b>Table 10-1</b>	GUI Platforms . . . . .	161
<b>Table 10-2</b>	Command Buttons . . . . .	167
<b>Table 10-3</b>	Key to Icons . . . . .	174
<b>Table 10-4</b>	Key to States . . . . .	177
<b>Table 11-1</b>	<code>cxfs_admin</code> Environment Variables . . . . .	228
<b>Table 11-2</b>	System Controller Types . . . . .	250
<b>Table 12-1</b>	Initialization Commands . . . . .	292
<b>Table 12-2</b>	<code>chkconfig</code> Arguments for Server-Capable Administration Nodes . . . . .	296
<b>Table 15-1</b>	Error Strings . . . . .	393
<b>Table 15-2</b>	System Log File Error Message Format . . . . .	422
<b>Table 15-3</b>	Log File Error Message Format . . . . .	434
<b>Table A-1</b>	Kernel Threads . . . . .	454
<b>Table B-1</b>	Paths for Server-Capable Administration Nodes . . . . .	463
<b>Table H-1</b>	Deprecated Commands . . . . .	505



---

## About This Guide

This guide documents CXFS 6.0 running on a storage area network (SAN). It assumes that you are already familiar with the XFS filesystem and you have access to the *XVM Volume Manager Administrator's Guide*.

You should read through this entire book, especially Chapter 15, "Troubleshooting" on page 375, before attempting to install and configure a CXFS cluster.

## Related Publications

For information about this release, see the following release notes:

- SGI InfiniteStorage Software Platform (ISSP): `README.txt`
- CXFS:
  - `README_CXFS_GENERAL.txt`
  - `README_CXFS_LINUX.txt`
  - `README_CXFS_MACOSX.html`
  - `README_CXFS_WINDOWS.html`

The following documents contain additional information:

- *DMF 5 Administrator's Guide for SGI InfiniteStorage*
- *CXFS 6 Client-Only Guide for SGI InfiniteStorage*
- *XVM Volume Manager Administrator's Guide*
- *Linux Configuration and Operations Guide*
- The user guide and quick start guide for your SGI Altix or SGI Altix XE system
- *Guide to Programming Environments and Tools Available on SGI Altix XE System*
- *NIS Administrator's Guide*
- *Personal System Administration Guide*
- *Performance Co-Pilot for Linux User's and Administrator's Guide*

- *SGI Foundation Software 2 Start Here*
- *SGI ProPack 7 for Linux Start Here*
- *SGI L1 and L2 Controller Software User's Guide*

The following man pages are provided on CXFS server-capable administration nodes:

---

Man Page	Software Product
<code>cbeutil(8)</code>	<code>cluster_admin</code>
<code>cdbBackup(8)</code>	<code>cluster_admin</code>
<code>cdbRestore(8)</code>	<code>cluster_admin</code>
<code>cdbconfig(8)</code>	<code>cluster_admin</code>
<code>cdbutil(8)</code>	<code>cluster_admin</code>
<code>cmond(8)</code>	<code>cluster_admin</code>
<code>cms_failconf(8)</code>	<code>cluster_services</code>
<code>cms_intervene(8)</code>	<code>cluster_control</code>
<code>crsd(8)</code>	<code>cluster_services</code>
<code>cxfslicense(8)</code>	<code>cluster_admin</code>
<code>cxfs_admin(8)</code>	<code>cxfs_admin</code>
<code>cxfs-config(8)</code>	<code>cxfs_util</code>
<code>cxfsdump(8)</code>	<code>cxfs_util</code>
<code>cxfsmgr(8)</code>	<code>sgi-sysadm_cxfs-client</code>
<code>cxfscp(1)</code>	<code>cxfs_util</code>
<code>fs2d(8)</code>	<code>cluster_admin</code>
<code>xvm(5)</code>	<code>cxfs-xvm-cmds</code>
<code>xvm(8)</code>	<code>cxfs-xvm-cmds</code>
<code>xvmgr(1)</code>	<code>sgi-sysadm_xvm-client</code>

---

## Obtaining Publications

You can obtain SGI documentation as follows:

- See the SGI Technical Publications Library at <http://docs.sgi.com>. Various formats are available. This library contains the most recent and most comprehensive set of online books, man pages, and other information.
- The `/docs` directory on the ISSP DVD or in the Supportfolio download directory contains the following:
  - The ISSP release note: `/docs/README.txt`
  - Other release notes: `/docs/README_NAME.txt`
  - A complete list of the packages and their location on the media:  
`/docs/RPMS.txt`
  - The packages and their respective licenses: `/docs/PACKAGE_LICENSES.txt`
- The release notes and manuals are provided in the `noarch/sgi-isspdocs` RPM and will be installed on the system into the following location:  
`/usr/share/doc/packages/sgi-issp-ISSPVERSION-TITLE`
- You can view man pages by typing `man title` at a command line.

---

**Note:** The external websites referred to in this guide were correct at the time of publication, but are subject to change.

---

## Conventions

This guide uses the following terminology abbreviations:

- *Linux* refers to any supported distribution of Linux, including those platforms running SGI Foundation Software software, unless otherwise specified
- *Windows* refers to Microsoft Windows 2000, Microsoft Windows 2003, Microsoft Windows XP, and Microsoft Windows Vista

- *SGI Foundation Software* refers to SGI Foundation Software for Linux running the `default` kernel on SGI Altix systems and the `smp` kernel of SGI Altix XE systems, as specified in the release notes

The following conventions are used throughout this document:

<b>Convention</b>	<b>Meaning</b>
<code>command</code>	This fixed-space font denotes literal items such as commands, files, routines, path names, signals, messages, and programming language structures.
<i>variable</i>	Italic typeface denotes variable entries and words or concepts being defined.
<b>user input</b>	This bold, fixed-space font denotes literal items that the user enters in interactive sessions. (Output is shown in nonbold, fixed-space font.)
[ ]	Brackets enclose optional portions of a command or directive line.
<b>GUI element</b>	This bold font denotes the names of graphical user interface (GUI) elements, such as windows, screens, dialog boxes, menus, toolbars, icons, buttons, boxes, and fields.
<TAB>	Represents pressing the specified key in an interactive session
<code>server-admin#</code>	In an example, this prompt indicates that the command is executed on a server-capable administration node
<code>client#</code>	In an example, this prompt indicates that the command is executed on a client-only node
<code>MDS#</code>	In an example, this prompt indicates that the command is executed on an active metadata server
<code>#</code>	In an example, this prompt indicates that the command is executed on an any node

*specificnode#*

In an example, this prompt indicates that the command is executed on a node named *specificnode* or of node type *specificnode*

This guide uses *Windows* to refer to both Microsoft Windows 2000 and Microsoft Windows XP nodes when the information applies equally to both. Information that applies to only one of these types of nodes is identified.

## Reader Comments

If you have comments about the technical accuracy, content, or organization of this publication, contact SGI. Be sure to include the title and document number of the publication with your comments. (Online, the document number is located in the front matter of the publication. In printed publications, the document number is located at the bottom of each page.)

You can contact SGI in any of the following ways:

- Send e-mail to the following address:

techpubs@sgi.com

- Contact your customer service representative and ask that an incident be filed in the SGI incident tracking system.
- Send mail to the following address:

SGI  
Technical Publications  
46600 Landing Parkway  
Fremont, CA 94538

SGI values your comments and will respond to them promptly.





## Introduction to CXFS

This chapter discusses the following:

- "What is CXFS?" on page 1
- "Comparison of XFS and CXFS" on page 3
- "Comparison of Network and CXFS Filesystems" on page 7
- "Cluster Environment Concepts" on page 10
- "CXFS Interoperability With Other Products and Features" on page 29
- "Hardware and Software Requirements for Server-Capable Administration Nodes" on page 35
- "CXFS Software Products Installed on Server-Capable Administration Nodes" on page 37
- "CXFS Tools" on page 38

### What is CXFS?

CXFS is clustered XFS, a parallel-access shared clustered filesystem for high-performance computing environments. CXFS allows groups of computers to coherently share XFS filesystems among multiple hosts and storage devices while maintaining high performance. CXFS runs on storage area network (SAN) RAID storage devices, such as Fibre Channel. A SAN is a high-speed, scalable network of servers and storage devices that provides storage resource consolidation, enhanced data access, and centralized storage management.

CXFS filesystems are mounted across the cluster by CXFS management software. All files in the filesystem are available to all hosts (called *nodes*) that mount the filesystem. All shared filesystems must be built on top of cluster-owned XVM volumes.

CXFS provides a single-system view of the filesystems; each host in the SAN has equally direct access to the shared disks and common pathnames to the files. CXFS lets you scale the shared-filesystem performance as needed by adding disk channels and storage to increase the direct host-to-disk bandwidth. The CXFS shared-file performance is not limited by LAN speeds or a bottleneck of data passing through a

centralized fileserver. It combines the speed of near-local disk access with the flexibility, scalability, and reliability of clustering.

To provide stability and performance, CXFS uses a private network and separate paths for data and *metadata* (information that describes a file, such as the file's name, size, location, and permissions). Each request is handled in a separate thread of execution, without limit, making CXFS execution highly parallel.

CXFS provides centralized administration with an intuitive graphical user interface (GUI) and command-line interface. See "CXFS Tools" on page 38.

CXFS provides full cache coherency across heterogeneous nodes running multiple operating systems. CXFS supports:

- Server-capable administration nodes running SGI Foundation Software on SUSE Linux Enterprise Server (SLES) operating system on either all SGI Altix ia64 systems or all SGI Altix XE x86-64 systems (do not mix architectures of server-capable administration nodes, see "Use the Same Architecture for All Server-Capable Administration Nodes" on page 50).

---

**Note:** CXFS does not support the Altix XE310, Altix XE320, or Altix XE340 as a server-capable administration node.

---

See the CXFS release notes for the supported kernels, update levels, and service pack levels.

---

**Note:** SGI ProPack 6 may be optionally installed on any CXFS server-capable administration node or client-only node running SGI Foundation Software.

---

- Client-only nodes running any mixture of the following operating systems:
  - Apple Mac OS X
  - Red Hat Enterprise Linux (RHEL)
  - SUSE Linux Enterprise Server (SLES)
  - SGI Foundation Software on RHEL
  - SGI Foundation Software on SLES
  - Microsoft Windows

See the CXFS release notes for the supported kernels, update levels, and service pack levels. For additional details about client-only nodes, see the *CXFS 6 Client-Only Guide for SGI InfiniteStorage*.

CXFS provides the following high-availability (HA) features:

- Replicated cluster database
- XVM path failover (failover version 2)
- Server failover
- Network failover

You can use the supported high-availability (HA) product in conjunction with CXFS to failover associated applications. See "Highly Available Services" on page 30.

## Comparison of XFS and CXFS

CXFS uses the same filesystem structure as XFS. A CXFS filesystem is initially created using the same `mkfs` command used to create standard XFS filesystems.

This section discusses the following:

- "Differences in Filesystem Mounting and Management" on page 4
- "Supported XFS Features" on page 5
- "When to Use CXFS" on page 6
- "Performance Considerations" on page 6

## Differences in Filesystem Mounting and Management

The primary difference between XFS and CXFS filesystems is the way in which filesystems are mounted and managed:

- In XFS:
  - XFS filesystems are mounted with the `mount` command directly by the system during boot via an entry in the `/etc/fstab` file.
  - An XFS filesystem resides on only one host.
  - The `/etc/fstab` file contains static information about XFS filesystems. For more information, see the `fstab(5)` man page.
- In CXFS:
  - CXFS filesystems are mounted using the CXFS graphical user interface (GUI) or the `cxfs_admin` command. See "CXFS Tools" on page 38.
  - A CXFS filesystem is accessible to those nodes in the cluster that are defined to mount it. CXFS filesystems are mounted across the cluster by CXFS management software. All files in the CXFS filesystem are visible to those nodes that are defined to mount the filesystem.
  - One node coordinates the updating of metadata on behalf of all nodes in a cluster; this is known as the *metadata server*.
  - The filesystem information is stored in the *cluster database (CDB)*, which contains persistent static configuration information about the filesystems, nodes, and cluster. The CXFS cluster administration daemons manage the distribution of multiple synchronized copies of the cluster database across the nodes that are capable of becoming metadata servers (the *server-capable administration nodes*). The administrator can view the database and modify it using the CXFS administration tools (see "CXFS Tools" on page 38).
  - Information is **not** stored in the `/etc/fstab` file. (However, the CXFS filesystems do show up in the `/etc/mtab` file.) For CXFS, information is instead stored in the cluster database.

## Supported XFS Features

XFS features that are also present in CXFS include the following:

- Reliability and fast (subsecond) recovery of a log-based filesystem.
- 64-bit scalability to 9 million terabytes (9 exabytes) per file.
- Speed:
  - High *bandwidth* (megabytes per second)
  - High *transaction rates* (I/O per second)
  - Fast metadata operations
- Dynamically allocated metadata space.
- Quotas. See "Quotas Differences" on page 33.
- Filesystem reorganizer (defragmenter), which must be run from the CXFS metadata server for a given filesystem. See the `fsr_xfs(8)` man page.
- Restriction of access to files using file permissions and access control lists (ACLs). You can also use logical unit (LUN) masking or physical cabling to deny access from a specific node to a specific set of LUNs in the SAN.
- External log filesystems

CXFS preserves these underlying XFS features while distributing the I/O directly between the LUNs and the nodes. The efficient XFS I/O path uses asynchronous buffering techniques to avoid unnecessary physical I/O by delaying writes as long as possible. This allows the filesystem to allocate the data space efficiently and often contiguously. The data tends to be allocated in large contiguous chunks, which yields sustained high bandwidths.

The XFS directory structure is based on B-trees, which allow XFS to maintain good response times even as the number of files in a directory grows to tens or hundreds of thousands of files.

## When to Use CXFS

You should use CXFS when you have multiple nodes running applications that require high-bandwidth access to common filesystems. CXFS performs best under the following conditions:

- Data I/O operations are greater than 16 KB
- Large files are being used (a lot of activity on small files will result in slower performance)
- Read/write conditions are one of the following:
  - All processes that perform reads/writes for a given file reside on the same node
  - The same file is read by processes on multiple nodes using buffered I/O, but there are no processes writing to the file
  - The same file is read and written by processes on more than one node using direct-access I/O

For most filesystem loads, the scenarios above represent the bulk of the file accesses. Thus, CXFS delivers fast local file performance. CXFS is also useful when the amount of data I/O is larger than the amount of metadata I/O. CXFS is faster than NFS because the data does not go through the network.

## Performance Considerations

CXFS may not give optimal performance under the following circumstances, and you should give extra consideration to using CXFS in these cases:

- When you want to access files only on the local host.
- When distributed applications write to shared files that are memory mapped.
- When access would be as slow with CXFS as with network filesystems, such as with the following:
  - Small files
  - Low bandwidth
  - Lots of metadata transfer

Metadata operations can take longer to complete through CXFS than on local filesystems. Metadata transaction examples include the following:

- Opening and closing a file
- Changing file size (usually extending a file)
- Creating and deleting files
- Searching a directory

In addition, multiple processes on multiple hosts that are reading and writing the same file using buffered I/O can be slower with CXFS than when using a local filesystem. This performance difference comes from maintaining coherency among the distributed file buffers; a write into a shared, buffered file will invalidate data (pertaining to that file) that is buffered in other hosts.

For a high-performance NFS edge serving configuration (in which CXFS client nodes can export data with NFS), contact SGI Professional Services.

## Comparison of Network and CXFS Filesystems

Network filesystems and CXFS filesystems perform many of the same functions, but with important performance and functional differences noted here:

- "Network Filesystems" on page 7
- "CXFS Filesystems" on page 8

### Network Filesystems

Accessing remote files over local area networks (LANs) can be significantly slower than accessing local files. The network hardware and software introduces delays that tend to significantly lower the transaction rates and the bandwidth. These delays are difficult to avoid in the client-server architecture of LAN-based network filesystems. The delays stem from the limits of the LAN bandwidth, latency, and shared path through the data server.

LAN bandwidths force an upper limit for the speed of most existing shared filesystems. This can be one to several orders of magnitude slower than the bandwidth possible across multiple disk channels to local or shared disks. The layers of network protocols and server software also tend to limit the bandwidth rates.

A shared fileserver can be a bottleneck for performance when multiple clients wait their turns for data, which must pass through the centralized fileserver. For example, NFS and Samba servers read data from disks attached to the server, copy the data into UDP/IP or TCP/IP packets, and then send it over a LAN to a client host. When many clients access the server simultaneously, the server's responsiveness degrades.

## CXFS Filesystems

A CXFS filesystem is a clustered XFS filesystem that allows for logical file sharing similar to network filesystems, but with significant performance and functionality advantages. CXFS runs on top of a SAN, where each node in the cluster has direct high-speed data channels to a shared set of disks.

This section discusses the following:

- "CXFS Features" on page 8
- "CXFS Restrictions" on page 9

## CXFS Features

CXFS has the following unique features:

- A *peer-to-disk* model for the data access. The shared files are treated as local files by all of the nodes in the cluster. Each node can read and write the disks at near-local disk speeds; the data passes directly from the disks to the node requesting the I/O, without passing through a data server or over a LAN. For the data path, each node is a peer on the SAN; each can have equally fast direct data paths to the shared disks. Therefore, adding disk channels and storage to the SAN can scale the bandwidth. On large systems, the bandwidth can scale to gigabytes and even tens of gigabytes per second. Compare this with a network filesystem where the data is typically flowing over a gigabit LAN.

This peer-to-disk data path also removes the fileserver data-path bottleneck found in most LAN-based shared filesystems.

- Each node can buffer the shared disk much as it would for locally attached disks. CXFS maintains the coherency of these distributed buffers, preserving the advanced buffering techniques of the XFS filesystem.
- A flat, single-system view of the filesystem; it is identical from all nodes sharing the filesystem and is not dependent on any particular node. The pathname is a normal POSIX pathname; for example, `/data/username/directory`.



---

**Note:** A Windows CXFS client uses the same pathname to the filesystem as other clients beneath a preconfigured drive letter.

---

The path does not vary if the metadata server moves from one node to another or if a metadata server is added or replaced. This simplifies storage management for administrators and users. Multiple processes on one node and processes distributed across multiple nodes have the same view of the filesystem, with performance similar on each node.

This differs from typical network filesystems, which tend to include the name of the fileserver in the pathname. This difference reflects the simplicity of the SAN architecture with its *direct-to-disk* I/O compared with the extra hierarchy of the LAN filesystem that goes through a named server to reach the disks.

- A full UNIX filesystem interface, including POSIX, System V, and BSD interfaces. This includes filesystem semantics such as mandatory and advisory record locks. No special record-locking library is required.

## CXFS Restrictions

CXFS has the following restrictions:

- Some filesystem semantics are not appropriate and not supported in shared filesystems. For example, the root filesystem is not an appropriate shared filesystem. Root filesystems belong to a particular node, with system files configured for each particular node's characteristics.
- All processes using a named pipe must be on the same node.
- Hierarchical storage management (HSM) applications such as the Data Migration Facility (DMF) must run on the active metadata server.

The following features are not supported in CXFS:

- The original XFS guaranteed-rate I/O (GRIO) implementation, GRIO version 1.

---

**Note: GRIO version 2 (GRIOv2)** is supported, see "Guaranteed-Rate I/O (GRIO) Version 2 Overview" on page 31.

---

- Swap to a file residing on a CXFS filesystem.
- XVM failover version 1
- Real-time filesystems

## Cluster Environment Concepts

This section defines the concepts necessary to understand CXFS:

- "Metadata" on page 11
- "Node" on page 11
- "RAID" on page 11
- "LUN" on page 11
- "Cluster" on page 11
- "Pool" on page 12
- "Node Types, Node Functions, and the Cluster Database" on page 13
- "Membership" on page 23
- "Private Network" on page 23
- "Data Integrity Protection" on page 25
- "CXFS Tiebreaker" on page 26
- "Relocation" on page 26
- "Recovery" on page 27
- "CXFS Services" on page 29

Also see the Glossary on page 535.

## Metadata

*Metadata* is information that describes a file, such as the file's name, size, location, and permissions. Metadata tends to be small, usually about 512 bytes per file in XFS. This differs from the *data*, which is the contents of the file. The data may be many megabytes or gigabytes in size.

## Node

A *node* is an operating system (OS) image, usually an individual computer.

## RAID

A redundant array of independent disks.

## LUN

A logical unit number (LUN) is a representation of disk space. In a RAID, the disks are not individually visible because they are behind the RAID controller. The RAID controller will divide up the total disk space into multiple LUNs. The operating system sees a LUN as a hard disk. A LUN is what XVM uses as its physical volume (*physvol*). For more information, see the *XVM Volume Manager Administrator's Guide*.

## Cluster

A *cluster* is the set of nodes configured to work together as a single computing resource. A cluster is identified by a simple name and a cluster identification (ID) number. A cluster running multiple operating systems is known as a *multiOS cluster*. A given node can be a member of only one cluster.

LUNs are assigned to a cluster by recording the name of the cluster on the LUN. Thus, if any LUN is accessible (via a Fibre Channel connection) from nodes in different clusters, then those clusters must have unique names. When members of a cluster send messages to each other, they identify their cluster via the cluster ID. Cluster names and IDs must be unique.

Because of the above restrictions on cluster names and IDs, and because cluster names and IDs cannot be changed after the cluster is created (without deleting the cluster and recreating it), SGI advises that you choose unique names and IDs for each of the clusters within your organization.

## Pool

The *pool* is the set of nodes from which a particular cluster may be formed. (All nodes created when using the `cxfs_admin` tool are automatically part of the cluster, so the concept of the pool is obsolete when using `cxfs_admin`.)

Only one cluster may be configured from a given pool, and it need not contain all of the available nodes. (Other pools may exist, but each is disjoint from the other. They share no node or cluster definitions.)

A pool is first formed when you connect to a given server-capable administration node (see "Node Types, Node Functions, and the Cluster Database" on page 13) and define that node in the cluster database using the GUI. You can then add other nodes to the pool by defining them while still connected to the first node. (If you were to connect to a different server-capable administration node and then define it, you would be creating a second pool).

Figure 1-1 shows the concepts of pool and cluster. Node9 and Node10 have been defined as nodes in the CXFS pool, but they have not been added to the cluster definition.

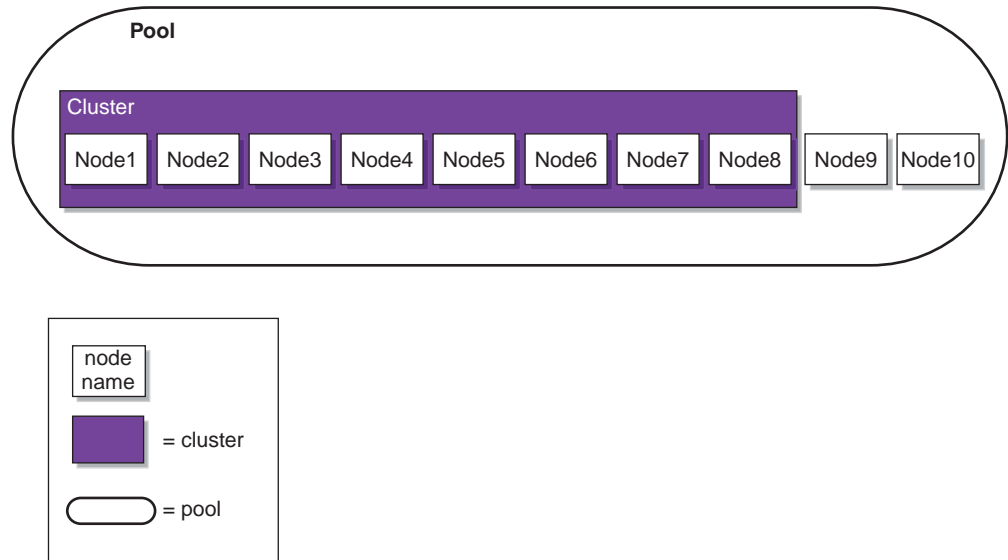


Figure 1-1 Pool and Cluster Concepts

## Node Types, Node Functions, and the Cluster Database

The *cluster database* (CDB) contains configuration and logging information. A node is defined in the cluster database as one of the following types:

- *Server-capable administration node*, which is installed with the `cluster_admin` software product and contains the full set of cluster administration daemons (`fs2d`, `crsd`, `cad`, and `cmd`) and the CXFS server-capable administration node control daemon (`clconfd`). Only nodes running Linux with SGI Foundation Software can be server-capable administration nodes. This node type is capable of coordinating cluster activity and metadata. Multiple synchronized copies of the database are maintained across the server-capable administration nodes in the pool by the *cluster administration daemons*.

---

**Note:** For any given configuration change, the CXFS cluster administration daemons must apply the associated changes to the cluster database and distribute the changes to each server-capable administration node before another change can take place.

---

For more details, see:

- "Cluster Administration Daemons" on page 43
- "CXFS Control Daemons" on page 44
- Appendix A, "CXFS Software Architecture" on page 453
- *Client-only node*, which is installed with the `cxfs_client` software product and that has a minimal implementation of CXFS that runs the CXFS client control daemon (`cxfs_client`). The client-only nodes in the pool do not maintain a local synchronized copy of the full cluster database. Instead, one of the daemons running on a server-capable administration node provides relevant database information to the client-only nodes. If the set of server-capable administration nodes changes, another node may become responsible for updating the client-only nodes. This node can run any supported operating system.

This node can safely mount CXFS filesystems but it cannot become a CXFS metadata server or perform cluster administration. Client-only nodes retrieve the information necessary for their tasks by communicating with a server-capable administration node. This node does not contain a copy of the cluster database.

For more details, see:

- "CXFS Control Daemons" on page 44
- Appendix A, "CXFS Software Architecture" on page 453
- *CXFS 6 Client-Only Guide for SGI InfiniteStorage*

For each CXFS filesystem, one server-capable administration node is responsible for updating that filesystem's metadata. This node is referred to as the *metadata server*.

Multiple server-capable administration nodes can be defined as *potential metadata servers* for a given CXFS filesystem, but only one node per filesystem is chosen to function as the *active metadata server*, based on various factors. There can be multiple active metadata servers in the cluster, one per CXFS filesystem.

All other nodes that mount a CXFS filesystem function as CXFS *clients*. A server-capable administration node can function at any point in time as either an active metadata server or a CXFS client, depending upon how it is configured and whether it is chosen to function as the active metadata server.

---

**Note:** Do not confuse *CXFS client* and *metadata server* with the traditional data-path client/server model used by network filesystems. Only the metadata information passes through the metadata server via the private Ethernet network; the data is passed directly to and from storage on the CXFS client via the Fibre Channel connection.

---

The metadata server must perform cluster-coordination functions such as the following:

- Metadata logging
- File locking
- Buffer coherency
- Filesystem block allocation

All CXFS requests for metadata are routed over a TCP/IP network and through the metadata server, and all changes to metadata are sent to the metadata server. The metadata server uses the advanced XFS journal features to log the metadata changes. Because the size of the metadata is typically small, the bandwidth of a fast Ethernet local area network (LAN) is generally sufficient for the metadata traffic.

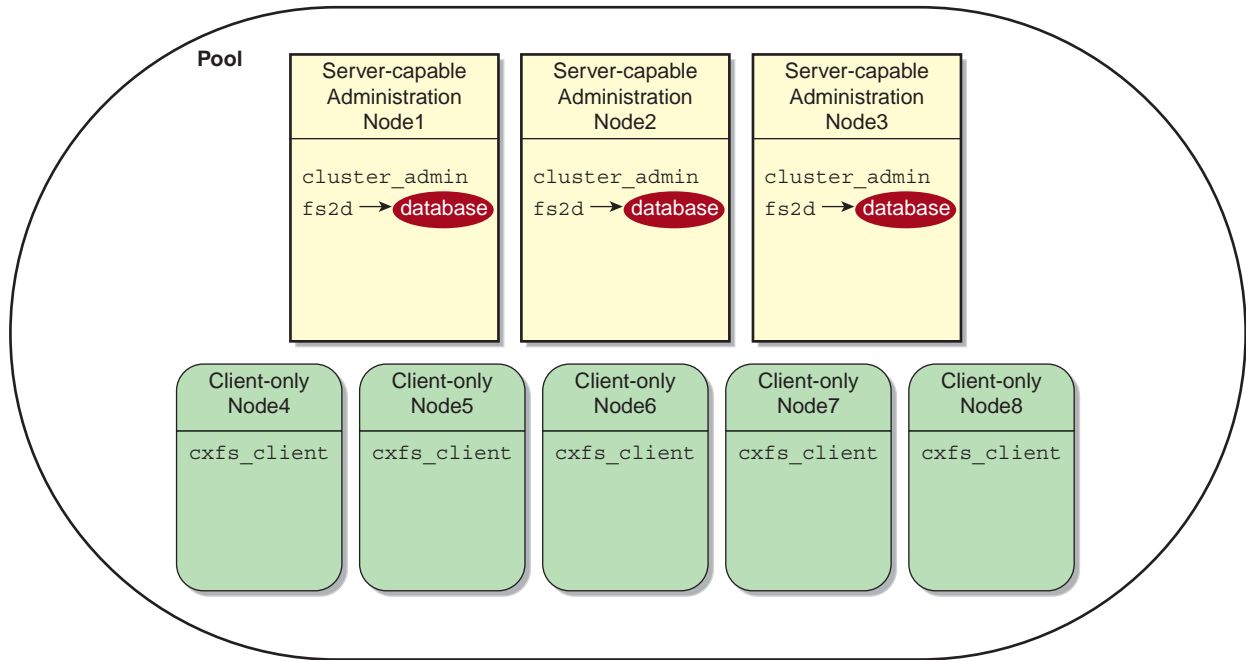
The operations to the CXFS metadata server are typically infrequent compared with the data operations directly to the LUNs. For example, opening a file causes a request for the file information from the metadata server. After the file is open, a process can usually read and write the file many times without additional metadata requests. When the file size or other metadata attributes for the file change, this triggers a metadata operation.

The following rules apply:

- If another potential metadata server exists, recovery will take place. For more information, see "Recovery" on page 27.
- If the last potential metadata server for a filesystem goes down while there are active CXFS clients, all of the clients will be forced out of the filesystem.
- If you are exporting the CXFS filesystem to be used with other NFS clients, the filesystem should be exported from the active metadata server for best performance (which might require manually relocating the metadata server). For more information on NFS exporting of CXFS filesystems, see "CXFS Mount Scripts" on page 298. For a high-performance NFS edge serving configuration (in which CXFS client nodes can export data with NFS), contact SGI Professional Services.
- There should be an odd number of server-capable administration nodes with CXFS services running for quorum calculation purposes. If you have a cluster that consists of only two server-capable administration nodes, you should use system reset and you should not use a tiebreaker. If the cluster has more than one server-capable administration node and at least one client-only node, SGI recommends that you define a stable client-only node as the CXFS tiebreaker. See "CXFS Tiebreaker" on page 26 and "Use an Odd Number of Server-Capable Administration Nodes" on page 53.

Figure 1-2 shows nodes in a pool that are installed with the `cluster_admin` software product and others that are installed with the `cxfs_client` software product. Only those nodes with the `cluster_admin` software product have the `fs2d` daemon and therefore a copy of the cluster database. (For more information, see Table 1-2 on page 43 and Table 1-3 on page 44.)





**Figure 1-2** Installation Differences

A *standby node* is a server-capable administration node that is configured as a potential metadata server for a given filesystem.

Ideally, all server-capable administration nodes will run the same version of the operating system. However, SGI supports a policy for CXFS that permits a rolling upgrade; see "CXFS Release Versions and Rolling Upgrades" on page 283.

The following figures show a few configuration possibilities. The potential metadata servers are required to be server-capable administration nodes; the other nodes should be client-only nodes.

Figure 1-3 shows a very simple configuration with a single metadata server and no potential (standby) metadata servers; recovery and relocation do not apply to this cluster. The database exists only on the server-capable administration node. The client-only nodes could be running any supported operating system.

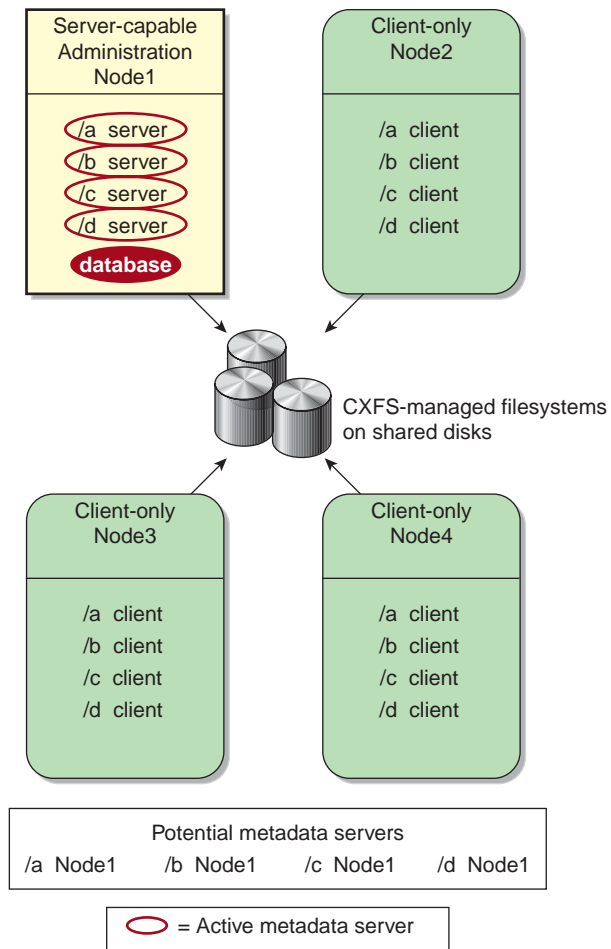


Figure 1-3 One Metadata Server (No Relocation or Recovery)

Figure 1-4 shows a configuration with two server-capable administration nodes, both of which are potential metadata servers for filesystems /a and /b:

- Node1 is the active metadata server for /a
- Node2 is the active metadata server for /b

Neither Node1 nor Node2 runs applications because they are both potential metadata servers. For simplicity, the figure shows one client-only node, but there could be many. One client-only node should be the tiebreaker so that the configuration remains stable if one of the server-capable administration nodes is disabled.

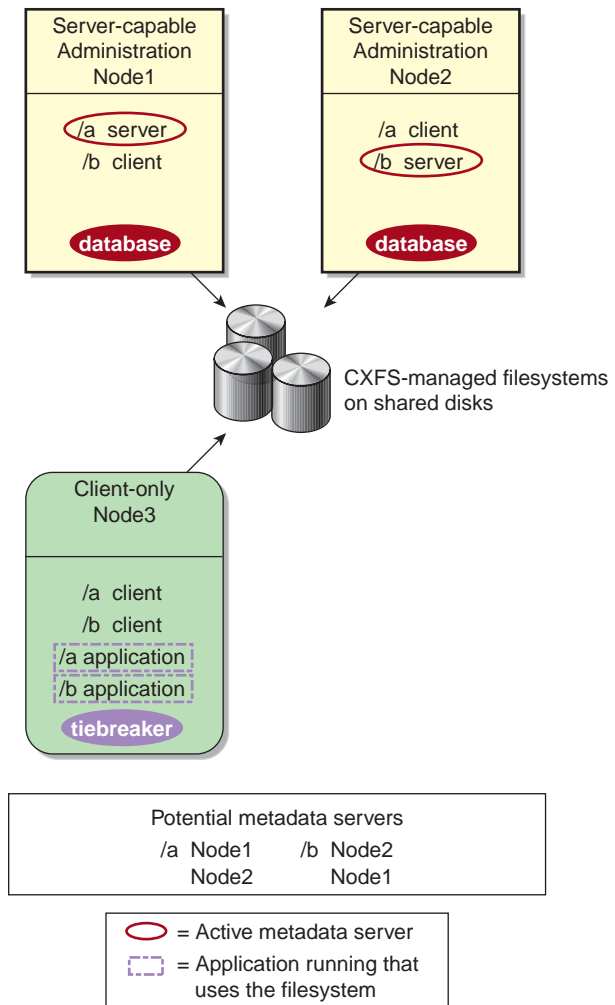


Figure 1-4 Two Metadata Servers for Two Filesystems

Figure 1-5 shows three server-capable administration nodes as active metadata servers. Node1 is the active metadata server for both filesystems /a and /b. If Node1 failed, Node2 would take over as the active metadata server according to the list of potential metadata servers for filesystems /a and /b.

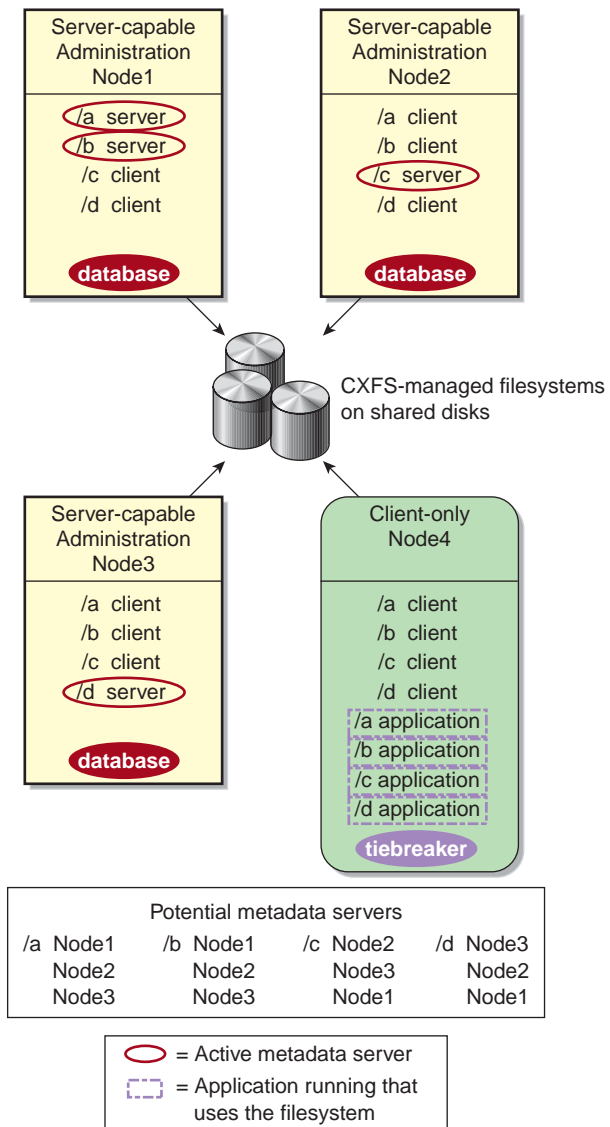


Figure 1-5 Three Metadata Servers for Four Filesystems

## Membership

The nodes in a cluster must act together to provide a service. To act in a coordinated fashion, each node must know about all the other nodes currently active and providing the service. The set of nodes that are currently working together to provide a service is called a *membership*:

- *Cluster database membership* is the group of server-capable administration nodes that are accessible to each other. (Client-only nodes are not eligible for cluster database membership.) The nodes that are part of the cluster database membership work together to coordinate configuration changes to the cluster database. One node is chosen to be the *quorum master*, which is the node that propagates the cluster database to the other server-capable administration nodes in the pool. (See "Determine the Quorum Master" on page 390.)
- *CXFS kernel membership* is the group of CXFS nodes in the cluster that can actively share filesystems, as determined by the CXFS kernel, which manages membership and CXFS kernel heartbeating. The CXFS kernel membership may be a subset of the nodes defined in a cluster. All nodes in the cluster are eligible for CXFS kernel membership.

CXFS kernel heartbeat messages are exchanged via a private network so that each node can verify membership:

- Every second, each server-capable administration node sends a single multicast packet monitored by all of the other server-capable administration and client-only nodes
- Every second, each client-only node sends a single multicast packet monitored by all of the server-capable administration nodes

A *heartbeat timeout* occurs when a node does not receive a heartbeat packet from another node within a predetermined period of time. Timeouts can happen in either direction, although they most frequently are seen when the server-capable administration node fails to receive a multicast heartbeat packet from a client-only node.

## Private Network

A *private network* is one that is dedicated to cluster communication and is accessible by administrators but not by users.

---

**Note:** A virtual local area network (VLAN) is not supported for a private network.

---

CXFS uses the private network for the following:

- CXFS kernel heartbeat
- Cluster database heartbeat
- CXFS filesystem metadata traffic
- Cluster database replication
- Communication between the cluster database master and the clients
- Communication between the `cxfs_admin` configuration command and the cluster database master

Even small variations in heartbeat timing can cause problems. If there are delays in receiving heartbeat messages, the cluster software may determine that a node is not responding and therefore revoke its CXFS kernel membership; this causes it to either be reset or disconnected, depending upon the configuration.

Rebooting network equipment can cause the nodes in a cluster to lose communication and may result in the loss of CXFS kernel membership and/or cluster database membership; the cluster will move into a degraded state or shut down if communication among nodes is lost. Using a private network limits the traffic on the network and therefore will help avoid unnecessary resets or disconnects. Also, a network with restricted access is safer than one with user access because the messaging protocol does not prevent *snooping* (illicit viewing) or *spoofing* (in which one machine on the network masquerades as another).

Therefore, because the performance and security characteristics of a public network could cause problems in the cluster and because CXFS kernel heartbeat and cluster database heartbeat are very timing-dependent, **a private network is required**. The private network should be used for metadata traffic only. (Although the primary network must be private, the backup network may be public.)



---

**Note:** When NFS or Samba serving from a CXFS cluster, the network used for remote fileserving cannot be a backup private network for CXFS. Using the fileserving network as a backup private network for the CXFS private network may result in heartbeat timeouts, which will cause a severe drop in CXFS and fileserving performance.

---

The private network must be connected to all nodes, and all nodes must be configured to use the same subnet for that network.

For more information, see:

- "Fix Network Issues First" on page 48
- "Use a Private Network" on page 49
- "Network Failover Tasks with `cxfs_admin`" on page 271

## Data Integrity Protection

A failed node must be isolated from the shared filesystems so that it cannot corrupt data. CXFS uses the following methods in various combinations to isolate failed nodes:

- System reset, which performs a system reset via a system controller. Reset should always be used for server-capable administration nodes.
- I/O fencing, which disables a node's Fibre Channel ports so that it cannot access I/O devices and therefore cannot corrupt data in the shared CXFS filesystem. When fencing is applied, the rest of the cluster can begin immediate recovery.

---

**Note:** I/O fencing differs from *zoning*. *Fencing* erects a barrier between a node and shared cluster resources. *Zoning* defines logical subsets of the switch (zones), with the ability to include or exclude nodes and media from a given zone. A node can access only media that are included in its zone. Zoning is one possible implementation of fencing. Because zoning implementation is complex and does not have uniform availability across switches, SGI chose to implement a simpler form of fencing: enabling/disabling a node's Fibre Channel ports.

---

- System shutdown for client-only nodes that use static CXFS kernel heartbeat monitoring.

- Cluster tiebreaker on a stable client-only node.

For more information, see "Protect Data Integrity on All Nodes" on page 56,

## CXFS Tiebreaker

The *CXFS tiebreaker node* is used in the process of computing the CXFS kernel membership for the cluster when exactly half of the server-capable administration nodes in the cluster are up and can communicate with each other.

The tiebreaker is required for all clusters with more than one server-capable administration node and at least one client-only node. You should choose a reliable client-only node as the tiebreaker; there is no default. For a cluster that consists of **only** four or more server-capable administration nodes, you should choose one of them as the tiebreaker; this is the only situation in which you should choose a server-capable administration node as a tiebreaker.

The tiebreaker is required in addition to I/O fencing or system reset; see "Data Integrity Protection" on page 25.

## Relocation

*Relocation* is the process by which the metadata server moves from one node to another due to an administrative action; other services on the first node are not interrupted.

---

**Note:** Relocation is disabled by default.

---

CXFS kernel membership is not affected by relocation. However, users may experience a degradation in filesystem performance while the metadata server is relocating.

An example of a relocation trigger is when the system administrator uses the GUI or `cxfs_admin` to relocate the metadata server.

To use relocation, you must enable relocation on the active metadata server and any standby server. See "CXFS Relocation Capability" on page 291.

See also "Use Relocation and Recovery Properly" on page 76.

## Recovery

*Recovery* is the process by which the metadata server moves from one node to another due to an interruption in services on the first node. If the node acting as the metadata server for a filesystem dies, another node in the list of potential metadata servers will be chosen as the new metadata server. This assumes that at least two potential metadata servers are listed when you define a filesystem.

The metadata server that is chosen must be a filesystem client; other filesystem clients will experience a delay during the recovery process. Each filesystem will take time to recover, depending upon the number of active inodes; the total delay is the sum of time required to recover each filesystem. Depending on how active the filesystems are at the time of recovery, the total delay could take up to several minutes per filesystem.

If a CXFS client fails, the metadata server will clean up after the client. Other CXFS clients may experience a delay during this process. A delay depends on what tokens, if any, that the deceased client holds. If the client has no tokens, then there will be no delay; if the client is holding a token that must be revoked in order to allow another client to proceed, then the other client will be held up until recovery returns the failed nodes tokens (for example, in the case where the client has the write token and another client wants to read). The actual length of the delay depends upon the following:

- The total number of exported inodes on the metadata server
- CXFS kernel membership situation
- Whether any metadata servers have died
- Where the metadata servers are in the recovery-order relative to recovering this filesystem

The CXFS client that failed is not allowed to rejoin the CXFS kernel membership until all metadata servers have finished cleaning up after the client.

The following are examples of recovery triggers:

- A metadata server panics
- A metadata server locks up, causing CXFS kernel heartbeat timeouts on metadata clients
- A metadata server loses connection to all of the CXFS networks

Figure 1-6 describes the difference between relocation and recovery for a metadata server. (Remember that there is one active metadata server per CXFS filesystem. There can be multiple active metadata servers within a cluster, one for each CXFS filesystem.)

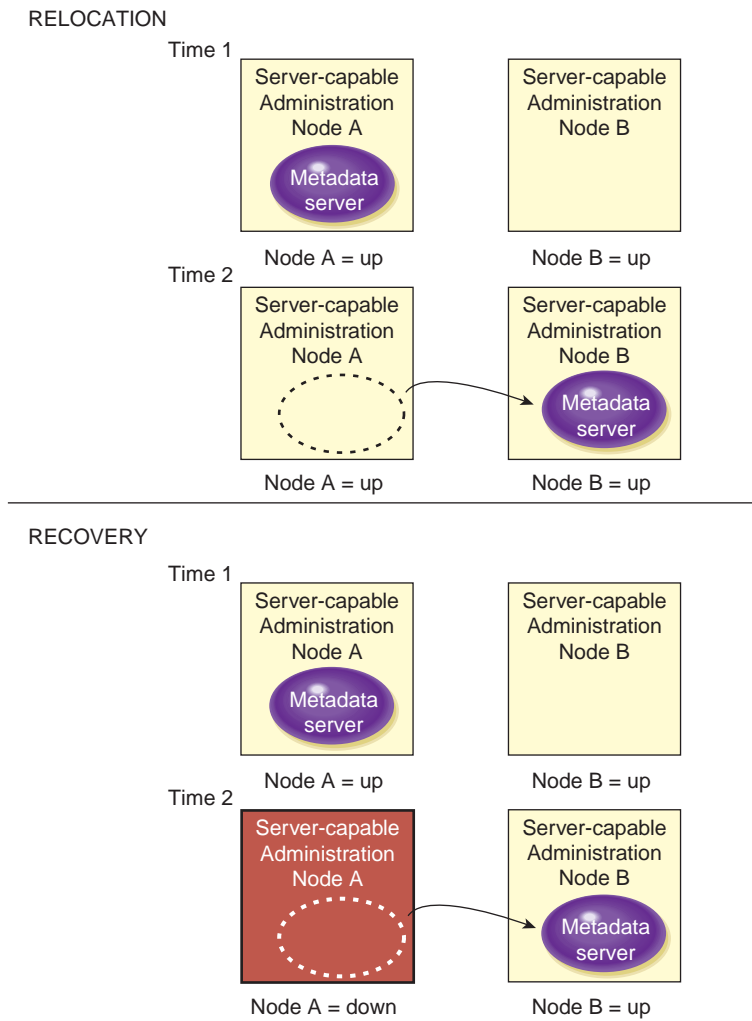


Figure 1-6 Relocation versus Recovery

See also "Use Relocation and Recovery Properly" on page 76.

## CXFS Services

To *start CXFS services* enables a node, which changes a flag in the cluster database by performing an administrative task using the CXFS GUI or `cxfs_admin`.

To *stop CXFS services* disables a node, which changes a flag in the cluster database, by performing an administrative task using the GUI or `cxfs_admin`.

To *shutdown CXFS services* withdraws a node from the CXFS kernel membership, due to the fact that the node has failed somehow. The node remains enabled in the cluster database.

Starting, stopping, or shutting down CXFS services does not affect the daemons involved. For information about the daemons that control CXFS services, see "CXFS Control Daemons" on page 44.

- "CXFS Control Daemons" on page 44
- "Start CXFS Services with the GUI" on page 197
- "Stop CXFS Services with the GUI" on page 197
- "Enable a Node with `cxfs_admin`" on page 251
- "Disable a Node with `cxfs_admin`" on page 251
- "Enable or Disable CXFS Kernel Membership (`cmsd`) for the Local Node" on page 255
- "Forced CXFS Shutdown: Revoke Membership of Local Node" on page 307

## CXFS Interoperability With Other Products and Features

CXFS is released as part of the SGI InfiniteStorage Software Platform (ISSP). ISSP combines SGI storage software products (such as CXFS and DMF) into a single distribution that is tested for interoperability.

This section discusses the following:

- "Data Migration Facility (DMF)" on page 30

- "Highly Available Services" on page 30
- "GPT Labels Overview" on page 31
- "Guaranteed-Rate I/O (GRIO) Version 2 Overview" on page 31
- "Storage Management" on page 32
- "Volume Management with XVM" on page 34
- "XVM Failover Version 2 Overview" on page 35

## Data Migration Facility (DMF)

CXFS supports the use of hierarchical storage management (HSM) products through the data management application programming interface (DMAPI), also known as the X/Open Data Storage Management Specification (XSDM). An example of an HSM product is the Data Migration Facility (DMF). DMF is the only HSM product supported with CXFS.

If DMF is managing a CXFS filesystem, DMF will ensure that the filesystem's CXFS metadata server is the DMF server and will use metadata server relocation if necessary to achieve that configuration. CXFS client-only nodes may be DMF parallel data mover nodes or DMF clients. With the Parallel Data Mover Option, DMF must always run in a CXFS environment.

For more information, see:

- "Using the Data Migration Facility (DMF)" on page 299
- *DMF 5 Administrator's Guide for SGI InfiniteStorage*

## Highly Available Services

The CXFS resource agent reports on whether the metadata server for a filesystem on a given node is running, not running, or has an error. The HA software then moves services accordingly, based upon constraints that the customer sets. For more information about the CXFS resource agent, see the SGI HA documentation.

## GPT Labels Overview

CXFS supports XVM labels on LUNs with GUID partition table (GPT) labels as well LUNs with SGI disk volume header (DVH) labels. A CXFS cluster can contain LUNs that have GPT labels and LUNs that have DVH labels. You can create these labels on server-capable administration nodes and Linux client-only nodes.

---

**Note:** DVH labels are supported on legacy devices.

---

CXFS supports a GPT-labeled LUN greater than 2 TB in size. However, being able to label a LUN does not mean that the system is able to recognize and use it. The operating systems in the cluster will determine whether you can actually use a LUN of a given size. If a LUN is set up as greater than 2-TB in size but if the operating system of a node in a cluster cannot support a greater-than-2-TB LUN, then this node will not be able to share or even access data on this LUN.

---

**Note:** GPT labels with one partition require that all nodes in the cluster run CXFS 5.5 or later. If one node in the cluster runs an earlier release, the XVM volume using that LUN will be present but will not be readable or writable on that node. In that case, the filesystem on that volume would not mount in the cluster and the command `xvm show -v phys` would report the following:

```
no direct attachment on this cell
```

For information about creating GPT labels, see the *XVM Volume Manager Administrator's Guide*.

---

## Guaranteed-Rate I/O (GRIO) Version 2 Overview

CXFS supports guaranteed-rate I/O version 2 (GRIOv2) clients on all platforms, with a GRIOv2 server on a server-capable administration node. GRIOv2 is disabled by default on the server-capable administration nodes and on Linux client-only nodes.

On Linux, GRIOv2 supports node-level static reservations.

---

**Note:** GRIOv2 application reservations are functional only for Windows 32-bit nodes; they are not functional on any other nodes (Mac OS X, Windows 64-bit, or Linux, including Linux server-capable administration nodes).

---

As the superuser, you can run the following commands from any node in the cluster:

- `grioadmin` provides stream and bandwidth management
- `griomon` provides information about GRIOv2 status
- `griogps` is the comprehensive stream quality-of-service monitoring tool

Run the above tools with the `-h` (help) option for a full description of all available options.

The paths to the GRIOv2 commands differ by platform. See Appendix B, "Path Summary" on page 463 and the appendix in the *CXFS 6 Client-Only Guide for SGI InfiniteStorage*. For details about GRIOv2, see the *Guaranteed-Rate I/O Version 2 for Linux Guide*. For other platform-specific limitations and considerations, see the *CXFS 6 Client-Only Guide for SGI InfiniteStorage*.

## Storage Management

This section describes the CXFS differences for the following:

- "Storage Backup Differences" on page 32
- "NFS Differences" on page 33
- "Quotas Differences" on page 33
- "Samba Differences" on page 33

### Storage Backup Differences

CXFS enables the use of commercial backup packages such as Veritas NetBackup and Legato NetWorker for backups that are free from the local area network (LAN), which allows the backup server to consolidate the backup work onto a backup server while the data passes through a storage area network (SAN), rather than through a lower-speed LAN.

For example, a backup package can run on a host on the SAN designated as a backup server. This server can use attached tape drives and channel connections to the SAN storages. It runs the backup application, which views the filesystems through CXFS and transfers the data directly from the LUNs, through the backup server, to the tape drives.



This allows the backup bandwidth to scale to match the storage size, even for very large filesystems. You can increase the number of LUN channels, the size of the backup server, and the number of tape channels to meet the backup-bandwidth requirements.

---

**Note:** Do not run backups on a client node because it causes heavy use of non-swappable kernel memory on the metadata server. During a backup, every inode on the filesystem is visited; if done from a client, it imposes a huge load on the metadata server. The metadata server may experience typical out-of-memory symptoms, and in the worst case can even become unresponsive or crash.

---

### NFS Differences

SGI Enhanced NFS is installed by default when you install the CXFS server or CXFS edge server software and will be used rather than stock NFS. You can put an Enhanced NFS server on top of CXFS so that computer systems that are not part of the cluster can share the filesystems. You should run the Enhanced NFS server on the CXFS active metadata server for optimal performance.

### Quotas Differences

XFS quotas are supported. However, the quota mount options must be the same on all mounts of the filesystem.

You can administer user and group quotas from any Linux node in the cluster.

With a Linux metadata server, the only supported use of project quotas is as directory quotas: for this purpose, the `/etc/projects` configuration file specifies which directory tree falls under which project, while the `/etc/projid` configuration file maps numeric project IDs to names.

You can view or modify project quotas only on the active CXFS metadata server, not on a standby metadata server or on client-only nodes.

For more information about setting quotas, see *XFS for Linux Administration*.

### Samba Differences

A CXFS filesystem may be shared via Samba from a CXFS node to other types of machines that are not running CXFS software, such as a Windows machine. The Samba server should run on the active metadata server for optimal performance.

There can be one Samba server per CXFS filesystem. You must not serve the same CXFS filesystem from multiple nodes in a cluster.

The architecture of Samba assumes that each share is exported by a single server. Because all Samba client accesses to files and directories in that share are directed through a single Samba server, the Samba server is able to maintain private metadata state to implement the required concurrent access controls (in particular, share modes, write caching, and oplock states). This metadata is not necessarily promulgated to the filesystem and there is no protocol for multiple Samba servers exporting the same share to communicate this information between them.

Running multiple Samba servers on one or more CXFS clients exporting a single share that maps to a common underlying filesystem has the following risks:

- File data corruption from writer-writer concurrency
- Application failure due to inconsistent file data from writer-reader concurrency

These problems do not occur when a single Samba server is deployed, because that server maintains a consistent view of the metadata used to control concurrent access across all Samba clients.



**Caution:** SGI recommends that you do not use multiple Samba servers.

---

## Volume Management with XVM

CXFS uses the XVM volume manager. XVM can combine many LUNs into high transaction rate, high bandwidth, and highly reliable filesystems. CXFS uses XVM to provide the following:

- Striping
- Mirroring
- Concatenation
- Advanced recovery features

The `xvm` command must be run on a server-capable administration node. If you try to run an XVM command before starting the CXFS daemons, you will get a warning message and be put into XVM's *local domain*.

When you are in XVM's local domain, you could define your filesystems, but then when you later start up CXFS you will not see the filesystems. (They will show up as *foreign* devices because they are not part of the cluster domain.) When you start up CXFS, XVM will switch to *cluster domain* and the filesystems will not be recognized because you defined them in local domain; to use them in the cluster domain, you would have to use the `give` command. Therefore, it is better to define the volumes directly in the cluster domain.

For more information, see the *XVM Volume Manager Administrator's Guide*.

## XVM Failover Version 2 Overview

CXFS supports XVM failover V2 on all platforms. XVM failover V2 allows XVM to use multiple paths to LUNs in order to provide fault tolerance and static load balancing. Paths to LUNs are representations of links from the client HBA ports to the fabric and from the fabric to the RAID controller; they do not represent the path through the fabric itself.

SGI requires `SGIAVT` mode for XVM failover V2 because failover V2 is unable to issue the device-specific commands necessary to change LUN ownership when the RAID is in `SGIRDAC` mode. See "Changing `SGIRDAC` Mode to `SGIAVT` Mode for SGI RAID" on page 494.

In general, you want to evenly distribute the I/O to LUNs across all available host bus adapters and RAID controllers and attempt to avoid blocking in the SAN fabric. The ideal case, from a performance standpoint, is to use as many paths as connection endpoints between two nodes in the fabric as possible with as few blocking paths as possible in the intervening SAN fabric.

For more information, see "XVM Failover V2" on page 333.

## Hardware and Software Requirements for Server-Capable Administration Nodes

A CXFS cluster is supported with as many as 64 nodes, of which as many as 16 can be server-capable administration nodes.

CXFS requires the following hardware and software for server-capable administration nodes, as specified in the release notes:

- All server-capable administration nodes within the cluster must have similar capabilities. You must use all Altix ia64 systems or all Altix XE x86-64 systems. See also "Provide Enough Memory" on page 50.
- An odd number of server-capable administration nodes or a tiebreaker with an even number of potential metadata servers. (SGI recommends that you always configure a stable client-only node as a tiebreaker, even for a cluster with an odd number of nodes.)
- Server-capable administration nodes that are dedicated to CXFS and filesystems work. See "Dedicate Server-Capable Administration Nodes to CXFS Work" on page 53.
- Server-capable administration nodes running Linux with the SGI Foundation Software listed in the release notes on all SGI Altix ia64 systems or all SGI Altix XE x86-64 systems. (For client-only nodes, see the release notes and *CXFS 6 Client-Only Guide for SGI InfiniteStorage*.)
- At least one host bus adapter (HBA) as listed in the release notes.
- A supported SAN hardware configuration. For details about supported hardware, see the Entitlement Sheet that accompanies the release materials. (Using unsupported hardware constitutes a breach of the CXFS license.)
- Use a network switch of at least 100baseT. (A network hub is not supported.)
- A private 100baseT or Gigabit Ethernet TCP/IP network connected to each node.

---

**Note:** When using Gigabit Ethernet, do not use jumbo frames.

---

- System reset capability and/or supported Fibre Channel switches. For supported switches, see the release notes. (Either system reset or I/O fencing is required for all nodes.)

---

**Note:** If you use I/O fencing and `ipfilterd` on a node, the `ipfilterd` configuration must allow communication between the node and the `telnet` port on the switch.

---

- RAID hardware as specified in the release notes.
- Adequate compute power for CXFS nodes, particularly server-capable administration nodes, which must deal with the required communication and I/O

overhead. There should be at least 2 GB of RAM on the system. To avoid problems during metadata server recovery/relocation, all potential metadata servers should have as much memory as the active metadata server. See "Provide Enough Memory" on page 50.

- Licenses for CXFS and XVM. See the general release notes Chapter 5, "CXFS Licensing" on page 103.
- The XVM volume manager .

## CXFS Software Products Installed on Server-Capable Administration Nodes

The following software products are installed on a server-capable administration node:

- Application binaries, documentation, and support tools:

```
cluster_admin
cluster_control
cluster_services
cxfs_admin
cxfs_cluster
cxfs_util
cxfs-xvm-cmds
```

- Enhanced XFS:

```
sgi-enhancedxfs-kmp-KERNELTYPE
```

- GRIOv2 software: *(optional)*:

```
grio2-cmds
grio2-server
```

- GUI tools:

```
sgi-sysadm_base-client
sgi-sysadm_base-lib
sgi-sysadm_base-server
sgi-sysadm_cluster_base-client
sgi-sysadm_cluster_base-server
sgi-sysadm_cxfs-client
sgi-sysadm_cxfs-server
```

```
sgi-sysadm_cxfs-web  
sgi-sysadm_xvm-client  
sgi-sysadm_xvm-server  
sgi-sysadm_xvm-web
```

- Kernel module:

```
sgi-cxfs-server-kmp-KERNELTYPE
```

For information about client-only nodes, see *CXFS 6 Client-Only Guide for SGI InfiniteStorage*.

## CXFS Tools

This section discusses the following:

- "Configuration Commands" on page 38
- "Cluster Administration Daemons" on page 43
- "CXFS Control Daemons" on page 44
- "Other Commonly Used Administrative Commands" on page 44

See also "CXFS and Cluster Administration Initialization Commands" on page 291.

## Configuration Commands

You can perform CXFS configuration tasks using the GUI (`cxfsmgr`) or `cxfs_admin`, shown in Table 1-1. These tools update the cluster database, which persistently stores metadata and cluster configuration information. After the associated changes are applied to all online database copies in the pool, the view area in the GUI will be updated. You can use the GUI or the `cxfs_admin` command to view the state of the database. (The database is a collection of files, which you cannot access directly.)

**Table 1-1** Configuration Commands

Command	Software Product	Description
<code>cxfs_admin</code>	<code>cxfs_admin</code>	Configures and administers the cluster database.
<code>cxfsmgr</code>	<code>sgi-sysadm_cxfs-client</code>	Invokes the CXFS GUI, which provides access to the tasks that help you set up and administer your CXFS filesystems and provides icons representing status and structure. The CXFS GUI also provides access to the XVM GUI.
<code>xvmgr</code>	<code>sgi-sysadm_xvm-client</code>	Directly invokes the XVM GUI, which provides access to the tasks that help you set up and administer your logical volumes and provides icons representing status and structure. You normally access the XVM GUI as part of the CXFS GUI.

The rest of this section discusses:

- "CXFS GUI Overview" on page 39
- "`cxfs_admin` Command-Line Configuration Tool Overview" on page 42

## CXFS GUI Overview

The `cxfsmgr` command invokes the CXFS Manager graphical user interface (GUI). The GUI lets you set up and administer CXFS filesystems and XVM logical volumes. It also provides icons representing status and structure. The GUI provides the following features:

- You can click any blue text to get more information about that concept or input field. Online help is also provided with the **Help** button.
- The cluster state is shown visually for instant recognition of status and problems.
- The state is updated dynamically for continuous system monitoring.
- All inputs are checked for correct syntax before attempting to change the cluster configuration information. In every task, the cluster configuration will not update until you click **OK**.
- Tasks take you step-by-step through configuration and management operations, making actual changes to the cluster configuration as you complete a task.

- The graphical tools can be run securely and remotely on any computer that has a web browser enabled to use Java, including Windows and Linux computers and laptops.

Figure 1-7 shows an example GUI screen. For more information, see Chapter 10, "CXFS GUI" on page 157.

---

**Note:** The GUI must be connected to a server-capable administration node, but it can be launched elsewhere; see "Starting the GUI" on page 158.

---



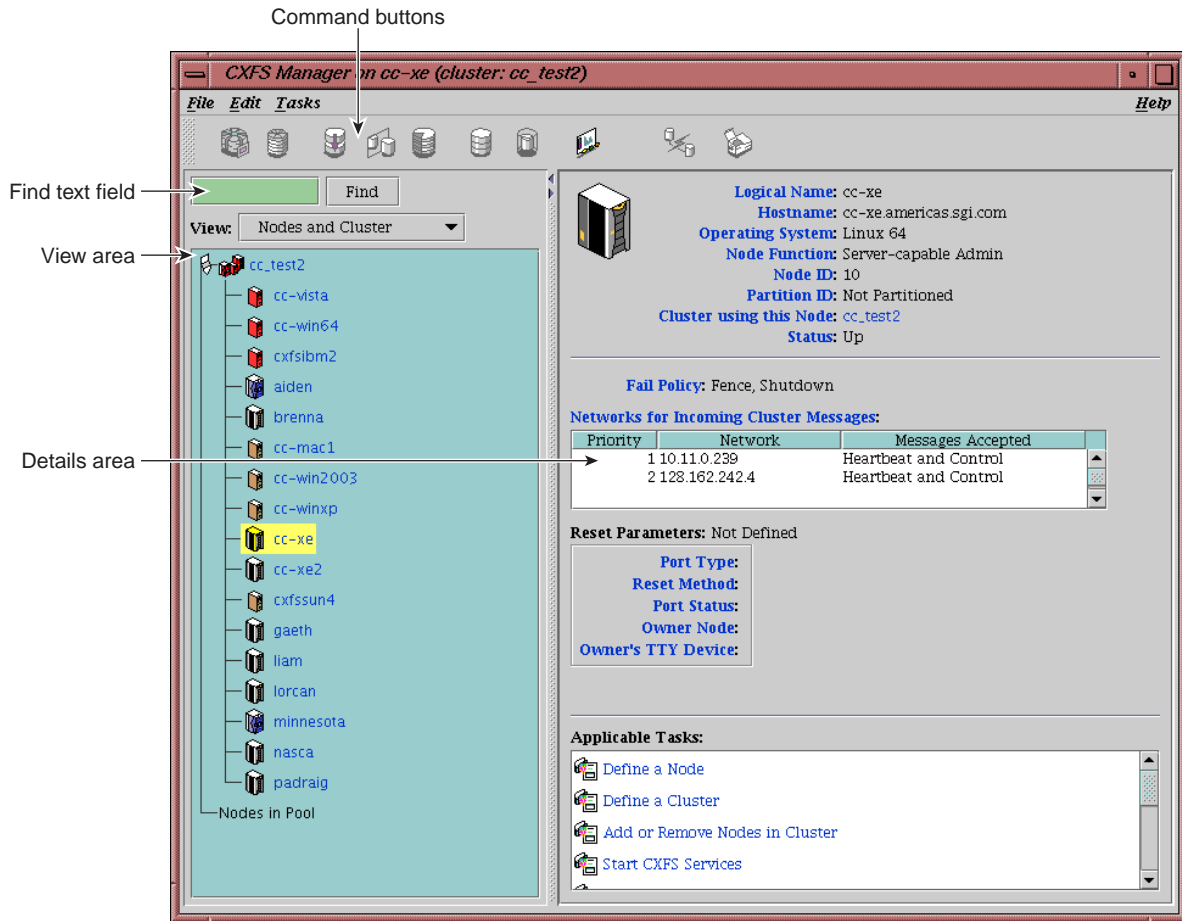


Figure 1-7 CXFS Manager GUI

### **cxfs\_admin Command-Line Configuration Tool Overview**

`cxfs_admin` lets you set up and administer CXFS filesystems and XVM logical volumes using command-line mode. It shows both the static and dynamic cluster states. This command is available on nodes that have the appropriate access and network connections. The `cxfs_admin` command provides the following features:

- Waits for a command to be completed before continuing and provides a list of possible choices (by using the <TAB> key).
- Validates all input before a command is completed.
- Provides a step-by-step mode with prompting and scripting capabilities.
- Provides better state information than the GUI or `cxfs_info`.
- Provides certain functions that are not available with the GUI.
- Provides a convenient method for performing basic configuration tasks or isolated single tasks in a production environment.
- Provides the ability to run scripts to automate some cluster administration tasks. You can use the `config` command in `cxfs_admin` to output the current configuration to a file and later recreate the configuration by using a command line option.

For more information, see Chapter 11, "cxfs\_admin Command" on page 223.

## Cluster Administration Daemons

Table 1-2 lists the set of daemons that provide cluster infrastructure on a server-capable administration node.

**Table 1-2** Cluster Administration Daemons

Daemon	Software Product	Description
cad	cluster_admin	Provides administration services for the CXFS GUI.
cmond	cluster_admin	Monitors the other cluster administration and CXFS control daemons on the local node and restarts them on failure.
crsd	cluster_control	Provides reset connection monitoring and control.
fs2d	cluster_admin	Manages the cluster database (CDB). Keeps each copy in synchronization on all server-capable administration nodes in the pool and exports configuration to client-only nodes.

You can start these daemons manually or automatically upon reboot by using the `chkconfig` command. For more information, see:

- "chkconfig Arguments" on page 296
- "Manually Starting/Stopping CXFS" on page 316
- Appendix A, "CXFS Software Architecture" on page 453

## CXFS Control Daemons

Table 1-3 lists the daemons that control CXFS nodes.

**Table 1-3** CXFS Control Daemons

Daemon	Software Product	Description
clconfd	cxfs_cluster	Controls server-capable administration nodes. Does the following: <ul style="list-style-type: none"><li>• Obtains the cluster configuration from the <code>fs2d</code> daemon and manages the local server-capable administration node's CXFS kernel membership services and filesystems accordingly</li><li>• Obtains membership and filesystem status from the kernel</li><li>• Issues reset commands to the <code>crsd</code> daemon</li><li>• Issues I/O fencing commands to configured Fibre Channel switches</li></ul>
cxfs_client	cxfs_client	Controls client-only nodes. Manages the local kernel's CXFS kernel membership services accordingly.

You can start these daemons manually or automatically upon reboot by using the `chkconfig` command. For more information, see:

- "chkconfig Arguments" on page 296
- "Manually Starting/Stopping CXFS" on page 316
- Appendix A, "CXFS Software Architecture" on page 453

## Other Commonly Used Administrative Commands

Table 1-4 summarizes the other CXFS commands of most use on a server-capable administration node. For information about client-only nodes, see *CXFS 6 Client-Only Guide for SGI InfiniteStorage*.

**Table 1-4** Other Administrative Commands

Command	Software Product	Description
cbeutil	cluster_admin	Accesses the back-end cluster database.
cdbBackup	cluster_admin	Backs up the cluster database.
cdbRestore	cluster_admin	Restores the cluster database.
cdbconfig	cluster_admin	Configures the cluster database.
cdbutil	cluster_admin	Accesses the cluster database by means of commands that correspond to functions in the libcdb library.
clconf_info	cxfs_cluster	Provides static and dynamic information about the cluster.
clconf_stats	cxfs_cluster	Provides CXFS kernel heartbeat statistics for cluster.
cms_failconf	cluster_control	Configures the action taken by the surviving nodes when a CXFS node loses membership. Normally, you will use the GUI or cxfs_admin to perform these actions.
cxfs-config	cxfs_util	Validates configuration information in a CXFS cluster.
cxfsdump	cxfs_util	Gathers configuration information in a CXFS cluster for diagnostic purposes.
cxfslicense	cxfs_util	Reports the status of license keys.
cxfs_shutdown	cxfs_cluster	Shuts down CXFS in the kernel and CXFS daemons.
haStatus	cluster_services	Obtains I/O fencing configuration and status information.
hafence	cxfs_cluster	Administer the CXFS I/O fencing configuration stored in the cluster database. Normally, you will perform this task using the GUI or cxfs_admin.
sysadmd	sgi-sysadm_base-server	Allows clients to perform remote system administration for the GUI server.



## Best Practices

This chapter summarizes configuration and administration best-practices information for CXFS:

- "Configuration Best Practices" on page 47
- "Administration Best Practices" on page 72

For the latest information and a matrix of supported CXFS and operating system software, see the following page on Supportfolio:

[http://support.sgi.com/content\\_request/838562/index.html](http://support.sgi.com/content_request/838562/index.html)

### Configuration Best Practices

This section discusses the following configuration topics:

- "Fix Network Issues First" on page 48
- "Save the Current Configuration Before Making Changes" on page 49
- "Use a Private Network" on page 49
- "Take Care When Using YaST for Configuration" on page 50
- "Use the Same Architecture for All Server-Capable Administration Nodes" on page 50
- "Provide Enough Memory" on page 50
- "Use CXFS Configuration Tools Appropriately" on page 51
- "Ensure Cluster Database Membership Quorum Stability" on page 51
- "Be Consistent in Configuration" on page 52
- "Use the Correct Mix of Software Releases" on page 52
- "Dedicate Server-Capable Administration Nodes to CXFS Work" on page 53
- "Use an Odd Number of Server-Capable Administration Nodes" on page 53
- "Create an Initial Cluster of All Server-Capable Administration Nodes" on page 54

- "Unmount Filesystems Before Adding or Deleting Server-Capable Administration Nodes" on page 54
- "Make Most Nodes Client-Only" on page 54
- "Use a Client-Only Tiebreaker" on page 55
- "Protect Data Integrity on All Nodes" on page 56
- "Use a Separate L2 for Each Node" on page 66
- "Avoid CXFS Kernel Heartbeat Issues on Large SGI Altix Systems" on page 66
- "Minimize the Number of Switches" on page 68
- "Configure Filesystems Properly" on page 69
- "Enable Forced Unmount When Appropriate" on page 69
- "Use the Appropriate CXFS Kernel Heartbeat Monitoring" on page 70
- "Verify the Configuration" on page 70
- "Use the Recovery Timeout Mechanism" on page 71
- "Use Proper Storage Management Procedures" on page 71
- "Run Samba Appropriately" on page 72
- "Install `ipmitool` on Altix XE Reset Nodes" on page 72
- "Use the LSI Drivers that Ship with the Linux OS" on page 72

### Fix Network Issues First

If there are any network issues on the private network, fix them before trying to use CXFS. A stable private network is important for a stable CXFS cluster network. Ensure that you understand the information in "Hostname Resolution and Network Configuration Rules" on page 117.

When you install the CXFS software on the client-only node, you must modify certain system files. **The network configuration is critical.** Each node in the cluster must be able to communicate with every other node in the cluster by both logical name and IP address without going through any other network routing; proper name resolution is key. SGI recommends static routing.



## Save the Current Configuration Before Making Changes

After establishing your configuration and before making any modifications, you should save the current configuration information so that you can return to it later in case of failure:

- "Save the CXFS Configuration" on page 49
- "Save the XVM Configuration" on page 49

### Save the CXFS Configuration

Before making significant changes to an existing CXFS configuration, run the `cxfs_admin config` command to create a copy of the current database. If needed, you can then use the output to recreate the cluster database after performing a `cdbreinit`. See "Saving and Recreating the Current Configuration with `cxfs_admin`" on page 279.

### Save the XVM Configuration

Occasionally, XVM labels can become corrupted. You should perform a backup of your XVM configuration using `xvm dump` any time it is changed so that you will be able to recover from potential problems. You should save the `xvm dump` output into an XFS (not CXFS) filesystem. For example, the following will dump all `xvm_labels` to the file `/var/xvm_config`:

```
xvm dump -topology -f /var/xvm_config phys/''*'' vol/''*''
```

For more information, see the section about saving and regenerating XVM configurations in the *XVM Volume Manager Administrator's Guide*. If repair is required, contact SGI Support.

## Use a Private Network

You are required to use a private network for CXFS metadata traffic:

- The private network is used for metadata traffic and should not be used for other kinds of traffic.
- A stable private network is important for a stable CXFS cluster environment.
- Two or more clusters should not share the same private network. A separate private network switch is required for each cluster.

- The private network should contain at least a 100-Mbit network switch. A network hub is not supported and should not be used.
- All cluster nodes should be on the same physical network segment (that is, no routers between hosts and the switch).
- Use private (10.x.x.x, 176.16.x.x, or 192.168.x.x) network addresses (RFC 1918).
- The private network must be configured as the highest priority network for the cluster. The public network may be configured as a lower priority network to be used by CXFS network failover in case of a failure in the private network.
- When administering more than one CXFS cluster, use unique private network addresses for each cluster. If you have multiple clusters connected to the same public network, use unique cluster names and cluster IDs.
- A virtual local area network (VLAN) is not supported for a private network.
- When NFS or Samba serving from a CXFS cluster, the network used for remote fileserving cannot be a backup private network for CXFS. Using the fileserving network as a backup private network for CXFS private network may result in heartbeat timeouts, which will cause a severe drop in CXFS and fileserving performance.

### **Take Care When Using YaST for Configuration**

You must be careful when configuring private network interfaces with YaST because it may create duplicate entries using the same hostname.

### **Use the Same Architecture for All Server-Capable Administration Nodes**

All server-capable administration nodes within the cluster must have similar capabilities. You must use all Altix ia64 systems or all Altix XE x86-64 systems. See also "Provide Enough Memory" on page 50.

### **Provide Enough Memory**

There should be at least 2 GB of RAM on the system. A server-capable administration node must have at least 1 processor and 1 GB of memory more than what it would need for its normal workload (work other than CXFS). In general, this means that the minimum configuration would be 2 processors and 2 GB of memory. If the metadata

server is also doing NFS or Samba serving, then more memory is recommended (and the `nbuf` and `ncsize` kernel parameters should be increased from their defaults). CXFS makes heavy use of memory for caching.

If a very large number of files (tens of thousands) are expected to be accessed at any one time, additional memory over the minimum is recommended to avoid throttling memory. Estimate the maximum number of inodes that will be accessed during a 2-minute window and size the server-capable administration node memory for that number. (The inode references are not persistent in memory and are removed after about 2 minutes of non-use.)

Use the following general rule to determine the amount of memory required (where `#inodes` is the maximum number of open files at any one time):

$$2 \text{ KB} \times \text{\#inodes} = \text{server-capable\_administration\_node\_memory}$$

In addition, about half of a CPU should be allocated for each Gigabit Ethernet interface on the system if it is expected to be run at close to full speed.

To avoid problems during metadata server recovery/relocation, all potential metadata servers should have as much memory as the active metadata server.

## Use CXFS Configuration Tools Appropriately

The GUI provides a convenient display of a cluster and its components through the view area. You should use it to see your progress and to avoid adding or removing nodes too quickly. After defining a node, you should wait for it to appear in the view area before adding another node. After defining a cluster, you should wait for it to appear before you add nodes to it. If you make changes too quickly, errors can occur. For more information, see "Starting the GUI" on page 158.

Do not attempt to make simultaneous changes using `cxfs_admin` and the GUI. Use one tool at a time.

## Ensure Cluster Database Membership Quorum Stability

The cluster database membership quorum must remain stable during the configuration process. If possible, use multiple windows to display the `fs2d_log` file for each server-capable administration node while performing configuration tasks. Enter the following:

```
server-admin# tail -f /var/cluster/ha/log/fs2d_log
```

Check the member count when it prints new quorums. Under normal circumstances, it should print a few messages when adding or deleting nodes, but it should stop within a few seconds after a new quorum is adopted. If not enough machines respond, there will not be a quorum. In this case, the database will not be propagated.

If you detect cluster database membership quorum problems, fix them before making other changes to the database. Try restarting the cluster administration daemons on the node that does not have the correct cluster database membership quorum, or on all nodes at the same time.

Enter the following on server-capable administration nodes:

```
server-admin# service cxfs stop
server-admin# service cxfs_cluster stop

server-admin# service cxfs_cluster start
server-admin# service cxfs start
```

---

**Note:** You could also use the `restart` option to stop and start.

---

Please provide the `fs2d` log files when reporting a cluster database membership quorum problem.

## Be Consistent in Configuration

Be consistent in configuration files for all nodes and when configuring networks. Use the same names in the same order. See Chapter 8, "Postinstallation Steps" on page 129.

## Use the Correct Mix of Software Releases

Create a new cluster using server-capable administration nodes that have the same version of the OS release and the same version of CXFS installed.

All nodes should run the same level of CXFS and the same level of operating system software, according to platform type. To support upgrading without having to take the whole cluster down, nodes can temporarily run different CXFS releases during the upgrade process.



---

**Caution:** You must upgrade all server-capable administration nodes before upgrading any client-only nodes (servers must run the same release as client-only nodes or a later release.) Operating a cluster with clients running a mixture of older and newer CXFS versions will result in a performance loss. Relocation to a server-capable administration node that is running an older CXFS version is not supported.

---

For details, see the platform-specific release notes and "CXFS Release Versions and Rolling Upgrades" on page 283.

### **Dedicate Server-Capable Administration Nodes to CXFS Work**

Server-capable administration nodes must be dedicated to CXFS and filesystems work (such as DMF, Samba, or NFS). Standard services (such as DNS and NIS) are permitted, but any other applications (such as analysis, simulation, and graphics) must be avoided.

Only dedicated nodes are supported as CXFS server-capable administration nodes. Running a server-capable administration node in a nondedicated manner will void the support contract. If you want to use an application on a server-capable administration node, SGI will provide a quotation to perform the following work:

- Audit the solution
- Design a supportable configuration
- Implement the changes

A statement of work will be created and implementation will begin after mutual agreement with the customer.

If additional products are required from SGI, the customer will be responsible for obtaining a quote and providing a purchase order before any corrective action begins. SGI will not correct unsupported configurations without compensation and reserves the right to terminate or suspend the support agreement.

### **Use an Odd Number of Server-Capable Administration Nodes**

Use an odd number of server-capable administration nodes with CXFS services running. See "Use a Client-Only Tiebreaker" on page 55.

## Create an Initial Cluster of All Server-Capable Administration Nodes

Ensure that you follow the instructions in "Preliminary Cluster Configuration Steps" on page 140.

SGI recommends that you form an initial cluster that consists of all of the server-capable administration nodes, to ensure that these nodes will have lower cell ID numbers than any client-only nodes. By ensuring that the server-capable administration nodes all have the low cell ID numbers, you will avoid potential problems. (The *cell ID* is the number associated with a node that is allocated when a node is added into the cluster definition with the GUI or when it is defined with `cxfs_admin`. The first node in the cluster has cell ID 0, and each subsequent node added gets the next available incremental cell ID. If a node is removed from the cluster definition, its cell ID becomes available. It differs from node ID.)

---

**Note:** Because `cxfs_admin` automatically adds a node to the cluster when you define the node, you should not define any client-only nodes until after you have defined all server-capable administration nodes. (Unlike `cxfs_admin`, defining and adding are two separate tasks within the GUI.)

---

After you have added all of the server-capable administration nodes, you can then add the client-only nodes. For large clusters, SGI recommends that you build up the remainder of the cluster in small groups of client-only nodes. This makes it easier to locate and fix problems, should any occur. See "Configuring a Large Cluster" on page 152.

## Unmount Filesystems Before Adding or Deleting Server-Capable Administration Nodes

Before adding or removing a server-capable administration node, you must first unmount any filesystems for which the node is a potential metadata server.

## Make Most Nodes Client-Only

You should define most nodes as client-only nodes and define just the nodes that may be used for CXFS metadata as server-capable administration nodes.

The advantage to using client-only nodes is that they do not keep a copy of the cluster database; they contact a server-capable administration node to get configuration information. It is easier and faster to keep the database synchronized

on a small set of nodes, rather than on every node in the cluster. In addition, if there are issues, there will be a smaller set of nodes on which you must look for problem.

See "Transforming a Server-Capable Administration Node into a Client-Only Node" on page 297.

## Use a Client-Only Tiebreaker

SGI recommends that you always define a stable client-only node as the CXFS tiebreaker for all clusters with more than one server-capable administration node and at least one client-only node.

Having a tiebreaker is critical when there are an even number of server-capable administration nodes. A tiebreaker avoids the problem of multiple-clusters being formed (a *split cluster*) while still allowing the cluster to continue if one of the metadata servers fails.

As long as there is a reliable client-only node in the cluster, a client-only node should be used as tiebreaker. Server-capable administration nodes are not recommended as tiebreaker nodes because these nodes always affect CXFS kernel membership.

The tiebreaker is of benefit in a cluster even with an odd number of server-capable administration nodes because when one of the server-capable administration nodes is removed from the cluster, it effectively becomes a cluster with an even-number of server-capable administration nodes.

Note the following:

- If exactly two server-capable administration nodes are configured and there are no client-only nodes, **neither** server-capable administration node should be set as the tiebreaker. (If one node was set as the tiebreaker and it failed, the other node would also shut down.)
- If exactly two server-capable administration nodes are configured and there is at least one client-only node, you should specify the client-only node as a tiebreaker.

If one of the server-capable administration nodes is the CXFS tiebreaker in a two-server-capable-node cluster, failure of that node or stopping the CXFS services on that node will result in a cluster-wide forced shutdown. If you use a client-only node as the tiebreaker, either server-capable administration node could fail but the cluster would remain operational via the other server-capable administration node.

- If there are an even number of server-capable administration nodes and there is no tiebreaker set, the fail policy must not contain the `shutdown` option because there is no notification that a shutdown has occurred. See "Data Integrity Protection" on page 25.

SGI recommends that you start CXFS services on the tiebreaker client after the server-capable administration nodes are all up and running, but before CXFS services are started on any other clients. See "Restart the Cluster In an Orderly Fashion" on page 81.

## Protect Data Integrity on All Nodes

All nodes must be configured to protect data integrity in case of failure. System reset or I/O fencing is required to ensure data integrity for all nodes.

SGI recommends that you use a system reset configuration on server-capable administration nodes in order to protect data integrity and improve server reliability. I/O fencing (or system reset when available) must be used on client-only nodes.

See also "Data Integrity Protection" on page 25.

## System Reset

You should configure system reset for all server-capable administration nodes in order to protect data integrity. (I/O fencing is appropriate for client-only nodes.)

---

**Note:** If the failure hierarchy contains `reset` or `fencerreset`, the reset might be performed before the system kernel core-dump can complete, resulting in an incomplete core-dump.

---

System reset is recommended because if a server hangs, it must be rebooted as quickly as possible to get it back in service, which is not available with I/O fencing. In addition, filesystem corruption is more likely to occur with a rogue metadata server, not a rogue client. (If fencing were to be used on a metadata server and fail, the cluster would have to either shutdown or hang. A fencing failure can occur if an administrator is logged into the switch.)

System reset is over the network and can use the following methods:

- `powerCycle` shuts off power to the node and then restarts it



- `reset` simulates the pressing of the reset button on the front of the machine

---

**Note:** See "Install `ipmitool` on Altix XE Reset Nodes" on page 72.

---

- NMI (nonmaskable interrupt) performs a core-dump of the operating system kernel, which may be useful when debugging a faulty machine

---

**Note:** NMI should only be used when directed to by SGI Service personnel. When used on SGI Altix nodes, the node will not restart automatically, but will stop in the `kdb` debugger, which requires human intervention to perform debugging and reset the node manually. (See SGI Bulletin TIB 200908 for information on debugging with `kdb`.) This mode is not applicable to SGI Altix XE nodes, which use BMC system controllers.

---

You would want to use `reset` for I/O protection on a client-only node that has a system controller when CXFS is a primary activity and you want to get it back online fast; for example, a CXFS fileserver.

## I/O Fencing

Nodes without system reset capability require I/O fencing. I/O fencing is also appropriate for nodes with system controllers if they are client-only nodes.

You should use the `admin` account when configuring I/O fencing. On a Brocade switch running 4.x.x.x or later firmware, modify the `admin` account to restrict it to a single `telnet` session. For details, see "Limiting `telnet` Sessions" on page 97.

If you use I/O fencing, SGI recommends that you use a switched network of at least 100baseT.

You should isolate the power supply for the switch from the power supply for a node and its system controller. You should avoid any possible situation in which a node can continue running while both the switch and the system controller lose power. Avoiding this situation will prevent the possibility of forming split clusters.

You must put switches used for I/O fencing on a network other than the primary CXFS private network so that problems on the CXFS private network can be dealt with by the fencing process and thereby avoid data or filesystem corruption issues. The network to which the switch is connected must be accessible by all server-capable administration nodes in the cluster.

If you manually change the port status, the CXFS database will not be informed and the status output by the `cxfs_admin` command will not be accurate. To update the CXFS database, run the following command:

```
server-admin# /usr/cluster/bin/hafence -U
```

I/O fencing does the following:

- Preserves data integrity by preventing I/O from nodes that have been expelled from the cluster
- Speeds the recovery of the surviving cluster, which can continue immediately rather than waiting for an expelled node to reset under some circumstances

To support I/O fencing, platforms require a Fibre Channel switch; for supported switches, see the release notes.

When a node joins the CXFS kernel membership, the worldwide port name (WWPN) of its host bus adapter (HBA) is stored in the cluster database. If there are problems with the node, the I/O fencing software sends a message via the `telnet` protocol to the appropriate switch and disables the port.



**Caution:** You must keep the `telnet` port free in order for I/O fencing to succeed; **do not** perform a `telnet` to the switch and leave the session connected.

Brocade switches running 4.x.x.x or later firmware by default permit multiple `telnet` sessions. However, in the case of a split cluster, a server-capable administration node from each side of the network partition will attempt to issue the fence commands, but only the node that is able to log in will succeed. Therefore, on a Brocade switch running 4.x.x.x or later firmware, you must modify the `admin` account to restrict it to a single `telnet` session. See "Keep the `telnet` Port Open on the Switch" on page 84 and the release notes.

---

The switch then blocks the problem node from communicating with the storage area network (SAN) resources via the corresponding HBA. Figure 2-1 describes this.

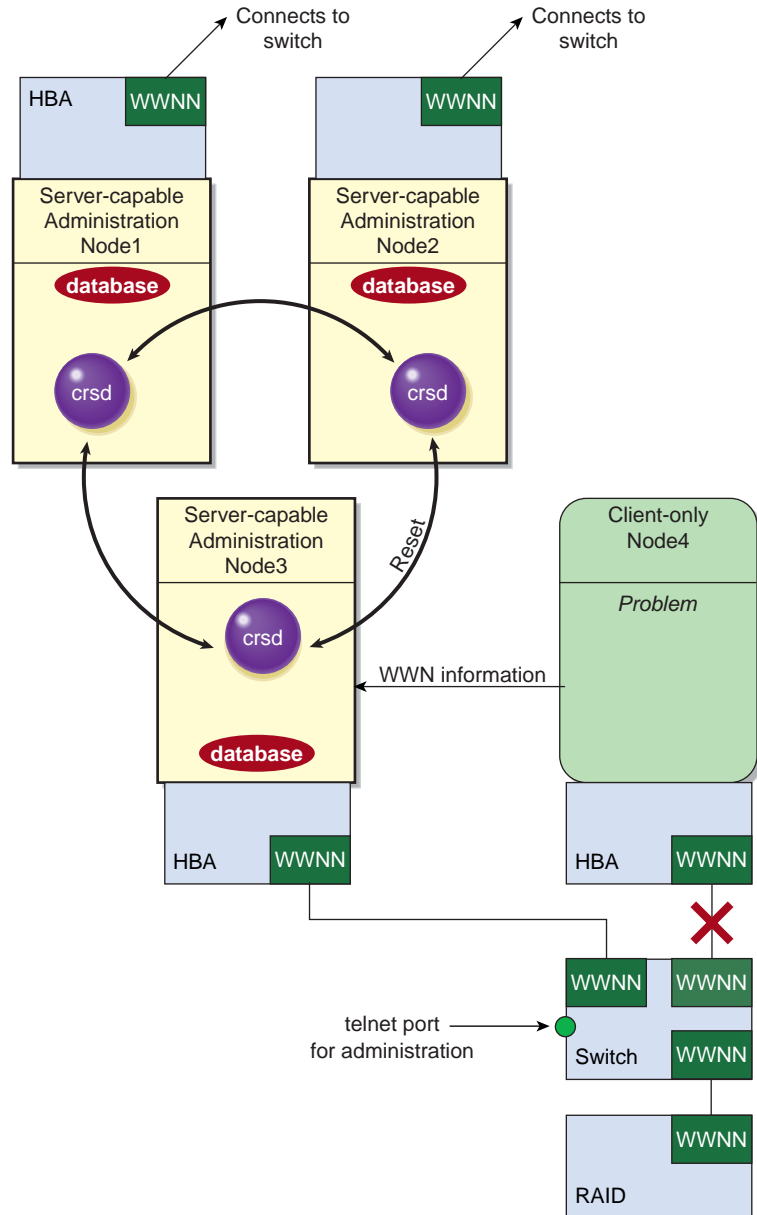


Figure 2-1 I/O Fencing

If users require access to nonclustered LUNs or devices in the SAN, these LUNs/devices must be accessed or mounted via an HBA that has been explicitly masked from fencing. For details on how to exclude HBAs from fencing for server-capable administration nodes, see:

- "Define a Switch with the GUI" on page 202
- "Create a Switch with `cxfs_admin`" on page 273

For nodes running other supported operating systems, see *CXFS 6 Client-Only Guide for SGI InfiniteStorage*.

To recover, the affected node withdraws from the CXFS kernel membership, unmounts all filesystems that are using an I/O path via fenced HBA(s), and then rejoins the cluster. This process is called *fencing recovery* and is initiated automatically. Depending on the fail policy that has been configured, a node may be reset (rebooted) before initiating fencing recovery. For information about setting the fail policy, see:

- "Fail Policies" on page 64
- "Define a Node with the GUI" on page 179
- "Create a Switch with `cxfs_admin`" on page 273

In order for a fenced node to rejoin the CXFS kernel membership, the current kernel membership leader must lower its fence, thereby allowing it to reprobe its XVM volumes and then remount its filesystems. If a node fails to rejoin the CXFS kernel membership, it may remain fenced. This is independent of whether the node was rebooted; fencing is an operation that is applied on the switch, not on the affected node. In certain cases, it may therefore be necessary to manually lower a fence. For instructions, see "Lower the I/O Fence for a Node with the GUI" on page 206, and "Using `hafence`" on page 292.



**Caution:** When a fence is raised on an HBA, **no further I/O is possible to the SAN via that HBA until the fence is lowered.** This includes the following:

- I/O that is queued in the kernel driver, on which user processes and applications may be blocked waiting for completion. These processes will return the `EIO` error code under UNIX, or display a warning dialog that I/O could not be completed under Windows.
  - I/O issued via the affected HBAs to nonclustered (local) logical units (LUNs) in the SAN or to other Fibre Channel devices such as tape storage devices.
-

On client-only nodes with system reset capability, you would want to use `Fence` for data integrity protection when CXFS is just a part of what the node is doing and therefore losing access to CXFS is preferable to having the system rebooted. An example of this would be a large compute server that is also a CXFS client. However, `Fence` cannot return a nonresponsive node to the cluster; this problem will require intervention from the system administrator.

For more information, see:

- "Switches and I/O Fencing Tasks with the GUI" on page 202
- "Create or Modify a Node with `cxfs_admin`" on page 242
- "Switch Tasks with `cxfs_admin`" on page 272

## Shutdown

You should only use the `shutdown` fail policy for client-only nodes that use static CXFS kernel heartbeat.

If you use dynamic heartbeat monitoring, you must not use the `shutdown` fail policy for client-only nodes; it can be slower to recover because failure detection may take longer if no operations are pending against a node that fails. `shutdown` is not allowed as a fail policy because of the dynamic nature and potentially asymmetric heartbeat monitor between two nodes. For example, the server may begin monitoring heartbeat for a client, but that client may not currently be monitoring heartbeat of the server, and therefore the nodes may not discover they have lost membership in a timely manner.

In the case of a cluster with no tiebreaker node, it is possible that using the `shutdown` setting on server-capable administration nodes could cause a network partition in which split clusters could be formed and data could therefore be corrupted.

Suppose this configuration of server-capable administration nodes:

AdminNodeA	AdminNodeB
-----	-----
fence	fence
reset	reset
shutdown	shutdown

If the CXFS private network between AdminNodeA and AdminNodeB fails, the following could occur:

1. Each node will try to fence the other. (That is, AdminNodeA will try to fence AdminNodeB, and AdminNodeB will try to fence AdminNodeA).
2. If the fence fails, each node will try to reset the other.
3. If the system reset fails, each assumes that the other will shut itself down. Each will wait for a few moments and will then try to maintain the cluster.

This will result in two clusters that are unaware of each other (a *split cluster*) and filesystem corruption will occur.

Suppose another configuration, in which neither server-capable administration node has shutdown set:

AdminNodeA	AdminNodeB
-----	-----
fence	fence
reset	reset

If the CXFS private network between AdminNodeA and AdminNodeB fails in this situation, each node would first try to fence the other and then try to reset the other, as before. However, if both of those actions fail, each would assume that the state of the other node is unknown. Therefore, neither node would try to maintain the cluster. The cluster will go down, but no filesystem corruption will occur.

The split cluster problem may be avoided by using a tiebreaker node or by not using the shutdown setting on any server-capable administration node.

---

**Note:** You must not use shutdown if you use dynamic CXFS kernel heartbeat.

---

### Avoid Split Clusters

The worst scenario is one in which the node does not detect the loss of communication but still allows access to the shared disks, leading to filesystem corruption. For example, it is possible that one node in the cluster could be unable to communicate with other nodes in the cluster (due to a software or hardware failure) but still be able to access shared disks, despite the fact that the cluster does not see this node as an active member.

In this case, the reset will allow one of the other nodes to forcibly prevent the failing node from accessing the disk at the instant the error is detected and prior to recovery from the node's departure from the cluster, ensuring no further activity from this node.

In a case of a split cluster, where an existing CXFS kernel membership splits into two halves (each with half the total number of server-capable administration nodes), the following will happen:

- If the CXFS tiebreaker and system reset or I/O fencing are configured, the half with the tiebreaker node will reset or fence the other half. The side without the tiebreaker will attempt to forcibly shut down CXFS services.
- If there is no CXFS tiebreaker node but system reset or I/O fencing is configured, each half will attempt to reset or fence the other half using a delay heuristic. One half will succeed and continue. The other will lose the reset/fence race and be rebooted/fenced.
- If there is no CXFS tiebreaker node and system reset or I/O fencing is not configured, then both halves will delay, each assuming that one will win the race and reset the other. Both halves will then continue running, because neither will have been reset or fenced, leading to likely filesystem corruption.

To avoid this situation, you should configure a tiebreaker node, and you must use system reset or I/O fencing. However, if the tiebreaker node (in a cluster with only two server-capable administration nodes) fails, or if the administrator stops CXFS services, the other node will do a forced shutdown, which unmounts all CXFS filesystems.

If the network partition persists when the losing-half attempts to form a CXFS kernel membership, it will have only half the number of server-capable administration nodes and be unable to form an initial CXFS kernel membership, preventing two CXFS kernel memberships in a single cluster.

For more information, contact SGI professional or managed services.

## Fail Policies

CXFS uses the following methods to isolate failed nodes. You can specify up to three methods by defining the fail policy. The second method will be completed only if the first method fails; the third method will be completed only if both the first and second methods fail. The possible methods are:

- `Fence`, which disables a node's Fibre Channel ports so that it cannot access I/O devices and therefore cannot corrupt data in the shared CXFS filesystem. When fencing is applied, the rest of the cluster can begin immediate recovery. See "I/O Fencing" on page 57.
- `Reset`, which performs a system reset via a system controller. See "System Reset" on page 56.
- `FenceReset`, which fences the node and then, if the node is successfully fenced, performs an asynchronous system reset; recovery begins without waiting for reset acknowledgment. If used, this fail policy should be specified first. If the fencing action fails, the reset is not performed; therefore, `reset` alone is also required for all server-capable administration nodes (unless there is a single server-capable administration node in the cluster). See "I/O Fencing" on page 57 and "System Reset" on page 56.
- `Shutdown`, which tells the other nodes in the cluster to wait for a period of time (long enough for the node to shut itself down) before reforming the CXFS kernel membership. (However, there is no notification that the node's shutdown has actually taken place.) See "Shutdown" on page 61.



**Caution:** You must not use the `shutdown` setting in either of the following circumstances:

- If you have a cluster with no tiebreaker, you must not use the `shutdown` setting for any server-capable administration node in order to avoid split clusters being formed. (This is because there is no notification that a shutdown has occurred.) See "Shutdown" on page 61.
  - On client nodes if you choose `dynamic` monitoring.
-



The following are valid fail policy sets:

---

**Note:** If the failure hierarchy contains `reset` or `fencerreset`, the reset might be performed before the system kernel core-dump can complete, resulting in an incomplete core-dump.

---

- Server-capable administration nodes:

FenceReset, Reset (Preferred)  
FenceReset  
Reset  
Reset, Fence

- Client-only nodes with static CXFS kernel heartbeat monitoring:

Fence, Shutdown (Preferred)  
Fence  
Fence, Reset  
Fence, Reset, Shutdown  
FenceReset  
FenceReset, Reset  
FenceReset, Reset, Shutdown  
FenceReset, Shutdown  
Reset  
Reset, Fence  
Reset, Fence, Shutdown  
Reset, Shutdown  
Shutdown

- Client-only nodes with dynamic CXFS kernel heartbeat monitoring:

Fence (Most common)  
Fence, Reset  
FenceReset  
FenceReset, Reset  
Reset  
Reset, Fence

For more information, see "Use the Appropriate CXFS Kernel Heartbeat Monitoring" on page 70.

---

**Note:** If the fail policy does not include `Shutdown` and all of the other actions fail, CXFS will stall membership until the failed node either attempts to join the cluster again or until the administrator intervenes by using `cms_intervene`. Objects held by the failed node stall until membership finally transitions and initiates recovery. For more information, see the `cms_intervene(8)` man page.

---

See also:

- "Protect Data Integrity on All Nodes" on page 56
- "Define a Node with the GUI" on page 179
- "Create or Modify a Node with `cxfs_admin`" on page 242

## Use a Separate L2 for Each Node

Having a single L2 attached to two server-capable administration nodes may cause both nodes to be rebooted. You should use a separate L2 for each node. For more information, see "L2 System Controller" on page 472.

## Avoid CXFS Kernel Heartbeat Issues on Large SGI Altix Systems

To avoid CXFS kernel heartbeat issues on large SGI Altix systems (those with more than 64 processors), do the following:

- Keep current on maintenance levels (especially patches related to `xpmem`).
- Set the CXFS kernel heartbeat timeout to a large value cluster-wide. See "`mtcp_hb_period`" on page 480.
- Use `cpusets` (for more information, see *Linux Resource Administration Guide*):
  - `Bootcpuset`:
    - On large systems, you generally need 4-8 CPUs in the `bootcpuset`.
    - The `bootcpuset` can consist of nonconsecutively numbered CPUs as long as each group is allocated on a node boundary.
    - Set `cpu_exclusive` (**but not** `memory_exclusive`).

- Batch cpuset, used to schedule work (usually consists of the CPU and nodes that remain after defining the bootcpuset):
  - Set `cpu_exclusive` and `memory_exclusive`.
- Per-job cpusets (children of the batch cpuset that are generally dynamically allocated by the batch scheduler) :
  - Allocate per-job cpusets on a node boundary.
  - Allocate per-job cpusets that are large enough to meet both the CPU and memory requirements of the job for which they are created. Jobs that exceed available resources should be killed via an automated means.
  - Set `cpu_exclusive` (**but not** `memory_exclusive`).
  - Set `memory_spread_{page,slab}` if specific nodes within a per-job cpuset are being oversubscribed.
- Remember the following when setting kernel memory parameters in `/etc/sysctl.conf`:
  - The kernel (`kswapd`) can lock out other activities on a CPU or the entire system if it is thrashing about, trying to maintain free memory pages to meet unrealistic default kernel tuning specifications on large systems.
  - Do not oversubscribe memory on the system.
  - Consider a job's I/O requirements when estimating a job's memory; buffer cache comes from the same pool of memory.

For example, you could set the following:

---

**Note:** The following tunable recommendations are generic. They should be evaluated to match a specific system's intended workload.

---

```
vm.min_free_kbytes= [ NumberOfNodes*64*pagesize/1024]
# printf "%d\n64\n16\n**p" `ls /sys/devices/system/node/ | wc -l` | dc
vm.dirty_ratio=10
vm.dirty_background_ratio=5
```

- Pin interrupt processing for NICs used for CXFS private networks to CPUs in the bootcpuset.

- Configure the I/O subsystem to meet job requirements for throughput and responsiveness:
  - Maintain the I/O subsystem at peak efficiency. This includes CXFS filesystems as well as locally attached storage where job and system I/O occurs.
  - Maintain the `failover2.conf` file across the cluster to maximize I/O performance.
  - Flush dirty pages at the maximum possible speed. Uncontrolled growth in the number of dirty pages stresses the kernel's memory management functions (for example, `kswapd`) and increases the chance of lengthy kernel lockouts impacting CXFS heartbeat functionality.
- Set the `mtcp_hb_local_options` system tunable parameter to specify a heartbeat generation routine that avoids some memory allocation problems for nodes with large CPU counts that run massively parallel jobs (0x3). See "mtcp\_hb\_local\_options" on page 480.
- Use dynamic heartbeat monitoring. A cluster defined with dynamic heartbeat starts monitoring only when a node is processing a message from another node (such as for token recall or XVM multicast) or when the client-only node monitors the server-capable administration node because it has a message pending (for example, a token acquire or metadata operation). Once monitoring initiates, it monitors at 1-second intervals and declares a timeout after a given number of consecutive missed seconds (specified by `mtcp_hb_period`), just like static monitoring. The intent of dynamic heartbeat monitoring is to avoid inappropriate loss of membership in clusters that have client-only nodes with heavy workloads. However, it may take longer to recover a client's tokens and other state information when there is an actual problem. Dynamic heartbeat monitoring also does not resolve any of the issues noted above if they occur during periods of active heartbeat monitoring.

See also "Inappropriate Node Membership Loss" on page 408.

## Minimize the Number of Switches

CXFS fencing operations are more efficient with a smaller number of large switches rather than a large number of smaller switches.

## Configure Filesystems Properly

Configure filesystems properly:

- Use a filesystem block size that is common to all CXFS OS platforms. Each CXFS OS platform supports a unique range of filesystem block sizes, but all of them support a filesystem block size of 4096 bytes. For this reason, SGI recommends 4-KB filesystems for compatibility with all CXFS platforms. For details on the filesystem block sizes supported by each CXFS OS platform, see the “Filesystem and Logical Unit Specifications” appendix in the *CXFS 6 Client-Only Guide for SGI InfiniteStorage*.
- Determine whether or not to have all filesystems served off of one metadata server or to use multiple metadata servers to balance the load, depending upon how filesystems will be accessed. The more often a file is accessed, the greater the stress; a filesystem containing many small files that are accessed often causes greater stress than a filesystem with a few large files that are not accessed often. CXFS performs best when data I/O operations are greater than 16 KB and large files are being accessed. (A lot of activity on small files will result in slower performance.)
- If you are using NFS or Samba, you should have the NFS or Samba server run on the active metadata server.
- Do not use nested mount points. Although it is possible to mount other filesystems on top of a CXFS filesystem, this is not recommended.
- Perform reconfiguration (including but not limited to adding and deleting filesystems or nodes) during a scheduled cluster maintenance shift and not during production hours. You should stop CXFS services on a server-capable administration node before performing maintenance on it.

## Enable Forced Unmount When Appropriate

Normally, an unmount operation will fail if any process has an open file on the filesystem. The *forced unmount* feature allows the unmount to proceed regardless of whether the filesystem is still in use.

If you enable the forced unmount feature for CXFS filesystems (which is turned off by default), you may be able to improve the stability of the CXFS cluster, particularly in situations where the filesystem must be unmounted. However, be aware that forced unmount will kill running processes to unmount a filesystem, which is potentially destructive.

This function is performed with the `fuser -m -k` command and the `umount` command. See:

- "Unmount CXFS Filesystems with the GUI" on page 215
- "Create or Modify a CXFS Filesystem with `cxfs_admin`" on page 263
- "Unmount a CXFS Filesystem with `cxfs_admin`" on page 269

## Use the Appropriate CXFS Kernel Heartbeat Monitoring

All nodes send CXFS kernel heartbeat messages once per second. If a node does not receive a heartbeat within a defined period, that node loses membership and is denied access to the cluster's filesystems. The defined period is one of the following:

- `static`: Monitors constantly at 1-second intervals and declares a timeout after 5 consecutive missed seconds (default).
- `dynamic`: Starts monitoring only when the node is processing a message from another node (such as for token recall or XVM multicast) or when the client monitors the server because it has a message pending (for example, a token acquire or metadata operation). After monitoring initiates, it monitors at 1-second intervals and declares a timeout after 5 consecutive missed seconds, just like static monitoring. Dynamic heartbeat monitoring is appropriate for clusters that have clients with heavy workloads; using it avoids inappropriate loss of membership. However, it may take longer to recover a client's tokens and other state information when there is an actual problem.

You can set the CXFS kernel heartbeat monitor period for the entire cluster by using the `cxfs_admin` command. See "Create a Cluster with `cxfs_admin`" on page 258.

## Verify the Configuration

You should always run the following command after any significant configuration change or whenever problems occur in order to validate the configuration:

```
server-admin# /usr/cluster/bin/cxfs-config -xfs -xvm
```

The CXFS GUI and `cxfs_admin` do not always prevent poor configurations. The `status` command in `cxfs_admin` will indicate some potential problems and the `cxfs-config` tool can detect a large number of potential problems.

## Use the Recovery Timeout Mechanism

The recovery timeout mechanism prevents the cluster from hanging and keeps filesystems available in the event that a node becomes unresponsive.

When recovery timeout is enabled, nodes are polled for progress after a recovery has begun. If recovery for a node is not making progress according to the specified polls, the recovery is considered stalled and the node will shut down or panic. For example, to enable the recovery timeout to begin monitoring after 5 minutes, monitor every 2 minutes, declare a node's recovery stalled after 15 minutes without progress, and panic the node with stalled recovery, you would set the following:

```
cxfs_recovery_timeout_start 300
cxfs_recovery_timeout_period 120
cxfs_recovery_timeout_stalled 900
cxfs_recovery_timeout_panic 1
```

For details about the parameters, see "Dynamic Parameters for Debugging Purposes Only" on page 487.



**Caution:** These parameters are provided for debugging purposes. You should only reset these parameters if advised to do so by SGI support.

---

## Use Proper Storage Management Procedures

You should configure storage management hardware and software according to its documentation and use proper storage management procedures, including the following:

- Assign IP addresses to all storage controllers and have them network-connected (but not on the private CXFS metadata network) and manageable via out-of-band management

---

**Note:** Do not use in-band management (which can cause problems if there is a loss of Fibre Channel connectivity).

---

- Keep a copy of the array configuration
- Monitor for read errors that do not result in drive strikes
- Keep a copy of the XVM volume configuration

## Run Samba Appropriately

If you are using Samba, you should have the Samba server run on the active metadata server. You must not use multiple Samba servers to export the same CXFS filesystem. For more information, see "Samba Differences" on page 33.

## Install `ipmitool` on Altix XE Reset Nodes

The `crsd` daemon issues a system reset via `ipmitool`. Therefore you must install `ipmitool` on any Altix XE node that can issue a system reset.

## Use the LSI Drivers that Ship with the Linux OS

You should use the LSI drivers that ship with the Linux operating systems. The newer drivers that are available on the LSI web site may not work and are not supported by SGI or the kernels CXFS uses in this release.

## Administration Best Practices

This section discusses the following administration topics:

- "Back Up the Cluster Database" on page 74
- "Change the Brocade Password when Prompted" on page 74
- "Do Not Run User Jobs on Server-Capable Administration Nodes" on page 74
- "Do Not Run Backups on a Client Node" on page 74
- "Use `cron` Jobs Properly" on page 74
- "Repair Filesystems with Care" on page 75
- "Defragment Filesystems with Care" on page 75
- "Use Relocation and Recovery Properly" on page 76
- "Shut Down Nodes Unobtrusively" on page 76
- "Remove Unused Cluster Components" on page 77
- "Use `fam` Properly" on page 77



- "Upgrade the Software Properly" on page 77
- "Use Fast Copying for Large CXFS Files" on page 78
- "Do Not Change Log File Names " on page 78
- "Rotate Log Files" on page 79
- "Use System Capacity Wisely" on page 79
- "Reboot Before Changing Node ID or Cluster ID" on page 79
- "Reboot a Removed Node Before Returning it to the Cluster Definition" on page 80
- "Restart CXFS on a Node after an Administrative CXFS Stop" on page 80
- "Restart the Cluster In an Orderly Fashion" on page 81
- "Disable Nodes that Affect Membership Before Maintenance" on page 81
- "Disable Reset If You Remove Reset Capability" on page 81
- "Avoid Performance Problems with Unwritten Extent Tracking" on page 82
- "Avoid Performance Problems with Exclusive Write Tokens" on page 82
- "Use Disk Layout Optimization for Approved Media Customers" on page 82
- "Set System Tunable Parameters Appropriately" on page 83
- "Keep the telnet Port Open on the Switch" on page 84
- "Solve Problems Efficiently" on page 84
- "Do Not Overfill CXFS Filesystems" on page 84
- "Use a Time Synchronization Application" on page 84
- "Turn Off Local XVM on Linux Nodes if Unused" on page 84
- "Avoid Memory-Mapped I/O for DMF Filesystems" on page 85
- "Do Not Use Both dmi and filestreams Mount Options" on page 85
- "After Restart, Verify that All Nodes Use the Preferred XVM Path" on page 86
- "Use Improved mkfs Options" on page 87

## Back Up the Cluster Database

Before and after making cluster configuration changes, you should back up the cluster database so that you can return to an earlier configuration in case of configuration problems or database corruption. See "Backing Up the Cluster Database with `cdbBackup`" on page 351.

## Change the Brocade Password when Prompted

If you are prompted to change the Brocade switch password, you should do so in order to make logins to the switch faster.

## Do Not Run User Jobs on Server-Capable Administration Nodes

Do not run user jobs on any server-capable administration nodes. These systems must be dedicated to CXFS services for maximum stability. See "Dedicate Server-Capable Administration Nodes to CXFS Work" on page 53.

## Do Not Run Backups on a Client Node

SGI recommends that you perform backups on the active metadata server.

Do not run backups on a client node, because it causes heavy use of non-swappable kernel memory on the metadata server. During a backup, every inode on the filesystem is visited; if done from a client, it imposes a huge load on the metadata server. The metadata server may experience typical out-of-memory symptoms, and in the worst case can even become unresponsive or crash.

## Use `cron` Jobs Properly

Jobs scheduled with `cron` can cause severe stress on a CXFS filesystem if multiple nodes in a cluster start the same filesystem-intensive task simultaneously.

Because CXFS filesystems are considered as local on all nodes in the cluster, the nodes may generate excessive filesystem activity if they try to access the same filesystems simultaneously while running commands such as `find` or `ls`. You should build databases for `rfind` and GNU `locate` only on the active metadata server.

Any task initiated using `cron` on a CXFS filesystem should be launched from a single node in the cluster, preferably from the active metadata server. Edit the nodes'

`crontab` file to only execute the `find` command on one metadata server of the cluster.

## Repair Filesystems with Care

Always contact SGI technical support before using `xfs_repair` on CXFS filesystems. You must first ensure that you have an actual case of filesystem corruption and retain valuable metadata information by replaying the XFS logs before running `xfs_repair`.



---

**Caution:** If you run `xfs_repair` without first replaying the XFS logs, you may introduce data corruption. You should run `xfs_ncheck` and capture the output to a file before running `xfs_repair`. If running `xfs_repair` results in files being placed in the `lost+found` directory, the saved output from `xfs_ncheck` may help you to identify the original names of the files.

---

Only use `xfs_repair` on server-capable administration nodes and only when you have verified that all other cluster nodes have unmounted the filesystem. Make sure that `xfs_repair` is run only on a cleanly unmounted filesystem. If your filesystem has not been cleanly unmounted, there will be uncommitted metadata transactions in the log, which `xfs_repair` will erase. This usually causes loss of some data and messages from `xfs_repair` that make the filesystem appear to be corrupted.

If you are running `xfs_repair` right after a system crash or a filesystem shutdown, your filesystem is likely to have a dirty log. To avoid data loss, you **MUST** mount and unmount the filesystem before running `xfs_repair`. It does not hurt anything to mount and unmount the filesystem locally, after CXFS has unmounted it, before `xfs_repair` is run.

## Defragment Filesystems with Care

The `xfs_fsr` tool is useful when defragmenting specific files but not filesystems in general.

Using `xfs_fsr` to defragment CXFS filesystems is not recommended except on read-mostly filesystems because `xfs_fsr` badly fragments the free space. XFS actually does best at maintaining contiguous free space and keeping files from being fragmented if `xfs_fsr` is not run as long as there is a moderate (10% or more) free space available on the filesystem.



---

**Caution:** You should use `xfstool fsr` **manually**, and only on the active metadata server for the filesystem; the `bulkstat` system call has been disabled for CXFS clients. Make sure that the filesystem is idle because `xfstool fsr` may create a temporary filesystem-full condition and fail other applications that otherwise would succeed.

---

## Use Relocation and Recovery Properly

Use relocation and recovery only to a standby node that does not currently run any applications (including NFS and Samba) that will use that filesystem. The node can run applications that use other filesystems. See "Node Types, Node Functions, and the Cluster Database" on page 13.

---

**Note:** Relocation is disabled by default. You should enable relocation only during the time when you intend to perform relocations; otherwise, leave relocation disabled. See "CXFS Relocation Capability" on page 291.

---

## Shut Down Nodes Unobtrusively

Rebooting the metadata server without first shutting down CXFS services can cause the metadata server to panic. Use the proper procedures for shutting down nodes. See "Cluster Member Removal and Restoration" on page 315.

When you shut down a server-capable administration node, it is unable to unmount the filesystems for which it is the active metadata server and is therefore unable to shut down gracefully. See "Relocation Error" on page 416.

When shutting down, resetting, or restarting a CXFS client-only node, do not stop CXFS services on the node. Rather, let the CXFS shutdown scripts on the node stop CXFS when the client-only node is shut down or restarted. (Stopping CXFS services is more intrusive on other nodes in the cluster because it updates the cluster database. Stopping CXFS services is appropriate only for a server-capable administration node.)

If you are going to perform maintenance on a potential metadata server, you should first shut down CXFS services on it. Disabled nodes are not used in CXFS kernel membership calculations, so this action may prevent a loss of quorum.

## Remove Unused Cluster Components

As long as a server-capable administration node remains configured in the cluster database, it counts against the cluster database quorum. However, the way it impacts the cluster depends upon the actual node count.

If a server-capable administration node is expected to be down for longer than the remaining mean-time to failure (MTTF) of another server-capable administration node in the cluster, you should remove it from the cluster and the pool in order to avoid problems with cluster database membership and CXFS membership quorum. See the following sections:

- "Modify a Cluster Definition with the GUI" on page 195
- "Delete a Node with `cxfs_admin`" on page 250

You should leave a client-only node in the cluster database unless you are permanently removing it.

You should also remove the definitions for unused objects such as filesystems and switches from the cluster database. This will improve the cluster database performance and reduce the likelihood of cluster database problems.

## Use `fam` Properly

If you want to use the file alteration monitor (`fam`), you must remove the `/dev/imon` file from CXFS nodes. Removing this file forces `fam` to poll the filesystem. For more information about the monitor, see the `fam(3)` man page.

## Upgrade the Software Properly

Do the following when upgrading the software:

- Save the current CXFS configuration as a precaution before you start an upgrade and acquire new CXFS server-side licenses (if required). See:
  - Chapter 13, "Cluster Database Management" on page 349
  - Chapter 5, "CXFS Licensing" on page 103
- Read the release notes and any late-breaking caveats on Supportfolio before installing or upgrading CXFS. These contain important information needed for a stable install/upgrade.

- Do not make any other configuration changes to the cluster (such as adding new nodes or filesystems) until the upgrade of all nodes is complete and the cluster is running normally.

SGI recommends the following for server-capable administration nodes in a production cluster:

- Run the latest CXFS release.
- Run a release that is the same or later than the release run by client-only nodes. (The only exception is if the release in question does not apply to the server-capable administration nodes.)
- Run the same minor-level release (such as 4.0.3) on all server-capable administration nodes.

## Use Fast Copying for Large CXFS Files

You can use the `cxfsscp` command to quickly copy large files (64 KB or larger) to and from a CXFS filesystem. It can be significantly faster than the `cp` command on CXFS filesystems because it uses multiple threads and large I/Os to fully use the bandwidth to the storage hardware.

Files smaller than 64 KB do not benefit from large direct I/Os. For these files, `cxfsscp` uses a separate thread using buffered I/O, similar to `cp`.

The `cxfsscp` command is available on Linux and Windows platforms. However, some options are platform-specific, and other limitations apply.

By default, `cxfsscp` uses direct I/O. To use buffered I/O, use the `--bi` and `--bo` options; for more information and a complete list of options, see the `cxfsscp(1)` man page.

## Do Not Change Log File Names

You should not change the names of the log files. If you change the names of the log files, errors can occur. If the disk is filling with log messages, see "Log File Management" on page 310.

## Rotate Log Files

Periodically, you should rotate log files to avoid filling your disk space; see "Log File Management" on page 310. If you are having problems with disk space, you may want to choose a less verbose log level; see "Configure Log Groups with the GUI" on page 200.

## Use System Capacity Wisely

To avoid a loss of connectivity between the metadata server and the CXFS clients, do not oversubscribe the metadata server or the private network connecting the nodes in the cluster. Avoid unnecessary metadata traffic.

If the amount of free memory is insufficient, a node may experience delays in CXFS kernel heartbeat and as a result will be kicked out of the CXFS membership. Examine the `/proc` filesystem for more information and use the commands found in the Linux `procps` RPM to monitor memory usage, in particular:

```
free
slabtop
vmstat
```

See also:

- "Provide Enough Memory" on page 50
- "Dedicate Server-Capable Administration Nodes to CXFS Work" on page 53
- "Out of Logical Swap Space" on page 418

## Reboot Before Changing Node ID or Cluster ID

If you want to change a node ID or the cluster ID, do the following:

1. Remove the current cluster definition for the node and/or cluster.
2. Reboot the node in order to clear the original values for node ID and cluster ID. (If you do not reboot before redefining, the kernel will still have the old values, which prohibits a CXFS membership from forming.) To change the cluster ID, you must reboot all nodes in the cluster.
3. Redefine the node ID or cluster ID

If you use `cdbreinit` on a server-capable administration node to recreate the cluster database, you must reboot it before changing the node IDs or the cluster ID.

See "Recreating the Cluster Database" on page 448.

## Reboot a Removed Node Before Returning it to the Cluster Definition

If you remove a node from the cluster definition (the list of nodes that are eligible to be members of the cluster), you must reboot it before adding it back into the cluster definition in order to avoid cell-ID issues.

## Restart CXFS on a Node after an Administrative CXFS Stop

If you perform an administrative CXFS stop (forced CXFS shutdown) on a node, you must perform an administrative CXFS start on that node before it can return to the cluster. If you do this while the database still shows that the node is in the cluster and is activated, the node will restart the CXFS membership daemon. Following a forced CXFS shutdown, the node can be prevented from restarting the CXFS membership daemon when CXFS is restarted by stopping CXFS services. (A forced CXFS shutdown alone does not stop CXFS services. A forced CXFS shutdown stops only the kernel membership daemon. Stopping CXFS services disables the node in the cluster database.)

For example, enter the following `cxfs_admin` command on the local node you wish to start:

```
cxfs_admin:mycluster> enable cmsd
```

See:

- "Disable a Node with `cxfs_admin`" on page 251
- "Enable a Node with `cxfs_admin`" on page 251
- "Enable or Disable CXFS Kernel Membership (`cmsd`) for the Local Node" on page 255
- "Forced CXFS Shutdown: Revoke Membership of Local Node" on page 307



## Restart the Cluster In an Orderly Fashion

SGI recommends that you do the following to restart the cluster in an orderly fashion if you have previously taken the entire cluster down for maintenance or because of server instability. This procedure assumes all nodes have been disabled.

1. Restart CXFS services (using the CXFS GUI or `cxfs_admin`) for the potential metadata servers. Do the following for each potential metadata server if you are using the `cxfs_admin` command:

```
cxfs_admin:clustername> enable node:admin1_nodename
cxfs_admin:clustername> enable node:admin2_nodename
...
```

2. Restart CXFS services on the client-only tiebreaker node:

```
cxfs_admin:clustername> enable node:tiebreaker_nodename
```

3. Restart CXFS services on the remaining client-only nodes: =

```
cxfs_admin:clustername> enable node:client1_nodename
cxfs_admin:clustername> enable node:client2_nodename
...
```

Repeat this step for each client-only node.

## Disable Nodes that Affect Membership Before Maintenance

You should disable a CXFS server-capable administration node or a client-only tiebreaker node before shutting it down for maintenance or otherwise taking it offline because these types of nodes will affect the CXFS kernel membership quorum calculation as long as they are configured as enabled in the cluster database. See "Disable a Node with `cxfs_admin`" on page 251.

## Disable Reset If You Remove Reset Capability

When reset is enabled, CXFS requires a `reset successful` message before it moves the metadata server. Therefore, if you have reset enabled when you must remove the reset capability for some reason, you must first disable reset before removing the reset capability. See the following:

- "Modify a Node Definition with the GUI" on page 189

- "Create or Modify a Node with `cxfs_admin`" on page 242

### Avoid Performance Problems with Unwritten Extent Tracking

When you define a filesystem, you can specify whether unwritten extent tracking is on (`unwritten=1`) or off (`unwritten=0`); it is on by default.

In most cases, the use of unwritten extent tracking does not affect performance and you should use the default to provide better security. However, unwritten extent tracking can affect performance when **both** of the following are true:

- A file has been preallocated
- Preallocated extents are written for the first time with records smaller than 4 MB

For optimal performance with CXFS when **both** of these conditions are true, it may be necessary to build filesystems with `unwritten=0` (off).



---

**Caution:** There are security issues with using `unwritten=0`.

---

### Avoid Performance Problems with Exclusive Write Tokens

For proper performance, CXFS should not obtain exclusive write tokens. Therefore, use the following guidelines:

- Preallocate the file.
- Set the size of the file to the maximum size and do not allow it to be changed, such as through truncation.
- Do not append to the file. (That is, `O_APPEND` is not true on the open.)
- Do not mark an extent as `written`.
- Do not allow the application to do continual preallocation calls.

### Use Disk Layout Optimization for Approved Media Customers

Approved media customers can use the XFS `filestreams` mount option with CXFS to maximize the ability of storage to support multiple real-time streams of video data.

It is appropriate for workloads that generate many files that are created and accessed in a sequential order in one directory.



---

**Caution:** SGI must validate that your RAID model and RAID configuration can support the use of the `filestreams` mount option to achieve real-time data transfer and that your application is appropriate for its use. Use of this feature is complex and is reserved for designs that have been approved by SGI.

---

For more information, see "Disk Layout Optimization for Approved Media Customers" on page 341.

## Set System Tunable Parameters Appropriately

You should use care when changing system tunable parameters. Do not change restricted system tunable parameters unless directed to do so by SGI support. For details, see Appendix D, "System Tunable Parameters" on page 479.

There are several configuration files that you can use to set a tunable automatically. SGI recommends that you use the `/etc/modprobe.conf.local` file. This file specifies options for modules and can be used to set options that cannot be set with `sysctl`. To set an option, add a line of the following format to `/etc/modprobe.conf.local`:

```
options modulename tunablename=value
```

In this guide, the *modulename* value to be used is given in the "Location" entry in Appendix D, "System Tunable Parameters" on page 479. For example, `sgi-cxfs` is the module name for the tunable `rhelpld_max`. Therefore, to set the value of `rhelpld_max` to 128, you would add the following line to `/etc/modprobe.conf.local`:

```
options sgi-cxfs rhelpld_max=128
```

There should be only one `options` line per module; if you want to specify multiple parameters, you must place them all on that single line.

---

**Note:** SGI does not recommend using `/etc/sysctl.conf` because it is a global configuration file that might be affected by upgrades of nonrelated software.

---

## Keep the `telnet` Port Open on the Switch

If there are problems with a node, the I/O fencing software sends a message via the `telnet` protocol to the appropriate Fibre Channel switch. The switch only allows one `telnet` session at a time; therefore, if you are using I/O fencing, you must keep the `telnet` port on the Fibre Channel switch free at all times.



---

**Caution:** Do not perform a `telnet` to the switch and leave the session connected.

---

## Solve Problems Efficiently

To solve problems efficiently, understand the information in "Troubleshooting Strategy" on page 375 and gather the information discussed in "Reporting Problems to SGI" on page 451.

## Do Not Overfill CXFS Filesystems

For best performance, keep your CXFS filesystems under 98% full. This is also a best practice for a local filesystem, but is even more important for a CXFS filesystem because of fragmented files and increased metadata traffic.

## Use a Time Synchronization Application

Some CXFS operations apply a client timestamp to a file and other operations apply a metadata server timestamp, even if a file is only accessed by a single client. If the system clocks on nodes in a CXFS cluster are not synchronized, timestamps on shared files may appear to change erratically and be unreliable. Therefore, SGI highly recommends that you use a time synchronization application such as Network Time Protocol (NTP).

## Turn Off Local XVM on Linux Nodes if Unused

If you do not have a local XVM volume on your Linux system, you should turn off the `boot.lvm` script to avoid unnecessarily probing all of the disks and `lun0` LUNs to which the machine has access. Do the following:

```
# chkconfig boot.lvm off
```

## Avoid Memory-Mapped I/O for DMF Filesystems

If you are running DMF in your CXFS cluster, you should not use memory-mapped I/O on files within DMF filesystems because the results are unpredictable.

Specifically, if an application uses `mmap(2)` to memory-map a file within a DMF filesystem and DMF subsequently makes the file offline, the application could see zeros instead of its data for subsequent pages brought into memory as the result of page faults. Similarly, if a file in a DMF filesystem is memory-mapped and then changed, it is possible for those changes to be lost if DMF subsequently makes the file offline.

On Linux clients, memory-mapping an offline file in a DMF filesystem may cause other processes such as `ps(1)` to block while DMF is making the file online.

On Windows clients, using memory-mapped files can be unavoidable because a file can become memory-mapped by many different methods, such as by moving the mouse over the file's icon or viewing the folder that contains the file. Windows does not notify the filesystem that the file is memory-mapped, and Windows will keep a file memory-mapped until it is forced to relinquish the file.

You should therefore use memory-mapped I/O in a CXFS cluster that has the following characteristics:

- Does not have Windows clients
- Is running DMF only on the metadata server or in non-DMF filesystems

## Do Not Use Both `dmi` and `filestreams` Mount Options

Do not use both the `dmi` mount option for DMF and the `filestreams` mount options for the `filestreams` allocator. DMF is not able to arrange file extents on disk in a contiguous fashion when restoring offline files. This means that a DMF-managed filesystem most likely will not maintain the file layouts or performance characteristics normally associated with filesystems using the `filestreams` mount option.

## After Restart, Verify that All Nodes Use the Preferred XVM Path

After restarting a node or after any failures in the fabric, you should verify that all nodes in the cluster are using the preferred XVM path. To perform the verification, you must use the following command on each node:

```
xvm show -v phys | grep preferred
```

If the preferred path is being used, the string `<currentpath>` is displayed (line breaks shown here for readability):

```
# xvm show -v phys | grep preferred
/dev/disk/by-path/pci-0002:00:01.0-fc-0x202400a0b85a42c2:0x0000000000000000
  <dev 2176> affinity=1 preferred <current path>

/dev/disk/by-path/pci-0002:00:01.1-fc-0x202500a0b85a42c2:0x0001000000000000
  <dev 2288> affinity=2 preferred <current path>

/dev/disk/by-path/pci-0002:00:01.1-fc-0x200500a0b8184876:0x0001000000000000
  <dev 2256> affinity=2 preferred <current path>

/dev/disk/by-path/pci-0002:00:01.0-fc-0x200400a0b8184876:0x0000000000000000
  <dev 2080> affinity=1 preferred <current path>
```

The following shows that no LUN is using the preferred path because `<current path>` is not displayed (line breaks shown here for readability):

```
# xvm show -v phys | grep preferred
/dev/disk/by-path/pci-0002:00:01.0-fc-0x202400a0b85a42c2:0x0000000000000000
  <dev 2176> affinity=1 preferred

/dev/disk/by-path/pci-0002:00:01.1-fc-0x202500a0b85a42c2:0x0001000000000000
  <dev 2288> affinity=2 preferred

/dev/disk/by-path/pci-0002:00:01.1-fc-0x200500a0b8184876:0x0001000000000000
  <dev 2256> affinity=2 preferred

/dev/disk/by-path/pci-0002:00:01.0-fc-0x200400a0b8184876:0x0000000000000000
  <dev 2080> affinity=1 preferred
```

## Use Improved `mkfs` Options

A number of `mkfs` options have been introduced that improve performance. For more information, see the `mkfs.xfs(8)` man page.

However, these options are not compatible with all CXFS platforms. Nodes running RHEL 4 (or any update) require that the filesystem be built with the following options:

```
server# mkfs -t xfs -l lazy-count=0 -i attr=1
```

Depending upon version of the `mkfs.xfs` program that is installed, these options may or may not be the default. The parameters used are printed by `mkfs.xfs` when run, and can also be obtained later by using the following command on SLES systems:

```
sles# xfs_info mountpoint
```





## SGI RAID for CXFS Clusters

This chapter discusses SGI RAID for CXFS clusters:

- "RAID Hardware" on page 89
- "RAID Firmware" on page 90
- "Number of LUNs Supported" on page 91
- "RAID Verification" on page 93

For additional updates, see the CXFS release notes.

### RAID Hardware

CXFS supports the following RAID hardware:

SGI InfiniteStorage 15000  
SGI InfiniteStorage 11000  
SGI InfiniteStorage 10000  
SGI InfiniteStorage 6700  
SGI InfiniteStorage 6120  
SGI InfiniteStorage 4600  
SGI InfiniteStorage 4500  
SGI InfiniteStorage 4100  
SGI InfiniteStorage 4000  
SGI InfiniteStorage 220 (Fibre Channel)  
SGI RM610  
SGI RM660  
SGI TP9700  
SGI TP9500S (serial ATA)  
SGI TP9500  
SGI TP9400  
SGI TP9300S (serial ATA)  
SGI TP9300  
SGI TP9100  
SGI S330

The SGI RAID will be initially installed and configured by SGI personnel.

## RAID Firmware

SGI RAID supports the following firmware:

---

**Note:** SGI InfiniteStorage 220 does not support online updates of the controller firmware.

---

- SGI InfiniteStorage 11000 and 15000 supports controller firmware version 6.02 or later.
- SGI InfiniteStorage 6700 supports controller firmware version V3.00 or later.
- SGI InfiniteStorage IS4600 supports controller firmware version 7.36 or later
- SGI InfiniteStorage IS4100 supports controller firmware version 7.60 or later
- SGI RM610 and RM660 running version 5.12b or later.
- The TP9700 9.14 CD contains the required controller firmware and NVSRAM files. The 06.14.xx.xx code or later must be installed.
- The TP9500S 8.0 CD contains the required controller firmware and NVSRAM files. The 05.41.xx.xx code or later must be installed.
- The TP9400/TP9500 6.0 CD contains the required controller firmware and NVSRAM files. The 05.30.xx.xx code or later must be installed.
- The TP9400 4.0 CD contains the required controller firmware and NVSRAM files for the 4774 or 4884 units:
  - If you have a 4774 unit, the 04.01.xx.xx , 04.02.xx.xx, or 05.30.xx.xx code or later must be installed
  - If you have a 4884 unit, the 04.02.xx.xx code is installed by default
- The TP9300S 8.0 CD contains the required controller firmware and NVSRAM files. The 05.41.xx.xx code or later must be installed if using 2882 controllers, or 05.42.xx.xx code or later if using 2822 controllers.

---

**Note:** The initial TP9300S used 2882 controllers in the controller module. This product was later replaced with a 2822 controllers (still using the TP9300S marketing code). With the release of the 2822 controller, SATA disk drives can be installed in the controller module (the 2882 did not have disk drives installed in the controller module).

---

- The TP9300 8.42 CD (TPSSM 8.42) contains the required 8.42 firmware for the S330.
  - The TP9300 7.0 CD contains the required controller firmware and NVSRAM files. The 05.33.xx.xx code or later must be installed.
  - The TP9100 1Gb 4.0 CD contains the required version 7.75 controller firmware for the 1-Gbit TP9100. Supported via special request with optical attach (other conditions may apply).
  - TP9100 2Gb requires firmware 9.03 or later
  - The TP9100 5.0 CD contains the required version 8.40 firmware for the 2-Gbit TP9100.
- 

**Note:** The TP9100 is limited to 64 host connections.

---

- The TP9100 4.0 CD contains the required version 7.75 controller firmware for the 1-Gbit TP9100. Supported via special request with optical attach (other conditions may apply).

See also "XVM Failover Version 2 Overview" on page 35.

## Number of LUNs Supported

By default, the RAID firmware and/or RAID controller supports a maximum number of logical units (LUNs), as shown in Table 3-1.

In some cases, you can obtain a separate software-enabling key that key will support a larger number of LUNs in separate partitions; this requires that the Fibre Channel ports be mapped to a partition. Contact your SGI sales representative for the SGI software partitioning key.

**Table 3-1** Number of LUNs Supported

Firmware	Controller	Default LUN Maximum	Optional LUN Maximum with a Partitioning Key
04.01.xx.xx		32	128
04.02.xx.xx		32	128
05.30.xx.xx		32	1024
05.33.xx.xx		32	2048
05.40.xx.xx		256	2048
06.14.xx.xx		32	2048
06.15.xx.xx		1024	
06.16.xx.xx		1024	
06.17.xx.xx		62	2048
06.19.xx.xx		2048	
06.60.xx.xx		2048	
07.10.xx.xx	IS4000	2048	
07.10.xx.xx	IS4500/IS4700	4096	
07.35.xx.xx		2048	
07.36.xx.xx	IS4000	2048	
07.36.xx.xx	IS4500, IS4600, IS4700	4096	
07.50.xx.xx	IS4000	2048	
07.50.xx.xx	IS4500, IS4600, TP9700	4096	
07.60.xx.xx	IS4100	4096	
07.60xx.xx	IS4600	4096	
	IS6120	2048	
	IS6700	512	
	IS11000	1024	

Firmware	Controller	Default LUN Maximum	Optional LUN Maximum with a Partitioning Key
	IS15000	1024	
	RM610	256	
	RM660	512	

## RAID Verification

To verify that the SGI RAID is properly installed and ready for use with CXFS, you can dump the RAID's profile and verify the controller software revisions.



## Switches

This chapter discusses the following:

- "Brocade Switch" on page 95
- "QLogic Fibre Channel Switch" on page 99

### Brocade Switch

This section discusses the following:

- "Brocade Firmware" on page 95
- "Verifying the Brocade Switch Firmware Version" on page 96
- "Verifying the Brocade License" on page 97
- "Limiting `telnet` Sessions" on page 97
- "Changing the Brocade FC Cable Connections" on page 99

See also "Change the Brocade Password when Prompted" on page 74.

### Brocade Firmware

All Brocade switches contained within the SAN fabric must have the appropriate Brocade firmware. For the currently supported firmware, see the CXFS general release notes.

If the current firmware level of the switches must be upgraded, please contact your local SGI service representative or customer support center.

The Brocade switch must be configured so that its Ethernet interface is accessible (using `telnet`) from all CXFS administration nodes. The fencing network connected to the Brocade switch must be physically separate from the private heartbeat network.



**Caution:** In order for I/O fencing to succeed, the admin user must not be logged in.

Switches using 4.x.x.x or later firmware permit multiple `telnet` sessions. However, CXFS I/O fencing requires a `telnet` lockout for global mutual exclusion when a fencing race occurs. Therefore, you must configure these switches to set the maximum allowed simultaneous `telnet` sessions for the `admin` user to 1. (Brocade switches running 3.x.x.x firmware are shipped with the required restrictions configured by default).

---

## Verifying the Brocade Switch Firmware Version

To verify the firmware version, log into the switch as user `admin` and use the `version` command, as shown in the following example:

```
workstation% telnet brocade1
Trying 169.238.221.224...
Connected to brocade1.example.com
Escape character is '^]'.

Fabric OS (tm) Release v2.6.0d

login: admin
Password:
brocade1:admin> version
Kernel:      5.4
Fabric OS:   v2.6.0d                <== Firmware Revision
Made on:    Fri May 17 16:33:09 PDT 2002
Flash:      Fri May 17 16:34:55 PDT 2002
BootProm:   Thu Jun 17 15:20:39 PDT 1999
brocade1:admin>
```



## Verifying the Brocade License

To verify the Brocade license, log into the switch as user admin and use the `licenseshow` command, as shown in the following example:

```
brocade:admin> licenseshow
dcRyzyScSedSz0p:
  Web license
  Zoning license
  SES license
  Fabric license
SQQQSyddQ9TRRdUP:
  Release v2.2 license
```

## Limiting telnet Sessions

You must limit the maximum allowed simultaneous telnet session:

- "Brocade 12000/24000/48000 and telnet" on page 97
- "Other Brocade Models and telnet" on page 98

### Brocade 12000/24000/48000 and telnet

To limit the maximum allowed simultaneous telnet sessions for the admin user to 1 on the Brocade 12000/24000/48000, do the following:

1. Connect to the switch via the `telnet` command and log in as `root`.
2. Use the `haShow` command to make sure that both central processors are up. This is indicated by the message `Heartbeat Up` within the output of the `haShow` command. If it is not up, wait a few minutes and run `haShow` again to check for the status.
3. Issue the `sync` command on the filesystems to avoid filesystem corruption:

```
# rsh 10.0.0.5 sync
# rsh 10.0.0.6 sync
```

4. Edit the `/etc/profile` file to change the `max_telnet_sessions` from 2 to 1 and place the information in a new file. For example:

```
# cd /etc
# sed -e 's/max_telnet_sessions=2/max_telnet_sessions=1/' profile >profile.new
```

5. Distribute the new profile to both partitions and central processors. For example:

```
# rcp /etc/profile.new 10.0.0.5:/etc/profile
# rcp /etc/profile.new 10.0.0.5:/mnt/etc/profile
# rcp /etc/profile.new 10.0.0.6:/etc/profile
# rcp /etc/profile.new 10.0.0.6:/mnt/etc/profile
```

6. Issue the `sync` command again to avoid filesystem corruption:

```
# rsh 10.0.0.5 sync
# rsh 10.0.0.6 sync
```

#### Other Brocade Models and telnet

To limit the maximum allowed simultaneous `telnet` sessions for the `admin` user to 1 on the Brocade 200E/300/3250/3252/3850/3852/3900/4100/4900/5000/5100/5300 , do the following:

1. Connect to the switch via the `telnet` command and log in as `root`.
2. Issue the `sync` command to avoid filesystem corruption:  

```
# sync
```
3. Edit the `/etc/profile` file to change the `max_telnet_sessions` from 2 to 1 and place the information in a new file. For example:

```
# cd /etc
# sed -e 's/max_telnet_sessions=2/max_telnet_sessions=1/' profile >profile.new
```

4. Distribute the edited profile file to both partitions on both central processors. For example:

```
# cp profile.new profile
# cp profile.new /mnt/etc/profile
```

5. Issue the `sync` command again to avoid filesystem corruption:

```
# sync
```

## Changing the Brocade FC Cable Connections

To change Brocade Fibre Channel cable connections used by nodes in the CXFS cluster, do the following:

1. Cleanly shut down CXFS services on the nodes affected by the cable change. Use the CXFS GUI or `cxfs_admin`.
2. Rearrange the cables as required.
3. Restart CXFS services.
4. Reconfigure I/O fencing if required. You must perform this step if I/O fencing is enabled on the cluster and if you added/removed any Brocade switches. You must use the CXFS GUI or `cxfs_admin` to add or remove switches from the CXFS configuration as required.
5. If any CXFS client nodes are connected to a new (or different) Brocade switch, restart CXFS services on those nodes. This will ensure that the CXFS administration servers can correctly identify the Brocade ports used by all clients.

## QLogic Fibre Channel Switch

All QLogic Fibre Channel (FC) switches contained within the SAN fabric must have the appropriate QLogic firmware installed, as shown in the CXFS general release notes.

For more information, see the QLogic *SANbox2-64 Switch Management User's Guide*.



**Caution:** The `admin` state is required for I/O fencing. To avoid interference with fencing, release `admin` mode as soon as possible. Do not leave `admin` mode sessions open.

---

The default port configuration on a QLogic 9200 FC switch is not compatible with the CXFS environment. To use the appropriate port configuration, change the following parameters:

<code>LinkSpeed</code>	Set to the appropriate value, such as 2 for 2 GB/s. (In some cases, <code>Auto</code> does not function properly.)
<code>PortType</code>	Enter the appropriate type, usually F. (You cannot use the <code>GL</code> autonegotiated mode.)

NoClose	Set to <code>True</code> to prevent the Fibre Channel circuit from shutting down during a host reboot.
IOStreamGuard	Set to <code>Enable</code> if the port is connected to a host HBA or to <code>Disable</code> if the port is connected to a storage HBA. (You cannot use <code>Auto</code> mode because most HBAs cannot negotiate this.)

To modify these parameters, use the `admin` command. For example, for a port connected to an SGI Altix:

```
SANbox #> admin start
```

```
SANbox (admin) #> config edit
```

```
The config named default is being edited.
```

```
SANbox (admin-config) #> set config port 31
```

A list of attributes with formatting and current values will follow. Enter a new value or simply press the ENTER key to accept the current value. If you wish to terminate this process before reaching the end of the list press 'q' or 'Q' and the ENTER key to do so.

```
Configuring Port Number: 31
```

```
-----
```

```
AdminState      (1=Online, 2=Offline, 3=Diagnostics, 4=Down) [Online]
LinkSpeed       (1=1Gb/s, 2=2Gb/s, 4=4Gb/s, A=Auto) [Auto ] 2
PortType        (GL / G / F / FL / Donor) [GL ] F
SymPortName     (string, max=32 chars) [Port31] Altix45
ALFairness      (True / False) [False ]
DeviceScanEnable (True / False) [True ]
ForceOfflineRSCN (True / False) [False ]
ARB_FF          (True / False) [False ]
InteropCredit   (decimal value, 0-255) [0 ]
ExtCredit       (dec value, increments of 15, non-loop only) [0 ]
FANEnable       (True / False) [True ]
AutoPerfTuning  (True / False) [True ]
MSEnable        (True / False) [True ]
NoClose         (True / False) [False ] True
IOStreamGuard   (Enable / Disable / Auto) [Auto ] Enable
```

```
PDISCPingEnable (True / False) [True ]
```

Finished configuring attributes.

This configuration must be saved (see config save command) and activated (see config activate command) before it can take effect. To discard this configuration use the config cancel command.

....

```
SANbox (admin-config) #> config save
```

The config named default has been saved.

```
SANbox (admin) #> config activate
```

The currently active configuration will be activated.

Please confirm (y/n): [n] **y**

```
SANbox (admin) #> admin end
```

```
SANbox #> show config port 31
```

Configuration Name: default

-----

Port Number: 31

-----

AdminState	Online
LinkSpeed	2Gb/s
PortType	F
SymbolicName	Altix45
ALFairness	False
DeviceScanEnabled	True
ForceOfflineRSCN	False
ARB_FF	False
InteropCredit	0
ExtCredit	0
FANEnabled	True
AutoPerfTuning	True
MSEnabled	True
NoClose	True
IOStreamGuard	Enabled
PDISCPingEnabled	True



## CXFS Licensing

---

**Note:** On SGI Altix and SGI Altix XE hardware platforms running SGI Foundation Software, *CPU count* is the number of processor sockets. On all other hardware platforms, or SGI Altix XE hardware running any other operating system, *CPU count* is the number of processor cores.

---

The licensing used for server-capable administration nodes is based on the SGI License Key (LK) software. Only server-side licensing is supported.

For the purposes of licensing, hyperthreaded CPUs are counted as a single processor, while multicore processors are counted as multiple processors. Therefore, a dual-core processor will be counted as 2 CPUs for the purposes of licensing with CXFS. A hyperthreaded CPU or hyperthreaded core would only be counted as a single CPU for licensing purposes.

This section discusses the following:

- "Server-Side Licensing Overview" on page 103
- "Gathering the Host Information" on page 110
- "Obtaining the License Keys from SGI" on page 110
- "Installing the License Keys" on page 110
- "Verifying the License Keys" on page 111
- "For More Information About Licensing" on page 116

See also "Upgrading Licenses" on page 284.

### Server-Side Licensing Overview

CXFS 6.0 and later requires server-side licensing and CXFS 6.0 licenses. Upgrading customers must obtain new licenses; contact your SGI support person.

CXFS server-side licensing uses license keys on the CXFS server-capable administration nodes; it does not require node-locked license keys on CXFS client-only nodes. The license keys are node-locked to each server-capable

administration node and specify the number and size of client-only nodes that may join the cluster membership.

Server-side licensing provides flexibility when changing the CXFS cluster configuration, such as the following:

- Adding nodes
- Changing the number of CPUs in one host
- Using a license key part-time from different nodes connected to the cluster

This section discusses the following:

- "Licensing Requirements" on page 104
- "Server-Side Client License Keys" on page 105
- "License Key Replication on Server Nodes" on page 106
- "Cumulative Client License Keys" on page 106
- "Examples of License Keys Required for Cluster Changes" on page 106

## Licensing Requirements

Server-side licensing requires the following license keys on each server-capable administration node:

- `CXFS_SS` (Altix ia64) or `CXFS_S SX` (Altix XE x86-64) feature license key. The CPU count in the server license key specifies the maximum number of sockets on the server. This license key is node-locked to the server.
- Client license keys, which specify the number and/or size of client-only nodes that may join the cluster. See "Server-Side Client License Keys" on page 105.

No license keys are required on the client-only nodes themselves.



---

**Note:** Other CXFS-aware products also require license keys:

- XVM cluster mirroring requires a license key on server-capable administration nodes in order for cluster nodes to access the cluster mirror. On CXFS client-only nodes, the user feature where applicable is honored after the `cxfs_client` service is started. XVM cluster mirroring on clients is also honored if it is enabled on the server. All CXFS client nodes need an appropriate mirror license key in order to access local mirrors.
  - If enabled, Guaranteed rate I/O version 2 (GRIOv2) requires a license key on the server-capable administration nodes
- 

## Server-Side Client License Keys

There are two classes of server-side client license keys:

- *Workstation client license keys* specify the number of nodes with as many as 16 CPUs running one of the following platforms:

Mac OS X  
Windows

For example, an 8-node workstation client license key will allow up to eight nodes running any combination of the supported workstation platforms to join CXFS membership. On Monday, you could have eight Windows 16-CPU nodes, on Tuesday you could have four Mac OS X nodes and four Windows 16-CPU nodes.

- *Enterprise client license keys* specify the total number of CPUs running one of the following platforms:

Linux on x86\_64 or ia64 architecture  
SGI Foundation Software (CPU count is the number of sockets, not cores)  
Windows (more than 16 CPUs)

For example, a 32-CPU enterprise license key will allow sixteen 2-CPU nodes, eight 4-CPU nodes, or one 32-CPU node to join membership. If your cluster contained an SGI Foundation Software node with 4 sockets (4 dual-core CPUs), it would use 4 of the licenses.

## License Key Replication on Server Nodes

The purchase of a workstation or enterprise license entitles you to generate a license key on each server-capable administration node in the cluster. Every server-capable administration node in the cluster should install a set of client license keys. A server will generate warnings in the system log if the license keys on one server-capable administration node are not equivalent to other server-capable administration nodes in the cluster.

---

**Note:** Server-side licensing does not introduce a point-of-failure in the CXFS cluster. If the metadata server fails and the cluster recovers to a backup server that has fewer/smaller client license keys, the client-only nodes that are currently in the cluster membership will remain in the membership. However, additional client-only nodes that attempt to join membership will fail until the membership count is reduced to below the license key entitlement on the active metadata server.

---

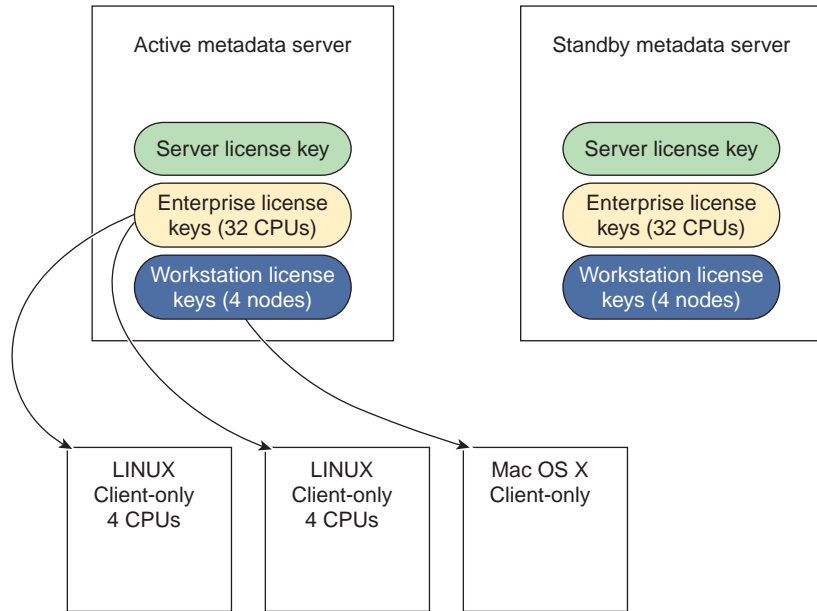
## Cumulative Client License Keys

The number of client license keys is cumulative. To add more client-only nodes, you can purchase additional workstation or enterprise licenses as appropriate (you do not have to upgrade existing license keys).

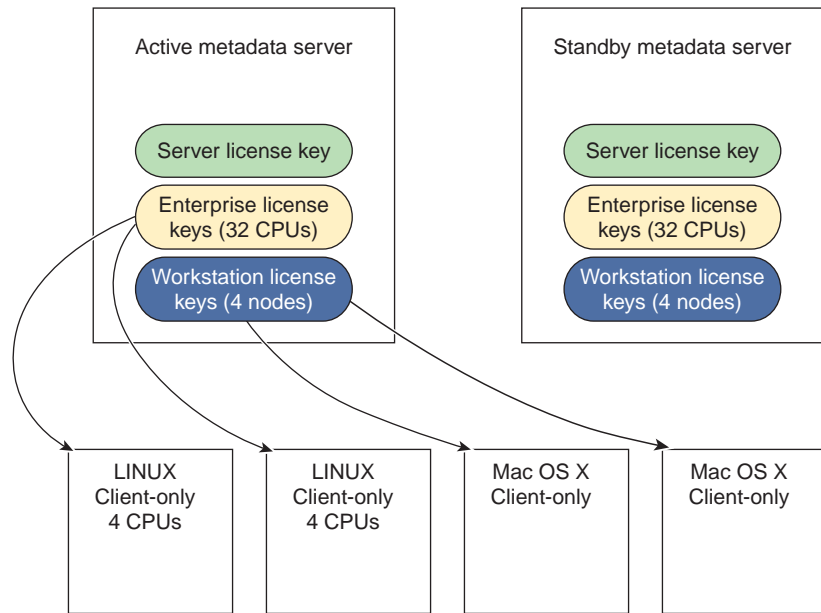
For example, if you already have a 32-CPU enterprise license key and want to add another 32-CPU enterprise-class machine, you purchase another 32-CPU enterprise license. You must install this new license key on every server-capable administration node in the cluster.

## Examples of License Keys Required for Cluster Changes

The following figures show examples of the license keys that are required for cluster changes.



**Figure 5-1** Server-Side License Keys



**Figure 5-2** Server-Side License Keys: Adding a New Client-Only Node

Table 5-1 further illustrates the progressive changes in license keys required by a cluster as nodes are added and removed.

**Table 5-1** Examples of License Keys Required for Cluster Changes

Action	Resulting Configuration	Licensing
Initial configuration	1 x 4-socket server-capable administration node 4 x 2-CPU Windows clients	Purchase one 4-CPU CXFS_SS server license key and one 5-node workstation license key. Generate the 5-node workstation license key (CXFS_SS_CLIENT_WRK) for the server-capable administration node (the extra license is for future expansion).
Add a 2-CPU Linux client	1 x 4-socket server-capable administration node 4 x 2-CPU Windows clients 1 x 2-CPU Linux client	No change, the 5-node workstation license key is now fully utilized.
Add an 8-socket SGI Foundation Software client	1 x 4-socket sever-capable administration node 4 x 2-CPU Windows clients 1 x 2-CPU Linux client 1 x 8-socket SGI Foundation Software client	Purchase an 8-CPU enterprise license key. Generate the 8-CPU enterprise license key (CXFS_SS_CLIENT_ENT) for the server-capable administration node.
Add another 4-socket server-capable administration node	2 x 4-socket server-capable administration node 4 x 2-CPU Windows clients 1 x 2-CPU Linux client 1 x 4-socket SGI ProPack client	Purchase another 4-CPU server license. Generate both workstation and enterprise client license keys for the new server-capable administration node from the original license keys.
Add an 8-CPU Linux node	2 x 4-socket server-capable administration nodes 4 x 2-CPU Windows clients 1 x 2-CPU Linux client 1 x 4-socket SGI ProPack client 1 x 8-CPU Linux client	Purchase an 8-CPU enterprise client license key. Generate the 8-CPU enterprise license key on each server-capable administration node.
Add a 4-CPU Mac OS X client for occasional use in the cluster	2 x 4-socket server-capable administration nodes 4 x 2-CPU Windows clients 1 x 2-CPU Linux client 1 x 4-socket SGI ProPack client 1 x 4-CPU Mac OS X client	No change if one of the other workstation-class clients is dropped out of the cluster when the Mac OS X client is required.

## Gathering the Host Information

When you order CXFS, you will receive an entitlement ID. You must submit the system host ID, host name, and entitlement ID when requesting your permanent CXFS license key.

To obtain the host information for a server-capable administration node, execute the following command (assuming that the `lkSGI` RPM from SGI Foundation Software has been installed):

```
/usr/sbin/lk_hostid
```

For example, the following shows that the serial number is `000423d5fd92` and the license ID is `23d5fd92`:

```
server-admin# lk_hostid
000423d5fd92 23d5fd92 socket=1 core=2 processor=2
#-----
#The above is the default selected by lk_hostid. See below for additional
#hostid pairs.
#-----
#Interface  SN                      LI                      Driver ( Comment )
#-----
eth0        000423d5fd92              23d5fd92               e1000
eth1        000423d5fd93              23d5fd93               e1000
```

## Obtaining the License Keys from SGI

To obtain your CXFS and XVM license keys, see information provided in your customer letter and the following web page:

<http://www.sgi.com/support/licensing>

## Installing the License Keys

To install the license keys, copy them into the `/etc/lk/keys.dat` file.

## Verifying the License Keys

This section discusses the following:

- "Verifying the License Keys with `lk_verify`" on page 111
- "Verifying the License Keys with `cxfslicense` After Installing CXFS" on page 113
- "Displaying the License Keys with `cxfs_admin` After Installing CXFS" on page 114

See also "License Key Error" on page 419.

For information about verifying the XVM mirror licenses on client-only nodes, see the *CXFS 5 Client-Only Guide for SGI InfiniteStorage*.

### Verifying the License Keys with `lk_verify`

You can use the `lk_verify -A` command to verify LK licenses. To see more output, use the `v` option. For example:

```
#14:06:45 lk_verify -A -vvv
lk_check    All    All : total found=6

1 /etc/lk/keys.dat:005    product=CXFS_S SX, version=6.000, count=0, begDate=1255964949, \
  expDate=1263794399, licenseID=23d5fd92, key=Kod/0ke9XCMEC8zzuuQr8OuaETY935J2, \
  info='CXFS SVR XE 8 CPU',attr='CPU 8', \
  vendor='Silicon Graphics International',ref_id='207462'
  Verdict:    SUCCESS. Nodelock. Uncounted.
              Available since 7 days on 19-Oct-2009 10:09:09.
              No End Date.

  Attribute 1 of 4 : info=CXFS SVR XE 8 CPU
  Attribute 2 of 4 : attr=CPU 8
  Attribute 3 of 4 : vendor=Silicon Graphics International
  Attribute 4 of 4 : ref_id=207462

2 /etc/lk/keys.dat:013    product=CXFS_SS_CLIENT_WRK, version=6.000, count=0, begDate=1255965205, \
  expDate=1263794399, licenseID=23d5fd92, key=ggS3SqQEbdDRgUXAUh5txcPQePdLbNu6G, \
  info='CXFS WRK 50 NODE',attr='NODE 50', \
  vendor='Silicon Graphics International',ref_id='207464'
```

## 5: CXFS Licensing

---

Verdict: SUCCESS. Nodelock. Uncounted.  
Available since 7 days on 19-Oct-2009 10:13:25.  
No End Date.

Attribute 1 of 4 : info=CXFS WRK 50 NODE  
Attribute 2 of 4 : attr=NODE 50  
Attribute 3 of 4 : vendor=Silicon Graphics International  
Attribute 4 of 4 : ref\_id=207464

3 /etc/lk/keys.dat:021 product=CXFS\_SS\_CLIENT\_ENT, version=6.000, count=0, begDate=1255965272, \  
expDate=1263794399, licenseID=23d5fd92, key=MzJ/TIrPoWFuuDyG2luGVG8BIdQJlzk, \  
info='CXFS ENT 256 CPU',attr='CPU 256', \  
vendor='Silicon Graphics International',ref\_id='207466'

Verdict: SUCCESS. Nodelock. Uncounted.  
Available since 7 days on 19-Oct-2009 10:14:32.  
No End Date.

Attribute 1 of 4 : info=CXFS ENT 256 CPU  
Attribute 2 of 4 : attr=CPU 256  
Attribute 3 of 4 : vendor=Silicon Graphics International  
Attribute 4 of 4 : ref\_id=207466

4 /etc/lk/keys.dat:027 product=sgi-nfs, version=2.000, count=0, begDate=1255965345, \  
expDate=1263794399, licenseID=23d5fd92, key=IbZB1kp/U1+UzchWzrrQWZdhJTGgLkxM, \  
info='ENHANCED NFS 2.0 LNX', vendor='Silicon Graphics International', \  
ref\_id='207468'

Verdict: SUCCESS. Nodelock. Uncounted.  
Available since 7 days on 19-Oct-2009 10:15:45.  
No End Date.

Attribute 1 of 3 : info=ENHANCED NFS 2.0 LNX  
Attribute 2 of 3 : vendor=Silicon Graphics International  
Attribute 3 of 3 : ref\_id=207468

5 /etc/lk/keys.dat:034 product=XVM\_PLEX\_LINUX, version=6.000, count=0, begDate=1255965403, \  
expDate=1263794399, licenseID=23d5fd92, key=tNy2JyQM3Eskhvezn0bYdK4qR7EI8ewp, \  
info='XVM PLEX STD 6 S',attr='4 CPU', \  
vendor='Silicon Graphics International',ref\_id='207470'



```
Verdict:      SUCCESS. Nodelock. Uncounted.
             Available since 7 days on 19-Oct-2009 10:16:43.
             No End Date.
```

```
Attribute 1 of 4 : info=XVM PLEX STD 6 S
Attribute 2 of 4 : attr=4 CPU
Attribute 3 of 4 : vendor=Silicon Graphics International
Attribute 4 of 4 : ref_id=207470
```

```
6 /etc/lk/keys.dat:042   product=XVM_PLEX_CLUSTER, version=6.000, count=0, begDate=1255965484, \
expDate=1263794399, licenseID=23d5fd92, key=WCLelTS9AckjKtDOBOFvZIRVpZhHvrO3, \
info='XVM PLEX CLSTR 6.0 1',attr='NODE 32', \
vendor='Silicon Graphics International',ref_id='207472'
```

```
Verdict:      SUCCESS. Nodelock. Uncounted.
             Available since 7 days on 19-Oct-2009 10:18:04.
             No End Date.
```

```
Attribute 1 of 4 : info=XVM PLEX CLSTR 6.0 1
Attribute 2 of 4 : attr=NODE 32
Attribute 3 of 4 : vendor=Silicon Graphics International
Attribute 4 of 4 : ref_id=207472
```

```
lk_check      All      All : total matched=6
```

## Verifying the License Keys with `cxfslicense` After Installing CXFS

To verify that the license keys have been installed properly, use the `cxfslicense -d` command **after installing the CXFS software** (see Chapter 7, "Server-Capable Administration Node Installation" on page 123). Licensing errors will be reported to the `fs2d` log.

For example, the following output shows that the licenses are in place for XVM and CXFS (the `XVM_SNAP_LINUX` license is obsolete):

```
serveradmin# /usr/cluster/bin/cxfslicense -d
Found 1 XVM_STD_LINUX license(s) of version 6.0 for XVM.
Found 1 XVM_PLEX_LINUX license(s) of version 6.0 for XVM.
Found 1 XVM_PLEX_CLUSTER license(s) of version 6.0 for XVM.
Didn't find XVM_SNAP_LINUX license of version 6.0 for XVM.
```

```
License(s) found: 1
Found 'CPU 8' serial 092039
Found 8 CPU version 6.0 license for CXFS_SS
Server-side licensing is available
License(s) found: 1
Found license for 50 of CXFS_SS_CLIENT_WRK 6.0 serial 092042
License(s) found: 1
Found license for 256 of CXFS_SS_CLIENT_ENT 6.0 serial 092045
```

If no valid license is found, `cxfslicense -d` will report:

```
server-admin# /usr/cluster/bin/cxfslicense -d
Didn't find XVM_STD_LINUX license of version 6.0 for XVM.
Didn't find XVM_PLEX_LINUX license(s) of version 6.0 for XVM.
Didn't find XVM_PLEX_CLUSTER license of version 6.0 for XVM.
Didn't find XVM_SNAP_LINUX license of version 6.0 for XVM.

Cannot find valid version 6.0 license for CXFS_SS

No CXFS server-side license, any server-side client licenses will be
ignored.

No licenses available for CXFS_SS_CLIENT_WRK 6.0.
No licenses available for CXFS_SS_CLIENT_ENT 6.0.

Error: No valid CXFS licenses found for this server.
```

The `cxfs_admin status` command displays the number of server-side license keys that have been issued to clients. See "cxfs\_admin and Status" on page 366.

Also see "License Key Error" on page 419.

## Displaying the License Keys with `cxfs_admin` After Installing CXFS

You can use the `cxfs_admin` command to display license information **after installing the CXFS software** (see Chapter 7, "Server-Capable Administration Node Installation" on page 123).

For example, the following is output from the `show licenses` command for the `clusterOne` cluster:

```
cxfs_admin:clusterOne > show licenses
Event at [ Jan 26 11:45:15 ]
status:licenses:
  cxfs_client:
    enterprise:
      valid=256
    workstation:
      allocated=2
      valid=50
```

For example, the following is output from the `status` command for the `clusterOne` cluster:

```

cxfs_admin:clusterOne > status
Event at [ Jan 26 11:48:12 ]
Cluster      : clusterOne
Tiebreaker   :
Client Licenses : enterprise  allocated 0 of 256
                  workstation  allocated 2 of 50
-----
Node          Cell ID  Age   Status
-----
bert *        1        5    Stable
cxfsxe5 *     0        26   Stable
cxfs3         4        0    Disabled
penguin17    2        1    Stable
pg-27        3        12   Stable

-----
Filesystem    Server Name  Status
-----
zj01s0       cxfsxe5     Mounted [4 of 5 nodes]
zj01s1       N/A         Unmounted
zj0ds2       cxfsxe5     Mounted [2 of 3 nodes]

-----
Switch        Port Count  Known Fenced Ports
-----
brocade26cp0 192        24, 25, 223

```

## For More Information About Licensing

To request software keys or information about software licensing, see the following web page:

<http://www.sgi.com/support/licensing>

If you do not have access to the web, please contact your local Customer Support Center.

## Preinstallation Steps

When you install the CXFS software, you must modify certain system files. The network configuration is critical. Each node in the cluster must be able to communicate with every other node in the cluster by both logical name and IP address without going through any other network routing; proper name resolution is key. SGI recommends static routing.

This section provides an overview of the steps that you should perform on your nodes prior to installing the CXFS software. It contains the following sections:

- "Hostname Resolution and Network Configuration Rules" on page 117
- "Adding a Private Network" on page 118
- "Verifying the Private and Public Networks" on page 121
- "Modifications Required for CXFS GUI Connectivity Diagnostics" on page 122
- "Configuring SuSEfirewall12" on page 122

### Hostname Resolution and Network Configuration Rules

---



**Caution:** It is critical that you understand these rules before attempting to configure a CXFS cluster.

---

Use the following hostname resolution rules and recommendations when defining a node:

- The first node you define in the pool must be an administration node.
- Hostnames cannot begin with an underscore (\_) or include any white-space characters.
- The private network IP addresses on a running node in the cluster cannot be changed while CXFS services are active.
- You must be able to communicate directly between every node in the cluster (including client-only nodes) using IP addresses and logical names, without routing.

- You must dedicate a private network for control messages, CXFS metadata, CXFS kernel heartbeat messages, and cluster database heartbeat messages. No other load is supported on this network.
- The private network must be connected to all nodes, and all nodes must be configured to use the same subnet for that network.
- Because CXFS kernel heartbeat and cluster database heartbeat are done using IP multicast, the private network must be multicast-capable. This means that all of the interfaces must have multicast enabled (which is the default) and all of the external networking hardware (such as switches) must support IP multicast.
- If you change hostname resolution settings in the `/etc/nsswitch.conf` file after you have defined the first administration node (which creates the cluster database), you must re-create the cluster database.

## Adding a Private Network

The following procedure provides an overview of the steps required to add a private network.

---

**Note:** A private network is required for use with CXFS.

---

You may skip some steps, depending upon the starting conditions at your site.

1. Edit the `/etc/hosts` file so that it contains entries for all nodes in the cluster and their private interfaces as well.

The `/etc/hosts` file has the following format, where *primary\_hostname* can be the simple hostname or the fully qualified domain name:

```
IP_address    primary_hostname    aliases
```

You should be consistent when using fully qualified domain names in the `/etc/hosts` file. If you use fully qualified domain names on a particular node, then all of the nodes in the cluster should use the fully qualified name of that node when defining the IP/hostname information for that node in their `/etc/hosts` file.

The decision to use fully qualified domain names is usually a matter of how the clients are going to resolve names for their client/server programs (such as NFS), how their default resolution is done, and so on.

Even if you are using the domain name service (DNS) or the network information service (NIS), you must add every IP address and hostname for the nodes to `/etc/hosts` on all nodes. For example:

```
190.0.2.1 server1-example.com server1
190.0.2.3 stocks
190.0.3.1 priv-server1
190.0.2.2 server2-example.com server2
190.0.2.4 bonds
190.0.3.2 priv-server2
```

You should then add all of these IP addresses to `/etc/hosts` on the other nodes in the cluster.

For more information, see the `hosts(5)` and `resolve.conf(5)` man pages.

---

**Note:** Exclusive use of NIS or DNS for IP address lookup for the nodes will reduce availability in situations where the NIS or DNS service becomes unreliable.

---

2. Edit the `/etc/nsswitch.conf` file so that local files are accessed before either NIS or DNS. That is, the `hosts` line in `/etc/nsswitch.conf` must list files first. For example:

```
hosts:      files nis dns
```

(The order of `nis` and `dns` is not significant to CXFS, but `files` must be first.)

3. Configure your private interface according to the instructions in the network configuration section of your Linux distribution manual. To verify that the private interface is operational, use the `ifconfig -a` command.

For example:

```
server-admin# ifconfig -a

eth0      Link encap:Ethernet  HWaddr 00:50:81:A4:75:6A
          inet addr:192.168.1.1  Bcast:192.168.1.255  Mask:255.255.255.0
          UP BROADCAST RUNNING MULTICAST  MTU:1500  Metric:1
          RX packets:13782788  errors:0  dropped:0  overruns:0  frame:0
          TX packets:60846  errors:0  dropped:0  overruns:0  carrier:0
          collisions:0  txqueuelen:100
          RX bytes:826016878 (787.7 Mb)  TX bytes:5745933 (5.4 Mb)
          Interrupt:19  Base address:0xb880  Memory:fe0fe000-fe0fe038

eth1      Link encap:Ethernet  HWaddr 00:81:8A:10:5C:34
          inet addr:10.0.0.10  Bcast:10.0.0.255  Mask:255.255.255.0
          UP BROADCAST MULTICAST  MTU:1500  Metric:1
          RX packets:0  errors:0  dropped:0  overruns:0  frame:0
          TX packets:0  errors:0  dropped:0  overruns:0  carrier:0
          collisions:0  txqueuelen:100
          RX bytes:0 (0.0 b)  TX bytes:0 (0.0 b)
          Interrupt:19  Base address:0xef00  Memory:febfd000-febfd038

lo        Link encap:Local Loopback
          inet addr:127.0.0.1  Mask:255.0.0.0
          UP LOOPBACK RUNNING  MTU:16436  Metric:1
          RX packets:162  errors:0  dropped:0  overruns:0  frame:0
          TX packets:162  errors:0  dropped:0  overruns:0  carrier:0
          collisions:0  txqueuelen:0
          RX bytes:11692 (11.4 Kb)  TX bytes:11692 (11.4 Kb)
```

This example shows that two Ethernet interfaces, `eth0` and `eth1`, are present and running (as indicated by `UP` in the third line of each interface description).

If the second network does not appear, it may be that a network interface card must be installed in order to provide a second network, or it may be that the network is not yet initialized.

4. (*Optional*) Make the modifications required to use CXFS connectivity diagnostics. See "Modifications for CXFS Connectivity Diagnostics" on page 126.



## Verifying the Private and Public Networks

For each private network on each server-capable administration node in the pool, verify access with the `ping` command:

1. Execute a `ping` using the private network. Enter the following, where *nodeIPAddress* is the IP address of the node:

```
ping nodeIPAddress
```

For example:

```
server-admin# ping 10.0.0.1
PING 10.0.0.1 (10.0.0.1) from 128.162.240.141 : 56(84) bytes of data.
64 bytes from 10.0.0.1: icmp_seq=1 ttl=64 time=0.310 ms
64 bytes from 10.0.0.1: icmp_seq=2 ttl=64 time=0.122 ms
64 bytes from 10.0.0.1: icmp_seq=3 ttl=64 time=0.127 ms
```

2. Execute a `ping` using the public network.
3. If `ping` fails, repeat the following procedure on each node:
  - a. Verify that the network interface was configured up using `ifconfig`. For example:

```
server-admin# ifconfig eth1
eth1      Link encap:Ethernet  HWaddr 00:81:8A:10:5C:34
          inet addr:10.0.0.10  Bcast:10.0.0.255  Mask:255.255.255.0
          UP BROADCAST MULTICAST  MTU:1500  Metric:1
          RX packets:0 errors:0 dropped:0 overruns:0 frame:0
          TX packets:0 errors:0 dropped:0 overruns:0 carrier:0
          collisions:0 txqueuelen:100
          RX bytes:0 (0.0 b)  TX bytes:0 (0.0 b)
          Interrupt:19 Base address:0xef00 Memory:febfd000-febfd038
```

In the third output line above, `UP` indicates that the interface was configured up.

- b. Verify that the cables are correctly seated.
4. Repeat this procedure on each node.

## Modifications Required for CXFS GUI Connectivity Diagnostics

In order to test node connectivity by using the GUI, the `root` user on the node running the CXFS diagnostics must be able to access a remote shell using the `rsh` command (as `root`) on all other nodes in the cluster. (This test is not required when using `cxfs_admin` because it verifies the connectivity of each node as it is added to the cluster.)

There are several ways of accomplishing this, depending on the existing settings in the pluggable authentication modules (PAMs) and other security configuration files.

The following method works with default settings. Do the following on **all nodes** in the cluster:

1. Install the `rsh-server` RPM.
2. Enable `rsh`.
3. Restart `xinted`.
4. Add `rsh` to the `/etc/securetty` file.
5. Add the hostname of the node from which you will be running the diagnostics into the `/root/.rhosts` file. Make sure that the mode of the `.rhosts` file is set to `600` (read and write access for the owner only).

After you have completed running the connectivity tests, you may wish to disable `rsh` on all cluster nodes.

For more information, see the Linux operating system documentation about PAM and the `hosts.equiv` man page.

## Configuring SuSEfirewall2

Linux uses `SuSEfirewall2` or `iptables` for IP filtering for the CXFS private network. `SuSEfirewall2` must either be turned off or configured appropriately. For more information, see the SuSE documentation.

## Server-Capable Administration Node Installation

On SGI Foundation Software nodes, CXFS supports either an *administration node* containing the cluster administration daemons (`fs2d`, `crsd`, `cad`, and `cmond`), the CXFS control daemon (`clconfd`), and the cluster database or a *client-only node* containing the `cxfs_client` daemon. The software you install on a node determines the node type.

---

**Note:** SGI Foundation Software is an overlay product that adds or enhances features in the supported Linux base distributions.

---

Nodes that you intend to run as metadata servers must be installed as administration nodes; all other nodes should be client-only nodes.

This chapter discusses the following:

- "Limitations and Considerations for Server-Capable Administration Nodes" on page 123
- "Installation Overview for Server-Capable Administration Nodes" on page 125
- "Installation Verification" on page 126
- "Modifications for CXFS Connectivity Diagnostics" on page 126

After completing these steps, see Chapter 9, "Initial Setup of the Cluster" on page 139. For details about specific configuration tasks, see Chapter 10, "CXFS GUI" on page 157.

## Limitations and Considerations for Server-Capable Administration Nodes

The following limitations and considerations apply to server-capable administration nodes in addition to the information in "CXFS Restrictions" on page 9. See also client-only node information in *CXFS 6 Client-Only Guide for SGI InfiniteStorage*.

- By default, DMAPAPI is turned off on SLES 10 and SLES 11 systems. When you install DMF on a server-capable administration node, it automatically enables DMAPAPI.

However, if you want to mount filesystems on a SLES 10 or SLES 11 client-only node with the `dmf` mount option, you must set `DMAPAPI_PROBE="yes"` in the

`/etc/sysconfig/sysctl` file on the node. Changes to the file will be processed on the next reboot.

After setting that system configuration file, you can immediately enable DMAPi for the current boot session by executing the following:

```
# sysctl -w fs.xfs.probe_dmapi=1
```

---

**Note:** These steps are not required on the DMF server or DMF parallel data mover nodes because these steps are done automatically when installing the `dmf` or `dmf-mover` packages.

---

If you run a DMAPi application other than DMF, you must also change the parameter on the server-capable administration nodes.

- GPT partition tables, often created by operating system installers or the `parted` partitioning tool, store labels in two locations. If you reuse a disk that previously had a GPT label, you must be careful; using tools such as `fdisk` to repartition the drive will not eliminate the backup GPT label. When you reboot, EFI scans the disks before the operating system is started. It assumes any backup labels it finds are valid and restores them. This can corrupt or destroy filesystems. You can use the `parted` tool to detect this situation and fix it.

---

**Note:** The `parted` tool has a `mkpartsect` command that accepts start and end values for partitions being created in sectors rather than MB. For more information, see the *XVM Volume Manager Administrator's Guide* and [http://support.sgi.com/content\\_request/838562/index.html](http://support.sgi.com/content_request/838562/index.html) on Supportfolio.

---

- CXFS filesystems with XFS version 1 directory format cannot be mounted on Linux nodes.
- The implementation of file creation using `O_EXCL` is not complete. Multiple applications running on the same node using `O_EXCL` create as a synchronization mechanism will see the expected behavior (only one of the creates will succeed). However, applications running on multiple nodes may not get the `O_EXCL` behavior they requested (creates of the same file from two or more separate nodes may all succeed).
- The CXFS metadata server is only capable of managing permissions for users with 32 or fewer group memberships. All accounts (including `root`) on CXFS clients must be limited to 32 or fewer groups.

## Installation Overview for Server-Capable Administration Nodes

---



**Caution:** CXFS is a complex product. To ensure that it is installed and configured in an optimal manner, you **must** purchase initial setup services from SGI. You should read through the following chapters before attempting to install and configure a CXFS cluster:

Chapter 1, "Introduction to CXFS" on page 1  
Chapter 2, "Best Practices" on page 47  
Chapter 3, "SGI RAID for CXFS Clusters" on page 89  
Chapter 4, "Switches" on page 95  
Chapter 5, "CXFS Licensing" on page 103  
Chapter 6, "Preinstallation Steps" on page 117  
Chapter 7, "Server-Capable Administration Node Installation" on page 123  
Chapter 8, "Postinstallation Steps" on page 129  
Chapter 9, "Initial Setup of the Cluster" on page 139

Also see the *CXFS 6 Client-Only Guide for SGI InfiniteStorage*.

---

Following is the order of installation and configuration steps:

1. Install the operating system (if not already done). See the CXFS release notes for supported levels.
2. Install and verify the RAID. See Chapter 3, "SGI RAID for CXFS Clusters" on page 89.
3. Install and verify the switch. See Chapter 4, "Switches" on page 95.
4. Obtain and install the CXFS license keys and (if needed) XVM license keys. See Chapter 5, "CXFS Licensing" on page 103.
5. Prepare the node, including adding a private network.
6. Install the CXFS software. See the *SGI InfiniteStorage Software Platform* release note. The ISSP release note is located in the `/docs/README.txt` on the DVD and is available on the Supportfolio download page.
7. Configure the cluster to define the new node in the pool, add it to the cluster, start CXFS services, and mount filesystems. See "Guided Configuration Tasks" on page 177.

8. Install the client-only nodes, as described in *CXFS 6 Client-Only Guide for SGI InfiniteStorage*.

## Installation Verification

To verify that the CXFS software has been installed properly, use the `rpm -qa` command to display all of the installed packages. You can filter the output by searching for particular package name.

For example, to verify that the `sgi-sysadm_base-lib` package has installed:

```
# rpm -qa | grep sgi-sysadm_base-lib
sgi-sysadm_base-lib-3.0-sgi200a6.sles11
```

---

**Note:** The output above is an example. The version level may not match the installed software.

---

To verify the SGI Foundation Software release, display the `/etc/sgi-foundation-release` file.

To verify licenses, see "Verifying the License Keys" on page 111.

## Modifications for CXFS Connectivity Diagnostics

If you want to use the cluster diagnostics to test node connectivity, the `root` user on the node running the CXFS diagnostics must be able to access a remote shell using the `rsh` command (as `root`) on all other nodes in the cluster. There are several ways of accomplishing this, depending on the existing settings in the pluggable authentication modules (PAM) and other security configuration files.

Following is one possible method. Do the following on all administration nodes in the cluster:

1. Install the `rsh-server` RPM using YaST.
2. Enable `rsh` by changing `disable yes` to `disable no` in the `/etc/xinetd.d/rsh` file.
3. Restart `xinetd`:

```
server-capable# service xinetd restart
```

4. Add the hostname of the node from which you will be running the diagnostics into the `/root/.rhosts` file. Make sure that the mode of the `.rhosts` file is set to `600` (read and write access for the owner only).

After you have completed running the connectivity tests, you may wish to disable `rsh` on all cluster nodes.

For more information, see the operating system documentation and the `hosts.equiv(5)` man page.





## Postinstallation Steps

When you install the CXFS software, there are some system file considerations you must take into account. **The network configuration is critical.** Each node in the cluster must be able to communicate with every other node in the cluster by both logical name and IP address without going through any other network routing; proper name resolution is key. SGI recommends static routing.

This section discusses the following:

- "Configuring `/etc/exports` on All Nodes" on page 129
- "Configuring Server-Capable Administration Node System Files" on page 130
- "Enabling GRIOV2 (*Optional*)" on page 136

After completing the steps discussed in this chapter, see Chapter 9, "Initial Setup of the Cluster" on page 139. For information about upgrades, see "CXFS Release Versions and Rolling Upgrades" on page 283.

### Configuring `/etc/exports` on All Nodes

The optional `/etc/exports` file on each node describes the filesystems that are being exported to NFS clients.

If the `/etc/exports` file contains a CXFS mount point, then when the system is booted NFS will export the empty mount point because the exports are done before CXFS is running. When CXFS on the node joins membership and starts mounting filesystems, the `clconfd-pre-mount` script searches the `/etc/exports` file looking for the mountpoint that is being mounted. If found, the script unexports the mountpoint directory because if it did not the CXFS mount would fail. After successfully mounting the filesystem, the `clconfd-post-mount` script will search the `/etc/exports` file and export the mount point if it is found in the `/etc/exports` file.

For more information, see "CXFS Mount Scripts" on page 298.

## Configuring Server-Capable Administration Node System Files

This section discusses system files on administration nodes:

- `/etc/services` on Server-Capable Administration Nodes" on page 130
- `cad.options` on Server-Capable Administration Nodes" on page 130
- `fs2d.options` on Server-Capable Administration Nodes" on page 131
- `clconfd.options` on Server-Capable Administration Nodes" on page 134

### `/etc/services` on Server-Capable Administration Nodes

The `/etc/services` file on each CXFS administration contains entries for `sgi-cad` and `sgi-crsd`. The port numbers assigned for these processes must be the same in all nodes in the pool.

The following shows an example of `/etc/services` entries for `sgi-cad` and `sgi-crsd`:

```
sgi-crsd      7500/udp      # Cluster reset services daemon
sgi-cad       9000/tcp      # Cluster Admin daemon
```

### `cad.options` on Server-Capable Administration Nodes

The `cad.options` file on each server-capable administration node contains the list of parameters that the cluster administration daemon reads when the `cad` process (which provides cluster information) is started. The file is located as follows:

```
/etc/cluster/config/cad.options
```

You can set the following options in the `cad.options` file:

```
--append_log      Appends cad logging information to the cad log file
                   instead of overwriting it.
--log_file filename Specifies the cad log filename. Alternately, this can be
                   specified as -lf filename.
```

`-vvvv` Specifies the verbosity level. The number of `v` characters indicates the level of logging. Setting `-v` logs the fewest messages; setting `-vvvv` logs the highest number of messages.

The default file has the following options:

```
-lf /var/cluster/ha/log/cad_log --append_log
```

The following example shows an `/etc/config/cad.options` file that uses a medium-level of verbosity:

```
-vv -lf /var/cluster/ha/log/cad_nodename --append_log
```

The default log file is `/var/cluster/ha/log/cad_log`. Error and warning messages are appended to the log file if log file is already present.

The contents of the `/etc/config/cad.options` file cannot be modified using `cxfs_admin` or the GUI.

If you make a change to the `cad.options` file at any time other than initial configuration, you must restart the `cad` processes in order for these changes to take effect. You can do this by rebooting the nodes or by entering the following command:

```
server-admin# service cxfs_cluster restart
```

If you execute this command on a running cluster, it will remain up and running. However, the GUI will lose connection with the `cad` daemon; the GUI will prompt you to reconnect.

## **fs2d.options on Server-Capable Administration Nodes**

The `fs2d.options` file on each server-capable administration node contains the list of parameters that the `fs2d` daemon reads when the process is started. (The `fs2d` daemon manages the distribution of the cluster database (CDB) across the server-capable administration nodes in the pool.) The file is located as follows:

```
/etc/cluster/config/fs2d.options
```

Table 8-1 shows the options can that can be set in the `fs2d.options` file.

**Table 8-1** fs2d.options File Options

Option	Description
-logdest <i>log destination</i>	Sets the log destination: all, stdout, stderr, syslog, logfile. If multiple destinations are specified, the log messages are written to all of them. If logfile is specified, it has no effect unless the -logfile option is also specified. The default is logfile.
-logevents <i>event name</i>	Logs selected events: all, internal, args, attach, chandle, node, tree, lock, datacon, trap, notify, access, storage. The default is all.
-logfile <i>filename</i>	Sets the log filename. The default is /var/cluster/ha/log/fs2d_log.
-logfilemax <i>maximum size</i>	Sets the log file maximum size (in bytes). If the file exceeds the maximum size, any preexisting filename.old will be deleted, the current file will be renamed to filename.old, and a new file will be created. A single message will not be split across files. If -logfile is set, the default is 10000000.
-loglevel <i>loglevel</i>	Set log level. The following log levels may be used: always, critical, error, warning, info, moreinfo, freq, morefreq, trace, busy. The default is info.
-trace <i>trace_class</i>	Trace selected events. The following trace classes may be used: all, rpcs, updates, transactions, monitor. If you specify this option, you must also specify -tracefile and/or -tracelog. No tracing is done, even if it is requested for one or more classes of events, unless either or both of -tracefile or -tracelog is specified. The default is transactions.
-tracefile <i>filename</i>	Set trace filename. There is no default.
-tracefilemax <i>maximum_size</i>	Sets the trace file maximum size (in bytes). If the file exceeds the maximum size, any preexisting filename.old will be deleted, the current file will be renamed to filename.old, and a new file will be created.
-[no]tracelog	[Does not] trace to the log destination. When this option is set, tracing messages are directed to the log destination or destinations. If there is also a trace file, the tracing messages are written there as well. The default is -tracelog.

Option	Description
-[no]parent_timer	[Does not] exit when the parent exits. The default is -noparent_timer.
-[no]daemonize	[Does not] run as a daemon. The default is -daemonize.
-l	Does not run as a daemon.
-h	Prints usage message.
-o help	Prints usage message.

If you use the default values for these options, the system will be configured so that all log messages of level `info` or less, and all trace messages for transaction events, are sent to the `/var/cluster/ha/log/fs2d_log` file. When the file size reaches 10 MB, this file will be moved to its namesake with the `.old` extension and logging will roll over to a new file of the same name. A single message will not be split across files.

If you make a change to the `fs2d.options` file at any time other than the initial configuration time, you must restart the `fs2d` processes in order for those changes to take effect. You can do this by rebooting the server-capable administration nodes or by entering the following command:

```
server-admin# service cxfs_cluster restart
```

If you execute this command on a running cluster, it should remain up and running. However, the GUI will lose connection with the `cad` daemon; the GUI will prompt you to reconnect.

### fs2d.options Example 1

The following example shows an `/etc/config/fs2d.options` file that directs logging and tracing information as follows:

- All log events are sent to: `/var/log/messages`
- Tracing information for RPCs, updates, and transactions are sent to `/var/cluster/ha/log/fs2d_ops1`.

When the size of this file exceeds 100,000,000 bytes, this file is renamed to `/var/cluster/ha/log/fs2d_ops1.old` and a new file `/var/cluster/ha/log/fs2d_ops1` is created. A single message is not split across files.

(Line breaks added for readability.)

```
-logevents all -loglevel trace -logdest syslog -trace rpcs
-trace updates -trace transactions -tracefile /var/cluster/ha/log/fs2d_ops1
-tracefilemax 100000000
```

**fs2d.options Example 2**

The following example shows an `/etc/config/fs2d.options` file that directs all log and trace messages into one file, `/var/cluster/ha/log/fs2d_chaos6`, for which a maximum size of 100,000,000 bytes is specified. `-tracelog` directs the tracing to the log file.

(Line breaks added for readability.)

```
-logevents all -loglevel trace -trace rpcs -trace updates
-trace transactions -tracelog -logfile /var/cluster/ha/log/fs2d_chaos6
-logfilemax 100000000 -logdest logfile.
```

**clconfd.options on Server-Capable Administration Nodes**

You can use the `clconfd.options` file on each server-capable administration node to contain a list of nondefault parameters that the `clconfd` daemon will read when the process is started. To use this feature, create the following file:

```
/etc/cluster/config/clconfd.options
```

Table 8-2 shows the options that can be set in the `fs2d.options` file.

**Table 8-2** `clconfd.options` File Options

Option	Description
-c <i>CDBfile</i>	Reads the cluster database configuration from the specified <i>CDBfile</i> file. The default file is <code>/var/cluster/cdb/cdb.db</code> .
-d <i>debugfile</i>	Enables printing debug information to the specified file <i>debugfile</i> . The default is to print no information.
-h	Prints a help message for <code>clconfd.options</code> .

Option	Description
-l	Runs <code>clconfd</code> in the foreground. (For SGI development debugging purposes only. Do not use this option unless directed to do so by SGI support.) The default is to run <code>clconfd</code> in the background.
-s <i>loglevel</i>	Specifies the log level to use for logging to standard error. The default is 0 (no logging). For information about log levels, see "Configure Log Groups with the GUI" on page 200.
-R	Disables real-time scheduling. By default, real-time scheduling is enabled.

For example, to print `hafence` debug information to the file `/tmp/hafence.log`, add the following line to the `clconfd.options` file:

```
-d /tmp/hafence.log
```

If you make a change to the `clconfd.options` file at any time other than the initial configuration time, you must restart the `clconfd` processes in order for those changes to take effect. You can do this by rebooting the server-capable administration nodes or by entering the following command:

```
server-admin# service cxfs restart
```

## Enabling GRIOv2 (*Optional*)

This section discusses enabling and disabling GRIOv2 the following for server-capable administration nodes:

- "Enabling GRIOv2 After Reboot" on page 136
- "Enabling GRIOv2 for the Current Session" on page 136
- "Disabling GRIOv2 After Reboot" on page 136
- "Disabling GRIOv2 for the Current Session" on page 137

---

**Note:** GRIOv2 requires a license key on the server-capable administration nodes.

---

### Enabling GRIOv2 After Reboot

To enable GRIOv2 on a server-capable administration node, do the following:

1. Turn the `grio2` flag on with the `chkconfig(8)` command:  

```
server# chkconfig grio2 on
```
2. Reboot the system.

### Enabling GRIOv2 for the Current Session

To enable GRIOv2 for the current session, enter the following:

```
server# services grio2 start
```

### Disabling GRIOv2 After Reboot

To prevent GRIOv2 from being enabled after reboot on server-capable administration node, do the following:

1. Turn the `grio2` flag on with the `chkconfig(8)` command:  

```
server# chkconfig grio2 on
```
2. Reboot the system.



## Disabling GRIOv2 for the Current Session

To disable GRIOv2 for the current session, enter the following:

```
server# services grio2 stop
```



## Initial Setup of the Cluster



**Caution:** CXFS is a complex product. To ensure that it is installed and configured in an optimal manner, you **must** purchase managed services from SGI. You should read through the following chapters before attempting to install and configure a CXFS cluster:

- Chapter 1, "Introduction to CXFS" on page 1
- Chapter 2, "Best Practices" on page 47
- Chapter 3, "SGI RAID for CXFS Clusters" on page 89
- Chapter 4, "Switches" on page 95
- Chapter 5, "CXFS Licensing" on page 103
- Chapter 6, "Preinstallation Steps" on page 117
- Chapter 7, "Server-Capable Administration Node Installation" on page 123
- Chapter 8, "Postinstallation Steps" on page 129
- Chapter 9, "Initial Setup of the Cluster" on page 139

Also see the *CXFS 6 Client-Only Guide for SGI InfiniteStorage*.

---

This chapter provides recommendations and a summary of the basic steps required to initially configure a cluster. It contains the following:

- "Preliminary Cluster Configuration Steps" on page 140
- "Initial Setup" on page 142
- "Configuring a Large Cluster" on page 152
- "Testing the System" on page 153

You should also refer to the information in "Configuration Best Practices" on page 47 and you may wish to use the worksheet provided in Appendix I, "Initial Configuration Checklist" on page 507.

This chapter points to detailed descriptions in the task reference chapters and in the *XVM Volume Manager Administrator's Guide*.

For information about licenses, see Chapter 5, "CXFS Licensing" on page 103.

## Preliminary Cluster Configuration Steps

Complete the following steps to ensure that you are ready to configure the initial cluster:

- "Verify the License" on page 140
- "Verify that the `chkconfig` Arguments are On" on page 140
- "Verify that the Cluster Daemons are Running" on page 141
- "Gather the Required Information" on page 142
- "Configure for `nsd` Use (*Optional*)" on page 142

During the course of configuration, you will see various information-only messages in the log files. See "Normal Messages" on page 413.

### Verify the License

Verify that you have the appropriate CXFS licenses by using the `cxfslicense -d` command on server-capable administration nodes after installing the CXFS software. See "Verifying the License Keys with `cxfslicense` After Installing CXFS" on page 113.

### Verify that the `chkconfig` Arguments are On

Ensure that the appropriate `chkconfig` arguments are on. For more information, see "chkconfig Arguments" on page 296.

Use `chkconfig --list` to verify that `cxfs_cluster` and `cxfs` are set to on for the site's normal run levels. For example, if the normal run levels are 3 and 5:

```
server-admin# /sbin/chkconfig --list | grep cxfs
cxfs_cluster 0:off 1:off 2:off 3:on 4:off 5:on 6:off
cxfs         0:off 1:off 2:off 3:on 4:off 5:on 6:off
```

---

**Note:** Your site's normal run levels may differ.

---

If the normal run levels are set to `off`, set them to `on` and reboot. For example:

```
server-admin# /sbin/chkconfig cxfs_cluster on
server-admin# /sbin/chkconfig cxfs on
server-admin# /sbin/chkconfig grio2 on (if running GRIOV2)
server-admin# reboot
```

## Verify that the Cluster Daemons are Running

When you **first install** the software, the following daemons should be running on all server-capable administration nodes:

```
cad
cmond
crsd
fs2d
clconfd
```

To determine which daemons are running on a server-capable administration node, enter the following:

```
server-admin# service cxfs_cluster status
fs2d is running.
cmond is running.
cad is running.
crsd is running.
server-admin# service cxfs status
clconfd is running.
```

If you have previously enabled GRIOV2, the `gpd2` daemon should also be running on a server-capable administration node.

If you do not see these processes on a server-capable administration node, see "Verify that the `chkconfig` Arguments are On" on page 140.

For more information, see:

- "Stopping and Restarting Cluster Administration Daemons" on page 447
- "Kernel Threads" on page 453

## Gather the Required Information

You should know the fully qualified hostname of the machine from which you will do CXFS administration, which should be the first node you define in the cluster database. If you use `cxfs_admin` (see "Initial Setup" on page 142), you should use the hostname when defining the first node. (This information is automatically supplied for you in the CXFS GUI.)

You should also know the IP addresses and hostnames of the other machines that will form the cluster and the name by which you want to refer to the cluster.

## Configure for `nsd` Use (*Optional*)

If your system uses `nsd` for hostname resolution, you must configure your system so that local files are accessed before the network information service (NIS) or the domain name service (DNS).

## Initial Setup

You can create the cluster and its components using either of the following tools, which provide similar functionality:

- "Initial Setup with the CXFS GUI" on page 143
- "Initial Setup with the `cxfs_admin` Command" on page 148



**Caution:** You should only use one configuration tool at a time to make changes.

---

The following procedures provide an overview of the basic steps to set up a cluster. You will first define a server-capable administration node from which you perform administrative tasks, and then the other components of the cluster.

## Initial Setup with the CXFS GUI

---

**Note:** For complete details about using the GUI, see "CXFS Tools" on page 38 and Chapter 10, "CXFS GUI" on page 157.

---

To initially configure the cluster with GUI, do the following:

- "Start the GUI" on page 143
- "Set Up a New Cluster with the GUI" on page 145
- "Set Up a New CXFS Filesystem with the GUI" on page 147

The server-capable administration node to which you connect the GUI affects your view of the cluster. You should wait for a change to appear in the view area before making another change; the change is not guaranteed to be propagated across the cluster until it appears in the view area. You should only make changes from one instance of the GUI at any given time; changes made by a second GUI instance may overwrite changes made by the first instance.

### Start the GUI

Start the CXFS Manager by entering the following:

```
server-admin# /usr/sbin/cxfsmgr
```

You can also start the GUI from your web browser. For more information, see "Starting the GUI" on page 158.

Supply the name of the server-capable administration node you wish to connect to and the `root` password.

Figure 9-1 shows an example of the GUI.

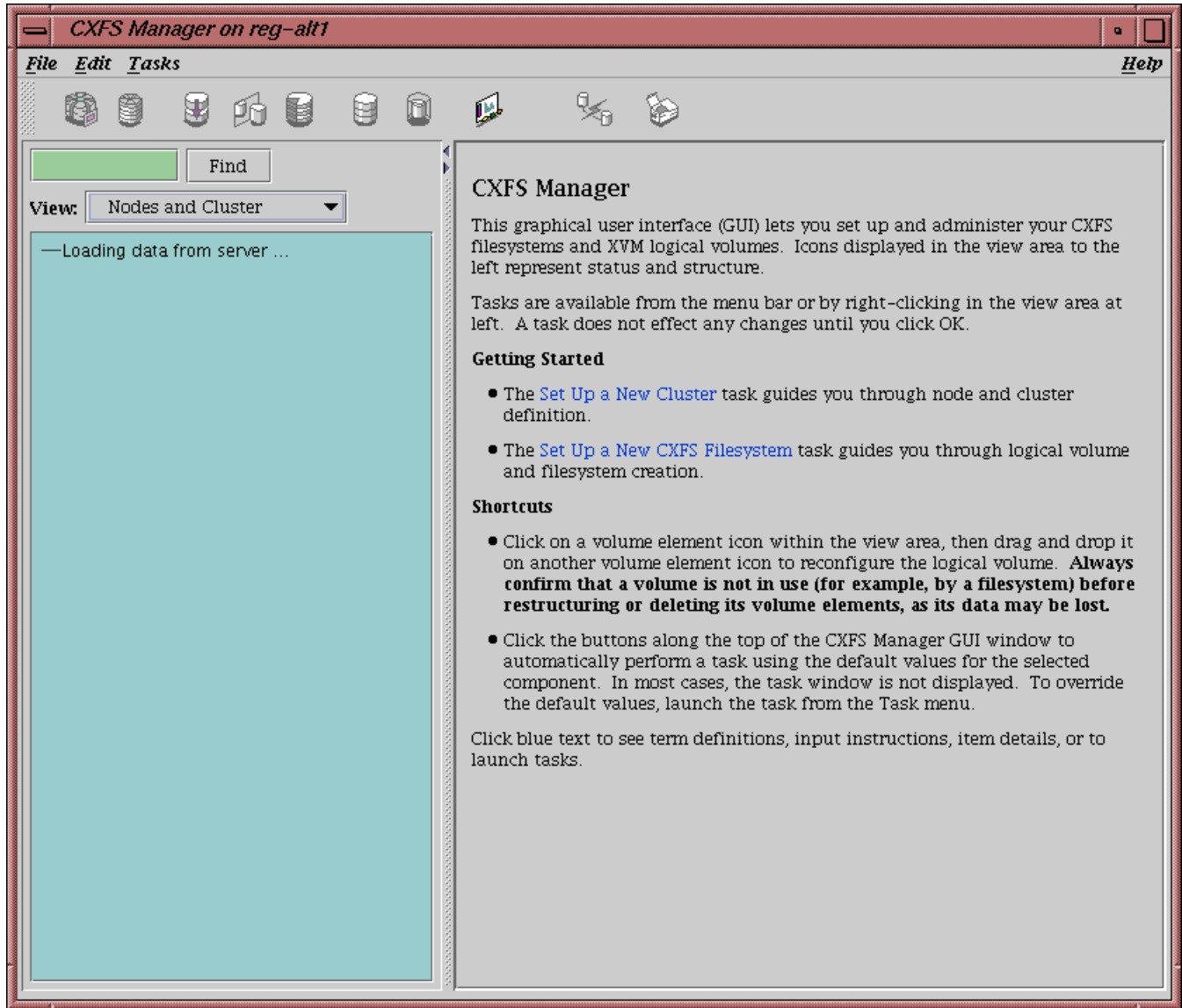


Figure 9-1 CXFS Manager



## Set Up a New Cluster with the GUI

Within the CXFS tasks, you can click any **blue** text to get more information about that concept or input field. In every task, the cluster configuration will not update until you click on **OK**.

---

**Note:** To specify reset method that uses Intelligent Platform Management Interface (IPMI) and baseboard management controller (BMC), you must use the `cxfs_admin` configuration tool. See "Create or Modify a Node with `cxfs_admin`" on page 242.

---

The **Set Up a New Cluster** task in the **Guided Configuration** menu leads you through the steps required to create a new cluster. It encompasses tasks that are detailed elsewhere.

Do the following:

1. Click **Define a Node** to define the server-capable administration node to which you are connected. See "Define a Node with the GUI" on page 179.

---

**Note:** If you attempt to define a cluster or other object before the local node has been defined, you will get an error message that says:

```
No nodes are registered on servername. You cannot define a cluster until you define the node to which the GUI is connected. To do so, click "Continue" to launch the "Set Up a New Cluster" task.
```

---

2. *(Optional)* **After** the first node icon appears in the view area on the left, click step 2, **Define a Node**, to define the other nodes in the cluster. To use private network failover, you must use the `cxfs_admin` command's `create failover_net` command to specify the network and mask; see "Network Failover Tasks with `cxfs_admin`" on page 271. See "Define a Node with the GUI" on page 179.

---

**Note:** Do not define another node until this node appears in the view area. If you add nodes too quickly (before the database can include the node), errors will occur.

---

Repeat this step for each node. For large clusters, define only the server-capable administration nodes first; see "Configuring a Large Cluster" on page 152.

3. Click **Define a Cluster** to create the cluster definition. See "Define a Cluster with the GUI" on page 194. Verify that the cluster appears in the view area. Choose **View: Nodes and Cluster**.
4. After the cluster icon appears in the view area:
  - a. Click **Add/Remove Nodes in Cluster** to add the server-capable administration nodes to the new cluster. Select the server-capable administration node names and click **Add** to add them to the list and click **OK** to complete the task. See "Add or Remove Nodes in the Cluster with the GUI" on page 188.

---

**Note:** SGI recommends that you form an initial cluster that consists of all of the server-capable administration nodes, to ensure that these nodes will have lower cell ID numbers than any client-only nodes. See "Create an Initial Cluster of All Server-Capable Administration Nodes" on page 54.

---

- b. Click **Add/Remove Nodes in Cluster** to add the client-only nodes to the new cluster. Select the client-only node names and click **Add** to add them to the list and click **OK** to complete the task. See "Add or Remove Nodes in the Cluster with the GUI" on page 188.

---

**Note:** For large clusters, SGI recommends that you build up the remainder of the cluster in small groups of client-only nodes. This makes it easier to locate and fix problems, should any occur. See "Configuring a Large Cluster" on page 152.

---

5. (*Optional*) Click on **Test Connectivity** to verify that the nodes are physically connected. See "Test Node Connectivity with the GUI" on page 193. (This test requires the proper configuration; see "Modifications for CXFS Connectivity Diagnostics" on page 126.)
6. If you are using I/O fencing, define the switch in the cluster; see the release notes for supported switches. I/O fencing is required for nodes without system controllers; see "Hardware and Software Requirements for Server-Capable Administration Nodes" on page 35.
7. Click **Start CXFS Services**. See "Start CXFS Services with the GUI" on page 197.
8. Click **Close**. Clicking on **Close** exits the task; it does not undo the task.

## Set Up a New CXFS Filesystem with the GUI

---

**Note:** Within the CXFS tasks, you can click any blue text to get more information about that concept or input field. In every task, the cluster configuration will not update until you click **OK**.

---

The **Set Up a New CXFS Filesystem** task leads you through the steps required to create a new filesystem and mount it on all nodes in your cluster. It encompasses tasks that are detailed elsewhere.

Do the following:

1. Click **Start CXFS Services** if the services have not been started already. (The current status is displayed beneath the task link.) See "Start CXFS Services with the GUI" on page 197.
2. Click **Label Disks**.

---

**Note:** The disk must be initialized before being labeled. If your disk has not been initialized during factory set-up, use the Linux `parted` command to initialize the disk. For more information, see the *XVM Volume Manager Administrator's Guide*.

---

3. Create slices, which define the physical storage, on the labeled disk. Click **Slice Disks**.
4. Create the type of filesystem you want: stripe, mirror, or concat.
5. Click **Make the Filesystem**. If you do not want to use the default options, click **Specify Sizes** and go to the next page. For more information, see the `mkfs(8)` man page and the *XVM Volume Manager Administrator's Guide*.
6. Click **Define a CXFS Filesystem**. This task lets you define a new filesystem, set the ordered list of potential metadata servers, and set the list of client nodes for the filesystem. See "Define CXFS Filesystems with the GUI" on page 210.
7. Click **Mount a CXFS Filesystem**. This task lets you mount the filesystem on all nodes in the cluster. See "Mount CXFS Filesystems with the GUI" on page 214.

Repeat these steps for each filesystem.

## Initial Setup with the `cxfs_admin` Command

---

**Note:** For the initial installation, SGI highly recommends that you use the GUI guided configuration tasks. See "Initial Setup with the CXFS GUI" on page 143. For complete details about using `cxfs_admin`, see "CXFS Tools" on page 38 and Chapter 11, "cxfs\_admin Command" on page 223.

---

You can perform configuration with `cxfs_admin` using normal mode (in which you specify each command and attribute) or in prompting mode, in which `cxfs_admin` asks you for the information it requires.

To initially configure the cluster with `cxfs_admin`, do the following (line breaks shown here for readability). A simple example of prompting mode follows the steps.

1. "Preliminary Cluster Configuration Steps" on page 140.
2. Initialize the cluster database and start `cxfs_admin`:

```
server-admin# /usr/cluster/bin/cxfs_admin -s
```

3. Define the cluster name, where *clustername* is the logical name of the cluster:

```
cxfs_admin> create cluster name=clustername
```

For example:

```
cxfs_admin> create cluster name=mycluster
```

4. Create the first server-capable administration node (normally the node on which you are currently running `cxfs_admin`). (You do not need to specify the node type because it must be `server_admin`.) If you use prompting mode, the name of the local node is used as a default for `name`.



**Caution:** It is critical that you enter the primary hostname for the first node defined in the pool.

---

```
cxfs_admin> create node name=server_capable_hostname private_net=private_IPaddress
```

For example:

```
cxfs_admin> create node name=server1 private_net=10.11.20.114
```

5. Exit `cxfs_admin` and restart the CXFS cluster services:

```
server-admin# service grio2 stop (if running GRIOv2)
server-admin# service cxfs stop
server-admin# service cxfs_cluster stop
server-admin# service cxfs_cluster start
server-admin# service cxfs start
server-admin# service grio2 start (if running GRIOv2)
```

6. Restart `cxfs_admin`:

```
server-admin# /usr/cluster/bin/cxfs_admin
```

---

**Note:** If you have multiple clusters connected to the same public network, use the `-i` option to identify the cluster name:

```
server-admin# /usr/cluster/bin/cxfs_admin -i mycluster
```

---

7. (Optional) Create the failover networks:

```
cxfs_admin:cluster> create failover_net network=IPaddress1 mask=netmask
cxfs_admin:cluster> create failover_net network=IPaddress2 mask=netmask
```

For example:

```
cxfs_admin:mycluster> create failover_net network=192.168.0.0 mask=255.255.255.0
cxfs_admin:mycluster > create failover_net network=10.0.0.0 mask=255.255.255.0
```

8. Create the switches:

```
cxfs_admin:cluster> create switch name=switch_hostname [vendor=brocade/qlogic]
[user=username password=password]
```

For example:

```
cxfs_admin:mycluster> create switch name=myswitch vendor=qlogic
```

9. Create another server-capable administration node:

```
cxfs_admin:mycluster> create node name=nodename os=OSType private_net=IPaddress
type=server_admin
```

For example:

```
cxfs_admin:mycluster> create node name=server2 os=Linux private_net=10.11.20.115 \  
type=server_admin
```

Repeat this step for each server-capable administration node.

---

**Note:** SGI recommends that you form an initial cluster that consists of all of the server-capable administration nodes to ensure that these nodes will have lower cell ID numbers than any client-only nodes and thereby avoid potential problems. See "Create an Initial Cluster of All Server-Capable Administration Nodes" on page 54.

---

10. Create the client-only nodes:

```
cxfs_admin:mycluster> create node name=nodename [os=OSType] private_net=IPaddress  
[type=client_only]
```

For example:

```
cxfs_admin:mycluster> create node name=client1 os=Windows private_net=10.11.20.116 \  
\
```

11. (Optional) Define one of the client-only nodes as the CXFS tiebreaker if using multiple server-capable administration nodes:

```
cxfs_admin:cluster> modify clustername tiebreaker=client_only_nodename
```

For example:

```
cxfs_admin:mycluster> modify mycluster tiebreaker=client1
```

12. Obtain a shell window for one of the server-capable administration nodes in the cluster and use the Linux `parted` command to create a volume header on the disk drive. For information, see the `parted(8)` man page and *Linux Configuration and Operations Guide*.
13. Create the XVM logical volumes. In the shell window, use the `xvm` command line interface. For information, see the *XVM Volume Manager Administrator's Guide*.
14. Make the XFS filesystems. In the shell window, use the `mkfs` command. For information, see the *XVM Volume Manager Administrator's Guide*.

### 15. Create the CXFS filesystems:

```
cxfs_admin:cluster> create filesystem name=XVMvolume [mountpoint=path] [options=mount_options]
```

For example:

```
cxfs_admin:cluster> create filesystem name=cxfsvoll1
```

### 16. (Optional) Create private network failover:

```
cxfs_admin:cluster> network=IPaddress mask=NetMask
```

For example, to create two private networks, one on the 192.168.0.x and the other on the 10.0.0.x subnets:

```
cxfs_admin:mycluster> create failover_net network=192.168.0.0 mask=255.255.255.0
```

```
cxfs_admin:mycluster > create failover_net network=10.0.0.0 mask=255.255.255.0
```

### 17. View the cluster status:

```
cxfs_admin:cluster> status
```

Following is a simple example using prompting mode:

```
cxfsopus14:~ # /usr/cluster/bin/cxfs_admin -s
Event at [ Oct 26 11:38:00 ]
Connecting to the local CXFS server...
cxfs_admin:(no cluster defined)> create cluster
Specify the attributes for create cluster:
  name? mycluster
Event at [ Oct 26 11:38:04 ]
cxfs_admin:mycluster> create node
Specify the attributes for create node:
  name? cxfsopus14
  type? server_admin
  private_net? 10.11.20.114
Event at [ Oct 26 11:38:08 ]
Node "cxfsopus14" has been created, waiting for it to join the cluster...
Please restart all cxfs and cluster services on the server "cxfsopus14" to make
it join the cluster.
Event at [ Oct 26 11:38:10 ]
cxfs_admin:mycluster> create filesystem
Specify the attributes for create filesystem:
  name? thump
  options?
```

```
forced_unmount? false
mountpoint? /mnt/thump
mounted? true
grio_managed? false
Event at [ Oct 26 11:39:04 ]
Filesystem "thump" has been created, waiting for it to be mounted on all
assigned nodes...
```

For more information, see Chapter 11, "cxfs\_admin Command" on page 223 and the help command within cxfs\_admin.

## Configuring a Large Cluster

When configuring a large cluster, you should ensure that a small cluster containing just the server-capable administration nodes is fully functional before adding any client-only nodes. By building up a large cluster with small groups of client-only nodes (step 3), you will minimize concurrent operational issues and use the database most efficiently.

Following is an overview of the procedure:

1. Create the initial cluster with just the server-capable administration nodes and test it:
  - a. Define the cluster name.
  - b. Define the initial server-capable administration node.
  - c. *(Optional)* Create the failover networks.
  - d. Create the switches.
  - e. Define all of the other the server-capable administration nodes.
  - f. If using the GUI, add all of the server-capable administration nodes to the cluster. (In cxfs\_admin, nodes that are created are automatically added to the cluster.)
  - g. Verify that the nodes are all part of the cluster membership.
2. Add the client-only nodes to the database:
  - a. Define **all** client-only nodes.



- b. Add **all** client-only nodes to the cluster. (In `cxfs_admin`, nodes that are created are automatically added to the cluster.)
3. Gradually build up the functional cluster with subsets of client-only nodes:
  - a. Start CXFS services on a **subset** of four client-only nodes.
  - b. Ensure that the nodes are part of the cluster membership.
4. Repeat step 3 as needed to complete the cluster membership.
5. Create the CXFS filesystems.
6. *(Optional)* Manually mount the CXFS filesystems.
7. Verify that the nodes are all part of the cluster membership and that all of the filesystems are mounted and fully functional.

Following is an example `cxfs_admin` script to configure a cluster. The first `node` line creates the first server-capable administration node; you can copy and repeat the second `node` line for each remaining server-capable or client-only node in the cluster:

---

**Note:** When using a script, SGI strongly recommends using `mounted=false` and then mounting the filesystems manually.

---

```
create cluster name=clustername
create node name=nodename private_net=IPaddress [type=server_admin]
create failover_net network=IPaddress1 mask=netmask
create switch name=switch_hostname [vendor=brocade/qlogic] [user=username password=password] [copy and repeat]
create node name=nodename type=server_admin private_net=IPaddress [copy and repeat]
create node name=nodename [os=OS] private_net=IPaddress [type=client_only] [copy and repeat]
create filesystem name=filesystemname forced_unmount=false mountpoint=/mnt/nodename mounted=false [copy and repeat]
```

## Testing the System

This section discusses the following:

- "Private Network Interface" on page 154
- "System Reset Connection for Server-Capable Administration Nodes" on page 154
- "Testing Serial Connectivity for the L2 on Altix 350 Systems" on page 155

## Private Network Interface

For each private network on each node in the pool, enter the following, where *nodeIPaddress* is the IP address of the node:

```
# ping -c 3 nodeIPaddress
```

Typical ping output should appear, such as the following:

```
PING IPaddress (190.x.x.x: 56 data bytes
64 bytes from 190.x.x.x: icmp_seq=0 ttl=254 time=3 ms
64 bytes from 190.x.x.x: icmp_seq=1 ttl=254 time=2 ms
64 bytes from 190.x.x.x: icmp_seq=2 ttl=254 time=2 ms
```

If ping fails, follow these steps:

1. Verify that the network interface was configured up by using `ifconfig`. For example:

```
# ifconfig ec3
ec3: flags=c63<UP,BROADCAST,NOTRAILERS,RUNNING,FILTMULTI,MULTICAST>
inet 190.x.x.x netmask 0xffffffff broadcast 190.x.x.x
```

The UP in the first line of output indicates that the interface was configured up.

2. Verify that the cables are correctly seated.

Repeat this procedure on each node.

## System Reset Connection for Server-Capable Administration Nodes

To test the system reset connections, do the following:

1. Ensure that the nodes are powered on.
2. Start the `cxfs_admin` command as `root` in write mode (`-A`) on one of the server-capable administration nodes :

```
server-admin# /usr/cluster/bin/cxfs_admin -A
```

3. Test the connections by entering of the following for each node:

```
cxfs_admin:clustername> control target-nodename operation=ping
```

4. If a command fails, make sure all the cables are seated properly and rerun the command.

## Testing Serial Connectivity for the L2 on Altix 350 Systems

You can use the `cu(1)` command to test the serial reset lines if you have installed the `uucp` RPM.

The `cu` command requires that the device files be readable and writable by the user `uucp`. The command also requires the `/var/lock` directory be writable by group `uucp`.

Perform the following steps:

1. Change ownership of the serial devices so that they are in group `uucp` and owned by user `uucp`.

---

**Note:** The ownership change may not be persistent across reboots.

---

For example, suppose you have the following TTY devices on the IO10:

```
server-admin# ls -l /dev/ttyIOC*
crw-rw---- 1 root uucp 204, 50 Sep 15 16:20 /dev/ttyIOC0
crw-rw---- 1 root uucp 204, 51 Sep 15 16:20 /dev/ttyIOC1
crw-rw---- 1 root uucp 204, 52 Sep 15 16:20 /dev/ttyIOC2
crw-rw---- 1 root uucp 204, 53 Sep 15 16:20 /dev/ttyIOC3
```

To change ownership of them to `uucp`, you would enter the following:

```
server-admin# chown uucp.uucp /dev/ttyIOC*
```

2. Determine if group `uucp` can write to the `/var/lock` directory and change permissions if necessary.

For example, the following shows that group `uucp` cannot write to the directory:

```
server-admin# ls -ld /var/lock
drwxr-xr-t 5 root uucp 88 Sep 19 08:21 /var/lock
```

The following adds write permission for group `uucp`:

```
server-admin# chmod g+w /var/lock
```

3. Join the `uucp` group temporarily, if necessary, and use `cu` to test the line.

For example:

```
server-admin# newgrp uucp
server-admin# cu -l /dev/ttyIOC0 -s 38400
```

For more information, see the `cu(1)` man page and the documentation that comes with the `uucp` RPM.

## CXFS GUI

This chapter discusses the CXFS Manager graphical user interface (GUI). It contains detailed information about CXFS tasks and an overview of XVM tasks. (For details about XVM tasks, see the *XVM Volume Manager Administrator's Guide*.)

This chapter contains the following sections:

- "GUI Overview" on page 157
- "Guided Configuration Tasks" on page 177
- "Node Tasks with the GUI" on page 179
- "Cluster Tasks with the GUI" on page 194
- "Cluster Services Tasks with the GUI" on page 196
- "Switches and I/O Fencing Tasks with the GUI" on page 202
- "Filesystem Tasks with the GUI" on page 207
- "Privileges Tasks with the GUI" on page 218

---

**Note:** CXFS requires a license key to be installed on each server-capable administration node. If you install the software without properly installing the license key, you will get an errors when trying to use the CXFS Manager GUI. For more information about licensing, see Chapter 5, "CXFS Licensing" on page 103.

---

### GUI Overview

The GUI lets you set up and administer CXFS filesystems and XVM logical volumes. It also provides icons representing status and structure.

This section provides an overview of the GUI:

- "Starting the GUI"
- "Running the Web-based Version" on page 159
- "Summary of GUI Platforms" on page 161

- "Logging In" on page 161
- "Making Changes Safely" on page 162
- "GUI Windows" on page 162
- "GUI Features" on page 164
- "Key to Icons and States" on page 174

## Starting the GUI

To start the GUI on a server-capable administration node where the CXFS GUI-client software (`sgi-sysadm_cxfs-client`) is installed, do the following:

1. Obtain and install the J2SE 1.4.2 (latest patch) software available from:

`http://java.sun.com`

2. Enter the following command line:

```
linux# /usr/sbin/cxfsmgr
```

3. Ensure that that the following line is not commented out in the file `/etc/ld.so.conf`:

- x86-64 systems:

```
/usr/lib64/sysadm/lib
```

- ia64 systems:

```
/usr/lib/sysadm/lib
```

4. Enter the following command line:

```
linux# /usr/sbin/cxfsmgr
```

---

**Note:** When running the CXFS GUI (`cxfsmgr`), an error occurs if the line `/usr/lib64/sysadm/lib` (for x86-64 systems) or `/usr/lib/sysadm/lib` (for ia64 systems) is commented out in the `/etc/ld.so.conf` file. For example, an x86-64 system would display the following error:

```
Error connecting to server: /usr/lib64/sysadm/bin/sysadmd: error
while loading shared libraries: libsysadmUtil.so.0: cannot open
shared object file: No such file or directory.
```

To resolve the problem, do the following:

1. Uncomment the `/usr/lib64/sysadm/lib` or `/usr/lib/sysadm/lib` line in the `/etc/ld.so.conf` file.
  2. Run `ldconfig`.
- 

## Running the Web-based Version

If you want to use a web-based version of the GUI on Linux, do the following:

1. Ensure that the following software products are installed on the server-capable administration nodes that you will connect to (by means of a Java-enabled web browser) for performing administrative operations:

```
sgi-sysadm_xvm-web
sgi-sysadm_cxfs-web
```

These software products are part of the software normally installed with CXFS.

2. Ensure that an apache Web server is installed and running on the server-capable administration node.
3. Create the file `/etc/apache2/conf.d/cxfs.conf` with the following contents for the CXFS GUI:

```
Alias "/CXFSManager" "/var/www/html/CXFSManager"

<Directory "/var/www/html/CXFSManager/">
    Options +ExecCGI +Includes +FollowSymLinks
    Order allow,deny
    Allow from all
    DirectoryIndex index.shtml
```

```
        AddType text/html .shtml
        AddOutputFilter INCLUDES .shtml
</Directory>
```

4. Create the file `/etc/apache2/conf.d/xvm.conf` with the following contents for the XVM GUI:

```
Alias "/XVMManager" "/var/www/html/XVMManager"

<Directory "/var/www/html/XVMManager">
    Options +ExecCGI +Includes +FollowSymlinks
    Order allow,deny
    Allow from all
    DirectoryIndex index.shtml
    AddType text/html .shtml
    AddOutputFilter INCLUDES .shtml
</Directory>
```

5. Enable apache2 on boot, if necessary:

```
linux# chkconfig apache2 on
```

6. Restart the apache2 server:

```
linux# /etc/init.d/apache2 restart
```

7. Close all browser windows and restart the browser.
8. Enter the URL `http://server/CXFSManager/` where *server* is the name of a server-capable administration node in the pool
9. At the resulting webpage, click the **CXFS Manager** icon.



## Summary of GUI Platforms

Table 10-1 describes the platforms where the GUI may be started, connected to, and displayed.

**Table 10-1** GUI Platforms

GUI Mode	Where You Start the GUI	Where You Connect the GUI	Where the GUI Displays
cxfsmgr	A server-capable administration node system with <code>sgi-sysadm_cxfs-client</code> installed	The server-capable administration node in the pool that you want to use for cluster administration	The system where the GUI was invoked
Web	Any system with a web browser and Java2 1.4.1 or 1.4.2 plug-in installed and enabled	The server-capable administration node in the pool that you want to use for cluster administration	The same system with the web browser

## Logging In

To ensure that the required GUI privileges are available for performing all of the tasks, you should log in to the GUI as `root`. However, some or all privileges can be granted to any other user using the GUI privilege tasks; see "Privileges Tasks with the GUI" on page 218.

A dialog box will prompt you to log in to a CXFS host. You can choose one of the following connection types:

- **Local** runs the server-side process on the local host instead of going over the network
- **Direct** creates a direct socket connection using the `tcpmux` TCP protocol (`tcpmux` must be enabled)
- **Remote Shell** connects to the server via a user-specified command shell, such as `rsh` or `ssh`. For example:

```
ssh -l root servername
```

---

**Note:** For secure connection, choose **Remote Shell** and type a secure connection command using a utility such as `ssh`. Otherwise, the GUI will not encrypt communication and transferred passwords will be visible to users of the network.

---

- **Proxy** connects to the server through a firewall via a proxy server

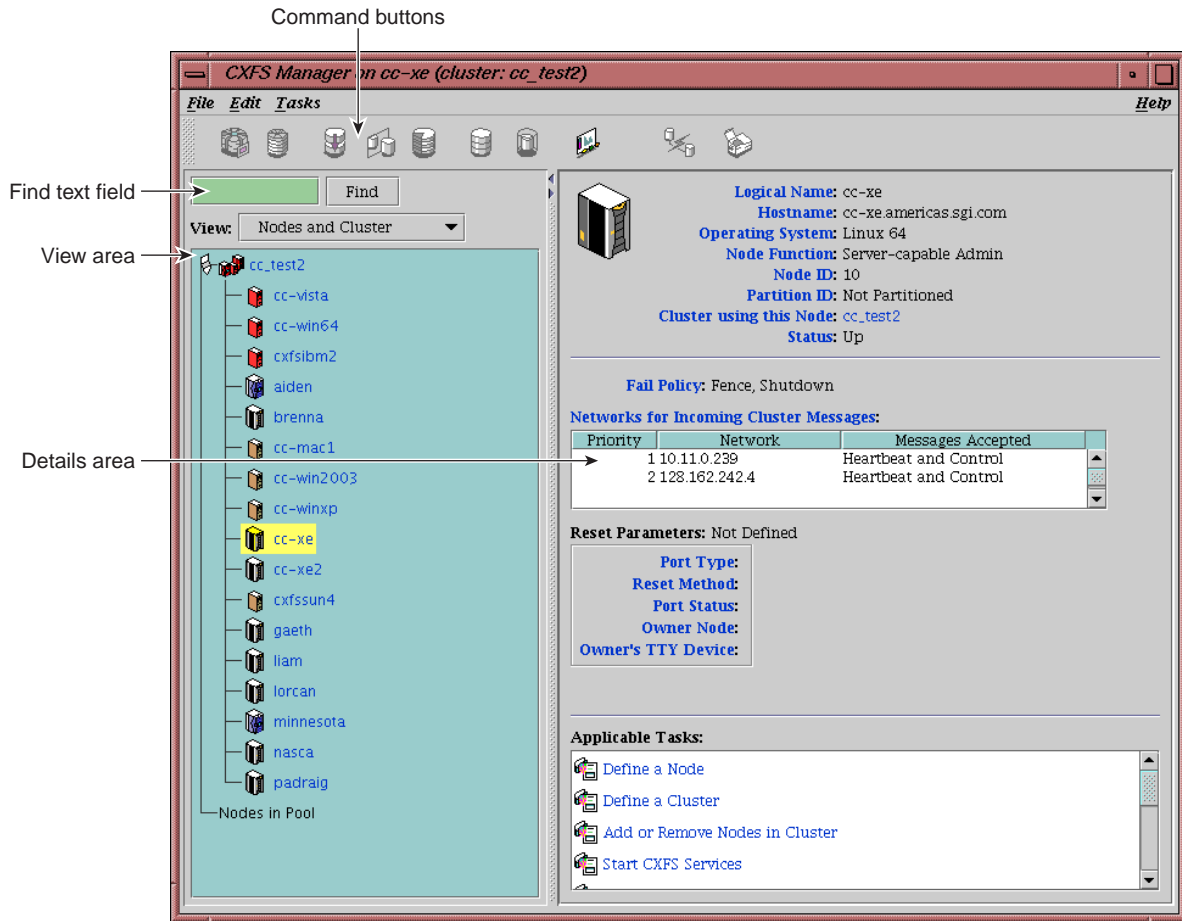
## Making Changes Safely

Do not make configuration changes on two different server-capable administration nodes in the pool simultaneously, or use the CXFS GUI, `cxfs_admin`, and `xvm` commands simultaneously to make changes. You should run one instance of the `cxfs_admin` command or the CXFS GUI on a single server-capable administration node in the pool when making changes at any given time. However, you can use any node in the pool when requesting status or configuration information. Multiple CXFS Manager windows accessed via the **File** menu are all part of the same application process; you can make changes from any of these windows.

The server-capable administration node to which you connect the GUI affects your view of the cluster. You should wait for a change to appear in the *view area* before making another change; the change is not guaranteed to be propagated across the cluster until it appears in the view area. (To see the location of the view area, see Figure 10-1 on page 163.) The entire cluster status information is sent to every server-capable administration node each time a change is made to the cluster database.

## GUI Windows

Figure 10-1 shows the **CXFS Manager** window displaying information for a specific component in the *details area*. For information about using the *view area* to monitor status and an explanation of the icons and colors, see "Cluster, Node, and CXFS Filesystem Status" on page 365.



**Figure 10-1** CXFS Manager GUI Showing Details for a Node

Figure 10-2 shows an example of the pop-up menu of applicable tasks that appears when you click the right mouse button on a selected item; in this example, clicking on the node name `cc-xe` displays a list of applicable tasks.

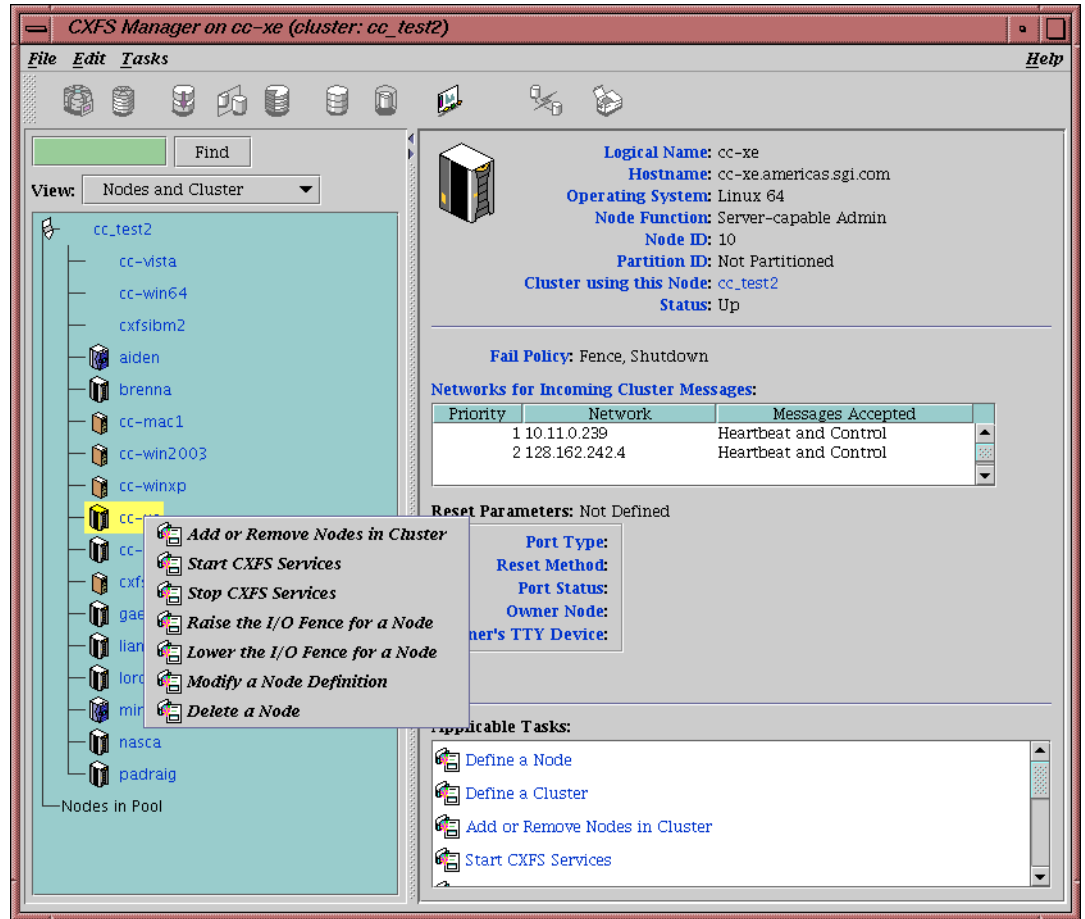


Figure 10-2 Pop-up Menu that Appears After Clicking the Right Mouse Button

## GUI Features

The **CXFS Manager** GUI allows you to administer the entire CXFS cluster from a single point. It provides access to the tools that help you set up and administer your CXFS cluster:

- *Tasks* let you set up and monitor individual components of a CXFS cluster, including XVM volumes. For details about XVM tasks, see *XVM Volume Manager Administrator's Guide*.

- *Guided configuration tasks* consist of a group of tasks collected together to accomplish a larger goal. For example, **Set Up a New Cluster** steps you through the process for creating a new cluster and allows you to launch the necessary individual tasks by clicking their titles.

This section discusses the following:

- "GUI Window Layout" on page 165
- "File Menu" on page 166
- "Edit Menu" on page 166
- "Tasks Menu" on page 166
- "Help Menu" on page 167
- "Shortcuts Using Command Buttons" on page 167
- "View Menu" on page 169
- "Performing Tasks" on page 170
- "Using Drag-and-Drop" on page 171
- "Structuring Volume Topologies" on page 171
- "Configuring Disks" on page 172
- "Displaying State" on page 172
- "Getting More Information" on page 173
- "Important GUI and `xvm` Command Differences" on page 173

## GUI Window Layout

By default, the window is divided into two sections: the *view area* and the *details area* (see Figure 10-1 on page 163). The details area shows generic overview text if no item is selected in the view area. You can use the arrows in the middle of the window to shift the display.

## File Menu

The **File** menu lets you display the following:

- Multiple windows for this instance of the GUI
- System log file: `/var/log/messages`
- System administration log file: `/var/lib/sysadm/salog`

The `salog` file shows the commands run directly by this instance of the GUI or some other instance of the GUI running commands on the system. (Changes should not be made simultaneously by multiple instances of the GUI or the GUI and `cxfs_admin`.)

The **File** menu also lets you close the current window and exit the GUI completely.

## Edit Menu

The **Edit** menu lets you expand and collapse the contents of the view area. You can choose to automatically expand the display to reflect new nodes added to the pool or cluster. You can also use this menu to select all items in the view menu or clear the current selections.

## Tasks Menu

The **Tasks** menu contains the following:

- **Guided Configuration**, which contains the tasks to set up your cluster, define filesystems, create volumes, check status, and modify an existing cluster
- **Nodes**, which contains tasks to define and manage the nodes
- **Cluster**, which contains tasks to define and manage the cluster
- **Cluster Services**, which allows you to start and stop CXFS services, set the CXFS tiebreaker node, set the log configuration, and revoke or allow CXFS kernel membership of the local node
- **Switches and I/O Fencing**, which contains tasks to configure switch definitions and manage I/O fencing
- **Disks**, which contains XVM disk administration tasks

- **Volume Elements**, which contains tasks to create, delete, modify, and administer XVM volume elements
- **Filesystems**, which contains tasks to define and manage filesystems and relocate a metadata server
- **Privileges**, which lets you grant or revoke access to a specific task for one or more users
- **Find Tasks**, which lets you use keywords to search for a specific task



### Help Menu

The **Help** menu provides an overview of the GUI and a key to the icons. You can also get help for certain items in blue text by clicking on them.








### Shortcuts Using Command Buttons

The command buttons along the top of the GUI window provide a method of performing tasks quickly. When you click a button, the corresponding task executes using default values, usually without displaying a task window. To override the defaults, launch the task from the **Tasks** menu. Table 10-2 summarizes the shortcuts available; for details about these tasks, see the *XVM Volume Manager Administrator's Guide*.

**Table 10-2** Command Buttons

Button	Task
	Labels selected unlabeled disks. If the selected disks include foreign and/or labeled disks, the <b>Label Disks</b> task will be run.
	Brings up the <b>Slice Disk</b> task with the selected disks as default inputs

---

Button	Task
	Creates a concat with a temporary name
	Creates a mirror with a temporary name
	Creates a stripe with a temporary name
	Creates a volume with a temporary name
	Creates a subvolume with a temporary name
	Detaches the selected volume elements from their current parents
	Deletes the selected non-slice volume elements or unlabels the selected disks directly, or brings up the appropriate delete task for the selected component

---



## View Menu

Choose what you want to view from the **View** menu:

- Nodes and cluster
- Filesystems
- Cluster volume elements
- Local volume elements
- Disks
- Switches
- Users
- Task privileges

### Selecting Items to View or Modify

You can use the following methods to select items:

- Click to select one item at a time
- Shift+click to select a block of items
- Ctrl+click to toggle the selection of any one item

Another way to select one or more items is to type a name into the **Find** text field and then press **Enter** or click the **Find** button.

### Viewing Component Details

To view the details on any component, click its name in the view area; see "Selecting Items to View or Modify" on page 169.

The configuration and status details for the component will appear in the details area to the right. At the bottom of the details area will be the **Applicable Tasks** list, which displays tasks you may wish to launch after evaluating the component's configuration details. To launch a task, click the task name; based on the component selected, default values will appear in the task window.

To see more information about an item in the details area, select its name (which will appear in blue); details will appear in a new window. Terms with glossary definitions also appear in blue.

### Performing Tasks

To perform an individual task, do the following:

1. Select the task name from the **Task** menu or click the right mouse button within the view area. For example:

**Task**  
    > **Guided Configuration**  
        > **Set Up a New Cluster**

The task window appears.

As a shortcut, you can right-click an item in the view area to bring up a list of tasks applicable to that item; information will also be displayed in the details area.

---

**Note:** You can click any blue text to get more information about that concept or input field.

---

2. Enter information in the appropriate fields and click **OK** to complete the task. (Some tasks consist of more than one page; in these cases, click **Next** to go to the next page, complete the information there, and then click **OK**.)

---

**Note:** In every task, the cluster configuration will not update until you click **OK**.

---

A dialog box appears confirming the successful completion of the task.

3. Continue launching tasks as needed.

## Using Drag-and-Drop

The GUI lets you use drag-and-drop to do the following:

- Move nodes between the pool and the cluster
- Structure volume topologies
- Administer XVM disks



**Caution:** Always exercise care when restructuring volume elements with drag-and-drop because data that resides on the volume element can be lost. The GUI attempts to warn the user when it can predict that there is a high likelihood of data loss. However, when a volume is not associated with a mounted filesystem, neither the `xvm` command nor the GUI can determine whether that volume holds important data.

---

To select multiple GUI icons, select the first icon by clicking the left mouse button, then press the `Ctrl` button while clicking on the additional icons. To select consecutive icons, select the first icon and press shift while selecting the last icon.

You cannot drag and drop between two GUI windows. You cannot drag and drop items onto shortcut command buttons.

See the *XVM Volume Manager Administrator's Guide* for more information about using drag-and-drop to structure volume topologies and configure disks.

## Structuring Volume Topologies

To reconfigure a logical volume, do the following:

- Select the view you want:

**View**

> **Cluster Volume Elements**

or

**View**

> **Local Volume Elements**

- Select a volume element icon
- Drag the icon and drop it on another volume element icon

Icons turn blue as you drag to indicate when it is valid to drop upon them. When you drag, if the mouse cursor reaches the top or the bottom of the view area, the display will scroll automatically.

You can use drag-and-drop to operate on multiple volume elements of different types. For example, you can detach several types of volume elements by selecting items and dragging them to any **Unattached** heading, even if no selected item belongs to that category. You can select multiple items of different types and attach them to a parent. For example, you can select two concats and a stripe and use drag-and-drop to attach them to a parent concat.

You can rename volume elements by clicking a selected (highlighted) volume element and typing a new name into the text field.

## Configuring Disks

To label or unlabel disks using drag-and-drop, select the following:

**View**  
    > **Disks**

Select an unlabeled disk then drag and drop it on the **Labeled Disks** heading, or select a labeled disk then drag and drop it on the **Unlabeled Disks** heading.

You can give away a disk using the task menu or drag-and-drop. In the **Disks** view, select a disk and then drag and drop it on the **Cluster Disks** heading.

---

**Note:** Giving away a disk presents less risk of data loss than stealing a disk.

---

You can label a disk by clicking a selected (highlighted) disk and typing a name into the resulting name text field.

For more information, see the *XVM Volume Manager Administrator's Guide*.

## Displaying State

The GUI shows the static and dynamic state of the cluster. For example, suppose the database contains the static information that a filesystem is enabled for mount; the GUI will display the dynamic information showing one of the following:

- A blue icon indicating that the filesystem is mounted (the static and dynamic states match).

- A grey icon indicating that the filesystem is configured to be mounted but the procedure cannot complete because CXFS services have not been started (the static and dynamic states do not match, but this is expected under the current circumstances). See "CXFS Services" on page 29.
- An error (red) icon indicating that the filesystem is supposed to be mounted (CXFS services have been started), but it is not (the static and dynamic states do not match, and there is a problem).

### Getting More Information

Click blue text to launch tasks or display one of the following:

- Term definitions
- Input instructions
- Item details
- The selected task window

### Important GUI and `xvm` Command Differences

When volume elements other than volumes are created or detached, the system automatically creates a volume and a subvolume that are associated with the volume element. You can explicitly name this generated volume, in which case the volume name is stored in label space and persists across machine reboots.

The GUI does not display volumes and subvolumes that were not named explicitly. The GUI displays the children of these volumes and subvolumes as available for use or as unattached. In contrast, the `xvm` command shows all volumes and subvolumes.








The GUI displays filesystems that are on volumes that were not named explicitly, but lists the volumes as **None**. Volumes and subvolumes that the system generated automatically with temporary names are mentioned in the full paths of unattached volume elements (for example, `/vol196/datav`), but the GUI ignores them otherwise.










To reduce the risk of data loss, SGI recommends that you name volumes explicitly when using the GUI. If you have created volumes using the `xvm` command that you did not name explicitly, you can use the `xvm` tool to assign these volumes permanent names before proceeding. This can reduce the risk of data loss.

## Key to Icons and States









The following tables show keys to the icons and states used in the CXFS Manager GUI.

**Table 10-3** Key to Icons

Icon	Entity
	64-bit Linux systems
	Client-only nodes other than 64-bit Linux
	Cluster
	Expanded tree in view area
	Collapsed tree in view area
	Switch
	XVM disk

Icon	Entity
	Unlabeled disk
	Foreign disk
	Slice
	Volume
	Subvolume
	Concat
	Mirror
	Stripe
	Slot







---

Icon	Entity
	Local filesystem
	CXFS filesystem
	Copy on write
	Repository
	Snapshot
	User account
	GUI task for which execution privilege may be granted or revoked
	Privileged command executed by a given GUI task

---



**Table 10-4** Key to States

Icon	State
	(grey icon) Inactive, unknown, offline — CXFS services may not be active
	(blue icon) Enabled for mount — CXFS services may not be active
	(blue icon) Online, ready for use, up, or mounted without error
	(green swatch) Open, in use
	(blinking orange arrow) Mirror reviving
	(red icon) Error detected, down or mounted with error

## Guided Configuration Tasks

This section discusses the following guided configuration tasks:

- "Make Changes to Existing Cluster" on page 178
- "Fix or Upgrade Cluster Nodes" on page 178

Also see "Set Up a New Cluster with the GUI" on page 145, "Set Up a New CXFS Filesystem with the GUI" on page 147, and "CXFS GUI and Status" on page 365. For

information about XVM guided configuration tasks, see the *XVM Volume Manager Administrator's Guide*.

## Make Changes to Existing Cluster

This task lists different ways to edit an existing cluster. You can make changes while the CXFS services are active, such as changing the way the cluster administrator is notified of events; however, you must first stop CXFS services before testing connectivity. You must unmount a filesystem before making changes to it.

See the following:

- "Modify a Cluster Definition with the GUI" on page 195
- "Set Up a New CXFS Filesystem with the GUI" on page 147
- "Modify a CXFS Filesystem with the GUI" on page 213
- "Define a Node with the GUI" on page 179
- "Test Node Connectivity with the GUI" on page 193
- "Add or Remove Nodes in the Cluster with the GUI" on page 188

## Fix or Upgrade Cluster Nodes

This task leads you through the steps required to remove a server-capable administration node from a cluster. It covers the following steps:

- "Stop CXFS Services with the GUI" on page 197.
- Perform the necessary maintenance on the node. If required, see "Reset a Node with the GUI" on page 189.
- "Start CXFS Services with the GUI" on page 197.
- Monitor the state of the cluster components in the view area. See "CXFS GUI and Status" on page 365.

When shutting down, resetting, or restarting a CXFS client-only node, do not stop CXFS services on the node. (Stopping CXFS services is more intrusive on other nodes in the cluster because it updates the cluster database. Stopping CXFS services is appropriate only for a server-capable administration node.) Rather, let the CXFS

shutdown scripts on the node stop CXFS when the client-only node is shut down or restarted.

## Node Tasks with the GUI

This section discusses the following:

- "Define a Node with the GUI" on page 179
- "Examples of Defining a Node with the GUI" on page 185
- "Add or Remove Nodes in the Cluster with the GUI" on page 188
- "Reset a Node with the GUI " on page 189
- "Modify a Node Definition with the GUI" on page 189
- "Delete a Node with the GUI" on page 192
- "Test Node Connectivity with the GUI" on page 193
- "Display a Node with the GUI" on page 193

---

**Note:** The **Set Up a New Cluster** guided configuration task leads you through the tasks required to set up the cluster and nodes. See "Set Up a New Cluster with the GUI" on page 145.

---

## Define a Node with the GUI

---

**Note:** Within the CXFS tasks, you can click any blue text to get more information about that concept or input field. In every task, the cluster configuration will not update until you click **OK**.

---

To define a node, do the following:

1. **Hostname:** Enter the hostname of the node you are defining. You can use a simple hostname, such as `lilly`, if it can be resolved by the name server or `/etc/hosts` on all nodes in the cluster; otherwise, use a fully qualified domain name such as `lilly.example.com`. Use the `ping` command to display the fully qualified hostname. Do not enter an IP address.

If you attempt to define a cluster or other object before the local node has been defined, you will get an error message that says:

No nodes are registered on *servername*. You cannot define a cluster until you define the node to which the GUI is connected. To do so, click "Continue" to launch the "Set Up a New Cluster" task.

2. **Logical Name:** Enter the simple hostname (such as `lilly`) or an entirely different name (such as `nodeA`). If you entered in the simple hostname for the **Hostname** field, the same name will be entered into the **Logical Name** field by default. Logical names cannot begin with an underscore (`_`) or include any whitespace characters, and can be at most 255 characters.

---

**Note:** To rename a node, you must delete it and then define a new node.

---

3. **Operating System:** Choose the name of the operating system that is running on the node being defined.

For Linux, you must specify whether the node is a server-capable administration node or a client-only node. Other nodes are always client-only nodes.

If you select a fail policy that includes reset for a Linux node, you will be given an opportunity to provide reset information on a second page. Any potential metadata server should include reset in its fail policy hierarchy.

You cannot later modify the operating system for a defined node. To change the operating system, you would have to delete the node and then define a new node with the new name.

4. **Node Function:** Select one of the following:

- **Server-capable Admin** is a node on which you will execute cluster administration commands and that you also want to be a CXFS metadata server. (You will use the **Define a CXFS Filesystem** task to define the specific filesystem for which this node can be a metadata servers.) Use this node function only if the node will be a metadata servers. You must install the `cluster_admin` product on this node.
- **Client-only** is a node that shares CXFS filesystems but on which you will not execute cluster administration commands and that will not be a CXFS metadata server. Use this node function for all nodes other than those that will be metadata servers. You must install the product on this node. This node

can run on any platform. (Nodes other than Linux are required to be client-only nodes.)

5. **Networks for Incoming Cluster Messages:** Do the following:

- **Network:** Enter the IP address or hostname of the NIC. (The hostname must be resolved in the `/etc/hosts` file.) The priorities of the NICs must be the same for each node in the cluster. For information about why a private network is required, see "Private Network" on page 23.

- **Messages to Accept:** Select **Heartbeat and Control**.

You can use the **None** setting if you want to temporarily define a NIC but do not want it to accept messages.

- Click **Add** to add the NIC to the list.

If you later want to modify the NIC, click the NIC in the list to select it, then click **Modify**.

To delete a NIC from the list, click the NIC in the list to select it, then click **Delete**.

By default, the priority 1 NICs are used as the private network; they must be on the same subnet. To allow one network to fail over to another, you must group the NICs into failover networks manually by using `cxfs_admin`. See Chapter 11, "cxfs\_admin Command" on page 223.

6. **Node ID:** (*Optional*) is an integer in the range 1 through 32767 that is unique among the nodes in the cluster. If you change this value after a node has been defined, you must reboot the affected node. You do not normally need to specify this attribute because CXFS will calculate an ID for you.

7. **Partition ID:** (*Optional*) Uniquely defines a partition in a partitioned Altix 3000 series system or Altix 4700 system. If your system is not partitioned, leave this field empty. Use the Linux `proc` command to determine the partition ID value (see below).

Click **Next** to move to the next screen.

8. **Fail Policy:** Specify the set of actions that determines what happens to a failed node: the second action will be followed only if the first action fails; the third action will be followed only if the first and second fail.

The available actions depend upon the operating system value selected for the node:

- **Shutdown:** tells the other nodes in the cluster to wait for a period of time (long enough for the node to shut itself down) before reforming the CXFS kernel membership. (However, there is no notification that the node's shutdown has actually taken place.) The default fail policy hierarchy for Linux nodes is **Reset, Shutdown**. The default for other nodes is **Shutdown**.



**Caution:** There are issues when using **Shutdown** with server-capable administration nodes; for more information and for a list of valid fail policy sets, see "Data Integrity Protection" on page 25. If you are using dynamic CXFS kernel heartbeat monitoring, you must not use the **Shutdown** setting on a client-only node. For information about heartbeat monitoring, see "Use the Appropriate CXFS Kernel Heartbeat Monitoring" on page 70. To specify a fail policy without **Shutdown** you must define or modify the node with `cxfs_admin`. See Chapter 11, "cxfs\_admin Command" on page 223.

---

- **Fence:** disables access to the SAN from the problem node. Fencing provides faster recovery of the CXFS kernel membership than reset.
- **FenceReset:** performs a fence and then, if the node is successfully fenced, **also** performs an asynchronous reset of the node via a system controller (according to the chosen reset method); recovery begins without waiting for reset acknowledgement.

---

**Note:** A server-capable administration node should also include **Reset** in its fail policy hierarchy (unless it is the only server-capable administration node in the cluster).

---

- **Reset:** performs a system reset via a system controller. A server-capable administration node should include **Reset** in its fail policy hierarchy.

---

**Note:** If the failure hierarchy contains **Reset** or **FenceReset**, the reset might be performed before the system kernel core-dump can complete, resulting in an incomplete core-dump.

---

9. If you have chosen a failure hierarchy that includes **Reset** or **FenceReset**, provide the following information.

- This node:
  - **Port Type:** select one of the following:
    - **L2** (Any Altix with an L2, Prism)
    - **BMC** (Altix XE systems)

---

**Note:** Altix XE systems use baseboard management controller (BMC) for reset. To configure reset via BMC or L2 over the network, use the `cxfs_admin` configuration tool. See "Create or Modify a Node with `cxfs_admin`" on page 242.

---

- **Reset Method:** The type of reset to be performed:
  - **Power Cycle** shuts off power to the node and then restarts it
  - **Reset** simulates the pressing of the reset button on the front of the machine (recommended)
  - **NMI** (nonmaskable interrupt) performs a core-dump of the operating system kernel, which may be useful when debugging a faulty machine

---

**Note:** NMI depends upon kernel support, which may not be present on all SGI Altix ia64 systems; if the kernel support is not provided, the **NMI** setting will not work.

NMI is not available on systems containing a baseboard management controller (BMC), such as SGI Altix XE x86-64 systems.

---

- **Port Password:** The password for the system controller port, **not** the node's `root` password or PROM password. On some nodes, the system administrator may not have set this password. If you wish to set or change

the system controller port password, consult the hardware manual for your node.

- **Temporarily Disable Port:** If you want to provide reset information now but do not want to allow the reset capability at this time, check this box. If this box is checked, CXFS cannot reset the node.
- Owner (node that sends the reset command):
  - **Logical Name:** Name of the node that sends the reset command. If you use serial cables, they must physically connect the node being defined and the owner node through the system controller port. At run time, the node must be defined in the CXFS pool.

You can select a logical name from the pull-down list or enter the logical name of a node that is not yet defined. However, you must define the server-capable administration node in CXFS before you run the node connectivity diagnostics task or start CXFS services.

- **TTY Device:** Name of the terminal port (TTY) on the owner node to which the system controller is connected (the node being reset). `/dev/ttyd2` is the most commonly used port, except on Altix 350 systems (where `/dev/ttyIOC0` is commonly used). The other end of the cable connects to this node's (the node being reset) system controller port, so the node can be controlled remotely by the owner node. Check the owner node's specific hardware configuration to verify which tty device to use.

---

**Note:** To specify reset method that uses Intelligent Platform Management Interface (IPMI) or L2 over the network, use the `cxfs_admin` configuration tool. See "Create or Modify a Node with `cxfs_admin`" on page 242.

---

10. Click **OK**.

---

**Note:** Do not add a second node until the first node icon appears in the view area. The entire cluster status information is sent to each server-capable administration node each time a change is made to the cluster database; therefore, the more server-capable administration nodes in a configuration, the longer it will take.

---



You can find the partition ID by reading the `proc` file. For example:

```
linux# cat /proc/sgi_sn/partition_id
0
```

The 0 indicates that the system is not partitioned. If the system is partitioned, the number of partitions (such as 1, 2, etc.) is displayed.

You could enter one of the following for the **Partition ID** field:

```
1
001.10
```

## Examples of Defining a Node with the GUI

The following figures show an example of defining a new node.

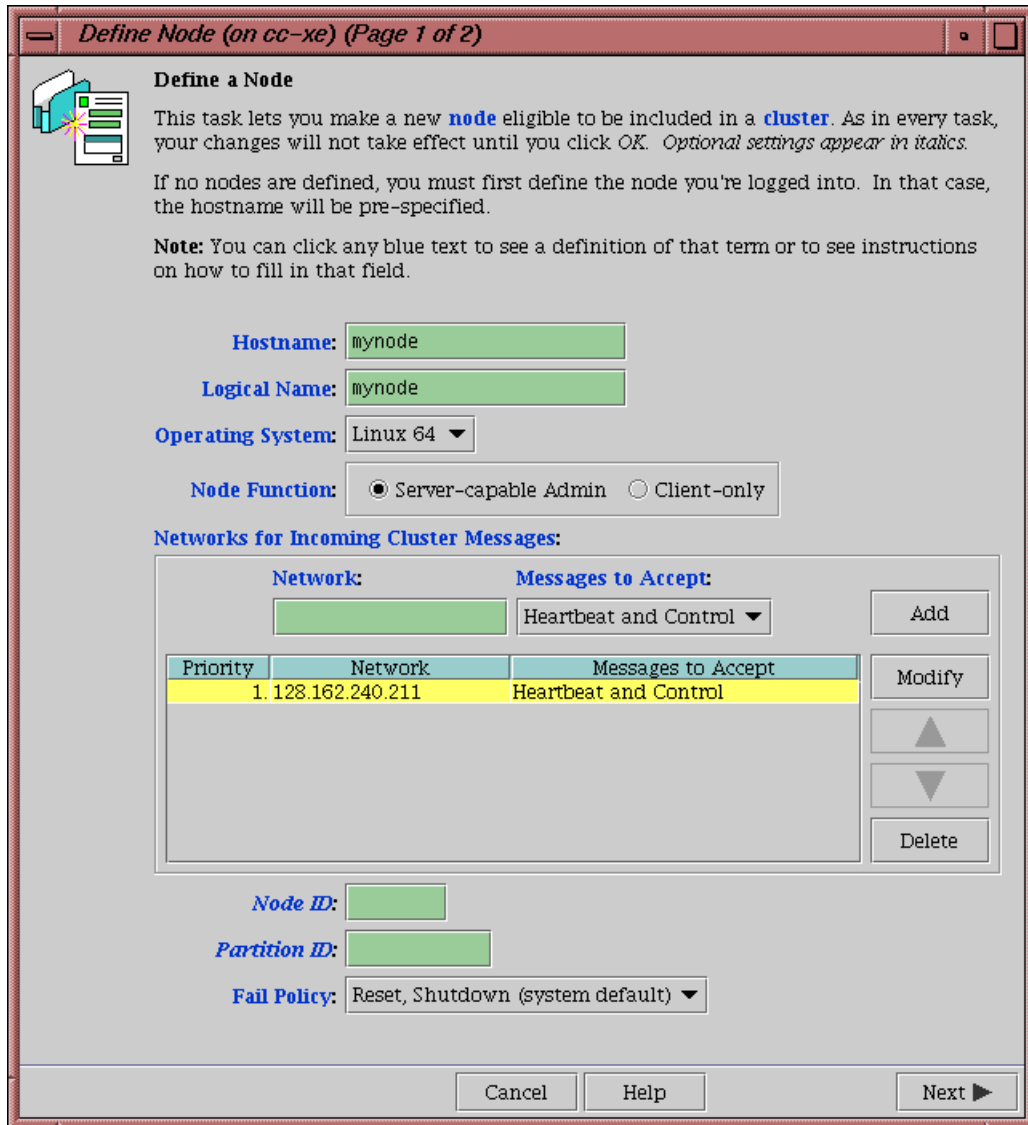


Figure 10-3 Example Node Definition

**Define Node (on cc-xe) (Page 2 of 2)**

**Configure how this node will be reset.**

When a CXFS node is not responding or is responding incorrectly to other CXFS cluster nodes, another CXFS node can reset the offending node by sending a message to its **system controller port**. To allow this node to be reset, you must provide information about both this node and the node that can reset it.

**Node mynode**

**Port Type:** L2 ▼

**Reset Method:** Power Cycle ▼

**Port Password:**

**Temporarily Disable Port:**

**Owner (Node that Sends Reset Command)**

**Logical Name:** cc-xe2 ▼

**TTY Device:** /dev/ttyd2

◀ Prev      OK      Cancel      Help

**Figure 10-4** Example System Reset Settings

## Add or Remove Nodes in the Cluster with the GUI

To avoid potential problems, you should add all server-capable administration nodes to the cluster before adding any client-only nodes. See "Create an Initial Cluster of All Server-Capable Administration Nodes" on page 54. After you have added nodes to the pool and defined the cluster, you can indicate which nodes to include in the cluster.

---

**Note:** Before adding or removing a server-capable administration node, you must first unmount any filesystems for which the node will be a potential metadata server.

Do not add or remove nodes until the cluster icon appears in the view area; set the **View** selection to **Nodes and Cluster**.

---

Do the following:

1. Add or remove the desired nodes:

- To add a node, select its logical name from the **Available Nodes** pull-down menu and click **Add**. The node name will appear in the **Nodes to Go into Cluster** list. To select all of the available nodes, click **Add All**.

---

**Note:** SGI recommends that you form an initial cluster that consists of all of the server-capable administration nodes, to ensure that these nodes will have lower cell ID numbers than any client-only nodes. See "Create an Initial Cluster of All Server-Capable Administration Nodes" on page 54.

---

- To delete a node, click its logical name in the **Nodes to Go into Cluster** screen. (The logical name will be highlighted.) Then click **Remove**.

2. Click **OK**.

## Reset a Node with the GUI

You can use the GUI to reset Linux nodes with system controllers. This sends a reset command to the system controller port on the specified node. When the node is reset, other nodes in the cluster will detect the change and remove the node from the active cluster. When the node reboots, it will rejoin the CXFS kernel membership.

To reset a node, do the following:

1. **Node to Reset:** Choose the node to be reset from the pull-down list.
2. Click **OK**.

## Modify a Node Definition with the GUI

To rename a node or change its operating system, you must delete it and then define a new node.

To modify other information about a node, do the following:

1. **Logical Name:** Choose the logical name of the node from the pull-down list. After you do this, information for this node will be filled into the various fields.
2. **Networks for Incoming Cluster Messages:** The priorities of the NICs must be the same for each node in the cluster.
  - **Network:** To add a NIC for incoming cluster messages, enter the IP address or hostname into the **Network** text field and click **Add**.
  - To modify a NIC that is already in the list, click the network in the list in order to select it. Then click **Modify**. This moves the NIC out of the list and into the text entry area. You can then change it. To add it back into the list, click **Add**.
  - To delete a NIC, click the NIC in the priority list in order to select it. Then click **Delete**.
  - To change the priority of a NIC, click the NIC in the priority list in order to select it. Then click the up and down arrows in order to move it to a different position in the list.

You can use the **None** setting if you want to temporarily define a NIC but do not want it to accept messages.

By default, the priority 1 NICs are used as the private network; they must be on the same subnet. To allow the one network to fail over to another, you must

group the NICs into networks manually by using `cxfs_admin`. See Chapter 11, "cxfs\_admin Command" on page 223.

Click **Next** to move to the next page.

3. **Partition ID:** (*Optional*) Uniquely defines a partition in a partitioned Altix 3000 series system or Altix 4700 system. If your system is not partitioned, leave this field empty. You can use the Linux `proc` command to determine the partition ID value; see below.
4. **Fail Policy:** Specify the set of actions that determines what happens to a failed node: the second action will be followed only if the first action fails; the third action will be followed only if the first and second fail.

The available actions depend upon the operating system value selected for the node:

- **Shutdown:** tells the other nodes in the cluster to wait for a period of time (long enough for the node to shut itself down) before reforming the CXFS kernel membership. (However, there is no notification that the node's shutdown has actually taken place.) The default fail policy hierarchy for Linux nodes is **Reset, Shutdown**. The default for other nodes is **Shutdown**.



**Caution:** There are issues when using **Shutdown** with server-capable administration nodes; for more information and for a list of valid fail policy sets, see "Data Integrity Protection" on page 25. If you are using dynamic CXFS kernel heartbeat monitoring, you must not use the **Shutdown** setting on a client-only node. For information about heartbeat monitoring, see "Use the Appropriate CXFS Kernel Heartbeat Monitoring" on page 70. To specify a fail policy without **Shutdown** you must define or modify the node with `cxfs_admin`. See Chapter 11, "cxfs\_admin Command" on page 223.

---

- **Fence:** disables access to the SAN from the problem node. Fencing provides faster recovery of the CXFS kernel membership than reset.
- **FenceReset:** performs a fence and then, if the node is successfully fenced, **also** performs an asynchronous reset of the node via a system controller (according to the chosen reset method); recovery begins without waiting for reset acknowledgement.

---

**Note:** A server-capable administration node should also include **Reset** in its fail policy hierarchy (unless it is the only server-capable administration node in the cluster).

---

- **Reset:** performs a system reset via a system controller. A server-capable administration node should include **Reset** in its fail policy hierarchy.
5. If you have chosen a failure hierarchy that includes **Reset** or **FenceReset**, provide the following information.
- This node:
    - **Port Type:** select one of the following:
      - **L2** (Any Altix with an L2, Prism)
      - **BMC** (Altix XE systems)
    - **Reset Method:** The type of reset to be performed:
      - **Power Cycle** shuts off power to the node and then restarts it
      - **Reset** simulates the pressing of the reset button on the front of the machine (recommended)
      - **NMI** (nonmaskable interrupt) performs a core-dump of the operating system kernel, which may be useful when debugging a faulty machine

---

**Note:** NMI depends upon kernel support, which may not be present on all SGI Altix ia64 systems; if the kernel support is not provided, the NMI setting will not work.

NMI is not available on systems containing a baseboard management controller (BMC), such as SGI Altix XE x86-64 systems.

---

- **Port Password:** The password for the system controller port, **not** the node's `root` password or PROM password. On some nodes, the system administrator may not have set this password. If you wish to set or change the system controller port password, consult the hardware manual for your node.

- **Temporarily Disable Port:** If you want to provide reset information now but do not want to allow the reset capability at this time, check this box. If this box is checked, CXFS cannot reset the node.
- Owner (node that sends the reset command):
  - **Logical Name:** Name of the node that sends the reset command. At run time, the node must be defined in the CXFS pool. You can select a logical name from the pull-down list or enter the logical name of a node that is not yet defined. However, you must define the node in CXFS before you run the node connectivity diagnostics task.
  - **TTY Device:** Name of the terminal port (TTY) on the owner node to which the system controller is connected. `/dev/ttyd2` is the most commonly used port, except on Altix 350 systems (where `/dev/ttyIOC0` is commonly used). The other end of the cable connects to this node's system controller port, so the node can be controlled remotely by the other node.

---

**Note:** To specify reset method that uses Intelligent Platform Management Interface (IPMI) or L2 over the network, use the `cxfs_admin` configuration tool. See "Create or Modify a Node with `cxfs_admin`" on page 242.

---

#### 6. Click **OK**.

On Linux, you can find the partition ID by reading the `proc` file. For example:

```
linux# cat /proc/sgi_sn/partition_id
0
```

The 0 indicates that the system is not partitioned. If the system is partitioned, the number of partitions (such as 1, 2, etc.) is displayed.

You could enter one of the following for the **Partition ID** field:

```
1
001.10
```

## Delete a Node with the GUI

You must remove a node from a cluster before you can delete the node from the pool. For information, see "Modify a Cluster Definition with the GUI" on page 195.



To delete a node, do the following:

1. **Node to Delete:** Select the logical name of the node to be deleted from the pull-down list.
2. Click **OK**.

## Test Node Connectivity with the GUI

The **Test Node Connectivity** screen requires `rsh` access between hosts. The `/.rhosts` file must contain the hosts and local host between which you want to test connectivity.

To test connectivity, do the following from the CXFS Manager:

1. Choose whether to test by network or serial connectivity by clicking the appropriate radio button.
2. Choose a node to be tested from the pull-down list and add it to the test list by clicking **Add**.

To delete a node from the list of nodes to be tested, click the logical name to select it and then click **Delete**.

3. To start the tests, click **Start Tests**. To stop the tests, click **Stop Tests**.
4. To run another test, click **Clear Output** to clear the status screen and start over with step 3.
5. To exit from the window, click **Close**.

## Display a Node with the GUI

After you define nodes, you can use the **View** selection in the view area to display the following:

- **Nodes and Cluster** shows the nodes that are defined as part of a cluster or as part of the pool (but not in the cluster)

Click any name or icon to view detailed status and configuration information.

## Cluster Tasks with the GUI

This section discusses the following:

- "Define a Cluster with the GUI" on page 194
  - "Modify a Cluster Definition with the GUI" on page 195
  - "Delete a Cluster with the GUI" on page 196
  - "Display a Cluster with the GUI" on page 196
- 

**Note:** The **Set Up a New Cluster** guided configuration task leads you through the tasks required to set up the cluster and nodes. See "Set Up a New Cluster with the GUI" on page 145.

---

### Define a Cluster with the GUI

A *cluster* is a collection of nodes coupled to each other by a private network. A cluster is identified by a simple name. A given node may be a member of only one cluster.

To define a cluster, do the following:

1. Enter the following information:
  - **Cluster Name:** The logical name of the cluster. Logical names cannot begin with an underscore (`_`) or include any whitespace characters, and can be at most 255 characters. Clusters must have unique names.
  - **Cluster ID:** A unique number within your network in the range 1 through 255. The cluster ID is used by the operating system kernel to make sure that it does not accept cluster information from any other cluster that may be on the network. The kernel does not use the database for communication, so it requires the cluster ID in order to verify cluster communications. This information in the kernel cannot be changed after it has been initialized; therefore, you must not change a cluster ID after the cluster has been defined. Clusters must have unique IDs.
  - **Cluster Mode:** Usually, you should set the cluster to the default `Normal` mode.

Setting the mode to `Experimental` turns off CXFS kernel heartbeat in the CXFS kernel membership code so that you can debug the cluster without causing node failures. For example, this can be useful if you just want to

disconnect the network for a short time (provided that there is no other cluster networking activity, which will also detect a failure even if there is no heartbeat) or if you want to enter the kernel debugger (which stops heartbeat) on a CXFS node. You should only use `Experimental` mode when debugging with the approval of SGI support.

- **Notify Administrator** (of cluster and node status changes):
  - **By e-mail:** This choice requires that you specify the e-mail program (`/usr/sbin/Mail` by default) and the e-mail addresses of those to be identified. To specify multiple addresses, separate them with commas. CXFS will send e-mail to the addresses whenever the status changes for a node or cluster. If you do not specify an address, notification will not be sent.
  - **By other command:** This choice requires that you specify the command to be run whenever the status changes for a node or cluster.
  - **Never:** This choice specifies that notification is not sent.

2. Click **OK**.

## Modify a Cluster Definition with the GUI

To change how the cluster administrator is notified of changes in the cluster's state, do the following:

1. Enter the following information:
  - **Cluster Name:** Choose from the pull-down list.
  - **Cluster Mode:** Usually, you should set the cluster to the default `Normal` mode. See "Define a Cluster with the GUI" on page 194, for information about `Experimental` mode.
  - **Notify Administrator:** Select the desired notification. For more information, see "Define a Cluster with the GUI" on page 194.
2. Click **OK**.

To modify the nodes that make up a cluster, see "Add or Remove Nodes in the Cluster with the GUI" on page 188.

---

**Note:** If you want to rename a cluster, you must delete it and then define a new cluster. If you have started CXFS services on the node, you must either reboot it or reuse the cluster ID number when renaming the cluster.

However, be aware that if you already have CXFS filesystems defined and then rename the cluster, CXFS will not be able to mount the filesystems. For more information, see "Cannot Mount Filesystems" on page 399.

---

### Delete a Cluster with the GUI

You cannot delete a cluster that contains nodes; you must move those nodes out of the cluster first. For information, see "Add or Remove Nodes in the Cluster with the GUI" on page 188.

To delete a cluster, do the following:

1. **Cluster to Delete:** The name of the cluster is selected for you.
2. Click **OK**.

### Display a Cluster with the GUI

From the **View** selection, you can choose elements to examine. To view details of the cluster, click the cluster name or icon; status and configuration information will appear in the details area on the right.

### Cluster Services Tasks with the GUI

This section discusses the following:

- "Start CXFS Services with the GUI" on page 197
- "Stop CXFS Services with the GUI" on page 197
- "Set Tiebreaker Node with the GUI" on page 198
- "Set Log Configuration with the GUI" on page 198
- "Revoke Membership of the Local Node with the GUI" on page 201

- "Allow Membership of the Local Node with the GUI" on page 201

## Start CXFS Services with the GUI

To start CXFS services, and set the configuration to automatically restart CXFS services whenever the system is rebooted, do the following:

1. **Node(s) to Activate:** Select `All Nodes` or the individual node on which you want to start CXFS services.
2. Click **OK**.

## Stop CXFS Services with the GUI

When CXFS services are stopped on a node, filesystems are automatically unmounted from that node. You can stop CXFS on a specified node or for the cluster, and prevent CXFS services from being restarted by a reboot, by performing the following steps.

---

**Note:** If you stop CXFS services using this method, they will not restart when the node is rebooted. To stop CXFS services temporarily (that is, allowing them to restart with a reboot if so configured), see "Manually Starting/Stopping CXFS" on page 316

---

1. Enter the following information:
  - **Force:** If you want to forcibly stop CXFS services even if there are errors (which would normally prevent the stop operation), click the **Force** checkbox.
  - **Node(s) to Deactivate:** Select `All Nodes` or the individual node on which you want to stop CXFS services.

If you stop CXFS services on one node, that node will no longer have access to any filesystems. If that node was acting as the metadata server for a filesystem, another node in the list of potential metadata servers will be chosen. Clients of the filesystem will experience a delay during this process.
2. Click **OK**. It may take a few minutes to complete the process.

After you have stopped CXFS services on a node, the node is no longer an active member of the cluster. CXFS services will not be restarted when the system reboots.



---

**Caution:** You should stop CXFS services before using the `shutdown` or `reboot` commands. If you execute `shutdown` or `reboot` when CXFS services are active, the remaining nodes in the cluster will view it as a node failure and be forced to run recovery against that node.

---

### Set Tiebreaker Node with the GUI

A *CXFS tiebreaker node* determines whether a CXFS kernel membership quorum is maintained when exactly half of the server-capable administration nodes are up and can communicate with each other. There is no default CXFS tiebreaker.



---

**Caution:** If one of the server-capable administration nodes is the CXFS tiebreaker in a cluster with two server-capable administration nodes, failure of that node or stopping the CXFS services on that node will result in a cluster-wide forced shutdown. Therefore SGI recommends that you use client-only nodes as tiebreakers so that either server could fail but the cluster would remain operational via the other server.

To ensure data integrity, SGI recommends that you use system reset for all potential metadata servers and reset or I/O fencing for all client-only nodes.

---

The current CXFS tiebreaker node is shown in the detailed view of the cluster.

To set the CXFS tiebreaker node, do the following:

1. **Tie-Breaker Node:** Select the desired node from the list. If there currently is a CXFS tiebreaker, it is selected by default.

To unset the CXFS tiebreaker node, select `None`.

2. Click **OK**.

### Set Log Configuration with the GUI

CXFS maintains logs for each of the CXFS daemons. CXFS logs both normal operations and critical errors to individual log files for each log group and the `/var/log/messages` system log file on server-capable administration nodes.

You can customize the logs according to the level of logging you wish to maintain.



---

**Caution:** Do not change the names of the log files. If you change the names, errors can occur.

---

When you define a log configuration, you specify the following information:

- **Log Group:** A set of one or more CXFS processes that use the same log configuration. A log group usually corresponds to one CXFS daemon, such as `crsd`.
- **Log Level:** A number controlling the amount of log messages that CXFS will write into an associated log group's log file.
- **Log File:** The file in which to log messages.

See also "Status in Log Files" on page 364.

#### Display Log Group Definitions with the GUI

To display log group definitions, do the following:

1. **Log Group:** Choose the log group to display from the menu.

The current log level and log file for that log group will be displayed in the task window, where you can change those settings if you desire.

2. Click **OK**.

### Configure Log Groups with the GUI

To configure a log group, do the following in the **Set Log Configuration** task:

1. Enter the appropriate information:
  - **Log Group:** Select the log group from the pull-down list. A *log group* is a set of processes that log to the same log file according to the same logging configuration. Each CXFS daemon creates a log group. Settings apply to all nodes in the pool for the `cli` and `crsd` log groups, and to all nodes in the cluster for the `clconfd` and `diags` log groups.
  - **Log Level:** Select the log level, which specifies the amount of logging.



**Caution:** The **Default** log level is quite verbose; using it could cause space issues on your disk. You may wish to select a lower log level. Also see:

"Log File Management" on page 310

"`cad.options` on Server-Capable Administration Nodes" on page 130

"`fs2d.options` on Server-Capable Administration Nodes" on page 131

---

The values are as follows:

- **Off** gives no logging
  - **Minimal** logs notifications of critical errors and normal operation (these messages are also logged to the `/var/log/messages` file)
  - **Info** logs **Minimal** notifications plus warnings
  - **Default** logs all **Info** messages plus additional notifications
  - **Debug 0** through **Debug 9** log increasingly more debug information, including data structures
2. **Log File:** Do not change this value.
  3. Click **OK**.



## Revoke Membership of the Local Node with the GUI

You should revoke CXFS kernel membership of the local node only in the case of error, such as when you need to perform a forced CXFS shutdown (see "Shutdown of the Database and CXFS" on page 304).

To revoke CXFS kernel membership for the local node, do the following:

1. **Local Node:** Verify the name of the local node, which will be displayed in the pop-up window.
2. Click **OK** to complete the task.

The result of this task will be considered as a node failure by the rest of the cluster. The rest of the cluster may then fail due to a loss of CXFS kernel membership quorum, or it may decide to reset the failed node. To avoid the reset, you can modify the node definition to disable the system controller status.

## Allow Membership of the Local Node with the GUI

You must allow CXFS kernel membership for the local node (the node to which the GUI is connected) after fixing the problems that required a forced CXFS shutdown; doing so allows the node to reapply for CXFS kernel membership in the cluster. A forced CXFS shutdown can be performed manually or can be triggered by the kernel. For more information, see "Shutdown of the Database and CXFS" on page 304.

You must actively allow CXFS kernel membership of the local node in the following situations:

- After a manual revocation as in "Revoke Membership of the Local Node with the GUI" on page 201.
- When instructed to by an error message on the console or the `/var/log/messages` system log file.
- After a kernel-triggered revocation. This situation is indicated by the following message in the `/var/log/messages` system log file:

```
Membership lost - withdrawing from cluster
```

To allow CXFS kernel membership for the local node, do the following:

1. **Local Node:** Verify the name of the local node, which will be displayed in the pop-up window.
2. Click **OK** to complete the task.

## Switches and I/O Fencing Tasks with the GUI

This section discusses the following:

- "Define a Switch with the GUI" on page 202
- "Modify a Switch Definition with the GUI" on page 205
- "Update Switch Port Information with the GUI" on page 205
- "Delete a Switch Definition with the GUI" on page 205
- "Raise the I/O Fence for a Node with the GUI" on page 206
- "Lower the I/O Fence for a Node with the GUI" on page 206

See the release notes for supported switches.

---

**Note:** Nodes without system controllers require I/O fencing to protect data integrity.

---

### Define a Switch with the GUI

This task lets you define a new switch to support I/O fencing in a cluster.

Do the following:

1. Enter the following information:
  - **Switch Name:** Enter the hostname of the switch; this is used to determine the IP address of the switch.
  - **Username:** Enter the user name to use when sending a telnet message to the switch. By default, this value is `admin`.
  - **Password:** Enter the password for the specified **Username** field.

- **Mask:** Enter one of the following:
  - A list of ports in the switch that will never be fenced. The list has the following form, beginning with the # symbol and separating each port number with a comma:

```
#port, port, port . . .
```

Each *port* is a decimal integer in the range 0 through 1023. Use a hyphen to specify an inclusive range. For example, the following indicates that port numbers 2, 4, 5, 6, 7, and 23 will never be fenced:

```
#2,4-7,23
```

---

**Note:** For the bladed Brocade 48000 switch (where the port number is not unique), the value you should use for **Mask** is the `Index` value that is displayed by the `switchShow` command. For example, the `switchShow` output below indicates that you would use a mask value of 16 for port 0 in slot 2:

```
brocade48000:admin> switchShow
Index Slot Port Address Media Speed State Proto
=====
   0   1   0   010000   id    N4   Online  F-Port  10:00:00:00:c9:5f:9b:ea
   1   1   1   010100   id    N4   Online  F-Port  10:00:00:00:c9:5f:ab:d9
   ...
  142   1  30   018e00   id    N4   Online  F-Port  50:06:0e:80:04:5c:0b:46
  143   1  31   018f00   id    N4   Online  F-Port  50:06:0e:80:04:5c:0b:66
   16   2   0   011000   id    N4   Online  F-Port  10:00:00:00:c9:5f:a1:f5
   17   2   1   011100   id    N4   Online  F-Port  10:00:00:00:c9:5f:a1:72
   ...
```

---

- A hexadecimal string that represents the list of ports in the switch that will never be fenced.

Ports are numbered from zero. If a given bit has a binary value of 0, the port that corresponds to that bit is eligible for fencing operations; if 1, then the port that corresponds to that bit will always be excluded from any fencing operations. For example, Figure 10-5 shows that a mask of `FF03` for a 16-port switch indicates that only ports 2–7 are eligible for fencing (because they have binary values of 0). Similarly, it shows that a mask of `A4` for an 8-port switch allows fencing only on ports 0, 1, 3, 4, and 6 (the

port numbers corresponding to binary 0) — ports 2, 5, and 7 will never be fenced (the port numbers corresponding to the nonzero value).

**16-port Switch (1= never fence, 0= may fence)**

Port #	15 14 13 12	11 10 9 8	7 6 5 4	3 2 1 0
Binary	1 1 1 1	1 1 1 1	0 0 0 0	0 0 1 1
Hexadecimal	F	F	0	3

**8-port Switch**

Port #	7 6 5 4	3 2 1 0
Binary	1 0 1 0	0 1 0 0
Hexadecimal	A	4

**Figure 10-5** Bit Mask Representation for I/O Fencing

Server-capable administration nodes automatically discover the available HBAs and, when fencing is triggered, will fence off all of the Fibre Channel HBAs when the **Fence** or **FenceReset** fail policy is selected. However, masked HBAs will not be fenced. Masking allows you to prevent the fencing of devices that are attached to the SAN but are not shared with the cluster, to ensure that they remain available regardless of CXFS status. You would want to mask HBAs used for access to tape storage, or HBAs that are only ever used to access local (nonclustered) devices.

- **Vendor:** Select the name of the switch vendor or enter the vendor name manually if not found in the list.
2. Click **OK** to complete the task.

## Modify a Switch Definition with the GUI

This task lets you modify an existing switch definition.

Do the following:

1. Enter the following information:
  - **Switch Name:** Select the hostname of the switch to be modified.
  - **Username:** Enter the user name to use when sending a telnet message to the switch. By default, this value is admin.
  - **Password:** Enter the password for the specified **Username** field.
  - **Mask:** Enter a list of port numbers or a hexadecimal string that represents the list of ports in the switch that will not be fenced. For more information, see "Define a Switch with the GUI" on page 202.
2. Click **OK** to complete the task.

---

**Note:** You cannot modify the vendor name for a switch. To use a different vendor, delete the switch and redefine it.

---

## Update Switch Port Information with the GUI

This task lets you update the mappings between the host bus adapters (HBAs) and switch ports. You should run this command if you reconfigure any switch or add ports. Click **OK** to complete the task.

## Delete a Switch Definition with the GUI

This task lets you delete an existing switch definition. Do the following:

1. **Switch Name:** Select the hostname of the Fibre Channel switch to be deleted.
2. Click **OK** to complete the task.

### Raise the I/O Fence for a Node with the GUI

This task lets you raise the I/O fence for a node. Raising an I/O fence isolates the node from the SAN; CXFS sends a messages via the `telnet` protocol to the switch and disables the port. After the node is isolated, it cannot corrupt data in the shared CXFS filesystem.

Do the following:

1. **Raise Fence for Node:** Select the name of the node you want to isolate. Only nodes that have been configured with a **Fence** or **FenceReset** fail policy can be selected.
2. Click **OK** to complete the task.

### Lower the I/O Fence for a Node with the GUI

This task lets you lower the I/O fence for a given node by reenabling the port. Lowering an I/O fence allows the node to reconnect to the SAN and access the shared CXFS filesystem.

Do the following:

1. **Lower Fence for Node:** Select the node you want to reconnect. Only nodes that have been configured with a **Fence** or **FenceReset** fail policy can be selected.
2. Click **OK** to complete the task.

## Filesystem Tasks with the GUI

The following tasks let you configure CXFS filesystems as shared XVM volumes. These shared volumes can be directly accessed by all nodes in a CXFS cluster. Each volume is identified by its device name. Each volume must have the same mount point on every node in the cluster.

---

**Note:** The **Set Up a New CXFS Filesystem** guided configuration task leads you through the steps required to set up a new CXFS filesystem. See "Set Up a New CXFS Filesystem with the GUI" on page 147.

---

This section discusses the following:

- "Make Filesystems with the GUI" on page 207
- "Grow a Filesystem with the GUI" on page 209
- "Define CXFS Filesystems with the GUI" on page 210
- "Modify a CXFS Filesystem with the GUI" on page 213
- "Mount CXFS Filesystems with the GUI" on page 214
- "Unmount CXFS Filesystems with the GUI" on page 215
- "Mount a Filesystem Locally" on page 215
- "Unmount a Local Filesystem" on page 216
- "Delete a CXFS Filesystem with the GUI" on page 216
- "Remove Filesystem Mount Information" on page 216
- "Relocate a Metadata Server for a CXFS Filesystem with the GUI" on page 217

### Make Filesystems with the GUI

This task lets you create a filesystem on a volume that is online but not open. To create filesystems on multiple volume elements, use the **Browse** button.

---



**Caution:** Clicking OK will erase all data that exists on the target volume.

---

To make a filesystem, do the following:

1. Enter the following information:
  - **Domain:** Select the domain that will own the volume element to be created. Choose **Local** if the volume element or disk is defined for use only on the node to which the GUI is connected, or choose **Cluster** if it is defined for use on multiple nodes in the cluster.
  - **Volume Element:** Select the volumes on which to create the filesystem or select the volume elements whose parent volumes will be used for the filesystems. The menu lists only those volume elements that are available. (When volume elements other than volumes are created or detached, the system automatically creates a volume and a subvolume that are associated with the volume element. If you did not explicitly name an automatically generated volume, the GUI will display its children only.)
  - **Specify Sizes:** Check this box to modify the default options for the filesystem, including data region size, and log size.

By default, the filesystem will be created with the data region size equal to the size of the data subvolume. If the volume contains a log subvolume, the log size will be set to the size of the log subvolume.

2. If you checked the **Specify Sizes** box, click **Next** to move to page 2. On page 2, enter the following information. For more information about these fields, see the `mkfs.xfs` man page.
  - **Block Size:** Select the fundamental block size of the filesystem in bytes.
  - **Directory Block Size:** Select the size of the naming (directory) area of the filesystem in bytes.
  - **Inode Size:** Enter the number of blocks to be used for inode allocation, in bytes. The inode size cannot exceed one half of the **Block Size** value.
  - **Maximum Inode Space:** Enter the maximum percentage of space in the filesystem that can be allocated to inodes. The default is 25%. (Setting the value to 0 means that the entire filesystem can become inode blocks.)
  - **Flag Unwritten Extents:** Check this box to flag unwritten extents. If unwritten extents are flagged, filesystem write performance will be negatively affected for preallocated file extents because extra filesystem transactions are required to convert extent flags for the range of the file.



You should disable this feature (by unchecking the box) if the filesystem must be used on operating system versions that do not support the flagging capability.

- **Data Region Size:** Enter the size of the data region of the filesystem as a number of 512-byte blocks. This number is usually equal to the size of the data subvolume. You should specify a size other than 0 only if the filesystem should occupy less space than the size of the data subvolume.
- **Use Log Subvolume for Log:** Check this box to specify that the log section of the filesystem should be written to the log subvolume of the XVM logical volume. If the volume does not contain a log subvolume, the log section will be a piece of the data section on the data subvolume.
- **Log Size:** Enter the size of the log section of the filesystem as a number of 512-byte blocks. You should specify a size other than 0 only if the log should occupy less space than the size of the log subvolume.

---

**Note:** XVM on SGI Foundation Software does not support real-time subvolumes.

---

3. Click **OK**.

## Grow a Filesystem with the GUI

This task lets you grow a mounted filesystem.

---

**Note:** In order to grow a filesystem, you must first increase the size of the logical volume on which the filesystem is mounted. For information on modifying XVM volumes, see the *XVM Volume Manager Administrator's Guide*.

---

To grow a filesystem, do the following:

1. Enter the following information:
  - **Filesystem:** Select the name of the filesystem you want to grow. The list of available filesystems is determined by looking for block devices containing XFS superblocks.
  - **Specify Sizes:** Check this option to modify the default options for the filesystem, including data region size and (if already present for the filesystem) log size.

By default, the filesystem will be created with the data region size equal to the size of the data subvolume. If the volume contains a log subvolume, the log size will be set to the size of the log subvolume.

2. If you checked the **Specify Sizes** box, click **Next** to move to page 2. For more information about these fields, see the `mkfs.xfs` man page.
  - **Data Region Size:** Enter the size of the data region of the filesystem as a number of 512-byte blocks. This number is usually equal to the size of the data subvolume. You should specify a size other than 0 only if the filesystem should occupy less space than the size of the data subvolume.
  - **Log Size:** Enter the size of the log section of the filesystem as a number of 512-byte blocks. You should specify a size other than 0 only if the log should occupy less space than the size of the log subvolume. This option only appears if the filesystem has a log subvolume.

---

**Note:** XVM on SGI Foundation Software does not support real-time subvolumes.

---

3. Click **OK**.

## Define CXFS Filesystems with the GUI

This task lets you define one or more CXFS filesystems having the same ordered list of potential metadata servers and the same list of client nodes.

---

**Note:** The list of potential metadata servers for a given filesystem is ordered, but because of network latencies and other unpredictable delays, it is impossible to predict which node will become the active metadata server for the initial mount of a filesystem.

---

If you select multiple device names, the path you enter for the mount point will be used as a prefix to construct the actual mount point for each filesystem.

This task assumes that you have created volume headers on your disk drives, created the XVM logical volumes, and made the filesystems. "Initial Setup with the CXFS GUI" on page 143.

To define filesystems, do the following:

1. Enter the following information:

- **Device Name:** Select the device names of the XVM volumes on which the filesystems will reside.

---

**Note:** Within the GUI, the default is to use the last portion of the device name; for example, for a device name of `/dev/cxvm/d761un0s0`, the GUI will automatically supply a logical filesystem name of `d761un0s0`. The GUI will accept other logical names defined with `cxfs_admin` but the GUI will not allow you to modify a logical name; you must use `cxfs_admin` to modify the logical name.

---

- **Mount Point:** The directory on which the specified filesystem will be mounted. This directory name must begin with a slash (/). The same mount point will be used on all the nodes in the cluster. For example, if you select the device name `/dev/cxvm/cxfs1` and want to mount it at `/mount/cxfs1`, you would enter `/mount/cxfs1` for the **Mount Point** value.

If you selected multiple device names in order to define multiple CXFS filesystems, the mount point path will be constructed using the mount point you enter as a **prefix** and the name of each device name (not including the `/dev/cxvm` portion) as the suffix. For example, if you select two volume device names (`/dev/cxvm/cxfs1` and `/dev/cxvm/cxfs2`) and enter a mount point of `/mount/`, then the CXFS filesystems will be mounted as `/mount/cxfs1` and `/mount/cxfs2`, respectively. If instead you had entered `/mount` for the mount point, the filesystems would be mounted as `/mountcxfs1` and `/mountcxfs2`.

For more information, see the `mount` man page.

- **(Optional) Mount Options:** These options are passed to the `mount` command and are used to control access to the specified XVM volume. Separate multiple options with a comma. For a list of the available options, see the `fstab` man page.
- **Force Unmount:** Select the default behavior for the filesystem. This option controls what action CXFS takes if there are processes that have open files or current directories in the filesystems that is to be unmounted. If you select **On**, the processes will be killed and the unmount will occur. If you select **Off**, the processes will not be killed and the filesystem will not be unmounted. SGI

recommends that you set **Force Unmount** to **On** in order to improve the stability of the CXFS cluster. This value can be overridden when you perform a manual unmount; see "Unmount CXFS Filesystems with the GUI" on page 215.

- **Metadata Servers:** A list of server-capable administration nodes that are able to act as metadata servers.

To add a server-capable administration node to the list of servers, choose a name from the pull-down node list and click **Add**. To select all nodes listed, click **Add All**.

---

**Note:** Relocation is disabled by default. Recovery and relocation are supported only when using standby nodes. Therefore, you should only define multiple metadata servers for a given filesystem if you are using the standby node model. See "Relocation" on page 26.

---

To remove a node from the list of servers, click the name in the list to select it and then click **Remove**.

---

**Note:** The order of servers is significant. The first node listed is the preferred metadata server. Click a logical name to select it and then click the arrow buttons to arrange the servers in the order that they should be used.

However, it is impossible to predict which server will actually become the server during the boot-up cycle because of network latencies and other unpredictable delays. The first available node in the list will be used as the active metadata server.

---

- **Enable Mount on:** A choice of either all nodes in the cluster or a list of selected server-capable administration nodes that you specify on a second page. (The filesystem is always mounted on the current metadata server.)
- **If Nodes are Added to the Cluster Later:** This option permits the filesystem to be mounted on all nodes that might be added to the cluster at some later date. This option is selected by default.
- If you chose **Only Selected Nodes** above, click **Next** to move to the second page of the task.

**Selected Nodes:** You can select the desired nodes from the **Node** list. You can also click **Add All** to select all nodes, which is the same as selecting **All Nodes Currently in Cluster**.

2. Click **OK**.

After defining the filesystems, you can mount them on the specified client nodes in the cluster by running the **Mount CXFS Filesystems** task.

---

**Note:** After a filesystem has been defined in CXFS, running `mkfs` on it (or using the "Make Filesystems with the GUI" on page 207 task) will cause errors to appear in the system log file. To avoid these errors, run `mkfs` before defining the filesystem in CXFS, or delete the CXFS filesystem before running `mkfs`. See "Delete a CXFS Filesystem with the GUI" on page 216.

---

## Modify a CXFS Filesystem with the GUI

---

**Note:** You cannot modify a mounted filesystem.

---

To modify an existing filesystem, do the following:

1. Enter the following information:
  - **Filesystem to Modify:** Choose a filesystem from the pull-down menu. This displays information for that filesystem in the various fields.
  - **Mount Point and Mount Options:** Change the information displayed for the selected filesystem as needed. To erase text, backspace over the text or select the text and type over it.
  - **(Optional) Mount Options:** These options are passed to the `mount` command and are used to control access to the specified XVM volume. For a list of the available options, see the `fstab` man page.
  - **Metadata Servers:**
    - To delete a node from the list of servers, click its name and then click **Delete**.
    - To add a new server-capable administration node to the list of servers, select it from the pull-down list and click **Add**. To select all server-capable

administration nodes, select **Add All**. The list for a given filesystem must consist of nodes running the same operating system.

- To rearrange the priority of a server, select it by clicking its name and then click the arrow buttons as needed.

---

**Note:** The list of potential metadata servers for a given filesystem is ordered, but because of network latencies and other unpredictable delays, it is impossible to predict which node will become the active metadata server for the initial mount of a filesystem.

---

- **Enable Mount on:** A choice of either all nodes in the cluster or a list of selected nodes that you specify on a second page. (The filesystem is always mounted on the current metadata server.)
- **If Nodes are Added to the Cluster Later:** This option permits the filesystem to be mounted on all nodes that might be added to the cluster at some later date. This option is selected by default.
- If you chose **Only Selected Nodes** above, click **Next** to move to the second page of the task.  
**Selected Nodes:** You can select the desired nodes from the **Node** list. You can also click **Add All** to select all nodes, which is the same as selecting **All Nodes Currently in Cluster**.

2. Click **OK**.

## Mount CXFS Filesystems with the GUI

To mount existing filesystems on all of their client nodes, do the following:

1. **Filesystem to Mount:** Choose the filesystem to be mounted.
2. Click **OK**.

If CXFS services are not active, mounting a filesystem will not completely succeed. The filesystem will be marked as ready to be mounted and a warning message will be displayed in the **Mount a Filesystem** task. The filesystem will not actually be mounted until you have started CXFS services. For information, see "Start CXFS Services with the GUI" on page 197.

## Unmount CXFS Filesystems with the GUI

To unmount filesystems from all of their client nodes, do the following:

1. Enter the following information:
  - **Filesystem to Unmount:** Choose the filesystems to be unmounted.
  - **Force Unmount:** Click **On** to force an unmount for all selected filesystems (no matter how they have been defined) or **Default** to force an unmount for those filesystems that have the forced unmount option set in their definition.

This option controls what action CXFS takes if there are processes that have open files or current directories in the filesystems that are to be unmounted. If forced is used (by selecting **On** or by selecting **Default** if force is the default behavior), the processes will be killed and the unmount will occur. If you select **Off**, the processes will not be killed and the filesystem will not be unmounted. The option is set to **Default** by default.

2. Click **OK**.

## Mount a Filesystem Locally

This task lets you mount a filesystem only on the node to which the GUI is connected (the local node).

To mount a filesystem locally, do the following:

1. Enter the following information:
  - **Filesystem to Mount:** Select the filesystem you wish to mount. The list of available filesystems is determined by looking for block devices containing XFS superblocks.
  - **Mount Point:** Specify the directory on which the selected filesystem will be mounted.
  - *(Optional)* **Mount Options:** Specify the options that should be passed to the `mount` command. For more information about available options, see the `fstab` man page.
2. By default, the filesystem will remount every time the system starts. However, if you uncheck the box, the mount will take place only when you explicitly use this task.

3. Click **OK**.

For more information, see the `mount` man page.

## Unmount a Local Filesystem

To unmount a filesystem from the local node, do the following:

1. Enter the following information:
  - **Filesystem to Unmount:** Choose the filesystem to be unmounted.
  - **Remove Mount Information:** Click the check box to remove the mount point from the `/etc/fstab` file, which will ensure that the filesystem will remain unmounted after the next reboot. This item is available only if the mount point is currently saved in `/etc/fstab`.
2. Click **OK**.

## Delete a CXFS Filesystem with the GUI

You cannot delete a filesystem that is currently mounted. To unmount a filesystem, see "Unmount CXFS Filesystems with the GUI" on page 215.

To permanently delete an unmounted filesystem, do the following:

1. **Filesystem to Delete:** Choose the name of the filesystem from the pull-down list.
2. Click **OK**.

## Remove Filesystem Mount Information

This task lets you delete a local filesystem's mount information in `/etc/fstab`.

---

**Note:** The filesystem will still be present on the volume.

---



Do the following:

1. **Filesystem Name:** Select the filesystem for which you want to remove mount information. The list of available filesystems is determined by looking for block devices containing XFS superblocks.
2. Click **OK**.

### Relocate a Metadata Server for a CXFS Filesystem with the GUI

If relocation is explicitly enabled in the kernel with the `cxfs_relocation_ok` systune, you can relocate the metadata server for a filesystem to any other potential metadata server in the list (see "Relocation" on page 26). The filesystem must be mounted on the system to which the GUI is connected.

1. Enter the following information:
  - **Filesystem:** Select the desired filesystem from the list.
  - **Current Metadata Server:** The current metadata server will be displayed for you.
  - **New Metadata Server:** Select the desired node from the list.

The selected server will assume responsibility for moderating access to the selected filesystem **after** you run the **Start CXFS Services** task; see "Start CXFS Services with the GUI" on page 197.

2. Click **OK** to complete the task.

CXFS kernel membership is not affected by relocation. However, users may experience a degradation in filesystem performance while the metadata server is relocating.

## Privileges Tasks with the GUI

The privileges tasks let you grant specific users the ability to perform specific tasks and to revoke those privileges.

---

**Note:** You cannot grant or revoke tasks for users with a user ID of 0.

---

This section discusses the following:

- "Grant Task Access to a User or Users" on page 218
- "Revoke Task Access from a User or Users" on page 221

### Grant Task Access to a User or Users

You can grant access to a specific task to one or more users at a time.

---

**Note:** Access to the task is only allowed on the node to which the GUI is connected; if you want to allow access on another node in the pool, you must connect the GUI to that node and grant access again.

---

Do the following:

1. Select the user or users for whom you want to grant access. You can use the following methods to select users:
  - Click to select one user at a time
  - Shift+click to select a block of users
  - Ctrl+click to toggle the selection of any one user, which allows you to select multiple users that are not contiguous
  - Click **Select All** to select all usersClick **Next** to move to the next page.
2. Select the task or tasks to grant access to, using the above selection methods. Click **Next** to move to the next page.
3. Confirm your choices by clicking **OK**.

---

**Note:** If more tasks than you selected are shown, then the selected tasks run the same underlying privileged commands as other tasks, such that access to the tasks you specified cannot be granted without also granting access to these additional tasks.

---

To see which tasks a specific user can access, select **View: Users**. Select a specific user to see details about the tasks available to that user.

To see which users can access a specific task, select **View: Task Privileges**. Select a specific task to see details about the users who can access it and the privileged commands it requires.

### Granting Access to a Few Tasks

Suppose you wanted to grant user `diag` permission to define, modify, and mount CXFS filesystems. You would do the following:

1. Select `diag` and click **Next** to move to the next page.
2. Select the tasks you want `diag` to be able to execute:
  - a. Ctrl+click **Define CXFS Filesystem**
  - b. Ctrl+click **Modify CXFS Filesystem**
  - c. Ctrl+click **Mount CXFS Filesystem**

Click **Next** to move to the next page.

3. Confirm your choices by clicking **OK**.

Figure 10-6 shows the tasks that `diag` can now execute. This screen is displayed when you select **View: Users** and click `diag` to display information in the details area of the GUI window. The privileged commands listed are the underlying commands executed by the GUI tasks.

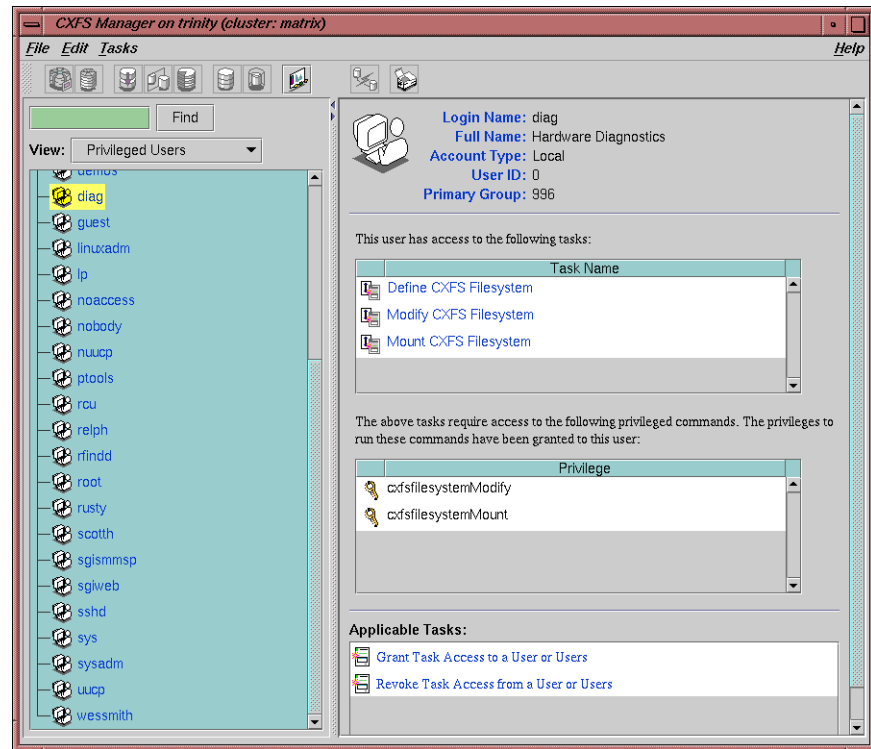


Figure 10-6 Task Privileges for a Specific User

### Granting Access to Most Tasks

Suppose you wanted to give user `sys` access to all tasks **except** changing the cluster contents (which also implies that `sys` cannot delete the nodes in the cluster, nor the cluster itself). The easiest way to do this is to select all of the tasks and then deselect the few you want to restrict. You would do the following:

1. Select `sys` and click **Next** to move to the next page.
2. Select the tasks you want `sys` to be able to execute:
  - a. Click **Select All** to highlight all tasks.
  - b. Deselect the task to which you want to restrict access. **Ctrl+click Add/Remove Nodes in Cluster**.

Click **Next** to move to the next page.

3. Confirm your choices by clicking **OK**.

## Revoke Task Access from a User or Users

You can revoke task access from one or more users at a time.

---

**Note:** Access to the task is only revoked on the node to which the GUI is connected; if a user has access to the task on multiple nodes in the pool, you must connect the GUI to those other nodes and revoke access again.

---

Do the following:

1. Select the user or users from whom you want to revoke task access. You can use the following methods to select users:
  - Click to select one user at a time
  - **Shift**+click to select a block of users
  - **Ctrl**+click to toggle the selection of any one user, which allows you to select multiple users that are not contiguous
  - Click **Select All** to select all users

Click **Next** to move to the next page.

2. Select the task or tasks to revoke access to, using the above selection methods. Click **Next** to move to the next page.
  3. Confirm your choices by clicking **OK**.
- 

**Note:** If more tasks than you selected are shown, then the selected tasks run the same underlying privileged commands as other tasks, such that access to the tasks you specified cannot be revoked without also revoking access to these additional tasks.

---

To see which tasks a specific user can access, select **View: Users**. Select a specific user to see details about the tasks available to that user.

To see which users can access a specific task, select **View: Task Privileges**. Select a specific task to see details about the users who can access it.

## **cxfs\_admin Command**

This chapter discusses the following:

- "cxfs\_admin Overview" on page 223
- "Node Tasks with cxfs\_admin" on page 239
- "Cluster Tasks with cxfs\_admin" on page 257
- "CXFS Filesystem Tasks with cxfs\_admin" on page 263
- "Network Failover Tasks with cxfs\_admin" on page 271
- "Switch Tasks with cxfs\_admin" on page 272
- "Fencing Tasks with cxfs\_admin" on page 277
- "Saving and Recreating the Current Configuration with cxfs\_admin" on page 279

### **cxfs\_admin Overview**

To use the `cxfs_admin` command, you must be logged in to a node that has permission to access the CXFS cluster database. See "Setting `cxfs_admin` Access Permissions" on page 230.

To make configuration changes using `cxfs_admin`, you must be logged in as `root` and execute `cxfs_admin` on a node with `admin` permission and in write mode. To perform some operational tasks, you must in addition execute `cxfs_admin` directly on a server-capable administration node. See "Making Changes Safely" on page 229

---

**Note:** For the steps to create a cluster for the first time, see "Initial Setup with the `cxfs_admin` Command" on page 148.

---

This section discusses the following:

- "Starting `cxfs_admin`" on page 224
- "Syntax of Commands within `cxfs_admin`" on page 225
- "Setting `cxfs_admin` Defaults" on page 227

- "Making Changes Safely" on page 229
- "Setting cxfs\_admin Access Permissions" on page 230
- "Accessing the Correct Cluster at a Multiple-Cluster Site" on page 232
- "Getting Help" on page 232
- "Basic and Advanced Mode" on page 234
- "Using Prompting Mode" on page 236
- "Command History" on page 237
- "Waiting for Commands to Complete" on page 237
- "Entering cxfs\_admin Commands on the Command Line" on page 238
- "Using cxfs\_admin Script Files" on page 238
- "Exiting from cxfs\_admin" on page 239

## Starting cxfs\_admin

To execute cxfs\_admin in the default read-only mode, enter the following:

```
# /usr/cluster/bin/cxfs_admin
```

To execute cxfs\_admin in write mode, enter the following:

```
# /usr/cluster/bin/cxfs_admin -A
```

If no other user already holds the cxfs\_admin lock, you will be given the lock by default when executing cxfs\_admin in write mode. You can make executing cxfs\_admin in write mode the default by setting the write\_mode parameter in the \$HOME/.cxfs\_admin file; see "Setting cxfs\_admin Defaults" on page 227.

See also:

- "Making Changes Safely" on page 229
- "Entering cxfs\_admin Commands on the Command Line" on page 238
- "Setting cxfs\_admin Access Permissions" on page 230
- "Accessing the Correct Cluster at a Multiple-Cluster Site" on page 232



## Syntax of Commands within `cxfs_admin`

Some `cxfs_admin` commands affect the `cxfs_admin` operating environment itself, some display status information, and others affect objects or classes. Within `cxfs_admin`, an *object* is a specific item that is configured in the CXFS cluster and a *class* contains a group of similar objects. For example, the filesystem names `fs1` and `fs2` would both be objects within the `filesystem` class.

Within a class, all objects must have unique names. If all objects in the cluster have unique names, you can abbreviate some commands by omitting the class name. However, if two or more objects in the cluster database have the same name, you must specify the class in order to uniquely identify the object.

The command syntax is:

```
command [[class:]object] [attributes]
```

where *attributes* takes a number of formats depending on the context, such as the following:

```
attribute
attribute=value
attribute=value1,value2,value3..
```

The actual syntax components for any given command vary, based on the needs of the command. For example, the following command requires no parameters to see a summary of the cluster:

```
cxfs_admin:mycluster> show
```

If an object name is unique within the cluster database, you can omit its class name. For example, if the name `nodeA` is unique within the database:

```
cxfs_admin:mycluster> show nodeA
```

However, if there were multiple objects named `production`, you must enter the class name:

```
cxfs_admin:mycluster> show node:production
```

Classes and objects may include the following shell-style wildcard characters:

```
*
?
[...]
```

---

**Note:** You can use the asterisk (\*) alone with the `show` and `config` commands in place of the *object* to apply the command to the entire cluster. If you do not specify any attributes, you can even omit the \* character.

For commands that will change the cluster database, however, SGI recommends that you also include at least one other character in the object's name to ensure that you act upon only the intended objects. For example, if you wanted to unmount both `myfileA` and `yourfileB`, you could enter `umount *file*`.

---

Command names and attribute names are not case-sensitive. However, all attribute values other than the node name (in `create node nodename`) and the switch name (in `create switch switchname`) are case sensitive.

You can see possible attributes by pressing the <TAB> key after entering the command or object. For example:

```
cxfs_admin:mycluster> create filesystem <TAB>
Required attributes:
  name= : A string

Optional attributes:
  forced_unmount= : True/false or enabled/disabled (default is "false")
  grio_managed=   : True/false or enabled/disabled (default is "false")
  mounted=       : True/false or enabled/disabled (default is "true")
  mountpoint=    : A pathname
  options=       : Nothing, one or more strings (can be empty)
```

The required attributes are listed first followed by optional attributes. The list of attributes will differ depending upon the complexity mode; see "Basic and Advanced Mode" on page 234.

Partially typing in the attribute name and pressing <TAB> will complete the attribute name (if unique) or show a list of matching attribute names. To see what kind of values are required for an attribute, press <TAB> after the = sign. For example:

```
cxfs_admin:mycluster> create node os=<TAB>
Linux      MacOSX   Unknown  Windows
```

Use `$` to refer to the object in the last command that you entered at the `cxfs_admin` prompt. For example, to delete `nodeA` (if it has a unique name within the cluster database):

```
cxfs_admin:mycluster> disable nodeA
cxfs_admin:mycluster> delete $
```

To specify multiple objects, separate them with a comma. For example:

```
cxfs_admin:mycluster> show nodeA,nodeB
```

You can abbreviate commands, objects, and attributes by entering the first character or two followed by pressing the `<TAB>` key. If more than one match is available, `cxfs_admin` shows a list of the possible matches.

## Setting `cxfs_admin` Defaults

You can use one of the following methods to set the defaults for the way that `cxfs_admin` behaves, shown in the order of their precedence:

1. Use the `set` command within `cxfs_admin`:

```
set
  editor=emacs|vi           (emacs)
  line_wrap=true|false     (true)
  mode=basic|advanced      (basic)
  stop_on_error=true|false (true)
```

For example, to change to `vi`:

```
cxfs_admin:mycluster> set editor=vi
```

Usage notes:

- `editor` specifies the editor style (`emacs` or `vi`). The default is `emacs`.
- `line_wrap` specifies the ability to wrap a line at the edge of the current window (`true`) or no line wrap (`false`). The default is `true`.
- `mode` determines whether prompting and output will show only those values that are required (`basic`) or all values (`advanced`). The default is `basic`. See "Basic and Advanced Mode" on page 234.

- `stop_on_error` will abort a command upon encountering an error (true) or keep going (false). The default is true.
2. Set the environment variables discussed in Table 11-1.

**Table 11-1** cxfs\_admin Environment Variables

Environment Variable	Values
<code>CXFS_ADMIN_CLUSTER_NAME</code>	<i>clustername</i> . Setting this value lets you bypass using the <code>-i</code> option if you have multiple clusters connected to the same public network, or want to use <code>cxfs_admin</code> from a node that is not part of the cluster. There is no default.
<code>CXFS_ADMIN_EDITOR</code>	emacs (default) or vi.
<code>CXFS_ADMIN_LINE_WRAP</code>	true (default) or false.
<code>CXFS_ADMIN_MODE</code>	basic (default) or advanced.
<code>CXFS_ADMIN_STOP_ON_ERROR</code>	true (default) or false.
<code>CXFS_ADMIN_WRITE_MODE</code>	true or false (default), which specifies whether <code>cxfs_admin</code> will attempt to obtain the lock (enter write mode) by default (similar to entering <code>-A</code> on the <code>cxfs_admin</code> command line). To obtain the lock, the host on which <code>cxfs_admin</code> is executed must also have admin access permission and you must be logged in as root. (See "Setting <code>cxfs_admin</code> Access Permissions" on page 230.)

3. Use the `.cxfs_admin` file in your home directory (as defined by the `HOME` environment variable) to set any of the following:

```
cluster_name=clustername
editor=emacs|vi
line_wrap=true|false
mode=basic|advanced
stop_on_error=true|false
write_mode=true|false
```

Lines within the `.cxfs_admin` file that begin with the `#` character or a space are ignored, as are lines that do not contain the `=` character.

For example, to use the `mycluster` cluster in advanced mode and the `vi` editor by default, include the following in your (or `root`) `$HOME/.cxfs_admin` file:

```
# My settings for cxfs_admin:
cluster=mycluster
mode=advanced
editor=vi
```

## Making Changes Safely

This section discusses the following safety features of `cxfs_admin`:

- "Read-Only Mode by Default" on page 229
- "Making Changes Requires Both Write Mode and `admin` Permission" on page 229
- "Stealing the Lock" on page 230
- "Giving Up the Lock" on page 230

### Read-Only Mode by Default

By default, `cxfs_admin` executes in read-only mode, in which the `cxfs_admin` lock is not set. The lock permits only one user at a time can make changes via `cxfs_admin`.



**Caution:** The `cxfs_admin` lock does not prevent other users from using the CXFS GUI while `cxfs_admin` is running. You should make database changes with only one instance of the CXFS GUI or `cxfs_admin` command at any given time.

---

In read-only mode, you can view the cluster status but you cannot make changes. The `cxfs_admin` prompt identifies that you are in read-only mode.

### Making Changes Requires Both Write Mode and `admin` Permission

To make changes to the cluster database, you must be logged in as `root` to a host that has `admin` access permission (see "Setting `cxfs_admin` Access Permissions" on page 230) and be in write mode. Do one of the following as `root` when `cxfs_admin` is connected to a node with `admin` access:

- Use the `-A` option on the `cxfs_admin` command line to override the default setting for this instance of the `cxfs_admin` process.

- Use the `.cxfs_admin` file or the `CXFS_ADMIN_WRITE_MODE` environment variable to permanently override the default setting (making it unnecessary to enter `-A` on the command line). See "Setting `cxfs_admin` Defaults" on page 227.
- Invoke `cxfs_admin` as normal but then request the lock:

```
cxfs_admin:mycluster> lock
```

### Stealing the Lock

If you request the lock but it is already held by another user, you will enter in read-only mode. To forcefully obtain the lock from someone else, you can use the `steal` attribute with the `lock` command. For example:

```
cxfs_admin:mycluster (read only) > lock
Event at [ Oct 21 15:58:02 ]
The administration lock is already held by root@node2 (pid=48449)
cxfs_admin:mycluster (read only) > lock steal=true
Event at [ Oct 21 15:58:03 ]
The administration lock has been stolen from root@node2 (pid=48449)
cxfs_admin:mycluster>
```

If someone holds the lock while you are using `cxfs_admin` but later drops it, you can obtain the lock by entering `lock` (there is no need to steal the lock at this point).

### Giving Up the Lock

To give up the lock, use the `unlock` command. For example:

```
cxfs_admin:mycluster> unlock
Event at [ Oct 21 15:58:02 ]
cxfs_admin:mycluster (read only) >
```

### Setting `cxfs_admin` Access Permissions

The `access` command lets you specify hosts that have permission to modify the cluster configuration and hosts that have permission to monitor the cluster state:

```
access
  allow=hostname_or_IPaddress_list
  permission=admin|monitor           (monitor, only available with allow)
  deny=server_name
```

By default, all server-capable administration nodes in the cluster are granted `admin` access (without using the `access` command).

For example, to grant `remotehostA` and `remotehostB` permission to modify the cluster configuration:

```
cxfs_admin:mycluster> access allow=remotehostA,remotehostB permission=admin
```

To grant read-only rights in order to monitor to the cluster configuration and status (`monitor` is the default access level):

```
cxfs_admin:mycluster> access allow=remotehostA
```

To revoke all access to the cluster database for a host that was previously granted some level of access, use the following command:

```
cxfs_admin:mycluster> access deny=remotehostA,remotehostB
```

To view the current access rights, use the following command:

```
show access
```

For example:

```
cxfs_admin:mycluster> show access
Event at [ Oct 21 15:58:02 ]
access:
  admin=server
  monitor=cluster
```

Usage notes:

- `allow` specifies the hosts to be granted the specified permission. These hosts must be on the same private network as the cluster nodes. To specify multiple hosts, use a comma-separated list. There are three reserved hostnames:
  - `cluster` denotes any node defined in the cluster
  - `server` denotes any server-capable administration node, even one that is disabled from CXFS membership (see "Disable a Node with `cxfs_admin`" on page 251)
  - `any` denotes any system that is on the private network

- `permission` specifies:
  - `admin` provides the ability to view and change the cluster database and perform administrative actions (if `cxfs_admin` was started in write mode and you are logged in as `root`). This is the default for all server-capable administration nodes.
  - `monitor` provides the ability only to view the current status of the cluster and the current definitions in the cluster database. This is the default for all client-only nodes.
- `deny` specifies the hosts to be denied all access to the cluster database (for hosts that were previously granted some level of access). To specify multiple hosts, use a comma-separated list. The same reserved hostnames as `allow` apply.

### Accessing the Correct Cluster at a Multiple-Cluster Site

If you have multiple clusters connected to the same public network, use the `-i` option to identify the cluster name:

```
cxfs_admin -i clustername
```

For example, for the cluster named `mycluster`:

```
server-admin# /usr/cluster/bin/cxfs_admin -i mycluster
```

On each client-only node, add `-i clustername` to the `cxfs_client.options` file. For more information about the `cxfs_client.options` file, see *CXFS 6 Client-Only Guide for SGI InfiniteStorage*.

---

**Note:** CXFS does not support multiple clusters on the same **private** network.

---

### Getting Help

At any time, you can enter `help` or `?` to see help text.

To see help for a given topic:

```
help topicname
```



The list of general topics includes the following:

- attributes
- commandline
- commands
- cxfs
- objects
- overview
- setup
- syntax
- tasks
- waiting

There is also help for each `cxfs_admin` command. For example, to see help about the `create` command:

```
cxfs_admin:mycluster> help create
```

To see all of the available help topics, press the <TAB> key:

```
cxfs_admin:mycluster> help <TAB>
```

To see a list of available commands for an object, such as a class like `filesystem` or a specific instance of a class like the `filesystem myfs`, use the `ops` (operations) command:

```
ops object
```

For example:

```
cxfs_admin:mycluster> ops filesystem
Event at [ Oct 21 15:58:02 ]
Commands for "filesystem":
  create, ops, show
cxfs_admin:mycluster> ops myfs
Event at [ Oct 21 15:58:03 ]
Commands for "filesystem:myfs":
  delete, modify, mount, ops, show, unmount
```

You can also use the `clconf_info` tool to view status. See Chapter 14, "Monitoring Status" on page 363.

For help with error messages, see "cxfs\_admin Errors" on page 439.

## Basic and Advanced Mode

The `cxf_s_admin` command operates in two complexity modes:

- **Basic mode**, which:
  - Shows only the required options and attributes in `show` output
  - Provides a list of possible choices when using the `<TAB>` key
  - Uses prompting for only the required fields
- **Advanced mode**, which:
  - Provides a list of possible choices when using the `<TAB>` key
  - Prompts for all possible fields, displays all attributes
  - Includes debugging information in output

---

**Note:** You should only use the advanced-mode commands and attributes at the advice of SGI support. Using the advanced mode commands or changing advanced mode attributes may induce unexpected behavior.

---

Advanced-mode commands and attributes are not included in prompts or `<TAB>` key completion when you are in basic mode. However, you can still manually enter an advanced attribute if you know it, even in basic mode. The advanced-mode commands and attributes are noted in their help topics.

You can enter advanced mode by using `cxf_s_admin -a` on the command line or by entering the following `cxf_s_admin` command:

```
cxf_s_admin:mycluster> set mode=advanced
```

To return to basic mode:

```
cxf_s_admin:mycluster> set mode=basic
```

For example, the following output shows only the basic-mode information for the node named `cxf_sxe5`:

```
cxf_s_admin:clusterOne> set mode=basic
Event at [ Oct 20 12:32:44 ]
Mode is set to basic
cxf_s_admin:clusterOne> show cxf_sxe5
```

```
Event at [ Oct 20 12:32:54 ]
node:cxfsxe5:
  cellid=1
  enabled=true
  os=Linux
  private_net:
    10.0.199.1
  status:
    age=23
    connected=true
    fencing=Stable
    license:
      have_license=true
    summary=Stable
    version=6.0.0.3
    wwns:
      210000e08b123d95
  type=server_admin
```

---

**Note:** The `have_license` field reports licenses for client-only nodes that have been obtained from the server. It does not display information about the server licenses. For more information about licensing, see "Show License Information with `cxfs_admin`" on page 262.

---

For example, the following output shows all information that is available in advanced mode for `cxfsxe5`:

```
cxfs_admin:clusterOne > set mode=advanced
Event at [ Oct 20 12:33:48 ]
Mode is set to advanced
cxfs_admin:clusterOne> show cxfsxe5
Event at [ Oct 20 12:33:53 ]
node:cxfsxe5:
  autoconf=false
  cellid=1
  clustername=clusterOne
  enabled=true
  failpolicy=Fence,Shutdown
  hostname=cxfsxe5.americas.sgi.com
  nodeid=1
  os=Linux
```

```
private_net:
  10.0.199.1
status:
  age=23
  build=07:39:08 Sep 22 2009
  connected=true
  fencing=Stable
  license:
    have_license=true
  member=true
  stable=true
  summary=Stable
  version=6.0.0.3
  wwns:
    210000e08b123d95
type=server_admin
```

---

**Note:** If a client is not connected to the cluster, the `build` and `version` fields will not display because the node cannot respond to for requests for this information.

---

## Using Prompting Mode

Some `cxfs_admin` commands will prompt you for required attributes if you press `ENTER` after the command name. To see information about the legal values for an attribute, press `<TAB>` after a question.

For example:

```
cxfs_admin:clusterOne> create <RETURN>
What do you want to create? The following can be used:
  autoconf, cluster, failover_net, filesystem, node, switch
```

In basic mode, you are only prompted for required parameters. To be prompted for all possible parameters, use advanced mode. See "Basic and Advanced Mode" on page 234.

Depending upon the context, `cxfs_admin` prompts will vary based upon your answers to previous prompts. For example, if you specify that a node's `type` value is `client-only`, `cxfs_admin` will prompt you for the operating system.

To exit from prompt mode, send an interrupt signal (typically, press `Ctrl-C`).

## Command History

The `history` command displays a list of commands that have been used in `cxfs_admin` since it was started:

- Display all of the commands (up to the previous 1000 commands):

```
history
```

- Limit the commands to the last specified number of items:

```
history num=number_of_items
```

For example, to display only the last 10 commands:

```
cxfs_admin:mycluster> history num=10
```

- Clear the history:

```
history clear
```

- Send the history to a file (you must enter the full pathname of the file):

```
history output=full_pathname
```

For example, to send the history output to the file `/tmp/myhistory`:

```
cxfs_admin:mycluster> history output=/tmp/myhistory
```

## Waiting for Commands to Complete

Some commands in `cxfs_admin` take a noticeable period of time to complete. `cxfs_admin` displays informational updates as a command progresses or a period character if nothing has changed within 2 seconds.

After 1 minute without change, a command will terminate. This may happen when there is a problem in creating or modifying a node or filesystem. The update message shows the problem status.

To interrupt a command, send an interrupt signal (usually `Ctrl-C`).

## Entering cxfs\_admin Commands on the Command Line

You can enter `cxfs_admin` commands directly from the `cxfs_admin` command line by using the `-c` option, as follows:

```
server-admin# /usr/cluster/bin/cxfs_admin -c "cxfs_admin_commands"
```

## Using cxfs\_admin Script Files

You can execute a series of `cxfs_admin` commands by using the `-f` option and specifying an input file:

```
server-admin# /usr/cluster/bin/cxfs_admin -f command_file
```

For example, suppose the file `/tmp/showme` contains the following:

```
cxfs6# more /tmp/showme
show access
set
```

You can execute the following command, which will yield the indicated output: (line breaks shown for readability):

```
# /usr/cluster/bin/cxfs_admin -f /tmp/showme
Connecting to the CXFS server for the "clusterOne" cluster...
Event at [ Oct 20 12:49:17 ]
access:
    admin=server
    monitor=cluster
Event at [ Oct 20 12:49:17 ]
mode=basic
editor=emacs
line_wrap=false
stop_on_error=true
```

---

**Note:** To make changes, you must execute `cxfs_admin` in write mode, such as by using the `-A` option. See "Making Changes Requires Both Write Mode and admin Permission" on page 229.

---

## Exiting from `cxfs_admin`

To exit from prompt mode, send an interrupt signal (typically, press `Ctrl-C`).

To exit out of the `cxfs_admin` session, enter `exit` or `quit` at the `cxfs_admin` command line:

```
cxfs_admin:mycluster> exit
```

## Node Tasks with `cxfs_admin`

This section discusses the following:

- "Automatically Configure a Client-Only Node" on page 239
- "Create or Modify a Node with `cxfs_admin`" on page 242
- "Delete a Node with `cxfs_admin`" on page 250
- "Enable a Node with `cxfs_admin`" on page 251
- "Disable a Node with `cxfs_admin`" on page 251
- "Show Node Information with `cxfs_admin`" on page 251
- "Enable or Disable CXFS Kernel Membership (`cmsd`) for the Local Node" on page 255
- "Control and Contact a Node with `cxfs_admin`" on page 255

---

**Note:** The entire cluster status information is sent to each server-capable administration node each time a change is made to the cluster database; therefore, the more server-capable administration nodes in a configuration, the longer it will take.

---

## Automatically Configure a Client-Only Node

The `autoconf` class creates a rule that determines whether the specified new client-only nodes can be automatically configured into the CXFS cluster database. This is known as *easy client configuration*.

---

**Note:** The `autoconf` action only applies to hosts that are not currently defined in the cluster database.

---

You can specify a single hostname and/or a range of IP addresses to be allowed (*whitelisted*) or disallowed (*blacklisted*). Only those nodes specified in a whitelist and not specified in a blacklist can be automatically configured. (That is, the blacklist has higher priority than the whitelist.)

Each `autoconf` rule must have a unique name. By default, only nodes that are defined by an `autoconf` rule set to `enable_node=true` will be defined as enabled and will be allowed to join the cluster. (If you set `enable_node=false`, the node will be defined in the database but disabled/inactive.)

- To create a new rule (line breaks shown here for readability):

```
create autoconf
  rule_name=rulename
  policy=allowed|disallowed           (allowed)
  hostname=hostname
  startIP=startingIPAddress
  endIP=endingIPAddress
  enable_node=true|false              (true)
```

- To change an existing rule:

```
modify [allowed:|disallowed:] rulename
```

- To delete an existing rule:

```
delete [allowed:|disallowed:] rulename
```

- To show an existing rule:

```
show [allowed:|disallowed:] rulename
```

- To show all existing rules:

```
show autoconf
```

- To show all allowed rules, which displays the rules for client-only nodes that are allowed to be automatically configured (whitelisted):

```
show allowed
```



- To show all disallowed rules, which displays the rules for client-only nodes that are explicitly not allowed to be automatically configured (blacklisted):

```
show disallowed
```

For example, suppose you want to let nodes `NodeA` and `NodeB` to be automatically configured and enabled in the cluster. You would create two rules:

```
cxfs_admin:mycluster> create autoconf rule_name=ruleNodeA policy=allowed hostname=NodeA enable_node=true
cxfs_admin:mycluster> create autoconf rule_name=ruleNodeB policy=allowed hostname=NodeB enable_node=true
```

If you then wanted to change the rule so that `NodeA` could not be automatically configured, you would modify the autoconf rule named `ruleNodeA`:

```
cxfs_admin:mycluster> modify autoconf rule_name=ruleNodeA policy=disallowed hostname=NodeA
```

---

**Note:** If `NodeA` was already defined in the cluster database, this would have no affect. The autoconf rules apply only to nodes that are not currently defined.

---

In this case, you could also delete `ruleNodeA`, because not listing a node in an autoconf allow rule is the same as disallowing it.

Suppose all of your client-only nodes have IP addresses within the range 192.168.0.1 through 192.168.0.20. To let all of the nodes be configured automatically except for the node named `bert`, you would need to create two rules:

```
cxfs_admin:mycluster> create autoconf rule_name=allowall
policy=allowed startIP=192.168.0.1 endIP=192.168.0.20 enable_node=true
cxfs_admin:mycluster> create autoconf rule_name=rulebert policy=disallowed
```

If there is a node that is not within the IP address range that you also want to allow, you can include it in the same rule. For example, the following would allow all nodes in the range 192.168.0.1 through 192.168.0.20 plus the node named `ernie` (that is in a different IP range):

```
cxfs_admin:mycluster> create autoconf rule_name=allowall policy=allowed startIP=192.168.0.1
endIP=192.168.0.20 hostname=ernie enable_node=true
Event at [ Oct 20 12:53:50 ]
"allowall" is created. After creating all desired autoconf rules, unlock all cxfs_admin sessions to allow
the defined nodes to then be automatically configured.
```

After you have finished creating or modifying all of the desired autoconf rules, you must unlock all `cxfs_admin` sessions in order for nodes to be automatically configured. (The automatic configuration process must have access to the

cxfs\_admin lock.) If the node that is created or reconfigured via autoconf is unable to join cluster membership, you must reboot the node.

## Create or Modify a Node with cxfs\_admin

---

**Note:** Before adding a server-capable administration node, you must first unmount any filesystems for which the node will be a potential metadata server.

You should create all server-capable administration nodes before creating any client-only nodes to ensure that the server-capable administration nodes get the lowest cell IDs. The cell ID is assigned by CXFS according to the order in which the nodes are created.

---

To define a node, use the following command and attributes (line breaks shown here for readability, defaults in parentheses):

```
create node
  name=nodename
  type=client_only|server_admin           (client_only)
  os=Linux|MacOSX|Windows|Unknown        (Linux)
  private_net private_network_IPaddress_list | hostname_list

Advanced-mode:
  enabled=true|false                      (true)
  hostname=hostname                      (FQDN_of_nodename)
  nodeid=nodeID                          (assigned by cxfs_admin)
  partition_id=partition_number
  failpolicy=FenceReset, Fence, Reset, Shutdown (Fence,Shutdown)
  reset_method=nmi|powerCycle|reset       (powerCycle)
  reset_port= bmc|l2
  reset_password=password
  reset_status=enabled|disabled           (enabled)
  reset_node=server_admin_node_sending_reset_command
  reset_comms=ipmi|network|tty
  reset_device=port | IP_address_or_hostname_of_device
```

When adding the first server-capable administration node, you must restart it or restart CXFS services and cluster services on the node:

```
server-admin# service cxfs stop
server-admin# service cxfs_cluster stop

server-admin# service cxfs_cluster start
server-admin# service cxfs start
```

When you create additional nodes, they will automatically be enabled and join the cluster.

To use prompting mode, press <ENTER>. To obtain information about legal values, press <TAB>.

For example, to create a client-only node, you could do the following, pressing the <TAB> key to see the list of operating system values:

```
cxfs_admin:mycluster> create node
Specify the attributes for create node:
name? newnode
type? client_only
os? <TAB>
Linux      MacOSX    Unknown  Windows
os? macosx
private_net? 192.168.0.178
Event at [ Oct 21 15:58:02 ]
Node "newnode" has been created, waiting for it to join the cluster...
Waiting for node newnode, current status: Inactive
Waiting for node newnode, current status: Establishing membership
Waiting for node newnode, current status: Probing XVM volumes
Operation completed successfully
```

To create a server-capable administration node using the defaults, you must delete the `client_only` default for type and enter `server_admin`. For example:

```
cxfs_admin:mycluster> create node
Specify the attributes for create node:
  name? newnode
  type? server_admin
  private_net? 192.168.0.178
Event at [ Oct 21 15:58:02 ]
Node "newnode" has been created, waiting for it to join the cluster...
Please restart all cxfs and cluster services on the server "newnode" to make it
join the cluster.
```

To create a server-capable administration node in advanced mode, which can prompt you to set additional values (such as for `reset_method` and `failpolicy`):

```
cxfs_admin:mycluster> set mode=advanced
cxfs_admin:mycluster> create node
Specify the attributes for create node:
  name? newnode
  type? server_admin
  private_net? 192.168.0.178
  enabled? true
  failpolicy? Reset,Shutdown
  hostname? newnode.example.com
  nodeid? 1
  partition_id?
  reset_method? reset
  reset_port? 12
  reset_password?
  reset_status? enabled
  reset_node? mfs2
  reset_comms? network
  reset_device? newnode-12.mycompany.com
Event at [ Oct 21 15:58:02 ]
Node "newnode" has been created, waiting for it to join the cluster...
Please restart all cxfs and cluster services on the server "newnode" to make it
join the cluster.
```

You will use a similar set of subcommands to modify a node. (To modify a node, you must first disable it.)

To modify the `failpolicy` to eliminate Shutdown:

```
cxfs_admin:mycluster> modify newnode failpolicy=Reset,Fence
```

**Basic-mode** usage notes:

- `name` is a simple hostname (such as `lilly`) or a fully qualified domain name (such as `lilly.example.com`) or an entirely different name (such as `node1`). It cannot begin with a number or an underscore (`_`), or include any whitespace characters, and can be at most 255 characters.
- `type` specifies the function of the node. Enter one of the following:
  - `client_only` is a node that shares CXFS filesystems but will never be a CXFS metadata server. Most nodes should be client-only nodes.
  - `server_admin` is an SGI Foundation Software (type `linux`) node that is a potential CXFS metadata server. (You will use the `create filesystem` command to define the specific filesystem for which this node can be a metadata server.)

- `os` is one of the following for client-only nodes:

Linux (SGI Foundation Software or Linux third-party)  
MacOSX  
Unknown  
Windows

- `private_net` is the IP address or hostname of the private network. (The hostname must be resolved in the `/etc/hosts` file.) SGI requires that this network be private; see "Private Network" on page 23.

There can be up to 8 network interfaces. The order in which you specify the interfaces determines their priority; the first interface will be priority 1, the second priority 2, and so on. There is no default.

To inform the servers of the failover networks, you must create a `failover_net` network. See "Network Failover Tasks with `cxfs_admin`" on page 271.

For more information about using the hostname, see "Hostname Resolution and Network Configuration Rules" on page 117.

**Advanced-mode** usage notes:

- `enabled` determines if a node will be able to obtain CXFS membership (`true`) or not (`false`). By default, the new node is enabled (`true`). To enable a command

created with `enabled=false`, use the `enable` command. See "Enable a Node with `cxfs_admin`" on page 251.

- `failpolicy` determines what happens to a failed node. You can specify up to three methods. The second method will be completed only if the first method fails; the third method will be completed only if both the first and second options fail. Separate options by commas (not whitespace). The option choices are as follows:
  - `Fence` disables access to the SAN from the problem node. Fencing provides faster recovery of the CXFS kernel membership than `reset`.
  - `FenceReset` performs a fence and then, if the node is successfully fenced, **also** performs an asynchronous reset of the node via a system controller; recovery begins without waiting for reset acknowledgement.

---

**Note:** SGI recommends that a server-capable administration node include `Reset` in its `failpolicy` (unless it is the only server-capable administration node in the cluster). See "Data Integrity Protection" on page 25.

---

The `FenceReset` and `Fence` policies are mutually exclusive.

- `Reset` performs a system reset via a system controller. This action requires a `reset_method` value; see "Hardware and Software Requirements for Server-Capable Administration Nodes" on page 35.
- `Shutdown` tells the other nodes in the cluster to wait for a period of time (long enough for the node to shut itself down) before reforming the CXFS kernel membership. (However, there is no notification that the node's shutdown has actually taken place.)



**Caution:** Because there is no notification that a shutdown has occurred, if you have a cluster with no tiebreaker, you must not use the `Shutdown` setting for any server-capable administration node in order to avoid split clusters being formed. See "Shutdown" on page 61.

---

You should not use the `Shutdown` fail policy on client nodes if you choose dynamic CXFS kernel heartbeat monitoring for the cluster.

---

**Note:** If the failure hierarchy contains `Reset` or `FenceReset`, the reset might be performed before the system kernel core-dump can complete, resulting in an incomplete core-dump.

---

For a list of valid `failpolicy` sets, see "Data Integrity Protection" on page 25.

For example, to perform a reset only if a fencing action fails, specify the following:

```
failpolicy=Fence,Reset
```

---

**Note:** If the fail policy does not include `Shutdown` and all of the other actions fail, CXFS will stall membership until the failed node either attempts to join the cluster again or until the administrator intervenes by using `cms_intervene`. Objects held by the failed node stall until membership finally transitions and initiates recovery. For more information, see the `cms_intervene(8)` man page.

---

To perform a fence and an asynchronous reset, specify the following:

```
failpolicy=FenceReset
```

- `hostname` is the fully qualified domain name. Use the `ping` to display the fully qualified hostname. Do not enter an IP address. The default for `hostname` is the fully qualified domain name for the value of `name`.
- `nodeid` is an integer in the range 1 through 32767 that is unique among the nodes in the cluster. If you change this value after a node has been defined, you must reboot the affected node. You do not normally need to specify this attribute because `cxfs_admin` will calculate an ID for you.
- `partition_id` uniquely defines a partition in an Altix 3000 series system or Altix 4700 system. For a non-partitioned system, this attribute is not required (the default unassigned). To unset the partition ID, use a value of 0. You can find the partition ID by reading the `proc` file. For example, for an Altix 3000:

```
altix# cat /proc/sgi_sn/partition_id
0
```

The 0 indicates that the system is not partitioned. If the system is partitioned, the number of partitions (such as 1, 2, etc.) is displayed.

- `reset_method` specifies the action that will automatically be taken by CXFS if `reset_status=enabled`. It can be one of the following:
  - `powerCycle` shuts off power to the node and then restarts it
  - `reset` simulates the pressing of the reset button on the front of the machine (recommended)
  - `nmi` (nonmaskable interrupt) performs a core-dump of the operating system kernel, which may be useful when debugging a faulty machine

---

**Note:** NMI depends upon kernel support, which may not be present on all SGI Altix ia64 systems; if the kernel support is not provided, the `nmi` setting will not work.

NMI is not available on systems containing a baseboard management controller (BMC), such as SGI Altix XE x86-64 systems.

---

The default is `powerCycle`.

- `reset_port` is the system controller port type based on the node hardware, as shown in Table 11-2 on page 250.
- `reset_password` is the password for the node's system controller port (not the node's `root` password or PROM password). On some nodes, the system administrator may not have set this password. If you wish to set or change the system controller password, consult the hardware manual for your node.
- `reset_status` specifies if the automatic system reset capability is turned on (`enabled`) or turned off (`disabled`). Using `disabled` lets you provide information about the system controller but temporarily disable reset (meaning that CXFS cannot reset the node). The default for nodes with system controllers is `enabled`, the default for nodes without system controllers is `disabled`; see "Hardware and Software Requirements for Server-Capable Administration Nodes" on page 35.
- `reset_node` specifies the name of the server-capable administration node (the *owner node*) that will send the reset command to the target node. It can be the logical name, hostname, or fully qualified domain name. If you use `reset_comms=tty`, serial cables must physically connect the target node and the owner node through the system controller port. The owner node must be defined in the cluster database.



- `reset_comms` is `tty` for TTY serial devices, `network` for network reset to systems with L2 system controllers (you can use network reset even if you have hardware reset capability.), or `ipmi` for intelligent platform management interface (IPMI) network reset to systems with BMC system controllers.
- `reset_device` is one of the following:
  - For systems with serial ports (`reset_comms=tty`), this is the name of the terminal port (TTY) on the owner node (the node issuing the reset). A serial cable connects the terminal port on the owner node to the system controller of the node being reset. `/dev/ttyd2` is the most commonly used port, except on Altix 350 systems (where `/dev/ttyIOC0` is commonly used).

---

**Note:** Check the owner node's specific hardware configuration to verify which TTY device to use.

---

- For systems with network-attached L2 system controllers (`reset_comms=network`), this is the IP address or hostname of the L2 controller on the node being reset. For example:

```
reset_device=nodename-l2.mycompany.com
```

- For systems with network-attached BMC system controllers (`reset_comms=ipmi`), this is the IP address or hostname of the BMC controller on the node being reset. For example:

```
reset_device=nodename-bmc.mycompany.com
```

Altix 3000 Bx2 system:

```
reset_comms=network reset_device=nodename-l2.mycompany.com
```

Altix 350 system without an L2:

```
reset_comms=tty reset_device=/dev/ttyIOC0
```

Altix XE system with a BMC:

```
reset_comms=ipmi reset_device=nodename-bmc.mycompany.com
```

**Table 11-2** System Controller Types

bmc	12
Any Altix XE	Any Altix with an L2 Prism

The following is an example of a node created for BMC reset, where the default for `reset_password` is `admin` as explained in "BMC System Controller" on page 465 (line breaks added here for readability):

```
cxfs_admin:mycluster> create node name=node1 type=server_admin private_net=192.168.0.168
enabled=true hostname=node1.example.com failpolicy=Fence,Reset,Shutdown
nodeid=1 reset_method=powerCycle reset_port=bmc reset_status=enabled
reset_node=mds2 reset_comms=ipmi reset_device=node1-bmc.mycompany.com
```

## Delete a Node with `cxfs_admin`

---

**Note:** Before deleting a server-capable administration node, you must first unmount any filesystems on that node and disable the node.

---

To delete a node from the cluster and the cluster database, use the following command:

```
delete [node:]nodename
```

If the node is enabled (which is the default), you must disable it before you delete it. For example, if `mynode` is a unique name in the cluster database:

```
cxfs_admin:mycluster> disable mynode
Node "mynode" has been disabled, waiting for it to leave the cluster...
Waiting for node mynode, current status: Disabled and unmounting
Operation completed successfully
cxfs_admin:mycluster> delete mynode
```

---

**Note:** If you delete an active metadata server, `cxfs_admin` will enter read-only mode. You can use the `lock` or `lock steal=true` to reenter lock mode. For more information, see "Making Changes Safely" on page 229.

---

### Enable a Node with `cxfs_admin`

To allow a disabled node to join the cluster, enter the following:

```
enable [node:]nodename
```

For example, if `node1` is a unique name in the cluster database:

```
cxfs_admin:mycluster> enable node1
```

### Disable a Node with `cxfs_admin`

To prevent a node from joining the cluster, enter the following:

```
disable [node:]nodename
```

For example, if `node1` is a unique name in the cluster database:

```
cxfs_admin:mycluster> disable node1
```

---

**Note:** This procedure is strongly recommended for stopping CXFS services on CXFS server-capable administration nodes or on a client-only tie-breaker node that must be shutdown for maintenance or otherwise taken offline. These types of nodes will affect the CXFS kernel membership quorum calculation as long as they are configured as enabled in the cluster database.

---

After you have disabled a node, the node is no longer an active member of the cluster.

---



**Caution:** If you disable a node, it will be marked as `Disabled` and it will therefore not rejoin the cluster after a reboot. To allow a node to rejoin the cluster, you must enable the node. See "Enable a Node with `cxfs_admin`" on page 251.

---

### Show Node Information with `cxfs_admin`

You can display a node's parameters with the following command:

```
show [node:]nodename
```

For example, if `cxfsxe5` is a unique name in the cluster database:

```
cxfs_admin:clusterOne> show cxfsxe5
Event at [ Oct 21 13:35:25 ]
node:cxfsxe5:
  cellid=1
  enabled=true
  os=Linux
  private_net:
    10.0.199.1
  status:
    age=44
    connected=true
    fencing=Stable
    license:
      have_license=true
    summary=Stable
    version=6.0.0.3
    wwns:
      210000e08b123d95
  type=server_admin
```

---

**Note:** The `have_license` field reports licenses for client-only nodes that have been obtained from the server. It does not display information about the server licenses. For more information about licensing, see "Show License Information with `cxfs_admin`" on page 262.

---

You can see a list of all of the nodes that have been defined with the following command:

```
show node
```

For example (output truncated):

```
cxfs_admin:clusterOne > show node
Event at [ Oct 21 13:36:02 ]
node:
  bert:
    cellid=0
    enabled=true
    os=Linux
    private_net:
      10.0.199.3
    status:
      age=33
      connected=true
      fencing=Stable
      license:
        have_license=true
      summary=Stable
      version=6.0.0.3
      wwns:
        100000062b126ff8, 100000062b126ff9
    type=server_admin
  cxfsxe5:
    cellid=1
    enabled=true
    os=Linux
    private_net:
      10.0.199.1
    status:
      age=44
      connected=true
      fencing=Stable
      license:
        have_license=true
      summary=Stable
      version=6.0.0.3
      wwns:
        210000e08b123d95
    type=server_admin
  cxfsxe10:
    cellid=3
```

```
enabled=false
os=Linux
private_net:
  10.0.199.4
status:
  age=-
  connected=false
  summary=Disabled
type=client_only
penguin17:
  cellid=4
  enabled=true
  os=Linux
  private_net:
    10.0.199.17
  status:
    age=54
    client=stable
    connected=true
    fencing=Stable
    filesystems=up
    license:
      allocated=1
      cpu_count=2
      have_license=true
      oem=none
      os=Linux32
      tier=workstation
    membership=up
    summary=Stable
    version=6.0.0.3
  wwns:
    210000e08b1a07d8
  xvm=up
  type=client_only
...
```

See also "Displaying the License Keys with `cxfs_admin` After Installing CXFS" on page 114.

## Enable or Disable CXFS Kernel Membership (`cmsd`) for the Local Node

The `cmsd` daemon controls CXFS kernel membership and heartbeat.

You must use the following command to allow CXFS kernel membership for the local server-capable administration node (the node on which `cxfs_admin` is running) after fixing the problems that required a forced CXFS shutdown (see "Shutdown of the Database and CXFS" on page 304):

```
cxfs_admin:mycluster> enable cmsd
```

You should revoke CXFS kernel membership of the local node only if an error requires you to perform a forced CXFS shutdown:

```
cxfs_admin:mycluster> disable cmsd
```

The result of the `disable cmsd` command is considered as a node failure by the rest of the cluster. The cluster may then fail due to a loss of CXFS kernel membership quorum or it may reset the failed node. To avoid the reset, modify the local node's definition to disable the system controller status.

---

**Note:** The `enable cmsd` and `disable cmsd` commands are only effective when `cxfs_admin` is executed directly on a server-capable administration node. They only affect the local node (the node on which `cxfs_admin` is running).

---

## Control and Contact a Node with `cxfs_admin`

---

**Note:** The `control` command must be run when `cxfs_admin` is executed directly on a server-capable administration node.

---

You can use the `control` command from a server-capable administration node to manually control and contact a target node that has a system controller. The target node must have the following attributes defined in the cluster database (see "Create or Modify a Node with `cxfs_admin`" on page 242):

```
reset_port  
reset_password  
reset_node  
reset_comms  
reset_device
```

You can do the following:

- "Reset a Node with `cxfs_admin`" on page 256 (recommended)
- "Power-Cycle a Node with `cxfs_admin`" on page 256
- "NMI a Node with `cxfs_admin`" on page 256
- "Ping a Node System Controller with `cxfs_admin`" on page 257

#### Reset a Node with `cxfs_admin`

SGI recommends the reset method for system control on server-capable administration nodes. To reset the target node, which simulates the pressing of the reset button on the front of the machine (recommended), enter the following:

```
cxfs_admin:mycluster> control target-nodename operation=reset
```

For example, to reset the node named `mds1`:

```
cxfs_admin:mycluster> control mds1 operation=reset
```

When the target node is reset, other nodes in the cluster will detect the change and remove the target node from the active cluster. When the target node reboots, it will rejoin the CXFS kernel membership.

#### Power-Cycle a Node with `cxfs_admin`

To shut off power to the target node and then restart it, enter the following:

```
cxfs_admin:mycluster> control target-nodename operation=powerCycle
```

#### NMI a Node with `cxfs_admin`

To send a nonmaskable interrupt to the target node, which performs a core-dump of the operating system kernel that may be useful when debugging a faulty machine, enter the following:

```
cxfs_admin:mycluster> control target-nodename operation=nmi
```



---

**Note:** NMI depends upon kernel support, which may not be present on all SGI Altix ia64 systems; if the kernel support is not provided, the `nmi` setting will not work.

NMI is not available on systems containing a baseboard management controller (BMC), such as SGI Altix XE x86-64 systems.

---

### Ping a Node System Controller with `cxfs_admin`

To contact the system controller for the target node via a `ping` command, enter the following:

```
cxfs_admin:mycluster> control target-nodename operation=ping
```

### Cluster Tasks with `cxfs_admin`

This section discusses the following:

- "Create a Cluster with `cxfs_admin`" on page 258
- "Modify a Cluster with `cxfs_admin`" on page 259
- "Specify a Tiebreaker with `cxfs_admin`" on page 260
- "Delete a Cluster with `cxfs_admin`" on page 261
- "Display a Cluster with `cxfs_admin`" on page 261
- "Show License Information with `cxfs_admin`" on page 262

## Create a Cluster with `cxfs_admin`

To create the cluster, use the following command (line breaks shown here for readability, defaults in parentheses):

```
create cluster
  name=clustername
```

*Advanced-mode:*

```
  id=clusterID
  heartbeat_monitor=dynamic|static  (static)
```

For example:

```
cxfs_admin:> create cluster name=mycluster
```

**Basic-mode** usage notes:

- *clustername* specifies the logical name of the cluster. It cannot begin with a number or an underscore (`_`), or include any whitespace characters, and can be at most 255 characters.

**Advanced-mode** usage notes:

- *id* is a unique number within your network in the range 1 through 255. The cluster ID is used by the operating system kernel to make sure that it does not accept cluster information from any other cluster that may be on the network. The kernel does not use the database for communication, so it requires the cluster ID in order to verify cluster communications. This information in the kernel cannot be changed after it has been initialized; therefore, you cannot change a cluster ID after the cluster has been defined. Clusters must have unique IDs.
- *heartbeat\_monitor* specifies how CXFS kernel membership is monitored. All nodes send CXFS kernel heartbeat messages once per second. If a node does not receive a heartbeat within a defined period, that node loses membership and is denied access to the cluster's filesystems. The defined period is one of the following:
  - *static*: Monitors constantly at 1-second intervals and declares a timeout after 5 consecutive missed seconds (default).
  - *dynamic*: Starts monitoring only when the node is processing a message from another node (such as for token recall or XVM multicast) or when the client monitors the server because it has a message pending (for example, a token acquire or metadata operation). Once monitoring initiates, it monitors at

1-second intervals and declares a timeout after 5 consecutive missed seconds, just like static monitoring. Dynamic heartbeat monitoring is appropriate for clusters that have clients with heavy workloads; using it avoids inappropriate loss of membership. However, it may take longer to recover a client's tokens and other state information when there is an actual problem.

---

**Note:** You should not use the `Shutdown` fail policy on client nodes if you choose dynamic heartbeat monitoring for the cluster.

---

## Modify a Cluster with `cxfs_admin`

To modify the cluster, use the following command (line breaks shown here for readability, defaults in parentheses):

```
modify clustername
    tiebreaker=client_only_nodename
    notify_addr=email_addresses
    notify_cmd=email_program
```

*Advanced-mode:*

```
heartbeat_monitor=dynamic|static    (static)
```

---

**Note:** You cannot change the cluster's name or ID.

---

For example, if `mycluster` is a unique name in the cluster database, to make the client-only node `clientA` the CXFS tiebreaker:

```
cxfs_admin:mycluster> modify mycluster tiebreaker=clientA
```

To email status changes to the users `joe` and `sally` using the `/usr/bin/mail` program, enter the following (line breaks shown here for readability):

```
cxfs_admin:mycluster> modify mycluster notify_cmd=/usr/bin/mail
notify_addr=joe@MyCompany.com,sally@MyCompany.com
```

**Basic-mode** usage notes:

- `clustername` identifies the object for which values will be modified (you cannot change the name of the cluster).
- `tiebreaker` specifies the CXFS tiebreaker. See "Specify a Tiebreaker with `cxfs_admin`" on page 260.
- `notify_addr` specifies the email address that CXFS will contact when there are cluster and node status changes. To specify multiple addresses, separate them with commas.
- `notify_addr` specifies the email program to use, such as `/usr/bin/mail`.

**Advanced-mode** usage notes:

- `heartbeat_monitor` specifies how CXFS kernel membership is monitored. See the description in "Create a Cluster with `cxfs_admin`" on page 258.

**Specify a Tiebreaker with `cxfs_admin`**

The CXFS tiebreaker node determines whether a CXFS kernel membership quorum is maintained when exactly half of the server-capable administration nodes can communicate with each other. There is no default CXFS tiebreaker.



**Caution:** SGI recommends that you use client-only nodes as tiebreakers to ensure that the cluster remains operational. `cxfs_admin` will only let you specify a server-capable administration node as a tiebreaker if the cluster contains four or more server-capable administration nodes and an even number of server-capable administration nodes.

To ensure data integrity for all nodes, you must use reset or I/O fencing. Clusters should have an odd number of server-capable administration nodes. If you have an even number of server-capable administration nodes, define a CXFS tiebreaker node.

---

To set the CXFS tiebreaker node, use the `modify` command as follows:

```
modify [cluster:]clustername tiebreaker=client_nodename
```

For example:

```
cxfs_admin:mycluster> modify mycluster tiebreaker=myclient
```

To unset the CXFS tiebreaker node, do not supply a value for `tiebreaker`. For example:

```
cxfs_admin:mycluster> modify mycluster tiebreaker=
```

### Delete a Cluster with `cxfs_admin`

To delete an inactive cluster, use the following command:

```
delete [cluster:]clustername
```

For example, if `mycluster` is a unique name in the cluster database:

```
cxfs_admin:mycluster> delete mycluster
```

However, you cannot delete an active cluster; you must first unmount and delete the filesystems, disable and delete the nodes, and so on.

### Display a Cluster with `cxfs_admin`

To display the cluster, use the following command:

```
show cluster
```

For example:

```
cxfs_admin:clusterOne > show cluster
Event at [ Oct 21 14:08:26 ]
cxfs:cluster:
  clusterOne:
    access:
      admin=server
      monitor=cluster
    autoconf:
      allowed:
        pg-27
      disallowed:
        (none)
    clusterid=9
    failover_net:
      (none)
    filesystem:
```

```
    zj01s0, zj01s1
heartbeat_monitor=static
log:
    clconfd, cli, crsd, diags
node:
    bert, cxfsxe5, cxfsxe10, penguin17, pg-27
status:
    filesystems:
        stable=true
        summary=Stable
    licenses:
        cxfs_client
    nodes:
        stable=true
        summary=Stable
    stable=true
    summary=stable
switch:
    brocade26cp1
tiebreaker=
```

### Show License Information with `cxfs_admin`

To show the number of CXFS licenses available for the cluster, use the following command:

```
show licenses
```

For example:

```
cxfs_admin:clusterOne > show licenses
Event at [ Oct 21 16:07:25 ]
status:licenses:
    cxfs_client:
        enterprise:
            valid=256
        workstation:
            allocated=2
            valid=50
```

## CXFS Filesystem Tasks with `cxfs_admin`

The `filesystem` class represents the clustered XVM volumes that can be mounted by CXFS nodes. Before you can create a filesystem definition, you must create the clustered XVM volume and make the filesystem with `mkfs`.

By default, the filesystem:

- Uses the XVM device of the same name
- Enables all nodes to mount the filesystem
- Mounts the filesystem in `/mnt/`
- Is not managed by GRIOv2

To override these defaults, use the optional attributes listed below.

This section discusses the following:

- "Create or Modify a CXFS Filesystem with `cxfs_admin`" on page 263
- "Mount a CXFS Filesystem with `cxfs_admin`" on page 268
- "Unmount a CXFS Filesystem with `cxfs_admin`" on page 269
- "Relocate the Metadata Server for a Filesystem with `cxfs_admin`" on page 269
- "Delete a CXFS Filesystem with `cxfs_admin`" on page 270
- "Show a CXFS Filesystem" on page 270

### Create or Modify a CXFS Filesystem with `cxfs_admin`

Use the following commands to define a filesystem and the nodes on which it may be mounted (line breaks shown here for readability, defaults in parentheses):

```
create filesystem
  name=fsname
  options=mount_options
  forced_unmount=true|false           (false)
  mountpoint=mountpoint             (/mnt/fsname)
  mounted=true|false                  (true)
  grio_managed=true|false             (false)
  grio_qual_bandwidth=qualified_bandwidth
```

**Advanced-mode:**

device= <i>volumename</i>	( <i>fsname</i> )
servers= <i>server_list</i>	( <i>all servers are potential MDS</i> )
nodes= <i>nodes_that_can_mount</i>	( <i>all nodes can mount</i> )
mount_new_nodes=true false	( <i>true</i> )

You will use a similar set of commands to modify a CXFS filesystem. (To modify a filesystem, you must first unmount it.)

---

**Note:** You must create XVM volumes with `xvm` and `mkfs` before you set it up using `cxfs_admin`.

The `device` value must be the XVM volume name. In basic mode, you are not prompted for a device name; `cxfs_admin` uses the value for `name` and prepends `/dev/cxvm/` to it. Therefore, in basic mode, the value you specify for `name` must be the XVM volume name. If you want to use a `name` value other than the XVM volume name, then you must use advanced mode and specify the `device` attribute.

---

**Basic-mode usage notes:**

- `name` specifies the name of the filesystem:
  - If you also specify a value for `device`, then `name` can be any string that does not begin with a number or an underscore (`_`), or include any whitespace characters, and can be at most 255 characters. For example, if the full XVM volume name is `/dev/cxvm/concat1`:

```
cxfs_admin:mycluster> create filesystem name=filesys1 device=concat1
```

- If you do not specify a value for `device`, then `name` must be the name of the XVM volume name following `/dev/cxvm`. For example:

```
cxfs_admin:mycluster> create filesystem name=concat1
```

- `options` specifies the mount options that are passed to the `mount` operating system command. These mount options control access to the specified filesystem. For a list of supported mount options, see the *CXFS 6 Client-Only Guide for SGI InfiniteStorage*. By default, this is unassigned.



Specify multiple mount options as a comma-separated list. For example, the following specifies that the `myfs` filesystem uses `inode64` allocation and does not update the access time stamps for files and directories:

```
cxfs_admin:mycluster> create filesystem name=myfs options=inode64,noatime
```

---

**Note:** No validation is done on the mount options in `cxfs_admin`, so an invalid option may prevent the filesystem mounting on all nodes.

---

- `forced_unmount` controls the action that CXFS takes if there are processes that have open files or directories in the filesystem to be unmounted:
  - If set to `true`, the processes will be killed and the unmount will occur
  - If set to `false`, the processes will not be killed and the filesystem will unmount only after all references to the filesystem have been closed (default)
- `mounted` specifies whether a new filesystem is mounted on all nodes in the cluster (`true`) or not mounted on any nodes (`false`). By default, the new filesystem is mounted on all nodes (`true`).
- `mountpoint` specifies a mount point for the filesystem. The mount point is a directory to which the XVM volume is attached. This directory name must begin with a slash (/). The default is `/mnt/fsname`.

For example, to create a filesystem named `myfs` and use the default mount point of `/mnt/myfs`:

```
cxfs_admin:mycluster> create filesystem name=myfs
```

To create the `myfs` filesystem but use a mount point of `/tmp/myfs`:

```
cxfs_admin:mycluster> create filesystem name=myfs mountpoint=/tmp/myfs
```

- `grio_managed` specifies whether a filesystem is managed by GRIOv2 (`true`) or not (`false`) if GRIOv2 has already been enabled on the node. The default is `false`. Setting `grio_managed` to `false` disables GRIO management for the specified filesystem, but it does not reset the `grio_qual_bandwidth` value. In this case, `grio_qual_bandwidth` is left unmodified in the cluster database and ignored.
- `grio_qual_bandwidth` specifies a filesystem's qualified bandwidth in bytes (B suffix), kilobytes (KB), megabytes (MB), or gigabytes (GB), where the units are multiples of 1024. The default is MB for 4000 or less, B for 4001 or greater. If the

filesystem is GRIO-managed, you must specify a qualified bandwidth with this attribute. To modify the qualified bandwidth, the filesystem must be unmounted.

For example, the following commands all create the `myfs` filesystem with a GRIOv2 qualified bandwidth of 1.2 GB/s (assuming that `grio_managed=true` has already been set):

```
cxfs_admin:mycluster> create filesystem name=myfs grio_qual_bandwidth=1288500000
cxfs_admin:mycluster> create filesystem name=myfs grio_qual_bandwidth=1258300KB
cxfs_admin:mycluster> create filesystem name=myfs grio_qual_bandwidth=1288.8MB
cxfs_admin:mycluster> create filesystem name=myfs grio_qual_bandwidth=1.2GB
```

**Advanced-mode usage notes:**

- `device` is the name of the XVM volume (minus `/dev/cxvm`). The default is the filesystem name specified by `name`.

For example, to create a `device` name of `mydev` for the `myfs` filesystem:

```
cxfs_admin:mycluster> create filesystem name=myfs device=mydev
```

- `servers` specifies the potential metadata servers that can serve the filesystem to the cluster. To specify multiple server-capable administration nodes, use a comma-separated list of node names.

---

**Note:** Relocation is disabled by default. Recovery and relocation are supported only when using standby nodes. Therefore, you should only define multiple metadata servers for a given filesystem if you are using the standby-node model. See "Relocation" on page 26.

---

The default is all server-capable administration nodes in the cluster. The list of potential metadata servers for a given filesystem is ordered, but because of network latencies and other unpredictable delays, it is impossible to predict which node will become the active metadata server for the initial mount of a filesystem.

---

**Note:** Before deleting a server-capable administration node, you must first unmount any filesystems for which the node is a potential metadata server.

---

For example, to specify that either `node2` or `node3` could be the metadata server, with `node2` being the primary server, for the `myfs` filesystem:

```
cxfs_admin:mycluster> create filesystem name=myfs servers=node2,node3
```

- `nodes` specifies the only nodes that can mount the filesystem as a comma-separated list; you must include the server-capable administration nodes in this list. If you do not specify `nodes` on the `create` command, all nodes can mount the filesystem. If you restrict the nodes on the `create` command line, you can later mount all nodes by specifying all of them with the `nodes` attribute.

For example, to restrict mounting the `myfs` filesystem to nodes `node1` and `node2`:

```
create myfs nodes=node1,node2
```

To add `node3`:

```
modify myfs nodes=node1,node2,node3
```

- `mount_new_nodes` specifies whether a newly created node will automatically mount the filesystem when it gets membership (`true`) or will not mount the filesystem (`false`). By default, new nodes mount all defined filesystems.

For example, to create filesystem `myfs` that is not automatically mounted by new nodes, use the following command:

```
cxfs_admin:mycluster> create filesystem name=myfs mount_new_nodes=false
```

To later mount the filesystem on `node3` after it has been created, use the following command:

```
cxfs_admin:mycluster> mount myfs nodes=node3
```

For example, using prompting in basic mode:

```
cxfs_admin:clusterOne> create filesystem
Specify the attributes for create filesystem:
name? zj01s0
options?
forced_unmount? false
mountpoint? /mnt/zj01s0
mounted? true
grio_managed? false
Event at [ Oct 21 15:04:15 ]
Filesystem "zj01s0" has been created, waiting for it to be mounted on all assigned nodes...
Waiting for filesystem zj01s0, current status: A server is trying to mount
Waiting for filesystem zj01s0, current status: cxfsxe5 trying to mount, penguin17 trying to mount, pg-27 trying to
mount
Waiting for filesystem zj01s0, current status: pg-27 trying to mount
Operation completed successfully
```

For example, using prompting in advanced mode:

```
cxfs_admin:clusterOne> create filesystem
Specify the attributes for create filesystem:
name? zj01s0
options?
forced_unmount? false
mountpoint? /mnt/zj01s0
device? zj01s0
servers? bert,cxfsxe5
nodes? bert,cxfsxe10,cxfsxe5,penguin17,pg-27
mounted? true
mount_new_nodes? true
grio_managed? false
Event at [ Oct 21 15:02:28 ]
Filesystem "zj01s0" has been created, waiting for it to be mounted on all assigned nodes...
Waiting for filesystem zj01s0, current status: A server is trying to mount
Waiting for filesystem zj01s0, current status: penguin17 trying to mount, pg-27 trying to mount
Operation completed successfully
```

---

**Note:** After a filesystem has been defined in CXFS, running `mkfs` on it will cause errors to appear in the system log file. To avoid these errors, run `mkfs` before defining the filesystem in CXFS or delete the CXFS filesystem before running `mkfs`. See "Delete a CXFS Filesystem with `cxfs_admin`" on page 270.

---

## Mount a CXFS Filesystem with `cxfs_admin`

The mount command operates on the set of nodes that were specified in the `nodes=nodelist` attribute when the filesystem was created. By default, this is all nodes in the cluster.

To mount the filesystem on all enabled nodes in the cluster:

```
mount filesystem
```

To mount the filesystem on specific enabled nodes:

```
mount filesystem nodes=nodelist
```

For example, to mount the filesystem `myfs` on only nodes `node2` and `node3`:

```
cxfs_admin:mycluster> mount myfs nodes=node2,node3
```

---

**Note:** When a node is configured to mount a filesystem, the node will automatically mount that filesystem when the node joins the cluster membership.

---

### Unmount a CXFS Filesystem with `cxfs_admin`

To unmount a filesystem from all nodes in the cluster:

```
umount filesystem
```

To unmount the filesystem from a specific comma-separated list of nodes:

```
umount filesystem nodes=nodelist
```

For example, to unmount filesystem `myfs` from nodes `node1` and `node3`:

```
cxfs_admin:mycluster> umount myfs nodes=node1,node3
```

---

**Note:** If any nodes are not in membership, the filesystem will be marked as not to be mounted when the nodes achieve membership.

---

### Relocate the Metadata Server for a Filesystem with `cxfs_admin`

The `relocate` command forcefully moves a filesystem's metadata server to another node in the cluster that has already been defined as a potential metadata server for that filesystem. This action is typically used to free a server so that it can be brought down for maintenance or upgrades. Relocation must also be explicitly enabled in the kernel with the `cxfs_relocation_ok` system tunable parameter (see "Relocation" on page 26).

If relocation is explicitly enabled in the kernel, you can relocate a metadata server to another node by using the following command:

```
relocate filesystem server=new_metadata_server
```

For example:

```
cxfs_admin:mycluster> relocate myfs server=node2
```

CXFS kernel membership is not affected by relocation. However, users may experience a degradation in filesystem performance while the metadata server is relocating.

## Delete a CXFS Filesystem with `cxfs_admin`

Use the following command to delete a filesystem:

```
delete [filesystem:] filesystem
```

You cannot delete a mounted filesystem; you must first unmount it. For example, if `myfs` is a unique name in the cluster database:

```
cxfs_admin:clusterOne> unmount zj01s0
Event at [ Oct 21 15:09:13 ]
Waiting for filesystem "zj01s0" to be unmounted on all nodes
Waiting for filesystem zj01s0, current status: bert trying to unmount, cxfsxe5 trying to unmount, penguin17 trying to unmount, pg-27 trying to unmount
Waiting for filesystem zj01s0, current status: bert trying to unmount, penguin17 trying to unmount, pg-27 trying to unmount
Waiting for filesystem zj01s0, current status: Unmounted
Operation completed successfully
cxfs_admin:clusterOne> delete zj01s0
Event at [ Oct 21 15:09:31 ]
```

## Show a CXFS Filesystem

To show information about all filesystems:

```
show filesystem
```

To show information about a specific filesystem:

```
show [filesystem:] fsname
```

For example, for a filesystem named `zj0ds0`:

```
cxfs_admin:clusterOne> show zj01s0
Event at [ Oct 21 15:11:19 ]
filesystem:zj01s0:
  device=zj01s0
  forced_unmount=false
  grio_managed=false
  grio_qual_bandwidth=0B
  mount=true
  mount_new_nodes=true
  mountpoint=/mnt/zj01s0
```

```
nodes:
  bert, cxfsxe10, cxfsxe5, penguin17, pg-27
options=
servers:
  bert, cxfsxe5
status:
  blocksize=4.00KB
  free=8.28GB
  nodes:
    bert=mounted
    cxfsxe10=disabled
    cxfsxe5=mounted
    penguin17=mounted
    pg-27=mounted
  server=bert
  size=8.37GB
  stable=true
  summary=Mounted
  utilization=1%
```

## Network Failover Tasks with `cxfs_admin`

To allow the cluster to continue operation if the primary private network fails, you can set up private network failover.

To inform the servers of the failover networks, you must create a `failover_net` network.



**Caution:** Do not create a `failover_net` network while CXFS services are active; doing so can lead to cluster malfunction.

---

Each node in the cluster must have all `private_net` values specified to match the subsets defined by the failover networks in the same order as all other nodes in the cluster.

Command syntax:

```
create failover_net network=IPaddress
mask=IPmask
```

To create two private networks, one on the 192.168.0.x subnet and the other on the 10.0.0.x subnet, use the following command:

```
cxfs_admin:mycluster> create failover_net network=192.168.0.0 mask=255.255.255.0
cxfs_admin:mycluster > create failover_net network=10.0.0.0 mask=255.255.255.0
```

To create a node with failover network support:

```
cxfs_admin:mycluster> create node name=mynode private_net=192.168.0.2,10.0.0.2
```

## Switch Tasks with cxfs\_admin

This section discusses the following:

- "Create a Switch with cxfs\_admin" on page 273
- "Delete a Switch Definition with cxfs\_admin" on page 275
- "Show Switches with cxfs\_admin" on page 275

For general information, see "I/O Fencing" on page 57.

---

**Note:** Nodes without system controllers require I/O fencing to protect data integrity. A switch is mandatory to support I/O fencing; therefore, multiOS CXFS clusters require a switch. See the release notes for supported switches.

---

To raise or lower a fence, see "Fencing Tasks with cxfs\_admin" on page 277. For all of the options to update port information for switches, use the `hafence` command.



## Create a Switch with `cxfs_admin`

To define a new switch, use the following command:

```
create switch
  name=switch_hostname
  user=username                (admin)
  password=username_password  (password)
  vendor=brocade|qlogic|site-specific_vendor (brocade)
```

### Advanced-mode:

```
[mask=ports_that_will_not_be_fenced]
```

---

**Note:** You must define all of the switches within your fabric to which a CXFS client or server is connected.

---

### Basic-mode usage notes:

- `name` specifies the hostname of the Fibre Channel switch; this is used to determine the IP address of the switch.
- `password` specifies the password for the specified `username`. The default is `password`.
- `user` specifies the user name to use when sending a telnet message to the switch. The default is `admin`.
- `vendor` specifies the vendor of the Fibre Channel switch. It can be one of the following values:

```
brocade (default)
qlogic
site-specific-value
```

For example, if `myswitch` is a QLogic switch:

```
cxfs_admin:mycluster> create switch name=myswitch vendor=qlogic
```

### Advanced-mode usage notes:

- `mask` specifies the ports on the switch that will never be fenced. By default, no ports are masked (and therefore all ports are available for fencing). The value for

mask is a series of comma-separated port ranges. For example, the following states that ports 0, 4, and 12 through 15 for myswitch will never be fenced by CXFS:

```
cxfs_admin:mycluster> create switch name=myswitch mask=0,4,12-15
```

**Note:** For non-bladed switches, the port column of the switchShow output is the port number for CXFS.

For bladed switches, where the port number is not unique, the port column of switchShow output means the port number of one slot. However, CXFS requires a unique number identified by the combination of slot and port for bladed switch, which is usually represented by the Index or Area value in the switchShow output (depending upon the switch version). For example, the switchShow output below for the Brocade 48000 switch indicates that you would use a mask value of 16 for port 0 in slot 2:

```
brocade48000:admin> switchShow
Index Slot Port Address Media Speed State Proto
=====
  0    1    0  010000  id    N4   Online  F-Port  10:00:00:00:c9:5f:9b:ea
  1    1    1  010100  id    N4   Online  F-Port  10:00:00:00:c9:5f:ab:d9
  ....
142    1   30  018e00  id    N4   Online  F-Port  50:06:0e:80:04:5c:0b:46
143    1   31  018f00  id    N4   Online  F-Port  50:06:0e:80:04:5c:0b:66
  16    2    0  011000  id    N4   Online  F-Port  10:00:00:00:c9:5f:a1:f5
  17    2    1  011100  id    N4   Online  F-Port  10:00:00:00:c9:5f:a1:72
  ...
```

For more details, see the switch documentation.

Server-capable administration nodes automatically discover the available HBAs and, when fencing is triggered, fence off all of the Fibre Channel HBAs when the Fence or FenceReset fail policy is selected. However, masked HBAs will not be fenced. Masking lets you prevent the fencing of devices that are attached to the SAN but are not shared with the cluster, to ensure that they remain available regardless of CXFS status. You would want to mask HBAs used for access to tape storage, or HBAs that are only ever used to access local (nonclustered) devices.

## Delete a Switch Definition with `cxfs_admin`

To delete a switch, use the following command:

```
delete [switch:]switch_hostname
```

For example, if `myswitch` is a unique name in the cluster database:

```
cxfs_admin:mycluster> delete myswitch
```

## Show Switches with `cxfs_admin`

To display all of the switches in the system, use the following command:

```
show switch [output=full_pathname_of_output_file]
```

For example, in basic mode (truncated):

```
cxfs_admin:clusterOne> show switch
Event at [ Oct 21 15:20:59 ]
switch:
  brocade26cp1:
    hostname=brocade26cp1
    num_ports=192
    port:
      0, 1, 2, 3, 4, 5, 6, 7, 8, 9, 10, 11, 12, 13, 14, 15, 16, 17, 18, 19, 20, 21, 22, 23, 24, 25, 26, 27,
      28, 29, 30, 31, 32, 33, 34, 35, 36, 37, 38, 39, 40, 41, 42, 43, 44, 45, 46, 47, 48, 49, 50,
      ...
    vendor=brocade
```

To send the output to the `/tmp/switchinfo` file:

```
cxfs_admin:mycluster> show switch output=/tmp/switchinfo
```

To display a specific switch:

```
show [switch:]switchname [output=full_pathname_of_output_file]
```

To display mask values, use advanced mode (see "Basic and Advanced Mode" on page 234.) For example, if `myswitch` is a unique name in the cluster database (truncated):

## 11: cxfs\_admin Command

---

```
cxfs_admin:clusterOne> show switch
Event at [ Oct 21 15:20:59 ]
switch:
  brocade26cp1:
    hostname=brocade26cp1
    num_ports=192
    port:
      0, 1, 2, 3, 4, 5, 6, 7, 8, 9, 10, 11, 12, 13, 14, 15, 16, 17, 18, 19, 20, 21, 22, 23, 24, 25, 26, 27,
      28, 29, 30, 31, 32, 33, 34, 35, 36, 37, 38, 39, 40, 41, 42, 43, 44, 45, 46, 47, 48, 49, 50,
      ...
    switchid=Switch0
    vendor=brocade
```

To display the switches and ports each host is connected to:

```
show wwns
```

For example:

```
cxfs_admin:clusterOne> show wwns
Event at [ Oct 21 15:26:11 ]
node:bert:status:wwns:
  100000062b126ff8:
    order=1
  100000062b126ff9:
    order=0
    switch=brocade26cp1
    switch_port=62
node:cxfsxe5:status:wwns:
  210000e08b123d95:
    order=0
    switch=brocade26cp1
    switch_port=167
node:penguin17:status:wwns:
  210000e08b1a07d8:
    order=0
    switch=brocade26cp1
    switch_port=41
node:pg-27:status:wwns:
  210000e08b1284c6:
    order=0
    switch=brocade26cp1
```

```
switch_port=170
210100e08b3284c6:
order=1
```

To show full status details for each port on the switch, use one of the following commands:

```
show [switch:]switchname all
show switchname:port
```

For example, for the switch named `brocade26cp1`:

```
cxfs_admin:clusterOne> show brocade26cp1:port
Event at [ Oct 21 15:27:01 ]
switch:brocade26cp1:port:
  0:
    status=Enabled
    wwn=100000062b117c8c
  1:
    status=Enabled
    wwn=100000062b117954
  2:
    status=Enabled
    wwn=100000062b117c7c
  3:
    status=Enabled
    wwn=100000062b11796c
  ...
```

## Fencing Tasks with `cxfs_admin`

This section discusses the following fencing tasks:

- "Query Fence Status" on page 278
- "Raise a Fence" on page 278
- "Lower a Fence" on page 278

## Query Fence Status

To query the fencing status of all nodes, enter the `query fence` command when `cxfs_admin` is executed directly on a server-capable administration node. For example:

```
cxfs_admin:clusterOne> query fence
Event at [ Oct 21 15:29:07 ]
Waiting for shell command to end
Switch[0] "brocade26cp1" has 192 ports
  Port 41 type=FABRIC status=enabled hba=210000e08b1a07d8 on host penguin17
  Port 62 type=FABRIC status=enabled hba=100000062b126ff9 on host bert
  Port 167 type=FABRIC status=enabled hba=210000e08b123d95 on host cxfsxe5
  Port 170 type=FABRIC status=enabled hba=210000e08b1284c6 on host pg-27
Operation completed successfully
```

## Raise a Fence

To raise the I/O fence for a node, enter the following when `cxfs_admin` is executed directly on a server-capable administration node:

```
cxfs_admin:mycluster> raise fence node=nodename
```

To be prompted for required attributes, you must be in advanced mode.

Raising an I/O fence isolates the node from the SAN; CXFS sends a messages via the `telnet` protocol to the switch and disables the port. After the node is isolated, it cannot corrupt data in the shared CXFS filesystem.

For example, to isolate node `pg-27`:

```
cxfs_admin:clusterOne> raise fence node=pg-27
Event at [ Oct 21 15:29:47 ]
Waiting for shell command to end
Operation completed successfully
```

## Lower a Fence

To lower the I/O fence for a node, enter the following when `cxfs_admin` is executed directly on a server-capable administration node:

```
cxfs_admin:mycluster> lower fence node=nodename
```

To be prompted for required attributes, you must be in advanced mode.

Lowering the fence reenables the port and allows the node to reconnect to the SAN and access the shared CXFS filesystem.

For example, to reconnect nodepg-27:

```
cxfs_admin:clusterOne> lower fence node=pg-27
Event at [ Oct 21 15:30:37 ]
Waiting for shell command to end
Operation completed successfully
```

## Saving and Recreating the Current Configuration with `cxfs_admin`

This section discusses the following:

- "Creating `cxfs_admin` Scripts" on page 279
- "Recreating the Cluster Using `cxfs_admin` Scripts" on page 280

### Creating `cxfs_admin` Scripts

The `cxfs_admin config` command displays a series of commands that represent the current configuration of the objects specified. You can use this output to recreate the configuration of the entire cluster or a subset of it.

By default, `config` displays information at the `cxfs_admin` prompt. To write the configuration output to a file, use the `output` attribute and specify the full pathname of the file to contain the information:

```
config node output=full_pathname
```

You can use the generated file with the `-f` command line option to recreate the configuration at a later time.

---

**Note:** For a more-readable configuration output (without the related commands), use the `show` command rather than the `config` command.

---

To create cxf<sub>s</sub>\_admin scripts, do the following:

1. Dump the entire cluster configuration to a file, such as /tmp/config1:

```
cxfs_admin:mycluster> config * output=/tmp/config1
```

2. Edit the /tmp/config1 file:
  - a. Modify the output so that the first node created is the server-capable administration node from which you are going to execute the cxf<sub>s</sub>\_admin command to create the cluster. (By default, the cxf<sub>s</sub>\_admin config command output lists nodes in alphabetical order by node name without regard to node type.)
  - b. Cut the create filesystem command lines at the end of the file and paste them into a second script file, such as /tmp/config2.

## Recreating the Cluster Using cxf<sub>s</sub>\_admin Scripts

To recreate the cluster using cxf<sub>s</sub>\_admin scripts, do the following:

1. Recreate the base cluster (except for the CXFS filesystems) by using the first script file (/tmp/config1):

```
server-admin# /usr/cluster/bin/cxfs_admin -s -f /tmp/config1
```

---

**Note:** Do not reboot or restart CXFS or cluster services before this script finishes.

---

2. Reboot the server-capable administration node:

```
server-admin# reboot
```

Repeat the reboot command on each server-capable administration node in the cluster.

3. Recreate the CXFS filesystems by using the second script file (/tmp/config2):

```
server-admin# /usr/cluster/bin/cxfs_admin -f /tmp/config2
```



## Administration and Maintenance

This chapter discusses the following topics:

- "Administrative Tasks" on page 282
- "Precedence of Configuration Options" on page 282
- "CXFS Release Versions and Rolling Upgrades" on page 283
- "CXFS Relocation Capability" on page 291
- "CXFS and Cluster Administration Initialization Commands" on page 291
- "Using `ha_fence`" on page 292
- "Firewalls and CXFS Port Usage" on page 295
- "`chkconfig` Arguments" on page 296
- "Granting Task Execution Privileges for Users" on page 297
- "Transforming a Server-Capable Administration Node into a Client-Only Node" on page 297
- "CXFS Mount Scripts" on page 298
- "Using the Data Migration Facility (DMF)" on page 299
- "Discovering the Active Metadata Server" on page 301
- "Shutdown of the Database and CXFS" on page 304
- "Avoiding a CXFS Restart at Reboot" on page 309
- "Log File Management" on page 310
- "Filesystem Maintenance" on page 310
- "Dump and Restore" on page 312
- "Hardware Changes and I/O Fencing" on page 313
- "Private Network Failover" on page 314
- "Cluster Member Removal and Restoration" on page 315

- "XVM Volume Mapping to Storage Targets" on page 332
- "XVM Failover V2" on page 333
- "Generation of Streaming Workload for Video Streams" on page 339
- "Frame Files Defragmentation and Analysis" on page 340
- "Disk Layout Optimization for Approved Media Customers" on page 341
- "Creating a Case-Insensitive CXFS Filesystem" on page 346

See also Chapter 13, "Cluster Database Management" on page 349.

## Administrative Tasks

You will use one of the following commands for CXFS administration:

- CXFS GUI connected to any server-capable administration node. See Chapter 10, "CXFS GUI" on page 157.
- `cxfs_admin`: for most commands, a `cxfs_admin` instance running on any node in the cluster network that has `admin` access permission (see "Setting `cxfs_admin` Access Permissions" on page 230). See Chapter 11, "`cxfs_admin` Command" on page 223.

---

**Note:** A few `cxfs_admin` commands, such as `stop_cxfs`, must be run from a `cxfs_admin` instance running on a server-capable administration node.

---

## Precedence of Configuration Options

Figure 12-1 shows the order in which CXFS programs take their configuration options.

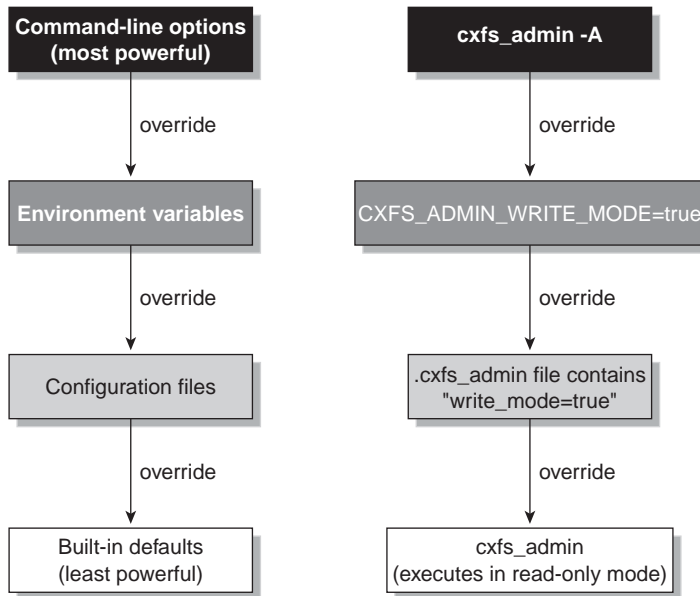


Figure 12-1 Precedence of Configuration Options

## CXFS Release Versions and Rolling Upgrades

SGI lets you upgrade of a subset of nodes from *X.anything* to *X.anything* within the same major-release thread (*X*). This policy lets you to keep your cluster running and filesystems available during the temporary upgrade process.

**Note:** A rolling upgrade is not supported between major releases (*X.anything* to *Y.anything*). For a major release, you must upgrade all nodes in the cluster at the same time.

To identify compatible CXFS releases, see the *CXFS MultiOS Software Compatibility Matrix* that is posted on Supportfolio:

[https://support.sgi.com/content\\_request/139840/index.html](https://support.sgi.com/content_request/139840/index.html)

After the upgrade process is complete, all nodes should be running the same major-level release *X.Y* (such as 6.0), or any minor-level release with the same major level *X.Y.anything* (such as the hypothetical 6.0.3).



---

**Caution:** You must upgrade all server-capable administration nodes before upgrading any client-only nodes (server-capable administration nodes must run the same or later release as client-only nodes.) Operating a cluster with clients running a mixture of older and newer CXFS versions may result in a performance loss. Relocation to a server-capable administration node that is running an older CXFS version is not supported.

Although clients that are not upgraded might continue to function in the CXFS cluster without problems, new CXFS functionality may not be enabled until all clients are upgraded; SGI does not provide support for any CXFS problems encountered on the clients that are not upgraded.

---

Using the 3.4.2 release as an example, a production cluster could contain server-capable administration nodes running 3.4.2 and client-only nodes running 3.4, 3.4.1, and 3.4.2; it could contain client-only nodes running 3.4.3 only because there was no server platforms included in 3.4.3. It should not contain any nodes running 3.3.

This section discusses the following:

- "Upgrading Licenses" on page 284
- "General Upgrade Procedure" on page 285
- "Example Upgrade Process" on page 287

## Upgrading Licenses

CXFS 6.0 and later releases require 6.0 licenses. For details about licenses, see Chapter 5, "CXFS Licensing" on page 103.

To upgrade to a 6.0 or later release, do the following:

1. Obtain 6.0 licenses from SGI. See "Obtaining the License Keys from SGI" on page 110.
2. Edit the `/etc/lk/keys.dat` file on all server-capable administration nodes:
  - a. Add the new 6.0 license keys
  - b. Delete the 5.0 licenses

To verify the licenses, see "Verifying the License Keys" on page 111.

3. Follow the steps in "General Upgrade Procedure" on page 285.

## General Upgrade Procedure

To upgrade a CXFS cluster, do the following:

1. Ensure all server-capable administration nodes are running the same previous software release.
2. Upgrade the *standby node* (say `admin2`), which is a server-capable administration node that is configured as a potential metadata server for a given filesystem. (See the release notes and Chapter 7, "Server-Capable Administration Node Installation" on page 123.) Then reboot the standby node.
3. For the first server-capable administration node that is an active metadata server (say `admin1`), move all CXFS filesystems running on it to the standby node (`admin2`), making the standby node now the active metadata server for those filesystems. Do the following:

```
admin1# /sbin/chkconfig grio2 off (if using GRIO)
admin1# /sbin/chkconfig cxfs off
admin1# /sbin/chkconfig cxfs_cluster off
admin1# reboot
```

---

**Note:** When performing upgrades, you should not make any other configuration changes to the cluster (such as adding new nodes or filesystems) until the upgrade of all nodes is complete and the cluster is running normally.

---

4. Upgrade the server-capable administration node (`admin1`). See the release notes and Chapter 7, "Server-Capable Administration Node Installation" on page 123.
5. Return the upgraded server-capable administration node (`admin1`) to the cluster. Do the following:

```
admin1# /sbin/chkconfig cxfs_cluster on
admin1# /sbin/chkconfig cxfs on
admin1# /sbin/chkconfig grio2 on (if using GRIO)
admin1# reboot
```

---

**Note:** Skip steps 6, 7, and 8 if your cluster has only two server-capable administration nodes.

---

6. For the next server-capable administration node that is an active metadata server (say `admin3`), move all CXFS filesystems running on it to the standby node (making the standby node now the active metadata server for those filesystems). Do the following to force recovery:

```
admin3# /sbin/chkconfig grio2 off (if using GRIO)
admin3# /sbin/chkconfig cxfs off
admin3# /sbin/chkconfig cxfs_cluster off
admin3# reboot
```

7. Upgrade the server-capable administration node (`admin3`). See the release notes and Chapter 7, "Server-Capable Administration Node Installation" on page 123.
8. Return the upgraded server-capable administration node (`admin3`) to the cluster. Do the following:

```
admin3# /sbin/chkconfig cxfs_cluster on
admin3# /sbin/chkconfig cxfs on
admin3# /sbin/chkconfig grio2 on (if using GRIO)
admin3# reboot
```

If your cluster has additional server-capable administration nodes, repeat steps 6 through 8 for each remaining server-capable administration node.

9. Return the first CXFS filesystem to the server-capable administration node that you want to be its metadata server (making it the active metadata server, say `admin1`). Do the following:
  - a. Enable relocation on the current active metadata server (`admin2`) by using the `cxfs_relocation_ok` system tunable parameter. See "Relocation" on page 26.
  - b. For each filesystem for which `admin2` is the now the active metadata server, manually relocate the metadata services back to the original metadata server (`admin1`) by using the CXFS GUI or `cxfs_admin`. For example:

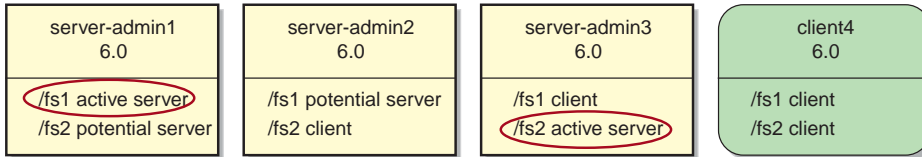
```
cxfs_admin:mycluster> relocate fs1 server=admin1
```
  - c. Disable relocation. See "Relocation" on page 26.
10. Return the next CXFS filesystem to the server-capable administration node that you want to be its metadata server (make it the active metadata server, say `admin3`). Repeat this step as needed for each CXFS filesystem.

11. Upgrade the client-only nodes. See the release notes for each platform and the *CXFS 6 Client-Only Guide for SGI InfiniteStorage*.

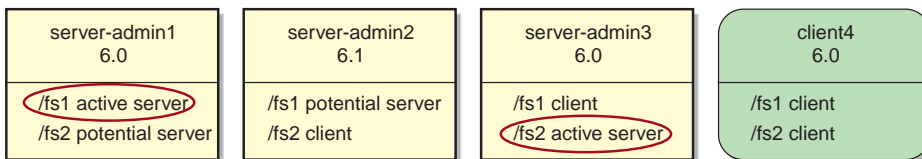
### **Example Upgrade Process**

The following figures show an example upgrade procedure for a cluster with three server-capable administration nodes and two filesystems (`/fs1` and `/fs2`), in which all nodes are running CXFS 6.0 at the beginning and Node2 is the standby node, and the cluster is upgrading to the hypothetical 6.1.

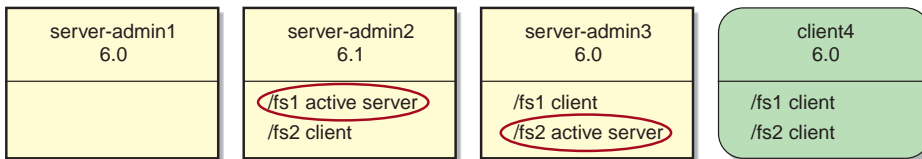
1 Starting configuration, all nodes running 6.0:



2 Upgrade server-admin2 to 6.1 and then reboot server-admin2:



3 On server-admin1, run `chkconfig parameter off` and then reset and then reboot server-admin1 to force recovery of /fs1 onto server-admin2:



4 Upgrade server-admin1 to 6.1:

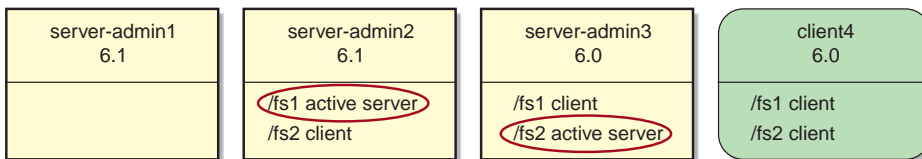
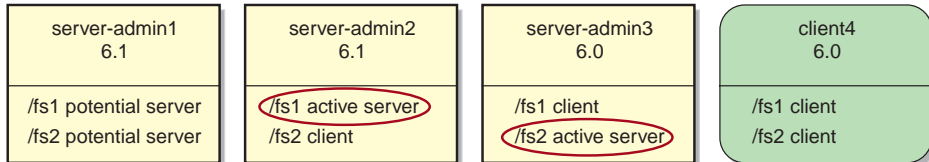


Figure 12-2 Example Rolling Upgrade Procedure (part 1)

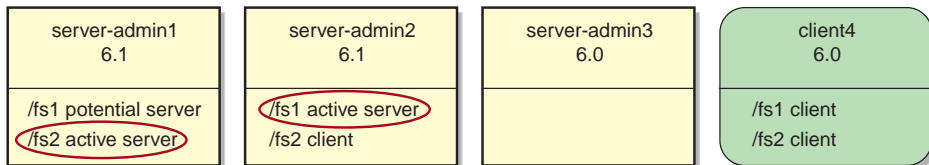


- 5 On server-admin1, run `chkconfig parameter on` and then reset server-admin1:

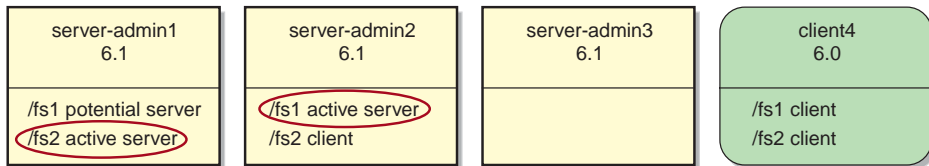
**Note:** Ensure that there will be no I/O that will be restarted from server-admin1 to /fs1 or /fs2 after server-admin1 is reset.



- 6 On server-admin3, run `chkconfig parameter off` and then reset server-admin3 to force recovery of /fs2 onto server-admin1:



- 7 Upgrade server-admin3 to 6.1:



- 8 On server-admin3, run `chkconfig parameter on` and then reset server-admin3:

**Note:** Ensure that there will be no I/O that will be restarted from server-admin3 to /fs2 after server-admin3 is reset.

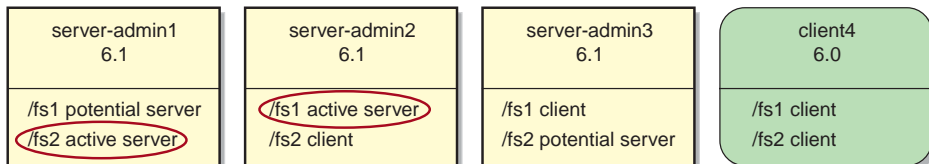
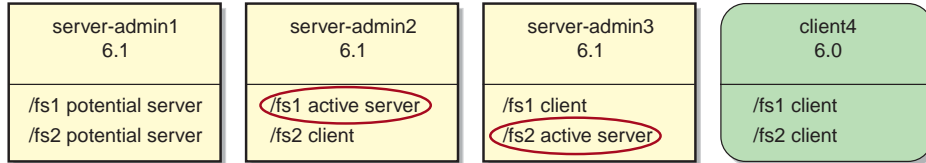


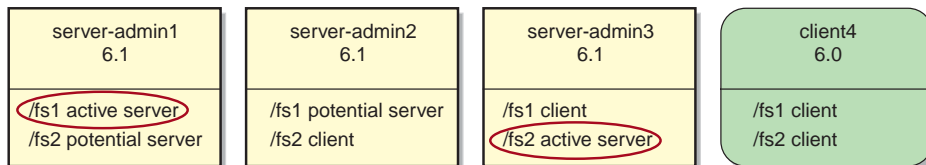
Figure 12-3 Example Rolling Upgrade Procedure (part 2)

- 9 To return the active metadata server for /fs2 to server-admin3, reset server-admin1:

**Note:** Ensure that there will be no I/O that will be restarted from server-admin1 to /fs2 after server-admin1 is reset.



- 10 To return the active metadata server for /fs1 to server-admin1, reset server-admin2:



- 11 Upgrade the client-only server-admin4 to 6.1 (repeat for all other client-only nodes):

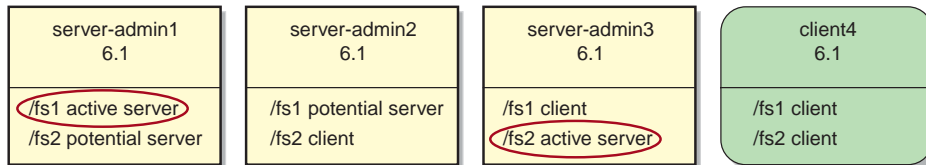


Figure 12-4 Example Rolling Upgrade Procedure (part 3)

## CXFS Relocation Capability

---

**Note:** Relocation is disabled by default.

---

To use relocation, you must enable relocation on the active metadata server. To enable relocation, reset the `cxfs_relocation_ok` parameter as follows:

- Enable at run time:

```
MDS# sysctl -w fs.cxfs.cxfs_relocation_ok=1
```

- Enable at reboot by adding the following line to `/etc/modprobe.conf.local`:

```
options sgi-cxfs cxfs_relocation_ok=1
```

To disable relocation, do the following:

- Disable at run time:

```
MDS# sysctl -w fs.cxfs.cxfs_relocation_ok=0
```

- Disable at reboot by adding the following line to `/etc/modprobe.conf` or `/etc/modprobe.conf.local`:

```
options sgi-cxfs cxfs_relocation_ok=0
```

See also "Relocation" on page 26.

## CXFS and Cluster Administration Initialization Commands

Table 12-1 summarizes the `/etc/init.d` initialization commands used for the CXFS control daemon and the cluster administration daemons. For more information about commands, see "CXFS Tools" on page 38.

**Table 12-1** Initialization Commands

Command	Arguments	Description
<code>service cxfs_client</code>	<code>start</code> <code>stop</code> <code>restart</code> <code>status</code>	Starts, stops, restarts (stops and then starts), or gives the status (running or stopped) of <code>cxfs_client</code> daemon (the client daemon) on the local node
<code>service cxfs_cluster</code>	<code>start</code> <code>stop</code> <code>restart</code> <code>status</code>	Starts, stops, restarts, or gives the status of <code>fs2d</code> , <code>cmond</code> , <code>cad</code> , and <code>crsd</code> (the cluster administration daemons) on the local node
<code>service cxfs</code>	<code>start</code> <code>stop</code> <code>restart</code> <code>status</code>	Starts, stops, restarts, or gives the status of <code>clconfd</code> (the CXFS server-capable administration node control daemon) on the local node
<code>service grio2</code>	<code>start</code> <code>stop</code> <code>restart</code> <code>status</code>	Starts, stops, restarts, or gives the status of <code>ggrd2</code> (the GRIOV2 daemon) on the local node

## Using `hafence`

To query the fencing status of a node, or raise or lower the fence for a node, you will normally use commands within `cxfs_admin`. See "Fencing Tasks with `cxfs_admin`" on page 277.

You can also run the following command on a server-capable administration node:

```
server-admin# /usr/cluster/bin/hafence -a -s switchname -u username -p password -m mask [-L vendorname]
```

To raise the fence for a node:

```
server-admin# /usr/cluster/bin/hafence -r nodename
```

To lower the fence for a node:

```
server-admin# /usr/cluster/bin/hafence -l nodename
```

To query switch status:

```
server-admin# /usr/cluster/bin/hafence -q -s switchname
```

Usage notes:

- -a adds or changes a switch in the cluster database.
- -l lowers the fence for the specified node.
- -L specifies the vendor name, which loads the appropriate plug-in library for the switch. If you do not specify the vendor name, the default is `brocade`.
- -m specifies one of the following:

- A list of ports in the switch that will never be fenced. The list has the following form, beginning with the # symbol, separating each port number with a comma, and enclosed within quotation marks:

```
"#port, port, port . . ."
```

Each *port* is a decimal integer in the range 0 through 1023. For example, the following indicates that port numbers 2, 4, 5, 6, 7, and 23 will never be fenced:

```
-m "#2,4,5,6,7,23"
```

- A hexadecimal string that represents ports in the switch that will never be fenced. Ports are numbered from 0. If a given bit has a binary value of 0, the port that corresponds to that bit is eligible for fencing operations; if 1, then the port that corresponds to that bit will always be excluded from any fencing operations. For an example, see Figure 10-5 on page 204.

Server-capable administration nodes automatically discover the available HBAs and, when fencing is triggered, fence off all of the Fibre Channel HBAs when the `Fence` or `FenceReset` fail policy is selected. However, masked HBAs will not be fenced. Masking allows you to prevent the fencing of devices that are attached to the SAN but are not shared with the cluster, to ensure that they remain available regardless of CXFS status. You would want to mask HBAs used for access to tape storage, or HBAs that are only ever used to access local (nonclustered) devices.

- -p specifies the password for the specified *username*.
- -q queries switch status.
- -r raises the fence for the specified node.

- `-s` specifies the hostname of the Fibre Channel switch; this is used to determine the IP address of the switch.
- `-u` specifies the user name to use when sending a telnet message to the switch.

For example, the following defines a QLogic switch named `myqlswitch` and uses no masking:

```
server-admin# /usr/cluster/bin/hafence -a -s myqlswitch -u admin -p *** -L qlogic
```

---

**Note:** Vendor plugin libraries should be installed in a directory that is in the platform-specific search path of the dynamic linker, typically the same location as the fencing library, `libcrf.so`. The above command line will attempt to load the `libcrf_qlogic.so` library.

---

The following masks port numbers 2 and 3:

```
server-admin# /usr/cluster/bin/hafence -a -s myqlswitch -u admin -p *** -m "#2,3" -L qlogic
```

The following lowers the fence for `client1`:

```
server-admin# /usr/cluster/bin/hafence -l client1
```

The following raises the fence for `client1`:

```
server-admin# /usr/cluster/bin/hafence -r client1
```

The following queries port status for all switches defined in the cluster database:

```
server-admin# /usr/cluster/bin/hafence -q
```

For more information, see the `hafence(8)` man page. See the release notes for supported switches.

## Firewalls and CXFS Port Usage

The CXFS private network should be restricted to CXFS use only. If there are daemons other than CXFS daemons that are running on systems attached to the private network, they should be configured to only listen for connections on the public networks. A firewall on the CXFS private network should not be required. However, if a firewall is used, CXFS uses the following ports:

- Fencing requires TCP port 23 for `telnet` access.
- The RPC port mapper requires UDP port 111 and TCP port 111.
- The `fs2d` daemon is RPC-based and is dynamically assigned on a TCP port in the range of 600-1023. The instance of `fs2d` that determines the cluster database membership also uses TCP port 5449.
- The `crsd` daemon defaults to UDP port 7500 and is set in `/etc/services`:

```
sgi-crsd          7500/tcp
```

- The CXFS kernel uses ports 5450 through 5453 (TCP for ports 5450 and 5451, UDP for ports 5052 and 5053).
- The server-capable administration node that is the quorum master uses UDP port 5449. (See "Determine the Quorum Master" on page 390.)
- The `cad` daemon defaults to TCP port 9000 and is set in `/etc/services`:

```
sgi-cad          9000/tcp
```

## chkconfig Arguments

Table 12-2 summarizes the CXFS `chkconfig` arguments for server-capable administration nodes.

**Table 12-2** `chkconfig` Arguments for Server-Capable Administration Nodes

Argument	Description
<code>cxfs_cluster</code>	Controls the cluster administration daemons ( <code>fs2d</code> , <code>crsd</code> , <code>cad</code> , and <code>cmond</code> ). If this argument is <code>off</code> , the database daemons will not be started at the next reboot and the local copy of the database will not be updated if you make changes to the cluster configuration on the other nodes. This could cause problems later, especially if a majority of nodes are not running the database daemons. If the database daemons are not running, the cluster database will not be accessible locally and the node will not be configured to join the cluster.
<code>cxfs</code>	Controls the <code>clconfd</code> daemon and whether or not the <code>cxfs_shutdown</code> command is used during a system shutdown. The <code>cxfs_shutdown</code> command attempts to withdraw from the cluster gracefully before rebooting. Otherwise, the reboot is seen as a failure and the other nodes must recover from it.
<b>Note:</b> <code>clconfd</code> cannot start unless <code>fs2d</code> is already running.	
<code>fam</code>	Starts the file alteration monitoring ( <code>fam</code> ) service, which is required to use the CXFS GUI on Linux nodes.

These settings can be modified by the CXFS GUI or by the administrator. These settings only control the processes, not the cluster. Stopping the processes that control the cluster will not stop the cluster (that is, will not drop the cluster membership or lose access to CXFS filesystems and cluster volumes), and starting the processes will start the cluster **only** if the CXFS services are marked as activated in the database.

The following shows the settings of the arguments on server-capable administration nodes:

```
server-admin# chkconfig --list | grep cxfs fam
cxfs_cluster 0:off 1:off 2:on 3:on 4:on 5:on 6:off
cxfs         0:off 1:off 2:on 3:on 4:on 5:on 6:off
fam          0:off 1:off 2:on 3:on 4:on 5:on 6:off
```



## Granting Task Execution Privileges for Users

The CXFS GUI lets you grant or revoke access to a specific GUI task for one or more specific users. By default, only `root` may execute tasks in the GUI. For instructions, see "Privileges Tasks with the GUI" on page 218.

The `cxfs_admin` command lets you grant access permission to specific nodes using the `access allow|deny` subcommands. See "Setting `cxfs_admin` Access Permissions" on page 230.

## Transforming a Server-Capable Administration Node into a Client-Only Node

You should install a node as a server-capable administration node only if you intend to use it as a potential metadata server. All other nodes should be installed as client-only nodes. See "Make Most Nodes Client-Only" on page 54.

To transform a server-capable administration node into a client-only node, do the following:

1. Ensure that the node is not listed in the cluster database as a potential metadata server for any filesystem.
2. Stop the CXFS services on the node.
3. Modify the cluster so that it no longer contains the node.
4. Delete the node definition.
5. Remove the packages listed in "CXFS Software Products Installed on Server-Capable Administration Nodes" on page 37 from the node.
6. Reboot the node to ensure that all previous node configuration information is removed.
7. Install client-only software as documented in the *CXFS 6 Client-Only Guide for SGI InfiniteStorage*.
8. Define the node as a client-only node.
9. Modify the cluster so that it contains the node if you are using the GUI. (This step is handled by `cxfs_admin` automatically.)
10. Start CXFS services on the node.

For more information about these tasks, see:

- Chapter 10, "CXFS GUI" on page 157
- Chapter 11, "cxfs\_admin Command" on page 223

## CXFS Mount Scripts

On server-capable administration nodes, the following scripts are provided for execution by the `clconfd` daemon prior to and after a CXFS filesystem is mounted or unmounted:

```
/var/cluster/clconfd-scripts/cxfs-pre-mount  
/var/cluster/clconfd-scripts/cxfs-post-mount  
/var/cluster/clconfd-scripts/cxfs-pre-umount  
/var/cluster/clconfd-scripts/cxfs-post-umount
```

The following script is run when needed to reprobe the Fibre Channel controllers on server-capable administration nodes:

```
/var/cluster/clconfd-scripts/cxfs-reprobe
```

You can customize these scripts to suit a particular environment. For example, an application could be started when a CXFS filesystem is mounted by extending the `cxfs-post-mount` script. The application could be terminated by changing the `cxfs-pre-umount` script.

On server-capable administration nodes, these scripts also allow you to use NFS to export the CXFS filesystems listed in `/etc/exports` if they are successfully mounted.

The appropriate daemon executes these scripts before and after mounting or unmounting CXFS filesystems specified in the `/etc/exports` file. The files must be named **exactly** as above and must have `root` execute permission.

---

**Note:** The `/etc/exports` file describes the filesystems that are being exported to NFS clients. If a CXFS mount point is included in the `exports` file, the empty mount point is exported unless the filesystem is re-exported after the CXFS mount using the `cxfs-post-mount` script.

---

The following arguments are passed to the files:

- `cxfs-pre-mount`: filesystem device name and CXFS mounting point

- `cxfs-post-mount`: filesystem device name, CXFS mounting point, and exit code
- `cxfs-pre-umount`: filesystem device name and CXFS mounting point
- `cxfs-post-umount`: filesystem device name, CXFS mounting point, and exit code

Because the filesystem device name is passed to the scripts, you can write the scripts so that they take different actions for different filesystems; because the exit codes are passed to the `-post-` files, you can write the scripts to take different actions based on success or failure of the operation.

The `clconfd` or `cxfs_client` daemon checks the exit code for these scripts. In the case of failure (nonzero), the following occurs:

- For `cxfs-pre-mount` and `cxfs-pre-umount`, the corresponding mount or unmount is not performed
- For `cxfs-post-mount` and `cxfs-post-umount`, `clconfd` will retry the entire operation (including the `-pre-` script) for that operation

This implies that if you **do not** want a filesystem to be mounted on a host, the `cxfs-pre-mount` script should return a failure for that filesystem while the `cxfs-post-mount` script returns success.

---

**Note:** After the filesystem is unmounted, the mount point is removed.

---

For information about the mount scripts on client-only nodes, see the *CXFS 6 Client-Only Guide for SGI InfiniteStorage*.

## Using the Data Migration Facility (DMF)

DMF must make all of its DMAPI interface calls through the CXFS active metadata server. The CXFS client nodes do not provide a DMAPI interface to CXFS mounted filesystems. A CXFS client routes all of its communication to DMF through the metadata server. This generally requires that DMF run on the CXFS metadata server. If DMF is managing a CXFS filesystem, DMF will ensure that the filesystem's CXFS metadata server is the DMF server and will use metadata server relocation if necessary to achieve that configuration.

---

**Note:** DMF data mover processes must only run on the DMF server node and any parallel data mover nodes. Do not run data mover processes on CXFS standby metadata server nodes.

---

DMF requires independent paths to tape drives so that they are not fenced by CXFS. The ports for the tape drive paths on the switch should be masked from fencing in a CXFS configuration.

The SAN must be zoned so that XVM does not failover CXFS filesystem I/O to the paths visible through the tape HBA ports when Fibre Channel port fencing occurs. Therefore, either independent switches or independent switch zones should be used for CXFS/XVM volume paths and DMF tape drive paths.

To use DMF with CXFS, do the following:

- For server-capable administration nodes, install the `sgi-dmapi` and `sgi-xfsplogs` packages from the SGI InfiniteStorage Software Platform (ISSP) release. These are part of the **DMF Server** and **DMF Parallel Data Mover** YaST patterns. The DMF software will automatically enable DMAPI, which is required to use the `dmi` mount option.

For CXFS client-only nodes, no additional software is required.

- When using the Parallel Data Mover Option, install the **DMF Parallel Data Mover** software package, which includes the required underlying CXFS client-only software. (From the CXFS cluster point of view, the DMF parallel data mover node is a CXFS client-only node but one that is dedicated to DMF data mover activities.)
- Use the `dmi` option when mounting a filesystem to be managed.
- Start DMF on the CXFS active metadata server for each filesystem to be managed.

For more information about DMF, see the *DMF 5 Administrator's Guide for SGI InfiniteStorage*.

## Discovering the Active Metadata Server

This section discusses how to discover the active metadata server using various tools:

- "CXFS GUI and the Active Metadata Server" on page 301
- "cxfs\_admin and the Active Metadata Server" on page 302
- "clconf\_info and the Active Metadata Server" on page 303

### CXFS GUI and the Active Metadata Server

To use the GUI to discover the active metadata server for a filesystem, do the following:

1. Select **View: Filesystems**
2. In the view area, click the name of the filesystem you wish to view. The name of the active metadata server is displayed in the details area to the right.

Figure 12-5 shows an example.

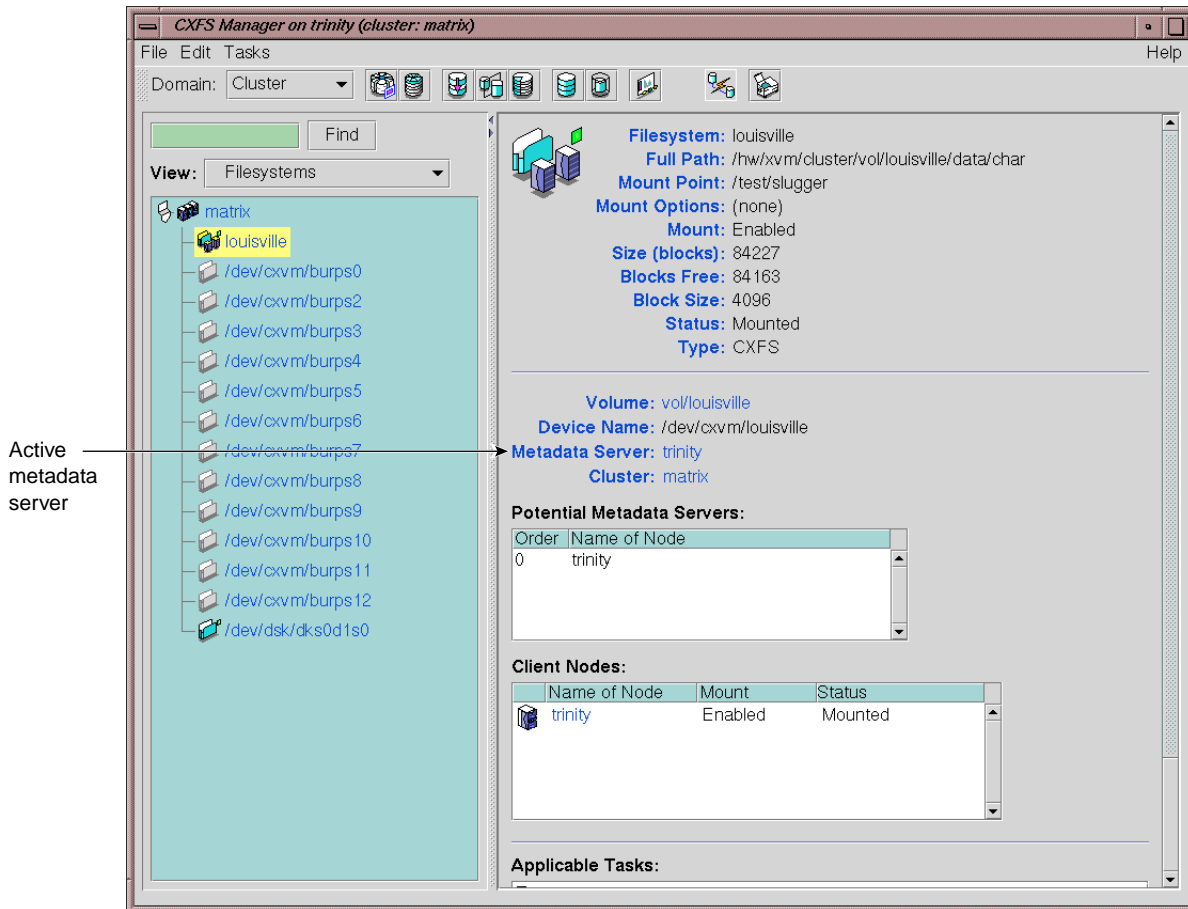


Figure 12-5 GUI Window Showing the Metadata Server

### cxfs\_admin and the Active Metadata Server

To use `cxfs_admin` to discover the active metadata server for a filesystem, do the following:

- To show information for all filesystems, including their active metadata servers:

```
show server
```

For example:

```
cxfs_admin:clusterOne> show server
Event at [ Oct 22 12:33:43 ]
filesystem:zj01s0:status:server=bert
filesystem:zj01s1:status:server=cxfsxe5
```

- To show the active metadata server for a specific filesystem:

```
show [filesystem:]filesystem:status:server
```

In the above, you could abbreviate `status` to `*`. For example, if filesystem `zj01s1` is a unique name in the cluster database:

```
cxfs_admin:clusterOne> show zj01s1:*:server
Event at [ Oct 22 12:34:43 ]
filesystem:zj01s1:status:server=cxfsxe5
```

## clconf\_info and the Active Metadata Server

You can use the `clconf_info` command to discover the active metadata server for a given filesystem. For example, the following shows that `bert` is the metadata server for `zj01s0`:

```
# /usr/cluster/bin/clconf_info
```

```
Event at [2009-10-22 12:37:33]
```

```
Membership since Wed Oct 21 13:34:43 2009
```

Node	NodeID	Status	Age	CellID
cxfsxe5	1	up	44	1
bert	3	up	33	0
pg-27	4	up	1	5
penguin17	5	up	54	4
cxfsxe10	6	inactive	-	3

```
2 CXFS FileSystems
```

```
/dev/cxvm/zj01s1 on /mnt/zj01s1 enabled server=(cxfsxe5) 3 client(s)=(bert,penguin17,pg-27) status=UP
/dev/cxvm/zj01s0 on /mnt/zj01s0 enabled server=(bert) 3 client(s)=(cxfsxe5,penguin17,pg-27) status=UP
```

## Shutdown of the Database and CXFS

This section tells you how to perform the following:

- "Cluster Database Shutdown" on page 304
- "Normal CXFS Shutdown: Stop CXFS Services or Disable the Node" on page 305
- "Forced CXFS Shutdown: Revoke Membership of Local Node" on page 307

For more information about states, Chapter 14, "Monitoring Status" on page 363. If there are problems, see Chapter 15, "Troubleshooting" on page 375.

### Cluster Database Shutdown

A *cluster database shutdown* terminates the following user-space daemons that manage the cluster database:

```
cad
clconfd
cmond
crsd
fs2d
```

After shutting down the database on a node, access to the shared filesystems remains available and the node is still a member of the cluster, but the node is not available for database updates. Rebooting the node results in a restart of all services (restarting the daemons, joining cluster membership, enabling cluster volumes, and mounting CXFS filesystems).

To perform a cluster database shutdown, enter the following on a server-capable administration node:

```
server-admin# killall -TERM clconfd
server-admin# service cxfs_cluster stop
```

If you also want to disable the daemons from restarting at boot time, enter the following:

```
server-admin# /sbin/chkconfig grio2 off (If running GRIOv2)
server-admin# /sbin/chkconfig cxfs off
server-admin# /sbin/chkconfig cxfs_cluster off
```

For more information, see "chkconfig Arguments" on page 296.



## Node Status and Cluster Database Shutdown

A cluster database shutdown is appropriate when you want to perform a maintenance operation on the node and then reboot it, returning it to `ACTIVE` status (as displayed by the GUI) or `stable` status (as displayed by `cxfs_admin`).

If you perform a cluster database shutdown, the node status will be `DOWN` in the GUI or `inactive` in `cxfs_admin`, which has the following impacts:

- The node is still considered part of the cluster, but is unavailable.
- The node does not get cluster database updates; however, it will be notified of all updates after it is rebooted.

Missing cluster database updates can cause problems if the kernel portion of CXFS is active. That is, if the node continues to have access to CXFS, the node's kernel level will not see the updates and will not respond to attempts by the remaining nodes to propagate these updates at the kernel level. This in turn will prevent the cluster from acting upon the configuration updates.

---

**Note:** If the cluster database is shut down on more than half of the server-capable administration nodes, changes cannot be made to the cluster database.

---

## Restart the Cluster Database

To restart the cluster database, enter the following:

```
server-admin# service cxfs_cluster start
server-admin# service cxfs start
```

## Normal CXFS Shutdown: Stop CXFS Services or Disable the Node

You should perform a *normal CXFS shutdown* in the GUI or disable a node in `cxfs_admin` when you want to stop CXFS services on a node and remove it from the CXFS kernel membership quorum.

A normal CXFS shutdown in the GUI does the following:

- Unmounts all the filesystems except those for which it is the active metadata server; those filesystems for which the node is the active metadata server will become inaccessible from the node after it is shut down.

- Terminates the CXFS kernel membership of this node.
- Marks the node as `INACTIVE` in the GUI and `disabled` in `cxfs_admin`.

The effect of this is that cluster disks are unavailable and no cluster database updates will be propagated to this node. Rebooting the node leaves it in the shutdown state.

If the node on which you shut down CXFS services is an active metadata server for a filesystem, then that filesystem will be recovered by another node that is listed as one of its potential metadata servers. The server that is chosen must be a filesystem client; other filesystem clients will experience a delay during the recovery process.

If the node on which the CXFS shutdown is performed is the sole potential metadata server (that is, there are no other nodes listed as potential metadata servers for the filesystem), then you should unmount the filesystem from all nodes before performing the shutdown.

The GUI task can operate on all nodes in the cluster or on the specified node; the `cxfs_admin disable` command operates on just a single specified node.

To perform a normal CXFS shutdown, see

- "Stop CXFS Services with the GUI" on page 197
- "Disable a Node with `cxfs_admin`" on page 251

### When You Should Not Perform Stop CXFS Services

You should not stop CXFS services under the following circumstances:

- If CXFS services are running on the *local node* (the server-capable administration node on which `cxfs_admin` is running or the node to which the CXFS GUI is connected)
- If stopping CXFS services on the node will result in loss of CXFS kernel membership quorum
- If the node is the only available potential metadata server for one or more active CXFS filesystems

To achieve a CXFS shutdown under these conditions, you must perform a forced CXFS shutdown. See "Forced CXFS Shutdown: Revoke Membership of Local Node" on page 307.

### Rejoining the Cluster after Stopping CXFS Services

The node will not rejoin the cluster after a reboot. The node will rejoin the cluster only after CXFS services are explicitly reactivated with the CXFS GUI or after the node is enabled using `cxfs_admin`.

### Forced CXFS Shutdown: Revoke Membership of Local Node

A *forced CXFS shutdown* (or *administrative CXFS stop*) is appropriate when you want to shutdown the local node even though it may drop the cluster below its CXFS kernel membership quorum requirement.

CXFS does the following:

- Shuts down all CXFS filesystems on the local node. Any attempts to access the CXFS filesystems will result in an I/O error (you may need to manually unmount the filesystems).
- Removes this node from the CXFS kernel membership.
- Marks the node as `DOWN` in the GUI or `inactive` in `cxfs_admin`.
- Disables access from the local node to cluster-owned XVM volumes.
- Treats the stopped node as a failed node and executes the fail policy defined for the node in the cluster database. See "Fail Policies" on page 64.



**Caution:** A forced CXFS shutdown may cause the cluster to fail if the cluster drops below CXFS kernel membership quorum.

---

If you do a forced CXFS shutdown on an active metadata server, it loses membership immediately. At this point, another potential metadata server must take over (and recover the filesystems) or quorum is lost and a forced CXFS shutdown follows on all nodes.

If you do a forced CXFS shutdown that forces a loss of quorum, the remaining part of the cluster (which now must also do an administrative stop) will **not** reset the departing node.

To perform an administrative stop, see:

- "Revoke Membership of the Local Node with the GUI" on page 201
- "Disable a Node with `cxfs_admin`" on page 251

### Node Status and Forced CXFS Shutdown

After a forced CXFS shutdown, the node is still considered part of the configured cluster and is taken into account when propagating the cluster database and when computing the cluster database (`fs2d`) membership quorum. (This could cause a loss of quorum for the rest of the cluster, causing the other nodes to do a forced CXFS shutdown). The state is `INACTIVE` in the GUI or `inactive` in `cxfs_admin`.

It is important that this node stays accessible and keeps running the cluster infrastructure daemons to ensure database consistency. In particular, if more than half the nodes in the pool are down or not running the infrastructure daemons, cluster database updates will stop being propagated and will result in inconsistencies. To be safe, you should remove those nodes that will remain unavailable from the cluster and pool.

### Rejoining the Cluster after a Forced CXFS Shutdown

After a forced CXFS shutdown, the local node will not resume CXFS kernel membership until the node is rebooted or until you explicitly allow CXFS kernel membership for the local node. See:

- "Allow Membership of the Local Node with the GUI" on page 201
- "Disable a Node with `cxfs_admin`" on page 251
- "Enable a Node with `cxfs_admin`" on page 251

If you perform a forced CXFS shutdown on a server-capable administration node, you must restart CXFS on that node before it can return to the cluster. If you do this while the cluster database still shows that the node is in the cluster and is activated, the node will restart the CXFS kernel membership daemon. Therefore, you may want to do this after resetting the database or after stopping CXFS services.

## Reset Capability and a Forced CXFS Shutdown

---



**Caution:** If you perform an administrative CXFS stop on a server-capable administration node with system reset capability and the stop will not cause loss of cluster quorum, the node will be reset (rebooted) by the appropriate node.

---

For more information about resets, see "System Reset" on page 56.

## Avoiding a CXFS Restart at Reboot

If the following `chkconfig` arguments are turned off, the `clconfd` and `cxfs_client` daemons on server-capable administration nodes and client-only nodes, respectively, will not be started at the next reboot and the kernel will not be configured to join the cluster:

- Server-capable administration nodes: `cxfs`
- Client-only nodes: `cxfs_client`

It is useful to turn these arguments off before rebooting if you want to temporarily remove the nodes from the cluster for system or hardware upgrades or for other maintenance work.

For example, do the following on a server-capable administration node:

```
server-admin# /sbin/chkconfig grio2 off (If running GRIOv2)
server-admin# /sbin/chkconfig cxfs off
server-admin# /sbin/chkconfig cxfs_cluster off
server-admin# reboot
```

For more information, see "chkconfig Arguments" on page 296.

## Log File Management

CXFS log files should be rotated at least weekly so that your disk will not become full.

A package that provides CXFS daemons also supplies scripts to rotate the log files for those daemons via `logrotate`. SGI installs the following scripts on server-capable administration nodes:

```
/etc/logrotate.d/cluster_admin  
/etc/logrotate.d/cluster_control  
/etc/logrotate.d/cxfs_cluster  
/etc/logrotate.d/grio2
```

To customize log rotation, edit these scripts.

For information about log levels, see "Configure Log Groups with the GUI" on page 200.

## Filesystem Maintenance

Although filesystem information is traditionally stored in `/etc/fstab`, the CXFS filesystems information is relevant to the entire cluster and is therefore stored in the replicated cluster database instead.

As the administrator, you will supply the CXFS filesystem configuration by using the CXFS GUI or `cxfs_admin`. The information is then automatically propagated consistently throughout the entire cluster. The cluster configuration daemon mounts the filesystems on each node according to this information, as soon as it becomes available.

A CXFS filesystem will be automatically mounted on all the nodes in the cluster. You can add a new CXFS filesystem to the configuration when the cluster is active.

Whenever the cluster configuration daemon detects a change in the cluster configuration, it does the equivalent of a `mount -a` command on all of the filesystems that are configured.



**Caution:** You must not modify or remove a CXFS filesystem definition while the filesystem is mounted. You must unmount it first and then mount it again after making the modifications.

---

This section discusses the following:

- "Mounting Filesystems" on page 311
- "Unmounting Filesystems" on page 311
- "Growing Filesystems " on page 312

## Mounting Filesystems

You supply mounting information with the CXFS GUI or `cxfs_admin`.



---

**Caution:** Do not attempt to use the `mount` command to mount a CXFS filesystem. Doing so can result in data loss and/or corruption due to inconsistent use of the filesystem from different nodes.

---

When properly defined and mounted, the CXFS filesystems are automatically mounted on each node by the local cluster configuration daemon, `clconfd`, according to the information collected in the replicated database. After the filesystems configuration has been entered in the database, no user intervention is necessary.

Mount points cannot be nested when using CXFS. That is, you cannot have a filesystem within a filesystem, such as `/usr` and `/usr/home`.

## Unmounting Filesystems

To unmount CXFS filesystems, use the CXFS GUI or `cxfs_admin`. These tools unmount a filesystem from all nodes in the cluster. Although this action triggers an unmount on all the nodes, some might fail if the filesystem is busy. On active metadata servers, the unmount cannot succeed before all of the CXFS clients have successfully unmounted the filesystem. All nodes will retry the unmount until it succeeds, but there is no centralized report that the filesystem has been unmounted on all nodes.

To verify that the filesystem has been unmounted from all nodes, do one of the following:

- Check the `SYSLOG` files on the metadata servers for a message indicating that the filesystem has been unmounted.

- Run the CXFS GUI or `cxfs_admin` on the metadata server, disable the filesystem from the server, and wait until the GUI shows that the filesystem has been fully disabled. (It will be an error if it is still mounted on some CXFS clients; the GUI will show which clients are left.)

## Growing Filesystems

To grow a CXFS filesystem, do the following:

1. Unmount the CXFS filesystem using the CXFS GUI or `cxfs_admin`.
2. Change the domain of the XVM volume from a cluster volume to a local volume using the XVM `give` command. See the *XVM Volume Manager Administrator's Guide*.
3. Mount the filesystem as an XFS filesystem using the `mount` command. For more information, see the `mount(8)` man page.
4. Use the `xfs_growfs` command or the CXFS GUI task; see "Grow a Filesystem with the GUI" on page 209.
5. Unmount the XFS filesystem. For more information, see the `umount(8)` man page.
6. Change the domain of the XVM volume back to a cluster volume using the `give` command.
7. Mount the filesystem as a CXFS filesystem by using the GUI or `cxfs_admin`

## Dump and Restore

You must perform the backup of a CXFS filesystem from the active metadata server for that filesystem. The `xfsdump` and `xfsrestore` commands make use of special system calls that will only function on the active metadata server. The filesystem can have active clients during a dump process.

In a clustered environment, a CXFS filesystem may be directly accessed simultaneously by many CXFS clients and the active metadata server. A filesystem may, over time, have a number of metadata servers. Therefore, in order for `xfsdump` to maintain a consistent inventory, it must access the inventory for past dumps, even if this information is located on another node. SGI recommends that the inventory be made accessible by potential metadata server nodes in the cluster using one of the following methods:



- Relocate the inventory to a shared filesystem. For example, where *shared\_filesystem* is replaced with the actual name of the filesystem to be shared:

- On the server-capable administration node currently containing the inventory, enter the following:

```
inventoryadmin# cd /var/lib
inventoryadmin# cp -r xfsdump /shared_filesystem
inventoryadmin# mv xfsdump xfsdump.bak
inventoryadmin# ln -s /shared_filesystem/xfsdump xfsdump
```

- On all other server-capable administration nodes in the cluster, enter the following:

```
otheradmin# cd /var/lib
otheradmin# mv xfsdump xfsdump.bak
otheradmin# ln -s /shared_filesystem/xfsdump xfsdump
```

- Export the directory using an NFS shared filesystem. For example:

- On the server-capable administration node currently containing the inventory, add `/var/lib/xfsdump` to `/etc/exports` and then enter the following:

```
inventoryadmin# exportfs -a
```

- On all other server-capable administration nodes in the cluster, enter the following:

```
otheradmin# cd /var/lib
otheradmin# mv xfsdump xfsdump.bak
otheradmin# ln -s /net/hostname/var/lib/xfsdump xfsdump
```

---

**Note:** It is the `/var/lib/xfsdump` directory that should be shared, rather than the `/var/lib/xfsdump/inventory` directory. If there are inventories stored on various nodes, you can use `xfsinvutil` to merge them into a single common inventory, prior to sharing the inventory among the nodes in the cluster.

---

## Hardware Changes and I/O Fencing

If you use I/O fencing and then make changes to your hardware configuration, you must verify that switch ports are properly enabled so that they can discover the WWPN of the HBA for I/O fencing purposes.

You must check the status of the switch ports involved whenever any of the following occur:

- An HBA is replaced on a node
- A new node is plugged into the switch for the first time
- A Fibre Channel cable rearrangement occurs

---

**Note:** Shut down the affected nodes before rearranging cables.

---

To check the status, use the following command on a server-capable administration node:

```
server-admin# /usr/cluster/bin/hafence -v
```

If any of the affected ports are disabled, you must manually enable them before starting CXFS on the affected nodes:

1. Connect to the switch using `telnet`.
2. Use the `portenable` command to enable the port.
3. Close the `telnet` session.

After the port is enabled, the metadata server will be able to discover the new (or changed) WWPN of the HBA connected to that port and thus correctly update the switch configuration entries in the cluster database.

## Private Network Failover

This section provides an example of modifying a cluster to provide private network failover. Do the following:

1. Create the failover network subnets. For example:

```
cxfs_admin:mycluster> create failover_net network=192.168.0.0 mask=255.255.255.0
cxfs_admin:mycluster> create failover_net network=192.168.1.0 mask=255.255.255.0
```

2. Disable all nodes (which shuts down the cluster):

```
cxfs_admin:mycluster> disable node:*
```

3. Update each node to include a private network. For example:

```
cxfs_admin:mycluster> modify red private_net=192.168.0.1,192.168.1.1
cxfs_admin:mycluster> modify yellow private_net=192.168.0.2,192.168.1.2
```

4. Enable all nodes:

```
cxfs_admin:mycluster> enable node:*
```

For more information, see Chapter 11, "cxfs\_admin Command" on page 223.

## Cluster Member Removal and Restoration

This section discusses removing and restoring cluster members for maintenance:

- "Manually Starting/Stopping CXFS" on page 316
- "Removing a Metadata Server from the Cluster Membership" on page 316
- "Restoring a Server-Capable Administration Node to the Cluster Membership" on page 318
- "Adding a New Server-Capable Administration Node to an Existing Cluster" on page 318
- "Adjusting the Cell ID Numbers" on page 323
- "Removing a Single Client-Only Node from the Cluster" on page 329
- "Restoring a Single Client-Only Node to the Cluster" on page 330
- "Stopping CXFS for the Entire Cluster" on page 331
- "Restarting the Entire Cluster" on page 332

These procedures are the safest way to perform these tasks but in some cases are not the most efficient. You should follow them if you have been having problems using standard operating procedures (performing a stop/start of CXFS services or a simple host shutdown or reboot).

## Manually Starting/Stopping CXFS

---

**Note:** If you are going to perform maintenance on a potential metadata server, you should first shut down CXFS services on it. Disabled nodes are not used in CXFS kernel membership calculations, so this action may prevent a loss of quorum.

---

On server-capable administration nodes, the `service cxfs_cluster` script is invoked automatically during normal system startup and shutdown procedures. (On client-only nodes, the path to the `cxfs_client` script varies by platform; see *CXFS 6 Client-Only Guide for SGI InfiniteStorage*.) This script starts and stops the processes required to run CXFS.

To start up CXFS processes manually on a server-capable administration node, enter the following commands:

```
server-admin# service grio2 start (if running GRIOv2)
server-admin# service cxfs_cluster start
server-admin# service cxfs start
```

To stop CXFS processes manually on a server-capable administration node, enter the following commands:

```
server-admin# service grio2 stop (stops GRIOv2 daemons)
server-admin# service cxfs stop (stops the CXFS server-capable administration node control daemon)
server-admin# service cxfs_cluster stop (stops the cluster administration daemons)
```

---

**Note:** There is also a `restart` option that performs a stop and then a start.

---

## Removing a Metadata Server from the Cluster Membership

If you have a cluster with multiple active metadata servers and you must perform maintenance on one of them, you must stop CXFS services on it.

To remove an active metadata server (`admin1`, for example) from the cluster membership, do the following:

1. Enable relocation by using the `cxfs_relocation_ok` system tunable parameter. See "Relocation" on page 26.

2. For each filesystem for which `admin1` is the active metadata server, manually relocate the metadata services from `admin1` to one of the other potential metadata servers (such as `admin2`) by using the CXFS GUI or `cxfs_admin`. For example:

```
cxfs_admin:mycluster> relocate fs1 server=admin2
```

3. Disable relocation. See "Relocation" on page 26.

---

**Note:** If you do not perform steps 1–3 in a system reset configuration, `admin1` will be reset shortly after losing its membership. The machine will also be configured to reboot automatically instead of stopping in the PROM. This means that you must watch the console and intervene manually to prevent a full reboot.

In a fencing configuration, `admin1` will lose access to the SAN when it is removed from the cluster membership.

---

4. Stop CXFS services for `admin1` by using the CXFS GUI or `cxfs_admin` running on another metadata server. For example:

```
cxfs_admin:mycluster> disable admin1
```

5. Shut down `admin1`.

If you do not want the cluster administration daemons and the CXFS control daemon to run during maintenance, execute the following commands:

```
admin1# /sbin/chkconfig grio2 off (if running GRIOV2)
admin1# /sbin/chkconfig cxfs off
admin1# /sbin/chkconfig cxfs_cluster off
```

If you do an upgrade of the cluster software, these arguments will be automatically reset to `on` and the cluster administration daemons and the CXFS control daemon will be started.

For more information, see "chkconfig Arguments" on page 296.

## Restoring a Server-Capable Administration Node to the Cluster Membership

To restore a server-capable administration node to the cluster, do the following:

1. Allow the cluster administration daemons, CXFS control daemon, and GRIOV2 daemon (if using GRIOV2) to be started upon reboot:

```
admin1# /sbin/chkconfig cxfs on
admin1# /sbin/chkconfig cxfs_cluster on
admin1# /sbin/chkconfig grio2 on (if using GRIOV2)
```

2. Immediately start cluster administration daemons on the node:

```
exMD# service cxfs_cluster start
```

3. Immediately start the CXFS control daemon on the node:

```
admin1# service cxfs start
```

4. Immediately start the GRIOV2 daemon on the node (if using GRIOV2):

```
admin1# service grio2 start
```

## Adding a New Server-Capable Administration Node to an Existing Cluster

To avoid problems, SGI recommends that the server-capable administration nodes all have lower cell ID numbers than any client-only nodes; see "Create an Initial Cluster of All Server-Capable Administration Nodes" on page 54. The cell ID number is established by CXFS when a node is added to the cluster definition, which happens automatically with `cxfs_admin` when you define a node.

If you want to add a new server-capable administration node to an existing cluster, you must determine if there is an available cell ID number for it that will be lower than the cell ID of any client-only node, or reconfigure the cluster definition so that such a number becomes available.

Following is an overview of the steps required:

1. Use the `cxfs_admin status` command to determine the current cell IDs.

---

**Note:** The GUI does not display cell ID numbers.

---

2. If a low cell ID number is available, define the new server-capable administration node with `cxfs_admin` (or use the corresponding GUI tasks to define the node and add it to the cluster).

3. If no low cell ID number is available, free the lowest cell ID that applies to a client-only node by using the `cxfs_admin disable` and `detach` commands to remove the associated client-only node from the cluster definition (or use the corresponding GUI task to remove the node from the cluster definition).

---

**Note:** Disabling a node will unmount CXFS filesystems and stop CXFS services on that node.

---

4. Define the new server-capable administration node with `cxfs_admin`, which automatically adds it to the cluster definition and assigns a cell ID number (or use the GUI tasks to define the node and add it to the cluster).
5. Restore the client-only node to the cluster definition by using the `cxfs_admin attach` and `enable` commands (or use the GUI task to add it to the cluster definition).
6. Use the `cxfs_admin status` command again to verify that the new server-capable administration node has a lower cell ID number than any client-only node.

The following sections provide detailed examples using `cxfs_admin`:

- "Add Server: Low Cell ID Number is Available" on page 319
- "Add Server: No Low Cell ID Number is Available" on page 321

---

**Note:** To use the GUI, see the following sections:

- "Add or Remove Nodes in the Cluster with the GUI" on page 188
  - "Define a Node with the GUI" on page 179
- 

### Add Server: Low Cell ID Number is Available

The following example (output truncated) shows the following:

- `mds1` and `mds2` are server-capable administration nodes (indicated by the `a *` character)
- `clientA` has the lowest cell ID (3) of any client-only node
- There is an available low cell ID number (2) between the current set of server-capable administration nodes (0 and 1) and the client-only nodes (3-5)

```
cxfs_admin:clusterOne > status
Event at [ Oct 22 13:08:07 ]
Cluster      : clusterOne
Tiebreaker   : clientA
Client Licenses : enterprise  allocated 0 of 256
                  workstation allocated 3 of 50
-----
Node          Cell ID  Age   Status
-----
mds1 *        0        4     Stable
mds2 *        1        3     Stable
clientA       3        1     Stable
clientB       4        1     Stable
clientC       5        1     Stable
...
```

To add a new server-capable administration node to the `clusterOne` cluster, do the following:

1. Define the server-capable administration node (in this case, `mds3`), which automatically adds it to the cluster definition and assigns a cell ID number:

```
cxfs_admin:clusterOne> create node
Specify the attributes for create node:
name? mds3
type? server_admin
private_net? 192.168.0.178
Event at [ Oct 22 13:08:08 ]
Node "mds3" has been created, waiting for it to join the cluster...
Please restart all cxfs and cluster services on the server "mds3" to make it
join the cluster.
```

2. Use the `status` command to verify that the new server-capable administration node has a lower cell ID number than any client-only node. For example:

```
cxfs_admin:clusterOne > status
Event at [ Oct 22 13:08:09 ]
Cluster      : clusterOne
Tiebreaker   : clientA
Client Licenses : enterprise  allocated 0 of 256
                  workstation allocated 3 of 50
-----
```



Node	Cell ID	Age	Status
mds1 *	0	10	Stable
mds2 *	1	9	Stable
mds3 *	2	1	Stable
clientA	3	7	Stable
clientB	4	7	Stable
clientC	5	7	Stable
...			

#### Add Server: No Low Cell ID Number is Available

The following example shows the following:

- mds1 and mds2 are server-capable administration nodes (indicated by the a \* character)
- clientA has the lowest cell ID (2) of any client-only node
- There **is not** an available low cell ID number between the current set of server-capable administration nodes (0 and 1) and the client-only nodes (2-4)

```

cxfs_admin:clusterOne > status
Event at [ Oct 22 13:08:10 ]
Cluster      : clusterOne
Tiebreaker   : clientA
Client Licenses : enterprise  allocated 0 of 256
                  workstation allocated 3 of 50
-----
Node          Cell ID  Age    Status
-----
mds1 *       0        4     Stable
mds2 *       1        3     Stable
clientA      2        1     Stable
clientB      3        1     Stable
clientC      4        1     Stable
...

```

Because there is no available number, you must adjust the cell IDs. Do the following:

1. Free the lowest cell ID that applies to a client-only node (in this case, 2 for `clientA`) by using the following `cxfs_admin` commands to remove the associated client-only node from the cluster definition:

```
cxfs_admin:clusterOne > disable clientA
Event at [ Oct 22 13:08:11 ]
Node "clientA" has been disabled, waiting for it to leave the cluster...
Waiting for node clientA, current status: Disabled and unmounting
Operation completed successfully
cxfs_admin:clusterOne> detach clientA
```

2. Define the new server-capable administration node `mds3`, which automatically adds it to the cluster definition and assigns a cell ID number (the now-available 2):

```
cxfs_admin:clusterOne> create node
Specify the attributes for create node:
name? mds3
type? server_admin
private_net? 192.168.0.178
Event at [ Oct 22 13:08:12 ]
Node "mds3" has been created, waiting for it to join the cluster...
Please restart all cxfs and cluster services on the server "mds3" to make it
join the cluster.
```

3. Restore the client-only node `clientA` to the cluster definition by attaching it and enabling it:

```
cxfs_admin:clusterOne > attach clientA
Event at [ Jan 11 15:27:58 ]
Node "clientA" has been enabled, waiting for it to join the cluster...
Waiting for node clientA, current status: Establishing membership
Waiting for node clientA, current status: Probing XVM volumes
Operation completed successfully
cxfs_admin:clusterOne> enable clientA
```

This automatically assigns a new cell ID number to `clientA` (the next available number, which is 5).

4. Use the `status` command to verify that the new server-capable administration node `mds3` has a lower cell ID number than any client-only node:

```
cxfs_admin:clusterOne > status
Event at [ Oct 22 13:08:13 ]
Cluster          : clusterOne
```

```

Tiebreaker      : clientA
Client Licenses : enterprise  allocated 0 of 256
                  workstation allocated 3 of 50
-----
Node            Cell ID  Age   Status
-----
mds1 *         0       28   Stable
mds2 *         1       27   Stable
mds3 *         2       15   Stable
clientA        5       1    Stable
clientB        3       25   Stable
clientC        4       25   Stable
...

```

## Adjusting the Cell ID Numbers

To avoid problems, SGI recommends that the server-capable administration nodes all have lower cell ID numbers than any client-only nodes; see "Create an Initial Cluster of All Server-Capable Administration Nodes" on page 54. The cell ID number is established by CXFS when a node is added to the cluster definition, which happens automatically with `cxfs_admin` when you define a node. When you remove a node from the cluster definition, its cell ID number is released.

If your cluster is experiencing problems, you should examine the current cell IDs and readjust as necessary. Following is an overview of the steps required:

1. Use the `cxfs_admin status` command to determine the current cell IDs.

---

**Note:** The GUI does not display cell ID numbers.

---

2. If a low cell ID number is available, assign it to the server-capable administration node that has an inappropriate cell ID by doing the following:
  - a. Remove the inappropriate cell ID from the node by using the `cxfs_admin disable` and `detach` commands, which removes the node from the cluster definition (or use the corresponding GUI task to remove the node from the cluster definition).
  - b. Assign a new cell ID (which will be the free low cell ID number) to the node by using the `cxfs_admin attach` and `enable` commands, which add the node back in to the cluster definition (or use the corresponding GUI task to add the node from the cluster definition).

3. If a low cell ID number is not available, adjust the cell IDs by doing the following:
  - a. Remove the inappropriate cell ID from the node by using the `cxfs_admin disable` and `detach` commands, which remove the node from the cluster definition (or use the corresponding GUI task to remove the node from the cluster definition).
  - b. Free the lowest cell ID that applies to a client-only node by using the `cxfs_admin disable` and `detach` commands to remove the associated client-only node from the cluster definition (or use the corresponding GUI task to remove the node from the cluster definition).
  - c. Assign a new cell ID (which will be the now-free low cell ID number) to the server-capable administration node by using the `cxfs_admin attach` and `enable` commands, which add the node back in to the cluster definition (or use the corresponding GUI task to add the node from the cluster definition).
  - d. Restore the client-only node to the cluster definition by using the `cxfs_admin attach` and `enable` commands (or use the GUI task to add it to the cluster definition). It will automatically be assigned a new, higher, cell ID number.
4. Use the `cxfs_admin status` command again to verify that the server-capable administration node has a lower cell ID number than any client-only node.

The following sections provide detailed examples using `cxfs_admin`:

- "Adjust Cell ID: Low Number is Available" on page 324
- "Adjust Cell ID: No Low Number is Available" on page 326

---

**Note:** To use the GUI, see the following sections:

- "Add or Remove Nodes in the Cluster with the GUI" on page 188
  - "Define a Node with the GUI" on page 179
- 

### Adjust Cell ID: Low Number is Available

The following example (output truncated) shows the following:

- `mds1` and `mds2` are server-capable administration nodes (indicated by the `a *` character)
- `mds2` has a higher cell ID number (3) than a client-only node (`clientA` with number 2)

- clientA has the lowest cell ID (2) of any client-only node
- There is an available low number (1)

```

cxfs_admin:clusterOne > status
Event at [ Oct 22 13:08:14 ]
Cluster      : clusterOne
Tiebreaker   : clientA
Client Licenses : enterprise  allocated 0 of 256
                  workstation allocated 3 of 50
-----
Node          Cell ID  Age    Status
-----
mds1 *       0        4     Stable
mds2 *       3        1     Stable
clientA      2        2     Stable
clientB      4        1     Stable
clientC      5        1     Stable
...

```

To adjust the inappropriate cell ID for mds2, do the following:

1. Remove the inappropriate cell ID from the mds2 node by using the following commands to remove mds2 from the cluster definition:

```

cxfs_admin:clusterOne > disable mds2
Event at [ Jan 11 15:29:38 ]
Node "mds2" has been disabled, waiting for it to leave the cluster...
Waiting for node mds2, current status: Disabled and unmounting
Operation completed successfully
cxfs_admin:clusterOne> detach mds2

```

2. Assign a new cell ID (which will be the free number 1) to mds2 by using the following commands to add the node back into the cluster definition:

```

cxfs_admin:clusterOne > attach mds2
Event at [ Jan 11 15:27:58 ]
Node "mds2" has been enabled, waiting for it to join the cluster...
Waiting for node mds2, current status: Establishing membership
Waiting for node mds2, current status: Probing XVM volumes
Operation completed successfully
cxfs_admin:clusterOne> enable mds2

```

3. Use the `status` command to verify that `mds2` has a lower cell ID number than any client-only node:

```
cxfs_admin:clusterOne > status
Event at [ Oct 22 13:08:15 ]
Cluster      : clusterOne
Tiebreaker   : clientA
Client Licenses : enterprise  allocated 0 of 256
                  workstation allocated 3 of 50
-----
Node          Cell ID  Age    Status
-----
mds1 *        0        22    Stable
mds2 *        1         1    Stable
clientA       2        20    Stable
clientB       4        19    Stable
clientC       5        19    Stable
...
```

#### Adjust Cell ID: No Low Number is Available

The following example (output truncated) shows the following:

- `mds1` and `mds2` are server-capable administration nodes (indicated by the a \* character)
- `mds2` has a higher cell ID number (3) than a client-only node (`clientA` with number 1 and `clientB` with number 2)
- `clientA` has the lowest cell ID (1) of any client-only node
- There is no available lower number

```

cxfs_admin:clusterOne > status
Event at [ Oct 22 13:08:16 ]
Cluster      : clusterOne
Tiebreaker   : clientA
Client Licenses : enterprise  allocated 0 of 256
                  workstation allocated 3 of 50
-----
Node          Cell ID  Age    Status
-----
mds1 *        0        4      Stable
mds2 *        3        3      Stable
clientA       1        1      Stable
clientB       2        1      Stable
clientC       4        1      Stable
...

```

Because there is no available number, you must readjust the cell IDs. Do the following:

1. Remove the inappropriate cell ID from server-capable administration node `mds2` by removing it from the cluster definition:

```

cxfs_admin:clusterOne > disable mds2
Event at [ Oct 22 13:08:17 ]
Node "clientA" has been disabled, waiting for it to leave the cluster...
Waiting for node clientA, current status: Disabled and unmounting
Operation completed successfully
cxfs_admin:clusterOne> detach mds2

```

2. Free the lowest cell ID (1) by removing the associated client-only node (`clientA`) from the cluster definition:

```

cxfs_admin:clusterOne > disable clientA
Event at [ Oct 22 13:08:18 ]
Node "clientA" has been disabled, waiting for it to leave the cluster...
Waiting for node clientA, current status: Disabled and unmounting
Operation completed successfully
cxfs_admin:clusterOne> detach clientA

```

3. Restore `mds2` to the cluster definition (which automatically assigns it the now-free cell ID of 1):

```

cxfs_admin:clusterOne > attach mds2
Event at [ Oct 22 13:08:19 ]
Node "mds2" has been enabled, waiting for it to join the cluster...
Waiting for node mds2, current status: Establishing membership
Waiting for node mds2, current status: Probing XVM volumes
Operation completed successfully
cxfs_admin:clusterOne> enable mds2

```

4. Restore `clientA` to the cluster definition:

```

cxfs_admin:clusterOne > attach clientA
Event at [ Oct 22 13:08:20 ]
Node "clientA" has been enabled, waiting for it to join the cluster...
Waiting for node clientA, current status: Establishing membership
Waiting for node clientA, current status: Probing XVM volumes
Operation completed successfully
cxfs_admin:clusterOne> enable clientA

```

5. Use the `status` command to verify that the new server-capable administration node has a lower cell ID number than any client-only node. For example:

```

cxfs_admin:clusterOne > status
Event at [ Oct 22 13:08:21 ]
Cluster          : clusterOne
Tiebreaker       : clientA
Client Licenses  : enterprise  allocated 0 of 256
                  workstation  allocated 3 of 50
-----
Node             Cell ID  Age    Status
-----
mds1 *           0        37    Stable
mds2 *           1        11    Stable
clientA          3         1    Stable
clientB          2        34    Stable
clientC          4        34    Stable
...

```



## Removing a Single Client-Only Node from the Cluster

To remove a single client-only node from the cluster, do the following:

1. Verify that the configuration is consistent among active metadata servers in the cluster by running the following on each active metadata server and comparing the output:

```
MDS# /usr/cluster/bin/clconf_info
```

If the client is not consistent with the metadata servers, or if the metadata servers are not consistent, then you should abort this procedure and address the health of the cluster. If a client is removed while the cluster is unstable, attempts to get the client to rejoin the cluster are likely to fail. For this reason, you should make sure that the cluster is stable before removing a client.

2. Flush the system buffers on the client you want to remove in order to minimize the amount of buffered information that may be lost:

```
client# sync
```

3. Stop CXFS services on the client. For example:

```
client# service cxfs_client stop
client# chkconfig cxfs_client off
```

4. Verify that CXFS services have stopped:

- Verify that the CXFS client daemon is not running on the client (success means no output):

```
client# ps -ef | grep cxfs_client
client#
```

- Monitor the `cxfs_client` log on the client you wish to remove and look for filesystems that are unmounting successfully. For example:

```
Apr 18 13:00:06 cxfs_client: cis_setup_fses Unmounted green0: green0 from /cxfs/green0
```

- Monitor the `SYSLOG` on the active metadata server and look for membership delivery messages that do not contain the removed client. For example, the following message indicates that cell 2 (`client`), the node being shut down, is not included in the membership:

```
Apr 18 13:01:03 5A:o200a unix: NOTICE: Cell 2 (client) left the membership
```

```
Apr 18 13:01:03 5A:o200a unix: NOTICE: Membership delivered for cells 0x3
```

```
Apr 18 13:01:03 5A:o200a unix: Cell(age): 0(7) 1(5)
```

- Use the following command to show that filesystems are not mounted:

```
client# df -hl
```

5. Verify that the configuration is consistent and does not contain the removed client by running the following on each active metadata server and comparing the output:

```
mds# /usr/cluster/bin/clconf_info
```

## Restoring a Single Client-Only Node to the Cluster

To restore a single client-only node to the cluster, do the following:

1. Verify that the configuration is consistent among active metadata servers in the cluster by running the following on each active metadata server and comparing the output:

```
MDS# /usr/cluster/bin/clconf_info
```

If the client is not consistent with the metadata servers, or if the metadata servers are not consistent, then you should abort this procedure and address the health of the cluster. If a client is removed while the cluster is unstable, attempts to get the client to rejoin the cluster are likely to fail. For this reason, you should make sure that the cluster is stable before removing a client.

2. Start CXFS on the client-only node:

```
client# chkconfig cxfs_client on  
client# service cxfs_client start
```

---

**Note:** The path to `cxfs_client` varies across the operating systems supported by CXFS. For more information, see *CXFS 6 Client-Only Guide for SGI InfiniteStorage*.

---

3. Verify that CXFS has started:

- Verify that the CXFS client daemon is running on the client-only node:

```
client# ps -ef | grep cxfs_client  
root      716      1  0 12:59:14 ?        0:05 /usr/cluster/bin/cxfs_client
```

- Monitor the SYSLOG on the active metadata server and look for a cell discovery message for the client and a membership delivered message containing the client cell. For example (line breaks added for readability):

```
Apr 18 13:07:21 4A:o200a unix: WARNING: Discovered cell 2 (woody)
  [priority 1 at 128.162.240.41 via 128.162.240.34]
Apr 18 13:07:31 5A:o200a unix: NOTICE: Cell 2 (client) joined the membership
Apr 18 13:07:31 5A:o200a unix: NOTICE: Membership delivered for cells 0x7
Apr 18 13:07:31 5A:o200a unix: Cell(age): 0(9) 1(7) 2(1)
```

- Monitor the `cxfs_client` log on the client you restored and look for filesystem mounts that are processing successfully. For example:

```
Apr 18 13:06:56 cxfs_client: cis_setup_fses Mounted green0: green0 on /cxfs/green0
```

- Use the following command to show that filesystems are mounted:

```
client# df -hl
```

4. Verify that the configuration is consistent and contains the client by running the following on each active metadata server and comparing the output:

```
MDS# /usr/cluster/bin/clconf_info
```

## Stopping CXFS for the Entire Cluster

To stop CXFS for the entire cluster, do the following:

1. Stop CXFS services on a client-only node:

```
client# service cxfs_client stop
```

Repeat this step on each client-only node.

2. (If running GRIOv2) Stop GRIOv2 services on a server-capable administration node:

```
server-admin# service grio2 stop
```

Repeat this step on each server-capable administration node.

3. Stop CXFS services on a server-capable administration node:

```
server-admin# service cxfs stop
```

Repeat this step on each server-capable administration node.

4. Stop the cluster daemons on a server-capable administration node:

```
server-admin# service cxfs_cluster stop
```

Repeat this step on each server-capable administration node.

## Restarting the Entire Cluster

To restart the entire cluster, do the following:

1. Start the cluster daemons on a server-capable administration node:

```
server-admin# service cxfs_cluster start
```

Repeat this step on each server-capable administration node.

2. Start CXFS services on a server-capable administration node:

```
server-admin# service cxfs start
```

Repeat this step on each server-capable administration node.

3. (If running GRIOV2) Start GRIOV2 services on a each server-capable administration node:

```
server-admin# service grio2 start
```

Repeat this on each server-capable administration node.

4. Start CXFS services on a client-only node:

```
client# service cxfs_client start
```

Repeat this step on each client-only node.

## XVM Volume Mapping to Storage Targets

The `cxfs-enumerate-wwns` script enumerates the worldwide names (WWNs) on the host that are known to CXFS. You can use the `cxfs-enumerate-wwns` script on a server-capable administration node to map XVM volumes to storage targets:

```
server-admin# /var/cluster/clconfd-scripts/cxfs-enumerate-wwns | grep -v "#" | sort -u
```

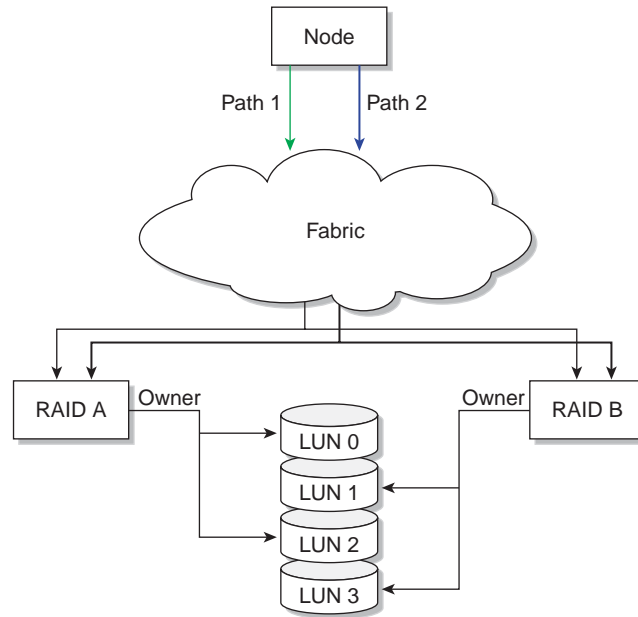
## XVM Failover V2

This section discusses the following:

- "XVM Failover Concepts" on page 333
- "failover2.conf File Concepts" on page 334
- "Generating a failover2.conf File" on page 336
- "Failover V2 Examples" on page 336
- "XVM Commands Related to Failover V2" on page 338
- "RAID Units and XVM Failover V2" on page 338

### XVM Failover Concepts

The example in Figure 12-6 shows two RAID controllers and the LUNs that they own. All LUNs are visible from each controller, therefore, each LUN can be accessed by each path. However, the controller for RAID A is preferred for LUN 0 and LUN 2, and the controller for RAID B is preferred for LUN 1 and LUN 3.



**Figure 12-6** Disk Paths

---

**Note:** The Mac OS X platform provides dynamic load balancing between all paths to the same RAID controller. In this case, the system will only show one path per controller to each LUN with local HBA ports or individual paths not visible.

---

### `failover2.conf` File Concepts

XVM failover V2 stores path information in the `failover2.conf` file. You must configure the `failover2.conf` file for each node. The entries in this file define failover attributes associated with a path to the storage. Entries can be in any order.

The `failover2.conf` file uses the following keywords:

- `preferred` indicates the best path for accessing each XVM physvol. This is the path that will be used at startup barring failure. There is no default preferred path.
- `affinity` groups all of the paths to a particular RAID controller that can be used in harmony without causing LUN ownership changes for a LUN between RAID

controllers, which would result in poor disk performance. An affinity group for a LUN should not contain paths that go to different RAID groups. The affinity value also determines the order in which these groups will be tried in the case of a failure, from lowest number to highest number. The valid range of affinity values is 0 (lowest) through 15 (highest). The path used starts with the affinity of the currently used path and increases from there. For example, if the currently used path is affinity=2, all affinity=2 paths are tried, then all affinity=3, then all affinity=4, and so on; after affinity=15, failover V2 wraps back to affinity=0 and starts over. Before you configure the failover2.conf file, the initial value for all paths defaults to affinity=0.

SGI recommends that the affinity values for a particular RAID controller be identical on every node in the CXFS cluster.

You may find it useful to specify affinities starting at 1. This makes it easy to spot paths that have not yet been configured because they are assigned a default of affinity=0. For example, if you added a new HBA but forgot to add its paths to the failover2.conf file, all of its paths would have an affinity=0, which could result in LUN ownership changes if some paths point to controller A and others point to controller B. Using this convention would not avoid this problem, but would make it easier to notice. If you use this convention, you must do so for the entire cluster.

---

**Note:** If you use the method where you do not use affinity=0 and you do not define all of the paths in the failover2.conf file, you will have a affinity group using an unknown controller. If in the example where you are using affinity=1 and affinity=2, if you are using affinity=2 as your current path and there is a failover, you will failover to affinity=0, which could use the same RAID controller and thus fail again or might use the other RAID controller. If there are multiple unspecified paths in the affinity=0 group, you might be mixing different RAID controllers in the same affinity group. This is only a performance issue, but you should fix any paths using the default affinity=0 value by adding them to the failover2.conf file and using an appropriate affinity value.

---

You can use the affinity value in association with the XVM foswitch command to switch an XVM physvol to a physical path of a defined affinity value.

For more information, see:

- The example file installed in /etc/failover2.conf.example

- The comments in the `failover2.conf` file
- "XVM Commands Related to Failover V2" on page 338
- Platform-specific examples of `failover2.conf` in the *CXFS 6 Client-Only Guide for SGI InfiniteStorage*
- *XVM Volume Manager Administrator's Guide*

### Generating a `failover2.conf` File

The easiest method to generate a `failover2.conf` file is to run the following command on platforms other than Windows:<sup>1</sup>

```
MDS# xvm show -v phys | grep affinity > templatefile
```

The entries in the output only apply to already-labeled devices. Values within `< >` angle brackets are comments; you can delete them or ignore them.

If all nodes have correctly configured `failover2.conf` files, an affinity change in one node will signal all other nodes in the cluster that the node has changed affinity for a LUN, allowing the other nodes to change to the same affinity (the same RAID controller). You can also use the `foswitch -cluster` command to cause all nodes in a cluster to either return to their preferred paths or move to a specific affinity. See "XVM Commands Related to Failover V2" on page 338.

### Failover V2 Examples

XVM failover V2 stores path information in the `failover2.conf` file. This section provides the following examples:

- "Example Using Two Affinities" on page 337
- "Example for Two RAID Controllers" on page 338

---

<sup>1</sup> For information about generating a `failover2.conf` file for Windows, see the *CXFS 6 Client-Only Guide for SGI InfiniteStorage*.



## Example Using Two Affinities

The following example uses two affinities:

```
/dev/disk/by-path/pci-0002:00:01.0-fc-0x202400a0b85a42c2:0x0000000000000000 affinity=1 preferred
/dev/disk/by-path/pci-0002:00:01.1-fc-0x202400a0b85a42c2:0x0000000000000000 affinity=1
/dev/disk/by-path/pci-0002:00:01.0-fc-0x202500a0b85a42c2:0x0000000000000000 affinity=2
/dev/disk/by-path/pci-0002:00:01.1-fc-0x202500a0b85a42c2:0x0000000000000000 affinity=2

/dev/disk/by-path/pci-0002:00:01.0-fc-0x202400a0b85a42c2:0x0001000000000000 affinity=1
/dev/disk/by-path/pci-0002:00:01.1-fc-0x202400a0b85a42c2:0x0001000000000000 affinity=1
/dev/disk/by-path/pci-0002:00:01.0-fc-0x202500a0b85a42c2:0x0001000000000000 affinity=2
/dev/disk/by-path/pci-0002:00:01.1-fc-0x202500a0b85a42c2:0x0001000000000000 affinity=2 preferred
```

The order of paths in the file is not significant. Paths to the same LUN are detected automatically. Without this file, all paths to each LUN would have `affinity=0` and there would be no preferred path. Setting a preferred path ensures that multiple paths will be used for performance. If no path is designated as preferred, the path used to the LUN is arbitrary based on the order of device discovery. There is no interaction between the preferred path and the affinity values.

This file uses affinity to group the RAID controllers for a particular path. Each controller has been assigned an affinity value. It shows the following:

- There is one PCI card with two ports off of the HBA (`pci-0002:00:01.1` and `pci-0002:00:01.0`)
- There are two RAID controllers, WWPN `202500a0b85a42c2` and WWPN `202400a0b85a42c2`
- There are two LUNs, `0001` and `0000`
- There are two affinity groups for each LUN, `affinity=1` and `affinity=2`
- There is a preferred path for each LUN

Failover will exhaust all paths to LUN `0001` from RAID controller `202400a0b85a42c2` (with `affinity=1` and the preferred path) before moving to RAID controller `202500a0b85a42c2` paths (with `affinity=2`)

### Example for Two RAID Controllers

The following example shows two RAID controllers, WWPN 200400a0b8184876 and WWPN 200500a0b8184876:

```
/dev/disk/by-path/pci-0002:00:01.0-fc-0x200400a0b8184876:0x0000000000000000 affinity=1 preferred
/dev/disk/by-path/pci-0002:00:01.1-fc-0x200400a0b8184876:0x0000000000000000 affinity=1
/dev/disk/by-path/pci-0002:00:01.0-fc-0x200500a0b8184876:0x0000000000000000 affinity=2
/dev/disk/by-path/pci-0002:00:01.1-fc-0x200500a0b8184876:0x0000000000000000 affinity=2
```

### XVM Commands Related to Failover V2

The following are useful XVM commands related to failover V2:

```
xvm help -verbose foconfig
xvm help -verbose foswitch
xvm help -verbose show
xvm foconfig -init
xvm foswitch -cluster -preferred physvol/name (switch phys/name in all nodes in cluster to preferred path)
xvm foswitch -preferred physvol
xvm foswitch -affinity 1 physvol
xvm foswitch -dev newdev
xvm foswitch -cluster -affinity 1 phys
xvm foswitch -cluster -setaffinity X phys/name (switch phys/name in cluster to affinity "X")
xvm show -verbose physvol
xvm show -verbose physvol | fgrep affinity > templatefile
```

For details, see the *XVM Volume Manager Administrator's Guide*.

---

**Note:** The `xvm` command is provided on all CXFS platforms. However, client-only nodes support only read-only commands.

---

### RAID Units and XVM Failover V2

This section discusses the following:

- "TP9100, RM610/660, and Failover V2" on page 339
- "TP9300, TP9500, TP9700, and S330 and Failover V2" on page 339

For more information about firmware levels, see "RAID Firmware" on page 90.

### **TP9100, RM610/660, and Failover V2**

The TP9100 and RM610/660 RAID units do not have any host type failover configuration. Each LUN should be accessed via the same RAID controller for each node in the cluster because of performance reasons. These RAID configurations behave and have the same characteristics as the SGIAVT mode discussed below.

TP9100 1 GB and 2 GB SGIAVT mode requires that the array is set to `multitid`.

### **TP9300, TP9500, TP9700, and S330 and Failover V2**

The TP9300, TP9500, and TP9700 RAID SGIAVT mode has the concept of LUN ownership by a single RAID controller. However, LUN ownership change will take place if any I/O for a given LUN is received by the RAID controller that is not the current owner. The change of ownership is automatic based on where I/O for a LUN is received and is not done by a specific request from a host failover driver. The concern with this mode of operation is that when a node in the cluster changes I/O to a different RAID controller than that used by the rest of the cluster, it can result in severe performance degradation for the LUN because of the overhead involved in constantly changing ownership of the LUN.

Failover V2 requires that you configure TP9300, TP9500, TP9700, and S330 RAID units with SGIAVT host type and the 06.12.18.xx code or later be installed.

TP9700 use of SGIAVT requires that 06.15.17xx. code or later be installed.

## **Generation of Streaming Workload for Video Streams**

To generate streaming workload for SD/HD/2K/4K formats of video streams, you can use the `frametest(1)` command. Each frame is stored in a separate file. You can also use this tool to simulate the reading and writing video streams by streaming applications. The tool also generates the performance statistics for the reading and writing operation, so it can be very useful for performance analysis for streaming applications.

For example, to do a multithreaded (4 threads) write test of 20,000 HD frames, as fast as possible (the `dir` directory should contain 20,000 HD frames created by a previous write test):

```
# frametest -t4 -w hd -n20000 -x frametest_w_t4_hd_20000_flatout.csv dir
```

To use 24 frames per second using a buffer of 24 frames:

```
# frametest -t4 -n20000 -f24 -q24 -g frametest_r_t4_hd_20000_24fps_24buf.csv dir
```

For details about `frametest` and its command-line options, see the `frametest(1)`

## Frame Files Defragmentation and Analysis

The `framesort` utility provides easy file-layout analysis and advanced file-sequence reorganization:

*File-layout analysis* shows the following:

- How well the specified files are allocated
- How many same-sized files are interleaved
- The number of runs where files are allocated in consecutive order or in reverse consecutive order

*File-sequence reorganization* makes files with consecutive filenames be placed consecutively in storage. It can also align files to their stripe-unit boundary. After rearrangement, files can gain higher retrieval bandwidth, which is essential for frame playback.

For example, the following command line will do analysis and rearrangement recursively starting from directory `movie1`. It also displays the progress status and verbose information. If the percentage of poorly organized files is equal to or greater than 15%, the rearrangement is triggered:

```
# framesort -rdgvva 15 movie1
```

For details about command-line arguments, see the `framesort(1)` man page.

## Disk Layout Optimization for Approved Media Customers

This section discusses the following:

- "Ideal Frame Layout" on page 341
- "Multiple Streams of Real-Time Applications" on page 342
- "The filestreams Mount Option" on page 344

### Ideal Frame Layout

An ideal frame layout is one in which frames for each stream are written sequentially on disk to maximize bandwidth and minimize latency:

- Minimize seek times while reading and writing
- Maximize RAID prefetch into cache for reads
- Maximize RAID coalescing writes into larger writes to each disk

Figure 12-7 shows an ideal frame layout.

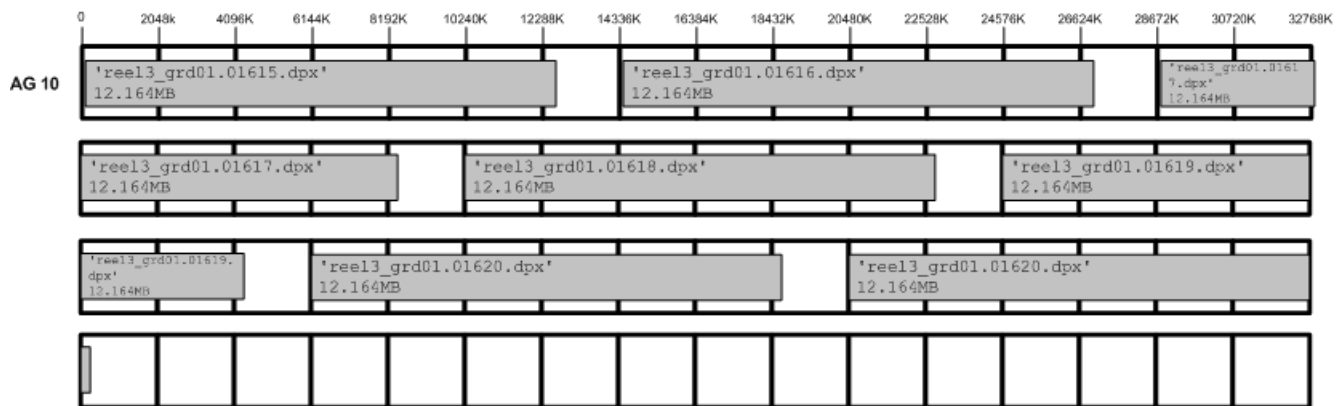


Figure 12-7 Ideal Frame Layout

With multithreaded applications (such as `frametest`), there will be multiple requests in flight simultaneously. As each frame is requested, data from upcoming frames will

be prefetched into cache. Figure 12-8 shows an example of a 4-thread frametest read (2-MB stripe unit / 1-GB cache size/ prefetch = x1 / 16 slices).

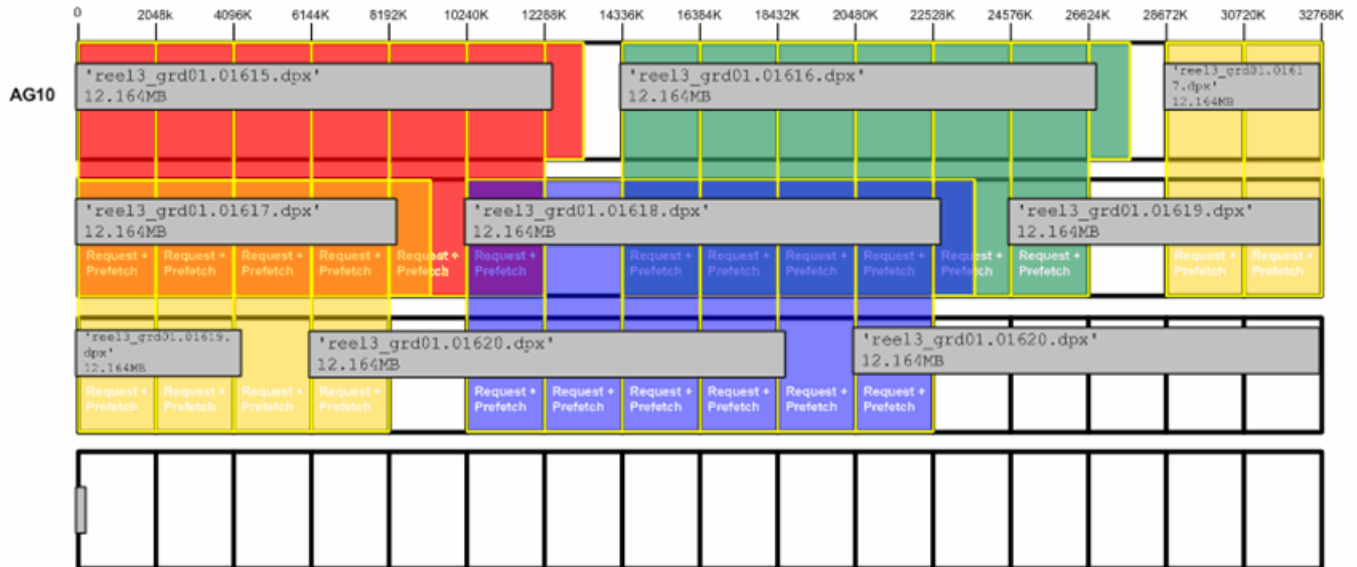


Figure 12-8 Ideal Frame Layout with RAID Prefetch

### Multiple Streams of Real-Time Applications

When there are multiple streams of real-time applications, frames from each stream are interleaved into the same region. Frames are not written sequentially but will jump forwards and backwards in the filesystem. The RAID is unable to support many real-time streams and is unable to maintain frame rates due to additional back-end I/O. Filesystems allocate files based on algorithms to utilize free space, not to maximize RAID performance when reading streams back.

Figure 12-9 shows an example of multiple streams. Figure 12-10 shows an example of poor cache utilization.

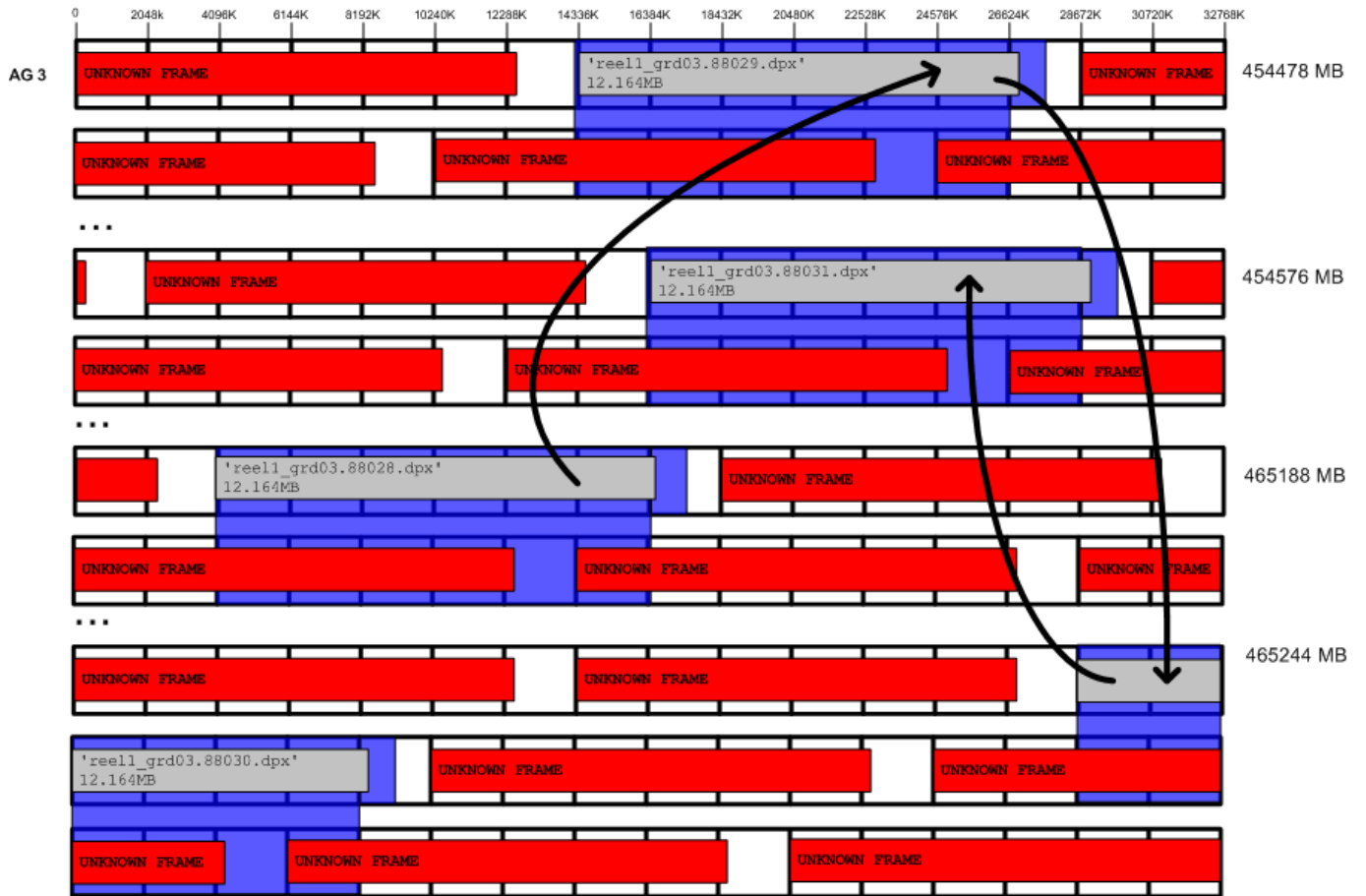


Figure 12-9 Multiple Streams of Real-Time Applications

System Performance Statistics

	All Ports	Port 1	Port 2	Port 3	Port 4	
Read MB/s:	183.9	45.8	46.8	46.3	45.0	
Write MB/s:	0.0	0.0	0.0	0.0	0.0	
Total MB/s:	183.9	45.8	46.8	46.3	45.0	
Read IO/s:	520	133	129	129	129	
Write IO/s:	0	0	0	0	0	
Total IO/s:	522	134	131	128	129	
Read Hits:	1.3%	1.6%	2.2%	0.6%	0.6%	
Prefetch Hits:	0.8%	1.1%	1.1%	0.6%	0.6%	
Prefetches:	46.3%	46.3%	46.0%	46.1%	46.8%	
Writebacks:	0.0%	0.0%	0.0%	0.0%	0.0%	
Rebuild MB/s:	0.0	0.0	0.0	0.0	0.0	
Verify MB/s:	0.0	0.0	0.0	0.0	0.0	
	Total	Reads	Writes	Pieces	Reads	Writes
Disk IO/s:	518	518	0	1:	4910	0
Disk MB/s:	544.6	544.6	0.0	2:	29890	0
Disk Pieces:	65710	65710	0	3:	340	0
BDB Pieces:		0		4:	0	0
				5:	0	0
Cache Writeback Data:	0.0%			6:	0	0
Rebuild/Verify Data:	0.0%	0.0%		7:	0	0
Cache Data Locked:	0.0%			8:	0	0

With only 1.3% read cache hits, RAID is reading **545MB/s** to return 184MB/s to the client (200% backend overhead)

Figure 12-10 Poor Cache Utilization

### The filestreams Mount Option

Approved media customers can use the XFS filestreams mount option with CXFS to maximize the ability of storage to support multiple real-time streams of video data. It is appropriate for workloads that generate many files that are created and accessed in a sequential order in one directory.



**Caution:** SGI must validate that your RAID model and RAID configuration can support the use of the filestreams mount option to achieve real-time data transfer and that your application is appropriate for its use. Use of this feature is complex and is reserved for designs that have been approved by SGI.



The `filestreams` mount option changes the behavior of the XFS allocator in order to optimize disk layout. It selects an XFS disk block allocation strategy that does the following:

- Identifies streams writing into the same directory and locks down a region of the filesystem for that stream, which prevents multiple streams from using the same allocation groups
- Allocates the file data sequentially on disk in the order that the files are created, space permitting
- Uses different regions of the filesystem for files in different directories

Using the `filestreams` mount option can improve both bandwidth and latency when accessing the files because the RAID will be able to access the data in each directory sequentially. Therefore, multiple writers may be able to write into the same filesystem without interleaving file data on disk. Filesystem can be filled up to approximately 94% before performance degrades. Deletion of projects does not fragment a filesystem, therefore there is no need to rebuild a filesystem after each project.

You can safely enable the `filestreams` mount option on an existing filesystem and later disable it without affecting compatibility. (The mount option affects where data is located in the filesystem; it does not change the format of the filesystem.) However, you may not get the full benefit of `filestreams` due to preexisting filesystem fragmentation.

Figure 12-11 shows an example of excellent cache utilization that allows for more streams.

```

System Performance Statistics
Read MB/s: 299.1 74.0 74.7 75.1 75.2
Write MB/s: 0.0 0.0 0.0 0.0 0.0
Total MB/s: 299.1 74.0 74.7 75.1 75.2

Read IO/s: 840 209 210 211 210
Write IO/s: 0 0 0 0 0
Total IO/s: 836 209 210 208 209

Read Hits: 99.5% 98.3% 99.6% 100.0% 100.0%
Prefetch Hits: 98.8% 97.6% 98.9% 99.6% 99.0%
Prefetches: 42.0% 41.5% 42.0% 42.9% 41.7%
Writebacks: 0.0% 0.0% 0.0% 0.0% 0.0%
Rebuild MB/s: 0.0 0.0 0.0 0.0 0.0
Verify MB/s: 0.0 0.0 0.0 0.0 0.0

Disk IO/s: 614 614 0 1: 39068 0
Disk MB/s: 345.5 345.5 0.0 2: 111 0
Disk Pieces: 39290 39290 0 3: 0 0
BDB Pieces: 0 0 0 4: 0 0
           5: 0 0
           6: 0 0
Cache Writeback Data: 0.0% 6: 0 0
Rebuild/Verify Data: 0.0% 0.0% 7: 0 0
Cache Data Locked: 0.0% 8: 0 0
    
```

Almost all data now found in RAID cache, only 15% backend disk I/O overhead

Figure 12-11 Excellent Cache Utilization

For more information, contact SGI Support.

## Creating a Case-Insensitive CXFS Filesystem

CXFS has limited support for case-insensitive filesystems:

- In ASCII filenames, lowercase and uppercase are treated as equal. This means the filesystem treats names that differ only in case as equivalent.

---

**Note:** It is not possible to rename a file to a name that only differs in case. For example, the following will not work:

```
# mv /cxfs/tp91/tmp/TST /cxfs/tp91/tmp/tst
mv: '/cxfs/tp91/tmp/TST' and '/cxfs/tp91/tmp/tst' are the same file
```

---

- The filesystem is case-preserving. This means the filesystem remembers the exact name that was used to create the file. This means that if a file was created with the name "File", it can be referenced using the name "FILE" or "file", but the reported name will always be "File".
- Case-insensitive CXFS filesystems are not supported on Linux clients. A Linux client will fail to mount the filesystem with messages such as the following:

```
Preparing to mount CXFS file system "/dev/cxvm/tp91"
XFS: bad version
XFS: SB validate failed
```

---

**Note:** Be aware that some applications rely on the case of filenames and will be confused when used with a case-insensitive filesystem.

---

Whether a CXFS filesystem is case-insensitive is determined when the filesystem is created. To create a case-insensitive filesystem, provide the following option to `mkfs.xfs`:

```
-n version=ci
```

For example:

```
# mkfs.xfs -n version=ci /dev/cxvm/tp91
meta-data=/dev/cxvm/tp91      isize=256    agcount=16, agsize=2746480 blks
      =                       sectsz=512   attr=2
data      =                       bsize=4096  blocks=43943680, imaxpct=25
      =                       sunit=16      swidth=32 blks
naming    =version 2           bsize=4096  ascii-ci=1
log       =internal log       bsize=4096  blocks=21472, version=2
      =                       sectsz=512   sunit=16 blks, lazy-count=0
realtime  =none               extsz=4096  blocks=0, rtextents=0
```



## Cluster Database Management

This chapter contains the following:

- "Performing Cluster Database Backup and Restoration" on page 349
- "Validating the Cluster Configuration with `cxfs-config`" on page 354

### Performing Cluster Database Backup and Restoration

You should perform a database backup whenever you want to save the database and be able to restore it to the current state at a later point.

You can use the following methods to restore the database:

- If the database is accidentally deleted from a server-capable administration node, use the `fs2d` daemon to replicate the database from another server-capable administration node. See "Restoring a Deleted Database from Another Node" on page 350.
- If you want to be able to recreate the current configuration, use the `config` command in `cxfs_admin`. You can then recreate this configuration by using the output file and the `cxfs_admin -f` option or running the script generated as described in "Saving and Recreating the Current Configuration with `cxfs_admin`" on page 279.
- If you want to retain a copy of the database and all node-specific information such as local logging, use the `cdbBackup` and `cdbRestore` commands. You should periodically backup the cluster database on all server-capable administration nodes using the `cdbBackup` command either manually or by adding an entry to the root `crontab` file. See "Using `cdbBackup` and `cdbRestore` for the Cluster Database and Logging Information" on page 351.

This section discusses the following:

- "Restoring a Deleted Database from Another Node" on page 350
- "Using `cdbBackup` and `cdbRestore` for the Cluster Database and Logging Information" on page 351

## Restoring a Deleted Database from Another Node

If the database has been accidentally deleted from an individual server-capable administration node, you can restore it by synchronizing with the database on another server-capable administration node.

---

**Note:** Do not use this method if the cluster database has been **corrupted**, because the database on another node will also be corrupted. In the case of corruption, you must reinstate a backup copy of the database. See "Saving and Recreating the Current Configuration with `cxfs_admin`" on page 279.

---

Do the following:

1. Stop the CXFS service on the server-capable administration node with the deleted database by running the following command in `cxfs_admin`:



---

**Caution:** If you omit this step, the target node might be reset by another server-capable administration node.

---

```
cxfs_admin:cluster> disable nodename
```

2. (If running *GRIOV2*) Stop the *GRIOV2* daemon (`ggd2`) by running the following command on the node with the deleted database:

```
server-admin# service grio2 stop
```

3. Stop the CXFS control daemon (`clconfd`) by running the following command on the node where step 1 was executed:



---

**Caution:** Running this command will completely shut down all CXFS filesystem access on the local node.

---

```
server-admin# service cxfs stop
```

4. Stop the CXFS cluster administration daemons (`cad`, `cmond`, `crsd`, and `fs2d`) by running the following command on the node where step 1 was executed:

```
server-admin# service cxfs_cluster stop
```

5. Verify that all of the filesystems have been unmounted and the cluster membership has been terminated. To do this, run `clconf_info` on the active metadata server.

6. Run `cdbreinit` on the node where step 1 was executed:

```
server-admin# /usr/cluster/bin/cdbreinit
```

7. Wait for the following message to be logged to the `syslog`:

```
fs2d[PID]: Finished receiving CDB sync series from machine nodename
```

8. Start the CXFS control daemon by running the following command on the node where step 1 was executed:

```
server-admin# service cxfs start
```

9. (If running *GRIOv2*) Start the *GRIOv2* daemon (`ggd2`) by running the following command on the node where step 1 was executed:

```
server-admin# service grio2 start
```

You can choose to have the `cdbreinit` command restart cluster daemons. The `fs2d` daemon will then replicate the cluster database to the node from which it is missing.

## Using `cdbBackup` and `cdbRestore` for the Cluster Database and Logging Information

The `cdbBackup` and `cdbRestore` commands backup and restore the cluster database and node-specific information, such as local logging information. You must run these commands individually for each server-capable administration node. This section discusses the following:

- "Backing Up the Cluster Database with `cdbBackup`" on page 351
- "Restoring the Cluster Database with `cdbRestore`" on page 352

### Backing Up the Cluster Database with `cdbBackup`

To perform a backup of the cluster, use the `cdbBackup` command on each server-capable administration node:

```
server-admin# /usr/cluster/bin/cdbBackup
```



---

**Caution:** Do not make configuration changes while you are using the `cdbBackup` command.

---

For more information, see the `cdbBackup(8)` man page.

### Restoring the Cluster Database with `cdbRestore`

To perform a restore, run the `cdbRestore` command on each server-capable administration node. You can use this method for either a missing or a corrupted cluster database. Do the following:

1. Disable all nodes in the cluster:

```
server-admin# /usr/cluster/bin/cxfs_admin -A -c "disable node:*
```

2. Stop CXFS services on all nodes in the cluster.
3. Stop the cluster administration daemons on each server-capable administration node.
4. Back up the cluster database as described in "Backing Up the Cluster Database with `cdbBackup`" on page 351.
5. Delete the existing database files by running the `cdbdelete` command on each server-capable administration command:

```
server-admin# /usr/cluster/bin/cdbdelete /var/cluster/cdb/cdb.db
```

6. Use the `cdbRestore` command on each server-capable administration node:

```
server-admin# /usr/cluster/bin/cdbRestore -f backup_filename
```



---

**Note:** The name of the backup file (*backup\_filename*) created by `cdbBackup` is displayed in the `cdbBackup` output.

For example, the following shows that `cdb_cc-xe.Oct.27.2008.08:58:17.tar.Z` is the value for *backup\_filename* (line breaks shown here for readability):

```
server-admin# /usr/cluster/bin/cdbBackup
Saving cdb header file /var/cluster/cdb/cdb.db and
  cdb data directory /var/cluster/cdb/cdb.db# as cdb
  backup file cdb_cc-xe.Oct.27.2008.08:58:17.tar.Z
  under directory /var/cluster/cdb-backup
...done.
```

---

7. Start the cluster administration daemons on each server-capable administration node.

For example, to clear the database and then restore the database to all server-capable administration nodes, do the following (command output not shown):

*Disable all nodes in the cluster:*

```
server-admin# /usr/cluster/bin/cxfs_admin -A -c "disable node:*"
```

*(If running GRIOV2) On each server-capable administration node:*

```
server-admin# service grio2 stop
```

*On each server-capable administration node:*

```
server-admin# service cxfs stop
```

*On each server-capable administration node:*

```
server-admin# service cxfs_cluster stop
```

*Back up the database on one server-capable administration node:*

```
server-admin# /usr/cluster/bin/cdbBackup
```

*On each server-capable administration node:*

```
server-admin# /usr/cluster/bin/cdbdelete /var/cluster/cdb/cdb.db
```

*On each server-capable administration node:*

```
server-admin# /usr/cluster/bin/cdbRestore -f backup_filename
```

*On each server-capable administration node:*

```
server-admin# service cxfs_cluster start
```

*On each server-capable administration node:*

```
server-admin# service cxfs start
```

*(If running GRIOv2) On each server-capable administration node :*

```
server-admin# service grio2 start
```

For more information, see the `cdbdelete(8)` and `cdbRestore(8)` man pages.

## Validating the Cluster Configuration with `cxfs-config`

The `cxfs-config` command validates configuration information in the cluster database:

```
server-admin# /usr/cluster/bin/cxfs-config
```

You can run it on any server-capable administration node in the cluster.

By default, `cxfs-config` displays the following:

- Cluster name and cluster ID
- Tiebreaker node
- Networks for CXFS failover networks
- Nodes in the pool:
  - Node ID
  - Cell ID (as assigned by the kernel when added to the cluster and stored in the cluster database)
  - Status of CXFS services (configured to be enabled or disabled)
  - Operating system
  - Node function

- CXFS filesystems:
  - Name, mount point (enabled means that the filesystem is configured to be mounted; if it is not mounted, there is an error)
  - Device name
  - Mount options
  - Potential metadata servers
  - Nodes that should have the filesystem mounted (if there are no errors)
  - Switches:
    - Switch name, user name to use when sending a telnet message, mask (a hexadecimal string representing a 64-bit port bitmap that indicates the list of ports in the switch that will not be fenced)
    - Ports on the switch that have a client configured for fencing at the other end
- Warnings or errors

For example, the following output shows that there are some issues with the way that server-capable administration node bert is configured:

```

cxfse5:~ # /usr/cluster/bin/cxfs-config
Global:
  cluster: clusterOne (id 9)
  cluster state: enabled
  tiebreaker:      dynamic heartbeat: disabled

Networks:
  net 0: type tcpip 10.0.0.0          255.255.255.0

Machines:
  node bert: node 3      cell 0  enabled Linux64 server_admin
    hostname: bert.americas.sgi.com
    autoconf: false
    fail policy: Fence, Shutdown
    nic 0: address: 10.0.199.3 priority: 1 network: none

  node cxfse10: node 6      cell 3  disabled Linux64 client_only
    hostname: cxfse10.americas.sgi.com
    autoconf: false

```

## 13: Cluster Database Management

---

```
fail policy: Fence, Shutdown
nic 0: address: 10.0.199.4 priority: 1 network: none
```

```
node cxfsxe5: node 1    cell 1  enabled Linux64 server_admin
hostname: cxfsxe5.americas.sgi.com
autoconf: false
fail policy: Fence, Shutdown
nic 0: address: 10.0.199.1 priority: 1 network: none
```

```
node penguin17: node 5    cell 4  enabled Linux32 client_only
hostname: penguin17.americas.sgi.com
autoconf: false
fail policy: Fence, Shutdown
nic 0: address: 10.0.199.17 priority: 1 network: none
```

```
node pg-27: node 4    cell 5  enabled Linux32 client_only
hostname: pg-27.americas.sgi.com
autoconf: false
fail policy: Fence, Shutdown
nic 0: address: 10.0.199.2 priority: 1 network: none
```

### Autoconf:

```
autoconf rule: pg-27
policy: allowed
hostname: pg-27
enable_node: true
```

### Filesystems:

```
fs zj01s0: /mnt/zj01s0      enabled
device = /dev/cxvm/zj01s0
force = false
options = []
servers = bert (0), cxfsxe5 (1)
clients = bert, cxfsxe10, cxfsxe5, penguin17, pg-27
```

```
fs zj01s1: /mnt/zj01s1      enabled
device = /dev/cxvm/zj01s1
force = false
options = []
servers = bert (0), cxfsxe5 (1)
clients = bert, cxfsxe10, cxfsxe5, penguin17, pg-27
```

## Switches:

```

switch 0: 192 port brocade admin@brocade26cp1      port 41: 210000e08b1a07d8 penguin17
      port 62: 100000062b126ff9 bert
      port 167: 210000e08b123d95 cxfsxe5
      port 170: 210000e08b1284c6 pg-27

```

## cxfs-config warnings/errors:

```

enabled machine bert has no NICs matching any net
enabled machine cxfsxe5 has no NICs matching any net
enabled machine penguin17 has no NICs matching any net
enabled machine pg-27 has no NICs matching any net
no NICs found on net 0
server bert fail policy must not contain "Shutdown" for cluster
  with even number of enabled servers and no tiebreaker
server cxfsxe5 fail policy must not contain "Shutdown" for cluster
  with even number of enabled servers and no tiebreaker

```

The following options are of particular interest:

- `-all` lists all available information
- `-ping` contacts each NIC in the machine list and displays if the packets is transmitted and received. For example (output truncated):

```

cxfsxe5:~ # /usr/cluster/bin/cxfs-config -ping
Global:
...
Machines:
  node bert: node 3      cell 0  enabled  Linux64  server_admin
    hostname: bert.americas.sgi.com
    autoconf: false
    fail policy: Fence, Shutdown
    nic 0: address: 10.0.199.3 priority: 1 network: none
      ping: --- 10.0.199.3 ping statistics ---
      ping: 5 packets transmitted, 5 received, 0% packet loss, time 4004ms
      ping: rtt min/avg/max/mdev = 0.070/0.103/0.145/0.030 ms
...

```

- `-xfs` lists XFS information for each CXFS filesystem, such as size. For example (output truncated):

```
cxfsxe5:~ # /usr/cluster/bin/cxfs-config -xfs
Global:
...
Filesystems:
  fs zj01s0: /mnt/zj01s0          enabled
    device = /dev/cxvm/zj01s0
    force = false
    options = []
    servers = bert (0), cxfsxe5 (1)
    clients = bert, cxfsxe10, cxfsxe5, penguin17, pg-27
    xfs:
      magic: 0x58465342
      blocksize: 4096
      uuid: a53cf4d1-b89f-4c75-9b36-dcbdbaf80139
      data size 8.38 GB
...

```

- `-xvm` lists XVM information for each CXFS filesystem, such as volume size and topology. For example:

```
cxfsxe5:~ # /usr/cluster/bin/cxfs-config -xvm
Global:
...
Filesystems:
  fs zj01s0: /mnt/zj01s0          enabled
      device = /dev/cxvm/zj01s0
      force = false
      options = []
      servers = bert (0), cxfsxe5 (1)
      clients = bert, cxfsxe10, cxfsxe5, penguin17, pg-27
  xvm:
      vol/zj01s0                0 online,open,accessible
      subvol/zj01s0/data        17576704 online,open,accessible
      slice/zj01s0              17576704 online,open,accessible

      data size: 8.38 GB
...

```

- `-check` performs extra verification, such as XFS filesystem size with XVM volume size for each CXFS filesystem. This option may take a few moments to execute.

For a complete list of options, see the `cxfs-config(8)` man page.

The following example shows errors reported by `cxfs-config` (line breaks shown for readability):

```
cxfsxe5:~ # /usr/cluster/bin/cxfs-config -check -all
Global:
  cluster: clusterOne (id 9)
  cluster state: enabled
  tiebreaker:      dynamic heartbeat: disabled

Networks:
  net 0: type tcpip 10.0.0.0          255.255.255.0

Machines:
  node bert: node 3      cell 0  enabled  Linux64  server_admin
      hostname: bert.americas.sgi.com
      autoconf: false

```

## 13: Cluster Database Management

---

```
fail policy: Fence, Shutdown
nic 0: address: 10.0.199.3 priority: 1 network: none
ping: --- 10.0.199.3 ping statistics ---
ping: 5 packets transmitted, 5 received, 0% packet loss, time 4002ms
ping: rtt min/avg/max/mdev = 0.048/0.099/0.134/0.033 ms
```

```
node cxfsxe10: node 6      cell 3  disabled Linux64 client_only
hostname: cxfsxe10.americas.sgi.com
autoconf: false
fail policy: Fence, Shutdown
nic 0: address: 10.0.199.4 priority: 1 network: none
```

```
node cxfsxe5: node 1      cell 1  enabled  Linux64 server_admin
hostname: cxfsxe5.americas.sgi.com
autoconf: false
fail policy: Fence, Shutdown
nic 0: address: 10.0.199.1 priority: 1 network: none
ping: --- 10.0.199.1 ping statistics ---
ping: 5 packets transmitted, 5 received, 0% packet loss, time 4000ms
ping: rtt min/avg/max/mdev = 0.007/0.008/0.013/0.004 ms
```

```
node penguin17: node 5    cell 4  enabled  Linux32 client_only
hostname: penguin17.americas.sgi.com
autoconf: false
fail policy: Fence, Shutdown
nic 0: address: 10.0.199.17 priority: 1 network: none
ping: --- 10.0.199.17 ping statistics ---
ping: 5 packets transmitted, 5 received, 0% packet loss, time 4001ms
ping: rtt min/avg/max/mdev = 0.074/1.365/6.425/2.530 ms
```

```
node pg-27: node 4      cell 5  enabled  Linux32 client_only
hostname: pg-27.americas.sgi.com
autoconf: false
fail policy: Fence, Shutdown
nic 0: address: 10.0.199.2 priority: 1 network: none
ping: --- 10.0.199.2 ping statistics ---
ping: 5 packets transmitted, 5 received, 0% packet loss, time 4002ms
ping: rtt min/avg/max/mdev = 0.061/0.597/2.488/0.946 ms
```

```
Autoconf:
autoconf rule: pg-27
```



```
policy: allowed
hostname: pg-27
enable_node: true
```

## Filesystems:

```
fs zj01s0: /mnt/zj01s0          enabled
device = /dev/cxvm/zj01s0
force = false
options = []
servers = bert (0), cxfsxe5 (1)
clients = bert, cxfsxe10, cxfsxe5, penguin17, pg-27
xvm:
  vol/zj01s0                    0 online,open,accessible
  subvol/zj01s0/data            17576704 online,open,accessible
  slice/zj01s0                  17576704 online,open,accessible

  data size: 8.38 GB
xfs:
  magic: 0x58465342
  blocksize: 4096
  uuid: a53cf4d1-b89f-4c75-9b36-dcbdbaf80139
  data size 8.38 GB
```

```
fs zj01s1: /mnt/zj01s1          enabled
device = /dev/cxvm/zj01s1
force = false
options = []
servers = bert (0), cxfsxe5 (1)
clients = bert, cxfsxe10, cxfsxe5, penguin17, pg-27
xvm:
  vol/zj01s1                    0 online,open,accessible
  subvol/zj01s1/data            17576704 online,open,accessible
  slice/zj01s1                  17576704 online,open,accessible

  data size: 8.38 GB
xfs:
  magic: 0x58465342
  blocksize: 4096
  uuid: ff8ea02c-d27b-4810-85b7-0f7f73988e79
  data size 8.38 GB
```

## 13: Cluster Database Management

---

### Switches:

```
switch 0: 192 port brocade admin@brocade26cp1      port 41: 210000e08b1a07d8 penguin17
  port 62: 100000062b126ff9 bert
  port 167: 210000e08b123d95 cxfsxe5
  port 170: 210000e08b1284c6 pg-27
```

### cxfs-config warnings/errors:

```
enabled machine bert has no NICs matching any net
enabled machine cxfsxe5 has no NICs matching any net
enabled machine penguin17 has no NICs matching any net
enabled machine pg-27 has no NICs matching any net
no NICs found on net 0
server bert fail policy must not contain "Shutdown" for cluster with even number
  of enabled servers and no tiebreaker
server cxfsxe5 fail policy must not contain "Shutdown" for cluster with even number
  of enabled servers and no tiebreaker
```

## Monitoring Status

This chapter discusses the following::

- "Methods to View System Status" on page 363
- "Status in Log Files" on page 364
- "Cluster, Node, and CXFS Filesystem Status" on page 365
- "I/O Fencing Status" on page 371
- "XVM Statistics" on page 373

### Methods to View System Status

You can view the system status in the following ways:

- Query the status of an individual node or the cluster by using the GUI or `cxfs_admin`.
- Keep continuous watch on the state of a cluster using the GUI view area or the following `cxfs_admin` command:

```
# /usr/cluster/bin/cxfs_admin -i clustername -r -c "status interval=seconds"
```

- Use the CXFS GUI or the `tail` command to view the end of the `/var/log/messages` system log file on a server-capable administration node.
- View the system log file on client-only nodes.
- Manually test the filesystems with the `ls` command.
- Use Performance Co-Pilot to monitor the read/write throughput and I/O load distribution across all disks and for all nodes in the cluster. The activity can be visualized, used to generate alarms, or archived for later analysis. You can also monitor XVM statistics.

See the following:

- *Performance Co-Pilot for Linux User's and Administrator's Guide*
- *Performance Co-Pilot for Linux Programmer's Guide*
- `dkvis(1)`, `pmie(1)`, `pmieconf(1)`, and `pmlogger(1)` man pages

---

**Note:** Administrative tasks must be performed using one of the following tools:

- The CXFS GUI when it is connected to a server-capable administration node (a node that has the `cluster_admin` software package installed)
  - `cxfs_admin` when you are logged in as `root` on a host that has permission to access the CXFS cluster database (some tasks require that `cxfs_admin` be running on a server-capable administration node)
- 

## Status in Log Files

You should monitor the following for problems:

- Server-capable administration node log: `/var/log/messages` (look for a `Membership delivered` message to indicate that a cluster was formed)
- Events from the GUI and `clconfd`: `/var/cluster/ha/log/cad_log`
- Kernel status: `/var/cluster/ha/log/clconfd_localhostname`
- Command line interface log: `/var/cluster/ha/log/cli_localhostname`
- Monitoring of other daemons: `/var/cluster/ha/log/cmond_log`
- Reset daemon log: `/var/cluster/ha/log/crsd_localhostname`
- Output of the diagnostic tools such as the network connectivity tests: `/var/cluster/ha/log/diags_localhostname`
- Cluster database membership status: `/var/cluster/ha/log/fs2d_log`
- System administration log: `/var/lib/sysadm/salog` (contains a list of the commands run by the GUI)

For information about client-only nodes, see *CXFS 6 Client-Only Guide for SGI InfiniteStorage*.

## Cluster, Node, and CXFS Filesystem Status

You can monitor system status with the following tools:

- "CXFS GUI and Status" on page 365
- "cxfs\_admin and Status" on page 366
- "cxfs\_info and Status" on page 368
- "clconf\_info and Status" on page 369

Also see "Key to Icons and States" on page 174.

### CXFS GUI and Status

You can monitor the status of the cluster, individual nodes, and CXFS filesystems by using the CXFS GUI connected to a server-capable administration node. For complete details about the GUI, see Chapter 10, "CXFS GUI" on page 157.

The easiest way to keep a continuous watch on the state of a cluster is to use the GUI view area and choose the following:

**Edit**  
> **Expand All**

The cluster status can be one of the following:

- **ACTIVE**, which means the cluster is up and running.
- **INACTIVE**, which means that CXFS services have not been started.
- **ERROR**, which means that some nodes are in a **DOWN** state; that is, the cluster **should** be running, but it is not.
- **UNKNOWN**, which means that the state cannot be determined because CXFS services are not running on the node performing the query.

To query the status of a node, you provide the logical name of the node. The node status can be one of the following:

- **UP**, which means that CXFS services are started and the node is part of the CXFS kernel membership.

- **DOWN**, which means that although CXFS services are started and the node is defined as part of the cluster, the node is not in the current CXFS kernel membership.
- **INACTIVE**, which means that CXFS services have not been started
- **UNKNOWN**, which means that the state cannot be determined because CXFS services are not running on the node performing the query.

State information is exchanged by daemons that run only when CXFS services are started. A given server-capable administration node must be running CXFS services in order to report status on other nodes.

For example, CXFS services must be started on `node1` in order for it to show the status of `node2`. If CXFS services are started on `node1`, then it will accurately report the state of all other nodes in the cluster. However, if `node1`'s CXFS services are not started, it will report the following states:

- **INACTIVE** for its own state, because it can determine that the start CXFS services task has not been run
- **UNKNOWN** as the state of all other nodes, because the daemons required to exchange information with other nodes are not running, and therefore state cannot be determined

You can use the view area to monitor the status of the nodes. Select **View: Nodes and Cluster**.

### **cxfs\_admin and Status**

You can monitor the status of the cluster, individual nodes, and CXFS filesystems by using the `cxfs_admin` command on any host that has `monitor` access permission for the CXFS cluster database. For complete details about `cxfs_admin`, see Chapter 11, "cxfs\_admin Command" on page 223.

For example:

- To query node and cluster status, use the following `cxfs_admin` command on any host that has `monitor` access to the CXFS cluster database:

```
status
```

For more information about `monitor` access, see "Setting `cxfs_admin` Access Permissions" on page 230.

- To continuously redisplay an updated status, enter an interval in seconds:

```
status interval=seconds
```

For example, to redisplay every 8 seconds:

```
cxfs_admin:mycluster> status interval=8
```

To stop the updates, send an interrupt signal (usually Ctrl+C).

- 

The most common states for nodes include:

Disabled: The node is not allowed to join the cluster

Inactive: The node is not in cluster membership

Stable: The node is in membership and has mounted all of its filesystems

A node can have other transient states, such as Establishing membership.

The most common states for filesystems include:

Mounted: All enabled nodes have mounted the filesystem

Unmounted: All nodes have unmounted the filesystem

The cluster can have one of the following states:

Stable

node(s) not stable

filesystem(s) not stable

node(s), filesystem(s) not stable

Any other state not mentioned above requires attention by the administrator.

For example (a \* character indicates a server-capable administration node):

```
cxfs_admin:clusterOne (read only) > status
Event at [ Oct 22 13:08:07 ]
Cluster      : clusterOne
Tiebreaker   :
Client Licenses : enterprise  allocated 0 of 256
                workstation  allocated 2 of 50
```

```
-----
Node          Cell ID  Age      Status
-----
bert *        0        4        Mounted 1 of 2 filesystems
cxfsxe5 *    1        3        Stable
cxfsxe10     3        -        Disabled
penguin17    4        0        Establishing membership
pg-27        5        0        Establishing membership
```

```
-----
Filesystem    Server      Status
-----
zj01s0        cxfsxe5    1 of 5 nodes mounted, bert trying to mount
zj01s1        bert       Mounted [2 of 5 nodes]
```

```
-----
Switch        Port Count  Known Fenced Ports
-----
brocade26cp1  192        4, 20, 21, 132, 223
```

### cxfs\_info and Status

You can monitor the status of the cluster, individual nodes, and CXFS filesystems by using the `cxfs_info` command on a stable client-only node. The path to `cxfs_info` varies by platform.

The `cxfs_info` command provides information about the cluster status, node status, and filesystem status. `cxfs_info` is run from a client-only node.

You can use the `-e` option to display information continuously, updating the screen when new information is available; use the `-c` option to clear the screen between updates. For less verbose output, use the `-q` (quiet) option.



For example, on a Linux client-only node named pg-27:

```
pg-27% /usr/cluster/bin/cxfs_info
cxfs_client status [timestamp Oct 22 12:45:55 / generation 5645836]

CXFS client:
    state: reconfigure (5), cms: quiesce, xvm: down, fs: down
Cluster:
    clusterOne (9) - enabled
Local:
    pg-27 (5) - enabled
Servers:
    bert          enabled  DOWN  0
    cxfsxe5       enabled  DOWN  1
Nodes:
    cxfsxe10     disabled DOWN  3
    penguin17    enabled  DOWN  4
    pg-27        enabled  DOWN  5
Filesystems:
    zj01s0
    zj01s1
```

## clconf\_info and Status

You can monitor the status of the cluster, individual nodes, and CXFS filesystems by using the `clconf_info` command on a server-capable administration node, assuming that the cluster is up.

The `clconf_info` command has the following options:

- e                      Waits for events from `clconfd` and displays the new information
- n *nodename*            Displays information for the specified logical node name
- p                      Persists until the membership is formed
- q                      (Quiet mode) Decreases verbosity of output. You can repeat this option to increase the level of quiet; that is, `-qq` specifies more quiet (less output) than `-q`.

- `-s` Sorts the output alphabetically by name for nodes and by device for filesystems. By default, the output is not sorted.
- `-v` (Verbose mode) Specifies the verbosity of output (`-vv` specifies more verbosity than `-v`). The default output for `clconf_info` is the maximum verbosity.

For example:

```

cxfse5:~ # /usr/cluster/bin/clconf_info

Event at [2009-10-22 13:12:41]

Membership since Thu Oct 22 13:12:41 2009

-----
Node           NodeID Status  Age    CellID
-----
cxfse5         1 up      3      1
bert           3 DOWN   -      0
pg-27         4 DOWN   -      5
penguin17     5 DOWN   -      4
cxfse10       6 inactive -      3
-----

2 CXFS FileSystems
/dev/cxvm/zj01s1 on /mnt/zj01s1 enabled server=(cxfse5) 0 client(s)=() status=UP
/dev/cxvm/zj01s0 on /mnt/zj01s0 enabled server=(cxfse5) 0 client(s)=() status=UP

```

This command displays the following fields:

- `Node` is the node name.
- `NodeID` is the node identification number.
- `Status` is the status of the node, which may be `up`, `DOWN`, or `inactive`.
- `Age` indicates how many membership transitions in which the node has participated. The age is 1 the first time a node joins the membership and will increment for each time the membership changes. This number is dynamically allocated by the CXFS software (the user does not define the age).
- `CellID` is the cell identification number, which is allocated when a node is added into the cluster definition with the GUI or `cxfse_admin`. It persists until the node

is removed from the cluster. The kernel also reports the cell ID in console messages.

You can also use the `clconf_info` command to monitor the status of the nodes in the cluster. It uses the same node states as the CXFS GUI. See "CXFS GUI and Status" on page 365.

## I/O Fencing Status

To check the current fencing status, do one of the following:

- Select **View: Switches** in the GUI view area
- Use the `show switch` command within `cxfs_admin`
- Use the `show fencing` command within `cxfs_admin` to show a summary of the fencing status per node
- Use the `query fence` command within `cxfs_admin` (when `cxfs_admin` is executed directly on a server-capable administration node) to show fencing details
- Use the `hafence` command as follows:

```
/usr/cluster/bin/hafence -q
```

For example, the following output shows that all nodes are enabled:

```
cxfs_admin:clusterOne > show fencing
Event at [ Jan 28 14:18:05 ]
node:bert:status:fencing=Stable
node:cxfsxe5:status:fencing=Stable
node:cxfsxe10:status:fencing=Stable
node:penguin17:status:fencing=Stable
node:pg-27:status:fencing=Stable
```

```
cxfs_admin:clusterOne > query fence
Event at [ Jan 28 14:18:22 ]
Waiting for shell command to end
Switch[0] "brocade26cp0" has 256 ports
  Port 41 type=FABRIC status=enabled hba=210000e08b1a07d8 on host penguin17
  Port 62 type=FABRIC status=enabled hba=100000062b126ff9 on host bert
  Port 167 type=FABRIC status=enabled hba=210000e08b123d95 on host cxfsxe5
```

```
Port 170 type=FABRIC status=enabled hba=210000e08b1284c6 on host pg-27
Port 201 type=FABRIC status=enabled hba=100000062b115f35 on host cxfsxe10
Operation completed successfully
```

A status of `enabled` for an `UNKNOWN` host indicates that the port is connected to a system that is not a node in the cluster. A status of `disabled` for an `UNKNOWN` host indicates that the node has been fenced (disabled), and the port may or may not be connected to a node in the cluster. A status of `enabled` with a specific name host indicates that the port is not fenced and is connected to the specified node in the cluster.

For example, the following `hafence verbose (-v)` output shows that port 4 is fenced (output truncated):

```
cxfsxe5:~ # /usr/cluster/bin/hafence -v
Switch[0] "brocade26cp1" has 192 ports
Port 0 type=FABRIC status=enabled hba=100000062b117c8c on host UNKNOWN
Port 1 type=FABRIC status=enabled hba=100000062b117954 on host UNKNOWN
Port 2 type=FABRIC status=enabled hba=100000062b117c7c on host UNKNOWN
Port 3 type=FABRIC status=enabled hba=100000062b11796c on host UNKNOWN
Port 4 type=FABRIC status=disabled hba=100000062b117ff0 on host UNKNOWN
Port 5 type=FABRIC status=enabled hba=100000062b117958 on host UNKNOWN
Port 6 type=FABRIC status=enabled hba=100000062b117f60 on host UNKNOWN...
```

To check current fail policy settings, use the `show failpolicy` command in `cxfs_admin`, the node information in the GUI, or the `cms_failconf` command as follows:

```
# /usr/cluster/bin/cms_failconf -q
```

For example:

```
cxfsxe5:~ # /usr/cluster/bin/cms_failconf -q
```

```
CMS failure configuration:
cell[0] bert      Reset
cell[1] cxfsxe5  Reset
cell[3] cxfsxe10      Fence Shutdown
cell[4] penguin17    Fence Shutdown
cell[5] pg-27      Fence Shutdown
```

## XVM Statistics

You can use Performance Co-Pilot to monitor XVM statistics. To do this, you must enable the collection of statistics by using the `pmstore` command:

- To enable the collection of statistics for the local host, enter the following:

```
# pmstore xvm.control.stats_on 1
```

- To disable the collection of statistics for the local host, enter the following:

```
# pmstore xvm.control.stats_on 0
```

You can gather XVM statistics in the following ways:

- By using the `pmdump` command from the SGI Foundation `pcp-gui` RPM. It can be used to produce an ASCII report of selected metrics from the `xvm` group in the Performance Co-Pilot namespace of available metrics.
- By using the `pmgxvm` command from the `pcp-sgi` package from the SGI ProPack release to monitor read and write activity at each XVM node.
- By using the `pmchart` command from the `pcp-gui` package to view time-series data in the form of a moving graph.

Figure 14-1 shows an example.

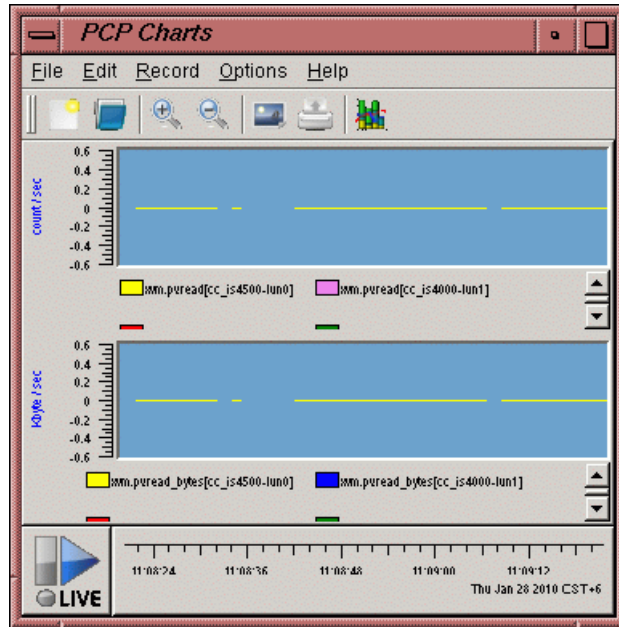


Figure 14-1 pmchart

## Troubleshooting

Configuring and administering a CXFS cluster can be a complex task. In general, most problems can be solved by rebooting a node. However, the topics in this chapter may help you avoid rebooting:

- "Troubleshooting Strategy" on page 375
- "Common Problems" on page 391
- "Understanding Error Messages" on page 412
- "Corrective Actions" on page 442
- "Using SGI Knowledgebase" on page 451
- "Reporting Problems to SGI" on page 451

See the *CXFS 6 Client-Only Guide for SGI InfiniteStorage* for additional troubleshooting information.

### Troubleshooting Strategy

To troubleshoot CXFS problems, do the following:

- "Know the Troubleshooting Tools" on page 376
- "Identify the Cluster Status" on page 388
- "Eliminate a Residual Cluster" on page 389
- "Determine If a Node Is Fenced" on page 389
- "Determine the Quorum Master" on page 390
- "Locate the Problem" on page 390
- "Redirect Switch Logs" on page 391

To avoid problems in the first place, follow the recommendations in Chapter 2, "Best Practices" on page 47.

## Know the Troubleshooting Tools

This section provides an **overview** of the tools required to troubleshoot CXFS:



---

**Caution:** Many of the commands listed are beyond the scope of this book and are provided here for quick reference only. See the other guides and man pages referenced for complete information before using these commands.

---

- "Physical Storage Tools" on page 376
- "Cluster Configuration Tools" on page 379
- "Cluster Control Tools" on page 380
- "Networking Tools" on page 381
- "Cluster/Node Status Tools" on page 381
- "Performance Monitoring Tools" on page 382
- "System Dump Analysis Tool (SLES 11 on x86-64)" on page 383
- "System Dump Analysis Tool (SLES 11 on ia64)" on page 385
- "Log Files" on page 387
- "Gather Cluster Configuration with `cxfsdump`" on page 387

### Physical Storage Tools

Understand the following physical storage tools:

- To display the hardware inventory:

```
# hwinfo --short
```

For more information, see the `hwinfo(8)` man page.

If the output is not what you expected, do a probe for devices and perform a SCSI bus reset, using the following commands:

- QLogic SCSI or Fibre Channel: use the following to probe the LUN on the specified *hostname*:

```
# echo "- - -" > /sys/class/scsi_host/hostname/scan
```



Each "-" character is a wildcard for bus, target, and LUN, respectively. Newer SCSI and all FC controllers have a single bus per function, but two functions in the dual-port controllers. For example, if you added a new LUN to a RAID (and the RAID is target 3) for a host named host3:

```
# echo "0 3 -" > /sys/class/scsi_host/host3/scan
```

QLogic Fibre Channel: use the following to discover and build a new table for the LUN, where 3 is the host number:

```
# echo "scsi-qlascan" >/proc/scsi/qla2xxx/3
```

- LSI: use the lsiutil tool to scan the HBA, selecting option 8 to scan for devices:

```
# lsiutil
```

```
LSI Logic MPT Configuration Utility, Version 1.41, November 23, 2005
```

```
4 MPT Ports found
```

	Port Name	Chip Vendor/Type/Rev	MPT Rev	Firmware Rev
1.	/proc/mpt/ioc0	LSI Logic 53C1030 B2	102	01032710
2.	/proc/mpt/ioc1	LSI Logic 53C1030 B2	102	01032710
3.	/proc/mpt/ioc2	LSI Logic FC949X A1	105	01030300
4.	/proc/mpt/ioc3	LSI Logic FC949X A1	105	01030300

```
Select a device: [1-4 or 0 to quit] 3
```

1. Identify firmware, BIOS, and/or FCode
2. Download firmware (update the FLASH)
4. Download/erase BIOS and/or FCode (update the FLASH)
8. Scan for devices
10. Change IOC settings (interrupt coalescing)
13. Change FC Port settings
16. Display logged-in devices
20. Diagnostics
21. RAID actions
22. Reset bus
23. Reset target
30. Beacon on
31. Beacon off
60. Show non-default settings

## 15: Troubleshooting

---

- 61. Restore default settings
- 98. Reset FC link
- 99. Reset port

Main menu, select an option: [1-99 or e for expert or 0 to quit] **8**

FC949X's link is online, type is fabric direct attach, speed is 2 Gbaud

B	T	L	Type	Vendor	Product	Rev	WWPN	PortId
0	127	0	Disk	SGI	TP9300	0612	200d00a0b8131841	021500
0	127	1	Disk	SGI	TP9300	0612		
0	127	2	Disk	SGI	TP9300	0612		
0	127	31	Disk	SGI	Universal Xport	0612		
0	128	0	Disk	SGI	TP9300	0612	200c00a0b8131841	021400
0	128	1	Disk	SGI	TP9300	0612		
0	128	2	Disk	SGI	TP9300	0612		
0	128	31	Disk	SGI	Universal Xport	0612		
0	129	0	Disk	SGI	TP9100 F PSEUDO	5903	23000050cc007d2c	021300
0	130	0	Disk	SGI	TP9100 F PSEUDO	5903	22000050cc007d2c	021200
			FC949X Port				100000062b0e4248	021700
			FCP Initiator				210000e08b1058d4	021000
			FCP Initiator				210100e08b3058d4	021100
			FCP Initiator				100000062b0e4249	021600
			Non-FCP				20fc006069c021b6	ffffffc
			Non-FCP				2007006069c021b6	fffffe

You can run the `cxfs-reprobe` script look for devices and perform a SCSI bus reset if necessary. `cxfs-reprobe` will also issue an XVM probe to tell XVM that there may be new devices available:

- On server-capable administration nodes:

```
server-admin# /var/cluster/clconfd-scripts/cxfs-reprobe
```

- On client-only nodes:

```
client# /var/cluster/cxfs_client-scripts/cxfs-reprobe
```

- To show the physical volumes, use the `xvm` command. For example, from a Linux node:

```
linux# /sbin/xvm show -v phys/
```

The path to the `xvm` command varies by platform. For more information, see the appendix in *CXFS 6 Client-Only Guide for SGI InfiniteStorage*. For details about XVM, see the *XVM Volume Manager Administrator's Guide*.

## Cluster Configuration Tools

Understand the following cluster configuration tools:

- To configure XVM volumes, use the `xvm` command. On a server-capable administration node:

```
# /sbin/xvm
```

The path to the `xvm` command varies by platform. For more information, see the appendix in *CXFS 6 Client-Only Guide for SGI InfiniteStorage*. For details about XVM, see the *XVM Volume Manager Administrator's Guide*.

- To configure CXFS, use the CXFS GUI or `cxfs_admin`:

– The GUI:

```
# /usr/sbin/cxfsmgr
```

See "GUI Features" on page 164 and Chapter 10, "CXFS GUI" on page 157.

– The `cxfs_admin` command:

```
# /usr/cluster/bin/cxfs_admin
```

See "Initial Setup with the `cxfs_admin` Command" on page 148 and Chapter 11, "`cxfs_admin` Command" on page 223.

- To reinitialize the database, use the `cdbreinit` command:

```
server-admin# /usr/cluster/bin/cdbreinit
```

See "Recreating the Cluster Database" on page 448.

- To check the cluster configuration, use the following command from a server-capable administration node in the cluster:

```
server-admin# /usr/cluster/bin/cxfs-config -all -check
```

SGI recommends that you run this command after any significant configuration change or whenever problems occur. For more information, see "Validating the Cluster Configuration with `cxfs-config`" on page 354.

## Cluster Control Tools

Understand the cluster control tools:

- "Cluster Administration Daemons" on page 43
- These commands are useful if you know that filesystems are available but are not indicated as such by the cluster status, or if cluster quorum is lost. However, note that `service cxfs stop` will cause CXFS to completely shut down on the local node.

See the following:

- "Ensure Cluster Database Membership Quorum Stability" on page 51
- "Restarting CXFS Services" on page 443
- "Clearing the Cluster Database" on page 444
- "Stopping and Restarting Cluster Administration Daemons" on page 447
- "CXFS Services" on page 29. Stopping CXFS services or shutting down CXFS services will cause its filesystems to be recovered by another potential metadata server.

---

**Note:** Relocation and recovery are supported only when using standby nodes. Relocation is disabled by default.

---

- To revoke and allow CXFS kernel membership on the local node, forcing recovery on the metadata server for the local node, use the GUI or the following `cxfs_admin` command:

```
cxfs_admin:clustername> disable node:nodename
```

Wait until recovery is complete before issuing a subsequent:

```
cxfs_admin:clustername> enable node:nodename
```

The local node cannot rejoin the CXFS kernel membership until recovery is complete.

Also see the following:

- "Revoke Membership of the Local Node with the GUI" on page 201
- "Allow Membership of the Local Node with the GUI" on page 201
- "Disable a Node with `cxfs_admin`" on page 251
- "Enable a Node with `cxfs_admin`" on page 251

## Networking Tools

Understand the following networking tools:

- Send packets to network hosts using the `ping(1)` command
- Show network status using the `netstat(1)` command

## Cluster/Node Status Tools

Understand the following cluster/node status tools:

- To show which cluster daemons are running:

```
# ps -ef | grep cluster
```

See "Verify that the Cluster Daemons are Running" on page 141.

- To see cluster and filesystem status, use one of the following:

- GUI:

```
# /usr/sbin/cxfsmgr
```

See "Display a Cluster with the GUI" on page 196.

- `cxfs_admin` command:

```
# /usr/cluster/bin/cxfs_admin -c status
```

See "Display a Cluster with `cxfs_admin`" on page 261.

- `cxfs_info` command on a client-only node (see *CXFS 6 Client-Only Guide for SGI InfiniteStorage*)

- To see the mounted filesystems:

```
# /bin/mount
# /bin/df
```

For more information, see the `mount(8)` and `df(1)` man pages.

You can also use the `df` command to report the number of free disk blocks

- To show volumes:

```
# /sbin/xvm show vol/
```

See the *XVM Volume Manager Administrator's Guide*.

## Performance Monitoring Tools

Understand the following performance monitoring tools:

- To monitor system activity, use the `sar(1)` command:

```
# /usr/bin/sar
```

- To monitor system input/output device loading on a Linux node, use the `iostat(1)` command. For example, to monitor at 2-second intervals for 1000000 times:

```
linux# iostat 2 1000000
```

- To monitor process status, memory consumption, paging activity, block I/O operations, interrupts, context switches, and processor usage on a Linux node, use the `vmstat(8)` command. For example, to monitor at 1-second intervals for 1000 times:

```
linux# vmstat -a -n 1 1000
```

- To monitor the statistics for an XVM volume, use the `xvm` command:

```
# /sbin/xvm change stat on {concatname|stripename|physname}
```

See the *XVM Volume Manager Administrator's Guide*.

- To monitor system performance, use Performance Co-Pilot (PCP). See the PCP documentation and the `pmie(1)` and `pmieconf (1)` man pages.

## System Dump Analysis Tool (SLES 11 on x86-64)

For system dump analysis on an Altix XE x86-64 system running SLES 11, use the SLES crash tool. This requires using the `kernel-default-debuginfo-kernelrevfile` kernel and debug symbols.

To enable the collection of crash dumps on a SLES 11 x86-64 system, do the following:

1. Install the following RPMs, where *kernelrev* matches your installed kernel

- `kernel-default-debuginfo-kernelrev`
- `kdump-version`
- `kexec-tools-version`

For example, for the `2.6.27.19-5-default` kernel, you would require `kernel-default-debuginfo-2.6.27.19-5.1` RPM, which would install the following file:

```
/usr/lib/debug/boot/vmlinux-2.6.27.19-5-default.debug
```

When you install the `kdump-version` RPM, it will automatically add the following information onto the kernel lines in the `/boot/grub/menu.lst` file :

```
crashkernel=256m-:128M@16M
```

---

**Note:** When you install the `kdump` RPM, `kdump` is automatically enabled. (Unlike previous SLES releases, when you had to manual do a `chkconfig kdump on`.)

---

2. When you install the `kdump-version` RPM, it will automatically add the following information onto the kernel lines in the `/boot/grub/menu.lst` file :

```
crashkernel=256m-:128M@16M
```

3. Reboot, which activates the kernel and reserves the required memory. You will see the following message on the console:

```
Loading kdump                                     done
```

4. Verify that the machine is set up correctly by requesting an NMI from the console:

```
x86-64_console# echo "c">/proc/sysrq-trigger
```

---

**Note:** If there are several old dump files, the oldest one might be deleted by this process.

---

For example:

```
x86-64_console# echo "c">/proc/sysrq-trigger
SysRq : Trigger a crashdump
Initializing cgroup subsys cpuset
Initializing cgroup subsys cpu
...
(pages of output)
```

The key piece of information to look for are lines such as the following at the end of the output:

```
Saving dump using makedumpfile
-----
Copying data                      : [ 100 %]

The dumpfile is saved to /root/var/crash/2009-10-28-13:05/vmcore.

makedumpfile Completed.
-----
Generating README                 Finished.
Copying System.map                Finished.
Copying kernel                    Finished.
Copying kernel.debug              Finished.
```

Then the machine will reboot normally.

5. Go to the `/var/log/dump` directory and look for the dump directories that named according to the date and time. Each date directory will contain the files required for analysis. For example:

```
x86-64# cd /var/log/dump
console# ls
2009-10-13-21:02/  2009-10-26-15:55/
x86-64# ls -l 2009-10-26-15:55
README.txt
System.map-2.6.27.19-5-default
```



```
vmlinux-2.6.27.19-5-default.debug  
vmlinux-2.6.27.19-5-default.gz  
vmcore
```

For more information, see the `crash(8)` man page.

### System Dump Analysis Tool (SLES 11 on ia64)

For system dump analysis on an Altix ia64 system running SLES 11, use the SLES `crash` tool.

To enable the collection of crash dumps on a SLES 11 ia64 system, do the following:

1. Install the following RPMs, where *kernelrev* matches your installed kernel

- `kernel-default-debuginfo-kernelrev`
- `kdump-version`
- `kexec-tools-version`

For example, for the `2.6.27.19-5-default` kernel, you would require `kernel-default-debuginfo-2.6.27.19-5.1` RPM, which would install the following file:

```
/usr/lib/debug/boot/vmlinux-2.6.27.19-5-default.debug
```

When you install the `kdump-version` RPM, it will automatically add the following information onto the kernel lines in the `/etc/elilo.conf` file :

```
crashkernel=512M-:256M
```

---

**Note:** When you install the `kdump` RPM, `kdump` is automatically enabled. (Unlike previous SLES releases, when you had to manual do a `chkconfig kdump on`.)

---

2. Run the following command to make the changes to `/etc/elilo.conf` take effect:

```
ia64# elilo
```

3. Reboot, which activates the kernel and reserves the required memory. You will see the following message on the console:

```
Loading kdump  
Regenerating kdump initrd ... done
```

System Boot Control: The system has been set up

4. Verify that the machine is set up correctly by requesting an NMI from the console:

```
ia64_console# echo "c">/proc/sysrq-trigger
```

---

**Note:** If there are several old dump files, the oldest one might be deleted by this process.

---

For example:

```
ia64_console# echo "c">/proc/sysrq-trigger
SysRq : Trigger a crashdump
Initializing cgroup subsys cpuset
Initializing cgroup subsys cpu
...
(pages of output)
```

The key piece of information to look for are lines such as the following at the end of the output:

```
Saving dump using makedumpfile
-----
Copying data                : [100 %]

The dumpfile is saved to /root/var/crash/2009-10-29-21:03/vmcore.

makedumpfile Completed.
-----
Generating README          Finished.
Copying System.map         Finished.
Copying kernel             Finished.
```

Then the machine will reboot normally.

5. Go to the `/var/log/dump` directory and look for the dump directories that named according to the date and time. Each date directory will contain the files required for analysis. For example:

```
ia64# cd /var/log/dump
ia64# ls
2009-10-13-21:02/  2009-10-26-15:55/
```

```
ia64# ls -l 2009-10-26-15:55
README.txt
System.map-2.6.27.19-5-default
vmlinuz-2.6.27.19-5-default.gz
vmcore
```

For more information, see the `crash(8)` man page.

## Log Files

Understand the log files discussed in "Status in Log Files" on page 364.

## Gather Cluster Configuration with `cxfsdump`

Before reporting a problem to SGI, you should use the `cxfsdump` command to gather configuration information about the CXFS cluster, such as network interfaces, CXFS registry information, I/O, and cluster database contents. This will allow SGI support to solve the problem more quickly.

---

**Note:** In cluster mode (the default when run on a server-capable administration node), the `cxfsdump` command requires `rsh/ssh` and `rcp/scp` access across all nodes in the cluster. You can use the `-secure` option to use secure remote connections.

---

You should run `cxfsdump` from a server-capable administration node in the cluster:

```
server-admin# /usr/cluster/bin/cxfsdump
```

The output will be placed in a file in the directory `/var/cluster/cxfsdump-data` directory on the server-capable administration node on which the `cxfsdump` command was run. The `cxfsdump` command will report the name and location of the file when it is finished.

To gather information about just the local node, use the `cxfsdump -local` option.

You can configure the location of the dump by selecting the directory from a **browse for folder** dialog or type in the path in the edit field.

For more information about client-only nodes, see *CXFS 6 Client-Only Guide for SGI InfiniteStorage*.

## Identify the Cluster Status

When you encounter a problem, identify the cluster status by answering the following questions:

- Are the cluster daemons running? See "Verify that the Cluster Daemons are Running" on page 141.
- Is the cluster state consistent on each node? Run the GUI or `cxfs_admin` command on each server-capable administration node and compare.
- Which nodes are in the CXFS kernel membership? Check the cluster status and the `/var/log/messages` file on server-capable administration nodes.
- Which nodes are in the cluster database (`fs2d`) membership? See the `/var/cluster/ha/log/fs2d_log` files on each server-capable administration node.
- Is the database consistent on all server-capable administration nodes? Determine this logging in to each server-capable administration node and examining the `/var/cluster/ha/log/fs2d_log` file and database checksum.
- Log onto the various CXFS client nodes or use the GUI view area display with details showing to answer the following:
  - Are the devices available on all nodes? Use the following:
    - The `xvm` command to show the physical volumes:

```
xvm:cluster> show -v phys/
```
    - Is the client-only node in the cluster? Use the `cxfs_info` command.
    - List the contents of the `/dev/cxvm` directory with the `ls` command:

```
# ls /dev/cxvm
```
    - Use the `hwinfo(8)` command to display the hardware inventory. See "Physical Storage Tools" on page 376.
  - Are the filesystems mounted on all nodes? Use `mount`, the GUI, and the `cxfs_admin` and `clconf_info` commands.
  - Which node is the metadata server for each filesystem? Use the GUI or the `cxfs_admin` command to determine. See "Discovering the Active Metadata Server" on page 301.

- Is the metadata server in the process of recovery? Look at the following file:

```
/var/log/messages
```

Messages indicate the recovery status. For example:

- Recovery is in process:

```
Mar 13 11:31:02 1A:p2 unix: ALERT: CXFS Recovery: Cell 1: Client Cell 0 Died, Recovering </scratch/p9/local>
```

- Recovery is complete:

```
Mar 13 11:31:04 5A:p2 unix: NOTICE: Signaling end of recovery cell 1
```

- If filesystems are not mounting, do they appear online in XVM? You can use the following `xvm` command:

```
xvm:cluster> show vol/*
```

## Eliminate a Residual Cluster

Before you start configuring another new cluster, make sure no nodes are still in a CXFS kernel membership from a previous cluster. Enter the following to check for a `cmsd` kernel thread:

```
server-admin# ps -ef | grep cmsd
```

If the output shows a `cmsd` kernel thread, perform a forced CXFS shutdown by entering the following:

```
server-admin# service cxfs stop
```

Then check for a `cmsd` kernel thread again.

After waiting a few moments, if the `cmsd` kernel thread still exists, you must reboot the machine or leave it out of the new cluster definition. It will not be able to join a new cluster in this state and it may prevent the rest of the cluster from forming a new CXFS kernel membership.

## Determine If a Node Is Fenced

To determine if a node is fenced, log in to a server-capable administration node and use the `cxfs_admin status` command or the `hafence(1M)` command.

The following messages are logged when fencing changes:

```
Raising fence on cell cellID (nodename)
Lowering fence on cell cellID (nodename)
```

## Determine the Quorum Master

The quorum master is the server-capable administration node with the lowest node ID number (not cell ID). To confirm which node is the quorum master, look in the `var/cluster/ha/log/fs2d_log` file for the most recent quorum message, such as the following example, which shows that `node3` is the quorum master:

```
Tue Jul 7 12:52:41.490 cxfsofus4 fs2d - Checking quorum with 4 members for any unknown members.
Tue Jul 7 12:52:41.490 cxfsofus4 fs2d - All quorum member machines known, master is node3
```

## Locate the Problem

To locate the problem, do the following:

- Examine the log files (see "Log Files" on page 387):
  - Search for errors in all log files. See "Status in Log Files" on page 364. Examine all messages within the timeframe in question.
  - Trace errors to the source. Try to find an event that triggered the error.
- Use detailed information from the view area in the GUI to drill down to specific configuration information.
- Run the **Test Connectivity** task in the GUI. See "Test Node Connectivity with the GUI" on page 193.
- Determine how the nodes of the cluster see the current CXFS kernel membership by entering the following command on each server-capable administration node:

```
server-admin# /usr/cluster/bin/clconf_info
```
- Check the `/var/log/messages` file on each server-capable administration node to make sure the CXFS filesystems have been successfully mounted or unmounted.

If a mount/unmount fails, the error will be logged and the operation will be retried after a short delay.

- Get a dump of the cluster database. You can extract such a dump with the following command:

```
server-admin # /usr/cluster/bin/cdbutil -c 'gettree #' > dumpfile
```

## Redirect Switch Logs

Brocade switch problems can cause CXFS to behave abnormally. For easier troubleshooting, use the `syslogdipadd` function on the switch to redirect its `syslogd` information to up to six potential metadata servers in the cluster. SGI recommends logging to at least two potential metadata servers on which you troubleshoot issues and look for error messages. The `syslogd` information is the same as that given by `errshow` command on the switch.

For example, on each switch, define the metadata server nodes MDS1 and MDS2 to which the switch can redirect its `syslogd` output:

```
switch:admin > syslogdipadd ipaddress_MDS1  
switch:admin > syslogdipadd ipaddress_MDS2
```

The entries from the switch can be sorted because they are prefixed by the switch name, which is standard `syslogd` behavior.

## Common Problems

The following are common problems and solutions:

- "Client Membership Loss" on page 393
- "Node is Permanently Fenced" on page 395
- "GUI Connection Error" on page 396
- "Cannot Access Filesystem" on page 396
- "Log Files Consume Too Much Disk Space" on page 396
- "Unable to Define a Node" on page 397
- "System is Hung" on page 397
- "Node is Detected but Never Joins Membership" on page 397
- "Cell ID Count and Membership delivered Messages" on page 397

- "Cannot Log In" on page 398
- "I/O Error in Filesystem" on page 399
- "Cannot Mount Filesystems" on page 399
- "GUI Displays Invalid Filesystems" on page 400
- "Multiple `client_timeout` Values" on page 400
- "No HBA WWPNs are Detected" on page 400
- "XFS Internal Errors in System Log File" on page 402
- "Multiple Ethernet Interfaces on Altix Systems" on page 403
- "Clients Unable to Remount Filesystems" on page 403
- "Forced Filesystem Shutdown Messages and XFS File Corruption" on page 403
- "GUI Will Not Run" on page 405
- "IPMI Issues" on page 405
- "`cxfs_admin` Output is Not Current" on page 408
- "`clconfd` Is Not Running" on page 408
- "Inappropriate Node Membership Loss" on page 408
- "Slow Access to Files" on page 409
- "CXFS Cannot Access the Switch" on page 410
- "Altix NMI System Reset Hangs" on page 410
- "Metadata Server Panics After Reboot" on page 410
- "Portmapper Issues" on page 411
- "Brocade `telnet` Session is Hung" on page 411
- "Clients Cannot Join the Cluster After Relocation" on page 411
- "`df` Display Problems for NFSv4-Exported Filesystems " on page 412
- "`mkinitrd` Fails" on page 412



## Client Membership Loss

The following messages indicate that a client has lost membership (line breaks added here for readability):

```
Mar 15 10:55:35 5A:mvxfs2 kernel: Error -1 reading mesg header channel 0 cell 4 (mvxfs17)
  [priority 1 at 192.168.17.173 via 192.168.17.48]
Mar 15 10:55:35 4A:mvxfs2 kernel: Error receiving messages from cell 4 (mvxfs17) tcpchannel 0
  [priority 1 at 192.168.17.173 via 192.168.17.48]
Mar 15 10:55:36 5A:mvxfs2 kernel: Error -1 reading mesg header channel 1 cell 4 (mvxfs17)
  [priority 1 at 192.168.17.173 via 192.168.17.48]
Mar 15 10:55:36 4A:mvxfs2 kernel: Error receiving messages from cell 4 (mvxfs17) tcpchannel 1
  [priority 1 at 192.168.17.173 via 192.168.17.48]
Mar 15 10:55:36 5A:mvxfs2 kernel: Error -1 reading mesg header channel 1 cell 4 (mvxfs17)
  [priority 2 at 163.154.17.173 via 163.154.17.48]
Mar 15 10:55:36 4A:mvxfs2 kernel: Error receiving messages from cell 4 (mvxfs17) tcpchannel 1
  [priority 2 at 163.154.17.173 via 163.154.17.48]
Mar 15 10:55:36 4A:mvxfs2 kernel: Transport failure cell 4
  [priority 2 at 163.154.17.173 via 163.154.17.48] 0 of 2 interfaces up
Mar 15 10:55:36 6A:mvxfs2 kernel: Heartbeat Monitor:Failure time-stamp 295789 ticks:Last heartbeat
  time-stamp 289940 ticks:Time-stamp delta 5849 ticks (5 seconds):Heartbeat timeout 5120 ticks (5 seconds)
```

The Error receiving and Error reading messages indicate that the message channel went down. The last message, which includes the Heartbeat Monitor string, contains other strings that give clues as to why the channel was disconnected. Table 15-1 on page 393 lists all of the possible strings that may be included.

**Table 15-1** Error Strings

String	Description
Aggregate Recover Transport	Failover has forced the transport down because the remote node has detected an error on the transport.
Aggregate Send	An error has occurred while attempting to send a message on the underlying socket. The most likely reason is that the message channel has been disconnected by the remote end.
Cell Up	An error occurred while attempting to establish a connection with the remote node.

---

String	Description
<code>disable heartbeat</code>	A configuration change has eliminated the node from the cluster or the local node is shutting down CXFS.
<code>Failure time-stamp</code>	The time-stamp in ticks of when the error was detected.
<code>Heartbeat Processing</code>	A CXFS kernel heartbeat has been received from the node that indicates it has dropped the local node from its set of known nodes.
<code>Heartbeat Monitor</code>	A CXFS kernel heartbeat timeout has been detected.
<code>Heartbeat timeout</code>	The configured timeout in ticks and in seconds for the CXFS kernel heartbeat.
<code>Last heartbeat time-stamp</code>	The time-stamp in ticks when the last CXFS kernel heartbeat from the remote node was received.
<code>Message Failure</code>	One of the following: <ul style="list-style-type: none"> <li>• An internal messaging error (for example, a corrupt header has been received). This brings down all transports connected to the remote node. This is a serious error that indicates a problem in the local node, the remote node, or the network is causing corruption.</li> <li>• A socket error has occurred while attempting to send a message. The most likely reason is that the message channel has been disconnected by the remote end.</li> </ul>
<code>Receive Thread</code>	A socket error has occurred when attempting to receive a message. The most likely reason is that the message channel has been disconnected by the remote end.
<code>Time-stamp delta</code>	The difference in ticks and in seconds. If this delta is greater than the configured CXFS kernel heartbeat timeout, then it is definitively a heartbeat timeout.

---

In the above example, the last message indicates that there is a heartbeat timeout because the string `Heartbeat Monitor` is included. The message also indicates that the error was detected at 295789 ticks (`Failure time-stamp` string) and that the configured timeout is 5120 ticks or 5 seconds (the `Heartbeat timeout` string). The delta is 5849 ticks or 5 seconds (the `Time-stamp delta` string), therefore it is a heartbeat timeout because the delta is greater than the configured heartbeat timeout.

## **Node is Permanently Fenced**

If you are unable to raise the fence on a node, it may be that the switch ports are unable to determine the WWPN. See "Hardware Changes and I/O Fencing" on page 313.

## GUI Connection Error

When running the CXFS GUI (`cxfsmgr`), an error occurs if the following line is commented out in the file `/etc/ld.so.conf`:

- x86-64 systems:

```
/usr/lib64/sysadm/lib
```

- ia64 systems:

```
/usr/lib/sysadm/lib
```

For example, an x86-64 system would display the following error:

```
Error connecting to server: /usr/lib64/sysadm/bin/sysadmd: error
while loading shared libraries: libsysadmUtil.so.0: cannot open
shared object file: No such file or directory.
```

To resolve the problem, do the following:

1. Uncomment the `/usr/lib64/sysadm/lib` or `/usr/lib/sysadm/lib` line in the file `/etc/ld.so.conf`.
2. Make your change take effect:

```
# ldconfig
```

## Cannot Access Filesystem

If you cannot access a filesystem, check the following:

- Is the filesystem enabled? Check the GUI and the `cxfs_admin status` command.
- Were there mount errors?

## Log Files Consume Too Much Disk Space

If the log files are consuming too much disk space, you should rotate them; see "Log File Management" on page 310. You may also want to consider choosing a less-verbose log level; see the following:

- "cad.options on Server-Capable Administration Nodes" on page 130
- "fs2d.options on Server-Capable Administration Nodes" on page 131

- "Configure Log Groups with the GUI" on page 200

## Unable to Define a Node

If you are unable to define a node, it may be that there are hostname resolution problems. See "Hostname Resolution and Network Configuration Rules" on page 117.

## System is Hung

The following may cause the system to hang:

- Overrun disk drives.
- CXFS kernel heartbeat was lost. In this case, you will see a message that mentions `withdrawl` of node.
- As a last resort, do a non-maskable interrupt (NMI) of the system and contact SGI. (The NMI tells the kernel to panic the node so that an image of memory is saved and can be analyzed later.) For more information, see the owner's guide for the node. Make available the `/var/log/messages` system log file on server-capable administration nodes.

## Node is Detected but Never Joins Membership

If a node is detected in the system log file but it never receives a `Membership delivered` message, it is likely that there is a network problem. See Chapter 8, "Postinstallation Steps" on page 129.

## Cell ID Count and `Membership delivered` Messages

The `Membership delivered` messages in the system log file include a bitmask with a bit set for the cell IDs of nodes that are members of the new CXFS membership. The `Membership delivered` messages are followed by one or more messages starting with `Cell(age) :` that print the individual cell IDs and the ages of their membership. `0xXXX` is a binary bitmask of cells included in the membership. In the following example, cell 0 has been in the last 21 CXFS memberships:

```
NOTICE: Membership delivered for cells 0x3.  
Cell(age): 0(21) 1(12)
```

If the Membership delivered messages are appearing frequently in the system log file, it may indicate a network problem:

- Nodes that are stable and remain in the membership will have a large membership version number.
- Nodes that are having problems will be missing from the messages or have a small membership version number.

See Chapter 8, "Postinstallation Steps" on page 129.

## Cannot Log In

If you cannot log in to a server-capable administration node, you can use one of the following commands, assuming that the node you are on is listed in the other nodes' `.rhosts` files:

```
# rsh hostname ksh -i  
# rsh hostname csh -i
```

## I/O Error in Filesystem

The following message indicates a problem (output lines wrapped here for readability):

```
ALERT: I/O error in filesystem ("/mnt") metadata dev 0xbd block 0x41df03 ("xlog_iodone")
ALERT:      b_error 0 b_bcount 32768 b_resid 0
NOTICE: xfs_force_shutdown(/mnt,0x2) called from line 966 of file ../fs/xfs/xfs_log.c.
      Return address = 0xc0000000008626e8
ALERT: I/O Error Detected.  Shutting down filesystem: /mnt
ALERT: Please umount the filesystem, and rectify the problem(s)
```

You can fix this problem using `xfs_repair` only if there is no metadata in the XFS log. See "Forced Filesystem Shutdown Messages and XFS File Corruption" on page 403, for the appropriate procedure.

I/O errors can also appear if the node is unable to access the storage. This can happen for several reasons:

- The node has been physically disconnected from the SAN
- A filesystem shutdown due to loss of membership
- A filesystem shutdown due to lost of the metadata server
- The node has been fenced out of the SAN

## Cannot Mount Filesystems

If you are unable to raise the fence on a node, it may be that the switch ports are unable to determine the WWPN. See "Hardware Changes and I/O Fencing" on page 313.

If you have defined filesystems and then rename your cluster (by deleting the old cluster and defining a new cluster), CXFS will not be able to mount the existing filesystems. This happens because the clustered XVM volume on which your CXFS filesystem resides is not accessible to the new cluster, and the volumes are therefore considered as foreign.

In order to mount the filesystem on the new cluster, you must use the XVM `steal` command to bring the clustered XVM volume into the domain of the new cluster. For more information, see the *XVM Volume Manager Administrator's Guide*.

## GUI Displays Invalid Filesystems

If you create new slices on a previously sliced disk that have the same starting blocks as slices already existing on the disk, and if the old slices had filesystems, then the GUI will display those old filesystems even though they may not be valid.

## Multiple `client_timeout` Values

The `clconfd` and `cxfs_client` daemons set the `client_timeout` value. The value depends on the order in which filesystems are mounted on the various nodes and adapts to help ensure that all filesystems get mounted in a timely manner. The value may differ among nodes and has no effect on the filesystem operation after it is mounted.



---

**Caution:** You should not attempt to change the `client_timeout` value. Improperly setting the values for `client_timeout` and `retry` could cause the `mount` command to keep waiting for a server and could delay the availability of the CXFS filesystems.

---

The `retry` value is forced to be 0 and you cannot change it.

## No HBA WWPNS are Detected

On most platforms, the `cxfs_client` software automatically detects the world wide port names (WWPNs) of any supported host bus adapters (HBAs) in the system that are connected to a switch that is configured in the cluster database. These HBAs will then be available for fencing.

However, if no WWPNs are detected, there will be messages logged to the `cxfs_client` file.

If no WWPNs are detected, you can manually specify the WWPNs in the `/etc/fencing.conf` fencing file for the Linux platform. This method does not work if the WWPNs are partially discovered.

The fencing file enumerates the worldwide port name for all of the HBAs that will be used to mount a CXFS filesystem. There must be a line for the HBA WWPN as a 64-bit hexadecimal number.



---

**Note:** The WWPN is that of the HBA itself, **not** any of the devices that are visible to that HBA in the fabric.

---

If used, the fencing file must contain a simple list of WWPNs, one per line.

If you use the fencing file, you must update it whenever the HBA configuration changes, including the replacement of an HBA.

Do the following:

1. Set up the switch and HBA.
2. Follow the Fibre Channel cable on the back of the node to determine the port to which it is connected in the switch. Ports are numbered beginning with 0. (For example, if there are 8 ports, they will be numbered 0 through 7.)
3. Use the `telnet` command to connect to the switch and log in as user `admin` (the password is `password` by default).
4. Execute the `switchshow` command to display the switches and their WWPN numbers.

For example:

```
brocade04:admin> switchshow
switchName:      brocade04
switchType:      2.4
switchState:     Online
switchRole:      Principal
switchDomain:     6
switchId:        fffc06
switchWwn:       10:00:00:60:69:12:11:9e
switchBeacon:    OFF
port 0: sw  Online      F-Port  20:00:00:01:73:00:2c:0b
port 1: cu  Online      F-Port  21:00:00:e0:8b:02:36:49
port 2: cu  Online      F-Port  21:00:00:e0:8b:02:12:49
port 3: sw  Online      F-Port  20:00:00:01:73:00:2d:3e
port 4: cu  Online      F-Port  21:00:00:e0:8b:02:18:96
port 5: cu  Online      F-Port  21:00:00:e0:8b:00:90:8e
port 6: sw  Online      F-Port  20:00:00:01:73:00:3b:5f
port 7: sw  Online      F-Port  20:00:00:01:73:00:33:76
port 8: sw  Online      F-Port  21:00:00:e0:8b:01:d2:57
```

```
port 9: sw Online F-Port 21:00:00:e0:8b:01:0c:57
port 10: sw Online F-Port 20:08:00:a0:b8:0c:13:c9
port 11: sw Online F-Port 20:0a:00:a0:b8:0c:04:5a
port 12: sw Online F-Port 20:0c:00:a0:b8:0c:24:76
port 13: sw Online L-Port 1 public
port 14: sw No_Light
port 15: cu Online F-Port 21:00:00:e0:8b:00:42:d8
```

The WWPN is the hexadecimal string to the right of the port number. For example, the WWPN for port 0 is 2000000173002c0b (you must remove the colons from the WWPN reported in the `switchshow` output to produce the string to be used in the fencing file).

5. Create the `/etc/fencing.conf` fencing file and add the WWPN for the port determined in step 2. (Comment lines begin with #.)

For dual-ported HBAs, you must include the WWPNs of any ports that are used to access cluster disks. This may result in multiple WWPNs per HBA in the file; the numbers will probably differ by a single digit.

For example, if you determined that port 0 is the port connected to the switch, your fencing file should contain the following:

```
# WWPN of the HBA installed on this system
#
2000000173002c0b
```

6. After the node is added to the cluster, enable the fencing feature by using the CXFS GUI, `hafence`, or `cxfs_admin` on a server-capable administration node.

## XFS Internal Errors in System Log File

After a filesystem has been defined in CXFS, running `mkfs` on it (or using "Make Filesystems with the GUI" on page 207) will cause XFS internal errors to appear in the system log file. For example (line breaks added for readability):

```
Aug 17 09:25:52 1A:yokohama-mds1 unix: ALERT: Filesystem "(NULL)": XFS internal error
xfs_mount_validate_sb(4) at line 237 of file ../fs/xfs/xfs_mount.c.
Caller 0xc000000000326ef4
```

```
Aug 17 09:14:52 6X:yokohama-mds1 clconfd[360]: < E clconf 11> CI_FAILURE, fsinfo_update(/dev/cxvm/work)
kernel returned 1010 (Filesystem is corrupted)
```

To avoid these errors, run `mkfs` before defining the filesystem in CXFS or delete the CXFS filesystem before running `mkfs`.

## Multiple Ethernet Interfaces on Altix Systems

In Altix systems with multiple Ethernet interfaces, the default behavior of the operating system is to dynamically assign interface names (such as `eth0`, `eth1`, and so on) at boot time. Therefore, the physical interface associated with the `eth0` device may change after a system reboot; if this occurs, it will cause a networking problem for CXFS. To avoid this problem, provide persistent device naming by using the `/etc/sysconfig/networking/eth0_persist` file to map specific Ethernet device names to specific MAC addresses. Adding lines of the format to the `eth0_persist` file:

```
ethN MAC_ID
```

For example:

```
eth0 08:00:69:13:dc:ec  
eth1 08:00:69:13:72:e8
```

## Clients Unable to Remount Filesystems

If you have multiple metadata servers in the cluster but only one potential metadata server defined for a given filesystem and that server goes down, the now server-less filesystem goes into a shutdown state. Although the clients maintain membership in the cluster, they will not remount the filesystem automatically when the potential metadata server comes back up. You must manually unmount the filesystem.

If there had been only one potential metadata server in the cluster, the filesystem's clients would have lost membership and gone through a forced shutdown, which automatically unmounts the filesystems.

## Forced Filesystem Shutdown Messages and XFS File Corruption

Forced filesystem shutdown messages **do not** necessarily imply that `xfs_repair` should be run. Following is an example of a message that does indicate an XFS file corruption:

```
XFS read error in file system metadata block 106412416
```

When a filesystem is forcibly shut down, the log is not empty — it contains valuable metadata. You must replay it by mounting the filesystem. The log is only empty if the filesystem is unmounted cleanly (that is, not a forced CXFS shutdown, not a crash). You can use the following command line to see an example of the transactions captured in the log file:

```
xfs_logprint -t device
```

If you run `xfs_repair` before mounting the filesystem, `xfs_repair` will delete all of this valuable metadata.

You should run `xfs_ncheck` and capture the output to a file before running `xfs_repair`. If running `xfs_repair` results in files being placed in the `lost+found` directory, the saved output from `xfs_ncheck` may help you to identify the original names of the files.



**Caution:** Always contact SGI technical support before using `xfs_repair` on CXFS filesystems. See "Repair Filesystems with Care" on page 75.

---

If you think you have a filesystem with real corruption, do the following from an Linux node with XFS commands RPM (`sgi-xfsprogs`) installed:

1. Disable the filesystem in CXFS:

```
linux# /usr/cluster/bin/cxfs_admin -A -c 'unmount filesystem'
```

2. Mount the device in order to replay the log:

```
linux# mount device any_mount_point
```

3. Unmount the filesystem:

```
linux# unmount device
```

4. Check the filesystem:

```
linux# xfs_check device
```

5. View the repairs that could be made, using `xfs_repair` in no-modify mode:

```
linux# xfs_repair -n device
```

6. Capture filesystem file name and inode pairs:

```
linux# xfs_ncheck device > xfs_ncheck.out
```

7. If you are certain that the repairs are appropriate, complete them:

```
linux# xfs_repair device
```

8. Enable the filesystem in CXFS:

```
linux# /usr/cluster/bin/cxfs_admin -A -c 'mount filesystem'
```

## GUI Will Not Run

If the GUI will not run, check the following:

- Is the license key properly installed on the server-capable administration node? See the following:
  - "Verify the License" on page 140
  - "License Key Error" on page 419
- Are the cluster daemons running? See "Verify that the Cluster Daemons are Running" on page 141.
- Are the `tcpmux` and `tcpmux/sgi_sysadm` services enabled in the `/etc/xinetd.d/tcpmux` and `/etc/tcpmux.conf` files?
- Are the `inetd` or `tcp` wrappers interfering? This may be indicated by `connection refused` or `login failed` messages.
- Are you connecting to a server-capable administration node? The `cxfsmgr` command can only be executed on a server-capable administration node. The GUI may be run from another system via the Web if you connect the GUI to a server-capable administration node.

## IPMI Issues

This section discusses the following IPMI issues:

- "BMC Does Not Respond to a ping Command" on page 406
- "ipmitool Command Fails" on page 406
- "Node is Not Reset" on page 407

### BMC Does Not Respond to a ping Command

If the baseboard management controller (BMC) does not respond to a `ping(8)` command from a remote node, verify that the BMC has a valid IP address assigned. See step 4 in "BMC System Controller" on page 465.

---

**Note:** The BMC will not respond to the `ping` command when issued from the local node (the node containing the BMC).

---

### `ipmitool` Command Fails

If an `ipmitool(1)` command issued to a local BMC device (the node containing the BMC) fails, check the following:

- Are the IPMI modules loaded? See step 2 in "BMC System Controller" on page 465.
- Does the IPMI device exist? The default device name is `/dev/ipmi0`.
- Has the `admin` user name and password been set on the BMC with the required ADMINISTRATOR privileges? See step 3 in "BMC System Controller" on page 465.
- Does the BMC have a valid IP address assigned? See step 4 in "BMC System Controller" on page 465.
- Does the `ipmitool` command line contain all of the required arguments, including the OEM identifier and the device path? The basic command line used for a local node is as follows:

```
# ipmitool -o intelplus -d /dev/ipmi0 command
```

For example:

```
# ipmitool -o intelplus -d /dev/ipmi0 power status
Chassis Power is on
```

For more information, see the `ipmitool(1)` man page.

If an `ipmitool(1)` command issued to the BMC from a remote node fails, check the following:

- Does the BMC respond to the `ping(8)` command? See "BMC Does Not Respond to a ping Command" on page 406.

- Is the correct version of `ipmitool` installed? See step 1 in "BMC System Controller" on page 465.
- Have the `admin` user name and password been set on the BMC with the required `ADMINISTRATOR` privileges? See step 3 in "BMC System Controller" on page 465.
- Does the `ipmitool` command contain all of the required arguments, including the `lanplus` interface, the OEM identifier, and the IP address (or alias) for the BMC? The basic command line used from a remote node is as follows:

```
# ipmitool -I lanplus -o intelplus -H bmc-nodename -U admin -P admin_password command
```

For example:

```
# ipmitool -I lanplus -o intelplus -H my-bmc-node \  
-U admin -P mypassword power status  
Chassis Power is on
```

For more information, see the `ipmitool(1)` man page.

- Does the BMC IP address (or alias) specified with the `ipmitool -H` command respond to a `ping(8)`?
- Does the BMC have address resolution protocol (ARP) and gratuitous ARP configured, with the ARP interval set to 5 seconds? (An interval of 5 seconds is supported for CXFS.) See step 4 in "BMC System Controller" on page 465.

### Node is Not Reset

If a node is not properly reset by CXFS, check the following:

- Does the node's failpolicy contain `Reset` or `FenceReset`? See the following:
  - "Modify a Node Definition with the GUI" on page 189
  - "Create or Modify a Node with `cxfs_admin`" on page 242
- Does the BMC respond to a `ping(8)` command from the node defined as the `reset_node`? See "BMC Does Not Respond to a `ping` Command" on page 406.
- Does `ipmitool(1)` work correctly from the node defined as the `reset_node`? Check the system log files for relevant error messages and see the following:
  - "ipmitool Command Fails" on page 406
  - "BMC System Controller" on page 465

### **cxfs\_admin Output is Not Current**

If the `cxfs_admin` output appears to be stale (such as after you manually change the port status, in which case the CXFS database is not informed), you can update the CXFS database by running the following command:

```
server-admin# /usr/cluster/bin/hafence -U
```

### **clconfd Is Not Running**

Sending `clconfd` a `SIGTERM` signal, the default signal sent by the `kill(1)` command, will cause the `clconfd` process to terminate. When the `clconfd` process terminates on a `SIGTERM` signal, it is not restarted by `cmond` and the node will remain in the CXFS cluster membership. All filesystem activity will continue without interruption. However, if `clconfd` is not running on one or more server-capable administration nodes in the cluster, configuration changes cannot be made in the cluster and CXFS recovery may hang, preventing nodes from joining the cluster membership.

The `clconfd` process will not run if there is a licensing problem. See "clconfd Daemon Death" on page 417.

### **Inappropriate Node Membership Loss**

If you experience problems involving a node being inappropriately taken out of the cluster membership (reset, fenced, or shut down, depending upon how the node fail policy is set), it may be that the CXFS kernel heartbeat timeout setting is inappropriate, especially if your cluster includes a large SGI Altix system (one with more than 64 processors). If you suspect this problem, you should examine the `SYSLOG` messages to determine the current kernel heartbeat timeout. Membership issues can involve either:

- Heartbeats sent from server-capable administration nodes to all other nodes in the cluster
- Heartbeats sent from client-only nodes to server-capable administration nodes (these are more likely to have problems)

Every kernel heartbeat multicast packet includes a counter value that monotonically increases with every heartbeat sent by the system. You can use a `snoop/tcpdump` of the private network to look at the counter and determine if the issue is a missing heartbeat or a late heartbeat. A nonconsecutive heartbeat count indicates that the heartbeat was issued by the client-only node but never received by the server-capable



administration node. It generally indicates a problem somewhere in the network stack or physical network layer.

Most client-only node heartbeat timeouts are caused by late heartbeats. This is a heartbeat multicast that is not sent out by the client-only node in a timely fashion. It is a strong indicator that the client-only node is suffering from some sort of resource constraint issue. Many common resources are subject to this problem, and detailed system performance analysis is usually required to determine the exact nature of the failure. The following are common problem areas:

- Kernel locks can be held for very long periods of time and prevent a client-only node from issuing a heartbeat multicast packet in a timely fashion.
- The CPU servicing interrupts for a CXFS private network interface may be too busy with other activities to service the CXFS heartbeat kernel thread.
- Memory thrashing and the associated high-priority kernel threads attempting to relieve the memory pressure may prevent the CXFS kernel heartbeat thread from being serviced or prevent the thread from allocating the memory it requires.
- Buffered I/O uses page cache and therefore contends for the same memory resources as user applications. Applications that have high I/O requirements can put intense pressure on system memory management functions and cause memory thrashing when dealing with a large amount of dirty page cache pages.
- A poorly configured or over-stressed CXFS private network can cause dropped heartbeat packets. This can be a problem with any node and can effect multiple client-only nodes at the same time.

To avoid these problems, see "Avoid CXFS Kernel Heartbeat Issues on Large SGI Altix Systems" on page 66.

## Slow Access to Files

If file access is slow, it could be due to one of the following problems:

- Ownership changes for a LUN between RAID controllers (*LUN flipping*) can result in poor disk performance. To determine if LUN flipping is a problem, compare the contents of the `/etc/failover2.conf` file and the output of the following command (which shows the LUNs designated as preferred):

```
# xvm show -v phys | grep preferred
```

If the preferred LUNs do not also show `current path`, there is a problem with ownership changes.

- File fragmentation can also decrease performance. Run the following command on the metadata server for the file with suspected fragmentation:

```
# xfs_bmap -v filename
```

### CXFS Cannot Access the Switch

There is only a single active `admin` login permitted to Fibre Channel switches that are properly configured for CXFS. If there is a defunct `admin` login remaining, CXFS may be unable to access the switch.

To solve this problem, do the following:

1. Log in to the Fibre Channel switch as `root`.
2. Determine the process IDs of the inactive `admin` logins. For example:

```
brocade:root> ps -ef | grep defunct
root      9179   9173   0 Apr12 ?          00:00:00 [login] <defunct>
root     18311  18308   0 May13 ?          00:00:00 [login] <defunct>
```

3. Kill the defunct login process IDs. For example:

```
brocade:root> kill -9 9179 18311
```

4. Remove the contents of the login records file:

```
brocade:root> cat /dev/null > /var/run/utmp
```

### Altix NMI System Reset Hangs

On SGI Altix machines, an NMI system reset will not proceed until there is human intervention. See "System Reset" on page 56.

### Metadata Server Panics After Reboot

Rebooting the metadata server without first shutting down CXFS services can cause the metadata server to panic. You must use the proper procedures for shutting down nodes. See "Shut Down Nodes Unobtrusively" on page 76.

## Portmapper Issues

The dynamic TCP port assignment used by the `fs2d` daemon may result in a collision with another service that is already using a fixed port number.

One example that has been observed is Samba hanging during startup when trying to query the CUPS printing system for printer information. Other applications that expect to connect on a well-known port may be affected.

To see which ports `fs2d` is using, use the following command:

```
# lsof -i TCP | grep fs2d
```

If you encounter this problem, one option is to restart `fs2d` with a `SIGHUP` signal so that it will move to another port:

```
# /usr/bin/killall -HUP fs2d
```

You may have to repeat this command until `fs2d` is assigned to a port that is not in contention.

## Brocade telnet Session is Hung

The Brocade `telnet` login session can become hung for Brocade switches running firmware version V5\* and later. To clear the situation, do the following:

1. Log in to the switch as `root`.
2. Kill the defunct `telnet` login process IDs.
3. Execute the following command:

```
# cat /dev/null > /var/run/utmp
```

## Clients Cannot Join the Cluster After Relocation

If a CXFS client fails or exits the cluster during the metadata server relocation process, the relocation process and the client recovery are likely to hang. This prevents any clients, including the failed client, from joining the cluster.

Once in this state, it may be possible to resolve the deadlock by resetting or power-cycling the `fs2d` quorum master. See "Determine the Quorum Master" on page 390.

## df Display Problems for NFSv4-Exported Filesystems

NFSv4-exported filesystems do not display properly in `df` output on Linux nodes. This is an NFS issue that exists independent of CXFS.

## mkinitrd Fails

If `mkinitrd` fails, it may be because a new kernel module was installed but the `sgi-xfspgms` RPM was not installed. To resolve this problem, install the `sgi-xfspgms` RPM and rerun `mkinitrd`.

## Understanding Error Messages

This section describes some of the error messages you may see. In general, the example messages are listed first by type and then in alphabetical order, starting with the message identifier or text.

---

**Note:** The `/var/log/messages` file may contain spurious error messages. This problem occurs in clusters with multiple private networks when one of the active network interfaces is downed by using the `ifconfig` command. This problem may also happen when the network is interrupted for other reasons.

Some of the transport failure messages generated may have cell IDs that are different from the cell ID of the node with the downed interface. The spurious error messages do not appear to affect the continued operation of the cluster.

---

This section discusses the following:

- "Normal Messages" on page 413
- "Relocation Error" on page 416
- "Shutdown Failure" on page 416
- "Controller Disable Messages" on page 417
- "CMS Error Messages" on page 417
- "clconfd Daemon Death" on page 417
- "Out of Logical Swap Space" on page 418

- "Lost CXFS Membership" on page 418
- "License Key Error" on page 419
- "IP Address Error" on page 420
- "System Log File Errors" on page 421
- "Log File Error Messages" on page 433
- "cdbreinit Error Messages" on page 438
- "cxfs\_admin Errors" on page 439
- "Mount Errors" on page 440
- "Authorization Errors" on page 440
- "Connection Error" on page 440
- "node is downrev Error" on page 441
- "EXTENT Errors" on page 442
- "GRIOv2 Errors" on page 442

## Normal Messages

Many messages are normal and do not indicate a problem. Following is a subset of normal messages:

```
NOTICE: Error reading mesg header 4 channel 1 cell 2
```

Error number 4 (EINTR) on MEMBERSHIP message channel (channel 1; channel 0 is the main channel for CXFS and XVM data) for connection with node 2. The EINTR indicates that this message channel is purposely being torn down and does not indicate an error in itself. (Any other error number is a real error that will cause the local node to declare the other node failed.) This is an informative message; no corrective action is required.

```
NOTICE: Membership delivered for cells 0x2
```

Membership has been delivered for the specified node. 0xXXX is a binary bitmask of cell numbers for which membership has been delivered; 0x2 equates to cell 1.

Cell(age) : 0(4) 1(2) 2(9)

Shows the cell and its age (the number of memberships it has been part of). One or more of these messages always follows a Membership delivered message.

NOTICE: Cell 3 (client) has joined the membership

The node with the specified cell ID has joined the membership. This message precedes a Membership delivered message if a node joined the membership.

NOTICE: Cell 3 (client) has left the membership

This message precedes a Membership delivered message if a node has left the membership.

NOTICE: Resetting cells 0x4

The number here is a bitmask of node numbers on which a reset is being requested. 0xXXX is a binary bitmask of cells being reset. In this case, 0x4 equates to cell 2. This is an informative message; no corrective action is required.

CI\_FAILURE, Cell 1 Machine cxfs1: server has no information about a machine that has reset capabilities for this machine

A reset mechanism was not provided for this node. The node will not be automatically reset if it fails. If you do not have reset capability, this message can be ignored. System reset configuration is recommended for all potential metadata servers.

CI\_CLCONFERR\_INIT in ep\_name() not binding socket

This message appears before the daemons start.

clconfd[16574]: <<CI> E clconf 0> CI\_CLCONFERR\_INIT, in ep\_name(): not binding socket

This clconfd message appears when daemons are starting up.

```

date <I0 clconfd clconf 610:0 clconfd_client.c:84> client
registration: clconfinfo, id 9119
date <I0 clconfd clconf 610:0 clconfd_service.c:781> sending
reply configuration and membership msg to client: clconfinfo,
id 9119
date <I0 clconfd clconf 610:0 clconfd_client.c:96> client
un-registration: clconfinfo, id 9119

```

These messages are issued if you run the `clconf_info` command. The `clconf_info` command first registers as a CXFS client with `clconfd`; it then gets a reply message to its request for configuration and membership status; finally, it unregisters when it is done.

```

date <I0 clconfd clconf 610:0 clconfd_service.c:781 sending reply
configuration and membership msg to client: cad, id 602

```

This message indicates that the `cad` daemon is polling `clconfd` for status regularly. `cad` does not register and unregister each time like `clconf_info` because it is a daemon and it does not exit after each request. You will see register/unregister messages for `cad` only when `cad` or `clconfd` restarts.

```

dcvn_import_force: error 1502 from invk_dsvn_obtain_exist

```

This is a normal message sent during the recovery process.

```

kernel: cxfs_cconnect_loop: cxfs_connect_find returns error =
110

```

This message will be produced if a filesystem is not successfully mounted within the designated timeout period. The mount will be retried.

```

cell 9: Membership daemon started

```

The CXFS membership daemon has started on the node with cell ID 9.

```

Starting tcp server for interface 192.168.14.47 channel 0

```

The machine has started accepting connections from other nodes in the cluster on the indicated interface.

```

Starting udp discovery for interface 192.168.13.163

```

The machine has started listening for heartbeat packets.

Starting udp multicast discovery for interface 192.168.13.163

The machine has started listening for heartbeat packets.

Discovered cell 8 (cxfsxe7) [priority 1 at 192.168.13.101 via 192.168.13.47] 1 of 2 interfaces up

A connection is being established between this node and node cxfsxe7; the local and remote network addresses used for this connection are shown as well.

## Relocation Error

If you try to relocate a filesystem and see an error similar to the following cxfs\_admin example, it means that relocation has not been enabled:

```
Error returned from server: feature not enabled (12)
Command "relocate slicelC server=server1" failed during commit: feature not enabled
```

To allow the relocation to occur, you must enable relocation as specified in "Relocation" on page 26.

If you see an error message such as the following when trying to shut down a node, it means that the node which is the active metadata server for one or more filesystems and was unable to unmount the filesystems, and therefore was unable to shutdown gracefully:

```
Aug 31 10:06:18 cc-xe kernel: Filesystem "xvm-2": relocation from this host is disabled
```

Also see "Shutdown Failure" on page 416.

## Shutdown Failure

If a node is unable to shutdown gracefully, it may be because it was unable to unmount the filesystems for which it is the active metadata server. See "Relocation Error" on page 416.



## Controller Disable Messages

If you see messages such as the following on the console or in a message log, it means that the Fibre Channel switch is misconfigured:

```
controller disable is not supported on loop
```

CXFS fencing recovery operations do not support loop mode. Verify that all Fibre Channel switches are configured correctly. See the switch documentation for configuration information.

## CMS Error Messages

The following messages may be logged by CMS:

```
CMS excluded cells 0xXXX with incomplete connectivity
```

Generated when CMS delivers a membership that excluded some **new** cells that had not established connections with enough cells yet to be admitted. 0xXXX is a binary bitmask of excluded cells.

```
CMS calculation limited to last membership:configuration change incomplete on cells 0xXXX
```

Generated when the leader is attempting to make a configuration change current (that is, actually use the change on all nodes), but some cells in the cluster have not yet gotten the configuration change staged (uploaded and ready to be made current). 0xXXX is a binary bitmask of cells that do not yet have the change in their configuration. Changes make their way through the cluster asynchronously, so this situation is expected. It can take a few attempts by the CMS leader before all nodes have the change staged. As long as this situation resolves eventually, there is no problem.

```
CMS calculation limited to last membership:recovery incomplete
```

Generated when new members were disallowed due to recovery from the last cell failure that is still being processed.

## clconfd Daemon Death

If the `clconfd` daemon exits immediately after it starts up, it usually means that the CXFS license key has not been properly installed. Check the end of the `clconfd` log file (`/var/cluster/ha/log/clconfd_nodename`) for error messages. For information about licensing error messages, see "License Key Error" on page 419.

You must properly install the license keys before you can use CXFS. If you increase the number of CPUs in your system, you may need a new license key. See Chapter 5, "CXFS Licensing" on page 103.

## Out of Logical Swap Space

The following example system log file message indicates an oversubscribed system:

```
ALERT: inetd [164] - out of logical swap space during fork while
allocating uarea - see swap(1M)
Availsmem 8207 availrmem 427 rlx freemem 10, real freemem 9
```

See "Use System Capacity Wisely" on page 79.

Daemons could also be leaking memory in this case. You may need to restart them:

- On server-capable administration nodes:

```
server-admin# service cxfs_cluster restart
```

- On client-only nodes:

```
client# killall cxfs_client
client# service cxfs_client start
```

## Lost CXFS Membership

The following message in the system log file indicates a kernel-triggered revocation of CXFS membership:

```
Membership lost - withdrawing from cluster
```

You must allow CXFS membership for the local node in this situation. See "Allow Membership of the Local Node with the GUI" on page 201 or "Enable a Node with cxfs\_admin" on page 251.

## License Key Error

You will see the following error if you try to install CXFS on a server-capable administration node without a valid license key already in place:

```
Preparing... #####
[100%]
  1:cxfs_cluster #####
[100%]
cxfs          0:off 1:off 2:off 3:on  4:off 5:on  6:off
cluster_cx-exitop: Added CXFS keys to /var/cluster/cdb/cdb.db
cluster_cx-exitop: Added CXFS administration access keys to
/var/cluster/cdb/cdb.db
cxfs license check failed - use '/usr/cluster/bin/cxfslicense -d' for
details
```

\* \* \* \* \* I M P O R T A N T \* \* \* \* \*

```
CXFS is not properly licensed for this host.  Run
'/usr/cluster/bin/cxfslicense -d'
for more detailed license information.
After fixing the license, please run
'/bin/true; /etc/init.d/cxfs_cluster restart'.
```

```
cluster_cx-exitop: success
```

If you see the following message in the `/var/cluster/ha/log/clconfd_nodename` logfile, it means that the CXFS license key was not properly installed:

```
CXFS not properly licensed for this host.  Run
'/usr/cluster/bin/cxfslicense -d'
for detailed failure information.
```

If you do not have the CXFS license key properly installed, you will see an error on the console when trying to run CXFS. For example:

```
Cluster services: CXFS not properly licensed for this host.  Run
'/usr/cluster/bin/cxfslicense -d'
for detailed failure information.  After fixing the
license, please run '/etc/init.d/cxfs_cluster restart'.
```

An error such as the following example will appear in the system log file:

```
Mar  4 12:58:05 6X:typhoon-q32 crsd[533]: <<CI> N crs 0> Crsd restarted.
Mar  4 12:58:05 6X:typhoon-q32 clconfd[537]: <<CI> N clconf 0>
Mar  4 12:58:05 5B:typhoon-q32 CLCONFD failed the CXFS license check.Use the
Mar  4 12:58:05 5B:typhoon-q32    '/usr/cluster/bin/cxfslicense -d'
Mar  4 12:58:05 5B:typhoon-q32 command to diagnose the license problem.
```

If the `clconfd` daemon dies right after it starts up, this error may be present.

An error such as the following example will appear in the `SYSLOG` file (line breaks added here for readability):

```
Jan 25 10:24:03 ncc1701:Jan 25 10:24:03 cxfs_client:
cis_main FATAL: cxfs_client failed the CXFS license check.
Use the cxfslicense command to diagnose the license problem
```

Message similar to the following will appear in the client-log file:

- **Successful:**

- Server license key granted, regardless of local client license key:

```
date CXFS_Client: cis_license_apply successfully reapplied for server-based license
date CXFS_Client: cis_license_apply allocated 1 "license_type" license(s).
```

- **Unsuccessful (CXFS will not start):**

- Server denies a license key, regardless of local license key presence:

```
date CXFS_Client: cis_license_apply ERROR: No license available
```

On a server-capable administration node, the error will appear in the `clconfd` log.

You must properly install the license key before you can use CXFS. See Chapter 5, "CXFS Licensing" on page 103.

## IP Address Error

If you have conflicting cluster ID numbers at your site, you will see errors such as the following:

```
WARNING: mtcp ignoring alive message from 1 with wrong ip addr 128.162.89.34
WARNING: mtcp ignoring alive message from 0 with wrong ip addr 128.162.89.33
```

A cluster ID number must be unique. This error can occur if you redefine the cluster configuration and start CXFS services while some nodes have stale information from a previous configuration.

To solve this problem, make the cluster ID numbers unique. First try the steps in "Eliminate a Residual Cluster" on page 389. If that does not work, reboot the nodes that have stale information. Stale nodes will complain about all of the nodes, but the up-to-date nodes will complain only about the stale nodes. The `/var/cluster/ha/log/clconfd_log` file on the stale nodes will also show error messages about `SGI_CMS_CONFIG_ID` failures.

If there are too many error messages to recognize the stale nodes, reboot every node.

## System Log File Errors

CXFS logs both normal operations and critical errors to the system log file, as well as to individual log files for each log group.

The system log file on server-capable administration nodes is in `/var/log/messages`.

In general, errors in the system log file file take the following form:

*timestamp priority\_&\_facility : hostname process[ID]: <internal\_info> CODE message\_text*

For example:

```
Sep  7 11:12:59 6X:cxfs0 cli[5830]: < E clconf 0> CI_IPCERR_NOSEVER, clconf
ipc: ipccInt_connect() failed, file /var/cluster/ha/comm/clconfd-ipc_cxfs0
```

Table 15-2 breaks down the parts of the preceding message.

**Table 15-2** System Log File Error Message Format

Content	Part	Meaning
Sep 7 11:12:59	Time stamp	September 7 at 11:12 AM.
6X	Facility and level	6X indicates an informational message. See <code>syslogd</code> and the file <code>/usr/include/sys/syslog.h</code> .
cxfs0	Node name	The node whose logical name is <code>cxfs0</code> is the node on which the process is running.
cli[5830]	Process[ID]	The process sending the message is <code>cli</code> and its process ID number is 5830.
<CI>E clconf 0	Internal information: message source, logging subsystem, and thread ID	The message is from the cluster infrastructure (CI). E indicates that it is an error. The <code>clconf</code> command is the logging subsystem. 0 indicates that it is not multithreaded.
CI_IPCERR_NOSEVER, clconf ipc	Internal error code	Information about the type of message; in this case, a message indicating that the server is missing. No error code is printed if it is a normal message.
ipcclnt_connect() failed, file /var/cluster/ha/comm/clconfd- ipc_cxfs0	Message text	A connection failed for the <code>clconfd-ipc_cxfs0</code> file.

The following sections present only the message identifiers and text:

- "General System Log File Messages" on page 423
- "cli System Log File Error Messages" on page 424
- "clconfd System Log File Error Messages" on page 425
- "crsd System Log File Error Messages" on page 429

- "cmond System Log File Error Messages" on page 430
- "cxfslicense System Log File Error Message" on page 431
- "fs2d System Log File Error Messages" on page 432

### General System Log File Messages

CI\_CONFERR\_NOTFOUND, Logging configuration error: could not read cluster database /var/cluster/cdb/cdb.db, cdb error = 3.

The cluster database has not been initialized. See "Recreating the Cluster Database" on page 448.

WARNING: Error receiving messages from cell 2 tcpchannel 1

There has been an error on the CXFS membership channel (channel 1; channel 0 is the main message channel for CXFS and XVM data). This may be a result of tearing down the channel or may be an error of the node (node with an ID of 2 in this case). There is no corrective action.

CI\_CRFERR\_NOLCK, failed to raise fence on cell 0

This message might indicate that CXFS cannot log in to the switch, which could occur if the switch operation has slowed due to a status change. You should examine the SAN fabric, the Fibre Channel connection, and the switch. You may need to reboot the switch to ensure the stability of CXFS.

This message could also indicate that an existing telnet session has hung on the switch. The fix to this situation, see "Brocade telnet Session is Hung" on page 411 or reboot the switch.

sw core-fc, port 95, host mds02 : still transient, 292s until timeout

This message indicates that the port status is temporary (neither enabled nor disabled). This could be due to an unused port or a

problem with the switch operation, either running too slowly or with too much traffic.

### **cli System Log File Error Messages**

For all `cli` messages, only the last message from the command (which begins with `CLI private command failed`) is meaningful. You can ignore all other `cli` messages.

The following are example errors from the `cli` daemon.

```
CI_ERR_INVALID, CLI private command: failed (Machine (cxfs0)
exists.)
```

You tried to create a new node definition with logical name `cxfs0`; however, that node name already exists in the cluster database. Choose a different name.

```
CI_ERR_INVALID, CLI private command: failed (IP address
(128.162.89.33) specified for control network is cxfs0 is
assigned to control network of machine (cxfs0).)
```

You specified the same IP address for two different private networks of node `cxfs0`. Use a different IP address.

```
CI_FAILURE, CLI private command: failed (Unable to validate
hostname of machine (cxfs0) being modified.)
```

The DNS resolution of the `cxfs0` name failed. To solve this problem, add an entry for `cxfs0` in `/etc/hosts` on all nodes.

```
CI_IPCERR_NOPULSE, CLI private command: failed (Cluster state
is UNKNOWN.)
```

The command could not complete. This is a transient error. However, if it persists, stop and restart the cluster daemons; see "Stopping and Restarting Cluster Administration Daemons" on page 447.



## clconfd System Log File Error Messages

The following errors are sent by the clconfd daemon.

CI\_CONFERR\_NOTFOUND, Could not access root node.

The cluster database is either non-existent or corrupted, or the database daemons are not responding. Check that the database exists.

If you get an error or the dump is empty, re-create the database; for more information, see "Clearing the Cluster Database" on page 444. If the database exists, restart the cluster daemons; see "Stopping and Restarting Cluster Administration Daemons" on page 447.

CI\_ERR\_NOTFOUND, Could not get Cellular status for local machine (cxfs1)

The database is corrupted or cannot be accessed. Same actions as above.

CI\_FAILURE, Call to open cdb for logging configuration when it is already open.

This indicates a software problem requiring you to restart the daemons; see "Stopping and Restarting Cluster Administration Daemons" on page 447.

CI\_FAILURE, Cell 1 Machine cxfs1: server has no information about a machine that has reset capabilities for this machine

A reset mechanism was not provided for this node. The node will not be automatically reset if it fails. To ensure proper failure handling, use the CXFS GUI or cxfs\_admin to modify the node's definition and add reset information. System reset configuration is recommended for all potential metadata servers. See "Define a Node with the GUI" on page 179, or "Create or Modify a Node with cxfs\_admin" on page 242.

CI\_FAILURE, CMD(/sbin/umount -k /dev/xvm/bob1): exited with status 1 (0x1)

An error occurred when trying to unmount the /dev/xvm/bob1 filesystem. Messages from the umount command are usually issued just before this message and provide more information about the reason for the failure.

```
CI_FAILURE, CMD(/sbin/clmount -o 'server_list=(cxfs0,cxfs1)'
/dev/xvm/bob2 /bob2): exited with status 1 (0x1)
```

An error occurred when trying to mount the `/dev/xvm/bob2` filesystem. Messages from the mount command are usually issued just before this message and provide more information about the reason of the failure.

```
CI_FAILURE, CMD(/sbin/clmount -o 'server_list=(cxfs2,cxfs0)'
/dev/xvm/stripe4 /xvm/stripe4): exited with status 1 (0x1)
```

You have tried to mount a filesystem without first running `mkfs`. You must use `mkfs` to construct the filesystem before mounting it. For more information, see the `mkfs(8)` man page.

```
CI_FAILURE, Could not write newincarnation number to CDB, error
= 9.
```

There was a problem accessing the cluster database. Retry the operation. If the error persists, stop and restart the cluster daemons; see "Stopping and Restarting Cluster Administration Daemons" on page 447.

If the problem persists, clear the database, reboot, and re-create the database. See "Clearing the Cluster Database" on page 444.

```
CI_FAILURE, Exiting, monitoring agent should revive me.
```

The daemon requires fresh data. It will be automatically restarted.

```
CI_FAILURE, No node for client (3) of filesystem (/dev/xvm/bob1)
on (/bob1).
```

(There may be many repetitions of this message.) The filesystem appears to still be mounted on a CXFS client node that is no longer in the cluster database. If you can identify the CXFS client node that used to be in the cluster and still has the filesystem mounted, reboot that node. Otherwise, reboot the entire cluster.

```
CI_FAILURE, No node for server (-1) of filesystem
(/dev/xvm/bob1) on (/bob1).
```

(There may be many repetitions of this message.) The filesystem appears to still be mounted on a server node that is no longer in the cluster database. If you can identify the server node that used to be

in the cluster and still has the filesystem mounted, reboot that node. Otherwise, reboot the entire cluster.

```
CI_FAILURE, Node cxfs0: SGI_CMS_HOST_ID(tcp,128.162.8 >9.33)
error 149 (Operation already in progress)
```

The kernel already had this information; you can ignore this message.

```
CI_FAILURE, Unregistered from crs.
```

The `clconfd` daemon is no longer connected to the reset daemon and will not be able to handle resets of failed nodes. There is no corrective action.

```
CI_IPCERR_NOSERVER, Crs_register failed,will retry later.
Resetting not possible yet.
```

The `clconfd` daemon cannot connect to the reset daemon. It will not be able to handle resets of failed nodes. Check the reset daemon's log file (`/var/cluster/ha/log/crsd_`) for more error messages.

```
CI_FAILURE, | > > SGI_CMS_CONFIG_ID_AUX_V2 error 22 (Invalid
argument)
CI_FAILURE, | > > clconfd_kernel_config_thread: failed to
update kernel config - retrying in 1 | > > second(s)
```

The previous configuration change has not fully propagated across the cluster and `clconfd` keeps trying until it succeeds. Possible causes include the following:

- The `cxfs_client` daemon is hung or is no longer running on one or more client-only nodes
- The `clconfd` daemon is hung or is no longer running on one or more server-capable administration nodes
- The cluster recovery is hung
- The local node is currently trying to join the cluster
- Other membership problems

If problems continue, you could try restarting cluster services.

Clconfd is out of membership, will restart after notifying clients.

The clconfd daemon does not have enough information about the current state of the cluster. It will exit and be automatically restarted with fresh data.

```
CMD(/sbin/clmount -o 'server_list=(cxfs2,cxfs0)'
/dev/xvm/stripe4 /xvm/stripe4): /dev/xvm/stripe4: Invalid
argument
```

You have tried to mount a filesystem without first running mkfs. You must use mkfs to construct the filesystem before mounting it. For more information, see the mkfs(8) man page.

```
CMD(/sbin/clmount -o 'server_list=(cxfs0,cxfs1)' /dev/xvm/bob2
/bob2): /dev/xvm/bob2: Invalid argumentSep 9 14:12:43 6X:cxfs0
clconfd[345]: < E clconf 3> CI_FAILURE, CMD(/sbin/clmount -o
'server_list=(cxfs0,cxfs1)' /dev/xvm/bob2 /bob2): exited with
status 1 (0x1)
```

The first message comes from the clmount command (the internal CXFS mount command) and explains the error (an invalid argument was issued). The second message says that the mount failed.

```
CI_FAILURE, clconfd_status_init: Failed to open status comm
module Wed Jan 2 15:06:40.128 EXITING.
```

This error message might indicate that there is a problem with CXFS multicast. You should also examine the fs2d log to see if a line such as the following specifies a valid multicast address for *IPaddress*:

```
fs2d - CIS config: multi:IPaddress:5449, delay=1s, incarnation=0x41cc5f0bcd1c235, flags=
```

If the address is not valid, there may be a problem with DNS or other name service. In this case, you must explicitly define the cluster\_mcast value to the normal CXFS multicast default value of 224.0.0.250 in the /etc/hosts file and ensure that etc/nsswitch.conf is configured so that files are read first. For more information, see "Verifying Connectivity in a Multicast Environment" on page 448.

CI\_CRFERR\_NOLCK, failed to lock switch for fencing update

The CXFS I/O fencing facility is unable to lock access to one or more Fibre Channel switches, perhaps due to defunct admin login processes. See "CXFS Cannot Access the Switch" on page 410.

CI\_FAILURE, CXFS filesystem (/dev/cxvm/tp95) on (/cxfs/tp95) already mounted with different options

A server-capable administration node was added to or deleted from the cluster while the filesystems for which it is a potential metadata server remained mounted, causing confusion. See "Unmount Filesystems Before Adding or Deleting Server-Capable Administration Nodes" on page 54.

### **crsd System Log File Error Messages**

The following errors are sent by the crsd daemon.

CI\_ERR\_NOTFOUND, No logging entries found for group crsd, no logging will take place - Database entry #global#logging#crsd not found.

No crsd logging definition was found in the cluster database. This can happen if you start cluster processes without creating the database. See "Recreating the Cluster Database" on page 448.

CI\_ERR\_RETRY, Could not find machine listing.

The crsd daemon could not find the local node in the cluster database. You can ignore this message if the local node definition has not yet been created.

CI\_ERR\_SYS:125, bind() failed.

The sgi-crsd port number in the /etc/services file is not unique, or there is no sgi-crsd entry in the file. For information about adding this entry, see "/etc/services on Server-Capable Administration Nodes" on page 130.

CI\_FAILURE, Entry for sgi-crsd is missing in /etc/services.

The sgi-crsd entry is missing from the /etc/services file. For information about adding this entry, see "/etc/services on Server-Capable Administration Nodes" on page 130.

CI\_FAILURE, Initialization failed, exiting.

A sequence of messages will be ended with this message; see the messages prior to this one in order to determine the cause of the failure.

CI\_ERR\_INTR, BMC is busy, delaying 5 seconds. Attempt 1 of 5.

The `crsd` daemon was unable to contact the baseboard management controller (BMC) of the system being reset. There will be 5 attempts to connect. You can ignore this message if the connection is successful upon a subsequent attempt. If the reset is not successful after all 5 attempts, see "IPMI Issues" on page 405.

CI\_CONFERR\_NOTFOUND, Error reading and storing port info.

CI\_CONFERR\_NOTFOUND, Initialization failed, exiting.

This error may indicate that the node that is responsible for resetting another node has not been defined in the cluster database. If you use the `reset` policy, you must define the owner node before starting CXFS. See "Define a Node with the GUI" on page 179 or "Create or Modify a Node with `cxfs_admin`" on page 242.

### **cmond System Log File Error Messages**

The following errors are sent by the `cmond` daemon.

Could not register for notification.cdb\_error = 7

An error number of 7 indicates that the cluster database was not initialized when the cluster process was started.

This may be caused if you execute the `cdbreinit` on one server-capable administration node while some other server-capable administration nodes in the pool are still running `fs2d` and already have the node listed in the database.

Do the following:

1. Execute the following command on the nodes that show the error:

```
errornode# /usr/cluster/bin/cdb-init-std-nodes
```

This command will recreate the missing nodes without disrupting the rest of the database.

2. If the error persists, force the daemons to restart by executing the following command on a server-capable administration node:

```
server-admin# service cxfs_cluster restart
```

Verify that `cmond` is restarted.

3. If the error persists, reinitialize the database on just the node that is having problems.

4. If the error still persists, reinitialize all nodes in the cluster.

See "Recreating the Cluster Database" on page 448.

```
Process clconfd:343 of group cluster_cx exited, status = 3.
```

The `clconfd` process exited with status 3, meaning that the process will not be restarted by `cmond`. No corrective action is needed.

```
Process crsd:1790 of group cluster_control exited, status = 127
```

The `crsd` process exited with an error (nonzero) status. Look at the corresponding daemon logs for error messages.

#### **cxfslicense System Log File Error Message**

The following message will be output by the `cxfslicense -d` command if you execute it before rebooting the system:

```
error reading kernel XVM cluster mirror status. Check if XVM module is started.
```

After you reboot the system and therefore load the XVM module, this message will no longer appear when you run `cxfslicense -d`.

### fs2d System Log File Error Messages

The following errors are sent by the fs2d daemon.

```
Error 9 writing CDB info attribute for node
#cluster#elaine#machines#cxfs2#Cellular#status
```

An internal error occurred when writing to the cluster database. Retry the operation. If the error persists, stop and restart the cluster daemons; see "Stopping and Restarting Cluster Administration Daemons" on page 447. If the problem persists, clear the database, reboot, and re-create the database. See "Clearing the Cluster Database" on page 444.

```
Error 9 writing CDB string value for node
#cluster#elaine#machines#cxfs2#Cellular#status
```

An internal error occurred when writing to the cluster database. Retry the operation. If the error persists, stop and restart the cluster daemons; see "Stopping and Restarting Cluster Administration Daemons" on page 447. If the problem persists, clear the database, reboot, and re-create the database. See "Clearing the Cluster Database" on page 444.

```
Failed to update CDB for node
#cluster#elaine#Cellular#FileSystems#fs1#FSStatus
```

An internal error occurred when writing to the cluster database. Retry the operation. If the error persists, stop and restart the cluster daemons; see "Stopping and Restarting Cluster Administration Daemons" on page 447. If the problem persists, clear the database, reboot, and re-create the database. See "Clearing the Cluster Database" on page 444.

```
Failed to update CDB for node
#cluster#elaine#machines#cxfs2#Cellular#status
```

An internal error occurred when writing to the cluster database. Retry the operation. If the error persists, stop and restart the cluster daemons; see "Stopping and Restarting Cluster Administration Daemons" on page 447. If the problem persists, clear the database, reboot, and re-create the database. See "Clearing the Cluster Database" on page 444.



Machine 101 machine\_sync failed with lock\_timeout error

The fs2d daemon was not able to synchronize the cluster database and the sync process timed out. This operation will be retried automatically by fs2d.

ALERT: CXFS Recovery: Cell 0: Server Cell 2 Died, Recovering

The server (cell 2) died and the system is now recovering a filesystem.

## Log File Error Messages

CXFS maintains logs for each of the CXFS daemons. For information about customizing these logs, see "Set Log Configuration with the GUI" on page 198.

Log file messages take the following form:

*daemon\_log timestamp internal\_process: message\_text*

For example:

cad\_log:Thu Sep 2 17:25:06.092 cclconf\_poll\_clconfd: clconf\_poll failed with error CI\_IPCERR\_NOPULSE

Table 15-3 on page 434, shows the parts in the preceding message.

**Table 15-3** Log File Error Message Format

Content	Part	Meaning
cad_log	Daemon identifier	The message pertains to the cad daemon
Sep 2 17:25:06.092	Time stamp and process ID	September 2 at 5:25 PM, process ID 92.
cclconf_poll_clconfd	Internal process information	Internal process information
clconf_poll failed with error CI_IPCERR_NOPULSE	Message text	The clconfd daemon could not be contacted to get an update on the cluster's status.

This section discusses the following:

- "cad Log File Error Messages" on page 434
- "cli Log File Error Messages" on page 436
- "crsd Log File Error Messages" on page 437
- "fs2d Log File Error Messages" on page 438

### cad Log File Error Messages

The following are examples of messages from `/var/cluster/ha/log/cad_log`:

```
ccacdb_cam_open: failed to open connection to CAM
server error 4
```

Internal message that can be ignored because the cad operation is automatically retried.

```
ccamail_cam_open: failed to open connection to CAM
server error 4
```

Internal message that can be ignored because the cad operation is automatically retried.

ccicdb\_cam\_open: failed to open connection to CAM  
server error 4

Internal message that can be ignored because the cad operation is automatically retried.

cclconf\_cam\_open: failed to open connection to CAM  
server error 4

Internal message that can be ignored because the cad operation is automatically retried.

cclconf\_poll\_clconfd: clconf\_poll failed with error  
CI\_IPCERR\_NOCONN

The clconfd daemon is not running or is not responding to external requests. If the error persists, stop and restart the cluster daemons; see "Stopping and Restarting Cluster Administration Daemons" on page 447.

cclconf\_poll\_clconfd: clconf\_poll failed with error  
CI\_IPCERR\_NOPULSE

The clconfd daemon could not be contacted to get an update on the cluster's status. If the error persists, stop and restart the cluster daemons; see "Stopping and Restarting Cluster Administration Daemons" on page 447.

cclconf\_poll\_clconfd: clconf\_poll failed with error  
CI\_CLCONFERR\_LONELY

The clconfd daemon does not have enough information to provide an accurate status of the cluster. It will automatically restart with fresh data and resume its service.

csrm\_cam\_open: failed to open connection to CAM server error 4

Internal message that can be ignored because the cad operation is automatically retried.

Could not execute notification cmd. system() failed. Error:  
No child processes

No mail message was sent because cad could not fork processes. Stop and restart the cluster daemons; see "Stopping and Restarting Cluster Administration Daemons" on page 447.

```
error 3 sending event notification to client [counter: 7 info:
0x000000021010f078]"
```

GUI process exited without cleaning up. (The counter and info numbers are internal data structures.)

### cli Log File Error Messages

The following are examples of messages from  
`/var/cluster/ha/log/cli_`*hostname*:

```
CI_CONFERR_NOTFOUND, No machines found in the CDB.
```

The local node is not defined in the cluster database.

```
CI_ERR_INVALID, Cluster (bob) not defined
```

The cluster called bob is not present in the cluster database.

```
CI_ERR_INVALID, CLI private command: failed (Cluster (bob) not
defined)
```

The cluster called bob is not present in the cluster database.

```
CI_IPCERR_NOPULSE, CLI private command: failed (Cluster state
is UNKNOWN.)
```

The cluster state could not be determined. Check if the `clconfd` daemon is running.

```
CI_IPCERR_NOPULSE, ipccInt_pulse_internal(): server failed to
pulse
```

The cluster state could not be determined. Check if the `clconfd` daemon is running.

```
CI_IPCERR_NOSEVER, clconf ipc: ipccInt_connect() failed, file
/var/cluster/ha/comm/clconfd-ipc_cxfs0
```

The local node (`cxfs0`) is not defined in the cluster database.

```
CI_IPCERR_NOSEVER, Connection file
/var/cluster/ha/comm/clconfd-ipc_cxfs0 not present.
```

The local node (cxfs0) is not defined in the cluster database.

### crsd Log File Error Messages

The following are examples of messages  
from `/var/cluster/ha/log/crsd_hostname`:

```
CI_CONFERR_INVALID, Nodeid -1 is invalid.
I_CONFERR_INVALID, Error from ci_security_init().
CI_ERR_SYS:125, bind() failed.
CI_ERR_SYS:125, Initialization failed, exiting.
CI_ERR_NOTFOUND, Nodeid does not have a value.
CI_CONFERR_INVALID, Nodeid -1 is invalid.
```

For each of these messages, either the node ID was not provided in the node definition or the cluster processes were not running in that node when the node definition was created in the cluster database. This is a warning that optional information is not available when expected.

```
CI_ERR_NOTFOUND, SystemController information for node cxfs2 not
found, requests will be ignored.
```

System controller information (optional information) was not provided for node cxfs2. Provide system controller information for node cxfs2 by modifying node definition. This is a warning that optional information is not available when expected. Without this information, the node will not be reset if it fails, which might prevent the cluster from properly recovering from the failure.

```
CI_ERR_NOTFOUND, SystemController information for node cxfs0 not
found, requests will be ignored.
```

The owner node specified in the node definition for node cxfs0 has not been defined. You must define the owner node.

```
CI_CRSEERR_NOTFOUND, Reset request 0x10087d48 received for node
101, but its owner node does not exist.
```

The owner node specified in the node definition for the node with a node ID of 101 has not been defined. You must define the owner

node. 0x10087d48 is a pointer to an internal datastructure that uniquely identifies the request while it is being handled.

### fs2d Log File Error Messages

The following are examples of messages from `/var/cluster/ha/log/fs2d_log`:

```
Failed to copy global CDB to node cxfs1 (1), error 4
```

There are communication problems between the local node and node `cxfs1`. Check the private networks of the two nodes.

```
Communication failure send new quorum to machine cxfs2 (102)
(error 6003)
```

There are communication problems between the local node and node `cxfs2`. Check the private networks of the two nodes.

```
Failed to copy CDB transaction to node cxfs2 (1)
```

There are communication problems between the local node and node `cxfs2`. Check the private networks of the two nodes.

```
Outgoing RPC to hostname : NULL
```

If you see this message, check your Remote Procedure Call (RPC) setup. For more information, see the `rpcinfo(8)` and `portmap(8)` man pages.

```
fs2d - RPC machine register: rejecting quorum from machine
hostname due to that machine not responding to our poll attempts
```

This message might indicate that the NIC for the private network has not been configured or has been configured incorrectly. It also might indicate that the cable has been unplugged.

### cdbreinit Error Messages

```
Thu Jun 3 16:20:45.431 cxfsopus1.example.com cbe_fs2 - cbe_create_node: cannot create new node (RPC error = 9)
libcdb - cdb_create_node: error 9 creating child of node 0x6000000000135c0 with subkey "ifd1"
```

This error means that some nodes have not been created in the cluster database. Error 9 usually means that `fs2d` has encountered an internal error while creating that

node. To fix the problem, make sure that `fs2d` is not running on any server-capable administration node and rerun `cdbreinit`.

## **cxfs\_admin Errors**

Following are common `cxfs_admin` errors.

```
Connecting to the local CXFS server...
receiving conflicting bootstrap packets from cluster(s) - cannot identify
server to connect to
gave up trying to connect to server
FATAL: exiting on fatal error
```

The `cxfs_admin` command can see multiple clusters. Reconfigure your network so that each cluster's private network subnet is independent of the private network subnet of other clusters. If you have multiple clusters connected to the same public network, use the `-i` option to identify the cluster name. See "Accessing the Correct Cluster at a Multiple-Cluster Site" on page 232.

```
Connecting to the CXFS server for the "mycluster" cluster...
Error returned from server: authorization error (8)
Inappropriate privileges to connect to the CXFS server
```

The host can see the cluster, but does not have permission to connect to it. Use `cxfs_admin` on another node that does have permission and use the `access` command to give permission to the first node.

```
Connecting to the CXFS server for the "mycluster" cluster...
Error returned from server: permissions error (9)
Insufficient privileges to acquire the administration lock
```

The host only has monitoring privileges and no administration privileges. Use the `permission=admin` attribute with the `access` command to grant the host administration rights, or use `-r` on the `cxfs_admin` command line.

```
Connecting to the CXFS server for the "mycluster" cluster...
not receiving bootstrap packets from any cluster - cannot identify server to connect to
gave up trying to connect to server
FATAL: exiting on fatal error
```

The host is not on the CXFS metadata private network and has not been granted explicit access to the cluster. Grant the host access by using the `access` command from a server-capable administration node or another host with `admin` access to the cluster.

## Mount Errors

The following error indicates that one of the LUNs in this volume is inaccessible. A GPT-labeled LUN in the volume may cause this if GPT labels are not supported on the system:

```
# /sbin/mount -t cxfs -o 'client_timeout=30s,retry=0,server_list=(server1,server2)' \  
/dev/cxvm/stripe93 /mnt/stripe93  
cxfs.util get_subvol_stripe: open(/dev/rcxvm/stripe93) returned -1, errno 19 (Operation not supported by device)  
cxfs.util get_subvol_stripe: Some of the volumes needed for /dev/rcxvm/stripe93 may have a main path that  
    runs through a controller to which this machine is not connected.  
cxfs.util set_xfs_args: get_subvol_stripe failed  
cxfs.util mount_main: set_xfs_args failed
```

## Authorization Errors

If a node is not allowed to be configured automatically by the `cxfs_admin` command, errors such as the following will appear in the `cxfs_client` log:

```
Aug 06 10:36:51 cxfs_client: cis_cdb_go ERROR: Error returned from server: authorization  
error (8)  
Aug 06 10:36:51 cxfs_client: cis_autoconf client is not in an autoconf "allowed" policy
```

For more information about automatic configuration, see "Automatically Configure a Client-Only Node" on page 239.

The `cxfs_admin` command will also display errors if the node running `cxfs_admin` does not have `admin` or `monitor` access to the cluster. See "Setting `cxfs_admin` Access Permissions" on page 230.

## Connection Error

The following message indicates that the system is unable to open UDP socket connection to another system (in this case, cell ID 4) because the connection attempt is refused:



```
mesg_connect:cell 4:channel 0:transport 2:connect error -111
```

Frequently repeated occurrences of this message may indicate an incorrect network configuration or may require reinstalling the CXFS software on either the CXFS client-only node or the server-capable administration node. This message may also occur occasionally when a node is started or shut down.

### **node is downrev Error**

All server-capable administration nodes in the cluster must run the same version of CXFS except during a rolling upgrade. The following types of errors indicate that the server-capable administration nodes are running different versions of CXFS software:

```
CXFS cell C (name) mount refused: node is downrev (tag X, has N, need M)
```

```
CXFS cell C (name) relocation refused: node is downrev (tag X, has N, need M)
```

```
Cell C (nodename) is downrev and will not be able to connect
```

An operation may be forbidden because of a version mismatch between the metadata server and the other node involved. The following operations may fail:

- An attempt by a client-only node running a newer version (such as CXFS 5.5) to mount a filesystem served by a metadata server running an older version (such as CXFS 5.4)
- An attempt to relocate a filesystem to between nodes with different versions (for example, from a CXFS 5.4 metadata server to a CXFS 5.5 server-capable administration node)

For example, the following message indicates that a client-only node tried to mount a filesystem served by a metadata server that is running an older version of CXFS:

```
CXFS cell 0 (xo-xe1) mount refused: node is downrev (tag 30, has -1, need 0)
```

In another example, the following message that appears on a client-only node (with a cell ID of 5) indicates that server-capable administration node `cxfsxe6` (with a cell ID of 9) is running an older CXFS release:

```
Cell 9 (cxfsxe6) is downrev and will not be able to connect
```

In this case, the following message will also appear at 1-second intervals on `cxfsxe6`:

```
mesg_connect:cell 5:channel 0:transport 2:connect error -111
```

This combination of messages indicates that the client-only node is running a version of CXFS from ISSP 2.x and `cxfsxe6` is a server-capable administration node running a later version of CXFS from ISSP 1.x, which is an unsupported configuration.

During a rolling upgrade, relocation of a filesystem between server-capable administration nodes running different versions of CXFS may be disabled. Recovery rather than relocation is used to move filesystems to an upgraded server-capable node. See "CXFS Release Versions and Rolling Upgrades" on page 283.

## EXTENT Errors

If you see messages like the following on the console or in the system log file, turn off CXFS extents deltas:

```
EXTENT: a8000002c9e60600 bno 10 not at boundary (got = 9+5)
```

This is best done on the metadata server by setting the `fs.cxfs.cxfs_extents_delta` system tunable parameter to 0. A reboot is not required. For more information, see "`cxfs_extents_delta`" on page 484.

## GRIOV2 Errors

If you see errors like the following, it means that the server-capable administration node was not rebooted after installing GRIOV2:

```
# /usr/sbin/grioadmin -sv
print_streams: error: Cannot get GRIO server info: Resource temporarily unavailable
grioadmin: print_streams: error: grio_get_streams: Resource temporarily unavailable
```

## Corrective Actions

This section covers the following corrective actions:

- "Restarting CXFS Services" on page 443
- "Clearing the Cluster Database" on page 444
- "Rebooting" on page 445
- "Rebooting without Rejoining the Cluster" on page 445

- "Recovering a Cluster with Two Server-Capable Administration Nodes" on page 446
- "Stopping and Restarting Cluster Administration Daemons" on page 447
- "Recreating the Cluster Database" on page 448
- "Verifying Connectivity in a Multicast Environment" on page 448
- "Power-Cycling a Node" on page 450
- "Resetting a Node" on page 450

## Restarting CXFS Services

If CXFS services do not restart after a reboot, it may be that the node was marked as `INACTIVE` in the cluster database using the **Stop CXFS Services** function of the GUI or a `disable node: nodename` function of `cxfs_admin`. In this case, issuing a `service cxfs_cluster start` or `service cxfs start` will not restart the services.

You must manually start CXFS services. If you use the GUI to restart the services, or enable with `cxfs_admin`, the configuration will be set so that future reboots will also restart CXFS services.

For information, see:

- "Start CXFS Services with the GUI" on page 197
- "Enable a Node with `cxfs_admin`" on page 251

## Clearing the Cluster Database

To clear the cluster database on all of the server-capable administration nodes, do the following, completing each step on each server-capable administration node before moving to the next step:



---

**Caution:** This procedure deletes all configuration information.

---

1. Enter the following on all server-capable administration nodes:

```
server-admin# service cxfs stop
```

2. Enter the following on all server-capable administration nodes:

```
server-admin# service cxfs_cluster stop
```



---

**Caution:** Complete steps 1 and 2 on each node before moving to step 3 for any node.

---

3. Enter the following on all server-capable administration nodes:

```
server-admin# /usr/cluster/bin/cdbreinit
```

See also "Reboot Before Changing Node ID or Cluster ID" on page 79.

4. Enter the following on all server-capable administration nodes:

```
server-admin# service cxfs_cluster start
```

5. Enter the following on all server-capable administration nodes:

```
server-admin# service cxfs start
```

See "Eliminate a Residual Cluster" on page 389 to get rid of possible stale cluster configuration in the kernel. If needed, reboot the nodes.

## Rebooting

The following are situations that may require rebooting:

- If some CXFS clients are unable to unmount a filesystem because of a busy vnode and a reset of the node does not fix the problem, you may need to reboot every node in the cluster
- If there is no recovery activity within 10 minutes, you may need to reboot the node

Enter the following individually on every node to reboot the cluster (other than Windows, which uses a different reboot mechanism):

```
# reboot
```

If you want CXFS services to restart whenever the node is rebooted, use the CXFS GUI to start CXFS services or `cxfs_admin` to enable the node. For information, see:

- "Start CXFS Services with the GUI" on page 197
- "Enable a Node with `cxfs_admin`" on page 251

For information about client-only nodes, see the *CXFS 6 Client-Only Guide for SGI InfiniteStorage*.

## Rebooting without Rejoining the Cluster

The `cxfs_cluster` argument to `chkconfig` controls the other cluster administration daemons and the replicated cluster database. If turned off, the database daemons will not be started at the next reboot and the local copy of the database will not be updated if you make changes to the cluster configuration on the other nodes. This could cause problems later, especially if a majority of nodes are not running the database daemons.

If the cluster daemons are causing serious trouble and prevent the machine from booting, you can recover the node by booting in single-user mode, turning the argument off and booting in multiuser mode.

For example:

```
ELILO boot: linux single
Uncompressing Linux... done
...
Skipped services in runlevel S:                splash
Give root password for login: *****

(none)# /sbin/chkconfig grio2 off (if running GRIOv2)
(none)# /sbin/chkconfig cxfs off
(none)# /sbin/chkconfig cxfs_cluster off
(none)# reboot
```

For more information, see "chkconfig Arguments" on page 296.

## Recovering a Cluster with Two Server-Capable Administration Nodes

There are specific issues with recovering a cluster with two server-capable administration nodes. Suppose the following sequence of events:

1. You have cluster named `clusterA` that has two server-capable administration nodes, any number of client-only nodes, and no CXFS tiebreaker:
  - `node1`
  - `node2`
2. `node1` goes down and will remain down for a while.
3. `node2` recovers and `clusterA` remains up.

---

**Note:** An existing cluster can drop down to 50% of the remaining server-capable administration nodes **after** the initial CXFS kernel membership is formed.

---

4. `node2` goes down and therefore `clusterA` fails.
5. `node2` comes back up. However, `clusterA` cannot form because the initialization of a cluster requires either:
  - **More than 50%** of the server-capable administration nodes
  - 50% of the server-capable administration nodes, **one of which is the CXFS tiebreaker**

To allow `node2` to form a cluster by itself, you must do the following:

1. Set `node2` to be the CXFS tiebreaker node, using the GUI or `cxfs_admin`. See:
  - "Set Tiebreaker Node with the GUI" on page 198
  - "Create a Cluster with `cxfs_admin`" on page 258
2. Revoke the CXFS kernel membership of `node2`. See:
  - "Revoke Membership of the Local Node with the GUI" on page 201
  - "Disable a Node with `cxfs_admin`" on page 251
3. Allow CXFS kernel membership of `node2`. See:
  - "Allow Membership of the Local Node with the GUI" on page 201
  - "Enable a Node with `cxfs_admin`" on page 251
4. Unset the CXFS tiebreaker node capability. See:
  - "Set Tiebreaker Node with the GUI" on page 198
  - "Create or Modify a Node with `cxfs_admin`" on page 242



**Caution:** All two-server-capable administration node clusters without a tiebreaker set must have fencing or reset configured. SGI recommends reset.

---

The cluster will attempt to communicate with the `node1` because it is still configured in the cluster, even though it is down. Therefore, it may take some time for the CXFS kernel membership to form and for filesystems to mount.

## Stopping and Restarting Cluster Administration Daemons

---



**Caution:** When the cluster administration daemons are stopped, the node will not receive database updates and will not update the kernel configuration. This can have very unpleasant side effects. Under most circumstances, the administration daemons should remain running at all times. Use these commands only as directed.

---

The commands to stop and restart cluster administration daemons depend upon the platform.

To stop and restart cluster administration daemons, enter the following:

- On server-capable administration nodes:

```
server-admin# service cxfs_cluster stop
server-admin# service cxfs_cluster start
```

- On client-only nodes:

```
client# killall cxfs_client
client# service cxfs_client start
```

You could also use the `restart` option to stop and start.

These commands affect the cluster administration daemons only.

See also "Restarting CXFS Services" on page 443. For general information about the daemons, see "Kernel Threads" on page 453.

## Recreating the Cluster Database

See Chapter 13, "Cluster Database Management" on page 349. If a node will not join cluster membership, you must reboot it.

## Verifying Connectivity in a Multicast Environment

Before multicast connectivity can be verified in the cluster, you must enable multicast ping on each node in the cluster. To enable multicast ping on a server-capable administration node, use one of the following methods (the permanent method will not take affect until after a reboot):

- Immediate but temporary method:

```
server-admin# echo "0" > /proc/sys/net/ipv4/icmp_echo_ignore_broadcasts
```

For more information, see <http://kerneltrap.org/node/16225>

- Immediate but temporary method:

```
server-admin# sysctl -w net.ipv4.icmp_echo_ignore_broadcasts=0"
```



- Permanent method upon reboot (survives across reboots):

1. Remove the following line (if it exists) from the `/etc/sysctl.conf` file:

```
net.ipv4.icmp_echo_ignore_broadcasts = 1
```

2. Add the following line to the `/etc/sysctl.conf` file:

```
net.ipv4.icmp_echo_ignore_broadcasts = 0
```

To verify general connectivity in a multicast environment, you can execute a `ping` command on the `224.0.0.1` IP address; `224.0.0.1` is the address for all systems on this subnet multicast.

To verify the CXFS kernel heartbeat, use the `224.0.0.250` IP address. (SGI uses `224.0.0.250` by default; you may need to explicitly set this if you are having problems with name resolution involving `cluster_mcast`, see below).

---

**Note:** A node is capable of responding only when the administration daemons (`fs2d`, `comond`, `cad`, and `crsd`) or the `cxfs_client` daemon is running.

---

For example, to see the response for two packets sent from IP address `163.154.17.49` to the multicast address for CXFS kernel heartbeat and ignore loopback, enter the following:

```
nodeA# ping -c 2 -I 163.154.17.49 -L 224.0.0.250
PING 224.0.0.250 (224.0.0.250): 56 data bytes
64 bytes from 163.154.17.140: icmp_seq=0 ttl=64 time=1.146 ms
64 bytes from 163.154.17.55: icmp_seq=0 DUP! ttl=255 time=1.460 ms
64 bytes from 163.154.17.52: icmp_seq=0 DUP! ttl=255 time=4.607 ms
64 bytes from 163.154.17.50: icmp_seq=0 DUP! ttl=255 time=4.942 ms
64 bytes from 163.154.17.140: icmp_seq=1 ttl=64 time=2.692 ms

---224.0.0.250 PING Statistics---
2 packets transmitted, 2 packets received, +3 duplicates, 0.0% packet
loss
round-trip min/avg/max = 1.146/2.969/4.942 ms
```

The above output indicates that there is a response from the following addresses:

```
163.154.17.140
163.154.17.55
163.154.17.52
163.154.17.50
```

To override the default address, you can use the `-c` and `-m` options on client-only nodes; for more information, see the `cxfs_client` man page.

To override or explicitly set the CXFS multicast address, do the following:

1. Set `cluster_mcast` to an IP address in the range 224.0.0.0 through 239.255.255.255 in the `/etc/hosts` file and make it resolvable on all nodes in the cluster. If you want to use DNS or another name service, you should avoid using a registered number. For a list of registered numbers, see:

<http://www.iana.org/assignments/multicast-addresses>

2. Verify that the `/etc/nsswitch.conf` file is configured so that local files are accessed before either NIS or DNS. That is, the `hosts` line in `/etc/nsswitch.conf` must list files first. For example:

```
hosts:      files nis dns
```

For more information, see "Adding a Private Network" on page 118.

## Power-Cycling a Node

To power-cycle a node, see "Control and Contact a Node with `cxfs_admin`" on page 255.

## Resetting a Node

To reset a node, see "Control and Contact a Node with `cxfs_admin`" on page 255.

## Using SGI Knowledgebase

If you encounter problems and have an SGI support contract, you can log on to Supportfolio and access the Knowledgebase tool to help find answers.

To log in to Supportfolio Online, see:

<https://support.sgi.com/login>

Then click on **Search the SGI Knowledgebase** and select the type of search you want to perform.

If you need further assistance, contact SGI Support.

## Reporting Problems to SGI

Before reporting a problem to SGI, you should retain the information by using the `cxfsdump` utility. See "Gather Cluster Configuration with `cxfsdump`" on page 387.

Also do the following:

- Retain any messages that appeared in the system logs immediately before the system exhibited the problem.
- After a system kernel panic, retain the debugger information from the KDB built-in kernel debugger. See "System Dump Analysis Tool (SLES 11 on x86-64)" on page 383.
- When a CXFS daemon or command aborts and creates core files, provide the core files and the following associated information:

- The application that created the core file:

```
file core_filename
```

- The binaries listed by the following command:

```
ldd application_path
```



## CXFS Software Architecture

This appendix discusses the following for administration nodes:

- "Kernel Threads" on page 453
- "Communication Paths" on page 455
- "Flow of Metadata for Reads and Writes" on page 459

Also see the following:

- "Cluster Administration Daemons" on page 43
- "CXFS Control Daemons" on page 44
- *CXFS 6 Client-Only Guide for SGI InfiniteStorage*

### Kernel Threads

Table A-1 on page 454, discusses kernel threads. CXFS shares with XFS the Linux `xfsbuofd` and `xfsdatabd` kernel threads to push buffered writes to disk.

---

**Note:** In the `ps` command output, the thread names begin with a `*` character, such as [`*mtcp_notify`]).

---

**Table A-1** Kernel Threads

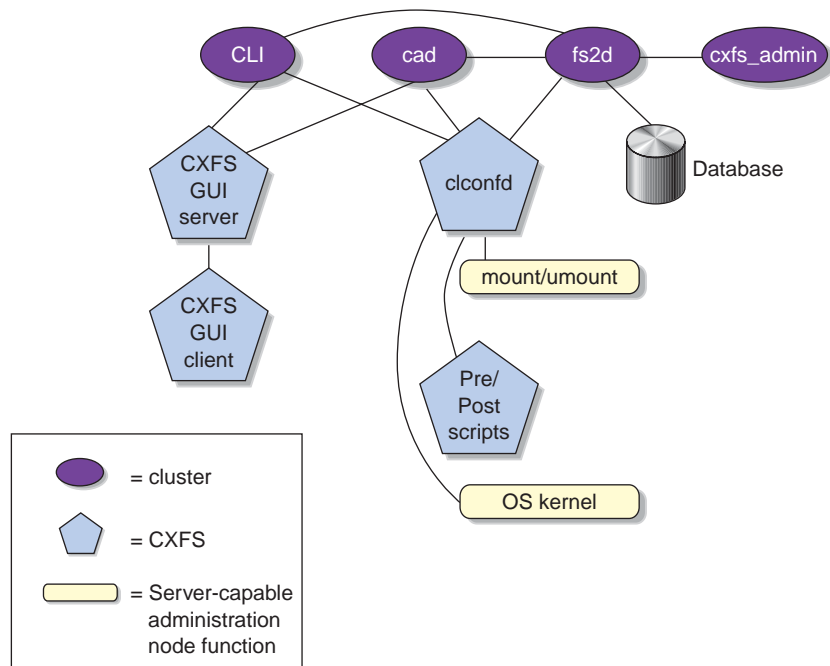
Kernel Thread	Software Product	Description
cmsd	sgi-cxfs-server-kmp	Manages CXFS kernel membership and CXFS kernel heartbeating.
Recovery	sgi-cxfs-server-kmp	Manages recovery protocol for node.
corpse leader	sgi-cxfs-server-kmp	Coordinates recovery between nodes.
dcshake	sgi-cxfs-server-kmp	Purges idle CXFS vnodes on the CXFS client.
cxfsd	sgi-cxfs-server-kmp	Manages sending extent and size updates from the client to the server. This daemon (which runs on the CXFS client) takes modified inodes on the client and ships back any size and unwritten extent changes to the server.
mtcp_recv	sgi-cxfs-server-kmp	Reads messages (one per open message channel).
mtcp_notify	sgi-cxfs-server-kmp	Accepts new connections.
mtcp_discovery	sgi-cxfs-server-kmp	Monitors and discovers other nodes.
mtcp_xmit	sgi-cxfs-server-kmp	Supplies CXFS kernel heartbeat.

The `fs2d`, `clconfd`, and `crsd` daemons run at real-time priority. However, the `mount` and `umount` commands and scripts executed by `clconfd` are run at normal, time-shared priority.

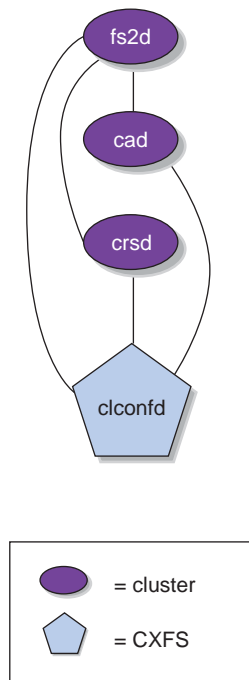
## Communication Paths

The following figures show communication paths in CXFS.

**Note:** The following figures do not represent the `cmond` cluster manager daemon. The purpose of this daemon is to keep the other daemons running.

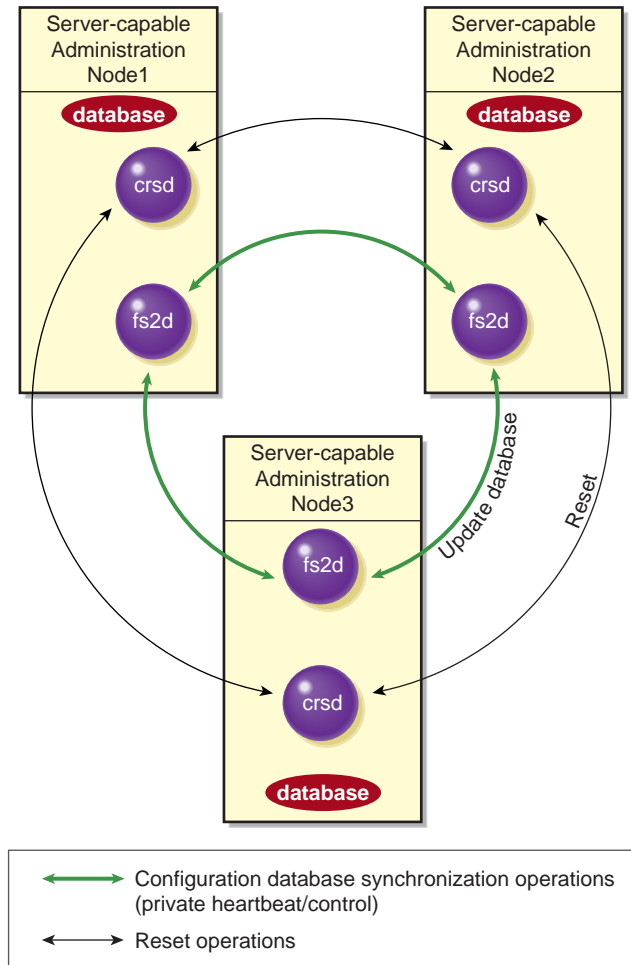


**Figure A-1** Communication Within One Server-Capable Administration Node

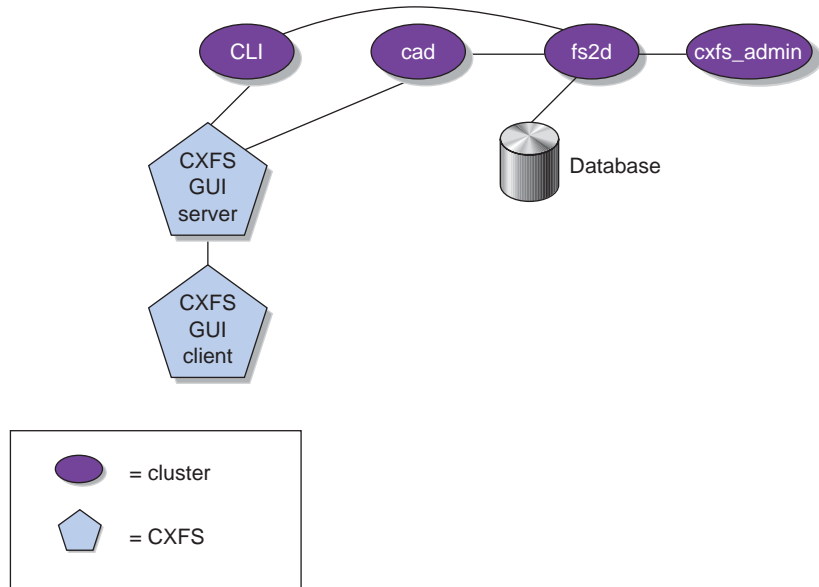


**Figure A-2** Daemon Communication Within One Server-Capable Administration Node





**Figure A-3** Communication Among Nodes in the Pool



**Figure A-4** Communication for a Server-Capable Administration Node Not in a Cluster

One of the server-capable administration nodes running the `fs2d` daemon is chosen to periodically multicasts its IP address and the generation number of the cluster database to each of the client-only nodes. Each time the database is changed, a new generation number is formed and multicast. Figure A-5 describes the communication among nodes, showing just a single client-only node as an example.

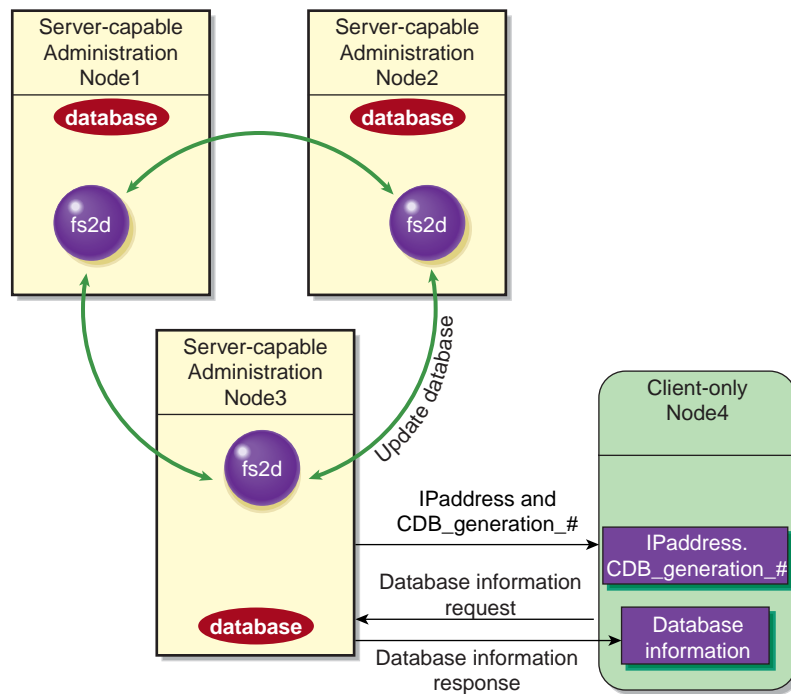


Figure A-5 Communication Among Nodes

## Flow of Metadata for Reads and Writes

The following figures show examples of metadata flow.

---

**Note:** A token protects a file. There can be multiple read tokens for a file at any given time, but only one write token.

---

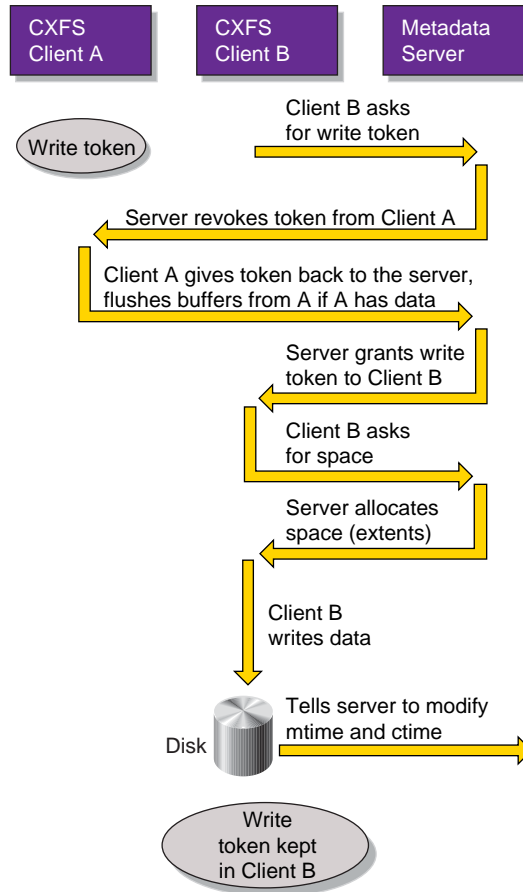
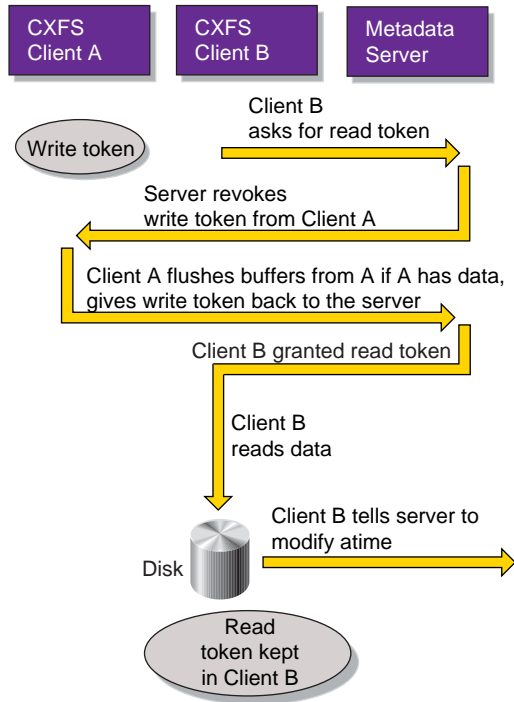
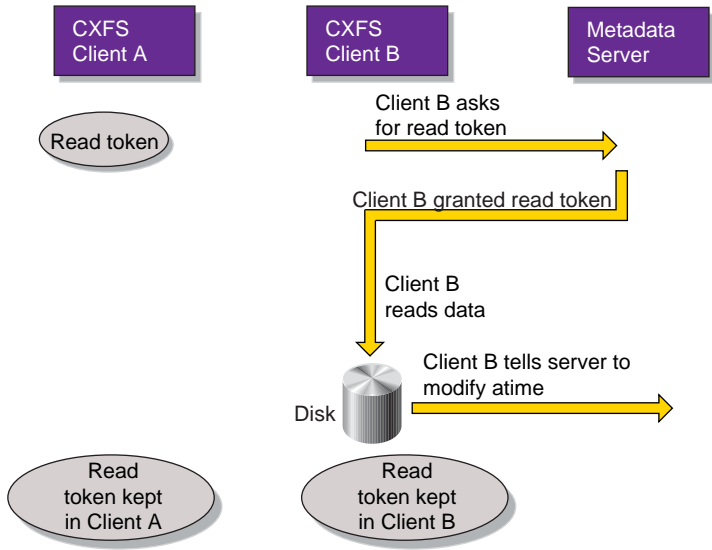


Figure A-6 Metadata Flow on a Write



**Figure A-7** Metadata Flow on a Read on Client B Following a Write on Client A



**Figure A-8** Metadata Flow on a Read on Client B Following a Read on Client A

---

## Path Summary

This appendix lists the locations for commonly used commands on server-capable administration nodes.

**Table B-1** Paths for Server-Capable Administration Nodes

Command/File	Path
<code>cdbreinit</code>	<code>/usr/cluster/bin/cdbreinit</code>
<code>chkconfig</code>	<code>/bin/chkconfig</code>
<code>cxfs_admin</code>	<code>/usr/cluster/bin/cxfs_admin</code>
<code>df</code>	<code>/bin/df</code>
<code>grioadmin</code>	<code>/usr/sbin/grioadmin</code>
<code>griomon</code>	<code>/usr/sbin/griomon</code>
<code>griogps</code>	<code>/usr/sbin/griogps</code>
<code>hinv</code>	<code>/usr/bin/hinv</code>
<code>hostname</code>	<code>/bin/hostname</code>
<code>mount</code>	<code>/bin/mount</code>
<code>netstat</code>	<code>/bin/netstat</code>
<code>ping</code>	<code>/bin/ping</code>
<code>ps</code>	<code>/bin/ps</code>
<code>xvm</code>	<code>/sbin/xvm</code>
Cluster daemon configuration files	<code>/etc/cluster/config/</code>
System log	<code>/var/log/messages</code>
CXFS configuration information	<code>/usr/cluster/bin/clconf_info</code>
CXFS/cluster daemon initialization	<code>/etc/init.d/cxfs_cluster</code>
CXFS license verification command:	<code>/usr/cluster/bin/cxfslicense</code>





## System Reset Configuration

This appendix discusses system controllers that can be used in CXFS system reset configurations:

- "BMC System Controller" on page 465
- "L2 System Controller" on page 472

---

**Note:** Configurations that use TTY ports require that you purchase serial cables.

---

### BMC System Controller

The BMC must not be on the primary CXFS private network. Ideally, the BMC should be on a different private network that is reachable by all server-capable administration nodes in the cluster. A public network is not ideal for security reasons, but is acceptable.

Altix XE systems contain an integrated BMC. CXFS uses Intelligent Platform Management Interface (IPMI) to communicate with the BMC.

To use the BMC, you must create an `admin` user ID and assign the BMC a static IP address. This can be done using `ipmitool(1)` on the system containing the BMC. Do the following:

1. Verify that you have `ipmitool(1)` version 1.8.9 or later:

```
# ipmitool -v
ipmitool version 1.8.9
```

2. Load the following IPMI modules:

```
# modprobe ipmi_msghandler
# modprobe ipmi_devintf
# modprobe ipmi_si
```

3. Create a user named `admin` with a password and `ADMINISTRATOR` privileges:

- a. Find the next available user ID:

```
# ipmitool -d /dev/ipmi0 user list 1/2
```

b. Assign the user name admin to the next available user ID:

```
# ipmitool -d /dev/ipmi0 user set name userID admin
```

c. Set the password for user admin:

```
# ipmitool -d /dev/ipmi0 user set password userID admin_password
```

d. Enable the access modes and set the privilege level to ADMINISTRATOR:

```
# ipmitool -d /dev/ipmi0 channel setaccess 1/2 userID callin=on ipmi=on link=on privilege=4
```

---

**Note:** You must apply the privilege change separately for channel 1 and for channel 2.

---

e. Verify that the correct settings were applied:

```
# ipmitool -d /dev/ipmi0 user list 1/2
# ipmitool -d /dev/ipmi0 channel getaccess 1/2 userID
```

For example (line breaks shown here for readability):

```
# ipmitool -d /dev/ipmi0 user list 1
ID Name          Callin Link Auth  IPMI Msg  Channel Priv Limit
1                true  false   true      ADMINISTRATOR

# ipmitool -d /dev/ipmi0 user list 2
ID Name          Callin Link Auth  IPMI Msg  Channel Priv Limit
1                true  false   true      ADMINISTRATOR

# ipmitool -d /dev/ipmi0 user set name 2 admin
# ipmitool -d /dev/ipmi0 user set password 2 password
# ipmitool -d /dev/ipmi0 channel setaccess 1 2 callin=on \
ipmi=on link=on privilege=4
[root@linux root]# ipmitool -d /dev/ipmi0 channel setaccess 2 2 callin=on \
ipmi=on link=on privilege=4

# ipmitool -d /dev/ipmi0 user list 1
ID Name          Callin Link Auth  IPMI Msg  Channel Priv Limit
1                true  false   true      ADMINISTRATOR
2  admin          true  true    true      ADMINISTRATOR

# ipmitool -d /dev/ipmi0 user list 2
```

ID	Name	Callin	Link Auth	IPMI Msg	Channel Priv Limit
1		true	false	true	ADMINISTRATOR
2	admin	true	true	true	ADMINISTRATOR

```
# ipmitool -d /dev/ipmi0 channel getaccess 1 2
```

```
Maximum User IDs      : 15
Enabled User IDs      : 2
User ID               : 2
User Name             : admin
Fixed Name            : No
Access Available      : call-in / callback
Link Authentication   : enabled
IPMI Messaging        : enabled
Privilege Level       : ADMINISTRATOR
```

```
# ipmitool -d /dev/ipmi0 channel getaccess 2 2
```

```
Maximum User IDs      : 15
Enabled User IDs      : 2
User ID               : 2
User Name             : admin
Fixed Name            : No
Access Available      : call-in / callback
Link Authentication   : enabled
IPMI Messaging        : enabled
Privilege Level       : ADMINISTRATOR
```

4. Apply the following local area network (LAN) settings for the BMC on the Altix XE system, for which the IPMI device is `/dev/ipmi0`. The BMC LAN settings apply to LAN channels 1 and 2.

---

**Note:** You must apply each change separately for channel 1 and for channel 2.

---

- Set the IP Address (use the same IP address for both channels):

```
# ipmitool -d /dev/ipmi0 lan set 1/2 ipaddr IP_address
```

- Set the subnet mask (use the same value for both channels):

```
# ipmitool -d /dev/ipmi0 lan set 1/2 netmask netmask
```

- Enable address resolution protocol (ARP) responses:  
`# ipmitool -d /dev/ipmi0 lan set 1/2 arp respond on`
- Enable *gratuitous ARP*, which broadcasts the MAC address to IP address mappings on a specified interface:  
`# ipmitool -d /dev/ipmi0 lan set 1/2 arp generate on`
- Set the gratuitous ARP interval (in seconds):

---

**Note:** An interval of 5 seconds is supported for CXFS.

---

```
# ipmitool -d /dev/ipmi0 lan set 1/2 arp interval 5
```

For example:

```
# ipmitool -d /dev/ipmi0 lan set 1 ipaddr nodename-bmc.company.com
Setting LAN IP Address to nodename-bmc.company.com
# ipmitool -d /dev/ipmi0 lan set 2 ipaddr nodename-bmc.company.com
Setting LAN IP Address to nodename-bmc.company.com
# ipmitool -d /dev/ipmi0 lan set 1 netmask 255.255.0.0
Setting LAN Subnet Mask to 255.255.0.0
# ipmitool -d /dev/ipmi0 lan set 2 netmask 255.255.0.0
Setting LAN Subnet Mask to 255.255.0.0
# ipmitool -d /dev/ipmi0 lan set 1 arp respond on
Enabling BMC-generated ARP responses
# ipmitool -d /dev/ipmi0 lan set 2 arp respond on
Enabling BMC-generated ARP responses
# ipmitool -d /dev/ipmi0 lan set 1 arp generate on
Enabling BMC-generated Gratuitous ARPs
# ipmitool -d /dev/ipmi0 lan set 2 arp generate on
Enabling BMC-generated Gratuitous ARPs
# ipmitool -d /dev/ipmi0 lan set 1 arp interval 5
BMC-generated Gratuitous ARP interval: 5.0 seconds
# ipmitool -d /dev/ipmi0 lan set 2 arp interval 5
BMC-generated Gratuitous ARP interval: 5.0 seconds
```

5. Verify your changes by using the following command:

```
# ipmitool -d /dev/ipmi0 lan print 1/2
```

For example:

```
# ipmitool -d /dev/ipmi0 lan print 1
Set in Progress      : Set Complete
Auth Type Support    : NONE MD5 PASSWORD
Auth Type Enable     : Callback :
                    : User      :
                    : Operator  :
                    : Admin    : MD5 PASSWORD
                    : OEM      :
IP Address Source    : Static Address
IP Address           : nodename-bmc.company.com
Subnet Mask          : 255.255.0.0
MAC Address          : 00:04:23:d5:af:3c
SNMP Community String :
IP Header            : TTL=0x40 Flags=0x40 Precedence=0x00 TOS=0x10
```

## C: System Reset Configuration

---

```
BMC ARP Control      : ARP Responses Enabled, Gratuitous ARP Enabled
Gratuitous ARP Intrvl : 5.0 seconds
Default Gateway IP   : 0.0.0.0
Default Gateway MAC  : 00:00:00:00:00:00
Backup Gateway IP    : 0.0.0.0
Backup Gateway MAC   : 00:00:00:00:00:00
RMCP+ Cipher Suites  : 0,1,2,3,4,5,6,7,8,9,10,11,12,13,14
Cipher Suite Priv Max : XXXXXXXXXXXXXXXX
                    : X=Cipher Suite Unused
                    : c=CALLBACK
                    : u=USER
                    : o=OPERATOR
                    : a=ADMIN
                    : O=OEM
```

6. Verify the BMC configuration and connectivity from a remote node by issuing `ipmitool(1)` commands remotely:

```
# ping IP_address_or_hostname
# ipmitool -H IP_address_or_hostname -U admin -P admin_passwd lan print 1/2
```

For example (line breaks shown here for readability):

```
# ping nodename-bmc.company.com

# ipmitool -H nodename-bmc.company.com -U admin \
-P mypassword lan print 1
Set in Progress      : Set Complete
Auth Type Support    : NONE MD5 PASSWORD
Auth Type Enable     : Callback :
                    : User      :
                    : Operator  :
                    : Admin    : MD5 PASSWORD
                    : OEM      :

IP Address Source    : Static Address
IP Address           : nodename-bmc.company.com
Subnet Mask          : 255.255.0.0
MAC Address          : 00:04:23:d5:af:3c
SNMP Community String :
IP Header            : TTL=0x40 Flags=0x40 Precedence=0x00 TOS=0x10
BMC ARP Control      : ARP Responses Enabled, Gratuitous ARP Enabled
Gratuitous ARP Intrvl : 5.0 seconds
```

```
Default Gateway IP      : 0.0.0.0
Default Gateway MAC    : 00:00:00:00:00:00
Backup Gateway IP      : 0.0.0.0
Backup Gateway MAC     : 00:00:00:00:00:00
RMCP+ Cipher Suites    : 0,1,2,3,4,5,6,7,8,9,10,11,12,13,14
Cipher Suite Priv Max  : XXXXXXXXXXXXXXXX
                        :   X=Cipher Suite Unused
                        :   c=CALLBACK
                        :   u=USER
                        :   o=OPERATOR
                        :   a=ADMIN
                        :   O=OEM
```

For more information, see:

- `ipmitool(1)` man page
- *Guide to Programming Environments and Tools Available on SGI Altix XE System*
- The user guide or quick start guide for your system

## L2 System Controller

The L2 system controller and the required USB cables are optional equipment available for purchase.

---

**Note:** You should use a separate L2 for each node to avoid unnecessary reboots.

You can use network reset if you have an L2 on a network. For details, see the information about `reset_comms` in "Create or Modify a Node with `cxfs_admin`" on page 242.

---

The L2 controller must not be on the primary CXFS private network. Ideally, the L2 controller should be on a different private network and must be reachable by all server-capable administration nodes in the cluster. A public network is not ideal for security reasons, but is acceptable. The number of network connections allowed depends upon the L2 version; contact your SGI support person for assistance.

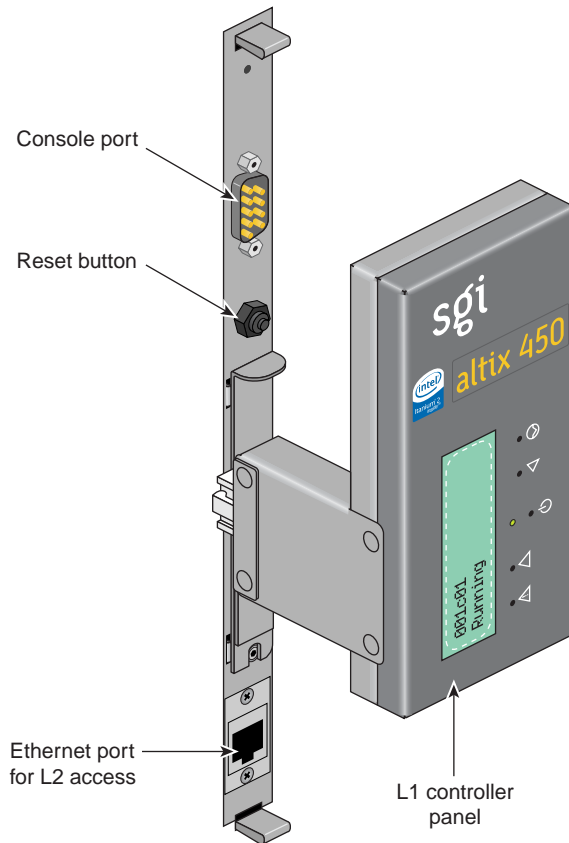
Altix systems with an integrated L2 (such as a NUMALink 4 R-brick), Altix 3000 Bx2 systems, Altix 450 systems and Altix 4700 systems use the L2 over Ethernet. See Figure C-2.

In Altix 350, use IO10 and a *multiport serial adapter cable*, which is a device that provides four DB9 serial ports from a 36-pin connector; see Figure C-3.

Use the modem port on the L2 system controller as shown in Figure C-4. Use DB9 serial ports on an IX-brick on Altix 3000. Connect the serial cable to the modem port on one end and the serial port on the IX-brick (for example, serial port connector 0), as shown in Figure C-5.

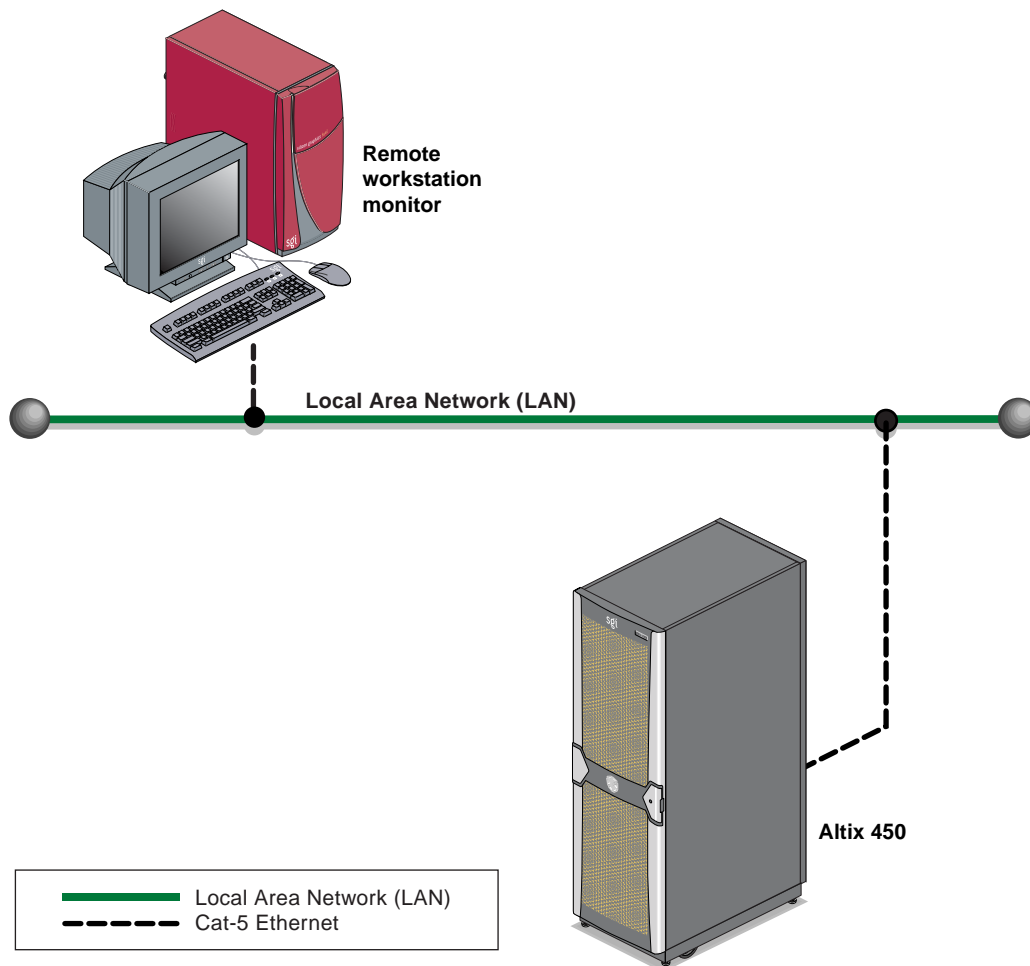
Figure C-1 shows the L2 access via the Ethernet port on an A450.



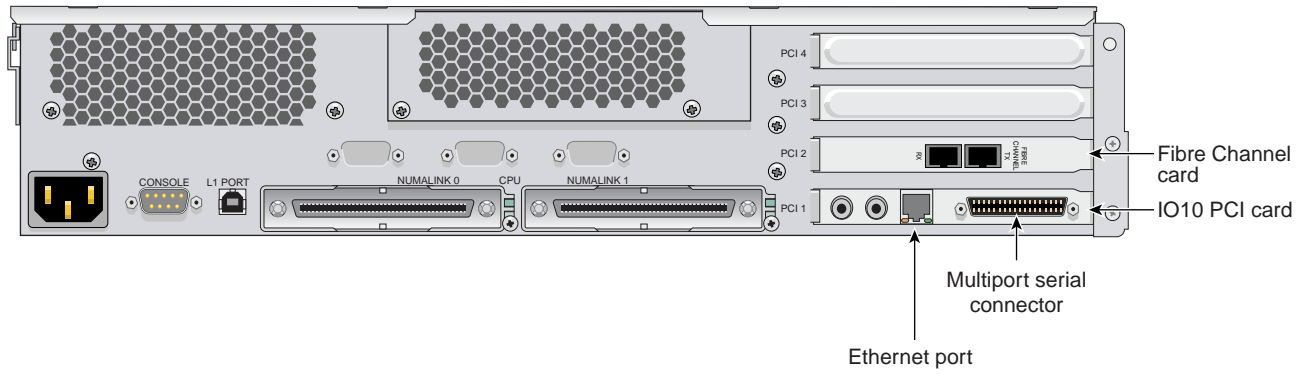


**Figure C-1** L2 Access via the Ethernet Port on an A450

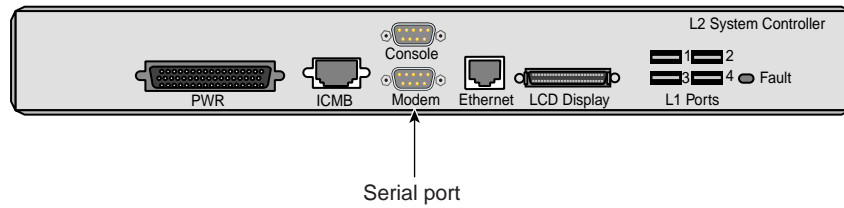
Figure C-6 shows connections for two machines with an L2 system controller. (This figure shows direct attached storage. Connections for other storage configurations will be the same.)



**Figure C-2** SGI Altix 450 System Control Network



**Figure C-3** Altix 350 Rear Panel



**Figure C-4** L2 Rear Panel

C: System Reset Configuration

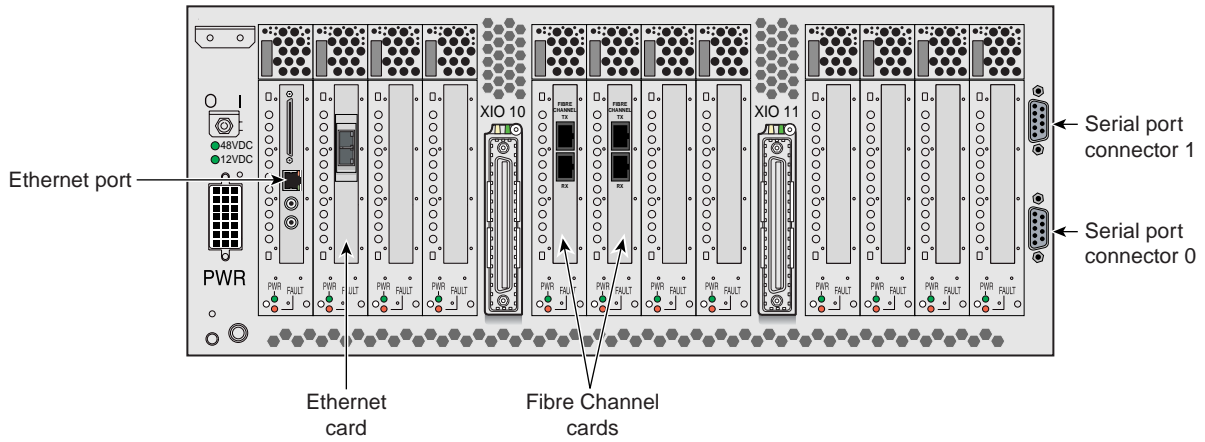


Figure C-5 IX-brick Rear Panel

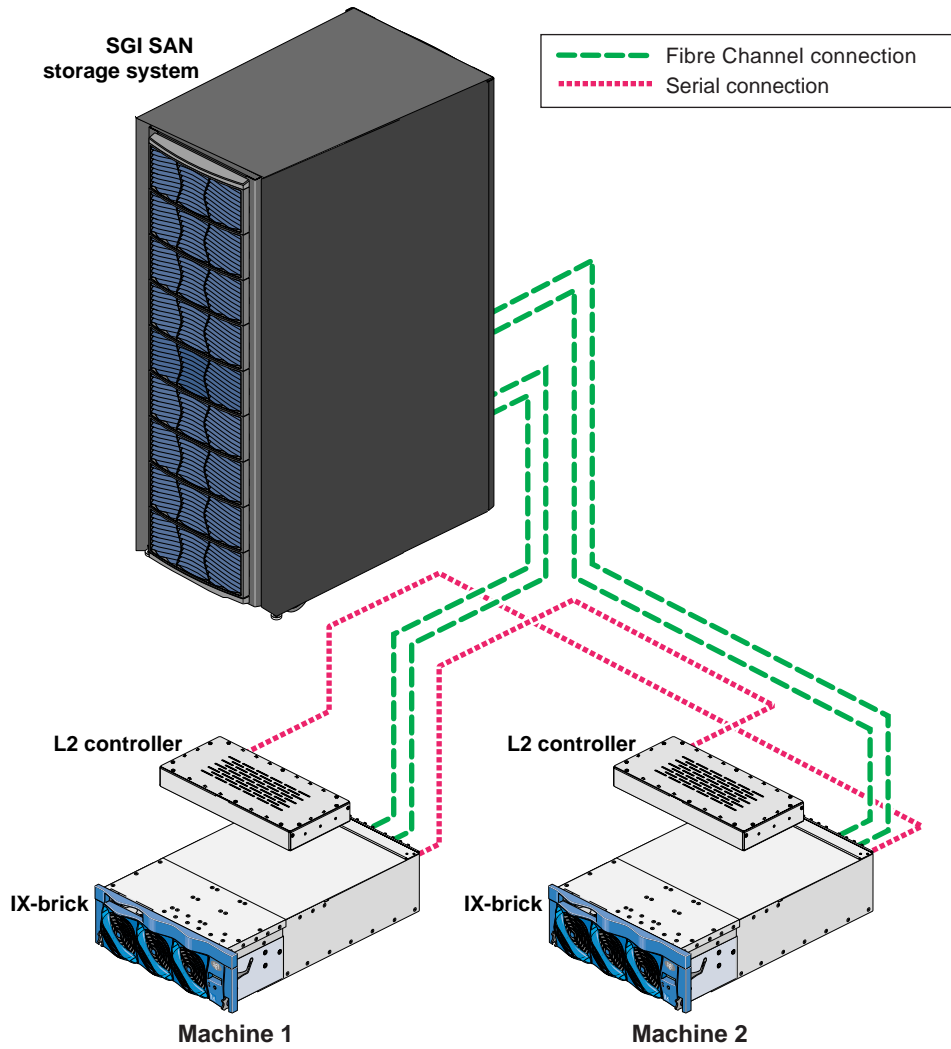


Figure C-6 Altix 3000 Connections



## System Tunable Parameters

This appendix discusses the following:

- "Static Parameters that are Site-Configurable" on page 480
- "Dynamic Parameters that are Site-Configurable" on page 483
- "Dynamic Parameters for Debugging Purposes Only" on page 487

SGI recommends that you use the same settings on all applicable nodes in the cluster.

---

**Note:** Before changing any parameter, you should understand the ramifications of doing so on your system. Contact your SGI support person for guidance.

---

To manipulate these parameters on a running system, you can use the Linux `sysctl` command. For more information, see the `sysctl(8)` man page.

Linux organizes the tunables in a hierarchy, therefore you must specify the entire "path" to the tunable. The first part of that path is given under the "Location" entry in the following sections. For example, the full path to the tunable `cxfsd_sync_force` is `fs.cxfs.cxfsd_sync_force`.

Example of a query using `sysctl`:

```
server-admin# sysctl fs.cxfs.cxfsd_sync_force
fs.cxfs.cxfsd_sync_force = 8372224
```

Example of setting a value using `sysctl`:

```
server-admin# sysctl fs.cxfs.cxfsd_sync_force=0
fs.cxfs.cxfsd_sync_force = 0
```

---

**Note:** There cannot be spaces around the = character when setting a value.

---

See also "Set System Tunable Parameters Appropriately" on page 83.

## Static Parameters that are Site-Configurable

Static parameters require a reboot to take affect. On any of the Linux flavors supported in this CXFS release, you must specify the parameter in `/etc/modprobe.conf.local`.

### `mtcp_hb_local_options`

Specifies how CXFS kernel heartbeat is generated for a Linux node. You should only change this value at the recommendation of SGI support.

Range of values:

- `0x0` uses the standard heartbeat generation routine (default).
- `0x1` uses the interrupt timer list instead of a kernel thread.
- `0x3` uses a heartbeat generation routine that avoids some memory allocation problems that may occur on nodes with large CPU counts that run massively parallel jobs.

Location: `kernel.cell` (`sgi-cell` module)

### `mtcp_hb_period`

Specifies (in hundredths of a second) the length of time that CXFS waits for CXFS kernel heartbeat from other nodes before declaring node failure. SGI recommends a value of 500 (5 seconds). You should only change this value at the recommendation of SGI support. The same value must be used on all nodes in the cluster.

Range of values:

- Default: 500
- Minimum: 100
- Maximum: 12000



---

**Note:** If your cluster includes large Altix systems (greater than 64 processors) , you may want to use a larger value, such as 6000 (60 seconds) or 12000 (120 seconds). However, the larger the timeout, the longer it takes the cluster to recognize a failed node and start recovery of the shared resources granted to that node. See "Avoid CXFS Kernel Heartbeat Issues on Large SGI Altix Systems" on page 66.

---

Location: `kernel.cell` (`sgi-cell` module)

### `mtcp_hb_watchdog`

Controls the behavior of the CXFS kernel heartbeat monitor watchdog. This facility monitors the generation of heartbeats in the kernel.

Range of values:

- 0 specifies that there is no use of watchdog (default)
- 1 specifies that watchdog expiration causes CXFS shutdown
- 2 specifies that watchdog expiration causes panic

Location: `kernel.cell` (`sgi-cell` module)

### `mtcp_nodelay`

Specifies whether to enable or disable `TCP_NODELAY` on CXFS message channels.

Range of values:

- 0 disables
- 1 enables (default)

Location: `kernel.cell` (`sgi-cell` module)

### `mtcp_rpc_thread`

Specifies whether metadata messages are sent from a separate thread in order to save stack space.

Range of values:

- 0 disables (default for most nodes)
- 1 enables

Location: `kernel.cell` (`sgi-cell` module)

### `rheltd_max`

Specifies the maximum number of `rheltd` threads to run. The `rheltd` threads help out recovery and relocation tasks. They are used for asynchronous inode reconstruction, parallel recoveries, and so on. The `rheltd` thread pool is global in nature and gets created during module load time.

Range of values:

- Default: 0, which specifies an automatically calculated value that will be 4 times the number of CPUs, as long as it is in the range 0 through 128. To disable automatic `rheltd_max` calculation, set `rheltd_max` to a non-zero value.
- Minimum: 0
- Maximum: 128

Location: `fs.cxfs` (`sgi-cxfs` module)

### `rheltd_min`

Specifies the minimum number of `rheltd` threads to run.

Range of values:

- Default: 0, which specifies an automatically calculated value that is 4 times the number of CPUs or 128, whichever is smaller. To disable automatic `rhelpd_min` calculation, set `rhelpd_min` to a non-zero value. When the value is set explicitly, the maximum is 8.
- Minimum: 0
- Maximum: 8

Location: `fs.cxfs` (`sgi-cxfs` module)

## Dynamic Parameters that are Site-Configurable

Dynamic parameters take affect as soon as they are changed.

### `cms_local_fail_action`

Specifies the action to take when a local node detects that it has failed:

Range of values:

- 0 withdraws from the cluster (default)
- 1 halts
- 2 reboots

Location: `kernel.cell` (`sgi-cell` module)

### `cxfs_client_push_period`

Specifies (in hundredths of a second) how long that a client may delay telling the metadata server that it has updated the `atime` timestamp of a file. The default for both `cxfs_client_push_period` and `cxfs_server_push_period` is 1/4 of a second, so `atime` updates are delayed by up to 1/2 second by default. See also "`cxfs_server_push_period`" on page 485.

Range of values:

- Default: 25

- **Minimum:** 0
- **Maximum:** 1000

Location: `fs.cxfs` (`sgi-cxfs` module)

### **`cxfs_dcvn_timeout`**

Specifies the time-out (in seconds) of the `dcvn` idle period before returning tokens to the server.

Range of values:

- **Default:** 60
- **Minimum:** 5
- **Maximum:** 3600

Location: `fs.cxfs` (`sgi-cxfs` module)

### **`cxfs_extents_delta`**

Specifies whether or not to optimize the way extent lists are sent across the private network by sending a delta when possible.

Range of values:

- 0 does not optimize
- 1 optimizes (default)

Location: `fs.cxfs` (`sgi-cxfs` module)

### **`cxfs_punch_hole_restrict`**

Specifies whether or not to allow exported files to have their extents freed by DMAPi via `dm_punch_hole()`.

Range of values:

- 0 allows extents to be freed (default)

- 1 does not allow extents to be freed

Location: `fs.cxfs` (`sgi-cxfs` module)

### `cxfs_relocation_ok`

Specifies whether relocation is disabled or enabled (must be specified on the active metadata server):

Range of values:

- 0 disables relocation (default)
- 1 enables relocation

---

**Note:** Relocation is disabled by default and is only supported on standby nodes. See:

- "Node Types, Node Functions, and the Cluster Database" on page 13
  - "Relocation" on page 26
- 

Location: `fs.cxfs` (`sgi-cxfs` module)

### `cxfs_server_push_period`

Specifies (in hundredths of a second) how long that a metadata server may delay broadcasting to the clients that it has updated the `atime` timestamp. The default for both `cxfs_client_push_period` and `cxfs_server_push_period` is 1/4 of a second, so `atime` updates are delayed by up to 1/2 second by default. See also "`cxfs_client_push_period`" on page 483.

Range of values:

- Default: 25
- Minimum: 0
- Maximum: 1000

Location: `fs.cxfs` (`sgi-cxfs` module)

### `cxfsd_max`

Specifies the maximum number of `cxfsd` threads to run per CXFS filesystem. (The `cxfsd` threads do the disk block allocation for delayed allocation buffers in CXFS and the flushing of buffered data for files that are being removed from the local cache by the metadata server.) The threads are allocated at filesystem mount time. The value of the `cxfsd_max` parameter at mount time remains in effect for a filesystem until it is unmounted.

Range of values:

- **Default:** 0, which specifies the value of `cxfsd_min + 2`. (The value for `cxfsd_max` is always at least `cxfsd_min + 2`, even if that forces the kernel to increase the value beyond 2048.) To disable automatic `cxfsd_max` calculation, set `cxfsd_max` to a non-zero value.
- **Minimum:** 16
- **Maximum:** 2048

---

**Note:** The value for `cxfsd_max` cannot be less than the value specified for `cxfsd_min`.

---

Location: `fs.cxfs` (`sgi-cxfs` module)

### `cxfsd_min`

Specifies the minimum number of `cxfsd` threads to run per CXFS filesystem. The value of the `cxfsd_min` parameter at mount time remains in effect for a filesystem until it is unmounted.

Range of values:

- **Default:** 0, which specifies an automatically calculated value that will be 2 times the number of CPUs (the number of actual running `cxfsd` threads is dynamic), as long as it is in the range 16 through 2048. To disable automatic `cxfsd_min` calculation, set `cxfsd_min` to a non-zero value.
- **Minimum:** 16
- **Maximum:** 2048

Location: `fs.cxfs` (`sgi-cxfs` module)

**mtcp\_mesg\_validate**

Enables checksumming. Normally, this is not needed and is only used if TCP data corruption is suspected.

Range of values:

- 0 performs no validation (default)
- 1 generates checksums, but does not perform validation
- 2 generates and validates checksums, warns (via a SYSLOG message) on validation failure
- 3 generates and validates checksums, warns and returns an error message on validation failure
- 4 generates and validates checksums, warns and panics on validation error

Location: `kernel.cell` (`sgi-cell` module)

## Dynamic Parameters for Debugging Purposes Only

---



**Caution:** These parameters are provided for debugging purposes. You should only reset these parameters if advised to do so by SGI support.

---

**cxfs\_client\_range\_age\_max**

Specifies the maximum age of a granted range, measured in generations, before a client will voluntarily return it.

Range of values:

- Default: 10
- Minimum: 0
- Maximum: 1000

Location: `kernel.cell` (`sgi-cell` module)

See also "`cxfs_server_range_age_max`" on page 489.

### **cxfs\_recovery\_slowdown**

Slows down recovery by inserting delays (measured in ms).

Range of values:

- Default: 0
- Minimum: 0
- Maximum: 60000

Location: `kernel.cell` (`sgi-cell` module)

### **cxfs\_recovery\_timeout\_panic**

Specifies the action taken when a node with stalled recovery is discovered.

Range of values:

- 0 shuts down a node with stalled recovery (default)
- 1 panics a node with stalled recovery

Location: `kernel.cell` (`sgi-cell` module)

### **cxfs\_recovery\_timeout\_period**

Specifies the time in seconds between recovery time-out polls.

Range of values:

- Default: 60
- Minimum: 0 (disables recovery polls)
- Maximum: 3600

Location: `kernel.cell` (`sgi-cell` module)



**cxfs\_recovery\_timeout\_stalled**

Specifies the time in seconds after which a node whose status is not changing is considered to have a stalled recovery.

Range of values:

- Default: 600
- Minimum: 0 (disables time-out)
- Maximum: 3600

Location: `kernel.cell` (`sgi-cell` module)

**cxfs\_recovery\_timeout\_start**

Specifies the time in seconds following a recovery before the recovery time-out monitoring begins.

Range of values:

- Default: 60
- Minimum: 0
- Maximum: 3600

Location: `kernel.cell` (`sgi-cell` module)

**cxfs\_server\_range\_age\_max**

Specifies the maximum age of a granted range, measured in generations, before the server will recall it.

Range of values:

- Default: 10
- Minimum: 0
- Maximum: 1000

Location: `kernel.cell` (`sgi-cell` module)

See also "cxfs\_client\_range\_age\_max" on page 487.

## Migration from `cmgr` to `cxfs_admin`

The `cmgr` command is no longer supported. If you have scripts that use `cmgr`, you should do the following to use `cxfs_admin`:

1. Do one of the following:
  - Run the `cmgr` script and build the cluster configuration from scratch
  - Start with the cluster database in the desired configuration
2. Run the `cxfs_admin config` command to generate a `cxfs_admin` script. This script should be the `cxfs_admin` equivalent of the `cmgr` script. See "Saving and Recreating the Current Configuration with `cxfs_admin`" on page 279.
3. Modify the script generated in step 2 so that the server-capable administration node on which `cxfs_admin` will be run to generate the cluster is the first node created in the script. (By default, the `cxfs_admin config` command output lists nodes in alphabetical order by node name without regard to node type.) This script can then be used to regenerate the cluster later. See "Saving and Recreating the Current Configuration with `cxfs_admin`" on page 279.

---

**Note:** The `bash` shell interprets `cmgr`-generated scripts, but `cxfs_admin` interprets `cxfs_admin`-generated scripts.

---

For more information about `cmgr`, see "Appendix F. Reference to `cmgr` Tasks" in *CXFS 5 Administration Guide for SGI InfiniteStorage* (007-4016-030) posted on the SGI Technical Publications Library:

[http://techpubs.sgi.com/library/manuals/4000/007-4016-030/sgi\\_html/apf.html](http://techpubs.sgi.com/library/manuals/4000/007-4016-030/sgi_html/apf.html)



## Migration from a Cluster with IRIX Server-Capable Administration Nodes

The information in this appendix will help you migrate from a cluster with IRIX server-capable administration nodes to a cluster with SGI Foundation Software for Linux server-capable administration nodes. It discusses the following:

- "Differences Between IRIX and Linux System Administration" on page 493
- "Caveats for Migrating from IRIX" on page 494
- "Migration Procedure" on page 497
- "Migration Troubleshooting" on page 501

You must ensure that you have the correct network configuration for the new Linux server-capable administration nodes; see Chapter 6, "Preinstallation Steps" on page 117. For assistance, contact SGI Managed Services.

### Differences Between IRIX and Linux System Administration

If you are migrating from a cluster with IRIX metadata servers to a cluster with SGI Foundation Software metadata servers, you should understand the differences between IRIX and Linux system administration. The details of these differences are beyond the scope of this guide, but a brief overview includes:

- Installation tools
- Mount options
- Paths
- Location of kernel system-tunable parameters

For more information, see the operating system documentation.

See also:

- "Limitations and Considerations for Server-Capable Administration Nodes" on page 123
- Chapter 12, "Administration and Maintenance" on page 281
- Appendix B, "Path Summary" on page 463

## Caveats for Migrating from IRIX

This section discusses the following:

- "Changing SGIRDAC Mode to SGI AVT Mode for SGI RAID" on page 494
- "Recreating Filesystems with the Appropriate Naming Version" on page 495
- "Recreating Filesystems with Large Block Sizes" on page 497
- "Using Project Quotas" on page 497

## Changing SGIRDAC Mode to SGI AVT Mode for SGI RAID

CXFS does not support SGIRDAC mode. To convert from SGIRDAC to SGI AVT, do the following:

1. Install the latest supported firmware on the RAID.
2. Determine the IP address for one of the controllers on each RAID box.
3. Make a script `settype.scr` that contains the following line:

```
set storageArray defaultHostType="modename";
```

---

**Note:** The capitalization and punctuation in the above line are required.

---

To switch to SGI AVT mode, use the following line:

```
set storageArray defaultHostType="SGIAVT";
```

For the InfiniteStorage 220, use the CLI client to set the host type to SGI AVT:

```
smicli -w SA_WWID -c 'set storageArray defaultHostType="SGIAVT";'
```

To determine the value for *SA\_WWID*, invoke the following:

```
smicli -d -w
```

For example:

```
# smicli -d -w
unit1 600a0b80002459d40000000045003fbc      localhost
      |---> SA_WWID
```

4. Run the following for one of the controllers per RAID box:

```
/opt/tpssm/client/tpssmcli RAID_IPaddress -f settype.scr
```

For example:

```
# /opt/tpssm/client/tpssmcli 192.168.0.1 -f settype.scr
Performing syntax check...

Syntax check complete.

Executing script...

Script execution complete.

tpssmcli completed successfully.
```

## Recreating Filesystems with the Appropriate Naming Version

Linux does not support version-1 naming on filesystems. You must examine the parameters for each filesystem by using the following command on the active metadata server for each filesystem:

```
xfs_growfs -n mountpoint
```

For example, the following shows that the `/stripe1` filesystem has version-2 naming:

```

irixMDS# xfs_growfs -n /stripe1
meta-data=/stripe1      isize=256      agcount=16, agsize=1663360 blks
                =                sectsz=512     attr=0, parent=0
data        =                bsize=4096    blocks=26611968, imaxpct=25
                =                sunit=128     swidth=768 blks, unwritten=1
                =                mmr=0
naming      =version 2     bsize=4096    mixed-case=Y
log         =internal     bsize=4096    blocks=13056 version=1
                =                sectsz=512     sunit=0 blks lazy-count=0
realtime    =none         extsz=4096    blocks=0, rtextents=0
    
```

If you have a filesystem that displays version-1 naming, you must recreate it on a Linux server-capable administration node so that it will have version-2 naming. Do the following:

1. Dump the filesystem data to backup media by using the `xfsdump(1M)` command.




---

**Warning:** If this step is not performed, all data currently on the filesystems will become inaccessible and will be permanently lost.

---

2. Unmount the CXFS filesystems clusterwide by using the `cxfs_admin` command.
3. Recreate the filesystem by using the `mkfs.xfs(8)` command on a Linux server-capable administration node. Preserve any nondefault filesystem parameters by specifying the applicable options to the `mkfs.xfs` command.
4. Restore the filesystem data from backup media by using the `xfsrestore(8)` command.

For more information, see the man pages for the above commands and the following:

- *IRIX Admin: Disks and Filesystems*
- *XFS for Linux Administration*



## Recreating Filesystems with Large Block Sizes

The maximum block size on Linux nodes varies by architecture:

- For SGI Altix ia64 server-capable administration nodes, the maximum block size is 16K.
- For SGI Altix XE x86-64 server-capable administration nodes, the maximum block size is 4K.

If you have filesystems with larger block sizes than the above, you must recreate them by performing a dump and a restore, changing the block size so that it does not exceed the maximum for the architecture of your systems.

---

**Note:** SGI recommends a block size of 4K for CXFS filesystems in a multiOS cluster because this is the only block size that is supported on all CXFS hardware platforms.

---

## Using Project Quotas

Under Linux, project quotas are applied to the files below a given directory. You can view the project quotas only from the active CXFS metadata server, not from CXFS client-only nodes. See "Quotas Differences" on page 33.

## Migration Procedure

---

**Note:** The following procedure assumes that the filesystems in the cluster you want to migrate do not have block sizes greater than the system page size and that they are not real-time filesystems. These types of filesystems are supported on IRIX but not on SGI Foundation Software.

---

Following is a procedure for using `cxfs_admin` to migrate from a cluster with IRIX server-capable administration nodes to a cluster with SGI Foundation Software for Linux server-capable administration nodes. For details about using `cxfs_admin`, see Chapter 11, "cxfs\_admin Command" on page 223.

---

**Note:** The cluster cannot be used for production work during this process.

---

For information about using the GUI to perform similar tasks, see Chapter 10, "CXFS GUI" on page 157.

1. As a precaution, save the current cluster database contents by using the `build_cmgr_script` command.
2. Ensure you have CXFS 6.0 and XVM 6.0 licenses installed on the Linux server-capable administration nodes. See:
  - "Upgrading Licenses" on page 284
  - Chapter 5, "CXFS Licensing" on page 103
3. From an IRIX server-capable administration node:
  - a. Unmount the CXFS filesystems clusterwide by using the `cxfs_admin` command. For example, to unmount the CXFS V9500 filesystem clusterwide:

```
cxfs_admin:mycluster> unmount V9500
```

- b. Use the IRIX `mount` and `umount` commands to mount and unmount the filesystems locally, which will ensure that the XFS log plays back cleanly. For example, mount and unmount the V9500 filesystem locally:

```
irixadmin# mount /dev/cxvm/V9500 /mnt
irixadmin# umount /mnt
```

- c. Disable each IRIX server-capable administration node by using the `cxfs_admin` command. For example, to disable the node named `irixnode1`:

```
cxfs_admin:mycluster> disable irixnode1
```

Repeat the `disable` command for each IRIX server-capable administration node.

- d. Create a Linux server-capable administration node in the cluster. This will allow the cluster database information to be transferred to the Linux nodes.

---

**Note:** This migration situation is the only time that mixed OS server-capable administration nodes are allowed in the same cluster.

---

For example (line breaks here for readability):

```
cxfs_admin:mycluster> create node name=linuxnode1 type=server_admin os=linux private_net=10.0.10.1
enabled=true hostname=linuxnode1.domain.com
```

4. From the Linux server-capable administration node created in step d above, do the following:

- a. Delete each IRIX server-capable administration node by using the `cxfs_admin` command. For example, to delete the node named `irixnode1`:

```
cxfs_admin:mycluster> delete irixnode1
```

Repeat the `delete` command for each IRIX server-capable administration node.

- b. Create any additional Linux server-capable administration nodes in the cluster. For example, to create a node named `linuxnode2`:

```
cxfs_admin:mycluster> create node name=linuxnode2 type=server_admin os=linux private_net=10.0.10.2
```

Repeat the `create` command for each Linux server-capable administration node.

- c. Modify the CXFS filesystems to assign the new Linux server-capable administration nodes as potential metadata servers. For example:

```
cxfs_admin:mycluster> modify filesystem name=V9500 servers=linuxnode1,linuxnode2
```

- d. Mount the CXFS filesystems by using the `cxfs_admin` command. For example, to mount the `V9500` filesystem:

```
cxfs_admin:mycluster> mount V9500
```

- e. Check cluster configuration:

```
cxfs_admin:mycluster> status
```

You could also use the `cxfs-config` command to verify the status.

5. Dispose of the former IRIX server-capable administration nodes properly:
  - a. Stop CXFS processes on each IRIX server-capable administration node:

```
irixadmin# /etc/init.d/grio2 stop (if running GRIOV2)
irixadmin# /etc/init.d/cxfs stop
irixadmin# /etc/init.d/cluster stop
```

Repeat these commands on each IRIX server-capable administration node.

- b. Do one of the following:
      - Transform the nodes into IRIX client-only nodes and add them to the cluster. Execute the `stop` commands above and follow the procedure in "Transforming a Server-Capable Administration Node into a Client-Only Node" on page 297.
      - Remove the IRIX server-capable administration nodes physically from the network.

For more information about using the GUI, see the following:

- "Unmount CXFS Filesystems with the GUI" on page 215
- "Stop CXFS Services with the GUI" on page 197
- "Define a Node with the GUI" on page 179
- "Add or Remove Nodes in the Cluster with the GUI" on page 188
- "Modify a CXFS Filesystem with the GUI" on page 213
- "Add or Remove Nodes in the Cluster with the GUI" on page 188
- "Delete a Node with the GUI" on page 192
- "Start CXFS Services with the GUI" on page 197
- "Mount CXFS Filesystems with the GUI" on page 214

## Migration Troubleshooting

The following sections discuss possible problems you may encounter after migrating from an IRIX cluster to an SGI Foundation Software cluster:

- "Filesystems Will Not Mount" on page 501
- "DMF Filesystems Will Not Mount" on page 501
- "Do Not Use `extlog` or `rtfs` Filesystems" on page 502

### Filesystems Will Not Mount

Messages such as the following indicate that the filesystem was not cleanly unmounted from the IRIX metadata server:

```
Jan 29 22:06:07 4A:cxfs2 kernel: XFS: nil uuid in log - IRIX style log
Jan 29 22:06:07 5A:cxfs2 kernel: Starting XFS recovery on filesystem:
xvm-0 (dev: xvm-0)
Jan 29 22:06:07 4A:cxfs2 kernel: XFS: dirty log written in incompatible
format - can't recover
```

To resolve this problem, you must return to the IRIX node and then mount and unmount the filesystem locally on the IRIX node in order to replay the dirty log messages (as in step 3b in "Migration Procedure" on page 497).



**Caution:** Do not steal the XVM volumes to the local host. Mounting `/dev/cxvm/volname` locally on `/mnt` is sufficient.

---

### DMF Filesystems Will Not Mount

If you have DMF filesystems and have `dmi` as a mount option, you must edit the `/etc/sysconfig/sysctlfile` to turn on DMAPi probing in order to mount CXFS filesystems. Change the bottom line from:

```
DMAPI_PROBE="no"
```

to:

```
DMAPI_PROBE="yes"
```

**Do Not Use `extlog` or `rtfs` Filesystems**

If you have SGI Foundation Software server-capable administration nodes, you cannot use `extlog` or `rtfs` filesystems.

---

## Filesystem Specifications

The following table lists filesystem specifications for Linux running on a server-capable administration node.

Item	Description
Maximum filesystem size	$2^{64}$ bytes
Maximum files size/offset	$2^{63}-1$ bytes
Filesystem block size (in bytes) <sup>1</sup>	512, 1024, 2048, 4096, 8192, or 16384
XVM device block size (in bytes)	512
Physical LUN limit for DVH-labeled disks	2 TB
Physical LUN limit for GPT-labeled disks <sup>2</sup>	$2^{63}$ device blocks
Maximum concatenated slices	65536

---

<sup>1</sup> If the filesystem is to be accessible by other platforms in a multiOS cluster, its block size must be supported on all platforms in the cluster

<sup>2</sup> Note the following about physical LUN limits for GPT-labeled disks:

- Physical LUNs with GPT labels are not constrained by XVM or CXFS to be smaller than the largest possible filesystem.
- Cluster nodes may constrain the LUN size to be smaller due to driver or other operating system constraints. A LUN used in the cluster may not be larger than the maximum size allowed by any node.
- All nodes that mount a filesystem using LUNs larger than 2 TB must be upgraded to CXFS 4.2 or later.





## Deprecated Commands

Table H-1 lists commands whose use has been replaced by `cxfs_admin`, the CXFS GUI, and `cxfs-config`.

**Table H-1** Deprecated Commands

Command	Description
<code>clconf_status</code>	Provides provides a <code>curses</code> interface to display status information gathered by the <code>cad</code> daemon.
<code>cluster_status</code>	Obtains configuration and status information.
<code>cmgr</code>	Configures the cluster database and administers CXFS
<code>haStatus</code>	Obtains configuration and status information



## Initial Configuration Checklist

Following is a checklist of the steps you must perform when installing and configuring a CXFS system.



---

**Caution:** CXFS is a complex product. To ensure that it is installed and configured in an optimal manner, you **must** purchase initial setup services from SGI.

This checklist is not intended to be used directly by the customer, but is provided for reference. It is intended to be used only as an aid; you must be certain to read this entire manual, especially "Configuration Best Practices" on page 47 and Chapter 15, "Troubleshooting" on page 375, before attempting to complete these procedures.

---

- [ ] Understand the application use, storage configuration, and I/O patterns at the site. (Not all applications benefit from CXFS; see "Comparison of XFS and CXFS" on page 3.)
- [ ] Connect the SAN hardware. See the RAID documents.
- [ ] Is there a private network? This is a requirement.
- [ ] Is system reset configured for all potential metadata servers, as recommended by SGI? Is system reset or I/O fencing configured for all client-only nodes? This is required to ensure data integrity for **all** nodes. See "Protect Data Integrity on All Nodes" on page 56.
- [ ] Are there an odd number of server-capable administration nodes with CXFS services running? Is there a client-only tiebreaker node? See "Use an Odd Number of Server-Capable Administration Nodes" on page 53 and "Use a Client-Only Tiebreaker" on page 55.
- [ ] Read this book, README files and release notes provided with the release, and the *CXFS 6 Client-Only Guide for SGI InfiniteStorage*.
- [ ] Verify that the network is usable.
- [ ] Install the CXFS software. See the *SGI InfiniteStorage Software Platform* release notes, Chapter 7, "Server-Capable Administration Node Installation" on page 123, and the *CXFS 6 Client-Only Guide for SGI InfiniteStorage*.

- [ ] Modify the configuration files and perform other tasks as needed. See Chapter 8, "Postinstallation Steps" on page 129.
- [ ] Completely configure and run a **small** cluster (such as 3 nodes). See Chapter 9, "Initial Setup of the Cluster" on page 139.
- [ ] Look for errors in the daemon log files in the `/var/cluster/ha/logs` directory.
- [ ] If all is well, add the rest of the nodes. If there are problems, see Chapter 15, "Troubleshooting" on page 375.
- [ ] Set up the filesystems. See Chapter 9, "Initial Setup of the Cluster" on page 139.

## Summary of New Features from Previous Releases

This appendix contains a summary of the new features for the CXFS releases from previous versions of the CXFS administration guides (specific part numbers are noted).

### **CXFS Version 1: Original Implementation**

CXFS version 1 is the original implementation of CXFS.

#### **IRIX 6.5.6f**

Original publication (007-4016-001).

#### **IRIX 6.5.6f Update**

The 007-4016-002 update contains additional troubleshooting information and instructions for unmounting and remounting filesystems with the command line interface. It was reorganized to make the tasks of installation and configuration clearer.

#### **IRIX 6.5.7f**

The 007-4016-003 update contains the following:

- Metadata server recovery information
- Administrative shutdown procedures
- Additional troubleshooting information
- Instructions for unmounting and remounting filesystems with the CLI
- Reorganized installation and configuration information

### IRIX 6.5.8f

The 007-4016-004 update contains the following:

- Support for hierarchical storage management (HSM) through data management application programming interface (DMAPI), also known as X/Open data storage management specification (XDSM)
- Changes to administrative shutdown, including two new `cmgr` subcommands to stop CXFS services on the local nodes: `admin cxfs_stop` and `admin cxfs_stop`
- Quorum changes without panics

### IRIX 6.5.9f

The 007-4016-005 update contains the following:

- Coexecution of CXFS and IRIS FailSafe 2.1, including commands to convert nodes and clusters to apply to both utilities
- Ability to use the `cmgr` command without extra prompting (`-p`), permitting the use of scripts
- New tasks to revoke and allow membership of the local node
- Ability to specify the tie-breaker node, which is used in the process of computing node membership for the cluster when exactly half the nodes in the cluster are up and can communicate with each other
- Clarification that a single subnet should be used

### IRIX 6.5.10f

The 007-4016-006 update contains the following:

- Clarifications about CXFS shutdown and database shutdown
- Additional information about CXFS daemons
- Clarifications to the comparison of XFS and CXFS

## IRIX 6.5.11f

The 007-4016-007 update contains the following:

- Addition of the Origin 3000 partition ID to node configuration
- Troubleshooting information for a two-node cluster when both nodes go down
- Information about editing the `/etc/hosts` file to use an alternate interface for heartbeat and control.
- Clarification about the use of hardware reset and tie-breaker nodes
- Ability to unset the tie-breaker node
- Use of `fsr`

## CXFS Version 2: MultiOS Cluster

CXFS version 2 includes client-only nodes on operating system platforms other than IRIX (*multiOS cluster*, or *heterogeneous clients*).

## IRIX 6.5.12f

The 007-4016-008 update contains the following:

- A cluster of at least **three** weighted nodes is recommended for a production environment (that is, one requiring relocation and recovery of the metadata server).

If you use a two-weighted-node cluster for production, you must do one of the following:

- Use reset lines to avoid data corruption and ensure that only one node is running in error conditions (reset lines are recommended for all CXFS clusters and required for use with IRIS FailSafe).
- Weight one node as 1 and the other as 0.
- Set a tie-breaker node.

However, there are issues with a two-weighted-node cluster.

- The new `cluster_status` command, which provides a `curses` interface to display status information gathered by the `cad` daemon (this information is also displayed by the `cxdetail` command).
- Cluster nodes can run adjacent levels of the IRIX operating system (OS); for example, 6.5.11f and 6.5.12f (this applies as of 6.5.12f).
- The ability to execute your own custom scripts around mounting operations.
- Partition ID information.
- Clarification about the following:
  - Hostname resolution rules; it is **critical** that you understand these rules and have files configured properly before attempting to configure a cluster.
  - The difference between *CXFS membership* and *fs2d membership*.
  - Configuration of nodes supported in an IRIS FailSafe and CXFS coexecution environment.
  - Unwritten extent tracking (`unwritten=1|0`) with CXFS.
  - Including the CXFS mount point in the `/etc/exports` file.
  - Number of nodes supported: 16 CXFS nodes, and up to 8 IRIS FailSafe nodes with coexecution.
  - The flow of information in a coexecution cluster.

## IRIX 6.5.13f

The 007-4016-009 update contains the following:

- The structure of the CXFS filesystem configuration has changed. CXFS filesystems can now be defined, modified, managed and deleted independently of each other and of the cluster definition. (Previously, the CXFS filesystems were defined as attributes to the cluster definition.)

The new design improves the performance, flexibility and reliability of filesystem configuration. To accommodate clusters mixing nodes running 6.5.12 and 6.5.13, backwards compatibility is enforced by default in 6.5.13. The result is that the performance achievements are not visible; however, if you are 6.5.13 on all nodes in the cluster, you may wish to turn off backwards compatibility. Backwards compatibility will be turned off in the 6.5.14 release.



- Information about locating the `xfsdump` inventory in a shared directory.
- Information about the IRIS FailSafe CXFS resource type that can be used to failover applications that use CXFS filesystems.
- The `-p` option is no longer required when defining filesystems with the `cmgr` command; the scripting capability is therefore provided.
- For certain GUI tasks, the ability to select all nodes at once in addition to specifying nodes individually.
- New `/var/cluster/cmgr-scripts/rotatelog` script to save log files with day and month name as suffixes.
- The setting to force an unmount of a filesystem using the `umount -k` option is turned off by default in the GUI. There is no default when using the `cmgr` command.
- Clarification of the term *CLI* to mean the underlying set of commands that are used by the `cmgr` cluster manager tool and by the GUI.
- Use of `sgi_apache.sw.server`.
- Correction: real-time filesystems are not currently supported. Changes to reflect this have been made in text.
- New and revised figures.

## IRIX 6.5.14f

The 007-4016-011 update contains the following:

- The graphical user interface (GUI) has been improved. The separate cluster view (the `cxdetail` command) and task manager (the `cxtask` command) have been streamlined into one window, the **CXFS Manager**. Both the `cxtask` and `cxdetail` commands are kept for historical purposes; this document refers to just `cxtask` for simplicity.

The new GUI provides the following features:

- Access to tasks through the menu bar or by clicking the right mouse button within the tree view
- Faster filesystem status and cluster status updates

- Access to the `salog(4)` file, which shows every command run from the GUI
- A **Find** textfield helps you find components within the displayed tree-view
- Information about the use of `xfs_repair` and CXFS filesystems.



---

**Caution:** Do not use `xfs_repair` on a CXFS filesystem unless you are certain there is a problem.

---

- Information about using `cmgr(8)`:
  - Invoking subcommands directly on the command line with the `-c` option
  - Using template scripts provided in the `/var/cluster/cmgr-templates` directory
- Information about MAC labels in a mixed Trusted IRIX and IRIX cluster.
- The structure of the CXFS filesystem configuration was changed with the release of IRIX 6.5.13. Backward compatibility with earlier versions is no longer maintained as of IRIX 6.5.14, because all nodes in the cluster must be running the same or adjacent releases.

If you are upgrading from 6.5.13f entirely to 6.5.14f, there is no further impact.

If you intend to run a mixture of 6.5.13f and 6.5.14f nodes, you must turn off backward compatibility.

If you are upgrading from 6.5.12f or earlier without first installing and running 6.5.13f, then you must perform a one-time manual conversion of your CXFS filesystem definitions.

## IRIX 6.5.15f

The 007-4016-012 update contains the following:

---

**Note:** Relocation and recovery are deferred in this release.

---

- Support for clients of other operating systems such as Solaris and Windows NT as defined in the *CXFS 5 Client-Only Guide for SGI InfiniteStorage*. These clients will be released asynchronously from the IRIX release. This support will require a

minimum of IRIX 6.5.15f plus appropriate patches. For more information, see your SGI support contact.

- Default scripts are now provided in the `/var/cluster/clconfd-scripts` directory to permit NFS-exporting of CXFS filesystems listed in `/etc/exports`.
- Reset lines are mandatory for two-node and two-weighted node clusters. Larger clusters should have an odd number of weighted nodes, or must have serial reset lines if only two of the nodes are weighted.
- Simplification of Chapter 1. General information about the CXFS Manager GUI and `cmgr` have been moved to their respective reference chapters, coexecution details have been moved into a separate chapter, and the communication flow diagrams and daemon information have been moved into an appendix.
- Information about the error messages that may cause administrators to use `xfs_repair` inappropriately.
- Changes to the `rotatelog` script syntax. The root `crontab` file now has an entry to run the `rotatelog` script weekly. If you run the script twice in one day, it will append the current log file to the previous saved copy, rather than overwriting it.
- A new figure describing some of the various combinations of node and cluster types in a coexecution cluster.

## IRIX 6.5.16f

The 007-4016-013 update contains the following:

---

**Note:** Relocation and recovery are fully implemented, but the number of associated problems prevents support of these features in CXFS. While data integrity is not compromised, cluster node panics or hangs are likely to occur. These features will be fully supported when these issues are resolved.

---

- Support for Solaris and Windows NT systems in a multiple operating system (multiOS) cluster, including the following:
  - Information about defining the operating system for a node. For existing clusters that are upgraded to IRIX 6.5.16f, existing nodes will be assigned an operating system type of `IRIX`.

- Information about I/O fencing, which allows a problem node to be isolated from the storage area network (SAN) so that it cannot corrupt data in the shared CXFS filesystem. Solaris and Windows NT nodes require a Brocade switch in order to support I/O fencing for data integrity protection; therefore, the Brocade switch is a required piece of hardware in a cluster running multiple operating systems.
- The new terms *multiOS* and *CXFS client-only node*.
- Support for the L1 controller on SGI Origin 300, SGI Origin 3200C, SGI Onyx 300, and SGI Onyx 3200C systems.
- Information about the CXFS GUI tasks to define and modify a filesystem, which have been split into two pages for ease of use.
- New GUI icons.

## IRIX 6.5.17f

The 007-4016-014 update contains the following:

- A new appendix contains an example `/etc/ipfilterd.conf` file that can be used to provide IP filtering for the CXFS private network.
- The `build_cmgr_script` command, which generates a `cmgr` script from the cluster database. The script can be used later to recreate the cluster database after performing a `cdbreinit` command.
- A sample script to `unexport` and locally `umount` an `lofs` filesystem.
- Use of the new command name `cx fsmgr`. The `cx fsmgr` command has the same function as the `cxtask` and `cxdetail` commands, which are kept for historical purposes.
- Clarifications to the following:
  - Starting the CXFS Manager graphical user interface
  - Masking and I/O fencing
  - Terminology such as *cluster*, *node*, and *pool*
  - Terminology used to describe the GUI

## IRIX 6.5.18f

The 007-4016-015 update contains the following:

---

**Note:** In this release, relocation is disabled by default and recovery is supported only when using standby nodes.

A *standby node* is a metadata server-capable administration node that is configured as a potential metadata server for a given filesystem, but does not currently run any applications that will use that filesystem. To use recovery, you must not run any applications on any of the potential metadata servers for a given filesystem; after the active metadata server has been chosen by the system, you can then run applications that use the filesystem on the active metadata server and client-only nodes.

Relocation and recovery are fully implemented, but the number of associated problems prevents full support of these features in the current release. Although data integrity is not compromised, cluster node panics or hangs are likely to occur. Relocation and recovery will be fully supported in a future release when these issues are resolved.

---

- IRIX nodes may now be CXFS client-only nodes, meaning that they run a minimal implementation of the CXFS and cluster services, and do not contain a copy of the CXFS cluster database. Client-only nodes are installed with the `cxfs_client` software product.

This change also introduces the term *CXFS administration node*, which is a node that is installed with the `cluster_admin` software product, allowing the node to perform cluster administration tasks and contain a copy of the cluster database. Nodes that you want to run as metadata servers must be installed as CXFS server-capable administration nodes; SGI recommends that all other nodes be installed as client-only nodes.

When you define a node, you no longer need to specify the node weight. This has been replaced by the **Node Function** field, allowing you to choose **Server-capable Admin**, **Client Admin**, or **Client-Only**. (For Solaris and Windows nodes, **Client-Only** is automatically selected for you.) Similar fields are provided for the `cmgr` command.

When upgrading to 6.5.18f, already existing IRIX nodes will by default be assigned as **Server-capable Admin** if they had a weight of 1.

This version also clarifies the terms used for membership: *CXFS kernel membership* and *cluster database membership*.

- New system-tunable parameters:
  - `cxfs_relocation_ok` lets you enable or disable the relocation feature; relocation is disabled by default in this release, and SGI recommends that you **do not** enable it.
  - `cxfsd_min` and `cxfsd_max` let you specify the minimum and maximum number of `cxfsd` threads to run per CXFS filesystem.
- New commands:
  - `cxfs_info` provides status information about the cluster, nodes, and filesystems and is run from a client-only node.
  - `cxfsdump` gathers CXFS configuration information.
- A CXFS cluster is supported with as many as 32 nodes. As many as 16 of those nodes can be CXFS administration nodes and all other nodes can be client-only nodes. You can choose to define a node as a CXFS client administration node, however, SGI strongly recommends that only potential metadata servers be configured as CXFS server-capable administration nodes and that there be an odd number of server-capable administration nodes for quorum calculation purposes.
- The graphical user interfaces for XVM and CXFS have been combined into one. This guide provides an overview of the XVM-specific tasks provided by the GUI; for details about these tasks, see the *XVM Volume Manager Administrator's Guide*.

The tasks to make, grow, mount/unmount a filesystem are now provided in the GUI.
- Tips about using CXFS and Trusted IRIX.
- Support for Microsoft Windows 2000 systems as client-only nodes. (This guide uses *Windows* to refer to both Microsoft Windows NT and Microsoft Windows 2000 nodes when the information applies equally to both. Information that applies to only one of these types of nodes is identified.)

## IRIX 6.5.19f

The 007-4016-016 update contains the following:

- The new rolling annual upgrade policy that permits you to upgrade from 6.5.*n* to the *n+1* or *n+4* release, as of 6.5.18f.

- The time required to update and propagate the database across nodes in the cluster has been significantly decreased.
- If you use I/O fencing and `ipfilterd` on a node, the `ipfilterd` configuration must allow communication between the node and the `telnet(1)` port on the switch.
- The following nodes do not contain system controllers and therefore require I/O fencing for data integrity protection:
  - Silicon Graphics Fuel visual workstation
  - Silicon Graphics Octane system
  - Silicon Graphics Octane2 system
- The CXFS Manager graphical user interface (GUI) has added a new icon to represent client-only nodes.
- In preparation for future CXFS MultiOS client releases, the CXFS software now also allows you to specify the Linux, IBM AIX, and Hewlett-Packard HP-UX operating systems when defining a node. For support details, see the *CXFS 5 Client-Only Guide for SGI InfiniteStorage* and release notes.
- This version clarifies the various methods to perform cluster database backups and restorations.
- Application programmers should be aware that XFS recently relaxed the requirement that direct I/O be aligned along filesystem block boundaries. As of IRIX 6.5.19f, direct I/O will also be accepted using 512-byte alignment.

This change makes the use of direct I/O on a CXFS partition more consistent with that of other vendor's requirements and thus makes the use of CXFS more transparent. See the description of direct I/O requirements in the `fcntl` man page.
- This version lists the system tunable parameters found in the `/var/sysgen/mtune/cell` file, some of which should not be modified.

## IRIX 6.5.20f

The 007-4016-017 update contains the following:

- Changes to the CXFS graphical user interface (GUI):
  - New login connection choices, including support for a remote shell connection, which connects to the server via a user-specified command shell, such as `rsh` or `ssh`.
  - The ability for the `root` user to grant other users permission to execute specific GUI tasks.
  - Use of Java2 for the CXFS GUI, which simplifies the Java installation and co-operation with third-party GUIs. This also enhances the ability to run the GUI through a web browser (via `http://server/CXFSManager/`).
  - Information about using the right mouse button to access tasks appropriate to the selected GUI item.
- Changes to the `cxfsd_min` and `cxfsd_max` defaults, and the `cxfsd_max` legal values.
- More information about memberships, quorums, and tiebreakers.
- A new figure describing standby mode.
- More information about IRIX client-only issues:
  - Client-only node system files
  - Status in log files
  - `cxfs_client` error messages



## CXFS Version 3: IRIX or SGI ProPack (Linux 2.4 Kernel) Servers

CXFS version 3 adds support for CXFS metadata servers on SGI Altix systems running Linux (2.4 kernel).

### CXFS 3.0

The 007-4016-018 update contains the following:

- Support for SGI ProPack metadata servers on SGI Altix 3000 family of servers and superclusters. A CXFS cluster can contain either SGI ProPack 2.3 server-capable administration nodes on Altix systems or IRIX server-capable administration nodes; you cannot mix IRIX and SGI ProPack server-capable administration nodes within one cluster.

CXFS does not support the relocation or recovery of DMAPi filesystems that are being served by SGI ProPack metadata servers.

Coexecution with FailSafe is not supported on SGI ProPack nodes.

- Due to packaging enhancements, CXFS may now be installed on the M stream or the F stream.

The IRIX CXFS software will no longer be bundled in the IRIX overlay CDs but instead is on a separate *CXFS IRIX Server and Client 3.0 for IRIX 6.5.22* CD. This changes the installation procedure.

---

**Note:** If you are upgrading from a previous IRIX release and have CXFS installed, you must upgrade both IRIX and CXFS. If you try to upgrade one without the other, conflicts will occur.

---

- Information about defining networks for CXFS kernel messaging (in addition to the network used for heartbeat/control). However, use of these networks is **deferred**.
- Support for IRIX real-time filesystems.
- Suggestions for configuring large clusters.
- Information about using ping to verify general connectivity and CXFS heartbeat in a multicast environment.

- The GUI has been changed to show a single display for the nodes in the cluster and nodes that are in the pool but not in the cluster. This new selection is **View: Nodes and Cluster**.
- Information about information retaining system core files and the output from the `cxfsdump` utility when reporting problems.
- Information about monitoring heartbeat timeouts for IRIX using Performance Co-Pilot or the `icrash` command.
- The ability to define multiple CXFS filesystems at one time with the GUI.

### CXFS 3.1

The 007-4016-019 update contains the following:

- Information about migrating from an IRIX cluster to a SGI ProPack cluster
- Support for a cluster of up to 64 nodes.
- Information about the TP9300 RAID.
- Information about the `cxfs-config` command.
- Clarification that serial hardware reset lines or I/O fencing is **required for all nodes** in order to protect data integrity.
- The ability to define a reset method for a given node to one of the following:
  - `powerCycle` to turn power off and on
  - `reset` to perform a serial reset
  - `nmi` to perform a nonmaskable interrupt

You can define this method using either the `cmgr` command or the GUI. You can manually perform a powercycle or an NMI with the `cmgr` command.

- New appendixes summarizing operating system path differences and new features from previous releases

## CXFS 3.2

The 007-4016-020 version contains the following:

- Support for client-only nodes running the Mac OS X operating system in the configuration tools.
- Information about console redirection.
- Information about the SGI TP9300, SGI TP9300S, and SGI TP9500S.
- Information about hardware changes and I/O fencing.
- Updated migration examples.
- Removal of the unimplemented GUI feature to define CXFS kernel messaging networks.

## CXFS 3.2 Update

The 007-4016-021 update contains the following:

- Information about private network failover as defined with the `cmgr` command. (Although the primary network must be private, the backup network may be public.)
- Support for Guaranteed-rate I/O version 2 (GRIOv2) in the IRIX installation procedure.
- Corrections to CXFS and cluster administration path differences between IRIX and SGI ProPack on SGI Altix systems.
- Updated the example for `clconf_info` command. The `clconf_info` command now reports a node as `inactive` rather than `DOWN*` and the unused incarnation number has been removed.
- Support for token obtain optimization. To disable, use the `cxfs_prefetch` system tunable parameter.
- If you have a cluster with an even number of server-capable administration nodes and no tiebreaker: to avoid a split-brain scenario, you should not use the **Shutdown** setting on any server-capable administration node.
- Information about multiple Ethernet interfaces on SGI Altix systems and providing persistent device naming.

- Clarification about the `chkconfig` arguments used for IRIX administration nodes, SGI ProPack administration nodes, and client-only nodes.
- Information about the correct options to use for quotas on SGI ProPack clusters (`uquota` and `gquota`).
- Information about serial reset configurations.
- Information about using the `hafence(1M)` command to define a QLogic switch. (You cannot use the GUI or the `cmgr` command to define or modify a switch other than a Brocade switch.)
- If you want to use quotas on a CXFS filesystem, you must install the quota package.
- Information about removing a metadata server from the cluster for maintenance.
- Mount options information.
- Addition of the XVM graphical user interface (GUI) to the CXFS SGI ProPack package.

### CXFS 3.3

The 007-4016-022 update contains the following:

- Procedures to remove a single client from the cluster and restore it, and shut down the entire cluster.
- A new chapter about best practices.
- Information about XVM failover.
- Updates to the rolling upgrade policy.
- Information about performing a miniroot install.
- Information about installing the latest Java2 software for use with the CXFS GUI and SGI ProPack.
- Information about modifying the `httpd.conf` file in order to use the CXFS GUI on SGI ProPack.
- Clarifications to terminology.

## CXFS 3.4

The 007-4016-023 update contains the following:

- Information about discovering the WWNs
- Support for system reset for SGI Altix systems that use an integrated L2, such as a NUMALink 4 R-brick, or SGI Altix 3000 Bx2 systems. Configuring a node of this type requires use of `cmgr`.
- Support for SGI ProPack for Linux 4 as a client-only node.
- Support for the `cxfsdump -secure` option for secure remote connections. In cluster mode (the default), `cxfsdump` requires `rsh/ssh` and `rcp/scp` access across all nodes in the cluster.

## CXFS Version 4: IRIX or SGI ProPack (Linux 2.6 Kernel) Servers

CXFS version 4 adds support for CXFS metadata servers on SGI Altix systems running Linux 2.6 kernel.

## CXFS 4.0

The 007-4016-024 update contains the following:

- Support for SGI ProPack 4 for Linux Service Pack 3.
- Support for IRIX 6.5.29.
- Server-side CXFS client license keys are now supported on server-capable administration nodes, allowing a client without a node-locked client-side license key to request a license key from the server. Server-side license keys are optional on IRIX metadata servers, but are required on SGI ProPack metadata servers. The licensing software is based on the FLEXlm product from Macrovision Corporation.
- Support for the `cxfs_admin` cluster configuration and administration command, which waits for a command to be completed before continuing, provides the ability to limit which nodes can mount a filesystem, provides an improved interface over `cmgr` (including `<TAB>` completion of commands), and scripting capabilities. In a future release, `cxfs_admin` will replace `cmgr`.
- The availability of dynamic heartbeat monitoring.

- Information about choosing the correct version of XVM failover for your cluster.
- Support for an SGI ProPack node as a server for the Guaranteed Rate I/O version 2 (GRIOv2) feature of CXFS.
- Support for GPT labels.
- Information about using the `md` driver on large SGI Altix systems with CXFS.
- Updates to IRIX CXFS installation procedures.
- Support for specifying a direct list of port numbers to be masked (that is, ports that will never be fenced), rather than using a hexadecimal string that represents the list. Ports that can be masked are now in the range 0 through 1023.
- Ability to specify a vendor when defining a Fibre Channel switch using the GUI.
- Requirement to start the file alteration monitoring (`fam`) service on SGI ProPack nodes in order to use the CXFS graphical user interface (GUI).
- Information about switching between `SGIRDAC` and `SGIAVT` mode for SGI RAID.
- Information about CXFS port usage. CXFS Port Usage.
- Information about the recovery timeout mechanism, in which nodes are polled for progress after a recovery has begun. If recovery for a node is not progressing according to the specified polls, the recovery is considered stalled and the node will then shut down or panic; this prevents the cluster from hanging and keeps filesystems available for the rest of the nodes in the cluster. The following site-changeable system tunable parameters are used:  

```
cxfs_recovery_timeout_panic  
cxfs_recovery_timeout_period  
cxfs_recovery_timeout_stalled  
cxfs_recovery_timeout_start
```
- Information about using the `filestreams` mount option to optimize disk layout.
- Best-practices information about:
  - Using proper storage management procedures
  - Being aware of differences between IRIX and Linux system administration
  - Modifying `updatedb` to avoid unnecessary load
  - Using fast copying for large CXFS files

- Minimizing the number of switches

---

**Note:** The contents of the former “Avoid Problems” section from the Troubleshooting chapter was moved into the Best Practices chapter.

---

- Addition of SGI RAID information (this information was removed from the release notes).
- Addition of switches information (this information was removed from the release notes).
- A complete list of system-tunable parameters.
- Support for drag-and-drop within the GUI to move nodes between the pool and the cluster.
- Client administration nodes are only supported and appropriate for IRIX nodes running in coexecution with FailSafe. If you are running an earlier release and have an SGI ProPack node that is defined as a client administration node, you must delete the node from the cluster database, uninstall CXFS, reinstall CXFS, and redefine the node as a client-only node. For simplicity, this guide no longer refers to *client-administration node* or *administration node* except in specific instances.
- For clarity, this book now uses the term *SGI ProPack* rather than *Linux* when referring to CXFS nodes running SGI ProPack for Linux.

## CXFS 4.1

The 007-4016-025 version includes the following:

- Support for SGI IRIX 6.5.30.
- Support for SGI ProPack 5 running SUSE Linux Enterprise Server 10 (SLES 10).
- Support for SGI License Key (LK) software on SGI ProPack server-capable administration nodes.

Server-side licensing is required on the following client-only nodes (to determine the Linux architecture type, use the `uname -i` command):

- SGI ProPack 5
- Red Hat Enterprise Linux (RHEL) 4 on x86-64

- SLES 9 on x86-64
  - SLES 10 on x86-64 or ia64
- 

**Note:** For specific release levels, see the release notes.

---

Other client-only nodes can use either server-side or client-side licensing. However, if one node within a cluster requires server-side licensing, all nodes must use server-side licensing. If no nodes in the cluster require server-side licensing, the nodes can continue to use existing client-side licensing.

---

**Note:** Server-side licensing is preferred, and no new client-side licenses will be issued. Customers with support contracts can exchange their existing client-side licenses for new server-side licenses. A future release will not support client-side licensing. For more information, contact SGI customer support.

---

- Support for the following RAID hardware:
  - SGI InfiniteStorage 10000
  - SGI InfiniteStorage 6700
  - SGI InfiniteStorage 4500
  - SGI InfiniteStorage 4000
- DMAPi is disabled by default on SGI ProPack 5 systems. When you install DMF on a server-capable administration node, it automatically enables DMAPi. However, if you want to mount filesystems on an SGI ProPack 5 client-only node with the `dmi` mount option, you must enable DMAPi.
- Information about the appropriate use of `lcrash` for SGI ProPack.
- Information about the procedure required when upgrading from CXFS 3.4.1 or earlier for clusters with three or more server capable nodes.
- Information about removing a metadata server from the cluster while avoiding a reset.
- New `mtcp_rpc_thread` system tunable parameter (for SGI ProPack and Linux third-party nodes) that specifies whether metadata messages are sent from a separate thread in order to save stack space.
- Information about rotating log files on SGI ProPack.



- Information about `SYSLOG credid` warnings.
- The table of mount options is now located in the *CXFS 5 Client-Only Guide for SGI InfiniteStorage*.

## CXFS 4.2

The 007-4016-026 version includes the following:

- Support for the SGI InfiniteStorage 220 RAID.
- Support for Intelligent Platform Management Interface (IPMI) reset using a baseboard management controller (BMC).
- As of CXFS 4.2, all server-capable administration nodes running 4.2 and client-only nodes running 4.2 require server-side licensing. If **all** existing client-only nodes are running a prior supported release, they may continue to use client-side license as part of the rolling upgrade policy until they are upgraded to 4.2. All client-only nodes in the cluster must use the same licensing type — if any client-only node in the cluster is upgraded to 4.2 or if a new 4.2 client-only node is added, then all nodes must use server-side licensing.

Customers with support contracts can exchange their existing client-side licenses for new server-side licenses. For more information, contact SGI customer support.

- Support for GPT-labeled LUNs larger than 2 TB. (All nodes that mount a filesystem using LUNs larger than 2 TB must be upgraded to CXFS 4.2 or later.)
- Disk layout optimization for approved media customers
- If you have multiple clusters connected to the same public network, use the `-i` option to `cxfs_admin` to identify the cluster name.
- Precedence of configuration options
- Support for printing `hafence` debug information to the specified file *debugfile* by using the `-d` option in the `/etc/cluster/config/clconfd.options` file.
- Using `cxfs-reprobe` on client-only nodes (SGI ProPack)
- Information about parameters that must be set for QLogic switches.
- The ability to use environment variables or the `.cxfs_admin` file to specify defaults for `cxfs_admin`, in addition to the `set` command.

- Documentation for the support of XVM failover version 2 on Windows (first supported in the CXFS 4.1.1 release).
- A new section that describes how to view the current CXFS licenses with the `cxfs_admin` command.
- `clconfd.options` on CXFS Administration Nodes
- Information about the `cmgr` command has been moved to an appendix. With the exception of performing the following administrative `cmgr` commands, the preferred CXFS configuration tools are `cxfs_admin` and the CXFS graphical user interface (GUI):

```
admin ping
admin reset
admin powerCycle
```

As of the CXFS 5.0 release, this functionality will be provided by the `cxfs_admin` command and the `cmgr` command will not be supported.

## CXFS Version 5: Linux Servers

CXFS version 5 supports CXFS metadata servers running Linux.

### CXFS 5.0

The 007-4016-027 version contains the following:

- Support for clusters with server-capable administration nodes running only SGI ProPack for Linux. IRIX is now exclusively supported as a client-only platform and is generally documented in *CXFS 5 Client-Only Guide for SGI InfiniteStorage*.

Because IRIX is no longer supported as a server-capable administration node, CXFS 5.0 also no longer supports coexecution with FailSafe. Because the client administration node type (`client_admin`) was supported only for coexecution with FailSafe, this node type is no longer supported.

For information about moving from a cluster with IRIX metadata servers to a cluster with SGI ProPack metadata servers, see the IRIX chapter in this book.

---

**Note:** CXFS does not support SGIRDAC mode.

---

- New initial installation and update procedures.
- The ability to revoke and restore the CXFS kernel membership for the local node, which must be a server-capable administration node, by using the `stop_cxfs` and `start_cxfs` commands in `cxfs_admin`.
- The ability to generate streaming workload for SD/HD/2K/4K formats of video streams by using the `frametest(1)` command.
- Support for the `framesort` utility, which provides easy file-layout analysis and advanced file-sequence reorganization.
- The new site-changeable static system-tunable parameter `mtcp_hb_local_options`.
- Reorganization to improve clarity.
- Information about the `cmgr` command is located primarily in an appendix (which has not been updated to reflect CXFS 5.0 support). With the exception of a few administrative `cmgr` commands, the preferred CXFS configuration tools are `cxfs_admin` and the CXFS graphical user interface (GUI). The following `cmgr` commands are still useful:

```
admin fence
admin nmi
admin ping
admin powerCycle
admin reset
start/stop cx_services
test connectivity
test serial
```

In addition, the `build_cmgr_script` command is still useful.

In a future release, all of `cmgr` functionality will be provided by the `cxfs_admin` command and the `cmgr` command will not be supported.

- The following commands are now deprecated: `clconf_status` and `cluster_status`. The functionality of these commands is now provided by the `cxfs_admin` command and/or the CXFS GUI.

## CXFS 5.2

The 007-4016-028 version contains the following:

- Support for *easy client configuration* using the `cxfs_admin` command and the new `autoconf` object, which was introduced in CXFS 5.1. This feature lets you specify new client-only nodes that are allowed to be automatically configured into the cluster database. (This action only applies to hosts that are not currently defined in the cluster database.)
- CXFS server-capable nodes must run SGI Foundation Software 1.

SGI Foundation Software 1 is a new product from SGI consisting of technical support tools, utilities, and driver software that enable SGI's Linux systems to run reliably and consistently. SGI ProPack 6 is the next generation of SGI's suite of performance-optimization libraries and tools that accelerate applications on SGI's Linux systems. SGI ProPack 6 may be optionally installed on any CXFS node running SGI Foundation Software 1. For more information on the content of these products, upgrades, ordering, service contracts, and licensing, see Supportfolio.

- Information about limited support for case-insensitive CXFS filesystems, first introduced with CXFS 5.1.
- Support for *edge serving*, in which CXFS client nodes can act as servers for NFS, Samba, CIFS, or any third-party network filesystem exporting files from a CXFS filesystem. However, there are no performance guarantees when using edge serving; for best performance, SGI still recommends that you use the active metadata server. If you require a high-performance solution, contact SGI Professional Services.

## CXFS 5.4

The 007-4016-029 version contains corrections the following new sections:

- “Unmount Filesystems Before Adding or Deleting Server-Capable Administration Nodes”
- “Change the Brocade Password when Prompted”
- “Use a Time Synchronization Application”
- “Turn Off Local XVM on Linux Nodes if Unused”
- “Configuring SuSEfirewall2”

- “Dynamic Parameters for Debugging Purposes Only”

## CXFS 5.6

The 007-4016-030 version contains the following:

- Support for SLES 11
- Information about the `node is downrev` error
- Inclusion of the following debugging dynamic system tunable parameters (added in CXFS 5.5) that specify the maximum age of a granted range, measured in generations, before the client will voluntarily return it or the server will recall it:
  - `cxfs_client_range_age_max`
  - `cxfs_server_range_age_max`
- Guaranteed Rate I/O (GRIO) version 2 is disabled by default on server-capable administration nodes.
- RPM name change (implemented in ISSP 1.7): `cxfs-sysadm` changes to `sgi-sysadm`
- Some caveats and considerations that were formerly listed in the CXFS general release note have been incorporated into this guide.



---

## Glossary

### **ACL**

Access control list.

### **active metadata server**

A server-capable administration node chosen from the list of potential metadata servers. There can be only one active metadata server for any one filesystem. See also *metadata*.

### **administration node**

See *server-capable administration node*.

### **administrative stop**

See *forced CXFS shutdown*.

### **advanced mode**

The `cxfs_admin` complexity mode that provides a list of possible choices when using the <TAB> key, prompts for all possible fields, displays all attributes, and includes debugging information in output.

### **age**

The number of membership transitions in which the node has participated. The age is 1 the first time a node joins the membership and will increment for each time the membership changes. This number is dynamically allocated by the CXFS software (the user does not define the age).

### **ARP**

Address resolution protocol.

### **basic mode**

The `cxfs_admin` complexity mode that only shows the common options and attributes in `show` output, provides a list of possible choices when using the <TAB> key, and uses prompting.

**bandwidth**

Maximum capacity for data transfer.

**blacklisted**

A node that is explicitly not permitted to be automatically configured into the cluster database.

**BMC**

Baseboard management controller.

**cell ID**

A number associated with a node that is allocated when a node is added into the cluster definition with the GUI or when it is defined with `cxfs_admin`. The first node in the cluster has cell ID 0, and each subsequent node added gets the next available incremental cell ID. If a node is removed from the cluster, its cell ID becomes available. It differs from *node ID*.

**CLI**

Underlying command-line interface commands used by the CXFS Manager graphical user interface (GUI).

**client**

In CXFS, a node other than the active metadata server that mounts a CXFS filesystem. A *server-capable administration node* can function as either an active metadata server or as a CXFS client, depending upon how it is configured and whether it is chosen to be the active metadata server. A *client-only node* always functions as a client.

**client-only node**

A node that is installed with the `cxfs_client.sw.base` software product; it does not run cluster administration daemons and is not capable of coordinating CXFS metadata. Any node can be client-only node. See also *server-capable administration node*.

**cluster**

A *cluster* is the set of systems (nodes) configured to work together as a single computing resource. A cluster is identified by a simple name and a cluster ID. A cluster running multiple operating systems is known as a *multiOS cluster*.



There is only one cluster that may be formed from a given pool of nodes.

Disks or logical units (LUNs) are assigned to clusters by recording the name of the cluster on the disk (or LUN). Thus, if any disk is accessible (via a Fibre Channel connection) from machines in multiple clusters, then those clusters must have unique names. When members of a cluster send messages to each other, they identify their cluster via the cluster ID. Cluster names must be unique.

Because of the above restrictions on cluster names and cluster IDs, and because cluster names and cluster IDs cannot be changed once the cluster is created (without deleting the cluster and recreating it), SGI advises that you choose unique names and cluster IDs for each of the clusters within your organization.

#### **cluster administration daemons**

The set of daemons on a server-capable administration node that provide the cluster infrastructure: `cad`, `cmond`, `fs2d`, `crsd`. See "CXFS Control Daemons" on page 44.

#### **cluster administration tools**

The CXFS graphical interface (GUI) and the `cxfs_admin` command-line tools that let you configure and administer a CXFS cluster, and other tools that let you monitor the state of the cluster. See "CXFS Tools" on page 38.

#### **cluster administrator**

The person responsible for managing and maintaining a cluster.

#### **cluster database**

The database that contains configuration information about all nodes and the cluster. The database is managed by the cluster administration daemons.

#### **cluster database membership**

The group of server-capable administration nodes in the **pool** that are accessible to cluster administration daemons and therefore are able to receive cluster database updates; this may be a subset of the nodes defined in the pool. The cluster administration daemons manage the distribution of the cluster database (CDB) across the server-capable administration nodes in the pool. (Also known as *user-space membership* and *fs2d database membership*.)

**cluster domain**

The XVM concept in which a filesystem applies to the entire cluster, not just to the local node. See also *local domain*.

**cluster ID**

A unique number within your network in the range 1 through 255. The cluster ID is used by the operating system kernel to make sure that it does not accept cluster information from any other cluster that may be on the network. The kernel does not use the database for communication, so it requires the cluster ID in order to verify cluster communications. This information in the kernel cannot be changed after it has been initialized; therefore, you must not change a cluster ID after the cluster has been defined. Clusters IDs must be unique.

**cluster mode**

One of two methods of CXFS cluster operation, *Normal* or *Experimental*. In *Normal* mode, CXFS monitors and acts upon CXFS kernel heartbeat or cluster database heartbeat failure; in *Experimental* mode, CXFS ignores heartbeat failure. *Experimental* mode allows you to use the kernel debugger (which stops heartbeat) without causing node failures. You should only use *Experimental* mode during debugging with approval from SGI support.

**cluster node**

A node that is defined as part of the cluster. See also *node*.

**complexity mode**

The manner in which `cxfs_admin` operates. See *basic mode* and *advanced mode*.

**control messages**

Messages that the cluster software sends between the cluster nodes to request operations on or distribute information about cluster nodes. Control messages, CXFS kernel heartbeat messages, CXFS metadata, and cluster database heartbeat messages are sent through a node's network interfaces that have been attached to a private network.

**control network**

See *private network*.

**CXFS**

Clustered XFS, a clustered filesystem for high-performance computing environments. See "What is CXFS?" on page 1.

**CXFS client daemon**

The daemon (`cxfs_client`) that controls CXFS services on a client-only node.

**CXFS control daemon**

The daemon (`clconfd`) that controls CXFS services on a server-capable administration node. See "Cluster Administration Daemons" on page 43.

**CXFS database**

See *cluster database*.

**CXFS kernel membership**

The group of CXFS nodes that can share filesystems in the cluster, which may be a subset of the nodes defined in a cluster. During the boot process, a node applies for CXFS kernel membership. Once accepted, the node can share the filesystems of the cluster. (Also known as *kernel-space membership*.) CXFS kernel membership differs from *cluster database membership*.

**CXFS services**

The enabling/disabling of a node, which changes a flag in the cluster database. This disabling/enabling does not affect the daemons involved. The daemons that control CXFS services are `clconfd` on a server-capable administration node and `cxfs_client` on a client-only node. See "CXFS Services" on page 29.

**CXFS services start**

To enable a node, which changes a flag in the cluster database, by using an administrative task in the CXFS GUI or the `cxfs_admin enable` command.

**CXFS services stop**

To disable a node, which changes a flag in the cluster database, by using the CXFS GUI or the `cxfs_admin disable` command. See also *forced CXFS shutdown*.

**CXFS shutdown**

See *forced CXFS shutdown* and *shutdown*.

**CXFS tiebreaker node**

A node identified as a tiebreaker for CXFS to use in the process of computing CXFS kernel membership for the cluster, when exactly half the nodes in the cluster are up and can communicate with each other. There is no default CXFS tiebreaker. SGI recommends that the tiebreaker node be a client-only node.

**database**

See *cluster database*.

**database membership**

See *cluster database membership*.

**details area**

The portion of the GUI window that displays details about a selected component in the view area. See also *view area*.

**domain**

See *cluster domain* and *local domain*.

**dynamic heartbeat monitoring**

Starts monitoring CXFS kernel heartbeat only when an operation is pending. Once monitoring initiates, it monitors at 1-second intervals and declares a timeout after 5 consecutive missed seconds, just like *static heartbeat monitoring*.

**DVH**

Disk volume header.

**easy client configuration**

Using the `cxfs_admin` command and the `autoconf` object to specify new client-only nodes that are allowed to be automatically configured into the cluster database.

**edge serving**

See *NFS edge serving*.

**fail policy hierarchy**

See *fail policy*.

**failure policy**

The set of instructions that determine what happens to a failed node; the second instruction will be followed only if the first instruction fails; the third instruction will be followed only if the first and second fail. The available actions are: *fence*, *fencerreset*, *reset*, and *shutdown*.

**fence**

The failure policy method that isolates a problem node so that it cannot access I/O devices, and therefore cannot corrupt data in the shared CXFS filesystem. I/O fencing can be applied to any node in the cluster (CXFS clients and metadata servers). The rest of the cluster can begin immediate recovery.

**fencerreset**

The failure policy method that fences the node and then, if the node is successfully fenced, performs an asynchronous system reset; recovery begins without waiting for reset acknowledgment. If used, this fail policy method should be specified first. If the fencing action fails, the reset is not performed; therefore, *reset* alone is also highly recommended for all server-capable administration nodes (unless there is a single server-capable administration node in the cluster).

**fencing recovery**

The process of recovery from fencing, in which the affected node automatically withdraws from the CXFS kernel membership, unmounts all filesystems that are using an I/O path via fenced HBA(s), and then rejoins the cluster.

**forced CXFS shutdown**

The withdrawal of a node from the CXFS kernel membership, either due to the fact that the node has failed somehow or by issuing an `admin cxfs_stop` command. This disables filesystem and cluster volume access for the node. The node remains enabled in the cluster database. See also *CXFS services stop* and *shutdown*.

**fs2d database membership**

See *cluster database membership*.

**gratuitous ARP**

ARP that broadcasts the MAC address to IP address mappings on a specified interface.

**GUI**

Graphical user interface. The CXFS GUI lets you set up and administer CXFS filesystems and XVM logical volumes. It also provides icons representing status and structure. See Chapter 10, "CXFS GUI" on page 157.

**GPT**

GUID partition table

**heartbeat messages**

Messages that cluster software sends between the nodes that indicate a node is up and running. CXFS kernel heartbeat messages, cluster database heartbeat messages, CXFS metadata, and control messages are sent through the node's network interfaces that have been attached to a private network.

**heartbeat timeout**

If no CXFS kernel heartbeat or cluster database heartbeat is received from a node in this period of time, the node is considered to be dead. The heartbeat timeout value must be at least 5 seconds for proper CXFS operation.

**I/O fencing**

See *fence*.

**IPMI**

Intelligent Platform Management Interface.

**ISSP**

SGI InfiniteStorage Software Platform, the distribution method for CXFS software.

**kernel-space membership**

See *CXFS kernel membership*.

**LAN**

Local area network.

**local domain**

XVM concept in which a filesystem applies only to the local node, not to the cluster. See also *cluster domain*.

**log configuration**

A log configuration has two parts: a *log level* and a *log file*, both associated with a *log group*. The cluster administrator can customize the location and amount of log output, and can specify a log configuration for all nodes or for only one node. For example, the `crsd` log group can be configured to log detailed level-10 messages to the `crsd-nodeA` log only on the node `nodeA` and to write only minimal level-1 messages to the `crsd` log on all other nodes.

**log file**

A file containing notifications for a particular *log group*. A log file is part of the *log configuration* for a log group.

**log group**

A set of one or more CXFS processes that use the same log configuration. A log group usually corresponds to one daemon, such as `gcd`.

**log level**

A number controlling the number of log messages that CXFS will write into an associated log group's log file. A log level is part of the log configuration for a log group.

**logical volume**

A logical organization of disk storage in XVM that enables an administrator to combine underlying physical disk storage into a single unit. Logical volumes behave like standard disk partitions. A logical volume allows a filesystem or raw device to be larger than the size of a physical disk. Using logical volumes can also increase disk

I/O performance because a volume can be striped across more than one disk. Logical volumes can also be used to mirror data on different disks. For more information, see the *XVM Volume Manager Administrator's Guide*.

**LUN**

Logical unit. A logical disk provided by a RAID. A logical unit number (LUN) is a representation of disk space. In a RAID, the disks are not individually visible because they are behind the RAID controller. The RAID controller will divide up the total disk space into multiple LUNs. The operating system sees a LUN as a hard disk. A LUN is what XVM uses as its physical volume (*physvol*). For more information, see the *XVM Volume Manager Administrator's Guide*.

**membership**

See *cluster database membership* and *CXFS kernel membership*.

**membership version**

A number associated with a node's cell ID that indicates the number of times the CXFS kernel membership has changed since a node joined the membership.

**metadata**

Information that describes a file, such as the file's name, size, location, and permissions.

**metadata server**

The server-capable administration node that coordinates the updating of metadata on behalf of all nodes in a cluster. There can be multiple potential metadata servers, but only one is chosen to be the active metadata server for any one filesystem.

**metadata server recovery**

The process by which the metadata server moves from one node to another due to an interruption in CXFS services on the first node. See also *recovery*.

**multiOS cluster**

A cluster that is running multiple operating systems, such Linux and Windows.



**multiport serial adapter cable**

A device that provides four DB9 serial ports from a 36-pin connector.

**NFS edge serving**

A configuration in which CXFS client nodes can export data with NFS.

**node**

A *node* is an operating system (OS) image, usually an individual computer. (This is different from the NUMA definition for a brick/blade on the end of a NUMALink cable.)

A given node can be a member of only one pool and only one cluster. See also *client-only node*, *server-capable administration node*, and *standby node*.

**node ID**

An integer in the range 1 through 32767 that is unique among the nodes defined in the pool. You must not change the node ID number after the node has been defined. It differs from *cell ID*.

**node membership**

The list of nodes that are active (have CXFS kernel membership) in a cluster.

**notification command**

The command used to notify the cluster administrator of changes or failures in the cluster and nodes. The command must exist on every node in the cluster.

**owner host**

A system that can control a node remotely, such as power-cycling the node. At run time, the owner host must be defined as a node in the pool.

**owner TTY name**

The device file name of the terminal port (TTY) on the *owner host* to which the system controller is connected. The other end of the cable connects to the node with the system controller port, so the node can be controlled remotely by the owner host.

**peer-to-disk**

A model of data access in which the shared files are treated as local files by all of the hosts in the cluster. Each host can read and write the disks at near-local disk speeds; the data passes directly from the disks to the host requesting the I/O, without passing through a data server or over a LAN. For the data path, each host is a peer on the SAN; each can have equally fast direct data paths to the shared disks.

**physvol**

Physical volume. A disk that has been labeled for use by XVM. For more information, see the *XVM Volume Manager Administrator's Guide*.

**pool**

The set of nodes from which a particular cluster may be formed. Only one cluster may be configured from a given pool, and it need not contain all of the available nodes. (Other pools may exist, but each is disjoint from the other. They share no node or cluster definitions.)

A pool is formed when you connect to a given node and define that node in the cluster database using the CXFS GUI. You can then add other nodes to the pool by defining them while still connected to the first node, or to any other node that is already in the pool. (If you were to connect to another node and then define it, you would be creating a second pool).

**port password**

The password for the system controller port, usually set once in firmware or by setting jumper wires. (This is not the same as the node's `root` password.)

**potential metadata server**

A server-capable administration node that is listed in the metadata server list when defining a filesystem; only one node in the list will be chosen as the active metadata server.

**private network**

A network that is dedicated to CXFS kernel heartbeat messages, cluster database heartbeat messages, CXFS metadata, and control messages. The private network is accessible by administrators but not by users. Also known as *control network*.

**quorum**

The number of nodes required to form a cluster, which differs according to membership:

- For CXFS kernel membership:
  - A majority (>50%) of the server-capable administration nodes in the cluster are required to **form** an initial membership
  - Half (50%) of the server-capable administration nodes in the cluster are required to **maintain** an existing membership
- For cluster database membership, **50%** of the **nodes in the pool** are required to form and maintain a cluster.

**quorum master**

The node that is chosen to propagate the cluster database to the other server-capable administration nodes in the pool.

**RAID**

Redundant array of independent disks.

**recovery**

The process by which a node is removed from the CXFS kernel membership due to an interruption in CXFS services. It is during this process that the remaining nodes in the CXFS kernel membership resolve their state for cluster resources owned or shared with the removed node. See also *metadata server recovery*.

**relocation**

The process by which the metadata server moves from one node to another due to an administrative action; other services on the first node are not interrupted.

**reset**

The failure policy method that performs a system reset via the system controller.

**SAN**

Storage area network. A high-speed, scalable network of servers and storage devices that provides storage resource consolidation, enhanced data access, and centralized storage management.

**server-capable administration node**

A node that is installed with the `cluster_admin` product and is also capable of coordinating CXFS metadata.

**server-side licensing**

Licensing that uses license keys on the CXFS server-capable administration nodes; it does not require node-locked license keys on CXFS client-only nodes. The license keys are node-locked to each server-capable administration node and specify the number and size of client-only nodes that may join the cluster membership. All nodes require server-side licensing.

**shutdown**

The fail policy that tells the other nodes in the cluster to wait before reforming the CXFS kernel membership. The surviving cluster delays the beginning of recovery to allow the node time to complete the shutdown. See also *forced CXFS shutdown*.

**split cluster**

A situation in which cluster membership divides into two clusters due to an event (such as a network partition or an unresponsive server-capable administration node) and the lack of reset or CXFS tiebreaker capability. This results in multiple clusters, each claiming ownership of the same filesystems, which can result in filesystem data corruption. Also known as *split-brain syndrome*.

**snooping**

A security breach involving illicit viewing.

**split-brain syndrome**

See *split cluster*.

**spoofing**

A security breach in which one machine on the network masquerades as another.

**standby node**

A server-capable administration node that is configured as a potential metadata server for a given filesystem, but does not currently run any applications that will use that filesystem.

**static heartbeat monitoring**

Monitors CXFS kernel heartbeat constantly at 1-second intervals and declares a timeout after 5 consecutive missed seconds (default). See also *dynamic heartbeat monitoring*.

**storage area network**

See *SAN*.

**system controller port**

A port sitting on a node that provides a way to power-cycle the node remotely. Enabling or disabling a system controller port in the cluster database tells CXFS whether it can perform operations on the system controller port.

**system log file**

Log files in which system messages are stored.

**tiebreaker node**

See *CXFS tiebreaker node*.

**transaction rates**

I/O per second.

**user-space membership**

See *cluster database membership*.

**view area**

The portion of the GUI window that displays components graphically. See also *details area*.

**VLAN**

Virtual local area network.

**whitelisted**

A node that is explicitly allowed to be automatically configured into the cluster database.

**XFS**

A filesystem implementation type for the Linux operating system. It defines the format that is used to store data on disks managed by the filesystem.

---

## Index

64-bit scalability, 5  
100baseT, 36

### A

access control lists, 5  
ACLs, 5  
activate CXFS services  
    cxf\_admin, 251  
    GUI, 197  
ACTIVE cluster status, 365  
active metadata server, 15  
add a node  
    cxf\_admin, 242  
    GUI, 188  
adding clients, 106  
address resolution protocol (ARP), 468  
administration  
    avoiding a CXFS restart at reboot, 309  
    best practices, 72  
    cache utilization, 346  
    case-insensitive CXFS filesystems, 346  
    chkconfig, 296  
    client removal, 329  
    client restoration, 330  
    cluster database shutdown, 304  
    discovering the active metadata server, 301  
    disk layout optimization, 341  
    dump and restore, 312  
    failover and RAID units, 338  
    failover2.conf, 334  
    fencing and hardware changes, 313  
    file-layout analysis, 340  
    filestreams, 344  
    filesystem maintenance, 310  
    forced CXFS shutdown, 307  
    frame files defragmentation, 340  
    granting task execution privilege, 297  
    growing filesystems, 312  
    ideal frame layout, 341  
    initialization commands, 291  
    log file management, 310  
    manually starting/stopping CXFS, 316  
    metadata server removal, 316  
    metadata server restoration, 318  
    mount scripts, 298  
    mounting filesystems, 311  
    normal CXFS shutdown, 305  
    port usage, 295  
    precedence of configuration options, 282  
    private network failover configuration, 314  
    RAID prefetch and frame layout, 342  
    RAID units and XVM failover, 338  
    real-time applications, 342  
    relocation, 291  
    removing and restoring cluster members, 315  
    restarting CXFS, 332  
    revoke membership of local node, 307  
    rolling upgrades, 283  
    shutdown of the database and CXFS, 304  
    stopping CXFS, 331  
    switch manipulation, 292  
    tasks, 282  
    tools, 38, 39, 42, 44  
    transform an existing node into a client-only  
        node, 297  
    unmounting filesystems, 311  
    video streaming, 339  
    XVM failover v2, 333  
administration daemon, 130  
administration membership, 23  
advisory record locks, 9  
affinity, 334

- age, 371
- Aggregate Recover Transport, 393
- Aggregate Send, 393
- allocation of space, 5
- allow CXFS kernel membership
  - cxfs\_admin, 255
  - GUI, 201
- Altix XE310, Altix XE320, Altix XE340, 2
- applications and server-capable administration
  - nodes, 53
- architecture of server-capable administration
  - nodes, 50
- ARP, 468
- asynchronous buffering techniques, 5
- atime, 459
- authorization errors, 440
- autoconf, 239
- automatic configuration, 239
- avoiding a CXFS restart at reboot, 309
- AVT, 494

## B

- B-trees, 5
- back up the cluster database, 74
- backup private network, 50
- backups, 32, 74
- bandwidth
  - management, 32
  - scaling, 8
  - supported XFS features, 5
  - when to use CXFS, 6
- baseboard management controller
  - See "BMC", 465
- best practices
  - administration, 72
  - configuration, 47
- block size, 69, 503
- blue text in the GUI, 167
- BMC, 56, 465
- boot.lvm, 84

- bootcpuset, 66
- Brocade switch
  - FC cable connections, 99
  - firmware, 95
  - license, 97
  - password, 74
  - telnet access to, 96, 97
  - telnet session hang, 411
  - verification, 96
- BSD interfaces, 9
- buffer coherency, 15
- buffering disks, 8
- bulkstat, 76

## C

- cache utilization, 343, 346
- cad
  - messages, 434
  - options file, 130
  - ports, 295
  - process, 43, 131, 141
  - verify it is running, 141
- cad.options file, 130
- capacity of the system, 79
- case-insensitive CXFS filesystems, 346
- cbeutil, 45
- cdbBackup, 45, 351
- cdbconfig, 45
- cdbdelete, 352
- cdbreinit, 80, 379, 444
- cdbreinit error messages, 438
- cdbRestore, 45, 352
- cdbutil, 45, 391
- cell ID
  - adjustment, 318, 323
  - displayed by clconf\_info, 371
  - displayed by cxfs\_admin, 354
  - membership delivered messages, 397
- Cell Up, 393



- channel traffic, 413
- checklist, 507
- chkconfig settings , 296
- clconf\_info, 45, 303, 369, 388, 390
- clconf\_stats, 45
- clconfd
  - mounting filesystems, 311
  - not running, 408
  - options file, 134
  - process, 44
  - verify it is running, 141
- clconfd daemon death, 417
- clconfd-scripts directory, 298
- clconfd.options file, 134
- clearing the database, 444
- cli, 436
- client
  - restoration, 330
- client-only node
  - backups and, 74
  - gathering status from, 368
  - node type, 245
  - OS platforms, 2
  - preference for, 54
  - removal, 329
  - terminology, 14
  - tiebreaker, 55
- client\_timeout, 400
- clients cannot join the cluster, 411
- clients unable to remount filesystems, 403
- cluster (terminology), 11
- cluster administration daemons, 13, 43, 130
- cluster configuration tools, 379
- cluster daemon restart, 448
- cluster database
  - backup/restore, 349
  - definition of term, 4
  - membership, 23
  - membership quorum stability, 51
  - quorum, 51
  - shutdown, 304
  - terminology, 13
- cluster database backup, 74
- cluster database restart, 305
- cluster definition
  - cxfs\_admin, 258
  - GUI, 194
- cluster deletion
  - cxfs\_admin, 261
  - GUI, 196
- cluster display
  - cxfs\_admin, 261
  - GUI, 196
- cluster domain, 35
- cluster ID
  - changing, 79
  - cxfs\_admin, 258
  - GUI, 194
- cluster manager tools, 38
- cluster membership, 23
- cluster migration, 491, 493
- cluster mirror status error, 431
- cluster mode, 195
- cluster modification
  - cxfs\_admin, 259
  - GUI, 195
- cluster status
  - tools for troubleshooting, 381
  - verification, 365
- cluster tasks
  - cxfs\_admin, 257
  - GUI, 194
- cluster\_admin, 37
- cluster\_admin software product, 43
- cluster\_control, 37
- cluster\_control software product, 43
- cluster\_services, 37
- cluster\_services software product, 44
- cmond
  - errors, 430
  - process, 43, 141
  - verify it is running, 141
- CMS error messages, 417

- cms\_failconf, 45
  - cms\_local\_fail\_action, 483
  - cmsd, 454
  - colors and states, 174
  - command buttons, 167
  - commands, 291
  - communication paths, 455
  - compute power, 51
  - concat creation, 168
  - concatenated slice limit, 503
  - concatenation, 34
  - concepts for CXFS, 11
  - configuration best practices, 47
  - configuration checker (cxfs-config), 354
  - configuration checklist, 507
  - configuration consistency, 52
  - configuration overview, 125
  - configuration saving, 49
  - configuration tasks
    - cxfs\_admin
      - cluster deletion, 261
      - cluster display, 261
      - cluster tasks, 257
      - CXFS services, 251
      - cxfs tiebreaker, 260
      - define a switch, 273
      - delete a switch, 275
      - fail policy hierarchy, 246
      - fencing, 246
      - filesystem deletion, 270
      - filesystem mount/unmount, 268
      - metadata server relocation, 269
      - node deletion, 250
      - node display, 251
      - node tasks, 239
  - GUI
    - cluster definition, 194
    - cluster deletion, 196
    - cluster display, 196
    - cluster modification, 195
    - connectivity test, 193
    - CXFS services start/stop, 197
  - cxfs tiebreaker, 198
  - delete a switch, 205
  - display a node, 193
  - fence lowering, 206
  - fence raising, 206
  - filesystem deletion, 216
  - filesystem modification, 213
  - filesystem mount/unmount, 214
  - log configuration, 198
  - membership allow/revoke, 201
  - metadata server definition, 210
  - metadata server relocation, 217
  - node addition/removal, 189
  - node definition, 179
  - node deletion, 193
  - node modification, 189
  - node resets, 189
  - set up a new filesystem, 147
  - setting up a new cluster, 145
  - switch definition, 202
  - switch modification, 205
  - update switch port information, 205
- configuration tools, 51
  - configuration verification, 70
  - configure system files, 129
  - configure XVM volumes, 379
  - connection error, 440
  - connectivity diagnostics, 122, 126, 155, 193
  - contact a system controller, 257
  - contacting SGI with problems, 451
  - contiguous allocation of space, 5
  - control command, 255
  - control daemons, 44
  - control network
    - See "private network", 23
  - controller disable Messages, 417
  - corpseleader process, 454
  - cpu\_exclusive, 67
  - cpusets, 66
  - crash (ia64), 385
  - crash (x86-64), 383

- create a cluster
  - cxfs\_admin, 258
  - GUI, 194
- create a filesystem metadata server
  - cxfs\_admin, 263
  - GUI, 210
- create a node
  - cxfs\_admin, 242
  - GUI, 179
- cron jobs, 74
- crontab, 74
- crsd
  - errors, 429, 437
  - ports, 295
  - process, 43, 141
  - verify it is running, 141
- ctime, 459
- currentpath, 86
- cxdetail, 162
- CXFS client node, 15
- CXFS kernel and ports, 295
- CXFS kernel membership
  - allow/revoke
    - cxfs\_admin, 255
    - GUI, 201
  - current information, 390
  - cxfs\_admin, 255
  - residual cluster, 389
- CXFS Manager
  - See "GUI", 164
- CXFS services
  - overview, 29
  - start
    - cxfs\_admin, 251
    - GUI, 197
  - stop
    - cxfs\_admin, 251
    - GUI, 197
- CXFS shutdown (forced)
  - cxfs\_admin, 255
  - GUI, 201
  - overview, 307
- CXFS shutdown (normal), 251
  - GUI, 197
  - overview, 305
- CXFS tiebreaker node
  - cxfs\_admin, 260
  - GUI, 198
- cxfs\*mount.sh scripts, 298
- cxfs\*umount.sh scripts, 298
- cxfs-config, 45, 354
- cxfs-reprobe, 378
- cxfs-xvm-cmds, 37
- cxfs\_admin, 37
  - access, 223
  - access permissions, 230
  - advanced mode, 234
  - attributes, 225
  - basic mode, 234
  - c option, 238
  - class, 225
  - command history, 237
  - command line execution, 238
  - defaults, 227
  - editor style, 227
  - i option, 232
  - error behavior, 227
  - exiting, 239
  - filesystem tasks, 263
  - help, 232
  - interrupting a command, 237
  - invocation, 224
  - license information, 262
  - license verification, 115
  - line wrapping, 227
  - lock, 230
  - modes, 227, 234
  - multiple clusters, 232
  - network failover tasks, 271
  - object, 225
  - output is not current, 408
  - overview, 42, 223
  - permissions, 229

- prompting mode, 236
- read-only mode, 229
- related commands, 39
- safety, 230
- scripts, 153
- scripts and, 238, 279
- set command, 227
- show a filesystem, 270
- steal, 230
- switch tasks, 272
- syntax, 225
- <TAB> completion, 234
- tiebreaker, 260
- cxfs\_admin errors, 439
- .cxfs\_admin file, 228, 230
- CXFS\_ADMIN\_CLUSTER\_NAME, 228
- CXFS\_ADMIN\_EDITOR, 228
- CXFS\_ADMIN\_LINE\_WRAP, 228
- CXFS\_ADMIN\_MODE, 228
- CXFS\_ADMIN\_STOP\_ON\_ERROR, 228
- CXFS\_ADMIN\_WRITE\_MODE, 228, 230
- cxfs\_client process, 44
- cxfs\_client software product, 44
- cxfs\_client.options file, 232
- cxfs\_client\_push\_period, 483
- cxfs\_client\_range\_age\_max, 487
- cxfs\_cluster, 37
- cxfs\_dcvn\_timeout, 484
- cxfs\_extents\_delta, 484
- cxfs\_info, 368
- cxfs\_punch\_hole\_restrict, 484
- cxfs\_recovery\_slowdown, 488
- cxfs\_recovery\_timeout\_panic, 71, 488
- cxfs\_recovery\_timeout\_period, 71, 488
- cxfs\_recovery\_timeout\_stalled, 71, 489
- cxfs\_recovery\_timeout\_start, 71, 489
- cxfs\_relocation\_ok, 485
- cxfs\_server\_push\_period, 485
- cxfs\_server\_range\_age\_max, 489
- cxfs\_shutdown, 45
- CXFS\_SS license key, 104
- cxfs\_util, 37

- cxfsdp, 78
- cxfsd process, 454
- cxfsd\_max, 486
- cxfsd\_min, 486
- cxfsdump, 45, 387
- cxfslicense, 45, 113
- cxfsmgr, 38, 39, 158, 379
  - See "GUI", 162
- cxtask (cxfsmgr), 162

## D

- daemons
  - cluster administration, 43
  - list of, 453
  - overview, 13
  - restart, 448
  - verify, 141
- data flow, 459
- data integrity protection, 25, 56
- data management API, 30
- Data Migration Facility
  - See "DMF", 30
- data security, 64
- database
  - clearing, 444
  - dump, 391
  - membership, 23
  - shutdown, 304
- database backup, 74
- DB9 serial port, 472
- dcshake process, 454
- deactivate CXFS services
  - cxfs\_admin, 251
  - GUI, 197
- debugging parameters, 487
- define a cluster
  - cxfs\_admin, 258
  - GUI, 194
- defragmentation, 5, 75, 340

- defunct admin logins, 410
- delete a cluster
  - cxfs\_admin, 261
  - GUI, 196
- delete a filesystem
  - cxfs\_admin, 270
  - GUI, 216
- delete a node
  - cxfs\_admin, 250
  - GUI, 188, 192
- detach volume elements, 168
- details area, 165
- /dev/cxvm, 388
- device block size, 503
- df, 382
- df display problems, 412
- direct-to-disk I/O, 9
- disable heartbeat, 394
- disable nodes, 81
- disk blocks, free, 382
- disk buffering, 8
- disk configuration, 172
- disk layout optimization, 82, 341
- disk management, 32
- disk unlabling, 168
- disk volume header (DVH) labels, 31
- display a cluster
  - cxfs\_admin, 261
  - GUI, 196
- display nodes
  - cxfs\_admin, 251
  - GUI, 193
- DMAPI, 30, 300
- DMF, 30, 85, 299
- dmi mount option, 85, 300
- DNS, 119, 142
- domain, 35
- DOWN node state, 366
- downrev error, 441
- drag-and-drop, 171, 172
- dump analysis (ia64), 385
- dump analysis (x86-64), 383

- dump from metadata server, 312
- dump of the database, 391
- DVH labels, 31
- dynamic heartbeat monitoring, 70
- dynamic parameters for debugging purposes, 487
- dynamic TCP port assignment, 411

## E

- easy client configuration, 240
- edge serving, 7
- Edit menu, 166
- EINTR, 413
- enhanced NFS, 33
- enterprise client license key, 105
- entitlement ID, 110
- ERROR cluster status, 365
- error messages, 393
- /etc/exports, 129
- /etc/fstab, 4, 310
- /etc/hosts file, 119
- /etc/init.d
  - See "service", 316
- /etc/lis.so.conf, 396
- /etc/mstab, 4
- /etc/nsswitch.conf file, 118
- /etc/projects, 33
- /etc/projid, 33
- /etc/services file, 130
- /etc/sysctl.conf, 67
- Ethernet network, 16
- examples
  - administrative communication within one node, 455
  - communication between nodes in the pool , 457
  - communication for a node not in a cluster, 458
  - communication paths, 455
  - cxfs\_admin scripts, 238
  - daemon communication within one server-capable administration node, 456

- /etc/hosts file, 119
  - /etc/inet/hosts file, 119
  - fs2d logging and tracing, 133
  - fs2d options, 133
  - GUI initial window, 144
  - GUI screens, 163
  - ifconfig, 154
    - Linux, 121
  - metadata flow, 460
  - metadata server distribution, 17
  - name services, 119
  - ping
    - Linux, 121
  - ping output, 154
  - pool and cluster concepts, 13
  - private network interface test, 154
    - Linux, 121
  - relocation versus recovery, 28
  - verify cluster daemons are running, 141
  - exclusive write tokens, 82
  - exporting a CFS filesystem, 16
  - exports file , 129
  - extent deltas, 442
  - EXTENT errors, 442
  - extent lists systune, 484
  - extent tracking, 82
  - external log filesystems, 5
- F**
- fail policies, 64
  - failover V2, 35
  - failover2.conf, 334
  - failover2.conf generation, 336
  - failover\_net network, 314
  - Failure time-stamp, 394
  - fam, 77
  - fast copy, 78
  - faster login for switch, 74
  - FC cable connections and Brocade switch, 99
  - fdisk, 124
  - features, 8
  - fenced node determination, 389
  - fencing, 25
    - lower (enable access)
      - cxfs\_admin, 278
      - GUI, 206
    - raise (disable access)
      - cxfs\_admin, 278
      - GUI, 206
  - fencing and hardware changes, 313
  - fencing and security of data, 58
  - fencing port requirements, 295
  - fencing status, 371
  - file access is slow, 409
  - file locking, 15
  - File menu, 162, 166
  - file size/offset maximum, 503
  - file-layout analysis, 340
  - file-sequence reorganization, 340
  - filestreams mount option, 83, 85, 344
  - filesystem block size, 503
  - filesystem comparison, network and CXFS, 7
  - filesystem configuration, 69
  - filesystem creation, 3
    - GUI, 207
  - filesystem defragmenter software, 75
  - filesystem deletion
    - cxfs\_admin, 270
    - GUI, 216
  - filesystem features of XFS supported by CXFS, 5
  - filesystem fullness, 84
  - filesystem growth, 312
    - GUI, 209
  - filesystem is inaccessible, 396
  - filesystem local-host access, 6
  - filesystem maintenance, 310
  - filesystem manager, 4
  - filesystem metadata server definition
    - GUI, 210
  - filesystem modification
    - GUI, 213

- filesystem mounting
  - cxfs\_admin, 268
  - GUI, 214, 215
  - overview, 311
  - XFS differences, 4
- filesystem mounting problems, 399
- filesystem network access, 6
- filesystem reorganizer, 5
- filesystem repair, 75
- filesystem response times, 5
- filesystem restriction of access, 5
- filesystem specifications, 503
- filesystem structure, 3
- filesystem tasks
  - GUI, 207
  - guided configuration, 147
- filesystem unmounting
  - cxfs\_admin, 269
  - GUI, 214–216
  - overview, 311
  - server-capable administration node
    - addition/deletion, 54
- filesystem view, 1
- find and crontab, 74
- Find text field, 169
- firewalls, 295
- firmware for switches
  - Brocade, 95
- forced CXFS shutdown, 29, 307
  - GUI, 197
- forced CXFS shutdown and restart, 80, 309
- forced filesystem shutdown messages, 403
- forced shutdown, 63
- forced unmount
  - GUI, 215
  - recommended, 69
- frame files defragmentation, 340
- frame layout with RAID prefetch, 342
- framesort, 340
- free disk blocks, 382
- fs2d
  - database membership, 23

- errors, 432, 438
- options file, 131
- ports, 295
- process, 43, 141
- verify it is running, 141
- fs2d membership
  - See "CXFS kernel membership", 23
- fs2d quorum master, 390
- fs2d.options file, 131
- fs2d\_log, 51, 388
- fsr, 75, 76
- fsr\_xfs, 5
- fstab, 4, 310
- function of a node, 180, 245
- fx, 150

## G

- gather cluster configuration information, 387
- gigabit ethernet, 36
- GPT labels, 31
- GPT labels with one partition, 31
- GPT partition tables, 124
- grant task access, 218
- granting task execution privilege, 297
- gratuitous ARP, 468
- GRIO, 10
- grio2, 136
- grio2-cmds, 37
- grio2-server, 37
- grioadmin, 32
- griomon, 32
- grioqos, 32
- GRIOV2, 31, 105
  - disabling after reboot, 136
  - disabling for the current session, 137
  - enabling after a reboot, 136
  - enabling for the current session, 136
- GRIOV2 errors, 442
- GRIOV2 license, 105

- group memberships, 124
- grow a filesystem
  - GUI, 209
- growing filesystems, 312
- guaranteed-rate I/O, 10
- guaranteed-rate I/O (GRIO) version 2
  - See "GRIOv2", 31
- GUI, 39
  - configuring with, 143
  - multiple instances, 162
  - overview, 38, 164
  - starting, 161
  - tasks
    - See "configuration tasks", 157
  - web-based version, 159
- GUI and xvm command differences, 173
- GUI connection error, 396
- GUI displays invalid filesystems, 400
- GUI help, 173
- GUI invocation, 158
- GUI will not run, 405
- GUID partition table (GPT) labels, 31
- guided configuration tasks, 165

## H

- HA, 3
- HA features, 3
- HA services, 30
- ha fence, 45, 292
- hardware changes, 313
- hardware inventory, 376
- hardware requirements, 36
- hardware reset
  - See "reset", 56
- haStatus, 45
- HBA, 36
- heartbeat monitor, 394
- heartbeat monitor systune, 481
- heartbeat monitoring, 70
- heartbeat network, 23, 181

- Heartbeat Processing, 394
- heartbeat systune, 480
- Heartbeat timeout, 394
- heartbeat timeout, 23
- heartbeat timing, 24
- help
  - for cxfs\_admin, 232
  - for GUI, 145
- Help button, 39
- Help menu, 167
- hierarchical storage management, 30
- high availability services, 30
- host bus adapter, 58
- hostname, 181
- hostname resolution, 117
- hostname/IP-address pairings, 145
- hosts file, 119
- hsm, 30
- hub, 36
- hung system, 397
- hung telnet session, 411
- hwinfo, 376
- hyperthread and multi-core processors, 103

## I

- I/O error in filesystem, 399
- I/O fencing, 25, 57
- I/O fencing and integrity of data, 58
- I/O operations, 6
- I/O overhead, 51
- icons and states, 174
- ideal frame layout, 341
- ifconfig, 154
  - Linux, 121
- ifconfig and error messages, 412
- INACTIVE
  - cluster status, 365
  - node state, 366
- incarnation, 371



InfiniteStorage Software Platform (ISSP), 29

initial cluster configuration

- cxfs\_admin, 148
- GUI, 143

initial configuration, 139

initial configuration checklist, 507

initialization commands, 291

input instructions, 173

installation overview, 125

installation verification, 126

Intelligent Platform Management Interface

- See "IPMI", 465

intelplus, 407

internode communication, 118

interoperability, 29

introduction, 1

inventory file, 312

iostat, 382

IP address and private network, 181

IP address error, 420

IP address, changing, 117

IP-address/hostname pairings, 145

ipfilterd, 36

IPMI, 465

IPMI issues, 405

ipmitool, 72, 406, 465

IRIX and Linux system administration

- differences, 493

ISSP, 29

item view

- See "details view", 165

IX brick, 472

## J

Java access to GUI, 40

jumbo frames, 36

## K

kernel heartbeat issues, 66

kernel memory parameters, 67

kernel threads, 453

Knowledgebase, 451

kswapd, 67

## L

L2, 248

L2 networks, 66

L2 system controller , 465, 472

label disks, 167

LAN, 7

lanplus, 407

large cluster, 54

large cluster configuration, 152

large clusters, 146

Last heartbeat time-stamp, 394

Legato NetWorker, 33

libcdb, 45

library for record locking, 9

license

- Brocade, 97
- GUI and, 405

license key error, 419

licenses

- cxfs\_admin, 262
- upgrading, 284

licensing

- client license key classes, 105
- CXFS\_SS key, 104
- enterprise client license keys, 105
- entitlement ID, 110
- examples, 107
- gathering host information, 110
- key replication, 106
- lk\_hostid, 110
- node-locked license keys, 103

- number of keys, 106
- obtaining keys, 110
- requirements, 104
- server-side licensing, 103
- SGI webpage, 116
- verifying the keys
  - cxfs\_admin, 115
  - cxfslicense, 113
  - lk\_verify, 111
- workstation client license keys, 105
- XVM, 105

limitations and considerations for server-capable administration nodes, 123

Linux

- ifconfig, 121

Linux and IRIX system administration differences, 493

lk\_verify, 111

local area networks (LANs), 7

local domain, 35

local node, 306

local node failure systune, 483

local XVM, 84

locate, 74

locks, 9

log configuration

- GUI, 198

log files, 387

- consume too much disk space, 396
- errors, 433
- list of, 364
- management, 310
- monitoring, 364
- names, 78
- sizes, 79

log in problems, 398

log-based filesystem, 5

logging fs2d options, 132

logical unit number (LUN), 11

logical volume creation, 150

logical volume reconfiguration, 171

lost CXFS membership, 418

- lower a fence
  - cxfs\_admin, 278
- lower command, 278
- ls, 74
- LSI drivers, 72
- lsiutil, 377
- LUN, 11
- LUN flipping, 409
- LUN limit, 503
- LUN management, 32
- LUN numbers supported, 91

## M

- Mac OS X, 2
- maintenance, 282
- maintenance levels, 66
- maintenance on nodes, 81
- make a filesystem
  - GUI, 207
- mandatory record locks, 9
- manually mounting filesystems, 153
- manually starting/stopping CXFS, 316
- mask and switch definition, 203
- matrix of supported CXFS software, 47
- media customers, 341
- media customers and disk layout optimization, 82
- membership
  - See "cluster database membership or CXFS kernel membership", 23
- membership delivered, 397
- membership loss, 393
- membership quorum stability, 51
- memory oversubscription, 67
- memory parameters, 67
- memory requirements, 50
- memory-mapped I/O issues, 85
- memory\_exclusive, 67
- memory\_spread\_{page,slab}, 67
- mesgtcpaccept process, 454

- mesgpcpdiscovery, 454
  - mesgpcpmulticast, 454
  - mesgpcprcv process, 454
  - Message Failure, 394
  - metadata
    - logging, 15
    - terminology, 2, 4, 11
    - transaction examples, 7
  - metadata flow, 459
  - metadata server
    - definition
      - GUI, 210
    - discovery, 301
    - model, 15
    - recovery, 27
    - relocation
      - cxfs\_admin, 269
      - GUI, 217
    - terminology, 4, 15
  - metadata server panics after reboot, 410
  - metadata server removal, 316
  - metadata server restoration, 318
  - migrating from an IRIX to an SGI Foundation
    - Software cluster, 491, 493
  - mirror creation, 168
  - mirror status error, 431
  - mirroring, 34
  - missing XVM volumes, 173
  - mkfs, 3, 147, 151
  - mkfs options, 87
  - mkfs.xfs —n version=ci, 347
  - mkinitrd fails, 412
  - mkpartsect, 124
  - mode of cluster, 195
  - modify a cluster
    - cxfs\_admin, 259
  - modify a filesystem
    - GUI, 213
  - modify a node
    - GUI, 189
  - monitoring
    - clconf\_info, 369
    - cxfs\_admin status, 366
  - monitoring tools, 382
  - mount
    - command, 4, 388
    - filesystems, 311
      - cxfs\_admin, 268
      - GUI, 214
    - options, 211
    - points, 211
    - see mounted filesystems, 382
  - mount a filesystem
    - GUI, 215
  - mount errors, 440
  - mount scripts, 298
  - mounted filesystems, showing, 382
  - mtcp\_hb\_local\_options, 480
  - mtcp\_hb\_period, 480
  - mtcp\_hb\_watchdog, 481
  - mtcp\_mesg\_validate, 487
  - mtcp\_nodelay, 481
  - mtcp\_rpc\_thread, 482
  - mtime, 459
  - multiOS cluster, 58
  - multiple ethernet interfaces, 403
  - multiple private networks and error messages, 412
  - multiple streams of real-time applications, 342
  - multiple-streams of real-time applications, 342
- N**
- name restrictions, 117
  - named pipes, 9
  - NetBackup, 33
  - network
    - interface configuration, 118
  - network connectivity
    - GUI, 193
  - network filesystem comparison, 7
  - network issues, 48
  - network requirements, 36

- network switch, 36
  - NetWorker, 33
  - networking tools, 381
  - networks, 23
  - new features summary, 509
  - new server-capable administration node, 318
  - NFS, 8, 33
  - NFS edge serving, 7
  - NFS exporting, 16, 129, 298
  - NFS fileserving network and private network, 50
  - NFS serving, 50
  - NIS, 119, 142
  - NMI a node, 256
  - NMI hangs, 410
  - NMI reset method, 57
  - no direct attachment, 31
  - node
    - isolation, 64
    - state, 365
    - status, 365
    - tasks
      - See "configuration tasks", 179
    - terminology, 1, 11
  - node addition
    - GUI, 188
  - node definition
    - cxfs\_admin, 242
    - GUI, 179
  - node deletion
    - cxfs\_admin, 250
    - GUI, 192
  - node display
    - cxfs\_admin, 251
    - GUI, 193
  - node function, 180, 245
  - node ID changes, 79
  - node ID, changing, 79
  - Node is Detected but Never Joins Membership, 397
  - node is downrev error, 441
  - node is not reset, 407
  - node is permanently fenced, 395
  - node membership loss, 408
  - node modification
    - GUI, 189
  - node removal, 77
  - node reset
    - cxfs\_admin, 255
    - GUI, 189
  - node shutdown, 76
  - node status
    - database shutdown, 305
    - forced CXFS shutdown, 308
  - node status and forced shutdown, 308
  - node status tools, 381
  - node tasks
    - cxfs\_admin, 239
    - GUI, 179
  - node-locked license keys, 104
  - normal CXFS shutdown, 197
  - notify administrator of cluster changes
    - GUI, 195
  - nsd, 142
  - nsswitch.conf file, 118
  - NT nodes, 34
  - NTP, 84
  - number of nodes supported, 35
- O**
- O\_EXCL, 124
  - old cluster, 389
  - osview, 79
  - out of logical swap space, 418
  - output to gather, 451
  - oversubscription of memory, 67
  - overview, 125
- P**
- packages installed
    - administration, 37

- panic after reboot, 410
- parted, 124
- partition, 247
- partition of network and reset of hardware, 63
- password for switch, 74
- path locations, 463
- pcp-gui, 373
- pcp-sgi, 374
- peer-to-disk model, 8
- perform tasks, 170
- Performance Co-Pilot, 383
  - XVM statistics, 373
- performance monitoring tools, 382
- physical LUN limit, 503
- physical storage tools, 376
- physical volumes, showing, 379
- ping, 121, 154
- ping a system controller, 257
- ping and BMC, 406
- pipes (named), 9
- pmdumptext, 373
- pmgxvm, 374
- pmie, 383
- pmieconf, 383
- pool, 12
- port usage, 295
- portmapper issues, 411
- POSIX pathname, 9
- potential metadata server, 15
- power cycle reset method, 57
- power-cycle a node, 256
- power-cycling a Node, 450
- precedence of configuration options, 282
- preferred path in failover2.conf, 334
- preferred XVM path, 86
- preinstallation steps, 117
- preliminary steps, 140
- private network, 23, 49, 118, 181
  - interface test
    - Linux, 121
- private network failover configuration, 314
- private network interface test, 154

- private network required, 36
- Privilege Manager, 161
- problem location, 390
- problem reporting, 451
- problem solving, 84

## Q

- QLogic FC switch, 99
- quality-of-service monitoring tool, 32
- query fence status, 278
- quorum, 51
- quorum leader, 390
- quorum leader and ports, 295
- quorum master, 390
- quorum stability, 51
- quotas, 5, 33

## R

- race to reset, 63
- RAID, 11
  - firmware, 90
  - hardware, 89
  - verification, 93
- RAID prefetch and frame layout, 342
- RAID units and XVM failover, 338
- raise a fence
  - cxfs\_admin, 278
  - GUI, 206
- raise command, 278
- RDAC, 494
- read and metadata
  - flow, 459
- real-time applications, 342
- real-time filesystems, 10
- reboot panic, 410
- rebooting, 445
- rebooting without rejoining the cluster, 445

- Receive Thread, 394
- reconfigure a cluster, 389
- record locks, 9
- record-locking library, 9
- recovering a two-node cluster, 446
- recovery, 76
  - features, 34
  - filesystem and XFS, 5
  - of the metadata server, 27
  - terminology, 27
- Recovery process, 454
- recovery timeout mechanism, 71
- recreating the cluster database, 448
- recreating the cluster using `cxfs_admin` scripts, 280
- Red Hat Enterprise Linux (RHEL), 2
- reinitialize the database, 379
- rejoin the cluster
  - forced CXFS shutdown, 308
  - normal CXFS shutdown, 307
- rejoining the cluster after a forced shutdown, 308
- rejoining the cluster after stopping CXFS, 307
- release history, 509
- reliability of the filesystem, 5
- relocate a metadata server
  - `cxfs_admin`, 269
  - GUI, 217
- relocation, 26, 76, 291
- relocation error, 411, 416
- remove a cluster
  - `cxfs_admin`, 261
  - GUI, 196
- remove a filesystem
  - `cxfs_admin`, 270
  - GUI, 216
- remove a nod
  - `cxfs_admin`, 250
- remove a node
  - GUI, 188, 192
- removed node, 80
- removing and restoring cluster members, 315
- reorganizer, 5
- reporting problems, 451
- requirements, 36
- reset, 36
  - removing, 81
- reset a database, 444
- reset a node, 256
  - `cxfs_admin`, 255
  - GUI, 189
- reset capability and forced shutdown, 309
- reset configurations, 465
- reset connection test, 154
- reset lines, 81
- reset methods, 56
- reset race, 63
- reset services daemon, 130
- `reset_comms`, 255
- `reset_device`, 255
- `reset_node`, 255
- `reset_password`, 255
- `reset_port`, 255
- resetting a node, 450
- residual cluster, 389
- restart (avoiding), 309
- restart at reboot, 309
- restart cluster daemons, 448
- restart the cluster database, 305
- restarting CXFS, 332
- restarting CXFS services, 443
- restore, 312
- restrictions with CXFS filesystems, 9
- revoke CXFS kernel membership
  - GUI, 201
- revoke membership of local node, 307
- `rfind`, 74
- RHEL, 2
- `rhelcd_min`, 482, 483
- RM610/660 and XVM failover, 339
- root filesystem and CXFS, 9
- rotating log files, 310
- RPC port mapper, 295

**S**

- S330 and XVM failover, 339
- Samba, 8, 33, 72
- Samba fileserving network and private network, 50
- Samba serving, 50
- SAN
  - documentation, 507
  - use of, 1
- sar, 382
- saving changes, 49
- scalability (64 bit0), 5
- scripts
  - cxfs\_admin, 238
  - pre/post-mount scripts, 298
- scripts for cxfs\_admin, 279
- selecting items to view or modify, 169, 218, 221
- server-capable administration node, 245
  - terminology, 13
- server-capable administration node numbers, 53
- server-side licensing, 103
- service cluster, 316
- service cxfs\_client, 316
- service cxfs\_cluster, 316
- services file, 130
- set up a new cluster, 145
- SGI Foundation Software, 2
- SGI InfiniteStorage RAID, 89
- SGI Knowledgebase, 451
- SGI ProPack, 2
- SGI RMxxx RAID, 89
- SGI S330, 89
- SGI TPxxxx RAID, 89
- sgi-cad, 130
- sgi-crsd, 130
- sgi-cxfs-server-kmp-KERNELTYPE, 38
- sgi-enhancedxfs-kmp-KERNELTYPE, 37
- sgi-sysadm\_base-client, 37
- sgi-sysadm\_base-lib, 37
- sgi-sysadm\_base-server, 37
- sgi-sysadm\_cluster\_base-client, 37
- sgi-sysadm\_cluster\_base-server, 37
- sgi-sysadm\_cxfs-client , 37
- sgi-sysadm\_cxfs-server, 37
- sgi-sysadm\_cxfs-web, 37
- sgi-sysadm\_xvm-client, 37
- sgi-sysadm\_xvm-server, 37
- sgi-sysadm\_xvm-web, 37
- SGIAVT, 35, 494
- SGIAVT mode, 339
- SGIRDAC, 35, 494
- shortcuts, 167
- show a cluster
  - cxfs\_admin, 261
  - GUI, 196
- show a node
  - cxfs\_admin, 251
  - GUI, 193
- show switches, 275
- shut down nodes unobtrusively, 76
- shutdown, 61
  - cluster database, 304
  - forced CXFS cluster database, 307
  - normal, 305
  - normal CXFS
    - cxfs\_admin, 246
    - GUI, 197
    - restart and, 80, 309
  - shutdown failure, 416
- single filesystem view, 1
- single-system view, 2
- site-changeable system tunable parameters, 479
- size of the cluster, 35
- SLES, 2
- slice disk, 167
- slow file access, 409
- snooping, 24
- software mix, 52
- software requirements, 36
- software upgrades, 77
- space
  - allocation, 5
- speed, 5

- split cluster, 62
- split-brain syndrome
  - See "split cluster", 55
- spoofing, 24
- standby node, 17, 76
- start
  - CXFS processes, 316
- start CXFS, 81
- start CXFS services, 307
  - cxfs\_admin, 251
  - GUI, 197
- state in the GUI, 172
- static heartbeat monitoring, 70
- statistics for an XVM volume, 382
- status
  - cluster, 365
  - node, 365
  - system, overview, 363
- stop CXFS services
  - cxfs\_admin, 251
  - GUI, 197
- stopping CXFS, 331
- storage area network, 1
- storage management, 32, 71
- storage tools, 376
- stream management, 32
- streaming workload for video streams, 339
- stripe creation, 168
- striping, 34
- subnet, 23, 50
- subvolume creation, 168
- summary of new features, 509
- Supportfolio, 451
- SUSE Linux Enterprise Server (SLES), 2
- SuSEfirewall2, 122
- swap to a file, 10
- switch, 58
  - Brocade, 95
  - definition
    - cxfs\_admin, 273
    - GUI, 202
  - display, 275
  - QLogic, 99
  - recommendations, 36
- switch access problems, 410
- switch definition
  - GUI, 202
- switch deletion
  - cxfs\_admin, 275
  - GUI, 205
- switch logs, 391
- switch modification
  - GUI, 205
- switch password, 74
- switch port information
  - GUI, 205
- switch telnet port, 84
- switch use, 68
- switchshow, 401
- sysadmd, 45
- sysadmdesktop, 161
- SYSLOG, 166, 312
- SYSLOG errors, 421
- syslogdipadd, 391
- system
  - files, 129
  - software communication paths, 455
  - status, 363
  - view, 2
- system activity, 382
- system administration differences between IRIX and Linux, 493
- system capacity, 79
- system controller types, 248
- system dump analysis (ia64), 385
- system dump analysis (x86-64), 383
- system hang, 397
- system log file, 166
- system reset
  - See "reset", 56
- system reset configurations, 465
- system tunable parameters, 83
  - site-changeable dynamic, 483



site-changeable static, 480  
System V interfaces, 9

## T

tasks, 170  
Tasks menu, 166  
TCP port, 295  
TCP/IP network, 16  
TCP/IP network requirements, 36  
telnet, 36  
    limit simultaneous sessions for Brocade, 97  
telnet and fencing, 99  
telnet and I/O fencing, 58  
telnet port, 84  
telnet port and I/O fencing, 58  
telnet session hung, 411  
temporary names, 168  
term definitions, 173  
terminology, 11  
test connectivity  
    GUI, 193  
Test Connectivity task, 390  
test the system, 153  
tgconfig, 36  
threads, 453  
tiebreaker  
    cxfs\_admin, 260  
tiebreaker node, 26  
    cxfs\_admin, 260  
    GUI, 198  
tiebreakers, 55  
tigon, 36  
time synchronization, 84  
Time-stamp delta, 394  
tokens, 82, 459  
tools, 38  
    cluster configuration, 379  
    cluster control, 380  
    cluster information, 387  
    cluster status, 381  
    networking, 381  
    node status, 381  
    performance monitoring, 382  
    physical storage tools, 376  
    system activity, 382  
    system dump analysis (ia64), 385  
    system dump analysis (x86-64), 383  
    troubleshooting, 376  
TP9100 and XVM failover, 339  
TP9300 and XVM failover, 339  
TP9500 and XVM failover, 339  
TP9700 and XVM failover, 339  
TPxxxx RAID, 89  
transaction rate, 5  
transaction rates, 7  
tree view  
    See "view area", 165  
troubleshooting  
    cluster database membership quorum  
        stability, 51  
    common problems, 391  
    corrective actions, 442  
    exclusive write tokens, 82  
    fenced node, 389  
    GUI use, 51  
    identify cluster status, 388  
    locate the problem, 390  
    log files, 387  
    messages, 412  
    normal messages, 413  
    quorum master, 390  
    reboot before changing node ID or cluster ID, 79  
    redirect switch logs, 391  
    removing reset, 81  
    reporting problems to SGI, 451  
    residual cluster, 389  
    restart CXFS after a forced CXFS shutdown, 80  
    strategy, 375  
    tools, 376  
    unwritten extent tracking, 82  
    using SGI Knowledgebase, 451

- xfs\_repair appropriate use, 75
- tunable parameters, 83

## U

- UDP port, 295
- unable to define a node, 397
- UNKNOWN cluster status, 365
- UNKNOWN node state, 366
- unlabel disks, 168
- unmount (forced)
  - GUI, 215
  - recommended, 69
- unmount a filesystem
  - cxfs\_admin, 269
  - GUI, 215, 216
- unmount scripts, 298
- unmounting filesystems, 311
- unwritten extent tracking, 82
- UP node state, 365
- upgrade procedure, 285
- upgrading
  - transform an existing node into a client-only node, 297
- upgrading licenses, 284
- user jobs and server-capable administration nodes, 74
- user-space membership, 23

## V

- validation tool, 45
- /var/adm/SYSLOG, 166
- /var/cluster/clconfd-scripts directory, 298
- /var/cluster/ha/log/fs2d\_log, 388
- /var/log/messages, 166
- /var/xfsdump/inventory, 312
- verification of installation, 126
- verify cluster daemons are running, 141

- verifying connectivity in a multicast environment, 448
- VERITAS NetBackup, 33
- video streams, 339
- view area, 165
- view cluster components, 169
- view component details, 170
- VLAN, 50
- vmstat, 382
- volume creation, 150, 168
- volume element detach, 168
- volume header creation, 150
- volume management, 34
- volume manager, 37
- volume topologies, 171
- volume-element deletion, 168

## W

- web browser access to GUI, 40
- web-based version of the GUI, 159
- weighted node
  - See "server-capable administration node", 16
- what is CXFS?, 1
- when to use CXFS, 6
- Windows, 3
- Windows nodes, 34
- workstation client license key, 105
- worldwide node name, 58
- worldwide port name, 400
- write and metadata flow, 459
- write tokens, 82
- WWN discovery, 332
- WWNN, 58
- WWPN, 400

**X**

X/Open Data Storage Management Specification, 30

**XFS**

comparison to CXFS, 3

features supported, 5

**xfs**

quotas, 33

XFS internal errors, 402

XFS version 1 directory format, 124

xfs\_fsr, 5, 75

xfs\_growfs, 312

xfs\_repair, 75

xfs\_repair appropriate use, 75

xfsd, 453

xfsdump and xfsrestore, 312

xpmem, 66

XSDM, 30

XVM, 34

logical volume creation, 150

requirement, 37

xvm, 379, 382, 388, 389

XVM cluster mirror status error, 431

xvm dump, 49

XVM failover

RAID units, 338

TP9100, RM610/660, and , 339

TP9300, TP9500, TP9700, and S330 and, 339

XVM failover V2, 35

commands, 338

concepts, 333

examples, 336

failover2.conf, 334

XVM failover version 1, 10

XVM in local mode, 84

XVM label corruption, 49

XVM license, 105

XVM path, 86

XVM repair, 49

XVM shortcuts, 167

XVM statistics, 373

XVM volume mapping to storage targets, 332

XVM volumes, 379

xvmgr, 39

**Y**

YaST configuration, 50

**Z**

zoning, 25