

**SONY®**

# ***TFT LCD Color Computer Display***

---

***SDM-P234***

# Owner's Record

The model and serial numbers are located at the rear of the unit. Record these numbers in the spaces provided below. Refer to them whenever you call upon your dealer regarding this product.

Model No. \_\_\_\_\_ Serial No. \_\_\_\_\_

## WARNING

**To prevent fire or shock hazard, do not expose the unit to rain or moisture.**

**Dangerously high voltages are present inside the unit. Do not open the cabinet. Refer servicing to qualified personnel only.**

### FCC Notice

This equipment has been tested and found to comply with the limits for a Class B digital device, pursuant to Part 15 of the FCC Rules. These limits are designed to provide reasonable protection against harmful interference in a residential installation. This equipment generates, uses, and can radiate radio frequency energy and, if not installed and used in accordance with the instructions, may cause harmful interference to radio communications. However, there is no guarantee that interference will not occur in a particular installation. If this equipment does cause harmful interference to radio or television reception, which can be determined by turning the equipment off and on, the user is encouraged to try to correct the interference by one or more of the following measures:

- Reorient or relocate the receiving antenna.
- Increase the separation between the equipment and receiver.
- Connect the equipment into an outlet on a circuit different from that to which the receiver is connected.
- Consult the dealer or an experienced radio/TV technician for help.

You are cautioned that any changes or modifications not expressly approved in this manual could void your authority to operate this equipment.

### IMPORTANTE

Para prevenir cualquier mal funcionamiento y evitar daños, por favor, lea detalladamente este manual de instrucciones antes de conectar y operar este equipo.

**If you have any questions about this product, you may call; Sony Customer Information Services Center  
1-800-222-7669 or <http://www.sony.com/>**

### Declaration of Conformity

Trade Name: SONY  
Model: SDM-P234  
Responsible Party: Sony Electronics Inc.  
Address: 16450 W. Bernardo Dr,  
San Diego, CA 92127 U.S.A.  
Telephone Number: 858-942-2230

This device complies with part 15 of the FCC rules. Operation is subject to the following two conditions: (1) This device may not cause harmful interference, and (2) this device must accept any interference received, including interference that may cause undesired operation.



BZ03

### NOTICE

This notice is applicable for USA/Canada only. If shipped to USA/Canada, install only a UL LISTED/CSA LABELLED power supply cord meeting the following specifications:

#### SPECIFICATIONS

Plug Type	Nema-Plug 5-15p
Cord	Type SVT or SJT, minimum 3 × 18 AWG
Length	Maximum 15 feet
Rating	Minimum 7 A, 125 V

### NOTICE

Cette notice s'applique aux Etats-Unis et au Canada uniquement.

Si cet appareil est exporté aux Etats-Unis ou au Canada, utiliser le cordon d'alimentation portant la mention UL LISTED/CSA LABELLED et remplissant les conditions suivantes:

#### SPECIFICATIONS

Type de fiche	Fiche Nema 5-15 broches
Cordon	Type SVT ou SJT, minimum 3 × 18 AWG
Longueur	Maximum 15 pieds
Tension	Minimum 7 A, 125 V

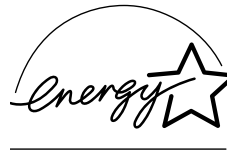











As an ENERGY STAR Partner, Sony Corporation has determined that this product meets the ENERGY STAR guidelines for energy efficiency.



This monitor complies with the TCO'99 guidelines.

# Table of Contents

Precautions .....	4
Identifying parts and controls .....	5
<b>Setup .....</b>	<b>7</b>
<b>Setup 1:</b> Connect the video signal cables .....	7
<b>Setup 2:</b> Connect the audio cord .....	8
<b>Setup 3:</b> Connect the speakers or headphones .....	8
<b>Setup 4:</b> Connect the power cord .....	8
<b>Setup 5:</b> Bundle the cords and cables .....	9
<b>Setup 6:</b> Turn on the monitor and computer .....	9
<b>Setup 7:</b> Adjust the tilt .....	10
Selecting the input signal (INPUT) .....	11
<b>Customizing Your Monitor .....</b>	<b>12</b>
Navigating the menu .....	12
 PICTURE ADJUST menu .....	13
 SCREEN menu (analog RGB signal only) .....	14
 COLOR menu .....	15
 GAMMA menu .....	16
 ZOOM menu .....	16
 MENU POSITION menu .....	17
 INPUT SENSING ON/OFF menu .....	17
 LANGUAGE menu .....	17
 RESET menu .....	17
 MENU LOCK menu .....	18
 OPTION menu .....	18
<b>Technical Features .....</b>	<b>19</b>
Power saving function .....	19
Reducing the power consumption (ECO mode) .....	19
Automatic brightness adjustment function (light sensor) .....	19
Automatic picture quality adjustment function (analog RGB signal only) .....	20
<b>Troubleshooting .....</b>	<b>21</b>
On-screen messages .....	21
Trouble symptoms and remedies .....	22
Self-diagnosis function .....	24
<b>Specifications .....</b>	<b>25</b>

GB

- Macintosh is a trademark licensed to Apple Computer, Inc., registered in the U.S.A. and other countries.
- Windows® is registered trademark of Microsoft Corporation in the United States and other countries.
- IBM PC/AT and VGA are registered trademarks of IBM Corporation of the U.S.A.
- VESA and DDC™ are trademarks of the Video Electronics Standards Association.
- ENERGY STAR is a U.S. registered mark.
- Adobe and Acrobat are trademarks of Adobe Systems Incorporated.
- All other product names mentioned herein may be the trademarks or registered trademarks of their respective companies.
- Furthermore, “™” and “®” are not mentioned in each case in this manual.

## Precautions

### Warning on power connections

Use the supplied power cord. If you use a different power cord, be sure that it is compatible with your local power supply.

#### For the customers in the U.S.A.

If you do not use the appropriate cord, this monitor will not conform to mandatory FCC standards.

#### For the customers in the UK

If you use the monitor in the UK, be sure to use the appropriate UK power cord.

Example of plug types

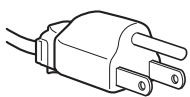

for 100 to 120 V AC

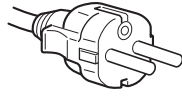

for 200 to 240 V AC

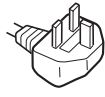

for 240 V AC only

The equipment should be installed near an easily accessible outlet.

### Installation

Do not install or leave the monitor:

- In places subject to extreme temperatures, for example near a radiator, heating vent, or in direct sunlight. Subjecting the monitor to extreme temperatures, such as in an automobile parked in direct sunlight or near a heating vent, could cause deformations of the casing or malfunctions.
- In places subject to mechanical vibration or shock.
- Near any equipment that generates a strong magnetic field, such as a TV or various other household appliances.
- In places subject to inordinate amounts of dust, dirt, or sand, for example near an open window or an outdoor exit. If setting up temporarily in an outdoor environment, be sure to take adequate precautions against airborne dust and dirt. Otherwise irreparable malfunctions could occur.

### Ventilation

The openings are provided for necessary ventilation. To ensure reliable operation of the set, and to protect it from overheating, these openings must never be blocked or covered.

### Handling the LCD screen

- Do not leave the LCD screen facing the sun as it can damage the LCD screen. Take care when you place the monitor by a window.
- Do not push on or scratch the LCD screen. Do not place a heavy object on the LCD screen. This may cause the screen to lose uniformity or cause LCD panel malfunctions.
- If the monitor is used in a cold place, a residual image may appear on the screen. This is not a malfunction. The screen returns to normal as the temperature rises to a normal operating level.
- If a still picture is displayed for a long time, a residual image may appear for a while. The residual image will eventually disappear.
- The LCD panel becomes warm during operation. This is not a malfunction.

### Note on the LCD (Liquid Crystal Display)

Please note that the LCD screen is made with high-precision technology. However, black points or bright points of light (red, blue, or green) may appear constantly on the LCD screen, and irregular colored stripes or brightness may appear on the LCD screen. This is not malfunction.

(Effective dots: more than 99.99%)

### Maintenance

- Be sure to unplug the power cord from the power outlet before cleaning your monitor.
- Clean the LCD screen with a soft cloth. If you use a glass cleaning liquid, do not use any type of cleaner containing an anti-static solution or similar additive as this may scratch the LCD screen's coating.
- Clean the cabinet, panel, and controls with a soft cloth lightly moistened with a mild detergent solution. Do not use any type of abrasive pad, scouring powder, or solvent, such as alcohol or benzene.
- Do not rub, touch, or tap the surface of the screen with sharp or abrasive items such as a ballpoint pen or screwdriver. This type of contact may result in a scratched picture tube.
- Note that material deterioration or LCD screen coating degradation may occur if the monitor is exposed to volatile solvents such as insecticide, or if prolonged contact is maintained with rubber or vinyl materials.

### Transportation

- Disconnect all cables from the monitor and hold the LCD display by the body. Be careful not to scratch the screen when transporting. If you drop the monitor, you may be injured or the monitor may be damaged.
- When you transport this monitor for repair or shipment, use the original carton and packing materials.

### Disposal of the monitor

- **Do not dispose of this monitor with general household waste.**
- **The fluorescent tube used in this monitor contains mercury. Disposal of this monitor must be carried out in accordance to the regulations of your local sanitation authority.**

### For customers in the United States

This product contains mercury. Disposal of this product may be regulated if sold in the United States. For disposal or recycling information, please contact your local authorities or the Electronics Industries Alliance (<http://www.eiae.org>).

## Identifying parts and controls

See the pages in parentheses for further details.

### Front of the LCD display

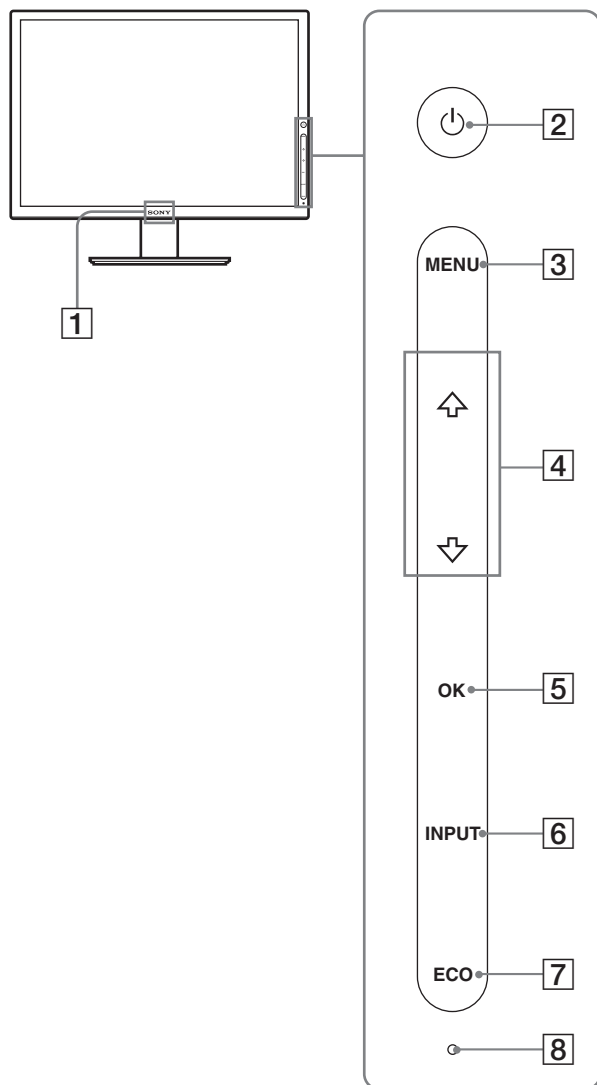

This display employs a touch sensor key system. You can operate the display by touching the letters or symbols on the front panel. Touch sensor keys work only when they are lit. Touch sensor keys light up when you turn the monitor on, but they turn off if you do not perform any operations for a while. To light them up again, touch an area of the touch sensor keys.

#### Note

Do not press the touch sensor keys too hard. This may cause a malfunction.

#### 1 Sony logo (page 18)

Sony logo illuminates.

#### 2 (Power) (pages 9, 19, 24)

This key turns the monitor on when the key lights up in red. To turn the monitor off, touch this key again.

If the key does not light up, press the MAIN POWER switch (9).

#### 3 MENU (page 12)

This key turns the menu screen on and off.

#### 4 (page 12)

These keys are used to select the menu items and make adjustments.

#### 5 OK (pages 12, 14)

This key activates the selected menu item and adjustments made using  (4).

When the menu screen is not displayed, with this key you can make automatic adjustment of the picture quality for the current input signal (one touch sensing function).

#### 6 INPUT (page 11)

This key switches the video input signal between INPUT1, INPUT2 and INPUT3 when multiple computers are connected to the monitor.

#### 7 ECO (page 19)

This key is used to reduce the power consumption.

#### 8 Light sensor (page 19)

This sensor measures the brightness of the surrounding area. Be sure not to cover the sensor with papers, etc.

GB

### Rear of the display stand

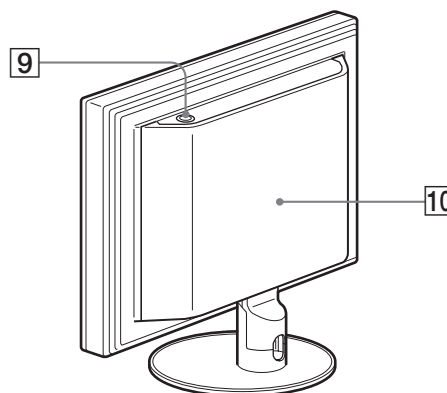

#### 9 MAIN POWER switch (page 9)

This switch turns the monitor's main power on and off.

#### 10 Back cover (page 7)

Slide up this cover when you connect cables or cords.

## Rear of the LCD display

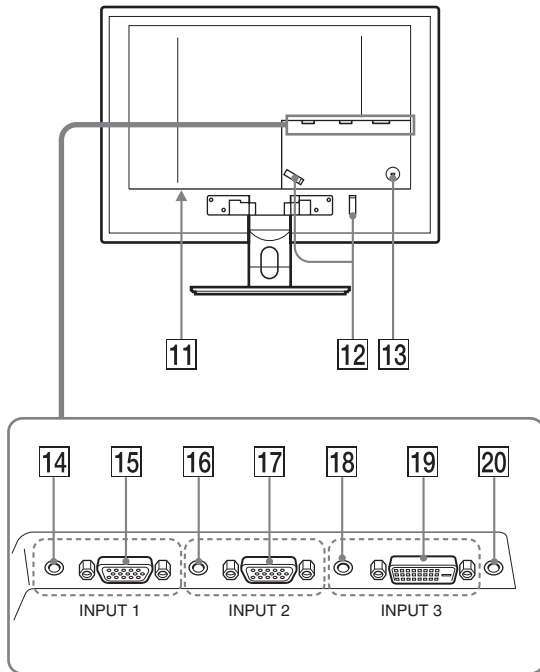

### 11 AC IN connector (page 8)

This connector connects the power cord (supplied).

### 12 Cable holder (page 9)

This part secures cables and cords to the monitor.

### 13 Security lock hole

The security lock hole should be used with the Kensington Micro Saver Security System.

Micro Saver Security System is a trademark of Kensington.

### 14 Audio input jack for INPUT1 (page 8)

This jack inputs audio signals when connected to the audio output jack of a computer or other audio equipment connected to INPUT1.

### 15 HD15 input connector (analog RGB) for INPUT1 (page 7)

This connector inputs analog RGB video signals (0.700 Vp-p, positive) and sync signals.

### 16 Audio input jack for INPUT2 (page 8)

This jack inputs audio signals when connected to the audio output jack of a computer or other audio equipment connected to INPUT2.

### 17 HD15 input connector (analog RGB) for INPUT2 (page 7)

This connector inputs analog RGB video signals (0.700 Vp-p, positive) and sync signals.

### 18 Audio input jack for INPUT3 (page 8)

This jack inputs audio signals when connected to the audio output jack of a computer or other audio equipment connected to INPUT3.

### 19 DVI-D input connector (digital RGB) for INPUT3 (page 7)

This connector inputs digital RGB video signals that comply with DVI Rev.1.0.

### 20 Audio output jack (page 8)

This jack outputs audio signals to speakers or headphones.

# Setup

Before using your monitor, check that the following items are included in your carton:

- LCD display
- Power cord
- HD15-HD15 video signal cable (analog RGB)
- DVI-D video signal cable (digital RGB)
- Audio cord (stereo miniplug)
- CD-ROM (utility software for Windows/Macintosh, Operating Instructions, etc.)
- Warranty card
- Quick Setup Guide

## Setup 1: Connect the video signal cables

- **Turn off the monitor, computer, and any other equipment before connecting them.**
- **When connecting the computer to the monitor's HD15 input connector (analog RGB), refer to "Connect a computer equipped with an HD15 output connector (analog RGB)."**

### Note

- Do not touch the pins of the video signal cable connector as this might bend the pins.
- Check the alignment of the HD15 connector to avoid bending the pins of the video signal cable connector.

- 1 Slide up the back cover.
- 2 Tilt the display forward.

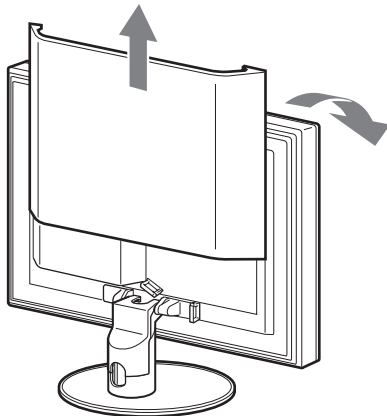

## Connect a computer equipped with a DVI output connector (digital RGB)

Using the supplied DVI-D video signal cable (digital RGB), connect the computer to the monitor's DVI-D input connector (digital RGB) for INPUT3.

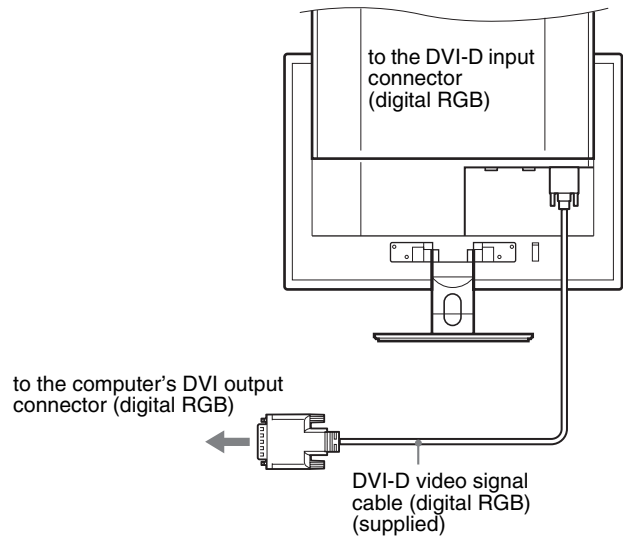

## Connect a computer equipped with an HD15 output connector (analog RGB)

Using the supplied HD15-HD15 video signal cable (analog RGB), connect the computer to the monitor's HD15 input connector (analog RGB) for INPUT1 or INPUT2.

Connect the computer according to the following illustrations.

### ■ Connecting to an IBM PC/AT or compatible computer

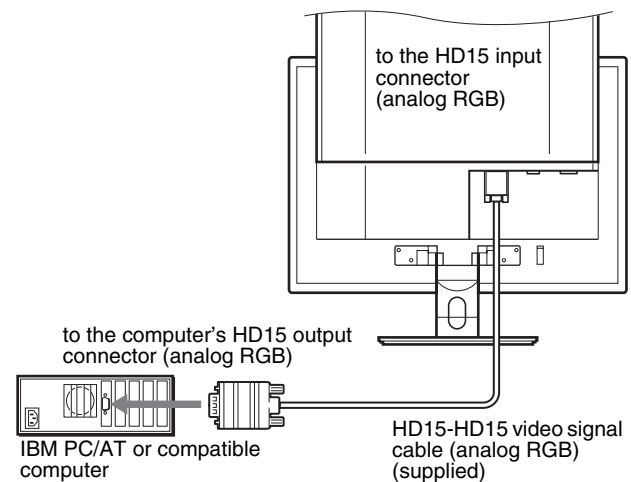

GB

## ■ Connecting to a Macintosh

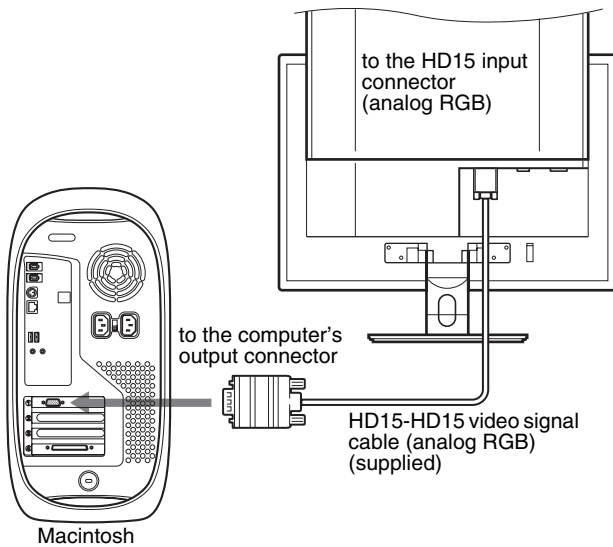

When connecting a Macintosh computer, use an adapter (not supplied), if necessary. Connect the adapter to the computer before connecting the video signal cable.

## Setup 2: Connect the audio cord

**Connect the supplied audio cord to the monitor's corresponding audio input jack.**

Using the speakers or headphones, you can listen to sound from your computer or other audio equipment connected to the monitor's audio input jacks.

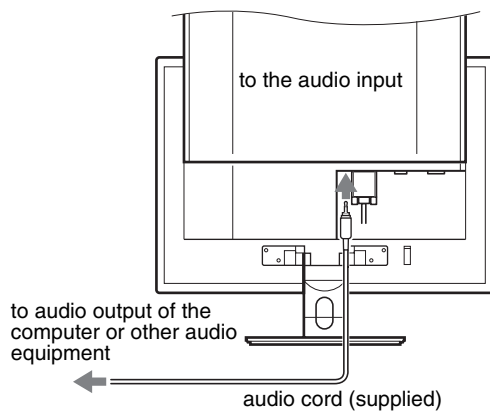

## Setup 3: Connect the speakers or headphones

**Connect the speaker cord or headphone cord securely to the monitor's audio output jack. (The speakers and headphones are not supplied.)**

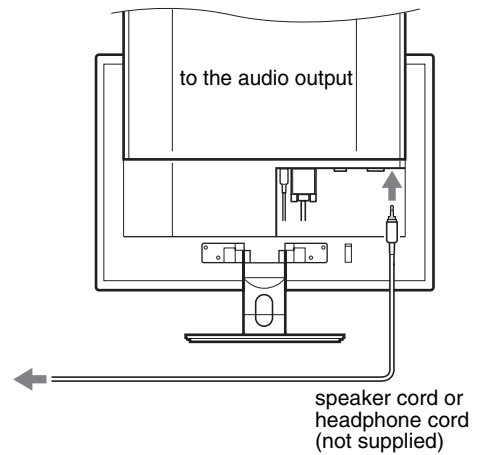

## Setup 4: Connect the power cord

- 1 **Connect the supplied power cord securely to the monitor's AC IN connector.**
- 2 **Connect the other end securely to a power outlet.**

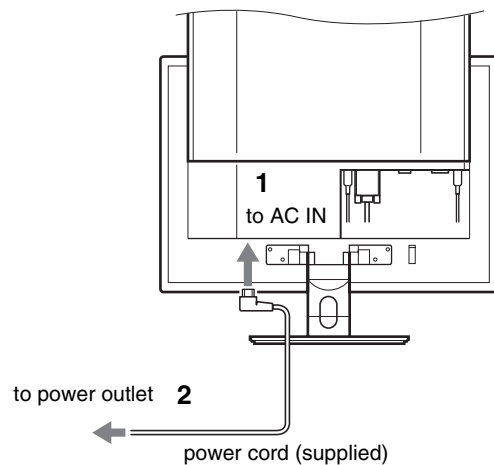





## Setup 5: Bundle the cords and cables

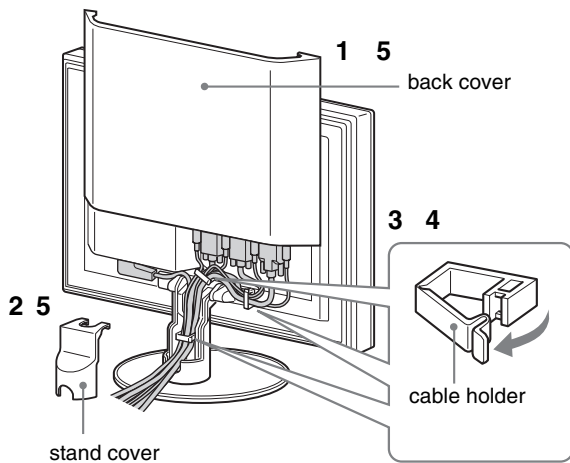

- 1 Slide up the back cover.
- 2 Remove the stand cover.
- 3 Secure the video signal cables, audio cords and speaker cord (or headphone cord) using the cable holder on the cabinet.
- 4 Secure the power cord, connecting cables and cords using the cable holder.
- 5 Replace the stand cover and then slide down the back cover.  
Please be sure that cords come out through the opening at the bottom of the stand cover, for proper placement of the stand cover.

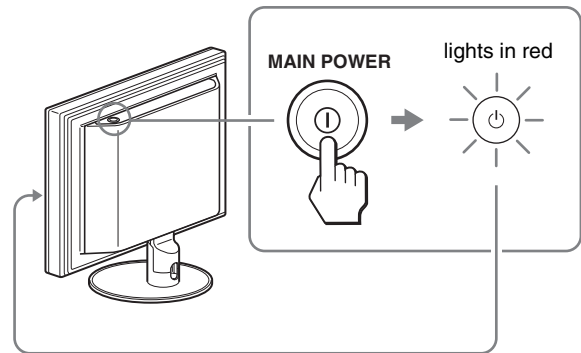

## Setup 6: Turn on the monitor and computer

- 1 Press the MAIN POWER switch located on the upper side of the monitor, if  (power) is not lit. Make sure  (power) is lit in red.



- 2 Touch and hold  (power) on the front right of the monitor for a few seconds.  
 (power) lights up in green.

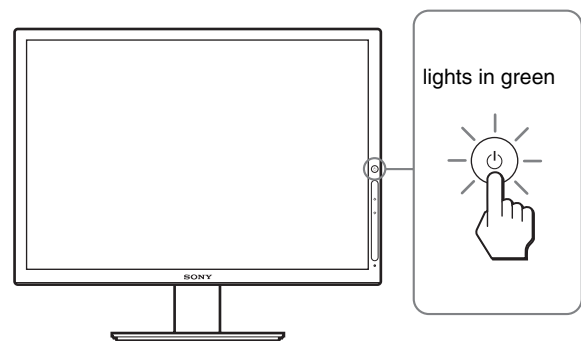

GB

- 3 Turn on the computer.
- 4 Touch INPUT to select the desired input signal.  
The selected input's picture appears on the screen.  
For more information, see "Selecting the input signal (INPUT)" on page 11.

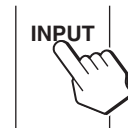

The installation of your monitor is complete. If necessary, use the monitor's controls to adjust the picture (page 12).

## If no picture appears on your screen

- Check that the power cord and the video signal cable are properly connected.
- If “NO INPUT SIGNAL” appears on the screen:
  - The computer is in the power saving mode. Try pressing any key on the keyboard or moving the mouse.
  - Check that the input signal setting is correct by touching INPUT (page 11).
- If “CABLE DISCONNECTED” appears on the screen:
  - Check that the video signal cable is properly connected.
  - Check that the input signal setting is correct by touching INPUT (page 11).
- If “OUT OF RANGE” appears on the screen, reconnect the old monitor. Then adjust the computer’s graphics board within the following ranges.

	Analog RGB	Digital RGB
<b>Horizontal frequency</b>	28–92 kHz	28–75 kHz
<b>Vertical frequency</b>	48–85 Hz	60 Hz
<b>Resolution</b>	1600 × 1200 or more* 1920 × 1200 or less	

\* Only when the vertical frequency is set to 60 Hz.

For more information about on-screen messages, see “Trouble symptoms and remedies” on page 22.

### No need for specific drivers

The monitor complies with the “DDC” Plug & Play standard and automatically detects all the monitor’s information. No specific driver needs to be installed on the computer.

The first time you turn on your computer after connecting the monitor, the setup Wizard may appear on the screen. In this case, follow the on-screen instructions. The Plug & Play monitor is automatically selected so that you can use this monitor.

The vertical frequency is set to 60 Hz.

Since flickers are unobtrusive on the monitor, you can use it as it is. You do not need to set the vertical frequency to any particular high value.

## Setup 7: Adjust the tilt

This monitor can be adjusted within the angles shown below.

Grasp the sides of the LCD panel, then adjust screen angles.

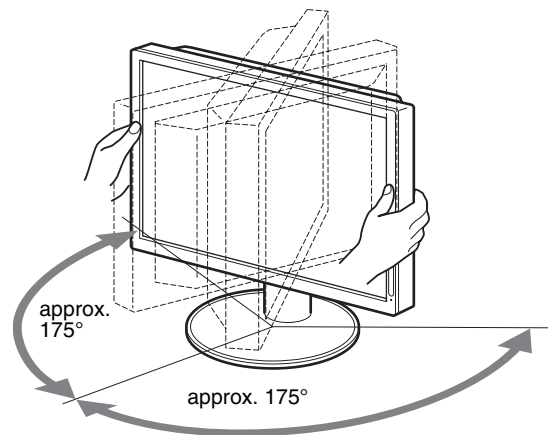
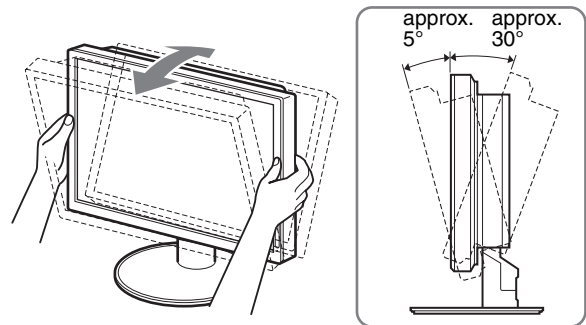

### To use the monitor comfortably

Adjust the viewing angle of your monitor according to the height of your desk and chair, and so that light is not reflected from the screen to your eyes.

#### Note

When adjusting the screen tilt, proceed slowly and carefully, being sure not to hit the monitor against the desk.

---

## Selecting the input signal (INPUT)

### Touch INPUT.

The input signal changes each time you touch this key.

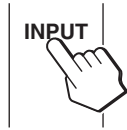

---

On-screen message (Appears about 5 seconds on the upper left corner.)	Input signal configuration
INPUT1 : HD15	HD15 input connector (analog RGB) for INPUT1
INPUT2 : HD15	HD15 input connector (analog RGB) for INPUT2
INPUT3 : DVI-D	DVI-D input connector (digital RGB) for INPUT3

---

# Customizing Your Monitor

## Before making adjustments

Connect the monitor and the computer, and turn them on. For the best results, wait for at least 30 minutes before making adjustments.

You can make numerous adjustments to your monitor using the on-screen menu.

## Navigating the menu

You can adjust the menus by using the touch sensor keys on the front of the monitor.

### 1 Light up touch sensor keys.

Touch an area of the touch sensor keys so they light up. If touch sensor keys are already been lit, this step is unnecessary (go to step 2).

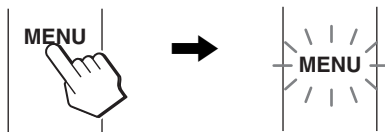

#### Note

Touch sensor keys work only when they are lit. Touch sensor keys light up when you turn the monitor on, but they turn off if you do not perform any operations for a while. To light them up again, touch an area of the touch sensor keys.

While the menu is displayed, the touch sensor keys remain on and ready for use.

### 2 Display the main menu.

Touch MENU to display the main menu on your screen.

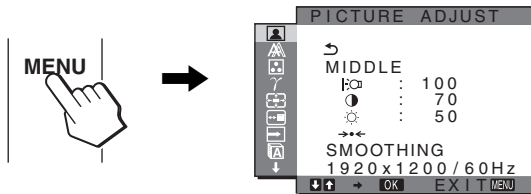

### 3 Select the menu.

Touch  $\uparrow/\downarrow$  to display the desired menu. Touch OK to move to the first menu item.

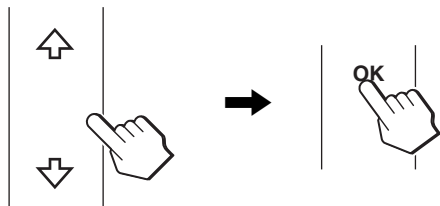

### 4 Select the item you want to adjust.

Touch  $\downarrow/\uparrow$  to select the item you want to adjust, then touch OK.

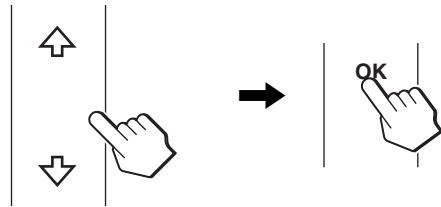

#### If $\curvearrowright$ is one of the menu items.

When you select  $\curvearrowright$  and touch OK, the display returns to the previous menu.

### 5 Adjust the item.

Touch  $\downarrow/\uparrow$  to make the adjustment, then touch OK. When you touch OK, the setting is stored, then the display returns to the previous menu.

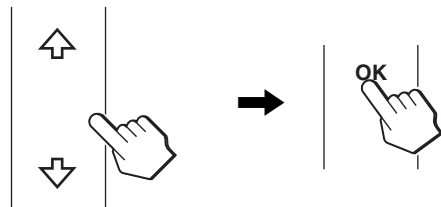

### 6 Close the menu.

When you touch MENU, the menu closes and the touch sensor keys turn off. If MENU is not touched for 45 seconds after adjustment, the menu closes and the touch sensor keys turn off.

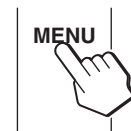





## Resetting the adjustments to the default settings

You can reset the adjustments using RESET menu. For more information about resetting the adjustments, see  $\rightarrow$  (RESET) on page 17.

## PICTURE ADJUST menu

You can adjust the following items using the PICTURE ADJUST menu.

- MODE (ECO mode)
- BACKLIGHT 
- CONTRAST 
- BRIGHTNESS 
- MODE RESET 
- SMOOTHING

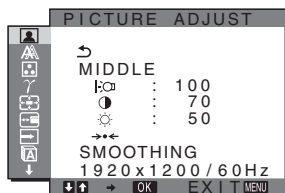

### Note

- You can adjust the backlight, contrast, and brightness for each ECO mode.
- Settings in the PICTURE ADJUST menu can be made for the current input. You can also adjust settings for other inputs.

### ■ Selecting the MODE (ECO mode)

You can select the picture mode to reduce the power consumption.

### Note

You can also select the picture mode with ECO (pages 5, 19) on the front of the monitor.

- 1 **Touch MENU.**  
The main menu appears on the screen.
- 2 **Touch ↓/↑ to select  (PICTURE ADJUST) and touch OK.**  
The PICTURE ADJUST menu appears on the screen.
- 3 **Touch ↓/↑ to select “MIDDLE” and touch OK.**  
The “MODE” menu appears on the screen.

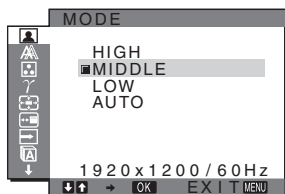



- 4 **Touch ↓/↑ to select the desired mode and touch OK.**  
The screen brightness is changed as the mode turns to HIGH → MIDDLE → LOW, and the power consumption is reduced.  
When you select “AUTO,” the monitor automatically adjusts the screen brightness according to the brightness of the surroundings (automatic brightness adjustment function). For more information, see “Automatic brightness adjustment function (light sensor)” on page 19.

### ■ Adjusting the BACKLIGHT

If the screen is too bright, adjust the backlight to make the screen easier to see.

### Note

The backlight cannot be adjusted when the ECO mode is set to “AUTO” (page 19).



- 1 **Touch MENU.**  
The main menu appears on the screen.
- 2 **Touch ↓/↑ to select  (PICTURE ADJUST) and touch OK.**  
The PICTURE ADJUST menu appears on the screen.
- 3 **Touch ↓/↑ to select “ BACKLIGHT” and touch OK.**  
The “BACKLIGHT” menu appears on the screen.
- 4 **Touch ↓/↑ to adjust the light level and touch OK.**

### ■ Adjusting the CONTRAST

Adjust the picture contrast.

### Note

The contrast cannot be adjusted when the ECO mode is set to “AUTO” (page 19).



- 1 **Touch MENU.**  
The main menu appears on the screen.
- 2 **Touch ↓/↑ to select  (PICTURE ADJUST) and touch OK.**  
The PICTURE ADJUST menu appears on the screen.
- 3 **Touch ↓/↑ to select “ CONTRAST” and touch OK.**  
The “CONTRAST” menu appears on the screen.
- 4 **Touch ↓/↑ to adjust the contrast and touch OK.**

### ■ Adjusting the BRIGHTNESS

Adjust the picture brightness (black level).

### Note

The brightness cannot be adjusted when the ECO mode is set to “AUTO” (page 19).

- 1 **Touch MENU.**  
The main menu appears on the screen.
- 2 **Touch ↓/↑ to select  (PICTURE ADJUST) and touch OK.**  
The PICTURE ADJUST menu appears on the screen.
- 3 **Touch ↓/↑ to select “ BRIGHTNESS” and touch OK.**  
The “BRIGHTNESS” menu appears on the screen.
- 4 **Touch ↓/↑ to adjust the brightness and touch OK.**

### ■ Resetting the adjustment data to the defaults

You can reset the adjustments to the default settings.

- 1 **Touch MENU.**  
The main menu appears on the screen.
- 2 **Touch ↓/↑ to select  (PICTURE ADJUST) and touch OK.**  
The PICTURE ADJUST menu appears on the screen.

- 3 Touch  $\downarrow/\uparrow$  to select “ $\leftarrow$  MODE RESET” and touch OK.

The “RESET” menu appears on the screen.

- 4 Touch  $\downarrow/\uparrow$  to select the desired mode and touch OK.
  - OK: To reset all of the adjustment data in the PICTURE ADJUST menu to the default settings.
  - CANCEL: To cancel resetting and return to the PICTURE ADJUST menu.

## ■ Adjusting the SMOOTHING

If the picture displayed at the FULL2 or FULL1 mode of ZOOM is not smooth, use the picture smoothing function.

- 1 Touch MENU.  
The main menu appears on the screen.
- 2 Touch  $\downarrow/\uparrow$  to select  (PICTURE ADJUST) and touch OK.  
The PICTURE ADJUST menu appears on the screen.
- 3 Touch  $\downarrow/\uparrow$  to select “SMOOTHING” and touch OK.  
The SMOOTHING menu appears on the screen.
- 4 Touch  $\downarrow/\uparrow$  to select the desired mode.  
The smoothing effect becomes stronger in the order of TEXT  $\rightarrow$  STANDARD  $\rightarrow$  GRAPHICS.
  - TEXT: To make the characters appear clear. (This mode is suited for text-based applications.)
  - STANDARD (The default setting): Standard smoothing effect.
  - GRAPHICS: To make the pictures appear clean. (This mode is suited for CD-ROM software such as photo images or illustrations.)

### Note

- When you set the  (ZOOM) menu to REAL, the SMOOTHING menu is not available.
- 1920  $\times$  1200 resolution signals are shown only in REAL mode and SMOOTHING is not possible.

## SCREEN menu (analog RGB signal only)

You can adjust the following items using the SCREEN menu.

- AUTO
- PHASE
- PITCH
- H CENTER
- V CENTER

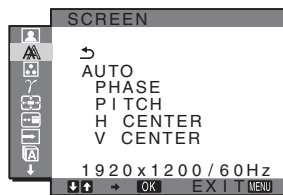

### Note

When receiving digital RGB signals from the DVI-D input connector for INPUT3, adjustment is unnecessary.

## ■ Automatic picture quality adjustment function

When the monitor receives an input signal, it automatically adjusts the picture's position and sharpness (phase/pitch), and ensures that a clear picture appears on the screen (page 20).

### Note

While the automatic picture quality adjustment function is activated, only  $\text{\textcircled{P}}$  (power) will operate.

### If the automatic picture quality adjustment function of this monitor seems not to completely adjust the picture

You can make further automatic adjustment of the picture quality for the current input signal. Adjust by touching OK on the front of the monitor (one touch sensing function), or following the steps in “AUTO” below.

### If you still need to make further adjustments to the picture quality

You can manually adjust the picture's sharpness (phase/pitch) and position (horizontal/vertical position).

These adjustments are stored in memory and automatically recalled when the monitor receives a previously input and registered input signal.

## ■ Make further automatic adjustments to the picture quality for the current input signal (AUTO)

- 1 Touch MENU.  
The main menu appears on the screen.
- 2 Touch  $\downarrow/\uparrow$  to select  (SCREEN) and touch OK.  
The SCREEN menu appears on the screen.
- 3 Touch  $\downarrow/\uparrow$  to select “AUTO” and touch OK.  
Make the appropriate adjustments of the screen's phase, pitch and horizontal/vertical position for the current input signal and store them.

## ■ Adjust the picture's sharpness manually (Phase/Pitch)

You can adjust the picture's sharpness as follows. This adjustment is effective when the computer is connected to the monitor's HD15 input connector (analog RGB).

- 1 Set the resolution to 1920  $\times$  1200 on the computer.
- 2 Load the CD-ROM.
- 3 Start the CD-ROM, select the area and model, and display the test pattern.  
**For Windows**  
Click [Utility]  $\rightarrow$  [Windows]/[Win Utility.exe].  
**For Macintosh**  
Click [Utility]  $\rightarrow$  [Mac]/[Mac Utility].
- 4 Touch MENU.  
The main menu appears on the screen.
- 5 Touch  $\downarrow/\uparrow$  to select  (SCREEN) and touch OK.  
The SCREEN menu appears on the screen.

- 6 Touch **↓/↑** to select “PHASE” and touch OK.  
The “PHASE” adjustment menu appears on the screen.

- 7 Touch **↓/↑** until the horizontal stripes are at a minimum.  
Adjust so that the horizontal stripes are at a minimum.

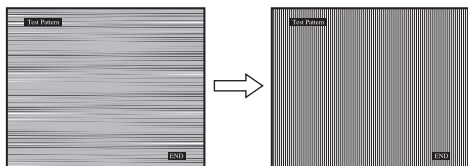

- 8 Touch OK.  
The main menu appears on the screen.  
If vertical stripes are observed over the entire screen, adjust the pitch using the following procedures.

- 9 Touch **↓/↑** to select “PITCH” and touch OK.  
The “PITCH” adjustment menu appears on the screen.

- 10 Touch **↓/↑** until the vertical stripes disappear.  
Adjust so that the vertical stripes disappear.

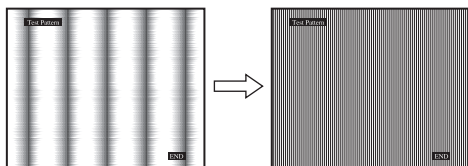

- 11 Click **[END]** on the screen to turn off the test pattern.

### ■ Adjust the picture’s position manually (H CENTER / V CENTER)

If the picture is not in the center of the screen, adjust the picture’s centering as follows.

- 1 Set the resolution to 1920 × 1200 on the computer.
- 2 Load the CD-ROM.
- 3 Start the CD-ROM, select the area and model, and display the test pattern.  
**For Windows**  
Click [Utility] → [Windows]/[Win Utility.exe].  
**For Macintosh**  
Click [Utility] → [Mac]/[Mac Utility].
- 4 Touch MENU.  
The main menu appears on the screen.
- 5 Touch **↓/↑** to select **▲** (SCREEN) and touch OK.  
The SCREEN menu appears on the screen.
- 6 Touch **↓/↑** to select “H CENTER” or “V CENTER” and touch OK.  
The “H CENTER” adjustment menu or “V CENTER” adjustment menu appears on the screen.
- 7 Touch **↓/↑** to center the test pattern on the screen.
- 8 Click **[END]** on the screen to turn off the test pattern.

## ☺ COLOR menu

You can select the picture’s color level for the white color field from the default color temperature settings.  
Also, if necessary, you can fine tune the color temperature.

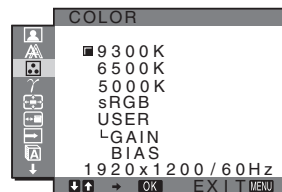

### Note

- You can adjust the color temperature for each ECO mode.
- Settings in the COLOR menu can be made for the current input. You can also adjust settings for other inputs.

- 1 Touch MENU.

The main menu appears on the screen.

- 2 Touch **↓/↑** to select **☺** (COLOR) and touch OK.  
The COLOR menu appears on the screen.

- 3 Touch **↓/↑** to select the desired color temperature and touch OK.

Whites will change from a bluish hue (9300K) to a reddish hue (5000K) as the temperature is lowered.

When you select “sRGB,” the colors adjust to the sRGB profile. (The sRGB color setting is an industry-standard color space protocol designed for computer products.) If you select “sRGB,” the color settings of your computer must be set to the sRGB profile.

### Note

- If a connected computer or other equipment is not sRGB-compliant, color cannot be adjusted to the sRGB profile.
- You cannot select “sRGB” when the ECO mode is set to “AUTO.”
- If you select “sRGB,” you cannot adjust the contrast and brightness in the PICTURE ADJUST menu. Also, you cannot adjust the GAMMA menu.

### ■ Fine tuning the color temperature

You can make additional adjustments to the light areas (GAIN:white level) and the dark areas (BIAS:black level) of a picture.

- 1 Touch MENU.

The main menu appears on the screen.

- 2 Touch **↓/↑** to select **☺** (COLOR) and touch OK.  
The COLOR menu appears on the screen.

- 3 Touch **↓/↑** to select “GAIN” and touch OK.

The GAIN ADJUSTMENT menu appears on the screen.

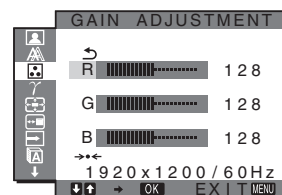

4 Touch **↓/↑** to select R (Red), G (Green) or B (Blue) and touch **OK**. Then touch **↓/↑** to adjust the GAIN and touch **OK**.

5 Touch **↓/↑** to select **↶**, then touch **OK**.  
The COLOR menu appears on the screen.

6 Touch **↓/↑** to select “BIAS” and touch **OK**.  
The BIAS ADJUSTMENT menu appears on the screen.

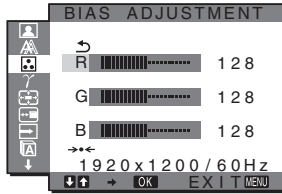

7 Touch **↓/↑** to select R (Red), G (Green) or B (Blue) and touch **OK**. Then touch **↓/↑** to adjust the BIAS and touch **OK**.

8 Touch **↓/↑** to select **↶**, then touch **OK**.  
The new color setting is stored in memory and automatically recalled whenever “USER” is selected.  
The COLOR menu appears on the screen.

### ■ Resetting the adjustment data to the defaults **↶↷**

You can reset the GAIN or BIAS to the default settings.

1 Touch **MENU**.

The main menu appears on the screen.

2 Touch **↓/↑** to select **☐** (COLOR) and touch **OK**.  
The COLOR menu appears on the screen.

3 Touch **↓/↑** to select “GAIN” or “BIAS” and touch **OK**.  
The GAIN ADJUSTMENT menu or BIAS ADJUSTMENT menu appears on the screen.

4 Touch **↓/↑** to select “**↶↷** RESET” and touch **OK**.  
The “RESET” menu appears on the screen.

5 Touch **↓/↑** to select the desired mode and touch **OK**.

- **OK**: To reset GAIN or BIAS to the default settings.
- **CANCEL**: To cancel resetting and return to the GAIN ADJUSTMENT menu or BIAS ADJUSTMENT menu.

---

## γ GAMMA menu

You can associate the picture’s color shade on the screen with the picture’s original color shade.

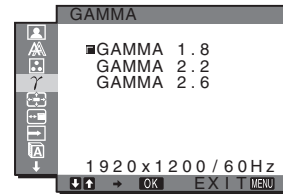

### ■ Selecting the GAMMA

1 Touch **MENU**.

The main menu appears on the screen.

2 Touch **↓/↑** to select **γ** (GAMMA) and touch **OK**.  
The GAMMA menu appears on the screen.

3 Touch **↓/↑** to select the desired mode and touch **OK**.

---

## 🔍 ZOOM menu

The monitor is set to display the picture on the screen in full, irrespective of the picture’s mode or resolution in the default setting (FULL2).

You can also view the picture in its actual aspect ratio or resolution.

Settings in the ZOOM menu can be made for the current input. You can also adjust settings for other inputs.

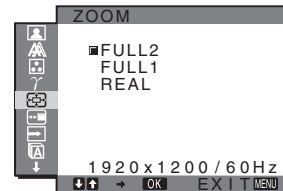

1 Touch **MENU**.

The main menu appears on the screen.

2 Touch **↓/↑** to select **🔍** (ZOOM) and touch **OK**.  
The ZOOM menu appears on the screen.

3 Touch **↓/↑** to select the desired mode and touch **OK**.

- **FULL2** (The default setting): The input signal is displayed on the screen in full, irrespective of the picture’s mode or resolution.
- **FULL1**: The input signal is displayed on the screen at its actual aspect ratio. Therefore, black bands may appear at the top and bottom of the picture, depending on the signal.
- **REAL**: The input signal is displayed on the screen at its actual resolution. Sub-1920 × 1200 signals are displayed at the center of the screen surrounded by a black frame.

### Note

When you use 1920 × 1200 resolution signals, the above mentioned settings are not available. The picture is displayed on the screen in full.



## MENU POSITION menu

You can change the menu position if it is blocking an image on the screen.

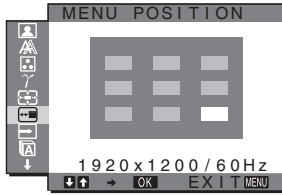

- 1 Touch MENU.**  
The main menu appears on the screen.
- 2 Touch ↓/↑ to select  (MENU POSITION) and touch OK.**  
The MENU POSITION menu appears on the screen.
- 3 Touch ↓/↑ to select the desired position and touch OK.**  
You can choose one of 9 positions where the menu will appear.

## INPUT SENSING ON/OFF menu

When you select AUTO ON in the INPUT SENSING ON/OFF menu, the monitor automatically detects an input signal to an input terminal, and changes the input automatically before the monitor goes into the power saving mode.

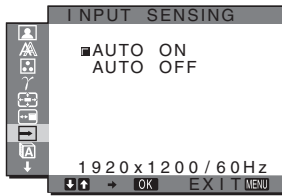

- 1 Touch MENU.**  
The main menu appears on the screen.
- 2 Touch ↓/↑ to select  (INPUT SENSING ON/OFF) and touch OK.**  
The INPUT SENSING menu appears on the screen.
- 3 Touch ↓/↑ to select the desired mode and touch OK.**
  - **ON:** When the selected input terminal has no input signal, or when you select an input terminal by INPUT on the monitor and the terminal has no input signal, the on-screen message appears (page 21) and the monitor checks the input signal to another input terminal automatically to change the input. When the input is changed, the selected input terminal is displayed on the left upper of the screen. When there is no input signal, the monitor goes into the power saving mode automatically.
  - **OFF:** The input is not changed automatically. Touch INPUT to change the input.

## LANGUAGE menu





- 1 Touch MENU.**  
The main menu appears on the screen.
- 2 Touch ↓/↑ to select  (LANGUAGE) and touch OK.**  
The LANGUAGE menu appears on the screen.
- 3 Touch ↓/↑ to select a language and touch OK.**
  - ENGLISH
  - FRANÇAIS: French
  - DEUTSCH: German
  - ESPAÑOL: Spanish
  - ITALIANO: Italian
  - NEDERLANDS: Dutch
  - SVENSKA: Swedish
  - РУССКИЙ: Russian
  - 日本語: Japanese
  - 中文: Chinese

GB

## RESET menu

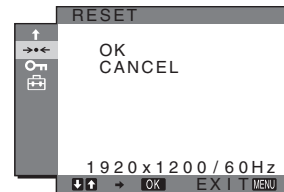
Reset the adjustments to the default settings.







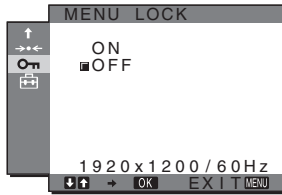

- 1 Touch MENU.**  
The main menu appears on the screen.
- 2 Touch ↓/↑ to select  (RESET) and touch OK.**  
The RESET menu appears on the screen.
- 3 Touch ↓/↑ to select the desired mode and touch OK.**
  - **OK:** To reset all of the adjustment data to the default settings. Note that the “ LANGUAGE” setting is not reset by this method.
  - **CANCEL:** To cancel resetting and return to the menu screen.

---

## MENU LOCK menu

Lock the control of keys to prevent accidental adjustments or resetting.





- 1 Touch MENU.**  
The main menu appears on the screen.
- 2 Touch ↓/↑ to select  (MENU LOCK) and touch OK.**  
The MENU LOCK menu appears on the screen.
- 3 Touch ↓/↑ to select either “ON” or “OFF” and touch OK.**
  - ON: Only  (power) and INPUT will operate. If you attempt any other operation, the  (MENU LOCK) icon appears on the screen.
  - OFF: Set “ MENU LOCK” to off. If “ MENU LOCK” has been set to “ON,” when you touch MENU, “ MENU LOCK” is automatically selected.

---

## OPTION menu

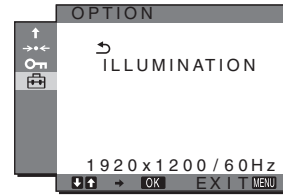
You can set the Sony logo on the front of the monitor to illuminate. The default setting is “ON”.



- 1 Touch MENU.**  
The main menu appears on the screen.
- 2 Touch ↓/↑ to select  (OPTION) and touch OK.**  
The OPTION menu appears on the screen.
- 3 Touch ↓/↑ to select “ILLUMINATION” and touch OK.**  
The ILLUMINATION menu appears on the screen.
- 4 Touch ↓/↑ to select either “ON” or “OFF” and touch OK.**
  - ON: Turns the Sony logo illumination on.
  - OFF: Turns the Sony logo illumination off. (Logo lights up approx. 15 seconds after you touch  (power) to turn the monitor on.)

# Technical Features

## Power saving function

This monitor meets the power-saving guidelines set by VESA, ENERGY STAR, and NUTEK. If the monitor is connected to a computer or video graphics board that is DPM (Display Power Management) Standard compliant, the monitor will automatically reduce power consumption as shown below.

Power mode	Power consumption	⏻ (power)
normal operation	80 W (max.)	green
ECO mode		green
active off* (deep sleep)	1.0 W (max.)	orange
⏻ (power) off	1.0 W (max.)	red
main power off	0 W	off

\* When your computer enters the “active off” mode, the input signal is cut and “NO INPUT SIGNAL” appears on the screen. After 5 seconds, the monitor enters the power saving mode. “Deep sleep” is a power saving mode defined by the Environmental Protection Agency.

## Reducing the power consumption (ECO mode)

If you touch ECO on the front of the monitor repeatedly, you can select the screen brightness.

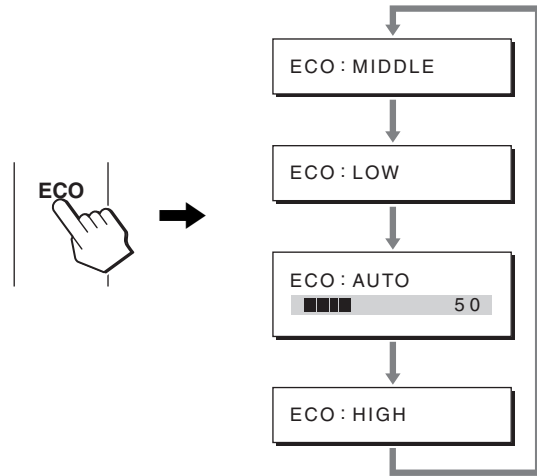

Each mode appears on the screen and the screen brightness is reduced according to the mode. The menu automatically disappears after about 5 seconds.

Screen brightness and power consumption are reduced as the mode changes from HIGH to MIDDLE to LOW.

The default setting of the screen brightness is set to “MIDDLE”. When you select “AUTO,” the monitor automatically adjusts the screen brightness according to the brightness of the surroundings (automatic brightness adjustment function). For more information, see “Automatic brightness adjustment function (light sensor)” on page 19.

### Note

- When the ECO mode is set to “HIGH,” “MIDDLE,” or “LOW,” BACKLIGHT, CONTRAST and BRIGHTNESS of the menu are available (page 13).
- You cannot select “sRGB” in the COLOR menu when the ECO mode is set to “AUTO.”

## Automatic brightness adjustment function (light sensor)

This monitor is provided with a feature to automatically adjust the screen brightness according to the brightness of the surroundings. The brightness of the screen is set to the most appropriate level by setting the ECO mode to “AUTO” with ECO on the front of the monitor, or in the PICTURE ADJUST menu. The default setting of the screen brightness is set to “MIDDLE”. Also, when you set the ECO mode to “AUTO” with ECO on the front of the monitor, the adjustment bar is also displayed. You can adjust the bar with ↓/↑. Screen brightness changes according to the level you set.

---

## **Automatic picture quality adjustment function (analog RGB signal only)**

**When the monitor receives an input signal, it automatically adjusts the picture's position and sharpness (phase/pitch), and ensures that a clear picture appears on the screen.**

### **The factory preset mode**

When the monitor receives an input signal, it automatically matches the signal to one of the factory preset modes stored in the monitor's memory to provide a high quality picture at the center of the screen. If the input signal matches the factory preset mode, the picture appears on the screen automatically with the appropriate default adjustments.

### **If input signals do not match one of the factory preset modes**

When the monitor receives an input signal that does not match one of the factory preset modes, the automatic picture quality adjustment function of this monitor is activated to ensure that a clear picture always appears on the screen (within the following monitor frequency ranges):

Horizontal frequency: 28–92 kHz (analog RGB)

28–75 kHz (digital RGB)

Vertical frequency: 48–85 Hz (analog RGB)

60 Hz (digital RGB)

Consequently, the first time the monitor receives input signals that do not match one of the factory preset modes, the monitor may take a longer time than normal to display the picture on the screen. This adjustment data is automatically stored in memory so that next time, the monitor will function in the same way as when the monitor receives the signals that match one of the factory preset modes.

### **If you adjust the phase, pitch, and picture position manually**

For some input signals, the automatic picture quality adjustment function of this monitor may not completely adjust the picture position, phase, and pitch. In this case, you can set these adjustments manually (page 14). If you set these adjustments manually, they are stored in memory as user modes and automatically recalled whenever the monitor receives the same input signals.

# Troubleshooting

Before contacting technical support, refer to this section.

## On-screen messages

If there is something wrong with the input signal, one of the following messages appears on the screen. To solve the problem, see “Trouble symptoms and remedies” on page 22.

### If “OUT OF RANGE” appears on the screen

This indicates that the input signal is not supported by the monitor’s specifications. Check the following items.

For more information about on-screen messages, see “Trouble symptoms and remedies” on page 22.

#### If “xxx.x kHz / xxx Hz” is displayed

This indicates that either the horizontal or vertical frequency is not supported by the monitor’s specifications.

The figures indicate the horizontal and vertical frequencies of the current input signal.

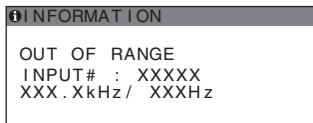

#### If “RESOLUTION > 1920 × 1200” is displayed

This indicates that the resolution is not supported by the monitor’s specifications (1920 × 1200 or less).

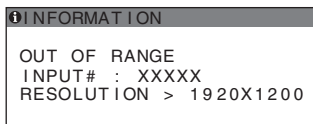

### If “NO INPUT SIGNAL” appears on the screen

This indicates that no signal is being input via the currently selected connector.

When INPUT SENSING ON/OFF (page 17) is set to ON, the monitor finds another input signal and changes the input automatically.

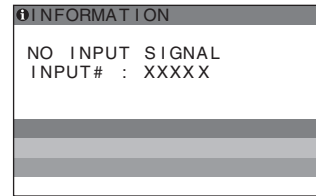

### GO TO POWER SAVE

The monitor will enter the power saving mode after about 5 seconds from the time the message is displayed.

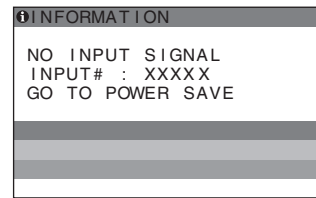

### If “CABLE DISCONNECTED” appears on the screen

This indicates that the video signal cable has been disconnected from the currently selected connector.

When INPUT SENSING ON/OFF (page 17) is set to ON, the monitor finds another input signal and changes the input automatically.

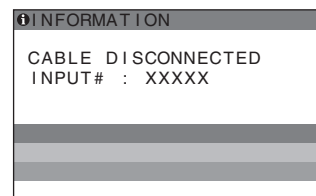

---

## Trouble symptoms and remedies

If a problem occurs as a result of a connected computer or other equipment, refer to the connected computer/equipment's instruction manual. Use the self-diagnosis function (page 24) if the following recommendations do not resolve the problem. For further information and troubleshooting assistance, please visit Sony support website at: <http://www.sony.net/>.

Symptom	Check these items
<b>No picture</b>	
If ⏻ (power) is not lit, or if ⏻ (power) will not light up when ⏻ (power) is touched,	<ul style="list-style-type: none"><li>• Check that the power cord is properly connected.</li><li>• Check that the monitor's MAIN POWER switch is on (page 9).</li></ul>
If ⏻ (power) turns on in red,	<ul style="list-style-type: none"><li>• Check that ⏻ (power) is on.</li></ul>
If ⏻ (power) is green,	<ul style="list-style-type: none"><li>• Use the self-diagnosis function (page 24).</li></ul>
If "CABLE DISCONNECTED" appears on the screen,	<ul style="list-style-type: none"><li>• Check that the video signal cable is properly connected and all plugs are firmly seated in their sockets (page 7).</li><li>• Check that the video input connector's pins are not bent or pushed in.</li><li>• Check that the input select setting is correct (page 11).</li><li>• A non-supplied video signal cable is connected. If you connect a non-supplied video signal cable, "CABLE DISCONNECTED" may appear on the screen. This is not a malfunction.</li></ul>
If "NO INPUT SIGNAL" appears on the screen, or ⏻ (power) is orange,	<ul style="list-style-type: none"><li>• Check that the video signal cable is properly connected and all plugs are firmly seated in their sockets (page 7).</li><li>• Check that the video input connector's pins are not bent or pushed in.</li><li>• Check that the input select setting is correct (page 11).</li></ul> <p><b>■ Problem caused by a connected computer or other equipment, and not caused by the monitor</b></p> <ul style="list-style-type: none"><li>• The computer is in the power saving mode. Try pressing any key on the keyboard or moving the mouse.</li><li>• Check that your graphics board is installed properly.</li><li>• Check that the computer's power is on.</li><li>• Restart the computer.</li></ul>
If "OUT OF RANGE" appears on the screen (page 21),	<p><b>■ Problem caused by a connected computer or other equipment, and not caused by the monitor</b></p> <ul style="list-style-type: none"><li>• Check that the video frequency range is within that specified for the monitor. If you replaced an old monitor with this monitor, reconnect the old monitor and adjust the computer's graphics board within the following ranges: Horizontal frequency: 28–92 kHz (analog RGB), 28–75 kHz (digital RGB) Vertical frequency: 48–85 Hz (analog RGB), 60 Hz (digital RGB) Resolution: 1600 × 1200 or more*, 1920 × 1200 or less * Only when the vertical frequency is set to 60 Hz.</li></ul>
If using Windows,	<ul style="list-style-type: none"><li>• If you replaced an old monitor with this monitor, reconnect the old monitor and do the following. Select "SONY" from the "Manufacturers" list and select "SDM-P234" from the "Models" list in the Windows device selection screen. If "SDM-P234" does not appear in the "Models" list, try "Plug &amp; Play."</li></ul>
If using a Macintosh system,	<ul style="list-style-type: none"><li>• When connecting a Macintosh computer, use an adapter (not supplied) if necessary. Connect the adapter to the computer before connecting the video signal cable.</li></ul>

Symptom	Check these items
<b>Picture flickers, bounces, oscillates, or is scrambled.</b>	<ul style="list-style-type: none"> <li>• Adjust the pitch and phase (analog RGB signal only) (page 14).</li> <li>• Try plugging the monitor into a different AC outlet, preferably on a different circuit.</li> <li>• Change the orientation of the monitor.</li> </ul> <p>■ <b>Problem caused by a connected computer or other equipment, and not caused by the monitor</b></p> <ul style="list-style-type: none"> <li>• Check your graphics board manual for the proper monitor setting.</li> <li>• Confirm that the graphics mode (VESA, Macintosh 19" Color, etc.) and the frequency of the input signal are supported by this monitor. Even if the frequency is within the proper range, some graphics boards may have a sync pulse that is too narrow for the monitor to sync with correctly.</li> <li>• This monitor does not process interlace signals. Set for progressive signals.</li> <li>• Adjust the computer's refresh rate (vertical frequency) to obtain the best possible picture (60 Hz is recommended).</li> </ul>
<b>Picture is fuzzy.</b>	<ul style="list-style-type: none"> <li>• Adjust the brightness and contrast (page 13).</li> <li>• Adjust the pitch and phase (analog RGB signal only) (page 14).</li> <li>• Adjust the smoothing (page 14).</li> </ul> <p>■ <b>Problem caused by a connected computer or other equipment, and not caused by the monitor</b></p> <ul style="list-style-type: none"> <li>• Set the resolution to 1920 × 1200 on your computer.</li> </ul>
<b>Picture is ghosting.</b>	<ul style="list-style-type: none"> <li>• Eliminate the use of video cable extensions and/or video switch boxes.</li> <li>• Check that all plugs are firmly seated in their sockets.</li> </ul>
<b>Picture is not centered or sized properly (analog RGB signal only).</b>	<ul style="list-style-type: none"> <li>• Adjust the pitch and phase (page 14).</li> <li>• Adjust the picture position (page 14). Note that some video modes do not fill the screen to the edges.</li> </ul>
<b>Picture is too small.</b>	<ul style="list-style-type: none"> <li>• Set the zoom setting to "FULL2" (page 16).</li> </ul> <p>■ <b>Problem caused by a connected computer or other equipment, and not caused by the monitor</b></p> <ul style="list-style-type: none"> <li>• Set the resolution to 1920 × 1200 on your computer.</li> </ul>
<b>Picture is dark.</b>	<ul style="list-style-type: none"> <li>• Adjust the brightness (page 13).</li> <li>• Adjust the backlight (page 13).</li> <li>• It takes a few minutes for the display to become bright after turning on the monitor.</li> <li>• Adjust the gamma on the GAMMA menu (page 16).</li> <li>• The screen might turn darker, depends on ECO mode you selected.</li> </ul>
<b>Wavy or elliptical pattern (moire) is visible.</b>	<ul style="list-style-type: none"> <li>• Adjust the pitch and phase (analog RGB signal only) (page 14).</li> </ul>
<b>Color is not uniform.</b>	<ul style="list-style-type: none"> <li>• Adjust the pitch and phase (analog RGB signal only) (page 14).</li> </ul>
<b>White does not look white.</b>	<ul style="list-style-type: none"> <li>• Adjust the color temperature (page 15).</li> </ul>
<b>Touch sensor keys do not work (the menu screen is not displayed).</b>	<ul style="list-style-type: none"> <li>• Touch the touch sensor key again. Touch sensor keys do not work when they are not lit. Touch an area of the touch sensor keys so they light up, then operate the display using the touch sensor keys.</li> </ul>
<b>Touch sensor keys do not work properly.</b>	<ul style="list-style-type: none"> <li>• Turn off the MAIN POWER switch located on the upper side of the monitor once and turn on again after 30 seconds, when static electricity might have caused the problem.</li> </ul>
<b>Touch sensor keys do not operate (O<sub>TM</sub> appears on the screen).</b>	<ul style="list-style-type: none"> <li>• If "MENU LOCK" is set to "ON," set it to "OFF" (page 18).</li> </ul>
<b>Resolution displayed on the menu screen is incorrect.</b>	<ul style="list-style-type: none"> <li>• Depending on the graphics board setting, the resolution displayed on the menu screen may not coincide with the one set on the computer.</li> </ul>
<b>After turning off the main power, ⏻ (power) stays bright for a while.</b>	<ul style="list-style-type: none"> <li>• When ⏻ (power) is lit in red, or when the monitor is in the power saving mode, if you turn the MAIN POWER switch off, ⏻ (power) may not turn off right away. This is not a malfunction.</li> </ul>

## Displaying this monitor's information

While the monitor is receiving a video signal, touch and hold MENU for more than 5 seconds until the information box appears.

Touch MENU again to make the box disappear.

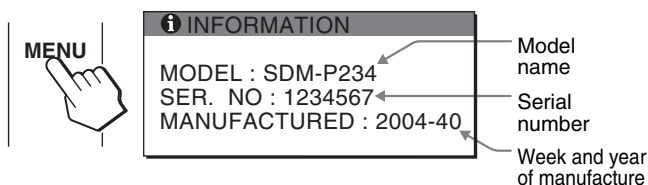

### Example



If any problem persists, call your authorized Sony dealer and give the following information:



- Model name: SDM-P234
- Serial number
- Detailed description of the problem
- Date of purchase
- Name and specifications of your computer and graphics board
- Type of input signals (analog RGB/digital RGB)

## Self-diagnosis function

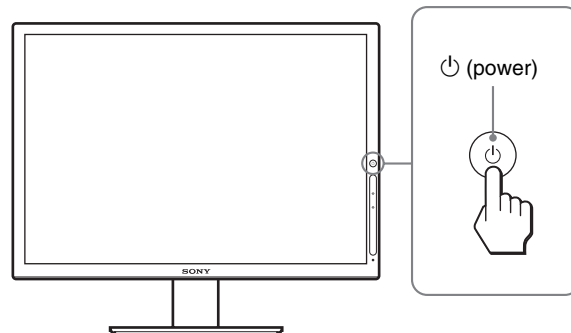
This monitor is equipped with a self-diagnosis function. If there is a problem with your monitor or computer(s), the screen will go blank and  (power) will light up in green. If  (power) is lit in orange, the computer is in power saving mode. Try pressing any key on the keyboard or moving the mouse.



### If the picture disappears from the screen and (power) is green

- 1 Turn the monitor off by touching  (power) and disconnect the video signal cables from the monitor.
- 2 Turn the monitor on by touching  (power).

If all four color bars appear (white, red, green, blue), the monitor is working properly. Reconnect the video signal cables and check the condition of your computer(s).

If the color bars do not appear, there is a potential monitor failure. Inform your authorized Sony dealer of the monitor's condition. Be sure to note the model name and serial number of your monitor. Also note the model name and specifications of your computer and graphics board.



# Specifications

## LCD panel

Panel type: a-Si TFT Active Matrix  
Picture size: 23 inch (58.4 cm)

## Input signal format

RGB operating frequency\*  
Horizontal: 28–92 kHz (analog RGB)  
28–75 kHz (digital RGB)  
Vertical: 48–85 Hz (analog RGB)  
60 Hz (digital RGB)

## Resolution

Horizontal: Max. 1920 dots (Only when the vertical frequency is set to 60 Hz, the horizontal resolution is 1600 dots or more.)  
Vertical: Max. 1200 lines (Only when the vertical frequency is set to 60 Hz, the vertical resolution is fixed to 1200 lines.)

## Input signal levels

Analog RGB video signal:  
0.7 V<sub>p-p</sub>, 75 Ω, positive  
SYNC signal:  
TTL level, 2.2 kΩ, positive or negative (Separate horizontal and vertical, or composite sync)  
0.3 V<sub>p-p</sub>, 75 Ω, negative (Sync on green)  
Digital RGB (DVI) signal: TMDS (Single link)

## Audio input

Stereo minijack, 0.5 V<sub>rms</sub>

## Audio output

Stereo minijack

## Power requirements

100–240 V, 50–60 Hz, Max. 1.0 A

## Power consumption

Max. 80 W

## Operating temperature

5–35 °C

## Dimensions (width/height/depth)

Display (upright):  
Approx. 534 × 429 × 250 mm (with stand)  
(21 1/8 × 17 × 9 7/8 inches)  
Approx. 534 × 352 × 110.5 mm (without stand)  
(21 1/8 × 13 7/8 × 4 inches)

## Mass

Approx. 9.7 kg (21 lb 6 oz) (with stand)  
Approx. 7.5 kg (16 lb 9 oz) (without stand)

## Plug & Play

DDC2B

## Accessories

See page 7.

## \* Recommended horizontal and vertical timing condition

- Horizontal sync width duty should be more than 4.8% of total horizontal time or 0.8 μs, whichever is larger.
- Horizontal blanking width should be more than 2.5 μsec.
- Vertical blanking width should be more than 450 μsec.

Design and specifications are subject to change without notice.

## TCO'99 Eco-document

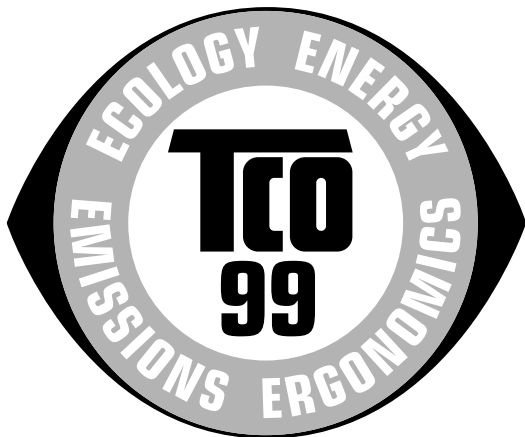

### ■ Congratulations!

You have just purchased a TCO'99 approved and labelled product! Your choice has provided you with a product developed for professional use. Your purchase has also contributed to reducing the burden on the environment and also to the further development of environmentally adapted electronics products.

### ■ Why do we have environmentally labelled computers?

In many countries, environmental labelling has become an established method for encouraging the adaptation of goods and services to the environment. The main problem, as far as computers and other electronics equipment are concerned, is that environmentally harmful substances are used both in the products and during their manufacture. Since it is not so far possible to satisfactorily recycle the majority of electronics equipment, most of these potentially damaging substances sooner or later enter nature.

There are also other characteristics of a computer, such as energy consumption levels, that are important from the viewpoints of both the work (internal) and natural (external) environments. Since all methods of electricity generation have a negative effect on the environment (e.g. acidic and climate-influencing emissions, radioactive waste), it is vital to save energy. Electronics equipment in offices is often left running continuously and thereby consumes a lot of energy.

### ■ What does labelling involve?

This product meets the requirements for the TCO'99 scheme which provides for international and environmental labelling of personal computers. The labelling scheme was developed as a joint effort by the TCO (The Swedish Confederation of Professional Employees), Svenska Naturskyddsforeningen (The Swedish Society for Nature Conservation) and Statens Energimyndighet (The Swedish National Energy Administration).

Approval requirements cover a wide range of issues: environment, ergonomics, usability, emission of electric and magnetic fields, energy consumption and electrical and fire safety.

The environmental demands impose restrictions on the presence and use of heavy metals, brominated and chlorinated flame retardants, CFCs (freons) and chlorinated solvents, among other things. The product must be prepared for recycling and the manufacturer is obliged to have an environmental policy which must be adhered to in each country where the company implements its operational policy.

The energy requirements include a demand that the computer and/or display, after a certain period of inactivity, shall reduce its power consumption to a lower level in one or more stages. The length of time to reactivate the computer shall be reasonable for the user.

Labelled products must meet strict environmental demands, for example, in respect of the reduction of electric and magnetic fields, physical and visual ergonomics and good usability.

Below you will find a brief summary of the environmental requirements met by this product. The complete environmental criteria document may be ordered from:

#### TCO Development

SE-114 94 Stockholm, Sweden

Fax: +46 8 782 92 07

Email (Internet): development@tco.se

Current information regarding TCO'99 approved and labelled products may also be obtained via the Internet, using the address: <http://www.tco-info.com/>

## ■ Environmental requirements

### Flame retardants

Flame retardants are present in printed circuit boards, cables, wires, casings and housings. Their purpose is to prevent, or at least to delay the spread of fire. Up to 30% of the plastic in a computer casing can consist of flame retardant substances. Most flame retardants contain bromine or chloride, and those flame retardants are chemically related to another group of environmental toxins, PCBs. Both the flame retardants containing bromine or chloride and the PCBs are suspected of giving rise to severe health effects, including reproductive damage in fish-eating birds and mammals, due to the bio-accumulative\* processes. Flame retardants have been found in human blood and researchers fear that disturbances in foetus development may occur.

The relevant TCO'99 demand requires that plastic components weighing more than 25 grams must not contain flame retardants with organically bound bromine or chlorine. Flame retardants are allowed in the printed circuit boards since no substitutes are available.

### Cadmium\*\*

Cadmium is present in rechargeable batteries and in the colour-generating layers of certain computer displays. Cadmium damages the nervous system and is toxic in high doses. The relevant TCO'99 requirement states that batteries, the colour-generating layers of display screens and the electrical or electronics components must not contain any cadmium.

### Mercury\*\*

Mercury is sometimes found in batteries, relays and switches. It damages the nervous system and is toxic in high doses. The relevant TCO'99 requirement states that batteries may not contain any mercury. It also demands that mercury is not present in any of the electrical or electronics components associated with the labelled unit.

### CFCs (freons)

The relevant TCO'99 requirement states that neither CFCs nor HCFCs may be used during the manufacture and assembly of the product. CFCs (freons) are sometimes used for washing printed circuit boards. CFCs break down ozone and thereby damage the ozone layer in the stratosphere, causing increased reception on earth of ultraviolet light with e.g. increased risks of skin cancer (malignant melanoma) as a consequence.

### Lead\*\*

Lead can be found in picture tubes, display screens, solders and capacitors. Lead damages the nervous system and in higher doses, causes lead poisoning. The relevant TCO'99 requirement permits the inclusion of lead since no replacement has yet been developed.

\* Bio-accumulative is defined as substances which accumulate within living organisms.

\*\* Lead, Cadmium and Mercury are heavy metals which are Bio-accumulative.